

Sharp 100th Anniversary

A Century of Sincerity and Creativity



Business Creed

Sharp Corporation is dedicated to two principal ideals:

“Sincerity and Creativity”

By committing ourselves to these ideals, we can derive genuine satisfaction from our work, while making a meaningful contribution to society.

Sincerity is a virtue fundamental to humanity ... always be sincere.

Harmony brings strength ... trust each other and work together.

Politeness is a merit ... always be courteous and respectful.

Creativity promotes progress ... remain constantly aware of the need to innovate and improve.

Courage is the basis of a rewarding life ... accept every challenge with a positive attitude.

Business Philosophy

We do not seek merely to expand our business volume. Rather, we are dedicated to the use of our unique, innovative technology to contribute to the culture, benefits and welfare of people throughout the world.

It is the intention of our corporation to grow hand-in-hand with our employees, encouraging and aiding them to reach their full potential and improve their standard of living.

Our future prosperity is directly linked to the prosperity of our customers, dealers and shareholders ...indeed, the entire Sharp family.

SHARP CORPORATION

Through sincerity and creativity,
Sharp is contributing to
the world by creating products
that instill passion in
people everywhere.



Sharp has a history of creating market demand by coming out with original, innovative products that make people's lives richer and their work more efficient. It is the patronage and support of these people that have brought Sharp to 2012, the company's 100th anniversary.

From its humble beginnings in Japan, Sharp has expanded its business across the globe, in the process amazing and capturing the hearts of people with products created through the company creed of 'Sincerity and Creativity'.

As the sun rises on Sharp's second century, the company will continue doing what is both its mission and its joy: provide products and technologies that help make society a better place. Join us as we take Sharp to even more people and places.

Business Philosophy and Business Creed

**Through sincerity and creativity,
Sharp is contributing to the world
by creating products that instill passion
in people everywhere.**

Sharp through the Years

Chapter 1 1912–1923

The Creativity to Found a Company Growing a Business with the Sharp Pencil

- 1 Tokuji Hayakawa Finds a Company in Honjo, Tokyo 1-01
- 2 The Birth of the Sharp Pencil 1-03
- 3 A Thriving Business Meets Great Misfortune 1-05

Chapter 2 1924–1949

Making a Fresh Start in Osaka Leading the Age of Radio in Japan

- 1 Recovering from the Great Kanto Earthquake and Rebuilding His Life 2-01
- 2 Growth as a Radio Manufacturer 2-03
- 3 Expanding Sales by Focusing on Business Partners 2-05
- 4 Incorporation and Wartime Operations 2-07
- 5 A Post-War Rebirth Based on Radios 2-09

In Pictures
Sharp Radios over the Years G1-01

Chapter 3 1950–1958

Overcoming a Financial Crisis Japan’s First Commercially Produced TV

- 1 From a Crisis of Survival to a Financial Turnaround 3-01
- 2 The Dawn of the Television Era 3-03
- 3 Mass Production of TVs Begins 3-05
- 4 Aiming to Become a Comprehensive Consumer Electronics Manufacturer 3-07
- 5 Strengthening Cooperation with Business Partners and Establishing Sales Subsidiaries 3-09
- 6 Establishing a Special Metalworking Plant 3-11

In Pictures
History of Television Development at Sharp G2-01

Chapter 4 1959–1969

Becoming a Comprehensive Home Appliance Manufacturer Creating New Demand through Products

- 1 New Company-Wide Business Division System, Factory Expansion 4-01
- 2 Development of the Calculator 4-03
- 3 Seeds of the Semiconductor Technology 4-05
- 4 Supporting the Home Appliance Boom 4-07
- 5 Towards an Invigorating, Fulfilling Corporation 4-09
- 6 Leveraging the Domestic Appliance Marketing Network 4-11
- 7 Sales Company Established in the US 4-13

Chapter 5 1970–1974

Toward a Comprehensive Electronics Company Advanced Development and Planning Center Built in Tenri

- 1 Company Name Change and Adopting a New Corporate Structure 5-01
- 2 Aiming to Be a Comprehensive Electronics Manufacturer 5-03
- 3 Development of Liquid Crystals and Growth in Office Products 5-05
- 4 Development and Commercialization of Copiers 5-07
- 5 Expansion of the Domestic Marketing and Service Organization 5-09
- 6 Trade Friction and Expansion of Overseas Operations 5-11

In Pictures
Device Industry and Information Communications Products That Originated in Calculators G3-01

Chapter 6 1975–1985

Development of the “New Life” Product Strategy Building a Strong Financial Structure

- 1 Setting in Motion a New Strategy to Ride Out an Economic Downturn 6-01
- 2 Breaking Through to Be a Trillion-Yen Company 6-03
- 3 Growth of the Device Business Built around Technology 6-05
- 4 Establishing a Foothold as an Electronic Office Equipment Manufacturer 6-07
- 5 Expanding and Upgrading Production Facilities 6-09
- 6 Establishing Sales Subsidiaries on a Nationwide Scale 6-11
- 7 Establishing the Company’s First Production Base in a Developed Country 6-13

Chapter 7 1986–1991

Three Challenges in Renovating the Business Structure Creating New Demand by Strengthening Product Appeal

- 1 Chance Is Found in Changes 7-01
- 2 Aiming to Strengthen Corporate Culture 7-03
- 3 Promoting Multimedia for Personal Use 7-05
- 4 Positioning LCDs as the Core Business 7-07
- 5 Confidence in Optoelectronics 7-09
- 6 Seeking the Best Locations for Production and Sales 7-11

In Pictures
Developing along with Application Products:
Optoelectronic Devices G4-01

Chapter 8 1992–1997

Enhancing Key Devices Such as LCDs Using the Spiral Strategy to Build a New Sharp

- 1 The 80th Anniversary of Sharp’s Founding 8-01
- 2 Putting Innovation into Action by Appreciating Customers’ Point of View and through Creative Synergy 8-03
- 3 Development and Production of LCDs and Solar Cells 8-05
- 4 A Blossoming Spiral Strategy 8-07
- 5 The Sharp Brand Spreads around the World 8-09

Chapter 9 1998–2003

Aiming to Be a One-of-a-Kind Company Issuing the LCD TV Declaration

- 1 Aiming to Be One-of-a-Kind, Rather Than Number One 9-01
- 2 Brand Strategy in Full Force 9-03
- 3 Human Resource Development Utilizing Diversity and Self-Motivation 9-05
- 4 Becoming an Environmentally Advanced Company 9-07
- 5 Growth in the Device Business through Selection and Consolidation 9-09
- 6 Debut of AQUOS LCD TVs 9-11
- 7 Plasmacluster Devices and Other Products with Distinctive Features 9-13
- 8 Revamping Overseas Marketing Strategy and Japanese Operations 9-15

Chapter 10 2004–2006

Birth of the “Kameyama Model” Large-Screen AQUOS

- 1 Construction of the Kameyama Plant 10-01
- 2 AQUOS for the World 10-03
- 3 Continuing Efforts to Protect the Environment 10-05
- 4 Focus on Health and Environment Products 10-07
- 5 Expanding Information and Communications Business 10-09
- 6 Boosting Corporate Value and Stressing Social Responsibility 10-11
- 7 Growth of the Chinese Market and International Business Measures 10-13

In Pictures
Evolution of LCD Technology and Application Products G5-01

Chapter 11 2007–2011

Promoting Efforts to Make Sharp an Environmentally Advanced Company Restructuring Business by Shifting to Areas Where Sharp Excels

- 1 Strong Financial Results and Radical Changes in the Business Environment 11-01
- 2 Developing the LCD TV and Large-Size LCD Business 11-03
- 3 Developing the Solar Cell Business Encompassing the Entire Value Chain 11-05
- 4 Consistent Efforts Focused on the Environment and Solutions 11-07
- 5 Focusing on Asia and Emerging Markets 11-09

Chapter 12 2012–

Striving to Rebuild Financial Results and Confidence Looking Ahead to the Next 100 Years, Embarking on New Growth

- 1 Aiming to Become a Global Company That Can Compete on the World Stage 12-01
- 2 Swiftly Pursuing Business Restructuring 12-03

Company Information

Corporate Profile /
Major Bases in Japan and Abroad Company Information-01
Changes in Capital, Business Performance,
and Number of Employees Company Information-07

Historical Overview

A History of Innovation,
Born from Sincerity and Creativity Chronology-01
Chronology (Developments at Sharp) Chronology-03

Notes

1. As a rule, the content in this publication is current as of the end of May 2012. (Some content may be more recent or prospective.)
2. As is the practice in historic depictions, this publication does not use honorific titles such as “Mr.” or “Mrs.” People’s job titles are those held during the period being referred to.
3. Proper names such as place names and company names are those that were used during the period being referred to. Out of necessity, current names or later names may also have been inserted.
4. Words such as “Co., Ltd.” denoting corporate status have not been used except in cases where such words are necessary to clarify corporate status; for example, for the establishment of new companies or company name changes. For Sharp-related companies, either the full company name or the shortened name, whichever is appropriate, has been used.
5. Names such as those of companies or products may be trademarks or registered trademarks of Sharp or other companies in Japan or other countries.

Chapter 1 | 1912 - 1923

March 30, 1926.

T. HAYAKAWA
PROPELLING PENCIL
Filed July 11, 1923

1,578,515

The Creativity to Found a Company
Growing a Business with the Sharp Pencil

In 1915, Sharp founder Tokuji Hayakawa invented the innovative twist-type Hayakawa Mechanical Pencil—later dubbed the Sharp Pencil. This pencil represented the culmination of painstaking efforts by Tokuji after he had completed an apprenticeship in metalworking and had launched a business in 1912 in a crowded neighborhood of old Tokyo. The Sharp Pencil served as the origin of our corporate name. With beauty and functionality in tune with the Taisho*1 Modern ethos of that period, the pencil was a hit product that led to a flourishing business. Since that time, an attitude of giving sincere thought to the people who use a product—and of harnessing originality and creativity in the pursuit of convenience and quality—has been the foundation of Sharp.

US patent drawings for the Sharp pencil

1 Tokuji Hayakawa Finds a Company in Honjo, Tokyo**The Founder's Childhood and His Apprenticeship at a Decorative Ornament Metalworking Shop**

Sharp Corporation came into being on September 15, 1912, when founder Tokuji Hayakawa opened a metalworking business. Let us now retrace the founder's footsteps leading up to this momentous milestone.

Tokuji Hayakawa was born on November 3, 1893, at 42 Hisamatsu-cho, Nihonbashi-ku, Tokyo City (now Chuo-ku, Tokyo). He was the youngest son of father Masakichi and mother Hanako.

Unfortunately, young Tokuji's mother was not only very busy with work; she was also in poor health. As a consequence, just 23 months after his birth, Tokuji was placed in the care of the Deno family, who ran a fertilizer business and who later formally adopted the boy. Tokuji endured a harsh childhood, being underfed and mistreated by his adoptive stepmother. He was forced to quit school shortly after entering second grade, and his life involved little more than pasting labels on matchboxes from morning until deep into the night.

Fortunately, help arrived in the form of Mrs. Inoue, an old, visually impaired woman from his neighborhood who understood the miseries of his foster home. She helped Tokuji to become an apprentice before the age of eight in a

metalworking business that made decorative metal ornaments. His intense gratitude for that act of kindness stayed with him forever and led to his later support for the visually impaired.

The long apprenticeship Tokuji served became an important opportunity for learning and marked the origin of his entrepreneurial spirit. His master, Yoshimatsu Sakata, had the stubborn but steady temperament of a seasoned artisan. Although strict when it came to work, he was a compassionate, warmhearted person. Tokuji not only learned the basics of metalworking techniques here; he also developed a sense of human kindness.



Sharp founder Tokuji Hayakawa (front row, far right) during his apprenticeship, with co-workers

Sakata started a new business manufacturing pencils. However, owing to the immaturity of the technology, the business failed and the majority of the pencils turned out to be rejects. While the other craftsmen in the workshop abandoned their master's venture, Tokuji took it upon himself to sell off all the rejected pencils at a stall in a night market. Harnessing his enthusiasm to sell goods in an appropriate setting, Tokuji honed his skills as a salesman. This experience would prove extremely useful in his later life as a businessperson.

Inventing the Tokubijo Snap Buckle

By April 1909, Tokuji had served the full term of his training apprenticeship of seven years and seven months. He then completed a year of unpaid service to fulfill his apprenticeship and become a fully fledged decorative metal craftsman.

Upon becoming a qualified craftsman, Tokuji purchased two press machines—one regular sized and one small—for shaping and working metal that would be used in fabricating products of his own devising. He also took on the challenge of new jobs that his master had turned down, such as producing fittings for adjustable-flow faucets*2.

One day, as Tokuji was watching a movie at the cinema, he was struck by the looseness of the belts worn by the actors. This observation prompted him to devise a belt buckle that could be tightly fastened without requiring holes in the belt strap.

Incorporating the first character of his own name, he called his buckle the Tokubijo. This belt buckle was awarded Tokuji's first utility model design patent. Through an introduction by an acquaintance, he received an order for a large quantity of these buckles. Gradually, Tokuji began to think seriously about starting his own business.



The Tokubijo buckle, an innovative new design that tightly clasped the belt without the need for fastening holes

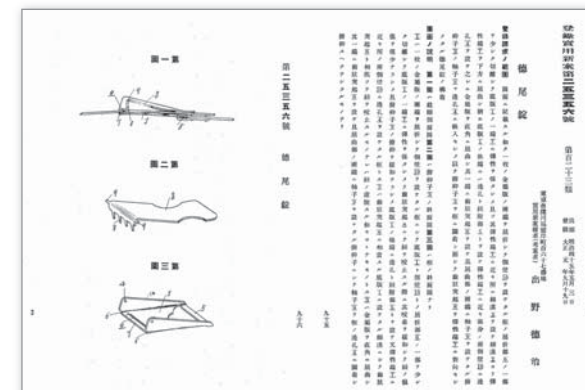

Utility Model Design Patent No. 25356 for the Tokubijo buckle (registered September 19, 1912)

Note: Tokuji returned to using the Hayakawa family name after legally separating himself from the Deno family in 1915. Also, the utility model registration uses an incorrect *kanji* character in transcribing his name, Tokuji.

Founded as a Metalworking Business

On September 15, 1912, before he was 19 years old, Tokuji finally won his long-sought independence. He rented a small house at 30 Matsui-cho 1-chome, Honjo-ku, Tokyo City (now Shin-ohashi, Koto-ku, Tokyo), and set up a metalworking business with two other men—a craftsman and an apprentice. His initial capital was 50 yen, and the workspace was small, covering an area a mere six *tatami* mats in size (11.85 m²). Nevertheless, he found ways to raise efficiency, such as by setting up tools and utensils more effectively.

At first, Tokuji focused on producing the Tokubijo buckle, but he also worked diligently on research into new products. One of them was the adjustable-flow faucet. He devised simplified mounting hardware that reduced the number of mounting components from nine to three. Instead of taking 30 minutes to install, as standard faucets did at the time, the new model took just one minute. The faucet earned Tokuji his second utility model design patent, following the one for the Tokubijo buckle.



The company was founded in a dense urban neighborhood of old Tokyo, Matsui-cho, Honjo-ku (now Shin-ohashi, Koto-ku, Tokyo)

Tokuji was not satisfied with one success; his originality and creativity led him to create a series of new products. In 1914, the same year he was married, he moved to a combined house and workplace at 35 Hayashi-cho 2-chome in Honjo-ku (now Tachikawa, Sumida-ku). With seven employees now working for him, he made a daring investment of 200 yen—a large sum in those days—to buy and install a one-horsepower motor*3.

Driven by the motto "Take the initiative and you will win," Tokuji was among the first in his industry to streamline production with machinery. In an era when his rivals were still manufacturing by hand, he developed a reputation as an unabashed enthusiast for machines.

*1 The Taisho era is a period in the history of Japan from 1912 to 1926.

*2 This faucet featured an attachment on the end that allowed it to be turned in any direction.

*3 In his autobiography, Tokuji noted that ordinary craftsmen in 1910 earned about 12 yen per month—less than one fifteenth of the price of the motor.

2 The Birth of the Sharp Pencil

Perfecting the Hayakawa Mechanical Pencil

■ Durable and Easy to Use— the Birth of a Beautiful Writing Instrument

In 1915, a major writing instrument manufacturer placed an order with Tokuji for a large quantity of metal fittings for use in a mechanical pencil—a product that came to be considered the predecessor of the Sharp Pencil. Despite featuring a thick, ungainly celluloid casing, it was fragile—little more than an expensive toy. Although he had been contracted only to fabricate its internal metal fittings, Tokuji believed he could improve the pencil's rudimentary design. He felt if it could be made into a practical product, like a fountain pen, it held promise as a viable business.

Leaving routine jobs to his employees and neglecting to eat and sleep, Tokuji immersed himself in the work of improving the mechanical pencil. Eventually he succeeded in reconfiguring the internal design, using a single piece of brass in place of a combination of many parts. The result was a tough and durable single component. Next, he shaped this brass part into a thin tube that tapered at the tip. By cutting a fine slot on the inside for the pencil lead to pass through, Tokuji perfected a design that employed a spindle to push the pencil lead out smoothly. He also devised a mechanism whereby lead could be reloaded into the pencil with a reverse turn of the barrel. Having fine-tuned the internal parts, Tokuji made the outer shell not from celluloid, but from a beautiful nickel-plated metal.

Not only was the new design durable and easy to use, it was also aesthetically pleasing. Thus was born the

Hayakawa Mechanical Pencil (*Hayakawa-shiki Kuridashi Enpitsu*).

Around this time, Tokuji was reunited with his older brother, Masaharu, whom he had not seen since childhood. Masaharu had a talent for business and accounting and was then running a general store. When Tokuji showed his brother the metal mechanical pencil, he agreed that it held ample promise as a new business. The two men established Hayakawa Brothers Company (*Hayakawa Keitei Shokai*) and worked together to sell the metal mechanical pencils. While continuing to work on other metalworking jobs, they began producing ten gross (approximately 1,440) units a month.

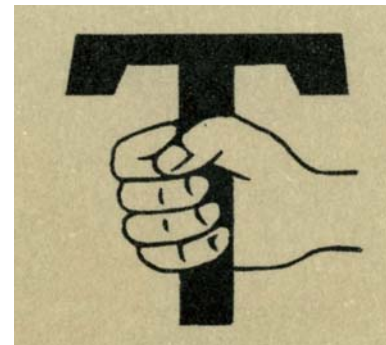

Tokuji trademarked a logo that symbolized "supporting one's own work on one's own resources," depicted using a right hand to grip the letter 'T', the first letter of his name

■ Struggle for Recognition

The two brothers took turns in visiting stationery and office supply wholesalers. Initially, the shops were critical and showed no interest. The new pencil wasn't considered a suitable match for traditional Japanese clothing, and the metal barrel felt cold in winter. Despite many such comments and rejections, the brothers did not give up.

The Hayakawas remained confident in their product and sought to have it carried by Ito-ya in Ginza, considered Japan's leading stationery store at the time. The high-class store was a severe judge of new products and made repeated requests for improvements to the pencil's design. The brothers were to make a total of 36 different samples before finally securing an order from Ito-ya's owner. By willingly accepting their customer's advice and creating a large number of samples, the brothers were able to greatly improve subsequent versions of their mechanical pencils.

Around three months after the Hayakawa brothers first began selling their mechanical pencils, they received some auspicious news. An inquiry arrived from a trading house* in Yokohama to whom they had sent a sample of the mechanical pencil. The impact of World War I, which had broken out in 1914, had made it difficult to obtain the German-made mechanical pencils that were popular at the



The company produced a wide variety of Sharp Pencils, including models with a calendar, scissors, and a compass

time in many parts of Europe and the United States. The Hayakawa Mechanical Pencil had apparently been singled out as being of a comparable standard to the German models. The Hayakawas immediately devoted their entire factory to producing pencils. Even while temporarily setting aside other jobs and working late into the night, they could hardly keep up with demand.

With exports of Hayakawa Mechanical Pencils to the US and Europe taking off, word of their excellent reputation abroad filtered back to Japan. Orders began to flood in from department stores and office supply stores such as Ito-ya.

Product Improvements and Expansion of Sales Channels

Even as the Hayakawa Mechanical Pencil gained overwhelming popularity, Tokuji was not satisfied with the status quo and took up the challenge of developing more sophisticated products. In 1916, using a US-made drill, he succeeded in making an extremely small hole in a metal tube, enabling the use of super-fine pencil lead. By devising a new metal barrel with added length and thickness, Tokuji perfected a new mechanical pencil.

When it came to sales, the Hayakawas adopted a dealer system. They signed contracts for consignment sales with Ando Gyokkado of Nagoya for the Chubu region of central Japan, and with the Tokyo office of Nihon Bungu Seizo for the Kanto region around Tokyo.

The brothers considered naming the new product the Sharp Pencil, but instead named it the Ever-Ready Sharp Pencil on the advice of Shotaro Fukui of Fukui Shoten (now Lion Office Products Corporation), their general agent in the Kansai area. For native Japanese speakers, the English words "ready" and "lady" sound the same; since these pencils were popular with western women, Mr. Fukui felt this name would boost the product's image in Japan. His idea was accepted, and the name was registered as a trademark. It later became common to call it the Sharp Pencil—the Hayakawas' original idea—with this name

eventually evolving into a generic term for mechanical pencils in Japan.

After the birth of the Ever-Ready Sharp Pencil, Tokuji devised a series of design improvements and also introduced a variety of popular new products, including affordably priced low-end models, luxury products made of gold and silver, and models incorporating a watch or a lighter.

In 1921, to celebrate the European visit of Japan's Crown Prince (later, the Emperor Showa), the Hayakawas gifted a 14-carat gold Sharp Pencil to the Imperial family. In addition, the original Sharp Pencil was exhibited at the Peace Commemoration Tokyo Exposition held in Ueno Park in 1922, where it received a gold medal to further enhance its reputation for quality and aesthetics.



The Sharp Pencil was awarded a gold medal at the Peace Commemoration Tokyo Exposition



The highly sophisticated design was well received, and acquired 48 new design patents in Japan and abroad

* A foreign trading house was an import/export business office staffed by resident foreign traders. Representatives and commission agents were stationed in these offices.

3 A Thriving Business Meets Great Misfortune

Ramping Up Output with a Streamlined Production System

■ Aggressively Introducing High-Performance Machinery

To boost production of Sharp Pencils, Hayakawa Brothers Company developed an assembly-line production system that could consistently and efficiently make high-quality products without the need for skilled craftsmen.

In 1919, the brothers purchased land near their factory in Hayashi-cho and built a new 400 m² factory and an 80 m² office. As an avid proponent of machines, Tokuji introduced high-performance machinery and invested most of the company's accumulated profits in equipment for the new factory. When necessary, he would buy imported machinery from Switzerland or the UK through agents. An imported press machine, for example, enabled the connected internal parts of the Sharp Pencil to be formed into a sturdy, integrated single piece.

Tokuji also believed in taking responsibility for the reliability of products made by one's own company. In one case, he conducted an exhaustive series of experiments with different plating materials, finally creating a finished product that was durable enough for him to claim that the plating would never flake off. It even came with an industry-first 10-year warranty.

■ Building a New Plant Employing 200 People

The Hayakawas' business flourished under management practices that streamlined production of long-selling products and that nurtured relationships with suppliers and business partners. As a result, business grew dramatically. In

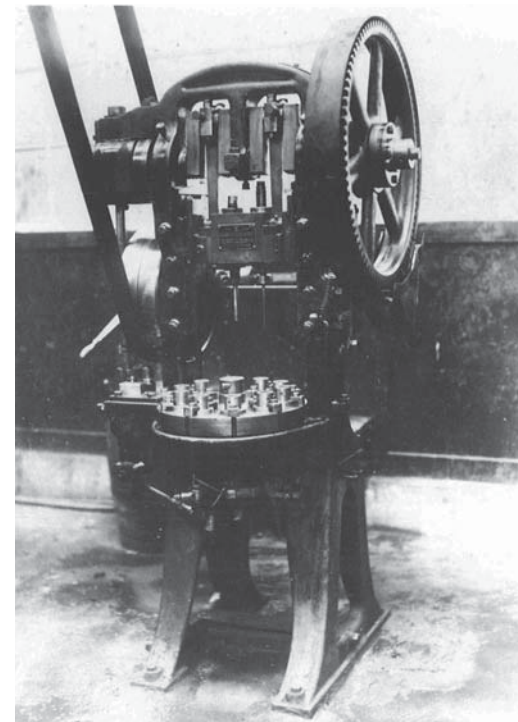

Imported press that helped make production more efficient and improved product quality

1920, the company established a branch factory in Oshiage (now Yahiro, Sumida-ku), and the following year it purchased 830 m² of land for the site of its third plant in Kameido (now Kameido, Koto-ku, Tokyo).

In 1923, the factory in Hayashi-cho was extended to 990 m². The plant employed 200 workers and achieved a strong financial performance, with sales of 50,000 yen per month.

The growth of the Sharp Pencil business could be attributed to the Hayakawas' inherent confidence in their products and their ability to persist with sales activities until customers understood the value of the products. They also made constant improvements in product quality and production methods and rolled out finished products that were superior in terms of both practicality and aesthetics.



The Sharp Pencil factory adopted efficient assembly-line operations

Earthquake Strikes Kanto Region—Family and Factory Are Lost

On September 1, 1923, at 11:58 in the morning, the Kanto region around Tokyo was struck by a magnitude 7.9 earthquake with its epicenter in Sagami Bay. Tokuji had been visiting a friend, but he hurried back to the factory to check on his employees and his family. At this point, fortunately, neither Tokuji's factory nor his home had sustained major damage. His family and employees were unharmed. Soon after, victims of the disaster began arriving one after another at the factory, and it soon became filled with people.

However, the fact that the earthquake struck just as households were preparing the midday meal would result in a catastrophe. Burning charcoal from overturned stoves ignited wooden houses, and flames began rising around town. The situation had suddenly grown alarming. Tokuji judged that the factory would be burned down in the spreading fire, so he distributed rice and money to his employees and sought safety elsewhere. He also passed out food to the victims who had gathered in the factory.

Being surrounded by extensive open gardens, the nearby Iwasaki Villa (now Kiyosumi Garden, Koto-ku) was considered safe. Tokuji therefore entrusted his wife and two children to an employee and sent them ahead, promising to follow them after he had finished cleaning up the factory. But Tokyo soon turned into a sea of fire. Tokuji rushed desperately through the streets—plunging into the river on several occasions—before finally making it to the Iwasaki Villa. In that place of refuge, he learned that his two children had perished in the fire and that his wife had sustained burns over her entire body. She later died. Tokuji had lost his family—his heart and soul, his source of support.

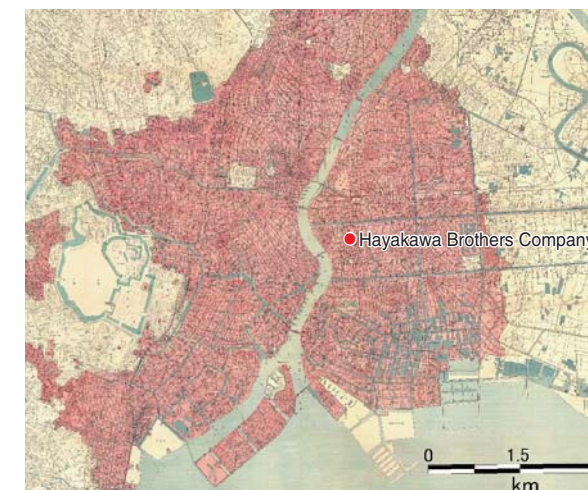

Red indicates the area destroyed by the fire that spread after the Great Kanto Earthquake (Tokyo City Fire Dynamics Map)

Having narrowly escaped death, Tokuji began, along with his employees, to live the life of a refugee. A few days after the earthquake, he moved into a tenement that he had earlier purchased in Kameido and that had survived the fire. The five apartments of this row house now housed about 70 employees from the devastated factory. It served as shelter to keep off the night dew.

When the situation had stabilized, Tokuji set to work protecting the equipment in the burnt-out factory in Hayashi-cho by oiling the machinery to prevent rust.



Aftershocks and fires caused chaos near Ishihara-cho, Honjo-ku, Tokyo (photo courtesy of Asahi Shimbun newspaper)

Scrambling to Respond after the Earthquake

Tokuji strove to rebuild his business, but prospects were bleak. As October began, Nihon Bungu Seizo, the company who had been selling Sharp Pencils on consignment in the Kanto area, demanded repayment of deposits made for open contracts and loans totaling 20,000 yen. It was a costly and urgent demand. After consulting with his brother, Tokuji concluded that, to deal with the debt and repay the loans, he would have to dissolve Hayakawa Brothers Company and transfer current business operations to Nihon Bungu Seizo.

In early November, he visited the Osaka headquarters of Nihon Bungu Seizo and met its president—along with Taichi Nakayama, president of parent company Nakayama Taiyodo—and negotiated an amicable settlement. The terms were that: 1) the machinery of Hayakawa Brothers Company would be transferred to Nihon Bungu Seizo, which would also have use of the patents on the Sharp Pencil at no charge; 2) Nihon Bungu Seizo would pay the accounts payable and hire the main technical personnel of Hayakawa Brothers Company to take over the Sharp Pencil business; and 3) Nihon Bungu Seizo would receive Tokuji's services as chief engineer for six months to provide technical guidance.

Tokuji, who had been fighting to get back on his feet after the blow of the earthquake, faced hardships and challenges one after another. Nevertheless, he never allowed himself to become discouraged.

Chapter 2 | 1924 - 1949

Making a Fresh Start in Osaka Leading the Age of Radio in Japan

Having lost everything in the Great Kanto Earthquake, Sharp's founder Tokuji Hayakawa relocated to Osaka and made a fresh start. Once there, he soon encountered an exciting new product—the radio.

Using his expertise in metal-processing technology, he produced Japan's first crystal radio receiver.

Next, he turned to the challenge of making vacuum-tube radios with high sensitivity. He created numerous models that could be enjoyed at the same time by the whole family, including models with built-in speakers.

Tokuji's spirit of originality and creativity was demonstrated not only in his products, but also in production methods and distribution.

His company would grow to be a major radio manufacturer with a trusted reputation.

Eventually, in 1935, he incorporated his company as a corporation.

Circuit diagram for the Type 35 radio

1 Recovering from the Great Kanto Earthquake and Rebuilding His Life

Establishing Hayakawa Metal Laboratories

Amid the heartbreak and hardship suffered as a victim of the Great Kanto Earthquake, Tokuji headed to Osaka in December 1923 to provide Nihon Bungu Seizo with manufacturing guidance for the Sharp Pencil. He vowed to himself that he would make a fresh start.

Making good on his commitment to Nihon Bungu Seizo, Tokuji worked together with 14 of his former employees to teach the skills needed to manufacture the Sharp Pencil. By August 1924, Tokuji had fulfilled his contract and left the company. He felt at home in Osaka, sharing with the locals a love of business and an appreciation of inner character over superficial markers of social status. He therefore resolved to try building a business in the area.

The area surrounding the city of Osaka then was tranquil rural countryside, which Tokuji found very much to his liking. A plot of land at 25 Saruyama, Tanabe-cho, Higashinari-gun, Osaka Prefecture—today, Nagaike-cho, Abeno-ku, Osaka—became the location for Sharp's current head office. Tokuji hoped to develop the land by building a large factory. He envisioned the lively, cheerful children from the neighborhood growing up and working there.

On September 1, 1924, just one year after the earthquake, Tokuji established Hayakawa Metal

Laboratories (*Hayakawa Kinzoku Kougyo Kenkyusho*), marking a major milestone on the road to recovery. Initially, he employed a staff of eight, including five new workers. Later, all of his former employees who had worked for Nihon Bungu Seizo would return and work together with the others.



Hayakawa Metal Laboratories and employees (1925)

Launching Research on Radio

The business began steadily, with manufacturing and sales of metal writing instruments and parts, but Tokuji was looking for a new business area. At a time when radio was already in use overseas, an announcement appeared in the newspapers that radio stations would be set up for broadcasting in Japan, starting in 1925. Tokuji had long believed that business success required constant pioneering of new fields ahead of one's rivals. On top of that, he had a keen interest in radio.

One day, he visited Ishihara Tokei-ten (now Ishihara Co. Ltd.) in Shinsaibashi, the bustling retail and entertainment district in central Osaka. The shop, which was run by a distant relative, dealt not only in clocks, but also in imported goods. As it happened, two crystal radios had just arrived from the United States. Without hesitation, Tokuji bought one for 7.50 yen. This would prove to be a fateful encounter with radio.

Tokuji and his employees immediately disassembled the radio he had bought and began studying it. While they were thoroughly familiar with metal processing, they had no knowledge of the principles of radio or even electricity. It was the first time they had seen a radio's inner parts. Nevertheless, by examining their shape and composition—and by making effective use of the metal-processing techniques—they were soon able to make faithful reproductions.

When the parts were finished, they turned to the challenge of making a prototype of the receiver set. Since radio broadcasts had yet to begin in Japan, they set up an apparatus to generate radio signals inside the factory and experimented using a manual Morse key to send beeping test tones.



Tokuji Hayakawa (right) testing a crystal radio

The Birth of Japan's First Crystal Radio

In April 1925, Tokuji and his team finally succeeded in assembling a radio, marking the birth of the first crystal radio produced in Japan. Test radio signals began being broadcast from a station in Osaka in June of the same year. The employees who listened to the broadcasts on a radio of their own making jumped for joy at the clear sound.



Japan's first domestically produced crystal radio

So as not to miss the opportunity of the start of radio broadcasting, the company worked to produce crystal radio sets as fast as they could. The new radio sold for 3.50 yen, less than half the price of imported models. Introduced immediately after the start of broadcasting in Japan, the radios flew off the shelves. Each radio bore the Sharp brand name, which had its origins in the popular Sharp Pencil but which also symbolized the sensitivity of the radio. At the same time, Tokuji's company also made and marketed parts for radios.

Although sales were strong, Tokuji did not try to exploit the excessively high prices that were common elsewhere at that time. His company entered the market early, guaranteed its products, and maintained fair prices. In addition, they worked to accumulate capital without wasting profits. Through the development and sale of radios, the Sharp brand name gradually became known in Japan. It was the first step towards becoming an electronics manufacturer.

2 Growth as a Radio Manufacturer

Development of a Vacuum-Tube Radio

In July of 1925, the company set up a sales office in Osaka on Utsubo-naka-dori, Nishi-ku—now Utsubo-honmachi, Nishi-ku—and began wholesaling their own products, along with imported vacuum-tube radios and parts.

In Japan, crystal radios were the dominant type of radio, providing clear sound with little background static. However, these radios required the use of headphones, meaning that groups of people could not listen to them together. Furthermore, volume levels were low and reception was possible only in a limited geographical area.

By contrast, vacuum-tube radios could receive signals even in remote valleys and seaside villages, thereby making radio available to everyone. Tokuji made up his mind to popularize a vacuum-tube radio of his own devising that took its power supply from the electrical lines used for lighting. First, he produced a battery-powered vacuum-tube radio that he named the Sharp Dyne, in emulation of the imported Neutrodyne receiver. Then, in 1929, he finally introduced an AC-powered vacuum-tube radio. It performed as well as the imported models, but cost far less—about one-tenth as much.

A number of different AC-powered Sharp Dyne models were developed, featuring from three to eight vacuum tubes. Tokuji's company was able to supply radios with optimal combinations of vacuum tubes, ranging from triodes to pentodes.

Initially, the horn speaker was a separate unit. The company supplemented its line-up with a high-end Fuji Go model, which featured an image of majestic Mount Fuji on the cabinet, and an affordably priced model with a simple design.

In 1930, the company's technical team created a pioneering design featuring a box-type radio receiver with the speaker housed in the main unit case. Variations of this radio incorporating a clock/timer or phonograph were also developed.



Sharp Dyne with a horn speaker

As radio became rooted in people's lives, the Sharp Dyne rose in popularity and made Sharp a household name synonymous with radio.

The Popularity of Radio Broadcasts

In the early days of radio, listeners were treated to music, entertainment, plays, lectures, and news. Radio was embraced as a new cultural medium and spread rapidly. Live broadcasts of baseball and other sports were also popular. August 1927 saw the first broadcast of the annual national high-school baseball tournament held at Koshien Stadium in Hyogo Prefecture. And in January 1928, a sumo tournament was broadcast live for the first time. During these live sports broadcasts, people would pack the streets in front of radio retailers. 1928 also saw the start of Japan's daily radio calisthenics program, which continues to this day.

By 1932, the number of subscribers to radio broadcasting surpassed 1 million—that figure rising to 1.4 million the following year.



Radio calisthenics began as a way to promote fitness and health among Japanese citizens. People of all ages moved to the rhythmical piano accompaniment. (Photo courtesy of *Asahi Shimbun* newspaper)

Devising a New Conveyor for Mass Production

The company expanded its factory buildings nearly every year to cope with the increased production of radios. A new plant was established in Hirano, near the head office, with the first building completed in 1934. Cabinets and parts made in this factory were then sent to the head office plant to be assembled into finished radios.

Since its founding, the company had focused on efficient production through mechanization and assembly-line operations. At the end of 1936, a new intermittent belt conveyor system was introduced to the radio production line—an innovation based on Tokuji's own design.

In this conveyor system, a work platform mounted on a belt would move and then stop in front of workers for a fixed time interval. During that pause, the worker would perform a predetermined task, such as mounting or wiring parts. The stop times could be adjusted to suit the skill levels of employees, promoting improved work efficiency throughout the 23 equal steps of the assembly process. The system was said to enable production of uniform-quality radios at the rate of one per minute. With a view to optimizing overall production, Tokuji set up an engineering team to study production costs and issues such as process allocation.

In this way, radio production increased dramatically year after year, from 58,000 units in 1936, to 88,000 units in 1938, to 130,000 units in 1939.



Radio production line using the intermittent belt conveyor system (around 1936)

The Beginnings of Quality Assurance and a Service System

In the period shortly after radio broadcasting had begun, many domestic products lacked the sophistication and quality level of imported products, and listeners were plagued with sets that didn't work. To provide purchasers with peace of mind when using the product, the company began in 1930 to attach a repair warranty notice to the radios it sold. Retailers would repair simple failures at no charge to the customer, and by entering the details of the problem on the notice and sending it back to the company, they would receive a small reimbursement of 0.50 yen.

This system provided a way to quickly respond to problems and gave both the consumer and the retailer a sense of security, while also promoting the high quality of the company's products. In addition, it served as a valuable source of information for product improvement.

Product development was given a further boost in 1937, when the company mounted a traveling caravan—a fleet of cars that toured the country, holding trade fairs, offering repair services, and doing market research wherever they went.

Tokuji also felt it was important that everyone connected

to the radio industry—from wholesalers and retailers to parts makers and competitors—should develop and expand together, so that prosperity could be shared by all. In November 1932, the company held a forum to promote measures for industry-wide prosperity. Tokuji placed particular stress on the importance of wholesalers, noting, "They are the primary sales contact for manufacturers. And from the standpoint of retailers, they are a significant presence and play the role of warehouse and financial institution." To encourage growth in the industry, Tokuji also held a debriefing session for the industry each time he returned from an overseas study tour, and consistently called for an expansion of exports.

Block diagram showing the working principle of the intermittent belt conveyor system (side view)

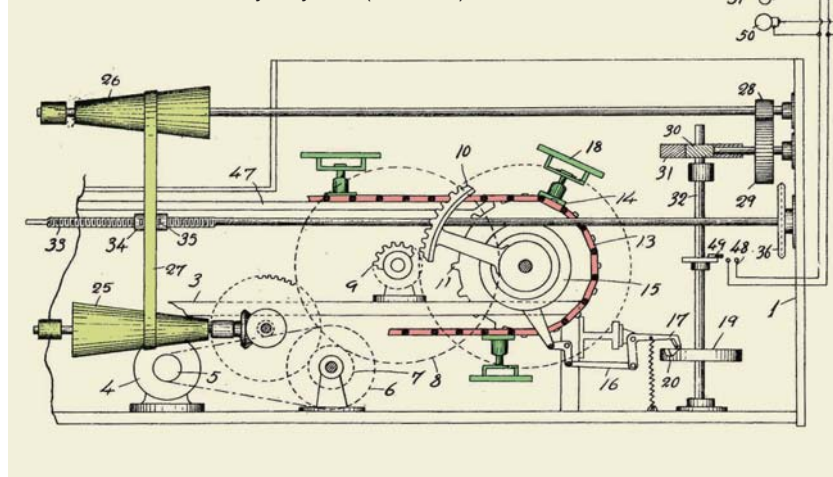

No. 18 is the work platform that alternately starts and stops with the movement of the conveyor belt. The action of pulleys 25 and 26 is a mechanism that enables the pause duration to be adjusted.

3 Expanding Sales by Focusing on Business Partners



Interior of the Utsubo sales office, where shelves were packed with products and parts

Expanding Sales Outlets

Opening Sales Offices and Branch Offices across the Country

Mindful of the importance of radio broadcasting, the government consolidated stations in Tokyo, Osaka, and Nagoya in August 1926 to form the Japan Broadcasting Corporation (NHK). Under the banner of this corporation, new stations began broadcasting in Kyushu, Hiroshima, Sendai, and Sapporo. Within two years, the whole country was linked in a radio program network. Seizing the opportunity presented by the launch of these broadcast stations, Tokuji's company established sales offices and branch offices throughout the country with the aim of expanding sales of receivers and parts.

Thriving in its advantageous location, the sales office in Utsubo, Osaka, was regarded as the home base. As sales increased, the number of employees grew, and the company upgraded and expanded its product line.

The company opened a Tokyo branch office in 1926, and then—to coincide with the launch of the Kyushu broadcast station in March 1927—one in Fukuoka. A trade fair targeting Kyushu wholesalers was held to generate publicity, raise capital, and celebrate the start of broadcasting. Among those invited to exhibit their products and share the cost of staging the event were Osaka- and Kobe-based manufacturers, wholesalers, and importers of parts such as vacuum tubes and batteries. A dozen shops accepted the invitation, and the fair was a great success. The Fukuoka branch office opened without any complications.



Trade fair held at a restaurant in Hakata to celebrate the launch of the Kyushu radio broadcasting station

The company subsequently established branch offices in Kokura in 1932 and in Nagoya in 1935. By the end of 1937, the company had further broadened its sales network by opening branch offices in Shizuoka, Sendai, Kanazawa, Hiroshima, Okayama, Kochi, Kumamoto, and Kagoshima.

Strengthening the Relationship with Business Partners

At the beginning of the 1930s, the company set up Sharp Kotokukai, an association of Sharp radio dealers that would hold meetings to introduce new products and discuss current market conditions. The organization also afforded the opportunity for members to deepen their relationships through informal social activities, such as attending plays, thereby promoting even greater sales growth.

The company also devoted energy to supporting struggling retailers. In 1936, the company introduced a bonus coupon system that paid retailers a monetary incentive directly based on sales. When making a sale, retailers would collect the coupon attached to the product. This system of financial rewards generated valuable data about the unit sales of different models.

In 1932, two-man teams from the production and sales departments began a series of study tours visiting retailers and surveying the market. While they strengthened their relationships with the retailers, the teams were also able to hear directly from them—and from consumers—about the market penetration of Sharp products. They learned valuable information about which product components were prone to failure and about the specific needs of different regions. These marketing efforts were considered extremely sophisticated for the time.

The study tour was an example of the company's commitment to trying out new creative ideas—not only in product development and assembly-line operations, but also in the areas of sales and distribution.

Working Early on to Expand Internationally

Export of Radio Parts Begins

In the spring of 1926, the company began to export radios and radio parts to China, India, Southeast Asia, and South America. In Japan, one year after the company had started manufacturing radios, the medium had at last caught on in major urban areas such as Tokyo, Osaka, and Nagoya.

In June 1927, Tokuji Hayakawa traveled to Shanghai, rented a prominent local restaurant for two days, and held a sample fair. It was a bigger event than the one held in Fukuoka in March and was also a great success. He was able to sell every last product that he had brought with him.

Tokuji, who was considering a full expansion into China, visited a number of the country's regions in June 1930. The following year, his company set up a sales agency in Hong Kong and staffed it with personnel from Japan. In April 1934, he opened a branch office in Shanghai, the company's first such overseas office.



The company's first overseas branch office, established in Shanghai, China

Expanding the International Sales Network

In 1933, Tokuji toured various areas of Southeast Asia over a two-month period. He gave thought not only to selling products, but also to buying local materials. In response to a question from a local newspaper reporter in Singapore, he expressed an interest in buying tin and wood to use in radio components. Reading the article published the following day, radio enthusiasts and timber merchants hoping to do business were prompted to visit him at his lodgings. The meetings were soon followed by the opening of sales outlets for Sharp radios in Singapore.

Next, Tokuji visited Bangkok, Thailand, where his

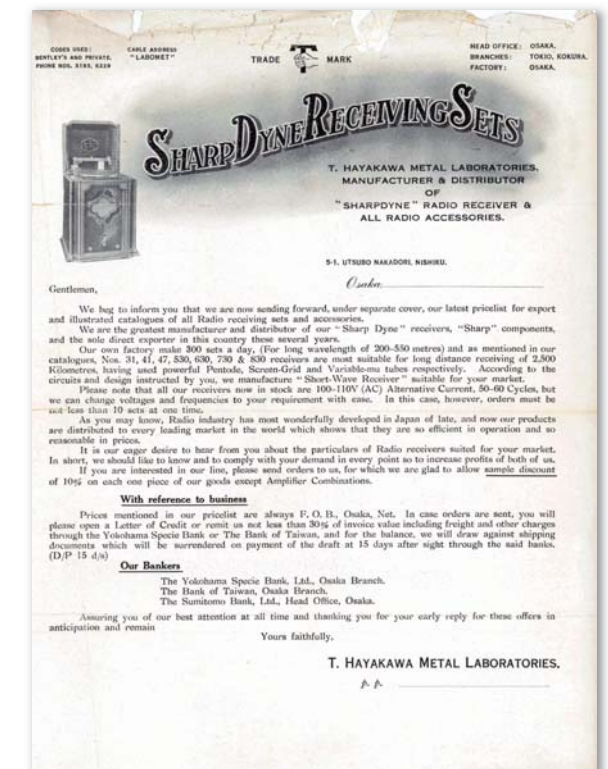

Advertising leaflet from around 1932 addressed to international trading companies. It indicates the products' ability to accommodate a variety of requirements, such as different voltages and line frequencies in various countries. It also mentions the company's willingness to customize radios to receive shortwave broadcasts—a feature not yet commercially available in Japan—as well as the products' flexible pricing strategy.

company already had a representative. Tokuji had presented a five-tube radio to His Royal Highness the Prince of Kamphaengphet during his trip to Japan in 1930. Consequently, the Sharp brand name was well known in Bangkok. In fact, it was said that up to 90% of the radios in the region were Sharp products. The company was represented by Bangkok Trading Company (BTC), one of Thailand's premier radio importers. Sharp continues to do business with them to this day.

From an early time, Tokuji's company promoted foreign trade; by 1933 its annual export sales of radios alone had reached 300,000 yen. Sharp radios were later exported extensively not only to China and Southeast Asia, but also to Europe, the Middle East, Australia, Africa, and South America.

4 Incorporation and Wartime Operations

Reorganizing into an Incorporated Company

Ten years had passed since the company had successfully assembled Japan's first crystal radio set. The scope of business operations had expanded, and the company's name recognition had increased. Tokuji decided to convert his privately held company into an incorporated organization in order to promote further business expansion and gain greater trust from society through the disclosure of reliable management information.

On May 1, 1935, at the Shin-osaka Hotel (now the Rihga Royal Hotel Osaka), a meeting was held to establish Hayakawa Metal Industry Institute Co., Ltd. (*Kabushikigaisha Hayakawa Kinzoku Kougyo Kenkyusho*). Registration of the establishment of the corporation was completed the following day, with Tokuji Hayakawa appointed president. Capital at the time of the corporation's establishment was 300,000 yen (fully paid). The company employed 564 workers and owned 10,056 m² of factory sites, along with other buildings covering 3,181 m². A further investment of 200,000 yen the same month increased capitalization to 500,000 yen.



Organizational meeting of Hayakawa Metal Industry Institute Co., Ltd.

In June 1936, having cemented its foundations in the radio business, the company changed its name to Hayakawa Industrial Co., Ltd. (*Hayakawa Kinzoku Kougyo Kabushikigaisha*).

The same month, the company built on an earlier investment to take a controlling stake in Yokohama Motor Parts Manufacturing Co., Ltd., an automotive parts manufacturing company with 250 employees. Tokuji took over as president of the company, which later became Hayakawa Dengyo Co., Ltd., a specialist in fluorescent lighting fixtures.

Tokuji's main company underwent another name change in May 1942, becoming Hayakawa Electric Co., Ltd. (*Hayakawa Denki Kougyo Kabushikigaisha*). The company constructed a new wooden two-story head office building in 1943. In addition, the company established a new research center to study applications of short- and ultra-short radio waves.

Successive injections of capital meant that by April 1945, before the end of World War II, capitalization had reached 8.3 million yen.

Business-Related Social Contributions

■ Opening the Hayakawa Commercial School for Youth

As a child, Tokuji had few opportunities to study in school and had a difficult time studying on his own. He would, for example, learn to read *kanji* characters only after having finished his daily tasks at his master's house. With this in mind, he was strongly motivated to give employees who had only graduated from elementary school the opportunity to study. Mastering the specialized knowledge of commerce and future industry would be advantageous not only to the individual employee, but also to the company, which would benefit from the development of outstanding human resources.

April 1935 saw the issuance of the Youths' School Ordinance. This Imperial edict targeted young people who had entered the workforce after graduating from elementary school by providing them with educational opportunities while they worked in factories or offices.

In May 1936, establishment of the Hayakawa Commercial School for Youth was finally approved, and the school was established the following year. Forty students were enrolled in the comprehensive course and 108 in the regular course, with tuition provided by 15 lecturers and instructors.

Diploma from the Hayakawa Commercial School for Youth

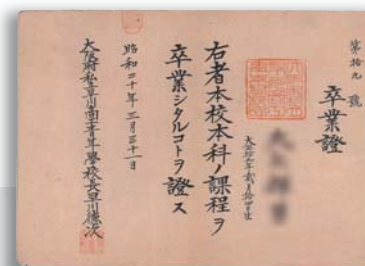

Building that housed the Hayakawa Commercial School for Youth

■ Donating Products for the Community

In order to bring the new culture of radio to a wider audience, the company made ongoing donations of radios to disadvantaged members of the community.

In 1930, the company began monthly donations of radios to orphanages and homes for the aged. By 1934, the total had surpassed 200 sets. The company also made donations to hospitals and elementary schools that had lost radios due to wind or flood damage. These efforts sprung from a strong desire to serve society through business.

Radio Production in Wartime

■ Materials Run Short

At the beginning of the 1930s, Japan was edging towards a wartime footing. By the middle of the decade, the cost of raw materials such as metal stock had skyrocketed, and companies decided to raise prices of consumer goods. Beginning in 1934, the Hayakawa company was forced repeatedly to raise prices.

Noteworthy products of this era include the Meicho ("clear listening") No. 1 radio, introduced in 1937. This radio overcame the weakness of regenerative receivers, which featured high sensitivity but which were susceptible to noise from self-oscillation. The Meicho No. 1 incorporated a function that could be adjusted to prevent this noise, enabling broadcasts to be heard clearly.

In July 1937, war broke out between Japan and China, and controls began to be imposed on materials. Initially, radios were regarded as luxury items, and the restrictions served to reduce their production. As the war progressed, however, people grew hungry for news. Realizing the valuable role that radio played in its public relations efforts, the government loosened restrictions on radio manufacturing.

To cope with the shortage of materials, the Osaka Radio Industry Association was created in April 1938, with President Hayakawa as the founder. In September of the same year, the association—along with the Tokyo Radio Industry Association and the Japan Broadcasting Corporation—organized a committee to standardize radio equipment. It was agreed to standardize radio models and prices while pursuing greater savings in materials, improved production efficiencies, and greater ease of use for the customer.

■ Designs That Saved on Materials; Meeting Strong Demand

As the wartime fighting grew more intense, the supply of radio materials worsened. Nevertheless the company was able to meet strong demand by making a strenuous effort to conserve materials and improve production efficiency. To reduce the amount of metal used, engineers came up with a series of creative ideas. These included devising innovative circuitry designs, eliminating transformers, using substitute materials such as paper, and shrinking the size of components.

The company had also been actively working to capitalize on new demand from regions such as China. In September 1938, for example, it received an order for 20,000 radio sets from a Chinese Telecommunication Company. Fortunately, the Hayakawa company had unimpeded access to sufficient supplies of the materials used in export goods—even those under wartime control—and therefore succeeded in fulfilling this large order. The

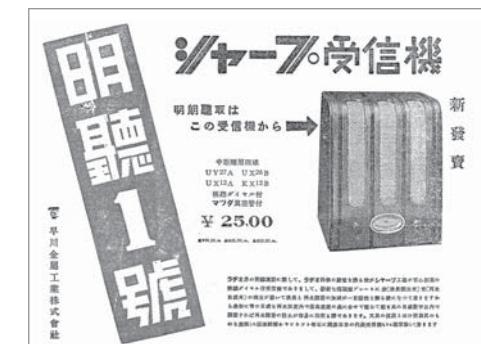

Ad for the Meicho No. 1 radio (from the industry journal, *Radio Koron*; June 20, 1937)

company also introduced to this region a superheterodyne* radio with push-button station selection. This radio's long-range reception enabled users to listen directly to major broadcast stations from the distant Japanese home islands.

Manufacturing Two-Way Radios

During the war, the company also manufactured portable two-way radios for the military. This was done to ensure the company's survival and to safeguard the livelihood of employees.

In December 1941, the Pacific War broke out, and in July 1942, military authorities asked the company to build 30 prototypes of a two-way radio for use in aviation. These radios required sophisticated technology; even specialized radio equipment manufacturers had put together no more than one or two such sets. After building a successful prototype, the company developed plans to produce an extraordinary 200 units per month by the end of 1943. Thanks to the company's expertise in assembly-line operations—gained through years of radio manufacturing—it was able to successfully achieve this goal.

To expand its production facilities, the company opened a new plant in June 1944 in Izumi-fuchu—in the southern part of Osaka Prefecture—and another one in Kyoto in April of the following year.



Radio production assembly line at the head office plant (1941)

* A superheterodyne radio-receiving circuit design shifts the received signal to an intermediate frequency, which is then amplified and demodulated. This system offers high sensitivity and is resistant to interference.

5 A Post-War Rebirth Based on Radios

Returning to Peacetime Industry— A Business Revival Driven by Radios

On August 15, 1945, the Pacific War came to an end. One week after hostilities subsided, the company harnessed its full expertise to offer customers a free radio repair service. Nearly 100 people lined up every day in front of the company's head office.



After the end of the war, long lines formed for free repairs of radio sets

For people who had long been forced to live under the austerity of war, entertainment programs on the radio had become one of the few sources of enjoyment.

President Hayakawa developed policies to adapt his business to the prevailing circumstances. First, he narrowed the company's scope to focus on producing only radios, just as before the war. Next, he aimed to revert the business to the size it was in 1941 and support the normal retirement of employees or help them find other jobs. The final policy initiative involved focusing on mass production of broadcast-station models—later, Kokumin-gata (“national-type”) home radios—which had standard specifications set by the Japanese government through the Japan Broadcasting Corporation.

Starting Out as a Private Company

In August 1946, the government announced that wartime reparations were being discontinued. A special war indemnity tax of 100% was imposed on radios and wireless equipment delivered primarily to the government and the military during the war—this was effectively a form of compensation.

To deal with this, the government created a special accounting system to prevent the collapse of companies for whom this tax would be a fatal blow. Hayakawa Electric was deemed one such company. Debt consolidation and business accounting were dealt with by separating accounts into two categories: one for old debt incurred during the war and one for post-war consumer business.

Later, on December 10, 1948, the company increased its capitalization to 30 million yen and merged the old and new accounts. Released from its special accounting arrangement,

the company was finally able to regain its management autonomy. The company's financial performance began an upturn around late 1948: in the four months following the

increase in capitalization, net income of 3.92 million yen was posted on sales of 132 million yen.

With the capital increases at the end of 1948, the company began trading its shares through the Osaka Securities Dealers Association. On May 14, 1949, the company's stock was listed on the Osaka Securities Exchange. The selling price for the first trade on June 2 was 42 yen per share. Given the economic situation at the time, this was considered an auspicious first market trade. With the public offering of stock, the company would continue its business activities as a publicly responsible institution.

It should also be noted that the company's trade union was formed on February 1, 1946, following the promulgation of the Labor Union Act in December 1945.

Focusing on the Kokumin-gata Radio

In March 1946, the Japanese government, the Communications Industry Association of Japan, and others established standards for a Kokumin-gata radio—a new standardized radio receiver intended to be sold nationwide. It carried an officially set price and was exempt from excise taxes. The company took advantage of this system to introduce the Sharp Kokumin-gata No. 1, No. 2, and No. 2-B—models that notably expanded sales.

In June 1946, the Ministry of Commerce and Industry (now the Ministry of Economy, Trade and Industry) indirectly called for increased production of radios. This request would lead to serious problems in the future; many manufacturers would later neglect to downsize their operations and would struggle with high costs everywhere they turned. Moreover, company management continued to face difficult times in trying to boost production, owing to a lack of key materials, an increase in wages, and a decrease in purchasing power due to inflation.

Prices for the Kokumin-gata radios soared, with official prices revised frequently. Finally, in August 1947, prices exceeded the point where the products were exempt from excise taxes, and a 30% tax was imposed. Sales of Kokumin-gata radios weakened considerably thereafter.



WWII-era head office plant that survived the war

Sharp Radios over the Years

From Crystal to Vacuum Tubes to Transistors

The golden age of radio in Japan spanned the 35-year period from 1925, when broadcasts began, to 1960, when television became widespread. The wartime economy of the mid-1930s and later hampered development of technology for radios. But in homes across the nation, radio continued to serve as the family's primary source of information and entertainment.

| | | |
|--|---|---|
| <p>+ 1925 + <i>Radio's Infancy</i></p> <p>Crystal Radio Comprising a tuned circuit for picking up broadcast signals and a crystal detector for extracting the audio signal from the radio waves, the crystal radio required a receiver in order to function properly.</p> | <p>+ 1929 + <i>Radio Age Dawns</i></p> <p>Battery-Powered Vacuum-Tube Radio Although the vacuum-tube radio had a speaker to amplify sound and boasted high sensitivity, its expensive battery had to be replaced periodically, making it no more than a temporary product on the scene.</p> | <p>+ 1930 + <i>Growth Period</i></p> <p>AC Vacuum-Tube Radio (No. 30) Drawing its power from a lamp line, this radio featured a separate speaker placed on top of the main unit.</p> |
| <p>+ 1930 + <i>Growth Period</i></p> <p>Radio with Built-in Speaker (No. 21) This radio used regenerative detection to improve sensitivity, with sound being picked up directly from different frequencies. This was the most common type of radio until the end of World War II. Sharp was the first company to make a radio with built-in speakers.</p> | <p>+ 1932 + <i>A Maturing Market</i></p> <p>Phono Radio (No. 53) Sharp released a combination radio and record player, designed as a luxurious piece of furniture.</p> | <p>+ 1932 + <i>A Period of Development</i></p> <p>Midget Radio (No. 34) Advancements in vacuum tube performance—including four- and five-terminal designs—enabled radios to become smaller. Sharp's midget radio was a popular addition to the company's product lineup.</p> |
| <p>+ 1938 + <i>Growth Slows</i></p> <p>Wartime Austerity Radio (Aikoku No. 1) Tightening wartime measures restricted the amount of metal that could be used for radio parts such as transformers. Soon only government-standardized models were being manufactured.</p> <p>Note: The Sino-Japanese War broke out in 1937, miring the country in war.</p> | <p>+ 1950 + <i>Business Recovers</i></p> <p>Superheterodyne Radio (SR-50) Shortly before the onset of private broadcasting in Japan, there was an industry-wide switch to superheterodyne models, which offered superior sensitivity and clearer channel selection. Compact, inexpensive models became popular.</p> <p>Note: Superheterodyne models were built during the war years, but these were specialized models designed to function over long distances.</p> | <p>+ 1957 + <i>The Zenith</i></p> <p>Transistor Radio (TR-115) The transistor revolutionized the radio. Compact, portable radios were a hit around the world.</p> |

Overcoming a Financial Crisis

Japan's First Commercially Produced TV

Sharp developed the first TV produced in Japan, and in 1953, quickly moved to mass-produce sets before the start of television broadcasting. The company's foresight in launching research on TVs in 1931—just as radio was beginning to gain in popularity—was finally bearing fruit. The Sharp TV was born as the company overcame a crisis of survival resulting from post-war turmoil and recession.

The company played a central role in popularizing television and aimed to bring TVs to every home.

It also added a variety of electrical products to its lineup that brought greater convenience to housework.

The company boldly expanded with the aim of becoming a comprehensive consumer electronics manufacturer.

TV sets and components in 1953

1 From a Crisis of Survival to a Financial Turnaround

Handling a Steep Drop in Demand for Radios

■ Tight Fiscal Measures Bring About a Recession That Hits the Company Hard

In the years after the war, Japan experienced severe inflation as a result of serious shortages of food and materials coupled with increased government spending intended to spur economic recovery. Between the fall of 1945 and the spring of 1949, the consumer price index saw an almost 100-fold increase (based on official prices).

To counter this situation, in 1949 and 1950 the General Headquarters of the Allied Forces (GHQ) implemented a series of financial and monetary austerity measures that included an anti-inflation policy (the so-called "Dodge Line"). The main recommendations of the initiative were to balance the national budget and reduce subsidies from the government. As a result, funds available to the open market were dramatically reduced. While this brought inflation under control and stabilized prices, rapid deflation took hold and the country fell into a deep recession. Unemployment soared, and consumer purchasing power began to decline.

After the war, the radio manufacturing industry had recovered relatively quickly and production capacity had risen. Yet sales became extremely sluggish due to the recession, and inventories became bloated. Furthermore,

commercial radio stations were scheduled to begin broadcasting the following year on new frequencies different from those used by Japan Broadcasting Corporation (NHK). The industry suffered another blow when consumers were reluctant to buy Kokumin-gata radios designed to receive NHK stations. Rumors circulated that these conventional radios would be susceptible to interference from the new commercial stations. Instead, consumers were choosing to wait for newer superheterodyne models that had better channel selectivity.

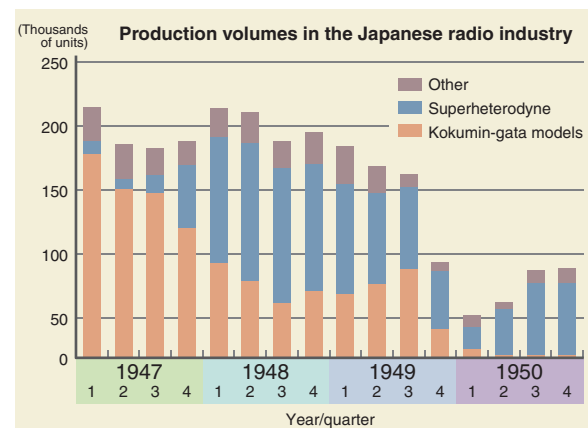

Although demand for low-price Kokumin-gata models had begun to increase in the midst of the recession, it plummeted at the beginning of 1950 as consumers reined in their spending.

In addition, black-market traders who paid no excise tax were flourishing, and this added to the turmoil in the market. The situation grew dire, with radio production in the industry plummeting from 800,000 sets in 1948, to 600,000 in 1949, and less than 300,000 units in 1950. Bankruptcies slashed the number of radio manufacturers from 80 immediately after the war to just 17 companies.

■ Desperate Efforts to Keep the Company Afloat

The company was saddled with a mountain of inventory and was posting losses due to wholesalers failing to pay their bills. Cash flow was tight as well. Under these circumstances, on the dates when the company's own bills were due, individual sales employees around the country scrambled to collect the proceeds from sales, which were then remitted to the head office as quickly as possible in amounts of 20,000 yen or even 10,000 yen at a time. It was a desperate effort to stave off bankruptcy.

At the end of February 1950, salary payments were delayed. In April, the company took a number of measures, such as strengthening its sales organization, lowering selling prices, and introducing a low-priced superheterodyne radio. In addition, production was suspended to concentrate on selling existing inventory. However, during the period from April to June, average monthly sales dropped to 15 million yen—40% of the figure for the equivalent period in the preceding year. By the end of July, borrowings amounted to 132 million yen. The company was also paying a special war indemnity tax, and there was insufficient cash on hand to cover these payments.

■ Overcoming the Crisis with Tremendous Cooperation and Support

Banks made reducing excess personnel a prerequisite for granting additional loans: "You should cut 210 people, and make it an organization of 378 people, which should be able to maintain current sales levels. And you should make further management efforts." President Hayakawa, however, had other ideas: "It would be better to dissolve the company than lay off so many employees." He gathered all the employees together and conveyed his thoughts to them. The employees responded by shouting, "Don't kill the company!"

At a labor council meeting on August 9, 1950, the company announced a reorganization plan that included staff reductions. Many union members also had strong hopes for the survival of the company and agreed to solicit members willing to take voluntary early retirement. A pamphlet entitled, *About Ways*



A pamphlet entitled *About Ways for the Company to Get Back on Its Feet* was distributed to all employees (August 1950)

for the Company to Get Back on Its Feet, was distributed by the company to all employees, outlining the actual condition of the business, including sales, profits, and debt, as well as a strategy for reorganization. Within a month, the number of employees taking early retirement reached the target set. Furthermore, on top of the personal guarantees of all the executives, the company received joint financing of 15 million yen from four different banks.

Under the reorganization plan, retirees received a discharge allowance as stipulated by law, severance pay of two months' salary, and a compensatory gift such as a commemorative radio. As well as assisting employees who chose to seek new jobs, the company promised them preferential status when the time came once more for the company to take on new employees. The layoffs that the company was forced to make at that time were a painful episode for everyone involved.

Business Recovery Thanks to Growing Demand for Radios

■ Military Procurement for the Korean War Sparks a Boom

In June 1950, the Korean War broke out. Military procurement for the war saved Japanese industry, which had been struggling in a recession. The economy turned around and sales of goods boomed. In the radio market, customers' desire to hear shortwave broadcasts telling of the growing international tensions fueled demand for All-Wave multi-band radios.

Net income for the fiscal period ending March 31, 1951—at the time, fiscal periods were six months long—was 3.43 million yen, with the company



US soldiers prepare for an amphibious landing during the Korean War (1950) (photo courtesy of *Asahi Shimbun* newspaper)

returning to profitability for the first time in over three periods. That April, there was a large order for radios from the US government. This helped to boost net income for the period ending in September by more than four times, to 13.29 million yen.

Nevertheless, the company saw the boom as temporary and implemented a series of prudent management measures in preparation for any sudden future recession. These measures helped the company withstand the impact of the national recession that followed the cessation of US procurements for the Korean War.

■ Commercial Radio Boom Boosts Popularity of "Super Radios"

Nine private commercial radio stations began broadcasting in 1951, with that number swelling to 21 the following year. The resultant variety of programming on offer sparked a boom in consumer demand for radios, which in turn led to a rapid recovery in radio manufacturing.

The new Sharp 5R-50 Superheterodyne Radio introduced in July 1950 was a compact, mass-produced model. It offered enough selectivity to prevent interference among multiple broadcast signals from stations in urban areas, along with the high sensitivity needed for receiving urban commercial broadcasts in rural areas. Sold at an affordable price point, it became a popular product.

Then there was the hit NHK radio drama, *Kimi no na wa* ("What's Your Name?"). In 1952, the popularity of this program helped drive the number of radio subscribers beyond 10 million, marking a peak for the radio industry.

2 The Dawn of the Television Era

Success in Developing a Prototype TV

■ Research on Television Began Even Before the War

In December 1926, Kenjiro Takayanagi—an assistant professor at Hamamatsu School of Technology, which is now Shizuoka University's Faculty of Engineering—successfully tested an experimental television based on technology that he had developed himself. Hearing of this, Hayakawa expressed his confidence that radio would be superseded by the era of television. He wanted his company to research this new technology. So he sent a postcard to the school with a job offer bearing the simple words, “Seeking a graduate.”

Reading the postcard, the professor who chaired the electrical engineering department thought it had come from a small company not used to dealing with personnel matters. Yet, from that brief sentence, he also got the feeling that it was a company passionate about new technology. The professor visited the company and found a small factory that nevertheless held promise. He was impressed, for example, by the sophisticated metal press techniques that formed the basis of the company's radio manufacturing.

In March 1931, one of Professor Takayanagi's most well regarded graduate students joined the company. A radiowave engineering laboratory was set up and research on television began, driven chiefly by this young man. Later, as the clouds of war grew ever darker, research on television was banned by the government.

■ Development Efforts and a Successful Prototype

For a period after the war, the occupation authorities (GHQ) did not allow research on television in Japan. It was 1949 before such research resumed in earnest. This long hiatus, which included the war years, caused Japan to fall significantly behind Europe and the US. The company, which had resumed developmental work on television, conducted research by consulting the scientific literature found in the GHQ library.

Industry figures at the time were concerned that manufacturing and servicing televisions would be difficult. Even the major manufacturers were hesitant about introducing commercial TV models. Under President Hayakawa's policy of breaking new ground by taking the initiative wherever possible, the company worked actively on developing a prototype model.

The development process was boosted by the company's expertise with related technologies, such as aviation radios developed during the war and VHF circuitry in FM radios used by police after the war. In 1951, a prototype was finally completed. Twenty years had passed since the graduate of Hamamatsu School of Technology had been invited to begin research.

Early in the summer of 1951, NHK began experimental TV broadcasts from its Osaka broadcasting station. The tests involved sending out a signal from Bamba-cho in Higashi-ku (now Chuo-ku), Osaka City, and viewing the

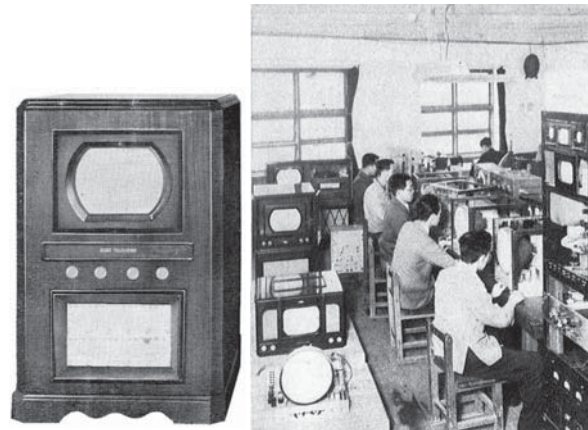

Prototype of a console-model TV with a 12-inch CRT (cathode ray tube) (1951) (left)
Hayakawa's TV research laboratory (1952) (right)

television pictures using an NHK receiver located in the Mitsukoshi Department Store in Kitahama, Higashi-ku. At that time, the company's technical team brought their prototype TV set to the Mizuno Building located near Mitsukoshi and managed to successfully receive the television signals. Those who had gathered to witness the experimental broadcasts were given their first experience of watching television. Apart from them, no one had known of the company's planned experiment—not even the broadcast station. Other manufacturers were duly impressed.

Following this success, the company moved quickly to set up a mass-production system in anticipation of the onset of television broadcasting. Specifically, the company had decided to develop and mass produce three key components on its own—the tuner, deflection coil*¹, and flyback transformer*²—but mass producing the deflection coil proved to be particularly difficult. Based solely on the

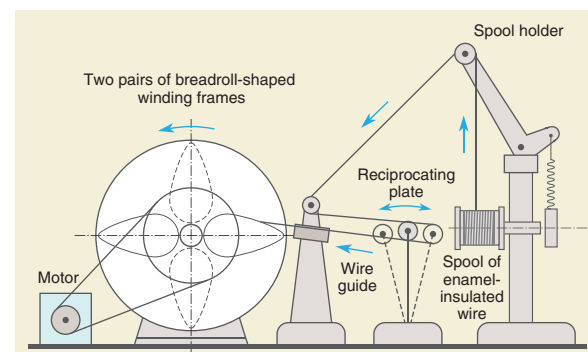
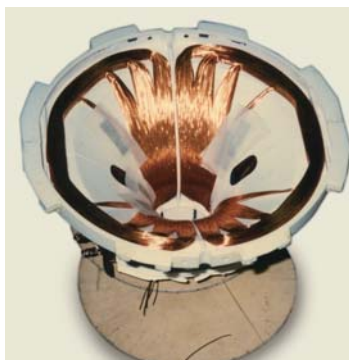

Deflection coil (top) and operation of deflection coil winding machine (bottom)

guidance of a single phrase from a scientific paper—“the deflection coil is a cosine winding”—the company was eventually able to perfect a winding machine that made mass production possible.

Signing a Technical Assistance Agreement with US-Based RCA

The company completed a working prototype of the television. While it was a success in terms of receiving television signals, significant breakthroughs in TV technology had already been achieved in the US and Europe. Moreover, bringing a practical television to market would require the cooperation of Western manufacturers who owned the patents to key technologies. To promote a cooperative technical alliance with RCA (Radio Corporation of America), President Hayakawa visited his old friend Kenjiro Takayanagi and asked for a personal referral to the company. Around this time, Takayanagi had been appointed chief engineer and a director of Victor Company of Japan, Ltd. (now JVC Kenwood Corporation), which had a connection with RCA. Although President Hayakawa was competing with Victor and other rival companies in the development of television, Takayanagi readily agreed to his request. That he did so owed much to the dream that the two men had shared before WWII of developing television in Japan. Consequently, they had a strong desire to provide the public with a Japan-made TV set as quickly as possible.

Accompanied by his chief of research, President Hayakawa visited RCA in the United States, and on June 19, 1952, signed a technical assistance agreement. This became the forerunner of such contracts for Japanese manufacturers, and soon led to Japan's first mass-produced televisions. Etched in his mind were the words of H. Alexander Straus, RCA's Far East representative and the man in charge of overseeing the agreement: “Television is a product that comes along only once in a hundred years and is indeed the product of the century. Please develop it into a

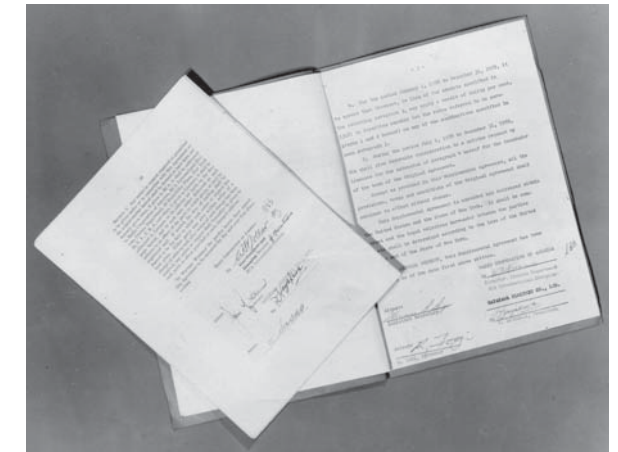

Technical assistance agreement signed with RCA

successful enterprise.”

Over the course of two months, President Hayakawa and his colleague traveled throughout the US and toured leading manufacturers, focusing in particular on the TV industry. With his own eyes, President Hayakawa saw efficient television production that made the most of available machinery and equipment. After purchasing a large amount of state-of-the-art machinery and research equipment needed for production, he returned to Japan.

President Hayakawa had been afforded an intimate look at the state of TV manufacturing in the US. The visit reaffirmed for him the potential of television and deepened his confidence in the TV business.

*1 The deflection coil generates a magnetic field to bend the electron beam projected onto the CRT screen.

*2 A flyback transformer generates the high voltages needed to accelerate electrons in a CRT.

Television Broadcasts Begin

Japan's first television broadcast aired at 2 pm on February 1, 1953. Following greetings from the chairman of NHK, a kabuki play was shown live. As of this day, the number of subscriptions to receive television broadcasts was 866. On August 28 of the same year, Japan's first private station began beaming telecasts.

In the beginning, TVs were prohibitively expensive, so people used to crowd around the sets installed in front of train stations or in shopping arcades. Businesses such as coffee shops, restaurants, barbershops, and public baths installed TVs to attract customers. Professional wrestling was particularly popular at that time: homegrown warrior Rikidozan became an overnight sensation as he cut down foreign wrestlers with his famous ‘karate chop’.



People gather in front of a TV in a public place (photo courtesy of Asahi Shimbun newspaper)

3 Mass Production of TVs Begins

Developing—and Mass Producing—Japan's First Television

In 1952, the government of Japan approved the alliance with RCA, and the company immediately began working on the design for a TV. Three models were developed with 12-inch, 14-inch, and 17-inch screens (measured diagonally), and test results were excellent. In the same year, mass production in the laboratory was successful. The Sharp TV3-14T TV marked the birth of Japan's first domestically produced television. In January 1953, television production was transferred to the Manufacturing Department—which was then made the independent TV Production Division—and full-scale mass production of TVs could begin. Among the factors that enabled this system to be developed so quickly were the bold decision to invest in plant and equipment, and the reservoir of production technologies from before the war.

On January 16, 1953, the company presented its plans for TV manufacturing to a gathering of about 200 marketing and sales staff. The price structure, planned monthly production volume, equipment construction, after-sales service, and other details were described. On hearing the company's ideas and proactive approach, participating retailers had high hopes for TV sales. A model with a 14-inch screen was to be priced at 175,000 yen. This was at a time when the starting salary for government workers with a high school education was 5,400 yen a month.

On February 1, 1953, the long-awaited NHK television broadcasts began, raising the curtain on the era of television in Japan. The subscribers were mainly radio stores, coffee shops, hotels, banks, and other businesses. Initially, the televisions were used for commercial purposes in public places. As a consequence, many were large 17-inch models made by competing companies. In May of the same year, the company added the 12-inch TV3-12T and 17-inch TV3-17T models to its lineup.



Sharp model TV3-14T—
Japan's first commercially produced TV set

Developing a Television Service Organization

Televisions have a much more complicated structure than radios. Learning from the example of the US, the leader in TV at the time, the company knew that being able to offer solid after-sales service was essential to success.

At the same time that it moved to prepare for mass production, the company worked to organize a service system. Beginning at the end of 1952 and covering a period of more than six months, it conducted weekly TV technology training sessions for in-house personnel.

From February 1953, the company held workshops to teach dealers about TV assembly and testing. While gaining hands-on experience assembling a television, they spent a week learning about a TV's construction and developing skills for making adjustments and repairs that would be invaluable for after-sales servicing. The TVs that were assembled during these classes were of a high enough standard that dealers could sell them in their own stores. In addition to the workshops held at the head office, training sessions were conducted at locations around the country.



After-sales service training (left)
Hiroshima group photo (bottom)



The company aimed to develop a network of 1,000 television dealers to provide after-sales service—dealers who would have the technical skills needed to repair broken TV sets, make picture adjustments, and handle similar requests. The training sessions gave dealers a sense of security and confidence when selling televisions in their stores and yielded good results in the early days of TV marketing.

In September 1956, the company established the Sharp Authorized Service Shop system, through which member stores undertook after-sales service on the company's behalf. The name of the shop responsible for after-sales service was printed on the warranty card, so consumers could feel free to request repairs and other services.

Increasing Demand for TVs and Streamlining Production

■ Promoting the 14-Inch TV as the Model for Every Home

In January 1953, when full-scale mass production began, the company produced only fifteen TV sets; but with each passing month, production volume increased. On May 21 of that year, when it was clear that production would reach 1,000 sets per month, the company reduced prices from 175,000 yen to 145,000 yen for the 14-inch model, and from 197,000 yen to 153,000 yen for the 17-inch model.

The industry had initially focused on the 17-inch model, which was in high demand for commercial applications. But the company decided to focus on a model with a 14-inch screen, considering it a better fit for the typical Japanese room and an optimal size for achieving the goal of bringing a TV into every home. The company further streamlined production and introduced a 14-inch model for 127,000 yen, finally achieving its price target of 10,000 yen per diagonal inch of screen size. Price reductions encouraged consumers to acquire TVs, moving toward the idea of “one set per home.”

In May 1954, the company held a 60% share of the 14-inch TV market. Eventually, the 14-inch model would become the standard television size in Japan. The fact that all manufacturers came to focus on this size for their flagship models led to even greater streamlining of production processes, improved quality for parts (especially for the CRT), and progressively lower prices. TVs would later become an important export product, and the focus on the 14-inch screen size is said to have contributed to the international competitiveness of Japan's TV manufacturing industry during its early years.

According to a summary in the book, *Japan's Television Industry: The Structure of Its Competitive Superiority*, by Atsushi Hiramoto, Sharp's share of all models produced in Japan was 22.9% in 1953 (April to December). By 1956, with a 16.9% share, the company had held the top place in the market for four consecutive years*1.

■ Building a New TV Plant

To push ahead with even greater streamlining of production, the company planned construction of a new TV plant at the head office (now the Tanabe Building). President Hayakawa laid down new design guidelines for the construction of the company's first reinforced-concrete production facility as a plant that “will not burn, will not collapse” and that would be a place “where people can work with peace of mind.”

The new plant was completed in March 1954. Production lines were installed that used an endless conveyor system*2,

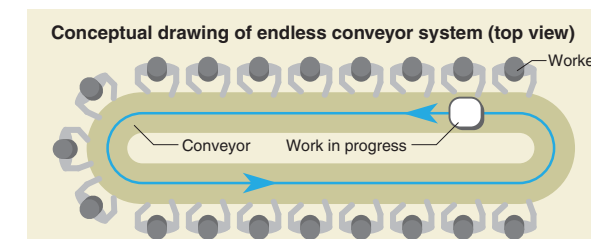

New TV plant

an original design. All processes from wiring and assembly to packaging and warehousing were performed using this assembly-line operation.

To further increase production, the company continued to build extensions to its plants, with TV production capacity eventually reaching 20,000 sets per month. The company worked not only to lead the industry in market share, but also to develop a series of innovative products to generate new demand.

Such products included the TV-500 from 1955, which used an all-metal cabinet, and the TB-50 from 1957, which adopted the world's first push-button tuner. This tuner allowed users to quickly select a station simply by pressing a button, without having to turn a channel-selector dial.

In July 1956, the company completed construction of a new head office building (Head Office, Phase 1). It was a four-story reinforced concrete building, with a partial 5th floor and a basement.



Push-button channel selector on the TB-50

Since 1953 when full-scale mass production of TVs began, the company's financial results had improved year after year. During this period, against the backdrop of strong financial performance, the company constructed a series of new buildings, including new plants, a new head office building, and sales offices.

*1 Source: Data compiled by the Japan Fair Trade Commission.

*2 The endless conveyor system was motor driven and featured a horizontal conveyor that ran in a continuous loop (conventional conveyors moved in a straight line longitudinally). As workers were positioned around the outside of the conveyor, increased production volumes were possible.

4 Aiming to Become a Comprehensive Consumer Electronics Manufacturer

Developing and Commercializing Electrical Appliance Products

■ The Electrical Appliance Boom and Working to Support Exclusive Sharp Dealers

In the first half of the 1950s, the Japanese economy enjoyed a post-war recovery. As people became more affluent, interest grew in durable consumer goods—in particular, electrical appliances. The year when television sales began in earnest, 1953, is generally regarded as the first year of the electrical appliance era in Japan. Beginning around that time, there were three products that every household aspired to own: the electric washing machine, the black-and-white TV set, and the electric refrigerator. These symbols of affluence and aspiration came to be known as the “three sacred treasures.”

With radios and TVs dominating its manufacturing roster, the company was late to enter the market for other home electrical appliances. In addition, the company was affected by competition in the TV market and by the exclusive dealer policies of other companies who could offer a more extensive lineup of products. As a result, the company experienced a significant decline in its share of the television market. To respond to growing demand for electrical appliances such as washing machines and refrigerators—and to maintain the loyalty of its exclusive dealers—the company had to expand the depth and breadth of its product range. In 1957, the company announced a new business policy of expanding to become a comprehensive consumer electronics manufacturer by adding more home appliances to its lineup.

■ Speeding Up Expansion of Electrical Appliances

The company had already been manufacturing its own brand of electric fans since 1956 and had launched production of refrigerators and washing machines in 1957. By adding mixers, toasters, electric rice cookers, and water-cooled air conditioners to these, the company started on the road to expanding and upgrading its electrical

The RC-101 Water-Cooled Air Conditioner, the company's first such product based on an original concept. Because it used underground water, which remains at a nearly constant temperature year-round, it offered better performance as the room temperature increased. This product gained great popularity.

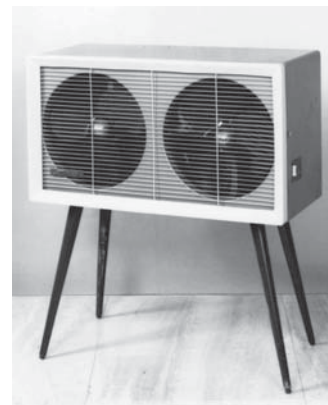

appliance offerings. The water-cooled air conditioner introduced in 1958 used cold water pumped up from underground to cool air inside the device before sending it out into the room. Its outstanding feature was quiet operation: since it did not use a compressor, there was no vibration or noise while it was running.

Around this time, product-development personnel would report on prototypes to senior management, including President Hayakawa, at monthly New Product Promotion Meetings. Product development would then proceed based on opinions expressed in these meetings.

In 1957, Hirano Plant No. 2 was completed. Here, electrical appliances such as washing machines were assembled, and systems established for comprehensive consumer electronics manufacturing. The site covered an area of 10,200 m², with the company constructing separate plants for fabricating metal TV cabinets and for painting. Although washing machines were the company's first large-size product, they were manufactured in volume using a conveyor-based start-to-finish production process—from sheet metal fabrication to painting and assembly. Comparing sales reports for the second half of fiscal 1959 to the first half of fiscal 1957, sales volume of electrical appliances was over five times higher. During the same two-and-a-half-year period, the proportion of the company's total sales achieved by electrical appliances went from less than 10% to more than 20%. These sales figures were a dramatic indication of the company's new impetus.

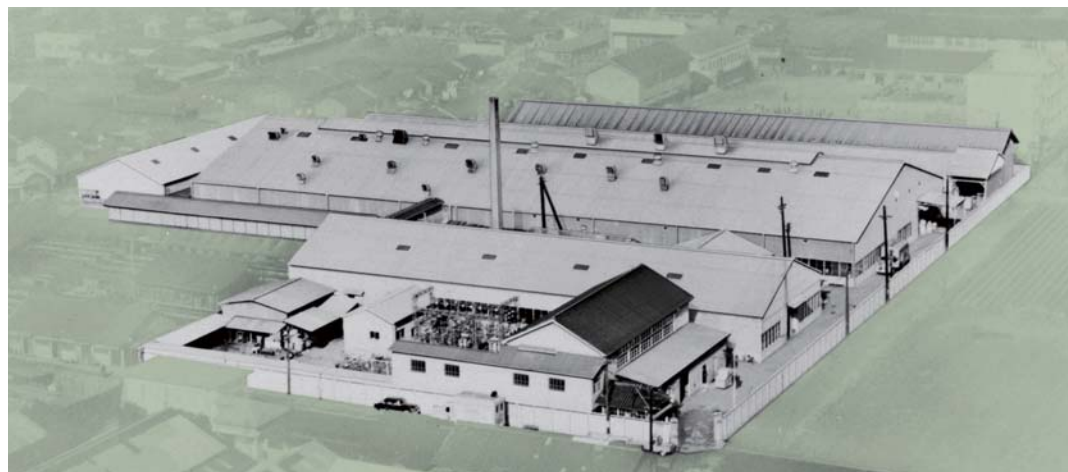

Hirano Plant No. 2 completed in 1957 (Kamimatsuyama-cho, Higashiumiyoshi-ku, Osaka City; now Hirano-ku, Osaka)

Forming Special Design Teams

As a wider variety of electrical appliances appeared on store shelves, consumers began to consider other purchasing criteria beyond performance and functionality—factors such as shape, color, and finish. As the 1950s began, manufacturers were becoming acutely aware of the importance of product design.

In 1954, the company hired an industrial designer to be responsible for the design of radios in the engineering department. In 1957, a section dedicated to design was set up in the respective engineering departments for TVs, radios, and electrical appliances. Up to that point, development engineers had worked on exterior appearance and finish as an extension of design, but from this time forward, product development became a collaborative effort between engineers and designers.

Around this time, plastic, which had only been introduced a short time earlier, came to play a major role in design. For example, using plastic to replace the wood and glass that had been used in radio cabinets up to then provided greater flexibility in terms of shape and color. A widely varied assortment of models became available, ranging from small portable types to large-sized models.

Among Sharp's early product designs, the shape of its electric fan was particularly well known. This original design was called the “Z line” because, when viewed from the side, the neck part supporting the motor and blades formed a shape like the letter Z. Its smart and elegant look, like a swan floating on water, proved highly popular.

The company's product designs were highly regarded and earned Sharp products a variety of design awards. In 1957, the TM-20 14-inch portable TV won first place in a design contest based on a reader poll held by *TV Technology* magazine. In 1960, the BH-350 transistor radio won the Arts & Crafts Association of Osaka Chairman's Award and an award of excellence at the Kobe Design Exhibition.



The TM-20 portable TV featured a novel design in which the channel selector and all adjustment knobs were mounted on the side



Billboard advertising sign for the “Z-line” electric fan posted in subway stations (around 1962)

Advertising Yields Success

In May 1952, the company completed a bus for advertising its radios and TVs. Loaded with TVs, megaphones, and tape recorders, it toured the country. At dealers and retailers, staff demonstrated trial television broadcasts and explained how broadcasting worked.

When private radio stations began broadcasting in 1951, the company sponsored many entertainment programs. A favorite of listeners was a radio program that began in 1953 in which two teams faced off in a singing contest. On television, a Sharp-sponsored show of comic plays beginning in 1956 was a hit with viewers.



This bus toured the country promoting Sharp TVs and radios

5 Strengthening Cooperation with Business Partners and Establishing Sales Subsidiaries

Developing a Nationwide Sales Network

Strengthening Ties with Dealers

Around this time in the Japanese electrical appliance industry, competitors began developing sales networks aiming to bring wholesalers and retailers under exclusive sales arrangements. In 1952, the company responded by organizing the Sharp Club—a nationwide network with regional groups working to expand sales of the company's products and strengthen links with dominant dealers (wholesalers) and retail outlets. The Sharp Club's aim was to enable all parties to prosper together by forging closer ties with one another.

In 1953, the company concluded dealer agreements with 190 leading wholesalers under the umbrella of various branch offices in Osaka, Tokyo, Nagoya, Hiroshima, Fukuoka, and Hokkaido. About 6,300 retail outlets who did business with those dealers became members of the Sharp Club organization. Sharp supported these member stores with a "bonus coupon" system that paid a sum of money as a measure of gratitude for sales, depending on the type and quantity of products sold.

In February 1952, the company also began publishing *Sharp News*, an informational magazine that served as a bridge between retailers and the company.



General dealer conference held to celebrate the completion of the head office building (1956)

In 1958, the company inaugurated the Sharp Friend Shop system targeting retail outlets for whom Sharp products accounted for a large percentage of total sales. The Sharp Friend Shop Association, which comprised these retailers, was formed nationwide with the goal of further strengthening collaboration at all levels. The association undertook coordinated sales and advertising, deepening the relationship of mutual cooperation between the company and retailers.

Sharp Electric Co. Established

In 1952, as the company was moving to develop a network of sales outlets, it spun off its sales division as a separate subsidiary and established Sharp Electric Co. with capitalization of 10 million yen. At this time, the sales



Fukuoka Branch building in Nagahama-cho, Fukuoka City (now Nagahama, Chuo-ku, Fukuoka) (1958)

structure was reorganized by bringing all branches, sales offices, and branch offices of Hayakawa Electric Co., Ltd.—with the exception of the Tokyo Branch and Osaka Sales Office—under the umbrella of Sharp Electric Co. The reorganization also included the addition of new sales offices and branch offices around the country. Furthermore, in 1958, Sharp Electric Co. absorbed and merged with Hayakawa Dengyo Co., Ltd., a company mainly engaged in the sale of fluorescent lighting fixtures.

Hayakawa Electric and Sharp Electric thus became inseparable halves. With one devoted to manufacturing and the other to sales, they worked together vigorously to promote business.

The Beginnings of Regional Sales Subsidiaries

In the summer of 1957, Sharp Shoji, a sales subsidiary in the Osaka area established in 1948, merged with a dealer, Nipponbashi Musen, and made a new start as an exclusive dealer for Sharp products.

As competition for sales of electrical appliances heated up, wholesalers with a fragile business base struggled to maintain cash flow as they were also affected by an economic slowdown. Nipponbashi Musen was no exception. After the Hayakawa company gave it an injection of funding and personnel, it was then absorbed into Sharp Shoji.

In September 1958, Sharp Shoji and QRK Shokai, an exclusive Sharp dealer, were combined to establish Osaka Sharp Sales Co., Ltd. Thereafter, regional sales companies were established throughout the country by making exclusive Sharp dealers the parent entity for such companies.

Also, although television would spread rapidly in the late 1950s, consumers still lacked purchasing power. What encouraged consumers to buy were monthly installment programs operated by manufacturers. In May 1957, the company established Tokyo Sharp Geppan Co., Ltd., to handle such purchases. In June, the company opened parallel companies in Osaka and Kyoto, followed by Nagoya, Hiroshima, and Fukuoka. In this manner, Sharp Geppan came to be established across the country.

6 Establishing a Special Metalworking Plant

Predecessor Was a Branch Factory of Hayakawa Electric

The Tokusen Metal Limited Partnership was established in 1950 with a view to being operated by individuals with disabilities.

The predecessor to this company was a branch factory of Hayakawa Electric established in 1944 to do metal press and stamping work. That factory had come into being the previous year, upon a request from Takeo Iwahashi, the founder of the Nippon Lighthouse—a facility located near the head office that assisted visually impaired individuals. Iwahashi had requested assistance in providing jobs to military veterans who had lost their sight in the war. At the factory, they were put to work fabricating wireless radio parts.

At the end of the war, the branch plant had been closed and the employees dismissed. In 1946, seven of these individuals came forward and asked to return to work. President Hayakawa set up a metal stamping plant in the quietest and sunniest part of the head office plant. He encouraged them saying, "There aren't a lot of new job opportunities for the visually impaired. You should all work with the pride of those who have been specially selected for this work from among many." He named the factory the "tokusen" plant, meaning the "specially selected" plant.

Becoming the Tokusen Metal Limited Partnership

This company's 150,000 yen in capital consisted of the retirement benefits of the seven individuals paid by the company, along with loans from rehabilitation funds provided by the Osaka Prefectural government. The visually impaired persons themselves became the owners of the Tokusen Metal plant and operated it on a self-supporting



Operations at the Tokusen Metal Limited Partnership factory (around 1950)

basis. It was likely to have been unprecedented that seven visually impaired persons shared responsibility for jobs such as machine operation and maintenance, as well as accounting, personnel, and administrative affairs. They discussed problems in monthly meetings of the full-time employees, and broke new ground in running a business by themselves.

In 1952, this company began assembly work for parts incorporated into Sharp radios and televisions. Later, the company expanded its assembly business to include printed circuit boards for calculators and remote controller transmitters. As the Hayakawa company's business developed, the products Tokusen Metal produced became ever more sophisticated.

The story of the Tokusen Metal plant being operated as an independent self-sustaining company became widely known. In April 1952, the renowned social entrepreneur Toyohiko Kagawa—accompanied by wealthy philanthropist John D. Rockefeller III—took a personal tour of the factory. Then, in 1954, HIH Prince Mikasa and HIH Prince Takamatsu toured the plant. These individuals were among an endless stream of celebrities wishing to see this place of work where visually impaired people worked independently and with peace of mind.

Five Accumulations of Competency

The period from late 1949 to early 1950 was a difficult time for the company but it secured a bank loan and set off on the road to recovery. In those hard times, Tokuji Hayakawa decided to establish a management path that would put the company on solid business ground. Based on personal experience, he came up with five principles of business centered on credibility. He put these on the wall of his office as his personal teaching, and people who visited him saw firsthand the struggles Hayakawa had been through and the origin of these principles. They were gradually conveyed from person to person and eventually became the company creed.

五つの蓄積

取引先の蓄積
人材の蓄積
奉仕の蓄積
資本の蓄積
信用の蓄積

Five Accumulations of Competency

Accumulation of credibility
Accumulation of capital
Accumulation of community service
Accumulation of human resources
Accumulation of customers

History of Television

Development at Sharp

Higher picture quality

Progress in broadcasting infrastructure

Ease of use

"Double sign" feature for simple color adjustment



1969: 19C-D3UN
Used two on-screen red lines (the "double sign") to simplify color adjustment

Automatic picture adjustment
1959: TD-81
Automatically optimized picture quality for each channel

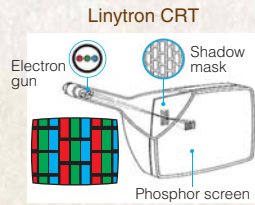

1972: 14IC-401
Used a horizontal electron gun to eliminate color shift

Key Station F500
Featured 500 lines of horizontal resolution for high picture quality



1985: 21C-K5B
Displayed detailed images with at least 500 lines of horizontal resolution when driven by video input

NewsVision
Allowed display of text broadcasts



1994: 32C-WD5
Allowed the user to view news in the form of text broadcasts while watching a TV program

TV with support for multiplex broadcasts (text and audio)



1983: 21C-L1
Allowed users to timer-record a text program or superimpose text onto a TV program

Start of test text broadcasts in Japan
1983

Start of text broadcasts in Japan
1985

Start of BS broadcasts in Japan
1989

TV with an Advanced Super-V LCD



2001: LC-20B1
Used an Advanced Super-V low-reflection black TFT LCD

HOME1125 high-definition TV



1992: 36C-SE1
Incorporated a simple MUSE decoder and pioneered HDTV for households at the low cost of one million yen

Start of test high-definition MUSE broadcasts in Japan
1991

Start of CS broadcasts in Japan
1992

LED AQUOS



2009: LC-60LX1
Delivered high picture quality by combining UVVA technology and LED backlighting

Terrestrial digital high-definition LCD TV



2003: LC-37AD1
Incorporated a built-in terrestrial digital HDTV tuner

Start of terrestrial digital broadcasts in Japan
2003

Start of BS digital broadcasts in Japan
2000

Start of CS digital broadcasts in Japan
1996

70-inch AQUOS Quattron 3D



2011: LC-70X5
Allowed users to enjoy a compelling, high-quality picture on a large 70-inch screen, which was more than four times the size of a 32-inch model

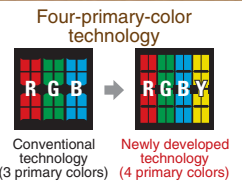

2010: LC-60LV3
Displayed colors such as glittery gold and bright yellow with vivid clarity thanks to four-primary-color technology that added yellow sub-pixels

Sakai Plant goes online

Kameyama Plant goes online

Japan's first domestically produced TV



1953: TV3-14T
The first TV to be mass-produced in Japan

Start of television broadcasts in Japan
1953

Sharp's first color TV



1960: CV-2101
Reproduced vivid images thanks to a proprietary color circuit

Start of color broadcasts in Japan
1960

Tochigi Plant goes online

All-channel TV
1968: 20G-W1U
All-channel TV with support for UHF broadcasts

Start of commercial UHF broadcasts in Japan
1968

1978: AN-1
Audio multiplexing adapter
1979: CT-2006
TV with built-in audio multiplexing functionality

Start of test broadcasts with audio multiplexing in Japan
1978

Start of broadcasts with audio multiplexing in Japan
1982

New Head Office Plant goes online



1957: TM-20
Featured a 14-inch design that could be easily carried anywhere in the home

TV-in-TV capability



1978: CT-1804X
Offered TV-in-TV capability for displaying two programs at the same time

Integrated TV and VCR



1980: CT-1818V
Integrated a TV and VCR into a single, stylish unit

X1 PC-TV



1982: CZ-800C/D
In addition to TV and PC functions, it could superimpose TV and PC images

3-inch LCD color TV



1987: 3C-E1
Used a color TFT LCD panel

Window Series large-screen LCD TV



1995: LC-104TV1
Used a 10.4-inch color TFT LCD panel

Introduction of AQUOS



2001: LC-20C1
Proposed a mobile approach to watching TV in the home with a portable design, set at a retail price of about 10,000 yen per inch

Freestyle AQUOS featuring freedom of installation



2011: LC-60F5
Introduced 32/40/60-inch models of the Freestyle AQUOS; expanded ways for watching TV by allowing the user to place the TV almost anywhere

Introduction of the Freestyle AQUOS



2011: LC-20FE1
Proposed the idea of carrying the TV with you to wherever in the home you want to watch it



1957: TB-50
Allowed users to quickly tune stations with a push-button channel-switching device



1959: TW-3
Allowed users to turn the TV on and off, switch channels, and control volume with a cordless remote control



1972: 20C-241
Displayed the channel number on the screen in large text for one or two seconds after changing channels



1979: CT-1880
Used a control unit that could be detached to serve as a remote control or attached to serve as a touch sensor



1985: 28C-G10
Used a digital TV circuit to display images from nine channels on the same screen



1991: 9E-HC1
Used an 8.6-inch color TFT LCD panel



AQUOS Familink support
2006: LC-37GX1W
Used a single remote control to operate both the TV and a video recorder

Becoming a Comprehensive Home Appliance Manufacturer Creating New Demand through Products

Demand for appliances boomed amid Japan's rapid economic growth. Besides TVs, Hayakawa Electric expanded into washing machines, refrigerators, and other products. It also began research into cutting-edge electronics, which led to numerous successes: mass production of microwave ovens and solar cells, and the world's first all-transistor diode calculator.

Harnessing the product appeal of color TVs and an increasingly advanced mass-production system, the company set up a series of sales companies overseas while boosting its export capabilities.

Pattern of the S-224, Sharp's first solar module

1 New Company-Wide Business Division System, Factory Expansion

Senior Executive Director Saeki Appointed

On May 10, 1958, Akira Saeki, for many years in charge of financial affairs at the company, was appointed to the highest management position of Senior Executive Director. It was hoped he could steer the company on a new course amid the volatile economy of that time.

He went on to enact numerous management reforms. The company took measures to expand its appliance lineup, began research into cutting-edge technologies, and started whole new product categories, including microwave ovens and calculators. It also focused on exports, as it set up sales companies in the US and other countries. With a careful eye on the business environment, Hayakawa Electric conducted capital investment and production plans, and deftly procured and adjusted financial resources. It also constantly strove to reduce costs, increase productivity, and boost profitability.

In June 1961, the company established the Hirano Division. In August 1963, it introduced a company-wide system of business divisions. Besides divisions for wireless products and appliances, the company launched a division for gas, cooking, and lighting products. Under the new system, each division was responsible for its own sales and profits. In May 1964, the company added a division for industrial equipment.

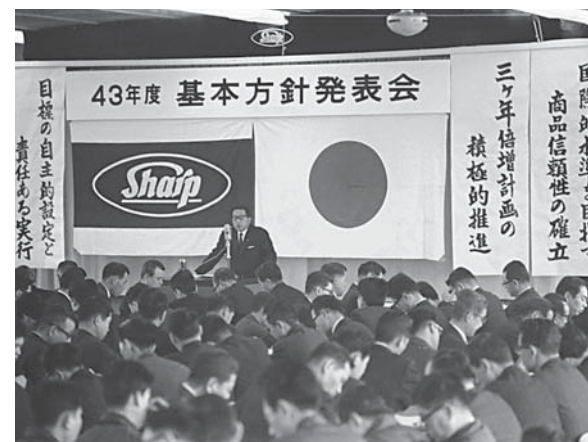

Senior Executive Director Saeki announces the company's first Basic Management Policy

On January 4, 1968, Hayakawa Electric held its first Basic Management Policy Presentation. Beyond merely explaining the company's management aims, this presentation analyzed the worldwide economic situation and industry trends, and it presented a clear company vision with measurable goals. Since 1968, the Basic Management Policy Presentation has rung in every new fiscal year at the company.

New Factories Built

As Hayakawa Electric expanded its operations, it built factories in new locations. The first step was to build a dedicated appliance factory in Takatori-cho (now Kitakamei-cho), Yao City, Osaka Prefecture; the aim was to have appliances account for 50% of the company's sales. In July 1959, the first building of the Yao Plant (originally called Hirano Plant No. 3) was completed. The facility boasted coating, plating, machining, and assembly capabilities. Particularly impressive was the totally automated plating factory, at that time said to be the most advanced in Asia. In October 1960, a refrigerator plant was completed. Around the same time, production lines were completed for water-cooled air conditioners, washing machines, fans, and oil heaters. Hayakawa Electric thus had the ability to manufacture numerous appliances in a single, comprehensive factory. By running its business utilizing such a comprehensive plant, the company could rapidly shift personnel and other management resources between sectors in response to changes in product demand. This ensured that the plant achieved optimal production levels and stable overall operation.

In June 1959, the company purchased land in Minosho-cho, Yamato-koriyama City, Nara Prefecture, where it built the Nara Plant (originally called the Yamato-koriyama Plant). While the new plant was being built, conveyor belts were installed in the previous building for the production of TV parts. In January 1960, Plant No. 1 was completed, and it began producing deflection coils, flyback transformers, and tuners for TVs, as well as radio parts. In 1962, the Nara Plant began producing voucher printers and commercial microwave ovens. In 1964, the company built a dedicated plant to strengthen production of industrial equipment. It also began mass production of the world's first all-transistor diode calculators and was now on its way to becoming a comprehensive electronics maker.

In May 1967, Hayakawa Electric completed the Hiroshima Plant in Isomatsu, Iida, Hachihonmatsu-cho, Kamo-gun, Hiroshima Prefecture (now Hachihonmatsu-iida, Higashi-hiroshima City). Built as a dedicated radio facility, it allowed the company to boost exports of transistor radios and was its first production base outside of Japan's Kansai region. It began production in June 1967, and added production of car radios and walkie-talkies as well. Of the approximately 1.62

million radios that the plant produced in fiscal 1968, about 90% were exported.

To meet burgeoning demand for color TVs, a large-scale dedicated plant (the Tochigi Plant) was built in Kibata, (now Hayakawa-cho), Yaita City, Tochigi Prefecture. Completed in March 1968, it began production in April of that year.

Thanks to the new plants in Hiroshima and Tochigi, the company's net sales went from approximately 42.08 billion yen in fiscal 1966 to 88.37 billion yen in fiscal 1968, while the number of employees jumped from about 8,200 to 13,900 over the same period.

As part of Hayakawa Electric's move to build dedicated plants, it renovated Hirano Plant No. 1 for the production of stereo systems, tape recorders, and other audio equipment. With completion of the first phase of renovation in June 1967, the plant took over the stereo division from the Tanabe Plant (Head Office). Full-scale operation began in November, following completion of the second phase of renovation.



Washing machine line at the Yao Plant (1959)



Parts line at the Nara Plant (1960)



The Hiroshima Plant, a dedicated radio factory (1967)



This long conveyor allowed the Tochigi Plant to turn out high-quality products extremely efficiently (1968)

2 Development of the Calculator

Young Engineers Drive the Company

Starting in late 1958, a group of young engineers would often get together after work to discuss business hurdles and their future dreams for the company. Not satisfied with current television technologies, they wanted to use their newfound knowledge and youthful sensibilities to advance the electronics industry.

One day about six months later, they had a chance to run their ideas past Senior Executive Director Saeki. They told him that the future lay in fields such as semiconductors, computers, microwaves, and ultrasound, and they suggested that the company focus its research there. It turned out that Saeki had himself long believed that the company would not grow if all it did was assemble products.

In September 1960, about 20 engineers in their mid-twenties were gathered as the founding staff of a research department dedicated to areas such as semiconductors and circuits. But despite the hopes and passion of these employees, the fact was that the company was sorely lacking in these technologies. Needing to learn the basics of computers, the calculator group from the circuit research lab spent their days at the offices of Hiroshi Ozaki (later to be an honorary advisor to the company) and Zen'ichi Kitamura of the School of Engineering at Osaka University.

This led to the company's development in July 1962 of the HAYAC-1, a small-scale electronic test computer. Two months later the company commercialized the CTS-1, a voucher printer utilizing a relay calculator.



Young engineers get together after work to discuss their concerns and hopes



The CS-10A, the world's first all-transistor diode electronic desktop calculator

World First: All-Transistor Diode Desktop Calculator

■ Long Struggle to Development Success

At the time, Japan's Ministry of International Trade and Industry (the forerunner of today's Ministry of Economy, Trade and Industry) had already begun a mainframe computer project with several Japanese electronics companies. Hayakawa Electric was not able to take part in this project. At any rate, mainframe computers did not fit the company's style of business: there was a limited market for the products, and they required the development of dedicated software. Hayakawa Electric instead used its strength in mass-produced products to focus on three areas: voucher printers, cash registers, and calculators. In calculators, the aim was to get users to switch to electronic models from the electric products mainly in use at the time. The company set to work developing a full-keyboard, 20-digit display desktop transistor calculator that would be quiet and fast yet would be about the same weight (approximately 20 kg) and price (approximately 500,000 yen) as electric models.

The first prototype failed to meet initial targets; its circuits took up a small room of approximately 7.4 m², and its market price would be more than 1.5 million yen.

To bring down the price, engineers adopted a mechanism that would hold the pressed number keys in the down position and use this as memory; this would reduce the number of transistors required. They also used inexpensive germanium transistors like those found in radios. To ensure stable quality, they used parts that had been subjected to high-temperature aging—a conditioning process that enabled parts to withstand wear and tear.

In March 1964, the company introduced the CS-10A Compet, the world's first all-transistor diode desktop calculator. It weighed 25 kg and sold for 535,000 yen—about the same price as a passenger car.

■ Second Calculator a Hit—The CS-20A

The price had to be reduced somehow. But by subjecting the transistors to aging and other stringent selection methods, there was a limit to what could be accomplished with mass production. Hayakawa Electric decided to adopt silicon transistors, and in 1965 it came out with the CS-20A, a numerical keypad calculator. It weighed 16 kg and sold for 379,000 yen.

Senior Executive Director Saeki was delighted with this calculator and for the next challenge he instructed his development team to make a calculator—an electronic abacus—that could be easily used in grocery stores. This goal became the roadmap for the increasingly smaller and more affordable calculators of the future.

The CS-20A was the center of attention at the 31st Business Show in Osaka in October 1965. In 1966, Sharp Electronics Corporation (SEC)—Hayakawa Electric's US sales subsidiary—began selling the CS-20A. The company was to achieve synergy through superior products and aggressive marketing so as to raise the Sharp brand image across the country.



President Hayakawa with the CS-20A

Calculators Use ICs, Then LSIs

The company strove to develop an “electronic abacus”—a personal-use calculator that was cheaper, lighter, and smaller. To make this dream a reality, the company decided to conduct joint research with a semiconductor manufacturer to develop ICs (integrated circuits), which were making dramatic progress in response to rapidly growing demand in the aerospace and arms industries in the US.

In 1966, the company developed the CS-31A, the world's first calculator to use bipolar ICs (28 ICs). The CS-31A was released and sold well. Eventually more than 70% of bipolar ICs produced would be used for calculators, and calculators were to be a major driver of Japan's semiconductor industry.

The quest for small, light calculators then began to focus on MOS (metal oxide semiconductor) ICs, which

had higher density and consumed less power than previous ICs. But there was still no mass-production technology for MOS ICs and quality was still inconsistent. Furthermore, MOS ICs were easily broken due to static electricity, and they were difficult to assemble. Elaborate measures were taken to solve these problems: to prevent static electricity, humidity levels were raised in the factory, and line workers wore conductive wires on their wrists to ground themselves.

In 1968, after overcoming numerous hurdles, the company released the CS-16A, a calculator employing MOS ICs. Compared to the CS-10A, this product cost less than half (230,000 yen), weighed just one-sixth (4 kg), and was just one-third as large. The CS-16A sold well, and the company was one step closer to an electronic abacus—a true personal-use calculator.

The next semiconductor technology to emerge was the LSI (large-scale integrated circuit), which boasted far greater density and made possible much smaller products. But Japanese semiconductor companies were experiencing low yield ratios and so were unable to supply MOS LSIs for calculators.

The company thus turned to North American Rockwell Corporation for MOS LSIs, leading to the release in March 1969 of the QT-8D Micro Compet calculator. Small and light enough to fit in the palm of one's hand, the QT-8D was called “electronics technology born of the Apollo” in reference to North American Rockwell's participation in the American moon mission project.

The integrated circuits and LCD technologies that came out of the development of calculators formed the foundation of digital appliances and drove advancement of the future electronics industry.



The QT-8D, the world's first LSI calculator (left) and its substrate fitted with MOS LSI

3 Seeds of the Semiconductor Technology

Establishing the Central Research Laboratories

Hirano Plant No. 2 was completed in 1957, and Hayakawa Electric expanded from radios and TVs into electrical appliances. This prompted the company to boost its research capabilities by starting an R&D laboratory. In 1960, the R&D system was upgraded with the addition of labs for semiconductor and circuit research, leading to the establishment of the Electronic Device Research Division in 1961. This marked the company's foray into new electronics fields. (See page 4-03.)

In November 1961, the company completed construction of its long-awaited five-story reinforced-concrete Central Research Laboratories.

President Hayakawa described the role of the new facility. "Industry is moving towards electronics, a technology for the 21st century, and competition in our industry will focus on this new area. The Central Research Laboratories represent our strategy for coming out ahead of other companies."

In August 1963, the Central Research Laboratories were organized into divisions for semiconductors, electronic devices, medical electronics, and machining technology. The facility fostered next-generation technologies including light-emitting diodes, solar cells, computers, and microwave ovens, making it truly the fountain of Sharp technologies.

Research began on medical electronics equipment in 1960. Engineers specializing in medical equipment were invited to the company, and development was carried out in collaboration with medical institutions and trading companies. Developments included electric scalpels, electrocardiographs, and continuous intra-arterial

infusion pumps. The ultrasonic washer developed in 1962 was at first used for washing medical instruments but was expanded for use with semiconductor elements, optical components, and gems and precious metals.

Development of Solar Cells

Start of Solar Cell Research

The company acquired a 2.5 cm-diameter silicon wafer—a thin slab of monocrystalline silicon—which it used to trial solar cells in 1959. This was the beginning of the company's semiconductor business. First developed in 1954 in Bell Laboratories of the US, solar cells are elements that convert the sun's light energy directly into electricity.

In 1959, President Hayakawa, upon hearing of his company's successful solar cell trial, went to the laboratory himself and urged further research. The conversion efficiency (i.e., the percentage of light energy converted to electrical energy) at that time was still just 4% to 5%—still a long way from what was hoped for.

As the conversion efficiency rose above 10%, the company began searching for potential applications in places that could not easily obtain electricity, such as at sea and in the mountains. Light buoys and other marine applications had to withstand the rigors of seawater and harsh weather. In 1962, the company developed a tough yet highly transparent acrylic resin package for the S-224, the company's first standardized solar module. After being tested for a year at sea, it was adopted by the Japan Coast Guard.

Mass production of this standardized model began in 1963, and the following year a mass production line was built in the Nara Plant. The product went on to be installed in many marine applications, most notably in 1966 on the Ogami Island Lighthouse in Nagasaki Prefecture, Japan. This 225 W solar module was at the time the world's largest.

President Hayakawa had long said, "If we could find a way of generating electricity from limitless solar heat and light, that would benefit humankind to an extent we can scarcely imagine." The company had made a start in this direction by contributing to making marine traffic safer.



The Ogami Island Lighthouse is powered by Sharp solar (photo courtesy of Japan Coast Guard)

The Rise of Optoelectronics

The company also began developing optoelectronics products, which use solar cells as the optical sensors.

In 1970, the company developed products including a silicon blue cell for cameras and an optical sensor for ray guns used in game consoles.

Developing ELs, Laser Diodes, and LEDs

Light-Emitting EL Panels

Hayakawa Electric began development of EL (electroluminescence) in 1960. EL is known as "a light-emitting wall" since it gives off luminescence when an alternating current is applied to it. (At that time, EL was made of inorganic material, not organic material.)

In 1962, EL was in use for green indicators such as emergency exit signs in hotels and department stores, but it was still lacking in terms of brightness, stability, and service life. The company thus decided to first work on developing monocrystalline LEDs (light-emitting diodes) and laser diodes instead of polycrystalline EL.

Oscillation of Laser Diode Achieved

It was said that oscillation of laser diodes could be achieved by polishing the edge of the crystals of an infrared-emitting diode. As a first step toward this, the company began developing an infrared-emitting diode using gallium arsenide (GaAs) semiconductors. In 1966, infrared light was obtained by using an in-house electric furnace to make a basic monocrystalline material. That same year, the company began sample sales of infrared-emitting diodes that were used as the tape readers for electronic calculators.

Research continued as the company achieved laser oscillation in liquid nitrogen. In 1968, this laser diode element was mounted on a rocket that went into outer space to observe cosmic dust.

Mass Production of Infrared Devices

The company raised the light-emitting efficiency of LEDs through a proprietary method called LPE (liquid phase epitaxial). In this method, p-n junctions* were built in unison with crystal growth. The acquisition of a patent for this technology allowed the company to leap far ahead of its rivals in the field of light-emitting elements.

In 1968, the company released products such as the GLE-502 gallium arsenide infrared-emitting diode, which achieved 20 to 50 times greater light emitting strength.

In 1970, the company released a gallium arsenide double LED that created visible green light by using a special fluorescent substance for a portion of the infrared light. This made it possible to see the movement of infrared light, which is normally invisible to the naked eye. The method of using a special fluorescent substance to convert the wavelength (color) of light was a precursor to the structure of the white LED lamp, a product that has seen rapidly growing use since about 2000.

The GLE-50G gallium arsenide double LED emitted visible green light and near-infrared light simultaneously

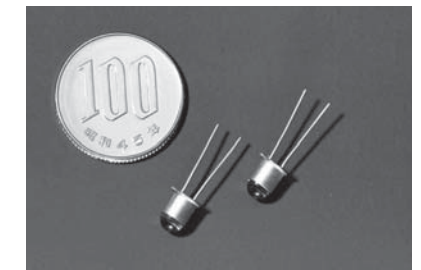

Increasing the Functions and Applications of LED Lamps

In 1972, the company released the GL-50AR gallium arsenide phosphide red LED lamp and the GL-50PR gallium phosphide red LED lamp. Besides giving high brightness with low electric current, these LED lamps emitted light from the entire crystal chip and could thus be used in applications such as number display elements.

The company also worked to expand applications. It developed unique applications such as large-size number displays and bar graphs. Usage of LED lamps grew to include consumer electronics applications such as the indicators for audio-visual equipment.

Thus began a virtuous circle whereby improved functions and performance created a wider range of product applications for the devices and resulted in lower prices due to economies of scale, in turn making the devices affordable for even more applications. In 1975, the company's LED lamp business in Japan enjoyed a more-than-30% share of this growing field, even reaching over 40% in certain months.

* A p-n junction is a junction formed at the boundary between a p-type and an n-type semiconductor.



Conducting R&D at the Central Research Laboratories

4 Supporting the Home Appliance Boom



The R-10 microwave oven in use at a department store in Osaka

■ First Microwave Oven in Japan with Turntable

In 1966, the company released the R-600, the first microwave oven in Japan with a turntable. It was priced below 200,000 yen for the household-use market and was compatible with standard household power sources. The turntable rotated food for even cooking, and a window allowed users to monitor their food.

In September 1967, the R-1000 commercial-use microwave oven was released. This product achieved high efficiency with improved stabilizing circuits for the magnetron's power source. It also incorporated a bicycle bell that emitted a "ding!" sound to alert users that cooking was finished. Eventually all microwave ovens used the same kind of bell, and people in Japan were soon referring to microwave ovens as "the ding!"



The R-600, Japan's first turntable-type microwave oven

Mass Production of Japan's First Microwave Oven

■ Development of Microwave Oven, Dissemination to Households

In 1960, the company began R&D in the promising field of microwave ovens. This product used powerful, ultra-high-frequency (2.45 GHz) radio waves emitted by a magnetron—a type of vacuum tube—to cook food from the inside out.

In April 1961, a 2 kW prototype displayed at the 4th International Trade Fair in Tokyo garnered an enthusiastic response. The following April, the company released the R-10, a 1 kW model that was Japan's first mass-produced microwave oven. Priced at 540,000 yen, it was ordered by restaurants and other commercial establishments.

Because the first microwave ovens were rather expensive, the company sold them by taking them to restaurants so potential customers could see how they were used and taste the food they cooked. Product developers were involved in the process of making them easier to use and improving the technology.

At the bakery at Korakuen Stadium in Tokyo, customers enjoyed pre-baked pancakes that were warmed up in the shop's microwave oven. In 1967, Kintetsu Corporation purchased a microwave oven for the buffet car on its Osaka-Nagoya limited express train.

Growing Lineup of Appliances

Seeking to expand its lineup of appliances, the company established a laboratory for basic research in 1961. Located in the Yao Plant—now the Advanced Technology Development Center of the Health and Environment Systems Group—it successfully developed a wide range of appliances, including refrigerators, washing machines, and air conditioners. To give one example, the laboratory's array of measuring devices enabled engineers to advance from water-cooled air conditioners to compressor-type products.

From the late 1950s to the 1960s, the company came out with many appliances with proprietary functions that were clever and original.

Memorable hit products included the KF-650 fish roaster, which used an electric heater installed under the top cover to cook fish without creating smoke. Also popular was a refrigerator that used a new type of insulation to halve the thickness of the walls. This refrigerator also incorporated a fan cooling system that eliminated the need to defrost the freezer compartment.

Start of Color TV Sales

■ Ushering in the Color TV Age

A number of companies began releasing color TVs on July 1, 1960, in time for Japan's first color broadcasts that September. While many companies were having trouble achieving decent picture quality, Hayakawa Electric's first color TV, the 21-inch CV-2101, showed the public consistently high-quality images at an industry trade show prior to market release.

Color TVs, however, took some time to proliferate. They were initially priced at about 500,000 yen—this, at a time when the average starting salary for government workers with a high school education was 7,400 yen a month. Moreover, there was still only about an hour of color broadcasting each day.

In the US, the early 1960s saw a boom in color TVs that boosted exports from Japan. The country's production went from about 5,000 TV sets in 1962 to 1.28 million in 1967, and this economy of scale brought prices down.

The 1964 Summer Olympics in Tokyo provided the impetus for more color broadcasts; by January 1965, NHK was showing about 11 hours of color programming each day. Thanks partly to falling prices, Japan eventually enjoyed a color TV boom of its own. In 1966, TVs accounted for 43% of the company's sales. In 1968, production began at the company's Tochigi Plant, which had a dedicated color TV line. The company produced about 300,000 TV sets that year and about 400,000 the following year.

At that time, color TVs required special picture adjustment upon installation. The company thus developed a test signal consisting of two on-screen red lines, for the purpose of adjusting the hues. This feature first appeared on the 19C-D3N, released in 1969. The 19CU-810, which was released the following year, automatically adjusted 12 picture parameters—including color, image quality, brightness, and contrast—and earned accolades from consumers.

■ Release of the Transistor Radio

In January 1957, the company released the TR-115 transistor radio. Due to the boom in pocket transistor radios in the US, the company received a huge order of 15,000 units in October 1957. Export radios now played a vital role in the company's business.

By 1964, transistor radio production in Japan had overtaken that of vacuum-tube radios. And by 1967, the number of transistor radios produced in Japan had grown to approximately nine times the 1964 level.



The CV-2101, the company's first color TV

Wedding of the Crown Prince and Princess

On April 10, 1959, Japan's Crown Prince Akihito married Michiko Shoda. Sales of TV sets boomed prior to the wedding at the prospect of being able to see a live broadcast of the ceremony and parade.

The day of the wedding was declared a national holiday. More than 500,000 people packed the parade route, and an estimated 15 million watched the event live on television.

The imperial wedding didn't just bring TVs into the public consciousness; it opened the door to a new consumer electronics boom.



Crown Prince Akihito and Crown Princess Michiko on their wedding day (photo courtesy of Yomiuri Shimbun newspaper)

5 Towards an Invigorating, Fulfilling Corporation

The MI Campaign

■ The Company's 50th and 55th Anniversaries

With sales flat, the company embarked on initiatives to create momentum that would propel it into the next phase of growth. In 1961, the company celebrated its 50th year in business with a sale that included the chance to win a house.



Sign for the company's 50th anniversary sale. The company was offering a total of 50 million yen in prizes, which included a house and a luxury car (April 1–September 30, 1961)

The company celebrated its 50th anniversary in 1962 with a publication in September highlighting 50 years of great product ideas from Hayakawa Electric.

To celebrate the company's 55th anniversary, in 1967 the company held Sharp technology fairs at department stores in Japan's major cities. Featuring products incorporating the company's then-current technologies, as well as technologies designed for homes of the future, the fairs drew countless visitors and boosted the brand image.



Visitors hear an explanation of a scale model of the company's traffic information system at a Sharp technology fair

■ Boosting In-House Morale and the Sharp Image

In January 1969, the company began its MI (Morale Image) campaign. An independent public opinion survey showed that people had a lower image of the company than it had hoped for. To counter this, the company strove to create an image of itself as a sincere first-class business possessing superior technology. The company conducted a multi-faceted information campaign to boost in-house morale while also raising its public image.

One of these measures was the weekly distribution of the MI Card to all employees. The cards summarized a range of corporate information from Hayakawa Electric in Japan and around the world relating to products, technologies, management, personnel, and history.

Other measures that helped make the campaign a success included corporate public relations, new corporate colors, redesigned uniforms, and a revised corporate charter.



MI Cards (1969–1970) provided employees with information using colorful photos and simple, casual writing

Towards Modern Quality Control

■ Improving QC Activities

In 1949, a number of the company's employees attended training sessions given by Eizaburo Nishibori, a pioneer in the field of statistical quality control in Japan. This prompted the company to adopt scientific quality control. Quality control (or QC) was immediately incorporated into the speaker factory, a quality control manager was appointed in the company's production division in September 1951, and a quality control division was launched in 1952. In 1955, Sharp audio speakers were certified for JIS (Japanese Industrial Standards). Taking this as an opportunity, the company formulated the company-wide HS (Hayakawa Standards), the purpose of which was to standardize in-house processes. In 1959, quality control departments were established in all company factories.

In the 1960s, the accepted wisdom regarding quality control was that inspections alone didn't guarantee quality; rather, quality resulted from the production process. Based on a redefined set of standards, work at the company's facilities was conducted with thorough attention to precision. As a result of these efforts, in 1963, the Yao Plant became a JIS-certified factory. It went on to win a series of prizes, including the Osaka Trade and Industry Bureau Director's Award, the Agency of Industrial Science and Technology President's Award, and the Minister of International Trade and Industry Award.

When the company developed the world's first all-transistor diode calculator in 1964, it had to ensure the reliability of the design owing to the product's large number of parts. The quality control measures conducted to ensure such design reliability were to be employed by the company in subsequent products.

■ Start of Small-Group Activities

In the mid-1960s, small-group activities* began to be incorporated into quality control. In the company's wireless products division, ZD (Zero Defect) activities were begun in June 1966 in the form of the 00 (zero zero) Strategy. The goal was to boost reliability and lower costs to ensure zero work errors and zero defects in the production of color TVs for the US market.

Under the GB (Greater Balance) Strategy put in place by the appliance division in August 1966, QC circles were the basis for employees to set concrete individual targets that they would work towards achieving.

The company had gotten an early start by incorporating quality control activities from 1949 onwards. Consequently, it succeeded in using small-group activities in the workplace to make QC an integral part of the corporate culture in the 1960s.

President Hayakawa's Social Contributions

In 1952, President Hayakawa went to the US for negotiations on a TV business tie-up. There, he visited social welfare facilities, including institutions for the disabled, and saw how advanced the country was in providing for the disadvantaged. He also saw how women had become fully integrated into the American workforce. Soon after arriving back in Japan, he initiated construction of a nursery school near the head office. This opened in 1954 as the Ikutoku-en nursery school.

President Hayakawa remembered his own difficult times as a child, and he wanted to build a place where children of single-parent families or double-income families could be happy while their parents were away at work. In 1976, the facility was rebuilt as a three-storey steel-frame building that also had a mother-child exercise room and a gallery for selling artwork produced by the disabled.



President Hayakawa affectionately watches over the youngsters at Ikutoku-en (1954)

In September 1962, President Hayakawa donated his own money for the construction of the Osaka Municipal Hayakawa Welfare Hall. He wanted to do his part to brighten the lives of the disabled and the elderly by giving them a place to relax and enjoy themselves.

In November 1969, the Osaka Municipal Abeno Youth Center (now the Momogaik Park Citizens Center) was completed. President Hayakawa donated construction funds with the conviction that young people needed cultural facilities to exercise their minds and bodies.

These social contribution activities were carried out with President Hayakawa's own money and with other funds gathered in a box in his office called the "Happiness Box." The money earned from his public speeches and writings went into this box and was then used for social welfare activities and employee charities. Eventually, company executives and others sympathetic to his causes began putting money in this box.

President Hayakawa's many social contribution efforts were widely lauded. In 1960, he received the Medal with Blue Ribbon from the Japanese government for his work in social welfare and in promoting employment for the physically disabled. And in 1965, he received the Japanese Order of the Sacred Treasure, Gold Rays with Neck Ribbon for many years of success in business and social welfare.

* Activities conducted by a small number of people who focus on finding ways to improve the quality and efficiency of the work they do.

6 Leveraging the Domestic Appliance Marketing Network

Establishing Sales Companies and Dealers

To maintain its marketing network and expand as a well-balanced comprehensive consumer electronics manufacturer, the company began expanding its product lineup in June 1960 by getting a foothold in categories beyond TVs and radios.

In December 1960, it unified its sales organization by setting up the Marketing Group, which allowed it to more quickly respond to rapid changes in market demand. As well, it adopted a consistent strategy in which nine sales divisions would each be in charge of one of nine regions of Japan.

Besides appliances, the company established a sales division for specialized equipment within the Marketing Group. The goal was to develop and sell products such as microwave ovens, medical equipment, solar cells, and EL displays.

Also at this time, the company began establishing new sales branches to strengthen its marketing network with dedicated Sharp dealers (i.e., wholesalers). To further strengthen its marketing abilities, it established regional sales companies—starting in Kyoto and Kobe—that combined the functions of dealers and dedicated regional sales branches. This gave the company fixed distribution routes from head office to sales outlets and thus enabled a more clear-cut marketing network.

In 1967, the company had 54 regional sales companies, 11 installment sales companies, and three after-sales service companies. In October of that year, Sharp Electric, which had until then been an independent sales company for the manufacturer (Hayakawa Electric), was absorbed along with the regional companies into Hayakawa Electric to form a single joint entity.

In December 1967, the company became the first major Japanese electronics manufacturer to set up in Okinawa—which was then still under US administration—by establishing Sharp Electronics Sales Okinawa Corporation as a domestic regional sales company. The company thus boosted its marketing network by staying ahead of its rivals in establishing sales bases. Sharp Electronics Sales Okinawa gave the company a vastly larger market share in this southern region.

In March 1968, specialized equipment-installation companies were established in Osaka, Tokyo, and Nagoya. Since sales outlets could not carry out installation of products such

as air conditioners, these new companies were dedicated to delivering and installing Sharp products for customers.

Start of the 70 Strategy and ATOM Units

■ 70 Strategy

While the company had established regional sales companies, its next step was to boost its network of outlets to ensure steady sales progress. In 1965, a five-year plan was formulated to have company-affiliated sales outlets account for 70% of total company sales. This plan was dubbed the “70 Strategy” since it was to be achieved by fiscal 1970.

Strategies were planned and support activities were conducted in line with the needs of individual stores. New sales routes for products such as office equipment and housing equipment were established, as were new stores.

In establishing new stores, the company allowed owners of existing sales outlets and company employees to apply to be the owners or managers of these new stores. The company would give these budding store managers its full support and those stores would open as Appliance Centers. In June 1967, the company opened the Minami Osaka Sharp Appliance Center as a partner store to Sharp Friend Shops. More Appliance Centers were opened around the country to help strengthen the company’s marketing network.

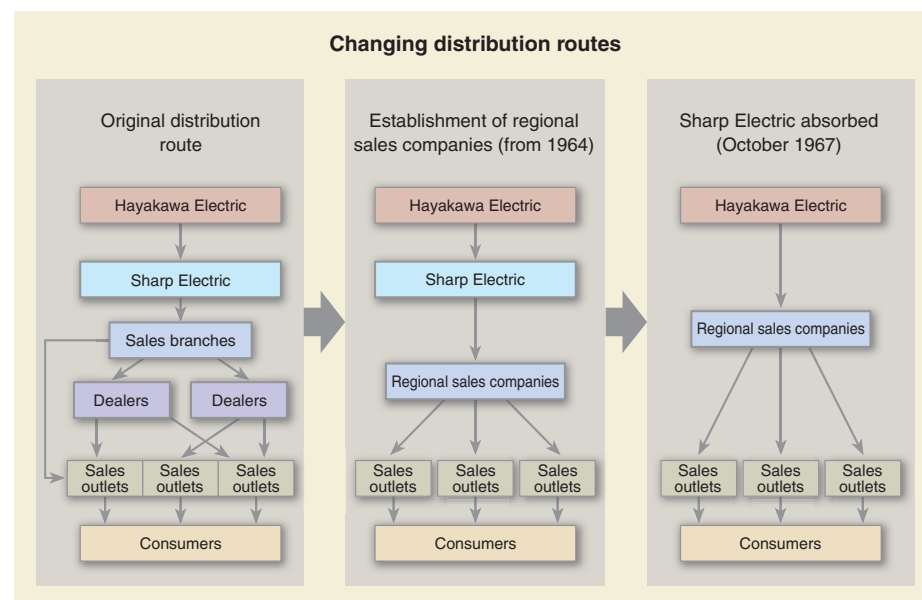

The company stressed business cooperation in order to boost the sales capabilities of its sales outlets. The goal was to achieve efficient marketing and a strong business foundation by having small-scale outlets work with each other. One effort towards this end was the 1967 launch of nationwide Accounting Centers, which supported the outlets in matters of accounting, taxes, and sales plans. Next was the 1968 nationwide establishment of Business Cooperation Centers. Areas in which these centers provided support included personnel hiring (cooperative hiring, for example), sales promotion (joint sales exhibits), and a customer membership program (the Friend system).

In March 1971, company-affiliated sales outlets accounted for more than 70% of overall company sales.

Originally, products made at each company plant were shipped by that plant to regional sales companies. But to consolidate and streamline transportation, the Sharp Tokyo Product Center was established in 1964 and the Sharp Osaka Product Center in 1969.



The Product Center in Fujiidera City, Osaka Prefecture

■ Start of ATOM Units

The Tokyo Olympics of 1964 were followed by an economic slump in 1965, when the company was saddled with approximately 10 months of inventory for TVs and had to temporarily stop production. To help alleviate this problem, a system of dedicated traveling sales promoters was established to support sales outlets. Called ATOM (“Attack Team of Market”), the teams consisted of employees from the manufacturing and engineering divisions who knew little about sales. It was thought that employees who had no firsthand experience of the time when sales were booming would have no preconceptions about selling, and that they would therefore stick to the basics of sales and marketing when working on the front lines of retail.

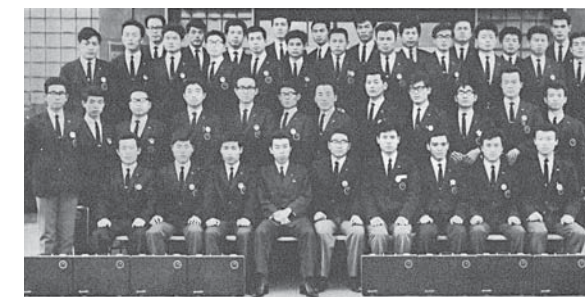

The very first ATOM team in front of the head office

In August 1965, 47 employees were chosen from among the applicants to form the first ATOM team. Their duties included going to sales outlets, examining TV picture quality (called “TV health check-ups”), visiting customers, tapping potential markets, and creating a new customer base.

Before long, the diligence of the ATOM team was having an effect on consumers and helping boost sales, as well as earning the trust of sales outlets. Team members were also earning accolades within the company, and by April 1966 there were a total of about 100 ATOM members.

ATOM members gradually began playing more important roles. While the period from the start of the program until 1966 was spent building up customers for sales outlets, by around 1967 ATOM had entered a period of establishing new sales outlets. When the Business Cooperation Center system was launched in 1968, ATOM teams were instrumental in training staff, as the company stressed the importance of establishing outlets and training staff.

Because the ATOM system was started with employees who had no previous sales experience, group training sessions to improve job skills were begun a year later. These group training sessions evolved to become a training program for the staff of sales outlets.

■ Microwave Oven Sales Promotion

Microwave ovens were a product that most consumers knew almost nothing about, so it was the sales division’s job to somehow show the public the benefits of this new product. In 1967, when home-use microwave ovens were just starting to catch on, the company sent out its microwave oven cooking instructors to get the job done. These female employees had been working since 1965 to create dishes suitable for microwave cooking, and they now began expanding their activities in earnest.



A company instructor teaches participants about microwave oven cooking

Leading party-style demonstration events, the instructors allowed participants to see and experience microwave ovens, and to taste what these devices could do. This convinced the public of the products’ benefits and led to increasing sales.

7 Sales Company Established in the US

Export Group Established, Exports Expanded

In the post-WWII period, the company renewed its export business mainly through radio parts, although the volume was still low. Exports later skyrocketed in 1957 with the sale of transistor radios. The 10 employees who made up the export division at that time had their hands full negotiating with customers, issuing letters of credit, and filling out export paperwork. Still, they were proud and excited to be supporting the company's export business. The main export products at the time were transistor radios for the US and vacuum-tube radios for Asian markets. The US accounted for the largest share of Hayakawa Electric's exports, at about 40%, followed by regions such as South America.

Starting in about 1958, there was huge jump in Japanese transistor radio exports to the US. To avoid a backlash from the US, under guidelines from Japan's Ministry of International Trade and Industry, companies initiated systems to restrict export prices, inspect exported products, and limit the number of products that could be exported. The Japanese radio industry was in a fierce battle with American manufacturers, so in order to avoid getting caught in a simple price war, Hayakawa Electric distinguished its lineup by including high-end models. This helped boost export sales.

In Asia, the company expanded its marketing network by signing dealer agreements in 1959 with companies including Roxy Electric Company Limited* in Hong Kong and Sampo Electronics Company in Taiwan.

In June 1963, the company looked to further expand exports by reorganizing its export division into the Export Group, with a total of 100 employees. Exports continued to grow, reaching about 20% of overall company sales.

Around this time, Japan was beginning to have trouble exporting to developing countries in Southeast Asia and South America. These fledgling economies wanted to protect their own industries by imposing high import tariffs and restricting the import of finished products. Hayakawa Electric countered this by signing T/A (technical collaboration agreements) with dealer companies in these countries, which enabled the company to manufacture black-and-white TVs and refrigerators locally.

The first such T/A agreement was with Taiwan's Sampo in 1966. This was followed by two agreements with Roxy—one for Singapore in 1966 and one for Malaysia in 1968—to start production in these countries.

A T/A was a mutually beneficial relationship that furthered industrial development by giving Hayakawa Electric royalties and the local partner company expertise in the latest technologies and plant management.

First Overseas Sales Subsidiary Established in the US

■ Sales Subsidiary Promotes Sharp Brand

Originally in the US, Hayakawa Electric made products at the request of appliance manufacturers, wholesalers, and department stores, which were then sold under the brand names of these customers. This meant that the company, through its commercial customers, could learn about the tastes of US consumers and about US quality standards. There were disadvantages, however: not only was the company unable to gain brand recognition; it could not build up marketing know-how or provide sufficient after-sales service. It decided that it must overcome these problems and boost exports by establishing its own sales company in the US.

In May 1962, the company's first overseas sales subsidiary, Sharp Electronics Corporation (SEC), was established in the heart of Manhattan. A wholly owned subsidiary capitalized at US\$150,000 (5.4 million yen), it had 14 employees, including five from Japan.

SEC began its business selling mainly transistor radios and portable black-and-white TVs, but sales of US\$2.74 million (986 million yen) in its first fiscal term (October 1962 to July 1963) were less than half of the target. When a quality problem occurred with some of the company's TVs, it responded by introducing a stricter quality control system and beefing up after-sales service. But the company faced a tough battle, due to factors including lack of brand power and a lack of familiarity with US business practices.



In 1962, SEC had its head office at the Rockefeller Center in New York City

Three years after its establishment, SEC moved across the Hudson River to New Jersey. This gave it a large enough area to house offices, a warehouse, and a repair and inspection space, and also enabled it to integrate its marketing and service functions.

■ Calculators and Other New Products Propel the Company

In 1966, SEC added the CS-20A calculator to its lineup, but it needed an office products sales route through which to market the product. SEC's marketing managers leafed through American city phone books looking for major office equipment dealers to carry the CS-20A. They visited dealers and other potential customers in the daytime and held "tempura parties" for them at night. These were a hit with the Americans at a time when Japanese food was still a rarity, and Sharp calculators were able to make a strong impression. This was the dawning of the calculator age, and the company's dogged determination led to the Sharp name becoming a familiar part of the US office equipment landscape.

The calculator helped SEC dramatically boost its performance. Sales in the company's fifth fiscal period (August 1966 to July 1967) were approximately US\$7.12 million (2.56 billion yen), and SEC's ranks had swelled to 24 employees from Japan and three-dozen local staff.

SEC's expanding business helped raise exports to 38% of the company's worldwide sales by fiscal 1968. And SEC's momentum provided a boost to sales in Europe.

Sales Subsidiaries Established in Europe

In 1968, Hayakawa Electric (Europe) GmbH (HEEG) was established in Hamburg, West Germany (now Germany). Capitalized at DM 400,000 (3.6 million yen), the company had seven employees, including one hired locally. Hayakawa Electric had originally opened a branch in West Germany in 1959, but sales through dealers to European markets did not reach expectations.

In November 1969, Sharp Electronics (U.K.) Ltd. (SUK) was established in Manchester, UK. With 21 employees, including four from Japan, the company had a capitalization of GBP 80,000 (69.1 million yen). SUK was established to take over the business of a bankrupt dealer who had been selling Sharp products. Because there was a period between this bankruptcy and the establishment of SUK, customers in the UK had trouble getting after-sales service for some time. SUK was able to expand its marketing network and gain a firmer footing in the country through a system of registration for retailers that regained the customer trust it had lost.



1968: The company's first sales base in Europe. The name was changed to Sharp Electronics (Europe) GmbH (SEEG) in 1970 (This photo was taken around 1971)

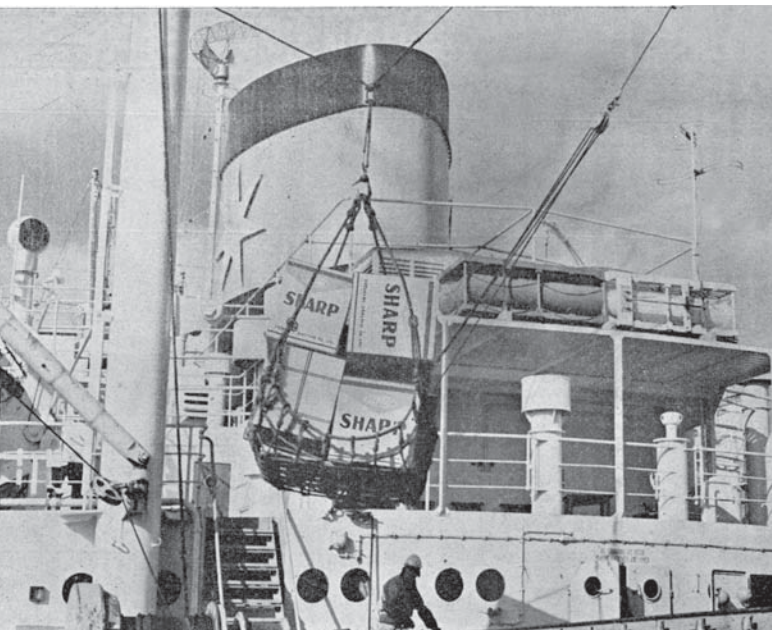

Large numbers of Sharp products were exported to countries around the world (around 1960)

* Roxy Electric Company Limited was a Sharp dealer based in Hong Kong. Sharp entered joint ventures with Roxy in order to establish sales and production companies in Singapore, Malaysia, and Hong Kong.

Toward a Comprehensive Electronics Company Advanced Development and Planning Center Built in Tenri

In 1970, the company changed its name from Hayakawa Electric Co., Ltd. to Sharp Corporation. Founding President Tokuji Hayakawa was appointed to the position of chairman and Senior Executive Director Akira Saeki became the new president of Sharp Corporation. With this new corporate structure, Sharp accelerated its business development in the electronics field.

Sharp made a bold decision to pass up the opportunity to exhibit at Expo '70 in Senri, Osaka. Rather than investing in a temporary pavilion, the company used the equivalent funds to build the Advanced Development and Planning Center, while also increasing its investments in manufacturing LSI chips, researching cutting-edge technologies, and strengthening employee training. Mass production of LED products began, and liquid crystal technology was developed around this time.

The Advanced Development and Planning Center, soon after opening (Tenri City, Nara Prefecture)

1 Company Name Change and Adopting a New Corporate Structure

Company Name Changed to Sharp Corporation

On January 1, 1970, the company changed its name from Hayakawa Electric Co., Ltd. to Sharp Corporation.

Just as the 1970s were about to dawn, President Hayakawa proposed the name change based on his hope for renewed growth in the company. The change was approved at the general shareholders meeting on November 28, 1969. The brand name Sharp—originally derived from the Sharp Pencil that President Hayakawa invented—had already been used on all the company's products from the radio onwards and had become familiar to the public.

There were two reasons behind the name change. First, the president wanted the name to fit the image of a company that was actively engaged in new fields in electronics, such as semiconductors. Second, he wanted to unify the company name and the brand name to strengthen the corporate image and improve the company's position in domestic and international markets.

With exports surpassing 40% of total sales—41.3% in the first half of fiscal 1969—the Sharp brand name was widely recognized. However, the same could not be said for the manufacturer's name, Hayakawa Electric. The company therefore decided to unify the corporate name and brand name, with a view to making a huge leap

forward as an international company. The change of the company name marked the beginning of a new era, as the company was striving to become a comprehensive electronics manufacturer that could compete on the world stage.



Replacing the outdoor signage of the head office reflecting the company's name change

President Saeki Appointed

Fair and Impartial Human Resource Management, Transparent and Accurate Accounting

On September 15, 1970, President Hayakawa became chairman, while Senior Executive Director Akira Saeki became the new president.

In the 1960s, the consumer electronics industry experienced rapid growth in Japan, spurred by a period of high economic growth. Sharp was growing well. At the same time, intensifying competition among consumer electronics manufacturers began to affect overseas operations. To make matters worse, the economic cycles in Japan and overseas were approaching a difficult period.

In this climate, President Saeki spoke to employees about the company's approach. "The important thing for a corporation is how it fulfills its social responsibility. The pursuit of profit is an absolute necessity, but that is not the goal of the company. A true company must contribute to society and to the welfare of people. In order to do this, we must always consider our suppliers, our customers, the industry, and the economy as a whole, so that we may establish the right approaches to manufacturing and marketing." He spoke about his own management philosophy as follows, "I will adhere to a fair and open management philosophy, based on fair and impartial human resource management and transparent and accurate accounting. That means we must fairly evaluate the abilities and character of each employee and trust them to perform their work. We must also use funds in a way that people can clearly understand."

President Saeki then made policies to expand business and operations by further developing the consumer electronics field. This would begin with research and development of new products that would be useful for society—following the success of the electronic calculator—and would also involve entering new fields, such as housing equipment and office products.

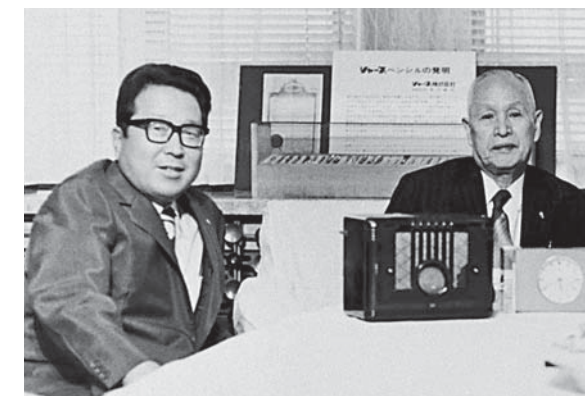

New corporate structure initiated by Chairman Hayakawa (left) and President Saeki

Overcoming Numerous Difficulties

Around 1970, when Sharp started moving forward with its new corporate structure, Japan's consumer electronics industry had various issues to deal with, such as lawsuits filed in the US charging Japanese manufacturers with

dumping TV sets on the US market at artificially low prices. There was also controversy over dual pricing of color TV sets in Japan's domestic market.

Making the situation worse, US President Nixon announced a new economic policy in August 1971 that suspended the convertibility between the US dollar and gold and that also placed a 10% tariff on imported products. The "Nixon Shock" came as a blow to Japanese industry.

Stock prices in Japan plunged temporarily, exports slowed, and the Japanese economy lost its momentum.

Further, in December 1971, the exchange rate was adjusted by 16.88%—from 360 yen to 308 yen per US dollar—under the Smithsonian Agreement, a currency exchange adjustment made by a group of ten advanced nations. Still, the US trade deficit increased, leading eventually to the adoption of a floating exchange rate system.

Starting about a month after the Nixon Shock on September 27, 1971, President Saeki began addressing the issue at Sharp by speaking directly with managers in the head office and by visiting factories around Japan. He also released a message to all employees on October 1, providing guidance to overcome these difficult circumstances.

His response was fast, following the company's swift analysis of the changing economic environment and political climate. Sharp developed and implemented concrete, comprehensive measures for product development, manufacturing, and marketing both in Japan and abroad.



President Nixon's announcement of emergency measures, centering on defending the US dollar, had a serious impact on the global economy (The Nikkei newspaper, August 16, 1971)



A pamphlet entitled *Facing a Period of Great Change in the World Economy* was published to explain measures being taken in response to the Nixon Shock

2 Aiming to Be a Comprehensive Electronics Manufacturer

Establishing Business Philosophy and Business Creed

In January 1973, Sharp carefully reviewed the basic spirit and ideas that had been guiding and nurturing the company since its beginning. The company then spelled out those ideas in its Business Philosophy, Business Creed, and Basic Business Principles.

The Business Philosophy describes ideas in line with what is now called corporate social responsibility (CSR)—ideas that aim to promote the mutual health and growth of society and stakeholders. It mentions contributing “to the culture, benefits and welfare of people throughout the world” and notes that “our future prosperity is directly linked to the prosperity of our customers, dealers and shareholders.”

The Business Creed declared that “Sharp Corporation is dedicated to two principal ideals: Sincerity and Creativity.” (Please refer to the title page.) “Sincerity” meant working in earnest, considering how to please and be useful to the people surrounding us. “Creativity” meant having the ability to open up future possibilities through constant innovation and improvement.

President Saeki thoughtfully placed “Sincerity” as a human being before “Creativity” as a company. He added “Courage” as the last item in the Business Creed, with the idea of incorporating into the company’s DNA the never-give-up spirit of the founder, who made a remarkable recovery after the Great Kanto Earthquake of 1923.

The Basic Business Principles included five key ideas: to develop unique technologies; to create the best products; to remain committed to customer-oriented sales; to build cooperative relationships for mutual prosperity; and to equate the growth of the company with the happiness of everybody.

The company created cards on which the Business Philosophy and Business Creed were printed and distributed them to businesses partners to help them understand the company’s corporate policies. This card



Cards for the Business Philosophy and Business Creed

was later translated into English, Chinese, French, German, and Spanish and distributed to employees and business partners overseas.

For the Annual Employee Award Ceremony, held in June 1972, a new award called the Sharp Grand Award was created to honor the individual or organization with the greatest achievement for the year.

Even now, this annually presented award continues to provide a source of motivation to individual employees. Morale is also raised in the workplace of each award recipient.

Making a Bold Decision, Progress in Manufacturing LSIs In-House

■ Building the Advanced Development and Planning Center

In January 1968, the company decided to cancel its participation in Expo '70, which was to be held in Senri, Osaka. The company considered that it would be more meaningful to allocate limited resources to building a facility that could be used for the long term. In November 1968, the company started construction of the Advanced Development and Planning Center in the hills of Tenri, Nara Prefecture. The term “Advanced Development” was intended to convey the new center’s purpose of advancing development and growth in two areas: the development of new technologies (in the Central Research Laboratories and a semiconductor plant) and the development of human resources (at a training institute for employees).

The construction of a semiconductor plant was prompted by the company’s experience of having difficulty in obtaining metal oxide semiconductor (MOS) large-scale integrated circuits (LSIs) when it was developing the world’s first LSI calculator—the QT-8D, released in 1969. “If we’re depending on other companies for the supply of semiconductors, we won’t be able to take the lead in the development of electronic calculators.” In March 1969, the company reached an agreement for technological cooperation with North American Rockwell Corporation and made an official announcement on the construction of a semiconductor plant.

Construction of the semiconductor plant, the Central Research Laboratories, and the training institute was completed in September 1970. Facilities for employee welfare were also built on the campus. Ever since, the Advanced Development and Planning Center has been serving as a supportive foundation in the development of technology and human resources for Sharp as a comprehensive electronics company.

Including construction and equipment costs, investment in the Advanced Development and Planning Center totaled 7.5 billion yen. It was a bold investment, considering that the operating capital for the company at that time was around 10.5 billion yen.

In August 1969, the company issued European Depository Receipts (EDRs) to raise 4.2 billion yen. 10 million new shares were issued. As a result, the total number of issued shares reached 210 million. The company became the first in Japan to issue EDRs and target Europe as a whole with new shares.



Senior Executive Director Saeki saw a model of the Apollo space capsule at North American Rockwell, a supplier of MOS LSI, and was convinced of the infinite possibilities of semiconductors

■ Starting In-House LSI Production

Initially the semiconductor plant in Tenri was working on only the second half of the manufacturing process. It imported LSI chip wafers from North American Rockwell

and then placed those chips in packages and finished them as LSIs. In 1972, the plant started operation of the first-half processes and became a facility for the integrated manufacture of LSIs.



Employees at the semiconductor plant working with microscopes in the later stages of the production process

Next, the company started producing more energy-efficient complementary metal oxide semiconductor (C-MOS) LSIs, in conjunction with development of a COS*-type calculator—the EL-805 Liquid Crystal Compet (released in 1973). The company harnessed innovative technologies to overcome challenges presented by the increasingly complicated C-MOS production process.

In March 1976, Sharp developed a process for packaging LSIs using the film-carrier method. This method involved placing LSI chips onto film, where circuit patterns were printed and then sealed with resin. LSIs made with this method were easy to process, transport, and store. This contributed to a streamlining of the production process for electronic calculators and also led to a surge in demand for semiconductors. The company began constructing a second plant in December 1976 and established a system capable of producing one million units per month.

* COS stands for Calculator On Substrate, a method of constructing the entire calculator system—including the display, driver, and key access points—on a single panel.

Japan World Expo '70

On March 14, 1970, Japan World Expo '70 opened in Senri Hills (in Suita City, Osaka Prefecture) with the theme of Progress and Harmony for Humankind.

The first World Expo held in Asia, it was a national event that symbolized the economic strength of Japan.

People waited in long lines to see exhibitions in pavilions located on a site covering 3.3 million m². By the time the expo closed on September 13, attendance numbers for the 183 days of the event had topped 64.2 million. Novel items such as a wireless telephone—the forerunner of today’s mobile phones—canned coffee, and Bulgarian-style yogurt made an impact at the expo and subsequently became popular.



Tower of the Sun, the symbol of Expo '70

3 Development of Liquid Crystals and Growth in Office Products

Developing Liquid Crystals and Application in Thin Electronic Calculators

■ Practical Application of LCDs

One technology that helped both to reduce the energy consumption of electronic calculators and provide them with thinner profiles was the LCD. The LC stands for “liquid crystal”—a crystal state between liquid and solid form. Liquid crystals were first discovered in 1888 by Friedrich Reinitzer, an Austrian plant biologist. In 1963, researchers at RCA in the US discovered that the transparency level of liquid crystal changes when it is electrically stimulated. In 1968, George Heilmeyer from RCA made an application based on this property and created the world’s first LCD.

In January 1969, NHK introduced the LCD developed by RCA in a television program. A Sharp researcher who saw the program was so impressed that he convinced management to start basic research. By the summer of that year, Sharp researchers succeeded in a verification experiment similar to the ones conducted by RCA using a device with a simple structure.

LCDs boasted low power consumption, but presented difficulties with technical issues such as display performance and service life. Other companies were not making much progress toward mass commercialization. Sharp boldly took on this challenge and succeeded in overcoming problems by developing an ionized organic compound as an additive.



Research and development of liquid crystal in a lab

■ The World’s First COS Pocket Electronic Calculators Using an LCD, the EL-805

Entering the 1970s, the utilization of LSIs for major components progressed, and that made it easier for businesses to get into the market for electronic calculators. This caused severe competition in sales of electronic calculators, which would later become known as the “electronic calculator war.” However, Sharp started

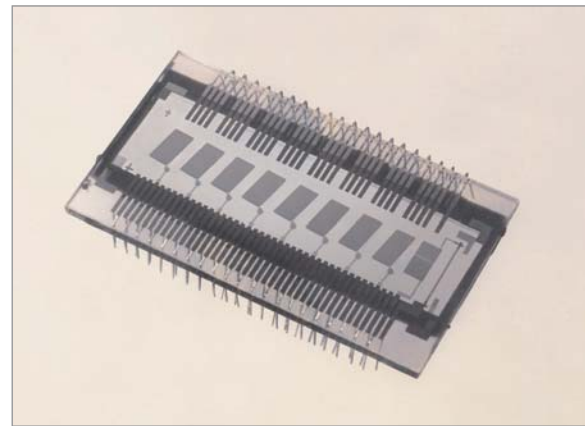

Prototype of LCD used for electronic calculators (1972)

exploring ideas for electronic calculators that were different from the products of competitors. Around that time, fluorescent display tubes and LEDs were starting to be used, replacing Nixie tubes. When combined with C-MOS LSIs, LCDs could be made thinner and battery life could be extended. As such, the company succeeded in making a prototype in early 1972 and decided to position LCDs as the next strategic product.

Due to the fact that liquid crystal can be sandwiched between two pieces of glass, COS structures were also considered. One of the two pieces of glass for the LCD was extended to make a substrate upon which electronic components could be mounted and connected by thick-film wiring.

However, it took two years from the start of full-scale research to be able to see results with liquid crystal. There were many issues to resolve concerning issues such as the mass production of transparent conductive film, the development of liquid crystal materials, and the technology for injecting liquid crystal. The company also needed to build a production line right away.

Requests for support were made to the Osaka National Research Institute as well as to Sharp’s LSI research division. Starting with the development of technologies to produce transparent conductive film and seal the pieces of glass, the obstacles were addressed one by one. Sharp finally succeeded in using liquid crystal for practical applications. In June 1973, Sharp introduced the world’s first COS pocket electronic calculator with an LCD, the EL-805 Liquid Crystal Compet. The technology allowed the calculator to be just 20 mm thick and offer 100 hours of continuous use from a single AA battery. It created a sensation following its release, and newspapers and television reports gave glowing reviews using words such as “groundbreaking” and “technological innovation.” With Sharp having proven the commercial value of liquid crystal, chemical material manufacturers and device manufacturers became convinced of the business potential of LCDs, and a cooperative environment was formed and strengthened.



COS substrate and the EL-805

The company introduced the COS-type LCD electronic calculator at the 5th International Liquid Crystal Conference held in Stockholm in 1974. It was hailed by display researchers from many countries as a significant breakthrough.

New Business with Cash Registers, POS, and Office Computers

Based on technologies used in its electronic calculators, Sharp developed new business-use products such as cash registers and point-of-sale (POS) terminals. Office product dealers had high hopes, and the market held much promise.

For cash registers, a new electronic type that would work with a light touch on the keys was desired to replace the old mechanical types. Sharp entered the market in 1971 with the ER-40, which incorporated IC technology. The following year, Sharp became the first company to succeed in practically applying LSIs. Since then, the company has continued to release unique products such as the industry’s first battery-operated cash register as well as one with a voice function.

In 1972, the company developed the Billpet, a compact business-processing terminal to be used by the salespeople of Coca-Cola (Japan) Co., Ltd. Salespeople were able to input sales data while visiting customers, and the data would be incorporated into a host computer. Sharp designed the logic architecture of Japan’s first micro-processing unit (MPU) for the commercialization of the Billpet. It had been incorporated into an LSI by Nippon Electric Co., Ltd. a year earlier.



The ER-40 electronic cash register, incorporating ICs



The Billpet compact business-processing terminal



The HAYAC-5000 was able to simultaneously process multiple jobs

The BL-3001 POS terminal installed in a Daikyo gas station

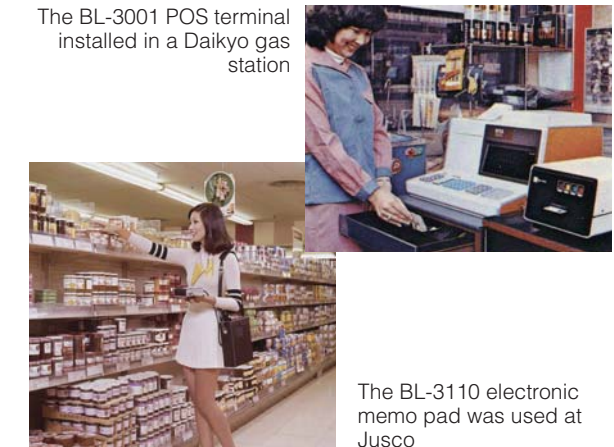

The BL-3110 electronic memo pad was used at Jusco

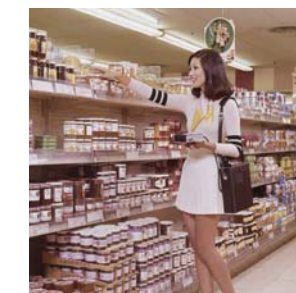

Sharp developed and released the HAYAC-3000—an office computer with the ability to issue vouchers and other functions—in 1971. Making its debut in 1974 was the HAYAC-5000, which could be multi-tasked to run as many as 15 programs at once. This model could simultaneously process information to issue vouchers, calculate salaries, and perform other functions that had previously only been done by large computers. It could also simultaneously issue vouchers to multiple typewriters.

4 Development and Commercialization of Copiers

Sharp innovations had helped to cultivate increasing demand among office product retailers for more products. The company therefore started developing a copier in 1970 to further establish the office products category as one of its core businesses.

The copier was developed from scratch by a small group of engineers who had little previous experience in the field. It was a major challenge for Sharp, as copiers feature complex mechanisms. The new development needed to bring together technologies from various fields such as electronics, optics, mechanics, and chemistry.

The process from design to preproduction went smoothly for the most part. But at the final stage the copier began to have trouble sending paper through for copying, depending on the paper type. Engineers determined that the cause of the problem was the direction of the fibers in the paper*¹. Sending paper in the direction of the fibers—that is, with the “grain” of the paper—solved the problem and paper travel became smooth again. It was an important lesson: that making a good copier involves paying attention to more than just the machine itself.

Sharp released its first copier, the SF-201, in January 1972. It was an indirect-electrostatic wet-toner copier and was well received. The company increased its lineup by releasing the SF-101 (a mass-market model) and the SF-301 (a high-end model) the same year.

The company announced its first plain-paper copier (PPC) at the 1973 Business Show in Osaka and started selling it as the SF-710 in October 1974. Most copiers at that time used complex mechanisms for control, but the SF-710 used IC control.



Sharp's first photocopier, the SF-201

The company exhibited the machine at the Hannover Messe in West Germany in April 1974, just before its commercial release. Many people from major office product companies in Europe and beyond came to see it, and about 10 companies showed interest. Sharp subsequently received official requests for OEM*², and Sharp's OEM business started growing as a core business in tandem with the growth of the Sharp brand in the copier market.

*1 The paper fibers, or grain of the paper, can be aligned either vertically or horizontally.

*2 OEM, original equipment manufacturing, is the manufacture of products to be sold under other companies' brand names.

5 Expansion of the Domestic Marketing and Service Organization

Development of the Sales Organization

In January 1972, Sharp announced a new sales company system to consolidate its 61 regional sales companies nationwide into 16 companies organized in regional blocks. This consolidation streamlined management operations and enabled the company to utilize 1,000 personnel for the frontline sales force. The previous year's Nixon Shock had caused an economic recession and slow sales, so an organizational change to focus on marketing was needed.

The former regional sales companies were renamed “sales centers,” and they increased in number from 61 to 73. In adding offices and branches under each sales center, 138 new sales bases were created to make a stronger sales network.

As part of the new sales company system, existing equipment companies and credit companies were also

reorganized by region in April 1972 to strengthen the organization. The purpose was to make cooperation with sales companies stronger and to promote greater activity in marketing and service activities.

In the field of office products, specialized sales companies were established in Tokyo, Osaka, and Nagoya in July 1969. Before becoming independent companies, the new companies had all been part of Sharp's office equipment marketing divisions in Tokyo, Osaka, and Nagoya. In other regions, home appliance and equipment companies were initially in charge of business machine sales. Later on, office product sales companies were set up in Kyushu, Chugoku, Kanto, Tohoku, and Shikoku and responsibilities were transferred.

In October 1972, the computer systems marketing division was spun off to establish Sharp System Products Co., Ltd. (SSP). This company consisted of three divisions: sales, software development, and maintenance services.

In order to strengthen marketing in the Tokyo metropolitan area, the Sharp Tokyo Building was built in June 1974. The Tokyo Branch, the Home Appliance Marketing Group, the Industrial Machine Marketing Group, and SSP—which had its headquarters in Tokyo—all moved into the building.



Sharp Tokyo Building built in 1974 (later, the Tokyo Ichigaya Building)

Enhancing Systems for Quality and Service

■ Establishment of the Product Reliability Control Center

In 1972, Sharp established the Product Reliability Control Center to further enhance its company-wide quality-control activities. The organization first consisted of a Product Testing Room, where products were tested

from the point of view of customers, and a Packaging Technology Room, where appropriate packaging was researched and developed. Later, a Quality Standards Room was added, to deal with regulations related to product safety and to develop standards. The company also implemented a company-wide design review (DR) in 1972 to prevent malfunctions by predicting potential problems in new products and by thoroughly examining quality and other issues in the design stage.

In July 1972, Sharp opened Consumer Information Centers at nine service companies around the country. The organizational change was made in response to increased demands from consumers following the enactment of the Basic Consumer Protection Act in 1968.

In 1973, the quality control division and service division were consolidated into the Service Group. The new organization was in charge of the Product Reliability Control Center, the Service Management Division (which managed the service companies), and the Parts Center.

The company changed the name of the internal standards for quality control, from “HS” to “SS” (Sharp Corporation Standards) along with the company name change in 1970. As new factories were opening in Hiroshima and Tochigi Prefectures, company-wide quality standards became necessary and the nationwide SS was implemented in May 1974.

In April 1974, the company moved its Parts Center to the Tanabe Plant to establish a standardized distribution system for home-appliance service parts. In 1984, the Parts Center in Osaka was consolidated and relocated to Fujiidera. The Parts Center improved its efficiency by introducing a new service parts automation system.

■ Start of Sharp Precision Machinery and Sharp Kosan

The company's Appliance Division opened a precision manufacturing plant in 1969 to make metal molds*. This was in response to the increased demand for metal molds and the need to modernize and streamline the process of manufacturing them. On March 2, 1970, the plant was independently established as Sharp Precision Machinery, Co., Ltd. (now Sharp Manufacturing Systems Corporation). Anticipating that all business divisions would need metal molds, Sharp had launched its own specialty metal molding company.

Meanwhile, Soei Jitsugyo—a company established in 1962 that operated in real estate, damage insurance, and automobile repair businesses—changed its company name to Sharp Kosan (now Sharp Finance Corporation).



Consumer Information Center at Sharp Kinki Service Center

* Metal molds are used for press or resin molding to mass-produce parts and components for industrial products. The quality of the mold determines the product's appearance, quality, and performance, and it can even affect productivity.

6 Trade Friction and Expansion of Overseas Operations

Growth of Exports to the US and Trade Conflict

Higher Hopes for Exports and Growth of SEC

Sharp's export sales started surging in 1968 and reached 23.6 billion yen in the first half of fiscal 1969—a 155% increase over the same period in the previous year and more than 40% of total sales. As Japan's consumer electronics market had become fairly saturated and the expectations placed on exports became even higher, the company reorganized its Export Group into the Overseas Business Group in April 1970.



Kaiji Geppo ("Overseas Business Monthly"), a publication started by Sharp in 1974 as a newsletter of the Overseas Business Group. It provided updates about the Group, information on regional trends, and product information. It included some articles in English. It was published until 1990, and there were 120 issues.

In the US, the largest market for Sharp's exports, the penetration rate of color TV sets was just over 40%. Sharp anticipated increased future demand and made efforts to reduce costs and increase awareness of the Sharp brand. At the Consumer Electronics Show (CES) in New York in 1970, Sharp exhibited 40 color television sets, including unique products such as a TV with an electronic tuner. These models were reported by the industry media and helped improve Sharp's brand image. Meanwhile, in the market for smaller TVs, the demand for black-and-white TV sets was still strong. Sharp's black-and-white sets had a good reputation for quality and design, and unit sales increased steadily from about 120,000 units in 1968 to 340,000 units in 1970.

Exports of other products were also increasing. There was still strong consumer demand for radios, and Sharp's exports of radios were increasing. Exports of tape recorders, which were shifting to the cassette format, were increasing as well. Exports of microwave ovens, an area



The R-7600, a microwave oven released in the US in 1974. It featured a turntable, which was a popular feature in Japan as well.

where Sharp already had the top market share among Japanese makers, continued to rise. Sharp's US sales subsidiary, SEC, was growing.

In 1970, SEC opened branches or sales offices in Chicago, Los Angeles, Detroit, and Atlanta and the number of employees reached about 300. SEC sales reached US\$26.12 million (approx. 9.4 billion yen), which was about 30% of the company's export sales.

Increasing Exports of Color TVs Cause Trade Friction

Around that time, Japanese consumer electronics manufacturers made progress in using ICs in color TVs, which had previously used transistors. These companies created high-quality products at lower costs, and exports increased. However, the rapid expansion of Japanese exports was seen as causing a decline in US TV manufacturing and an increase in the US unemployment rate. This all led to increasing trade friction.

One event that became symbolic of the time was the filing of an anti-dumping lawsuit by the US Electronics Industry Association against Japanese black-and-white and color TV manufacturers. In March 1971, an anti-dumping tariff was introduced. It remained in place until negotiations between the US and Japan led to a settlement in 1980. In December 1970, a US television manufacturer, National Union Electric Company filed a lawsuit against seven Japanese manufacturers, including Sharp, charging that the manufacturers were acting as a cartel and dumping their products in violation of US antitrust laws. In September 1974, Zenith Radio Corporation joined the lawsuit. The two companies were demanding restitution of US\$1.26 billion. The lawsuit ended with the complete vindication of the Japanese manufacturers in April 1987—but it took a long time to resolve, and Sharp took on a heavy burden in legal expenses. The lawsuit also required a huge amount of paperwork to produce the needed reference materials.

Expansion of Overseas Manufacturing and Sales Bases

Sharp decided to strengthen its manufacturing operations overseas as a way of dealing with trade friction and the economic policies of the US. The company set up a number of manufacturing facilities for re-export. These facilities would export parts and unfinished products to third countries, mostly in Asia, which in turn would then export finished products to Europe and North America.

In 1971, Sharp invested in Sampo Electronics Company in Taiwan and built a new plant where a million radios and 300,000 television sets could be manufactured for export to the US. In 1973, the company established Sharp Data Corporation (SDA^{*1}) mainly to manufacture electronic calculators for export to the US. SDA produced an original-model pocket electronic calculator that used locally made parts. In 1974, the company established Sharp-Roxy Corporation (M) Sdn. Bhd. (SRC^{*2}) in Malaysia as its first large-scale center for re-export of Sharp audio products. In 1975, construction was completed of a 57,000 m² plant capable of producing 700,000 radio sets and 400,000 tape recorders a year.

Meanwhile, beside the centers for re-export, the company established Sharp do Brasil S.A. Indústria de Equipamentos Eletrônicos (SDB) as a manufacturing base for electronic calculators and color TVs for Brazil's domestic market.

With a view to establishing a sales organization that did not rely so much on the US market, Sharp opened a number of new sales subsidiaries. In 1971, the company established Sharp Corporation of Australia Pty. Ltd. (SCA). SCA, with capital of 400,000 Australian dollars (150 million yen) sold electronic calculators, stereo sets, tape recorders, microwave ovens, and other products. SCA built a plant in 1975 and started manufacturing color TVs. In 1974, the company established Sharp Electronics of Canada Ltd. (SECL) with capital of 300,000 Canadian



Inside the SRC plant established in Malaysia in 1974. Since then, Sharp established a sales company and a manufacturing company in Malaysia, making that country an important overseas base.

dollars (90 million yen), selling electronic calculators and other office products and offering after-sales services. Strengthening sales networks around this time helped to raise awareness of the Sharp brand, and the company could accelerate its plans to move away from exporting "store brands."

^{*1} The company name was changed to Sharp Korea Corporation (SKC) in 1984.

^{*2} In 2008, Sharp dissolved the joint venture agreement with Roxy and started a new joint venture with Onkyo Corporation under a new company name, S&O Electronics Malaysia Sdn. Bhd. (SOEM).

The First Oil Crisis

Triggered by the Fourth Arab-Israeli War that started in October 1973, Arab nations substantially reduced oil supplies to the US and other Western nations and then continued to reduce oil production. Further, OPEC (Organization of the Petroleum Exporting Countries) raised crude oil prices to about four times their previous levels over a period of just two months.

Japan had made a full-scale shift in energy supply from coal to oil in the 1960s and was relying heavily on oil. The reduction of oil imports and rising prices had a serious impact on the economy.

Companies were frantic to secure raw materials and fuel, and—partly as a result of their rush to purchase supplies—the balance of supply and demand was severely challenged. Prices, even in the area of consumer items, surged dramatically.



During the oil crisis, even gas stations were putting up banners calling for people to conserve energy (photo courtesy of *Asahi Shimbun* newspaper)

Device Industry and Information/Communications Products That Originated in Calculators

Device industry stemming from the calculator

Semiconductor Industry



Camera module
Microwave oven
Word processor

Faced with the need for LSIs to use in its calculators, Sharp built the Advanced Development and Planning Center including a semiconductor plant in Tenri in 1970 and began mass-producing LSIs. Sharp's approach of developing distinctive products through the in-house manufacture of key devices began here.

LCD Industry



LCD TV
Media tablet
Videocamera

To differentiate its offerings from those of competitors, Sharp incorporated an LCD, which it had been researching since 1969, in a calculator, thereby creating a thinner device that used less power. LCDs went on to become key devices used in fields ranging from information/communications devices to audiovisual products, evolving into a premier electronics industry.

Solar Cell Industry

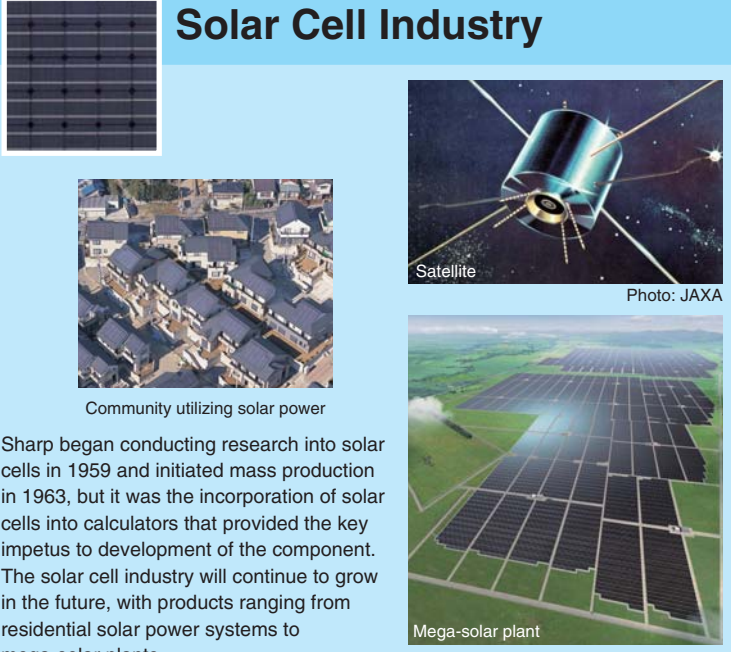

Satellite (Photo: JAXA)
Mega-solar plant

Community utilizing solar power

Sharp began conducting research into solar cells in 1959 and initiated mass production in 1963, but it was the incorporation of solar cells into calculators that provided the key impetus to development of the component. The solar cell industry will continue to grow in the future, with products ranging from residential solar power systems to mega-solar plants.

Sharp Calculators Recognized as an IEEE Milestone (2005)

Sharp calculators have been recognized as an IEEE Milestone by the IEEE, an international academic society in the area of electricity and electronics. The honor recognizes innovative initiatives undertaken by Sharp from 1964 to 1973 to miniaturize calculators and reduce their power consumption. Semiconductor, LCD, and solar cell technologies established as part of these research processes made significant contributions to the development of the electronics industry.



IEEE Milestone commemorative plaque

Origins of information/communications products

All-transistor diode calculators



1964: CS-10A

IC calculators



1967: CS-31A

LSI calculators



1969: QT-8D
Used MOS LSIs to achieve a higher degree of integration than was possible with ICs

LCD calculators



1973: EL-805
Used an LCD and C-MOS LSIs; could be used for 100 hours on a single AA battery

Solar-powered calculators



1976: EL-8026
Brought solar cells, which had previously been used exclusively in lighthouses and on satellites, to the calculator

Buttonless



1977: EL-8130

0.8 mm thick



1985: EL-900

Exceptional designs



1979: EL-8152

Development of more advanced manufacturing technologies

ELSiS

Awarded the 1970 Okochi Memorial Production Prize

Development of the film carrier method



1976: EL-8020

Production line automation

First-half process



1978: EL-8140

Second-half process



1980: EL-211

Awarded the 1980 Okochi Memorial Production Prize

Sharp's information communications products that are attracting attention today



- Touchscreen LCD monitor
- Digital MFP
- Electronic cash register
- POS terminal
- Media tablet
- Business-use mobile handsets
- Electronic dictionary
- Fax machine
- Calculator
- Smartphone

| | | | | | | |
|--|---|--|--|--|--|---|
| Voucher printers 1962 CTS-1 | Minicomputers 1971 HAYAC-3000 | Handy data terminals 1972 BL-3100 | Scientific calculators 1977 PC-1200 | Electronic translators 1979 IQ-3000 | Electronic organizer 1987 PA-7000 | Zaurus PDA 1993 PI-3000 |
| Cash registers 1971 ER-40 | Compact business processing terminals 1972 Billpet | POS terminals 1973 BL-3700 | Personal computers 1978 MZ-80K | Word processors 1979 WD-3000 | English-Japanese translation system 1988 DUET E/J | Electronic dictionaries 1997 PW-5000 |
| Copiers 1972 SF-201 | | | | Fax machines 1980 FO 2000 | Cordless phones 1987 CJ-530 | Mobile phones 1994 JN-A100 |

Chapter 6 | 1975 - 1985

Development of the “New Life” Product Strategy Building a Strong Financial Structure

In the midst of sluggish domestic demand resulting from market saturation of home appliances and an economic downturn that followed the oil crisis, Sharp laid out its New Life product strategy—a consumer-oriented strategy that proposed new lifestyles.

This was well received and contributed to both sales and profits. In addition, the office automation equipment business—including copiers and fax machines—began to blossom in earnest. Overseas, in the face of growing trade friction, Sharp continued its development by strengthening overseas production and introducing new categories of products.

With the success of these business strategies, Sharp achieved 10 consecutive years of growth in sales and profits. At the same time, it improved its financial structure.

Thin profiles enabled Sharp to win the calculator wars. The EL-8152 featured an outstanding design with a thickness of just 1.6 mm.

1 Setting in Motion a New Strategy to Ride Out an Economic Downturn

The New Life Product Strategy

To cope with the first oil crisis in 1973, Sharp pushed forward with development of feature-oriented ELM products designed to eliminate wastes of energy (E), labor (L), and materials (M), but they were never fully able to address the needs of consumers.

Consequently, in 1976, the company launched an innovative New Life product strategy. The intention was to introduce a new marketing technique called “lifestyle proposals,” which involved suggesting new lifestyles to the youth segment born after World War II and dubbed the “baby boomers.” These individuals had values different from those of the past—values that were expected to spread among an even broader segment of consumers. Sharp created development standards tailored to these values and designated high-value-added products meeting these criteria as New Life (NL) products.

In the course of designing this new strategy, Sharp studied leading companies who were profitable even during periods of economic recession. The points these companies had in common were 1) that they made products that pursued the values of consumers, and 2) that everyone in the company had a solid understanding of company policies and strategies. With this in mind, Sharp instituted the New Life Committee in April 1977 to thoroughly inform all employees about the concept of the

new strategy—an essential first step towards implementing it. More than 700 management personnel at the section manager level were appointed to the committee, including personnel from head office divisions and sales subsidiaries.

Popular New Life Products

The first NL product was the 16C-681S 16-inch color TV introduced in April 1976. It satisfied the desires of consumers who wanted to enjoy a larger 16-inch screen on a TV equivalent in size to a 14-inch model. The SJ-6400X three-door refrigerator/freezer announced at the same time positioned the frequently used refrigerator compartment on top and included a special bin to store vegetables at the proper temperature. This product was introduced in response to the voices of housewives who wanted to keep vegetables fresh without having them dry out.

The emergence of these hit products changed the way NL products were viewed within the company, particularly among sales representatives. A series of products made their debut and gained popularity in the market, including a stylishly designed vacuum cleaner and a stereo cassette player with a track-selection feature.

The 200th NL product was the R-5000W sensor microwave oven introduced in December 1979. It was an innovative product that detected the degree of doneness when cooking and automatically adjusted heating time without using a timer. It was a popular product, and the company was flooded with orders.



SJ-6400X three-door refrigerator/freezer



EC-1500 vacuum cleaner was highly rated for its stylish design

The percentage of NL product sales among all home appliances sold in fiscal 1979 was around 45%, and they grew to become a mainstay for Sharp. They proved to be a major contributor to sales growth and improved profits in this period.

Products such as the ones below were hits either side of 1980.



VC-6080 VCR sold for the then-low price of 150,000 yen



GF-808 double-cassette radio/player offered new value, namely, the ability to edit cassette tapes

New Developments Follow the New Life Strategy

As the information society continued to advance, Sharp formulated the New Business Strategy in April 1980. The company proposed a new around-the-clock lifestyle that augmented its “new lifestyle at home” concept with a “new business style at work” concept.

In 1985, the 10th year of the New Life Strategy, the company redefined its target-user market segment. In place of the “new family” approach, which emphasized emotional value, the company adopted a New Life People Strategy that focused on informational value and targeted young people with unique personalities and a strong sense of individualism. New product engineering was launched, directed toward consumers who were in the vanguard of new modes of living in the information society.

Design played an important role in both the New Life and New Business strategies. In October 1973, all design teams were reassigned from their divisions and placed under the umbrella of the Corporate Design Center, a newly established company-wide business unit that reported directly to the President. Design strategy was

given a role not only to improve product value, but also to improve corporate image by reflecting corporate strategy and embodying Sharp’s business philosophy through design.

The Corporate Design Center developed product designs based on the fundamental concept of “humanware design,” which made the user the foremost consideration.

New Focus on Sales Promotion Measures

NL products were designed to propose new lifestyles, so it was important to communicate to dealers the “heart and soul” that underpinned product planning. To that end, Product Strategy Meetings (i.e., preview meetings) were held across the country. There was also a high level of interest in NL products from people other than exclusive Sharp dealers. The number of participating stores increased over time, so that by the spring of 1979, representatives from 8,500 stores were in attendance.

To complement the product strategy, Sharp proposed creating tastefully designed retail stores where consumers could experience the benefits of the products first hand. This led to upgraded exterior signage and the establishment of in-store New Life product areas. To increase points of contact with consumers, Sharp had, since 1973, been making use of nationwide joint exhibitions (*Goten*)—product-exhibition and -sales events held in collaboration with local dealers. The aim was to expand sales through lifestyle proposals by bringing together expertise for attracting customers and promoting sell-through. The exhibitions toured the entire country, attracting customers with unique events.



Stores were refurbished to become New Life Stores suitable for NL products. They received new standardized exterior signage (top) and were set up with unconventional sales-floor designs.

The ATOM unit was also active in promoting sell-through of NL products. One of their unique activities was a “bucket” promotion that was deployed nationwide in 1985. In advance, customers were handed a plastic pail on which an invitation was affixed. When the customer visited a store, a door prize—such as vegetables or a convenient everyday item—was placed in the pail. The element of surprise and the sense of expectation proved popular, and these promotions produced a customer turnout two to three times greater than that of normal sales events.

2 Breaking Through to Be a Trillion-Yen Company

The One-Trillion Yen Initiative and 10 Straight Years of Growth in Sales and Profit

■ Announcement of the One-Trillion Yen Initiative

At the Basic Management Policy Presentation in January 1980, President Saeki announced a growth initiative that targeted sales of 1 trillion yen (non-consolidated) by fiscal 1987, the 75th anniversary of the company’s founding.

The company formulated a series of three-year plans to boost sales from approximately 395 billion yen in fiscal 1979 to one trillion yen. Called the New Sharp Strategy, it aimed at making an unprecedented leap forward. In 1983, the targeted year for reaching one trillion yen in sales was brought forward, to fiscal 1985. In fiscal 1983, non-consolidated sales were 756.5 billion yen, while consolidated sales were 1.172 trillion yen. However, the export environment deteriorated during fiscal 1985; sales on a non-consolidated basis were 955.2 billion yen, falling slightly short of the 1 trillion yen target.

In 1985, Sharp deployed ATTACK '90, a company-wide movement that looked ahead to the 1990s and aimed to strengthen overall management capabilities. It was a movement devoted to management “attacks”—that is, management on the offensive. One of the initiatives of ATTACK '90 involved the launch of the CM (Creative Management) campaign. Under this campaign, employees aligned themselves with the direction of company-wide and departmental policies. The tasks that needed to be accomplished—and the people responsible for achieving them—were clearly delineated. Employees were expected to do their job tasks autonomously and creatively in order to reliably and steadily achieve business objectives. Implementation was based on the PDCA cycle: developing policies (Plan); executing policy measures (Do); performing self-checks and undergoing checks by superiors (Check); and implementing measures and countermeasures in response (Act).

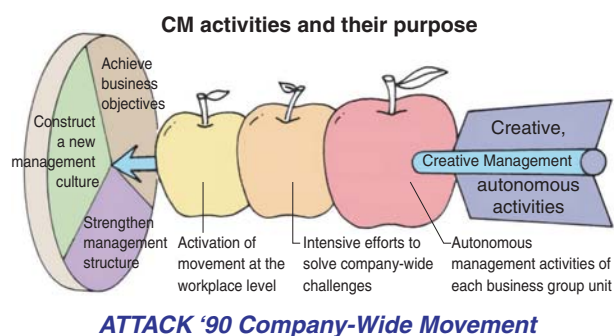

■ Sales and Profit Increase for 10 Consecutive Years from 1976

Sharp worked to stimulate demand by developing novel and feature-rich products based on innovative technologies and marketing strategies. In addition, all departments

worked ceaselessly to strengthen management structure. As a result, financial results showed steady improvement, and the company saw growth in sales and profit for 10 years in a row from fiscal 1976 to fiscal 1985.

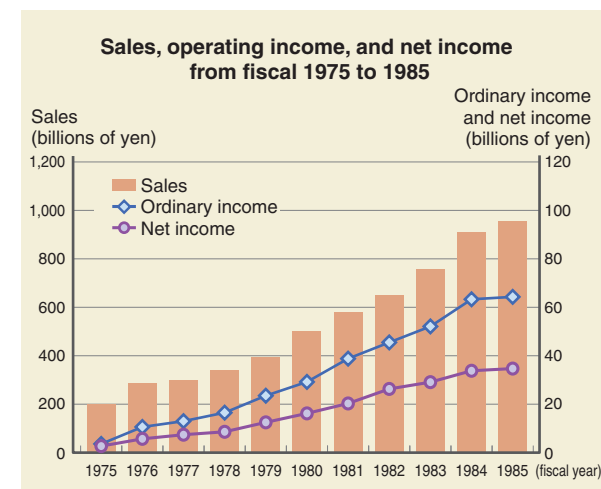

In this period, one of the factors behind Sharp’s strong operating results was the company’s effort to rapidly strengthen its financial structure. In 1975, Sharp embarked on an initiative to strengthen its balance sheet by setting goals to reduce debt, improve its capital-asset ratio, and lower the break-even point. First, each division worked to reduce accounts receivable and inventory, in order to create an environment that would allow an injection of high-quality external funding. Leveraging this, the company raised new capital by issuing convertible bonds and by making a public offering of new shares at market price. In overseas markets during the years from 1978 to 1985, Sharp issued convertible bonds, which were denominated in German Marks and Swiss Francs, as well as European Depositary Receipts (EDRs).

Over the 10 years from fiscal 1976 to 1985, Sharp made capital investments at home and abroad totaling approximately 500 billion yen and invested a total of approximately 280 billion yen in research and development. Even while making such huge investments, the company worked to enhance its financial structure through the capital-raising efforts mentioned above, so that in fiscal 1985 the company posted an annual financial profit in excess of 25.0 billion yen (non-consolidated). In addition, the company’s net assets (non-consolidated) at the end of fiscal 1985 were 350.5 billion yen—about 8.5 times the level at the end of fiscal 1975—and the capital-asset ratio stood at 40.6%. Sharp’s financial structure had thus been greatly strengthened.

Subsequently, non-consolidated financial results for fiscal 1989 showed sales of 1.572 trillion yen and ordinary income of 72.4 billion yen. This was a record high for both sales and profit, and the company had at last achieved its goal of being a trillion yen business.

Establishment of Sharp Taskforces

In 1977, Sharp Taskforces (*Kin-Pro*) were born. This system is unique to Sharp and offers unparalleled flexibility for teams working under the direct control of the President. The best human resources are gathered from each division and research laboratory to tackle urgent themes that require company-wide collaboration outside the regular company organizational structure.

What provided the model for the Sharp Taskforce was the S734 Project organized in 1972 to win the “calculator wars” of the early 1970s. Making the EL-805 COS calculator a reality required concurrent development of innovative new technologies—such as the LCD, C-MOS LSI chip, and thick-film wiring—over a short span of one year. Accordingly, Sharp achieved its objectives by creating an organization that crossed divisional boundaries and involved the collective efforts of engineers from the Corporate Development Group and the Industrial Equipment Group.

Based on this model, the company set up the Emergency Command System, later renamed Sharp Taskforces. This became the framework under which projects were established. These projects encompassed not only development and production, but also fields such as sales and management.

Starting in December 1977, 14 Sharp Taskforces were launched—including one working on development of the front-loading VCR—and achieved notable success.

Members of Sharp Taskforces wore a gold company badge and displayed a spirit of striving for success, no matter what. With their combination of human resources, facilities, and funding, the Sharp Taskforces demonstrated development capabilities that other companies were unable to replicate.

Many unique, proprietary products such as the Zaurus PDA and LCD ViewCam videocamera came out of these Sharp Taskforces. Wide-ranging interchanges between team members—who gained a solid grasp of the processes involved in commercialization—also had a beneficial effect on the development of the company’s human resources. Sharp’s corporate culture supported a climate of



fusion, such that team members were never made to feel organizational barriers. This was the key to the longevity and success of the Sharp Taskforces.

The Death of Chairman Hayakawa

On June 24, 1980, Chairman Tokuji Hayakawa, the founder of Sharp, passed away. He was 86 years old.

The company funeral for Chairman Hayakawa was held on July 12 at the Namba Branch Temple (Minami-mido) of Higashi Honganji temple in Higashi-ku (now Chuo-ku), Osaka, with the service presided over by President Saeki. Representing friends, Konosuke Matsushita, founder of Matsushita Electric Industrial Co., Ltd., delivered a eulogy that left a deep impression on those in attendance.



June 25, 1980: Prayers were offered for the spirit of deceased Chairman Hayakawa during his funeral procession leaving the head office

In November 1981, to honor the memory of the founder, the Memorial Hall and Technology Hall were completed within the Advanced Development and Planning Center at Tenri, Nara Prefecture. A number of representative products for which Sharp was the industry leader are on display in the Memorial Hall. These include the Tokubijo snap buckle and the Sharp Pencil invented by the founder, as well as crystal radios, TVs, and electronic calculators. The Technology Hall emphasizes Sharp’s technological prowess, and features easy-to-understand commentaries intermingled with demonstrations of the latest technologies.

In April 1980, the Sharp Fellowship Society was formed. Established for the benefit of retirees of the company, the society provided a place where old associates—who had shared good times and bad—could gather and maintain ties with the company. The society continues to hold New Year’s gatherings, publish a newsletter, and sponsor various club activities. Chapters have subsequently been formed across the country. An issue of the newsletter commemorating the 30th anniversary of the Sharp Fellowship Society was published in April 2010.

3 Growth of the Device Business Built around Technology

Expansion of the Solar Business

■ Enhancing Monocrystalline Solar Cell Technology

Sharp's solar cell business broadened to encompass applications other than maritime uses. By working ceaselessly to improve conversion efficiency and reliability, the company strengthened its position as a leading solar cell manufacturer.

In February 1976, Sharp solar cells traveled to outer space aboard the Ume, Japan's first operational ionosphere-observing satellite. For solar cells used on artificial satellites traveling outside Earth's atmosphere, the conversion efficiency was improved for short-wavelength solar radiation such as ultraviolet light, and, furthermore, the size and weight were trimmed. Since no repairs were possible in outer space, a thorough quality-assurance system was set up to establish the extremely high reliability that is essential for mission-critical components such as power sources.

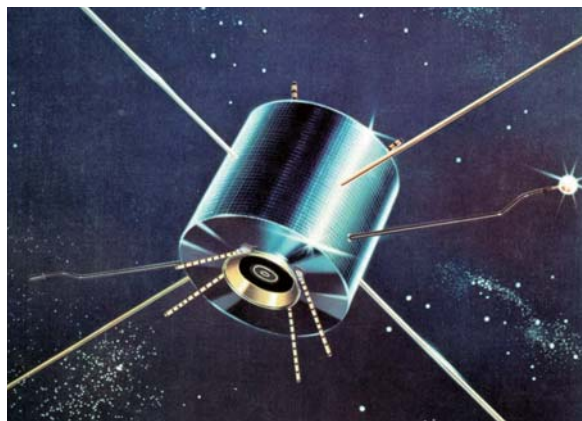

Ume, Japan's first domestically produced operational space satellite powered by Sharp solar cells (photo courtesy of Japan Aerospace Exploration Agency [JAXA])

When it came to solar cells for terrestrial applications, Sharp developed the S-225 solar module in 1976. This module featured a tightly sealed, ruggedized structure designed for sea-based or coastal installations where maintenance was difficult. In addition, in 1976 the company developed the EL-8026, the world's first solar-powered calculator.

■ Commercialization of Amorphous Silicon Solar Cells

Amorphous (non-crystalline) solar cells offered attractive advantages. For one, they eliminated the need for the crystallization process. What's more, they were cost-effective, owing to the fact that they used only about 100th the amount of refined silicon, compared to crystalline solar cells.

In 1982, Sharp established Sharp-ECD Solar Co., Ltd. as a joint venture with Energy Conversion Devices Inc. (ECD) of the US. The company was able to form a tandem-cell

(dual-layer structure) amorphous silicon film on a stainless steel substrate, and it boasted high productivity.

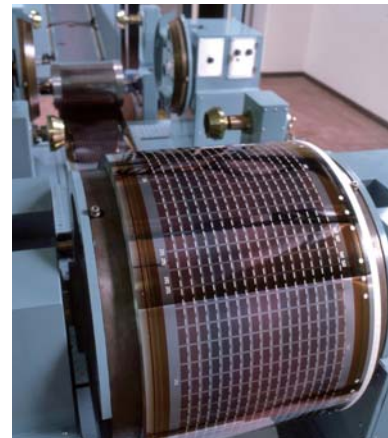

Production line for amorphous silicon solar cells, whose distinguishing feature is the roll-to-roll process

■ Shinjo Plant Completed for Dedicated Production of Solar Cells

The oil crisis prompted the Japanese government to launch the Sunshine Project to promote development of alternative energy sources. In 1980, the Solar Equipment Group was established to commercialize solar energy (i.e., solar light and heat). The Shinjo Plant (now the Katsuragi Plant) was constructed in Shinjo-cho, Kita-katsuragi-gun (now Katsuragi City), Nara Prefecture to serve as its base of operations.

Plant No. 1 produced the Solar Ace A (Auto) solar power system, consisting of a high-efficiency heat collector and heat-storage tank. At the same time, Plant No. 2 for solar cells had an annual production capacity of 1,000 kW.

Demand for solar products fell rapidly after oil prices settled down and Sharp downsized its solar business. Nevertheless, the advanced technologies and sales networks developed during this time were later fully put to use.

The Evolving Electronic Device Business

■ Growth in Opto Devices Based on Proprietary Technologies

OPIC devices were a revolutionary development in the field of optoelectronics. OPIC (optical IC) devices integrated an optical semiconductor (a light-receiving element) and signal-processing circuitry (an IC) onto a single chip. In addition to helping make products more compact at lower costs, OPIC devices also had the outstanding feature of being highly resistant to electrical noise—a benefit deriving from the fact that they are single

Structure and block diagram of OPIC chip (IS485)

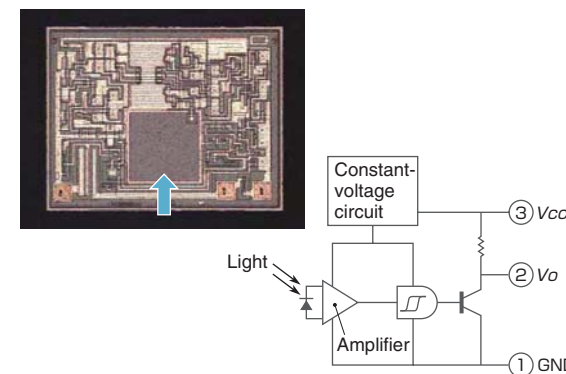

The square in the center (arrow) is the photodiode (light-receiving component); the area around it is occupied by signal-processing circuitry (IC).

integrated devices. Taking advantage of this, Sharp developed numerous OPIC products, including a laser light-receiving element. In 1981, a photo-interrupter to detect the motion of objects and a photocoupler that provided both electrical isolation and signal propagation were developed.

Also in 1981, Sharp developed the VSIS (V-channeled Substrate Inner Stripe) structure to effectively extract laser light. It was a breakthrough that extended the lifetime of existing laser diodes by several times, enabling a service life of approximately 40,000 hours. It proved extremely popular, and since 1982 Sharp laser diodes have been used by numerous makers in the majority of their CD players.

■ Commercialization of Inorganic EL Displays

In 1974, Sharp developed thin-film technology capable of depositing light-emitting elements under vacuum for use in EL (electroluminescent) displays. This enabled a display in which the panel itself was very thin, with a thickness of about 2 mm. Moreover, compared to CRTs, this panel consumed only one-fifth the power, provided wide viewing angles, and suffered virtually no bleed (blurring).

In 1983, the industry's first factory for mass production of EL displays became operational. These displays were adopted for use as monitors in instrumentation and production equipment, and they were also installed as computer displays on the US Space Shuttle.



Thin-profile, easily viewable EL displays

■ Development of New LSI Chips

In 1977, taking advantage of LSI technology developed for the electronic calculator, Sharp introduced the SM-4, the world's first C-MOS-based single-chip 4-bit microprocessor. As well as offering ultra-low power

consumption, the SM-4 came in a flat package that represented a significant improvement in mounting density. It went on to see widespread use.

One application of the SM-4 was in a portable game device introduced in 1980, which became a huge hit in Japan.

Progress in LCD Technologies

■ From DSM to TN LCDs

The display element in the EL-805—Sharp's first LCD pocket calculator—was a DSM (dynamic scattering mode) LCD. This LCD presented significant difficulties, in that it required high drive voltages and its response time slowed at low temperatures. Accordingly, in 1976, Sharp introduced the EL-8020—a calculator equipped with a TN (twisted nematic) LCD. TN LCDs were also used in small game devices with a built-in clock. Faced with growing demand, Sharp began operating an integrated production line with advanced automation in 1982.

■ Development of an LCD TV

Beginning in 1976, Sharp launched research on an LCD TV. Passive-matrix LCDs were not capable of achieving high-resolution image quality. Therefore, in 1983, Sharp developed an active-matrix LCD that incorporated thin-film transistors (TFTs). The company then went on to complete a prototype of a 3.2-inch color LCD TV.



Prototype 3.2-inch TFT color LCD TV (1985)

■ From TN to STN LCDs

At the same time, Sharp developed the STN (super twisted nematic) LCD for use in passive-matrix LCDs. The liquid crystal material in this new design featured a twist angle increased from 90°—the angle achieved by TN LCDs—to 240°. This allowed the LCD to provide sufficient contrast even when the panel was enlarged (i.e., when its pixel count increased). Equipped with this LCD, the WD-250 word processor could display text and graphics clearly on its large screen. That model gained popularity in part because of the convenience it offered in creating New Year's greeting cards in Japan. Through the success of this word processor, demand for LCDs also grew dramatically.

4 Establishing a Foothold as an Electronic Office Equipment Manufacturer

In the late 1970s, office equipment evolved and began to be called OA (office automation) equipment. Sharp developed a range of electronic office equipment, adding new features to earlier models of calculators and copiers. In addition, the company responded to requests from dealers by expanding into new product categories, such as fax machines or computers—the latter evolved from earlier calculator designs.

Development of Calculators and Computers

■ Outbreak of the Calculator Wars

In the 1970s, the fierce competition in the Japanese calculator market grew even more intense and came to be known as the "calculator wars." To win amid this competition, Sharp announced a policy of in-house start-to-finish production—from parts to finished products—to make calculators different from those of other companies. The company pushed forward to give Sharp calculators thinner profiles.

In 1975, Sharp introduced the 9 mm-thick EL-8010 calculator, which was followed a year later by the 7 mm-thick EL-8020. In 1977, the EL-8130 "card" calculator was born, boasting a thickness of 5 mm. This buttonless model used a keyless touch pad that emitted a beep for each finger press to confirm the desired operation. Marketed with a highly effective TV commercial using the catch phrase, "The button wars are over!," this calculator became a huge hit.

In 1978, automated production lines built around ultra-fine pattern-fabrication technology made the EL-8140 calculator possible. It was the size of a credit card, with a thickness of 3.8 mm. The 1.6 mm-thick EL-8152 was launched the following year. Thanks to its outstanding design, it was selected for the permanent collection of the Museum of Modern Art, New York. Following this, in 1985, the 0.8 mm-thick EL-900 was introduced.

In addition, Sharp introduced a series of new calculators, including solar-powered models, calculators combined with an abacus, and scientific calculators. By 1985, cumulative production of calculators had reached more than 200 million units.

■ The Birth of the Pocket Computer and Electronic Translator

After the calculator, Sharp launched development of new products such as portable devices using dot-matrix LCDs that could display not only numbers, but also Roman letters and Japanese *katakana* characters. These developments led to the birth of the pocket computer and an electric translation device.

In 1977, Sharp introduced the PC-1200, its first pocket computer. It added programming functions to the calculating capabilities of a scientific calculator. In 1980, the PC-1210 was introduced with BASIC, a general-purpose

programming language. This was a huge hit product for applications such as scientific computing and introductory programming. The PC-1500 introduced in 1982 featured extended applications to handle business tasks, such as calculating estimates. A book was sold in which users presented their own programs written for the PC-1500, such as schedule management and an address book. The pocket computer gave impetus to the development of products such as electronic organizers.

In 1979, Sharp introduced the IQ-3000, its first electronic translation device. About 2,800 English words and phrases at the high school level, plus a 5,000-word Japanese dictionary (displayed in *katakana*) were built in. The following year, the IQ-3100 multi-lingual translator was introduced. With additional options, it could translate among three languages at the same time, making it useful for overseas travel. Its 23-character screen was wide enough to display conversational phrases.

In 1981, the IQ-5000 electronic translator with voice synthesis technology made its debut.

■ Development of Japanese-Language Word Processors

At the 1977 Business Show in Tokyo, Sharp unveiled a prototype Japanese-language word processor, a first in Japan. The functionality of its *kana-kanji* conversion feature—a proprietary development of Sharp—had been enhanced during the commercialization process, opening up new possibilities for a wide range of electronic office equipment. In 1979, the WD-3000 word processor was introduced using a text-input system based on a *kanji* tablet. In 1982, Sharp introduced the WD-1000, which was equipped with a *kana-kanji* conversion function, and in 1983, the WD-2400T, which combined a typewriter keyboard and phonetic tablet for Japanese-language input.

Sharp also began to focus on development of word processors for personal use. In 1984, it introduced the WD-500, and in 1985, the WD-100, which featured phrase-based *kana-kanji* conversion and which retailed at a low price of 148,000 yen.



PC-1210 pocket computer with BASIC programming capability



IQ-3000, Sharp's first electronic translator



WD-3000, Sharp's first Japanese-language word processor

In addition, as offices were beginning to move away from electric typewriters, Sharp also entered the electronic typewriter market, with a primary focus on Europe and the US. The ZX-400, a mass-market model for offices, was introduced in 1982, along with the ZX-500, a mid-range model with a display.

■ Introduction of Personal Computers

In May 1978, the Components Division of the Electronic Components Group introduced the MZ-40K microcomputer kit, and in December, the MZ-80K, an assemble-it-yourself model that ran under BASIC. This was Sharp's first personal computer. The next year, the MZ-80C was introduced as its pre-assembled version, and in 1981, the MZ-80B as a high-end model. The MZ series captured the top market share and became highly sought-after by engineering students, helping to boost Sharp's image as a technology company.

In 1980, the Electronic Calculator Division of the Industrial Equipment Group launched the PC-3000 series of computers for business and office tasks, but it turned out that it competed with the MZ series. To resolve this problem, in October 1981, it was decided to establish the Personal Computer Division within the same Group, and to place development and production of both the MZ and PC series under its control.

In November 1982, in turn, the TV Systems Division of the Electronic Equipment Group launched the X1 PC-TV. In addition to TV and PC functions, it enabled TV and PC image signals to be superimposed. The X1 was a particularly popular model among audio-video fans and game-oriented young people.



The MZ-80B (left) and X1 PC-TV became popular products

Evolution of Copiers and Introduction of Fax Machines

■ Developing the World's First Copier with an LSI Chip

In 1976, Sharp introduced the SF-710L, the world's first copier to use an embedded LSI chip. Switching to an LSI chip made it possible to shrink the control board to fit onto a single printed circuit board, and it also served to improve reliability, reduce the overall size of the copier, and lower costs. In 1978, Sharp introduced the SF-810, the industry's first stationary-platen desktop copier. The platen, which had previously moved horizontally to scan the document original, was now stationary, and this design subsequently became the model for mid-range and mass-market machines. The SF-740, introduced in 1979, also featured the ability to copy onto postcards and became a best-selling machine.

With a goal of producing the world's smallest and lightest copiers, Sharp developed compact, low-speed models not available from US and European manufacturers. The SF-750 and SF-770 copiers introduced in 1981 were hits in Japan and abroad. The Z-60, a copier small enough to be considered for personal use, was introduced in 1984. The world's smallest B4-size copier at the time, the Z-60 offered a number of innovative features, including a developing unit that could easily be replaced by users themselves. In 1985, the SF-9500 was added as Sharp's first high-speed model, and served to complete a full lineup—from the smallest personal models to high-speed machines.

■ Introducing Fax Machines

In 1979, while awaiting a decision from the International Telecommunication Union on international G3 facsimile transmission standards for high-speed machines, Sharp worked to develop products that could take advantage of the anticipated new standards. In 1980, the company introduced the FO-2000 series of G3 fax machines, which were capable of sending and receiving text more clearly with finer detail.



FO-2000 G3 fax machine

■ Developing a Broad Range of Commercial Equipment

In June 1974, Sharp combined three departments—those for vending machines, refrigeration equipment for cold chain distribution, and air conditioning equipment—and established the Commercial Equipment Division. Sharp's coffee-vending machines were market leaders: in 1977 they boasted a 40% share of the entire Japanese market and accounted for approximately 70% of the Division's total production value.

Environmental information systems represented a unique business field targeting the public sector. Traffic information systems—an area that Sharp had been working on since the late 1960s—informed drivers traveling on expressways about abnormal weather conditions, traffic congestion, speed limits, and the like. A water distribution system that provided remote control of municipal water systems was also widely popular.



Vending machine production line at the Yao Plant (1976)



The world's first road weather information system installed on the Tomei Expressway used an illuminated board to automatically display traffic warnings (1969)

5 Expanding and Upgrading Production Facilities

In 1978, the Industrial Equipment Group launched the ACE-80 Plan, a three-year initiative aimed at rapid development following a basic policy of Advance, Challenge and Expand. Under this plan, the Nara Plant introduced the world's first automated production line for the complete fabrication of electronic calculators. In addition to the automated assembly of printed circuit boards, which it had been doing previously, it employed automated cabinet assembly and automated testing and inspection. The plant achieved production of 300,000 units per month and was awarded the 1980 Okochi Memorial Production Prize*1.

In response to growing demand for optoelectronic devices for use in office equipment, VCRs, and factory automation, Sharp consolidated the Semiconductor Applications Division at the Shinjo Plant (now the Katsuragi Plant) in 1985. The plant was tasked with providing greater production capacity for the electronic components business.

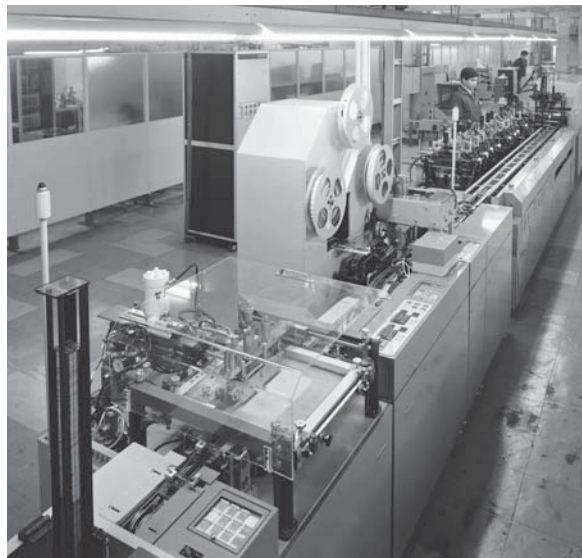

Automated production line for finished calculator products—a world first (Nara Plant)

In the autumn of 1973, production of audio products—including radios, tape recorders, and stereo systems—was consolidated at the Hiroshima Plant, which became the major base for the Audio Systems Division. In addition, deregulation of the telecommunications business in Japan prompted Sharp's entry into the phone equipment market.

Home game machines introduced by a certain toy manufacturer in 1983 were a big hit, and sales of the mask ROM*2 products used in them grew dramatically. To respond to this demand, Sharp constructed the Fukuyama Plant in 1985 (in Fukuyama City, Hiroshima Prefecture). This state-of-the-art automated plant used robots in all production processes. Further, Fukuyama Plant No. 2—which was constructed in 1989—introduced microfabrication technology along with the latest computer-integrated manufacturing systems.

In September 1978, Sharp established the CAD (computer aided design) Center. In 1980, the company began marketing a CAD system for printed circuit board design that reduced design time to one-tenth of previous levels and that accommodated automation of production equipment. In addition, in 1983, Sharp developed Kernel-3D, an integrated 3D CAD/CAM (computer-aided manufacturing) system for mechanical design. The system supported design at both the conceptual and mechanical levels and for items such as molds and dies.

*1 The Okochi Memorial Production Prize is an award presented to individuals and business entities who have improved business performance, as evidenced by outstanding results as well as inventions and designs related to production engineering and advanced production methods. The prize is named after Dr. Masatoshi Okochi, the third president of Japan's RIKEN natural sciences research institute.

*2 Mask ROM is a type of read-only memory (ROM) whose data contents are permanently stored in it using transistor circuitry.

6 Establishing Sales Subsidiaries on a Nationwide Scale

Restructuring and Consolidating the Sales Organization

Around this time in Japan, consumer electronics distribution underwent a major shift towards nationwide specialty retailers and chain stores. Sharp's business partners were seeking distribution agreements covering larger geographic areas, along with a consolidation of

business contact points. It became necessary for Sharp to move beyond the previous regional structure and establish companies providing nationwide coverage.

In 1972, Sharp's system for marketing consumer electronics comprised 16 companies nationwide (covering regions other than Okinawa). In 1978, the Osaka, Keiji, and Hyogo Sharp Electric Companies were merged to establish Kinki Sharp Electric Company. In January 1981, twelve companies around the country—with the exception

of companies in charge of volume retailers located in Nipponbashi, Osaka, and Akihabara, Tokyo—combined with Sharp's home appliance sales promotion department to establish Sharp Consumer Electronics Co., Ltd. The result was a four-company nationwide system that also included Naniwa Sharp Electric (Nipponbashi), Tokyo Chuo Sharp Sales (Akihabara), and Sharp Electronics Sales Okinawa Corporation.

In 1977, Sharp's nationwide office equipment sales companies formed a 10-company system. In 1978, nine of these companies (with the exception of the one in Okinawa) were merged and reorganized into a two-company system consisting of East Japan Sharp Office Equipment Sales and West Japan Sharp Office Equipment Sales. Further, in December 1980, these two companies were merged with an office equipment sales company in Okinawa. In addition, the department in charge of retailers at Sharp System Products (SSP) and Sharp Corporation's Industrial Equipment Marketing Group were also consolidated to form a single nationwide company, Sharp Business Co., Ltd. (SBK).

In October 1982, the Domestic Consumer Electronics Marketing Group was set up, followed in April 1983 by the Domestic Industrial Equipment Marketing Group. Furthermore, the head office functions—which had been incorporated into the sales companies when Sharp Consumer Electronics and SBK were established—reverted to Sharp Corporation. The Domestic Consumer Electronics Marketing Group focused on planning and promoting overall marketing strategies, planning sales network (distribution) strategies, and disseminating information. The Domestic Industrial Equipment Marketing Group was made an independent organization to provide software support and expand measures to meet the product needs of the Industrial Equipment Group.

Improving Service Subsidiaries and Affiliated Companies

In March 1977, to provide a higher quality of service nationwide, Sharp System Service was formed by consolidating the service departments of Sharp's office equipment sales companies. It was established as a dedicated office equipment service company with 68 offices.

In March 1982, the 10 home appliance service companies nationwide changed their company names to Sharp XX Engineering (where “XX” was the region name). In March 1983, Sharp responded to the nationwide growth of its sales subsidiaries by consolidating the 10 service companies to form Sharp Engineering Corporation.

In March 1977, the Hayakawa Tokusen Metal Limited Partnership became a special subsidiary company of Sharp Corporation. Under a Japanese law for promoting employment of the disabled, a subsidiary employing people with disabilities was deemed to be a business facility of the parent company when assessing the parent company's rate of employing disabled persons. When Tokusen Metal began construction of new premises (i.e., a new plant), city ordinances decreed building restrictions because the site was located in a residential area. However, outreach by President Saeki to the city of Osaka and understanding from local residents—based on concern for social welfare—enabled completion of the plant in



New factory building for the Hayakawa Tokusen Metal Limited Partnership, completed with local support



Employees working in the plant (around 1982)

October 1981. In September 1982, the company was reorganized as Sharp Tokusen Industry Co., Ltd.

In October 1978, Sharp Equipment Corporation and nine equipment sales companies nationwide were merged and reorganized into two large units, one responsible for eastern Japan and the other for the western part of the country (respectively, East Japan Sharp Equipment and West Japan Sharp Equipment).

In April 1979, Sharp Electronic Specialty Equipment Sales was established, with a focus on sales of medical equipment originating from the Medical Equipment Sales Division of the Industrial Equipment Marketing Group. In December 1979, SBC Software Co., Ltd. was established as a company specializing in application software development.

In May 1982, Sharp Finance Corporation was spun off from Sharp Consumer Electronics and established as an independent credit services unit. It expanded its business scope by adding comprehensive financial services to its existing provision of financing to promote manufacturer sales. In October 1985, it merged with Sharp Kosan and expanded into other business areas, including car leasing, insurance brokerage, real estate, and travel services.

From the Service Group to the Reliability Control Group

In 1975, the Service Group changed its name to the Reliability Control Group. This change reflected a policy of ensuring the reliability of products in terms of both quality and service. The Product Reliability Control Center, Parts Center, and Service Management Division were placed under its umbrella; later, the Overseas Service Division and the Consumer Center in charge of handling customer inquiries were added.

7 Establishing the Company’s First Production Base in a Developed Country

Developing a Diverse Range of Measures for Overseas Sales

■ Trade Friction over TVs Intensifies

Despite the headwind of the Nixon Shock of 1971 and the first oil crisis of 1973, exports of color TVs made in Japan—particularly Sharp’s Z Chassis model—continued to expand. This ongoing success was attributed to the improved performance and significantly lower costs made possible by the use of ICs. However, the steep increase in exports led to new trade frictions. In May 1977, Japanese manufacturers decided to voluntarily limit exports of color TVs to the US. Beginning in 1978, exports of TVs were reduced to 60% of the previous year’s level, dealing a serious blow to color TV exports.

■ Three Measures to Cope with Trade Friction

As a response to trade friction with the US, Sharp strengthened sales of non-TV products to that country, and at the same time, it worked to build up its sales networks in regions other than the US. In addition, Sharp decided to take the bold step of launching local production there (see page 6-12).

In response to the US copier market, which at the time was focused on large machines and controlled by a small number of major manufacturers, Sharp offered compact, easy-to-use copiers. In 1981, this led to Sharp models taking the top ranking in number of shipped units in the US (based on a Dataquest [now Gartner] survey). In particular, the SF-750, then the world’s smallest and lightest copier, was highly rated.

In addition, Sharp established a solid position in the microwave oven market, armed with an abundance of products that offered high performance and low cost. In 1975, 48% of the microwave ovens made in Japan and exported to the US were Sharp products (based on Sharp research).

The oil crisis plunged the US into a recession in 1974. A hit product at this time was a Sharp two-way CB (citizen band) radio designed for in-vehicle use. Long-haul truckers purchased these units to exchange information on the locations of filling stations where they would be able to refuel. Sharp products developed a reputation for high quality, which also helped expand the market for Sharp audio/video products through the same sales channels. However, other manufacturers quickly entered the market, causing prices to fall, and the CB radio boom was soon over.

Other sales and marketing bases established outside the US included Sharp Electronics (Svenska) AB (SES)—now Sharp Electronics (Nordic) AB (SEN)—in Sweden in 1979, and Sharp-Roxy Sales & Service Company (M) Sdn. Bhd. (SRSSC) in Malaysia in 1985.

■ Deepening Ties with China

In China, Sharp participated in the Canton Fair in 1963. Then, in 1971, the company welcomed members of the Chinese Institute of Electronics (CIE) to the semiconductor plant at Tenri. Following the normalization of diplomatic relations between Japan and China in 1972, Sharp’s relationship with China grew deeper. When China’s Chairman of the State Planning Commission visited Japan in 1979 and purchased 1.2 million black-and-white TVs from 11 Japanese consumer electronics manufacturers, Sharp received orders for more than 600,000 sets. Sharp began full-fledged marketing activities in China, establishing the Beijing Office in 1981, the Shanghai Office in 1985, and the Guangzhou Office in 1986.

Sharp not only exported finished goods to China; in keeping with Chinese government policies, the company also concluded technology-licensing agreements for color TVs with five major Chinese factories in 1984. The Chinese government had been promoting its own domestic production of parts, and Sharp’s common chassis was the only such component to pass Chinese national standards. Eventually, more than 20 factories adopted this TV chassis. In the spring of 1985, a Sharp Comprehensive Technology Exhibition was held in Beijing and Shanghai. This exhibition was big news, raising Sharp’s profile in China as a comprehensive electronics manufacturer and helping to solidify Sharp’s reputation for advanced technological capabilities.

This wide range of measures in various regions of the world began to bear fruit: the value of Sharp’s exports in fiscal 1976 topped 100 billion yen for the first time, reaching 153.2 billion yen—an increase of 81.8% compared to the previous year. In fiscal 1985, exports were 577.0 billion yen, another record high.



Long lines of visitors began forming early in the morning, waiting for the doors to open at the Sharp Comprehensive Technology Exhibition in Beijing

First Consumption-Area Production Base Established in the US

■ Meeting with Top US Government Officials

This was Sharp’s first attempt at local production in a developed country. Before establishing a production base in the US, there was a need to dispel concerns that a Japanese company starting operations there would cause further trade friction between the two nations. In October 1978, President Saeki traveled to Washington, DC, and met with Vice President Walter Mondale and US Trade Representative Robert Strauss, as well as other government officials. The meetings resulted in a vote of approval, with Vice President Mondale commenting, “I believe Sharp’s investment will not only contribute to increased employment and economic development in the US, but it will also help resolve trade issues between the two countries.”

In October 1979, Sharp Manufacturing Company of America (SMCA) was established on a 356,000 m² site on the outskirts of Memphis, Tennessee, as the production division of SEC, Sharp’s US sales subsidiary. It began with production of color TVs.



SMCA was established in Memphis, Tennessee in 1979

■ High Quality Is Key to Plant’s Success

However, operation of the new plant was not smooth sailing from the beginning. Employees were so strongly motivated to achieve planned production goals that they were not focused enough on product quality. By repeating the mantra, “Quality is the lifeblood of a manufacturer,” they transformed their attitude and awareness and eventually achieved high standards of quality. As an indication of the quality of SMCA products, cumulative production of color TVs and microwave ovens reached one million units in 1981, despite the recession. The *Wall Street Journal*, a leading business and financial newspaper in the US, devoted a great deal of coverage to the factors behind SMCA’s success, including its efforts to reduce defects, the guidance given to employees and subcontractors, and the family atmosphere based on Japanese-style management.

■ Expanding Production Bases outside the US

Sharp made steady progress in building a production system that would not be affected by government policies in the countries to which it exported. In 1985, it



An ad that appeared in a local newspaper in 1989 celebrating the 10th anniversary of the founding of SMCA and expressing gratitude from the Mayor of Shelby County, Tennessee, and other local dignitaries: “Thanks for pinning your hopes on us. Sharp and the Memphis Partnership.” Clearly, SMCA had integrated well into the local community.

established Sharp Manufacturing Company of U.K. (SUKM) as the production division of SUK, the sales subsidiary in the UK. SUKM was Sharp’s first production base in Europe, and it began with production of VCRs for the European market. This move was done against a backdrop of rapid growth in the export of VCRs from Japan to Europe, which prompted the imposition of customs import regulations in 1982—for example, limiting customs clearance to only the port of Poitiers, France—and dumping complaints from European manufacturers. This in turn had led Japanese manufacturers to voluntarily restrain exports for three years beginning in 1983. Although the objective in establishing SUKM was to avoid such trade friction with European countries, it was also welcomed by the UK government and local communities for contributing to local employment and strengthening the industrial infrastructure of the area.

In Asia, in conjunction with re-export bases, Sharp also established production bases in regions where its products were consumed. In Malaysia, Sharp established Sharp-Roxy Electronics Corporation (M) Sdn. Bhd. (SREC^{*1}) in 1980 to produce color and black-and-white TVs for export markets, and Sharp-Roxy Appliances Corporation (M) Sdn. Bhd. (SRAC^{*2}) in 1985 to produce color TVs and refrigerators for Malaysia. In the Philippines, Sharp (Phils.) Corporation (SPC) was established in 1982. It produced black-and-white and color TVs for the domestic market, as well as tape recorders and washing machines for export.

*1 In 2009, SREC was merged into Sharp Manufacturing Corporation (M) Sdn. Bhd. (SMM).

*2 In 2002, SRAC terminated production activities and became an investment holding company for SRSSC.

Chapter 7 | 1986 - 1991

Three Challenges in Renovating the Business Structure Creating New Demand by Strengthening Product Appeal

Responding to the surging value of the yen following the Plaza Accord, Sharp began redefining the company's business structure under a new management team. The company created a three-pillar strategy: expanding the non-consumer electronics business, such as information/communications equipment and electronic devices; increasing the ratio of domestic sales with products that create new demand; and shifting production overseas.

Through determined efforts in these areas, Sharp transformed challenges into opportunities and put the company back on the growth track. Sharp also foresaw the potential of the LCD business and made efforts to develop LCD-based applications.

Electronic organizers and word processors became a huge success, and Sharp took a decisive leadership role in the age of information technology.

Blueprint for a refrigerator with a dual-swing door, which allows the door to open in either direction, an example of a demand-generating product

1 Chance Is Found in Changes

President Tsuji Appointed

President Saeki was convinced that Sharp was establishing a new structure that could effectively respond to changes in the business environment in the difficult climate following the Plaza Accord. On June 27, 1986, he said, "I would like to entrust management for the future to a younger generation with the faith that their creativity and agility can be effectively put to work." Saeki became the new chairman and appointed Haruo Tsuji, who had been a senior executive director, to be the new president. On June 26, 1987, Saeki retired from the position of chairman and became a corporate advisor.

President Tsuji had become a member of Sharp's board of directors in 1977 after serving as the Group Deputy General Manager of the Consumer Electronics Marketing Group and the Group General Manager of the Electronic Equipment Group. His achievements included the development of in-house production for VCRs—an area where Sharp had been falling behind competitors—and an increase in the market share for color TVs. From 1984, he had worked as the head of the consumer electronics business. He contributed to business expansion by being in charge of a wide range of operations, including production and domestic and international sales.

Upon his appointment as president, he expressed his hopeful vision. He stated that, "When drastic changes are

happening, as they are now, motivations for new technology, new products, new demand, and new culture are born. I'd like to take this positively, believing that there is a silver lining within these dark clouds." He set a company-wide slogan for the following year of 1987 as "Catch the opportunity in change and create new demand. Have a creative spirit for innovation and act upon it."



New management team with Chairman Saeki (right) and President Tsuji

Business Innovation to Overcome the Strong Yen

Starting a Strategy to Chase Two Hares at Once

In the currency exchange market, the yen quickly rose in value against the US dollar following the Plaza Accord. The value of the US dollar averaged 238.53 yen in 1985, but it decreased to 168.52 yen the following year. The effect of the stronger yen was serious for Sharp, where more than 60% of sales came from exports. Sales for fiscal 1986 fell to 90.9% of the previous year's level, and recurring profit was just 58.8% of the previous year's total. For the first time in 11 years, Sharp reported a decrease in its income and profit. It was an emergency situation.

Sharp took immediate measures to respond to these developments. First, the company elicited new ideas from all domestic and overseas divisions for emergency measures to create a system whereby the company could make a profit even if the dollar fell to 150 yen. From October 1986, company-wide efforts were initiated to revitalize the business. The plan consisted of 116 items (subsequently to be increased in quality and quantity) such as the early introduction of new products, the utilization of parts procured from overseas, and a review of expenses.

Meanwhile, Sharp began making comprehensive revisions of the business structure. The company took on a strategy of "chasing two hares at once," considering pressing issues for management while also looking at the mid to long-term future. The company created the following three-pillar strategy.

First was a shift to growth areas. While expanding the consumer electronics market, the company would also shift to technology-intensive and large-scale equipment businesses, and it would expand its business in the non-consumer electronics market with information equipment and electronic devices. The company would particularly focus on the area of optoelectronics and invest heavily in LCD technology that would become a central driving force for the company. As a result, the ratio of sales of non-consumer electronics increased from 32.6% in fiscal 1985 to 46.9% in fiscal 1990.

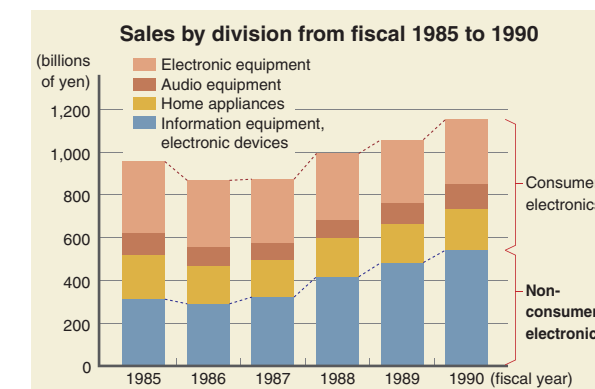

Second was the creation of brand new products and the strengthening of domestic business. The company utilized the Creative Lifestyle Focus Center (established in 1985) and worked to create high-value-added products that would create new demand, working from customers' perspectives and applying key devices. As a result,

domestic sales increased, and the company's percentage of domestic sales grew from less than 40% in fiscal 1985 to 52.3% in fiscal 1988.

Third was to establish a global production system that would not be affected by fluctuations in foreign exchange rates. Sharp aimed to increase the ratio of overseas production in overseas sales and opened and expanded production facilities in both advanced countries and developing countries to benefit from their geographical advantages. As a result, the value of overseas production in fiscal 1988 was nearly double what it was in fiscal 1985.

These efforts resulted in a recovery of sales. Sales in fiscal 1987 were up slightly (100.5%) compared to the previous year. Sales in fiscal 1988—when the yen was at its strongest for that period—were up (113.7%) compared to the previous year. Sharp was thus able to overcome the strong yen.



Sharp Appliances (Thailand) Ltd. (SATL), a manufacturing subsidiary, was established in Thailand in 1987

Implementing a Company-Wide, Comprehensive Strategy: Jump Up 80

In 1988, a comprehensive company-wide strategy—Jump Up 80—was implemented as Sharp prepared to celebrate its 80th anniversary in 1992. Considering that increasing organizational efficiency alone wouldn't raise the morale of the company, Sharp came up with bold measures for the future. The strategy called for using optoelectronics as a core technology to expand the size of the business; it also called for placing more emphasis on information and electronic devices as well as other new areas. With an eye toward the 21st century, Sharp planned to build a foundation for management that would maintain double-digit annual growth even after the company achieved the one trillion yen annual sales milestone.

In the late 1980s, Japanese companies utilized the deregulation of financial markets and strengthened corporate financing. Sharp issued domestic convertible bonds and bonds with warrants in US dollars to raise finance of about 98.9 billion yen in 1987 and 173.9 billion yen in 1989. Helped by a bull market in shares, the company increased its ratio of self-capitalization to 49.8% at the end of fiscal 1991, up 11.2 points from fiscal 1986. Sharp also issued commercial paper (CP)* to raise capital for the short term and reduce finance costs.

* Commercial paper (CP): A discount style of promissory note that leading corporations issue in the open market for short-term financing. Promissory notes have now been entirely replaced by a paperless electronic CP (short-term bond).

2 Aiming to Strengthen Corporate Culture

Restructuring the Sales System Responding to the Popularity of Office Automation Products

Around this time, office automation (OA)* was spreading rapidly in Japan, and large-scale consumer electronics stores carried more and more of these products. To respond to this change, Sharp consolidated the separate marketing groups for consumer electronics and information equipment into one organization in 1986.

In January of the following year, the PA products* and copier divisions of Sharp Business (SBK) and Sharp Consumer Electronics were merged to become Sharp Electronics Sales Corporation (SEH). This was done partly to improve responsiveness in distribution. Meanwhile, in the OA products area, Sharp System Products (SSP) and Sharp Electronics Specialty Equipment Sales were integrated into the remaining divisions of SBK, and the combined business was restarted under the new corporate name of Sharp System Products Co., Ltd.



Videos were used to provide product information on a regular basis

The domestic marketing division focused on improving the dissemination of information to dealers. They supplemented the existing *Sharp News* periodical with audio-visual information tools that could be used to present product information in a vivid, lively manner.

In April 1987, the Information Communication Marketing Group was established to be in charge of dealing with governmental agencies, large corporations, and Nippon Telegraph and Telephone Corporation (NTT). In June 1988, in addition to the existing OEM orders from NTT branch offices, Sharp received an order from NTT's headquarters. Following that, the weight of sales for communication devices started growing rapidly within the Group.

Additionally, in public relations activities, Sharp increased its involvement as a sponsor in international soccer games and at the Asian Pacific Awards—an event honoring distinguished books in Asia and hosted by Mainichi Newspapers Co.

Measures to Bring Out the Talents of Employees

■ New Personnel Evaluation System, Valuing “People”

Seeing that people would be the key to dealing with the difficult business climate prevailing in the late 1980s, Sharp developed a new personnel system.

In 1988, the company implemented an internal application program where employees could tackle areas that the company was pursuing. The program was designed to advance the company's goal of placing appropriate talent on important and pressing work, while meeting the needs of employees wishing to take on a new and interesting challenge. In 2000, it became a permanent program under the name of the Open Recruitment System.

In 1987, Sharp started an overseas trainee program to train employees to be ready to perform on a global stage. Trainees were sent to Sharp's overseas subsidiaries, to language schools, and to major universities such as the Massachusetts Institute of Technology. In 1988, Sharp started a program to send employees for a limited time to organizations inside and outside the company, so that they could gain a wider range of knowledge and cultivate networks of people in various fields. When sent outside the Sharp Group, the employees were sent to research institutes, universities, companies in other industries, and companies overseas, to acquire knowledge and information that couldn't be acquired inside the company. In 1991, a career development rotation program was implemented. This provided young employees in the administrative and marketing fields with opportunities to experience different jobs and workplaces and to develop a wider perspective.

A new personnel evaluation system, based on the CM (Creative Management) program, was implemented in 1989. It was a unique personnel evaluation program where employees had an interview with their superiors to set goals and evaluate their performance. The evaluations not only served as criteria for determining raises and promotions, but they also helped to develop individual capabilities and increase motivation.



Sharp supported the self-improvement of employees through the Saturday Technology School (started in 1984) and the Saturday Business School (started in 1985)

■ Company-Wide Small-Group Activities Become CATS Activities

In 1989, Sharp started a facility-maintenance program, TPM (Total Productive Maintenance), to be participated in by all employees. In 1990, TPM and the small-group activities by quality-control circles were integrated into the Sharp CATS (Creative Action Teams) program. The name symbolized the creative and agile nature of the small-group activities. CATS identified issues in the workplace and held activities to address these issues and raise the quality of work.

Product Development by Listening to the Voices of New Consumer Leaders

■ Establishing the Creative Lifestyle Focus Center

In April 1985, the Creative Lifestyle Focus Center was established based on the idea of then-Senior Executive Director Tsuji. The center would gather the diverse voices of consumers to understand their purchasing patterns accurately in order to develop new types of products. Tsuji focused on the trend of individualism in consumer leaders' thinking and how it affected the preferences of people. He presented the idea of “personal appliances” as opposed to conventional “home appliances.”

The company began a program of studying about 500 highly lifestyle-conscious consumers to better understand user trends. The program was designed to analyze their lifestyles and product needs through group interviews and other means.

The Creative Lifestyle Focus Center was upgraded to the Creative Lifestyle Planning Group and the organization further enhanced in April 1991.



A meeting at the Creative Lifestyle Focus Center (1985)

■ Introducing the U's Series

As more women were participating in the workforce, the needs increased to make housekeeping more efficient and to make better use of time and space. Sharp discovered the needs for “new necessities” through lifestyle surveys and developed a product line called the U's series. One survey showed that, although many time-conscious working wives were already using toaster ovens regularly, they were not familiar with microwave ovens. From these results, the company got the idea for a combined toaster/microwave oven, the RE-102. It was well received, as it saved both space and cooking time.

The first products from the U's series introduced in September 1986 were the RE-102 and the SJ-30R7 “cooking” refrigerator that had a built-in microwave oven. Sharp also launched the “ist” series for the new mature generation who



The RE-102 was a microwave oven with a toaster oven function. It could defrost frozen food, warm it up, and bake it quickly. Its low height allowed for a compact size that could fit on a dining table.

sought quality and real value.

These were examples of Sharp's efforts to capture and analyze the characteristics of people's changing lifestyles and behavior, so that the company could develop unique products.

■ Introducing Unique, Industry-First Products

In January 1989, Sharp introduced the revolutionary SJ-38WB, a refrigerator with a dual-swing door that could open to the right or left—the first in the industry. The mechanism of the door for this product was born from an idea of an engineer who was inspired from seeing his wife's brooch. He applied the idea from the mechanism of



The SJ-38WB was a refrigerator with a dual-swing door that could open in either direction. When the door was being opened, the locking mechanism on the opening side turned to release, but the other side remained locked.

the turn stopper that keeps the pin of the brooch from releasing. Using this insight, he persevered until he achieved the new design.

In 1987, Sharp released the ES-X1 washer/dryer, which incorporated a washing machine and a dryer in one unit. And in 1991, the company introduced a fully automatic washing machine, the ES-B750, which used air bubbles to clean—a world-first. The air bubbles effectively dissolved the detergent, improving the washing power and reducing the unevenness of the washing.

In the area of color TVs, Sharp introduced high-value-added products with large screens and outstanding picture and sound quality to support authentic audio-visual experiences. Sales at large-scale consumer electronics stores, where Sharp was strong, increased. Sharp's share of domestic TV sales grew from 2.7% in 1981 to 15.5% in 1987, making it number two in the industry. (Source: *Japan's Television Industry: The Structure of Its Competitive Superiority*, by Atsushi Hiramoto)

In December 1990, Sharp introduced the VC-BS50, a VCR that had a vacuum deposition head and enabled users to enjoy high-quality images even when playing back in extended play (3x) mode.

* OA stands for Office Automation and means products such as word processors and fax machines that make paperwork efficient by automation. PA means the personal version of OA products, targeting individual consumers.

3 Promoting Multimedia for Personal Use

Development of Electronic Organizers

■ IC Cards Instead of Refill Pages

At a time when organizers (i.e., day planners) with refillable pages were popular, Sharp began developing an electronic version of the organizer that used IC cards to expand its capabilities.

A prototype was completed in July 1986, but its commercialization was delayed. Since it could display only *katakana*, Sharp deemed it insufficiently user-friendly. After further development, the world's first *kanji*-capable electronic organizer, the PA-7000, was introduced in January 1987. The PA-7000 also had five personal information management functions: a calendar, a scheduler, a memo function, a phone book, and a calculator.

With IC cards to expand functionality, users could add functions they wanted, such as a dictionary or English conversation guide. The organizer drew rave reviews for its ability to display *kanji* and became a huge success. With the aid of sales promotion efforts, it sold 500,000 units in a single year.

■ “Bware” Intellectual Information Tools

In 1988, Sharp commercialized a series of mobile information tools, including electronic organizers, under the brand name of Bware (“Business Ware”). These products were targeted at businesspeople living in an information-intensive society and wanting to utilize that information anytime and anywhere—whether they were on the move or at their destination of the day.

Initially, Bware products used IC cards that were developed by Sharp. But the company made the source code for the devices open to the public, so that software companies and publishers could develop and sell their own content. Sharp also introduced the Program BASIC Card to enable retailers and general users to create their own applications. Sharp electronic organizers were received so



Sharp electronic organizers steal the show at the 1987 Data Show in Tokyo

well that by August 1990 total shipments in Japan had reached four million units.

Evolution of the Japanese Word Processor

In the beginning, the process of inputting text in a *kana-to-kanji*-converting word processor required inputting by clause. The converter often suggested inappropriate *kanji* characters, as there are many combinations with the same pronunciation. In order to solve this problem, Sharp designed a connected-clause conversion method that suggested *kanji* characters based on an evaluation of the content of the surrounding clauses. In the case of the word “warm,” it could change the suggested *kanji* character depending on whether it was connected to “room” or “food.” Further, the company developed an artificial intelligence (AI) dictionary—which included about 40,000 examples—to increase the accuracy of the connected-clause conversion.

In May 1987, Sharp introduced the WD-540 word processor, which was loaded with the AI dictionary. This was followed in the same year by the introduction of the WD-820, which featured a large backlit DSTN LCD, and the WD-850, which had the industry's first large EL display. In 1988, Sharp introduced a laptop word processor, the WV-500. To achieve the smaller and lighter design of this model, the word-processor section was separated from the printer.

In May 1989, Sharp's cumulative production of word processors reached two million units. Sharp continued to fulfill customer expectations by introducing new products, one after another. In 1990, the company released the WD-A340, which included Super Outline Fonts that could be printed beautifully regardless of font size. In 1991, a business-use word processor, the WD-SD70, was introduced. It had a 17-inch LCD screen that could be oriented either vertically or horizontally for better visibility.

The WD-A340 offered quality nearing that of printed type thanks to built-in Super Outline Fonts and a 64-dot 400-dpi high-resolution printer



Creating New Style for Telephones

Facsimiles

With plateauing demand for facsimile machines in the business market, Sharp shifted focus to the home market. October 1990 saw the introduction of the UX-1, which was made to be as small, thin, and light as possible and which could be set up beneath a telephone. The model's nickname, Illustalk, reflected Sharp's effort to promote sending illustrations by facsimile as a fun new way of communicating. Advertised with the catch phrase, “A better way to communicate than words,” it was well received and helped popularize home use of facsimiles.



The UX-1 was a stylish home-use fax that redefined information equipment (phone sold separately)

Telephones

In April 1985, NTT was privatized, and the market for telephone equipment was opened up. Responding to this change, Sharp established the Communication Audio Division inside the Audio Systems Group. The following year, the company introduced an answering machine.

Next, Sharp entered the cordless phone market. Cordless phones were divided into two types—the ultra-low-power type (for communication distances within 10 meters) and the low-power type (for communication distances within 100 meters). Sharp introduced the ultra-low-power CJ-S30 in December 1987 and the low-power CJ-S100 in April 1988. The latter was priced at 89,800 yen—significantly lower than the prices of competing models—as Sharp had made the key components in-house and had automated its production. Later, Sharp focused on the low-power type that could provide more stable communication.

In September 1989, the company introduced the industry's first low-power cordless phone with an answering machine, the CJ-A300. It was developed in just six months through cooperation between the development teams for cordless phones and answering machines. In April 1991, Sharp's cumulative production of cordless phones reached two million units. The expansion of the business was extremely fast.



The CJ-A300 could control answering machine functions via the handset and make calls from the base unit, which was not possible on previous models

Efforts in Computer Products

Scanners

In July 1986, Sharp introduced a desktop-size high-precision color scanner, the JX-450. It became popular in the design and fashion industries, gaining status as the global standard.

Copiers

In 1989, Sharp introduced its first full-color copier, the CX-7500. The year 1991 saw the release of the SD-2075, a high-speed copier that could output 76 copies per minute with air paper feeding and a form feeder function. In fiscal 1991, the worldwide production of Sharp copiers reached 500,000 units a year and cumulative sales surpassed 3.6 million units.

System Products

In the POS terminal market, the RZ-5100 series (for gas stations) increased efficiency for software development by using a multitasking general OS. Sharp also released the RZ-5800, which could handle bar-code input. In the handy terminal market, the RZ-5550, with a touchscreen LCD, and the RZ-5541R, with wireless communication capability, were commercialized in rapid succession.

PCs

In March 1987, Sharp introduced the X68000 series, which had evolved out of the X1 PC-TV. Natural color graphics—with 65,536 colors—and superb sound quality suited for games made this product popular for personal use. It was supported in particular by dedicated fans and remained popular even after sales ended. In July 1988, the AX386 was released, featuring a high-resolution display. This model was an AX (architecture extended) PC based on common specifications developed by a consortium of Japanese electronics companies. Sharp enhanced its PC lineup by introducing models such as a laptop type and a laptop type with a color LCD.

English-to-Japanese Translation System

Sharp succeeded in developing an industry-first, English-to-Japanese translation system for minicomputers and exhibited it at the Business Show in Tokyo in 1985. In September 1988, the DUET E/J was introduced. Onboard AI technology enabled it to achieve high-level semantic/language processing. It could also automatically read English text through optical character recognition (OCR).

School Education Support System

In 1984, Sharp began developing an education support system for elementary schools and junior high schools in cooperation with, among others, Professor Kazuhiko Nakayama from the University of Tsukuba. Initially, the system comprised mainly hardware; but positive feedback about the system prompted the development of software that could be used for other manufacturers' PCs. Thus, Sharp System Products (SSP) developed classroom/learning support software that utilized networks and supported the creation of teaching materials. This software was introduced in 1990. With schools moving forward in response to the information age, sales increased and the business expanded.

4 Positioning LCDs as the Core Business

Strengthening Development and Production Systems for LCDs

■ Establishing the Liquid Crystal Display Division

In 1985, Sharp succeeded in creating a prototype for a 3-inch LCD color TV. The final decision was made to build a plant for thin-film transistor (TFT) LCDs and the company organized a Sharp Taskforce to study methods for mass production. Manufacturing of TFTs is similar to that of LSIs in terms of the construction of transistors. Initially, the company considered building a facility for a 6-inch (15 cm) wafer size, which was the standard for LSIs at that time. However, Sharp was aware from its experience in manufacturing LCDs for electronic calculators that creating multiple panels from a single glass substrate was important in terms of cost efficiency. Therefore the company insisted upon using the larger A4 size (14.3 inch [36 cm] diagonal) glass substrates that had been used for production of passive-matrix (duty) LCDs. Sharp had also heard about the prospects for development of a large exposure device suited to this purpose, and it made the decision to use the A4-size substrates.

In 1986, Sharp exhibited a 3-inch TFT LCD TV with about 92,000 pixels at the Japan Electronics Show in Tokyo. The high image quality, which had not existed previously, drew a great deal of attention.

■ Thoroughly Examining the Potential for LCD Application Products

As well as further developing LCDs themselves, Sharp extensively reviewed the potential of products utilizing LCDs. For example, the company considered new products such as in-vehicle TVs and projection TVs. Sharp made the decision to utilize LCDs to open up business areas with new products while developing the LCD business itself, following a corporate strategy based on uniqueness, social contribution, and feasibility.

In January 1986, the LCD department was upgraded to the Liquid Crystal Display Division—an indication of the company's determination to focus on LCDs. At the TFT LCD plant, efforts were made to improve the efficiency rate and the quality of production. In October 1987, Sharp released the 3C-E1 3-inch LCD color TV.

■ Development of the 14-Inch Color TFT LCD

In the process of establishing production technology for 3-inch LCDs, Sharp also took on the challenge to create a 14-inch LCD, utilizing the entire glass substrate. The company decided to investigate how well the thin film would form and to see if there would be defective transistors created in making a large TFT LCD panel using the entire surface of the glass substrate. In the initial stages, the efficiency rate for 3-inch LCDs was low and



The 14-inch color TFT LCD was a sensation at the Japan Electronics Show in 1988

the success rate for 14-inch displays was close to zero. Sharp continued to try different approaches, such as using multiple wiring to the pixels or dividing the pixels into four and using multiple transistors. Finally, Sharp's first prototype 14-inch color TFT LCD was completed in 1988. The 14-inch size was the best-selling size for portable CRT TVs; this new LCD had the same screen size but with amazing dimensions. It had a thickness of just 27 mm—one-thirteenth as thick as a conventional CRT TV—and it weighed just 1.8 kg. This success cemented Sharp's decision to begin full-scale operation of a large-size LCD business; in 1989, the company started building a large-size TFT LCD production line (the NF-1 line) at the Tenri Plant. The company also decided to build a plant in Mie Prefecture. In April 1990, the Liquid Crystal Display Division was upgraded to the Liquid Crystal Display Group.



The LCD plant in Tenri, where large, high-quality TFT LCDs were efficiently produced

■ Establishment of the DSTN Passive-Matrix LCD Business

STN (super twisted nematic) LCDs were used for the first time in the WD-250 word processor, which was released in 1986. It offered good contrast, but the yellow-

green cast of its display made onscreen objects look quite different to those printed on paper. The company therefore aimed to produce a "paper-white" display by eliminating the color cast. In order to accomplish that, the LCD was overlapped in two layers to reverse the light twisting. Beyond merely creating this structure, Sharp's research extended to examining around 2,000 different liquid crystal materials and the effects of polish quality on the LCD glass. In the end, Sharp succeeded in developing DSTN (double super twisted nematic) LCDs, which appeared "paper white." In 1987, DSTN LCDs were used for the WD-820 word processor. The model's easy-to-view display played a large part in helping Sharp to increase its market share.



The WD-820 word processor had a revolutionary easy-viewing "paper-white" display



Display of conventional STN LCD

In 1987, Sharp's yearly shipments of word processors surpassed 500,000 units. In 1988, the company succeeded in creating a color version. Duty LCDs, which were increasingly being used for office automation products, became a driving force for the LCD business.

Developing Ever More LCD Application Products

■ Debut of the LCD Projection System

Sharp proceeded to aggressively develop LCD application products. LCDs became widely used for the displays on information products such as word processors and electronic organizers, as well as on phones, copiers, VCRs, humidifiers, and many other products. This contributed to the improved operability of the products.

In 1989, Sharp introduced an LCD projection system—the XV-100Z—that made it easy to create a 100-inch display. Offering a dynamic visual experience at home, this product received the grand prize at the 1989 Nikkei Outstanding Products and Services Awards. SEC, Sharp's sales company in the US, actively engaged in sales promotion by touring the country with a XV-100Z loaded on a large trailer to create a mini theater.

Meanwhile, Sharp introduced the VL-C860 video camera with a color LCD viewfinder—an industry first. The viewfinder was different from conventional black-



Home theater with the XV-100Z LCD projection system

and-white viewfinders, as users could identify objects by color. Customers reported their satisfaction at being able to, for example, identify their child at a school sports festival. The video camera had a high resolution of 70,400 pixels per inch, achieving both high contrast and detailed image quality.

Sharp also introduced the AX386LC color TFT LCD laptop PC in 1990.

■ Creating the World's First Wall-Mount TV

In 1991, Sharp introduced the industry's first wall-mount TV, the 9E-H series. It utilized the largest screen in the industry at that time, an 8.6-inch color TFT LCD. It was stylishly designed to enhance interior décors, and the media reported that the "dream wall-mount TV has finally arrived."

The production value of LCDs was only 8.9 billion yen in fiscal 1986 when the Liquid Crystal Display Division was established. Following that, the markets for LCDs and LCD application products both grew and reached 180 billion yen in fiscal 1993. In short, the LCD business had grown by 20 times in just seven years.



The industry's first wall-mount TV, the 9E-HC1

5 Confidence in Optoelectronics

Advancing in the Optoelectronic Device Business

In 1988, Sharp made it clear in its basic corporate policy that it intended to become a comprehensive electronics company with optoelectronics as its core technology. The company had already achieved a large market share in optoelectronic devices in Japan.

Around this time, there was a widespread increase in technologies that could process high volumes of information using light—for example, fiber-optic communication devices and compact discs. Also, the market for LCDs was growing fast.

■ Advancing in Lasers

In 1981, Sharp began mass production of laser diodes for pickups (readers) used in CD players. The company reportedly achieved an 80% market share for laser diodes installed in CD players released in 1982.

The company endeavored to develop a new method of growing crystals—the vapor deposition method*—that would increase power output and productivity. In 1987, Sharp developed the low-current quantum well laser. The following year, Sharp developed a hologram laser unit in cooperation with Philips International B.V. of the Netherlands. This new product was made by housing together in a single package the laser element (the light-emitting part)—which had previously been an independent device—and the signal-reading element (the light-receiving part). This product made it easier to assemble pickups and also reduced the process of optical adjustment after assembly, contributing to lower costs and smaller product sizes. Sharp increased its market share in lasers.

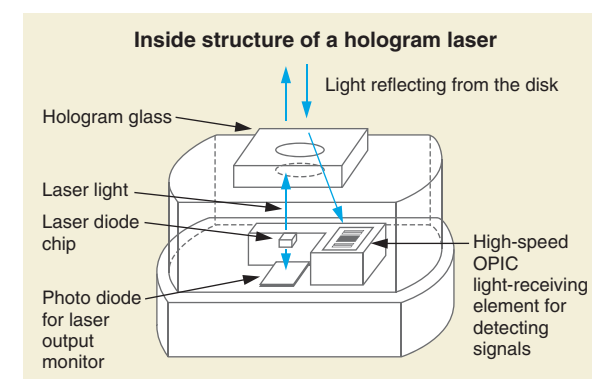

■ Progress in LED/EL

LED

Sharp developed an ultra-high-luminance, 5,000 mcd (millicandela) LED lamp in 1987, expanding the application of LEDs to electronic billboards, tail lights for automobiles, and other uses.

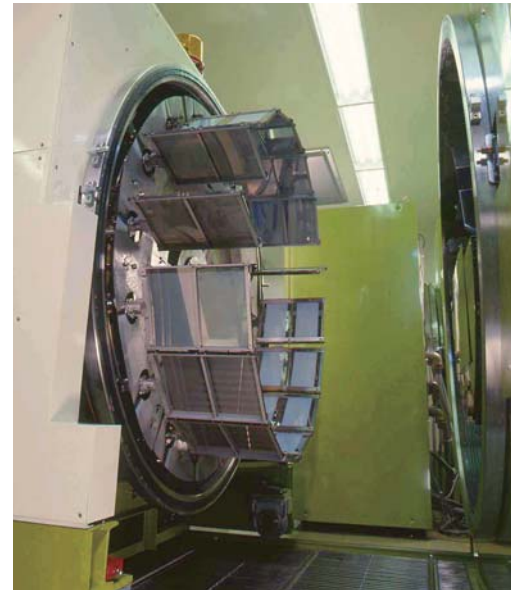

EL panel deposition device that put a thin film coating on a glass substrate by high-temperature vacuum deposition

Inorganic EL

Sharp overcame the issue of service life in the development of thin-film electroluminescence (EL) technology, to make it suitable for practical applications. Sharp's 10-inch display from 1987 achieved high image quality and low power consumption not found on CRTs. The company made progress in utilizing it for factory automation (FA) products and other applications. In 1989, Sharp also developed an EL display capable of processing handwritten text that users could input as if they were writing on paper. This was achieved by simultaneously detecting the coordinates of the stylus pen and displaying input on the EL panel. In 1988, Sharp was awarded the Karl Ferdinand Braun Prize from the Society for Information Display (SID) for pioneering the development of stable, high-luminance thin-film EL displays.

■ Steady Growth in RF (Radio Frequency) Components and Mask ROM Business

Sharp developed a DBS tuner for satellite broadcast receivers. Its reliability and functionality were regarded highly and many orders came in from Europe, North America, and other areas. In the mask ROM business, the company responded to the needs of videogame and OA product manufacturers for higher speed, larger storage capacity, and faster delivery. In 1994, the company's domestic market share reached 41.9%.

Technological Advances in Solar Cells

■ Progress in Conversion Efficiency

The biggest issue for solar cells is the power generation cost, and improvement of conversion efficiency to reduce this cost has long been a challenge in the field.

In 1989, Sharp achieved a practical conversion efficiency of 17.1%—the best in the world at the time—for terrestrial-use monocrystalline silicon solar cells, and in 1991 it achieved a 20.4% conversion efficiency at the research level. This was made possible by bringing together a number of advanced technologies, including thin-film control technology to improve absorption of surface light; optical diffusion control technology to efficiently convert absorbed light to electrical current; and technology for maximizing efficiency in the formation of the back-side aluminum electrodes that prevent light from going through the back of the solar cell.

For the cheaper-to-produce polycrystalline type of solar cell, Sharp worked on improving conversion efficiency by developing technology for sandwiching a layer of stabilized SiO₂ (silicon dioxide) on the surface of the solar cell and creating a reflection-prevention film.

■ Solar Cells in Action around the World

Leading the industry in terms of conversion efficiency and other aspects, Sharp's solar cells contributed to people's lives in various places. Three solar power generation plants were installed in Thailand in 1986, supplying electricity to 240 households in three off-the-grid villages and greatly pleasing the 2,500 residents. These power generation plants were installed with grant assistance from the Japanese government. For space missions, Sharp's outer space solar cells were adopted for satellites such as the Fuji in 1986 and Kiku No. 5 in 1987.

Expansion of Device Sales

■ Sales Promotion Activities for Devices

Laser diodes strengthened Sharp's brand power in electronic devices. In order to further boost the brand and gain more orders, Sharp held its first electronic

components trade show in the Tokyo metropolitan area in 1987, with the exhibit centered on IC-related products—such as CCDs, microcomputers, and memory devices—along with other unique products such as LEDs and color LCDs.



An electronic components trade show was held at Sharp's head office as well

■ Urged to Purchase Foreign Products

In 1985, the Japanese government requested industry to increase imports and this called for the increased utilization of imported semiconductors. Sharp held a joint exhibition with foreign semiconductor manufacturers in 1989 to promote sales of imported semiconductors.

This exhibition contributed not only to the increased sales of new components but also to the exchange of technical information, benefiting both foreign semiconductor manufacturers and Sharp.

* The vapor deposition method is a method of growing crystals on a substrate surface by condensing the vaporized form of the material.

Columbus Sails the Nation Promoting Sharp

For 18 months starting in June 1988, the Sharp Columbus, a 2,800-ton ship, visited a total of 72 ports around Japan including Kobe and Yokohama and was boarded by a total of 1.37 million people.

Inside the Columbus, visitors could experience Sharp products like high-definition TVs, EL displays, and laser diodes, and see lifestyle/office-style exhibits featuring the latest models of Sharp audio-visual and office equipment. Everywhere the ship docked, it was enthusiastically welcomed by harbor masters and local mayors. About 600 media organizations came by to do stories on this Sharp promotional vessel.

Also at each port of call, Sharp held negotiations with dealers and joint sales exhibitions for customers, making the tour an excellent opportunity to sell Sharp products.



The Columbus (top) and a bustling product exhibit inside (bottom)

6 Seeking the Best Locations for Production and Sales

Enhancing the Network of Sales Bases

■ Taking on a Difficult Environment in Production and Sales

The Plaza Accord on September 22, 1985 triggered a sudden and dramatic increase in the value of the yen. However, that change didn't fix the US trade deficit with Japan, and trade friction between the US and Japan didn't subside at all. In 1986, the two countries reached an agreement on the trade of semiconductors. In the following year, the US enacted a 100% tariff on color TVs and PCs, claiming that Japanese companies had violated the agreement. Affected by these developments, Sharp's exports in fiscal 1986 decreased to about 80% of those in the previous year. In 1989, the Japan-US Structural Impediments Initiative was held to correct trade imbalances. Similarly, European markets moved to restrict imports of products such as VCRs. Under these difficult circumstances, Sharp made progress in production and sales based on a concept of the "best locations for production and sales."

In Europe, where the integration to the European Union (EU) was set to commence in 1992, Sharp bid to improve its market responsiveness by adding six new sales organizations—making nine sales subsidiaries in nine countries. In 1990, the company established a financial subsidiary, Sharp International Finance U.K. Plc. (SIF) in the UK. By managing financing for the European subsidiaries in one place, Sharp minimized the negative impact of currency exchange fluctuations and effectively raised and managed funds.

In the US, Sharp released a new product, the facsimile, in 1985. Starting from 1987, it kept the top market share for 11 consecutive years (based on a Dataquest survey). The company also kept the top market share for 11 consecutive years in the sales of microwave ovens, starting from 1990 (based on a Trendata survey).



In developing a network of dealers for office products and communication equipment, Sharp expanded the market for business-use facsimiles. (Photo shows FO-800 fax)

Sharp also established new sales bases in the Asia and Pacific regions and continued to improve its product and marketing strategy to fit the needs of the regions.

Further, in February 1987, the Overseas Business Group, product divisions, and overseas sales subsidiaries held their first joint product strategy and management policy review. Lively discussions were held regarding sales plans, marketing initiatives, and trade issues.



The first product strategy and management policy review was held in 1987. Six sales companies from overseas (SEC, SEEG, SECL, SCA, SUK, SRS) participated.

In 1988, a new in-company English-language periodical called *We're Sharp* was launched to keep close communication with employees and their families at manufacturing and sales subsidiaries around the world. A Chinese edition has been published since 2004.

■ Company-Wide Efforts to Increase Imports

In August 1985, Sharp established an import company, Sharp Trading Corporation (STC). In that year, the Ministry of International Trade and Industry (now METI) took measures to adjust Japan's balance of trade surplus by asking 60 major companies to increase their imports of products. Through STC, Sharp made company-wide efforts to increase the number of items imported—including components and products made at Sharp's overseas bases, as well as general consumer goods—while increasing sales volume in order to stabilize and develop overseas operations. As a result, imports by Sharp surged from approximately 4.3 billion yen in fiscal 1984 to 29.8 billion yen in 1991. The company created a virtuous cycle by connecting with overseas markets more tightly through imports and exports.

Localization of Production Facilities

Sharp's company-wide plans were formulated in line with a division of production facilities into two categories: production facilities for local consumption (where the primary purpose was sales in that country or region) and production facilities for re-export (where the primary purpose was for export to third countries).

■ Efforts to Become Part of the Local Community

In markets in Europe and North America, the focus was to ease trade frictions while continuing to secure the company's position in those markets. The company also made efforts to contribute locally by hiring local staff.

SMCA in the US began production of PCs and LCD projectors in addition to microwave ovens and color TVs. SMCA's microwave ovens were also exported to Europe. As a result of progressive improvements in quality control (QC) and streamlining and automation of manufacturing, the cumulative number of color TVs and microwave ovens manufactured by SMCA reached 10 million units in November 1988, in just eight or so years following the company's establishment.

Sharp developed production facilities in Europe as well, but Japanese companies (including Sharp) were criticized by EU nations claiming that they performed the value-added process in Japan and then merely had the products assembled in Europe. Responding to this, Sharp strengthened local design technology divisions and made efforts to increase the portion of locally procured components.

SUKM in the UK began manufacturing electronic typewriters, copiers, and CD players—in addition to VCRs and microwave ovens—and expanded its business by exporting to EU nations. SUKM was awarded the 1990 Queen's Award for Export and Technology in recognition of its contribution to increasing exports from the UK. It was rare for a foreign company that had been in operation for less than five years to receive the honor. It became big news, with SUKM receiving a lot of praise.

■ Active Enhancement of Re-Export Bases

Re-export bases, mostly in Asia, were expected to bring two benefits. By replacing exports from Japan, they helped to ease trade friction. They also helped to establish a system where profits could be made even with the strong yen. Actively enhancing re-export bases enabled Sharp to secure an inexpensive but excellent workforce and procure high-quality materials at lower costs. Sharp was able to dramatically increase its competitive position in terms of pricing. SREC in Malaysia was even awarded the 1987 Export Achievement Award from the Malaysian government for its contribution to the growth of the country's industry. Sharp was responsible for 14% of Malaysia's exports of electric and electronic products and was seen as an industry leader in that country.

Sharp also established Creative Lifestyle Focus Centers in the US in 1986 and in West Germany in 1987 to expand its development of lifestyle-based products, which had been achieving strong results in Japan. The company researched the needs of local markets and worked both to develop new products locally and to redevelop mature products.



The ultra-thin VL-50C video camera, developed at the US Creative Lifestyle Focus Center

Sharp overseas manufacturing and sales bases established between 1986 and 1991
(Business activities are those at time of establishment)

| Year | Company name | | Country or region | Business activities |
|------|--------------|--|-------------------|---|
| | ● | ◆ | | |
| 1986 | ● | Sharp Electronics (Schweiz) AG (SEZ) | Switzerland | Sales of office equipment |
| | ● | Sharp Electronics GmbH (SEA) | Austria | Sales of consumer electronics and office equipment (incorporated into SEEG in 2004) |
| | ● | Sharp-Roxy Sales (Singapore) Pte., Ltd. (SRS) | Singapore | Sales of consumer electronics and office equipment |
| | ●◆ | Sharp Electrónica España S.A. (SEES) | Spain | Manufacture and sales of color TVs, sales of consumer electronics |
| | ◆ | Sharp Electronics Taiwan Co., Ltd. (SET) | Taiwan | Manufacture of electronic tuners (business stopped in 2008) |
| 1987 | ◆ | Sharp Appliances (Thailand) Ltd. (SATL) | Thailand | Manufacture and sales of microwave ovens and refrigerators |
| | ● | Sharp Electronics (Singapore) Pte., Ltd. (SESL) | Singapore | Supply of components and kits for Sharp manufacturing bases |
| | ● | Sharp-Roxy (Hong Kong) Ltd. (SRH) | Hong Kong | Sales of consumer electronics and office equipment |
| 1988 | ● | Sharp Corporation of New Zealand Ltd. (SCNZ) | New Zealand | Sales of consumer electronics and office equipment |
| | ◆ | Sharp Precision Manufacturing (U.K.) Ltd. (SPM) | United Kingdom | Manufacture of precision press components (business stopped in 2005) |
| 1989 | ◆ | Sharp Manufacturing France S.A. (SMF) | France | Manufacture of copiers and facsimiles |
| | ● | Sharp Thebnakorn Co., Ltd. (STCL) (Name changed to Sharp Thai Co., Ltd. [STCL] in 2007) | Thailand | Sales of consumer electronics and office equipment |
| | ●◆ | Kalyani Sharp India Ltd. (KSIL) (Name changed to Sharp India Limited [SIL] in 2005) | India | Manufacture and sales of color TVs and VCRs |
| | ◆ | Sharp Manufacturing Corporation (M) Sdn. Bhd. (SMM) | Malaysia | Manufacture of VCRs |
| 1990 | ● | Sharp Corporation (Taiwan) (SCOT) | Taiwan | Sales of consumer electronics |
| | ● | Sharp Burotype Machines S.A. (SBM)* (Name changed to Sharp Electronics France S.A. [SEF] in 1991) | France | Sales of office equipment |
| | ● | Sharp Electronics (Italia) S.p.A. (SEIS) | Italy | Sales of consumer electronics |
| 1991 | ● | Sharp Electronics Benelux B.V. (SEB) | Netherlands | Sales of office equipment |

The year of establishment is the year the company was registered. * For SBM, it is the year Sharp acquired a local dealer and made it a sales subsidiary.

What are optoelectronics devices?

Optoelectronic devices—semiconductor components that combine optics and electronics—have played a major role in the development of an advanced, information-based society thanks to their ability to communicate, store, and convert large volumes of information quickly and accurately. They consist of light-emitting and light-receiving elements, and they are available in numerous variations of purpose and function. Sharp began dedicating resources to research in this field early on and established a lead in the global market thanks to technological advantages in terms of products and manufacturing techniques.

Developing along with Application

Products: Optoelectronic Devices

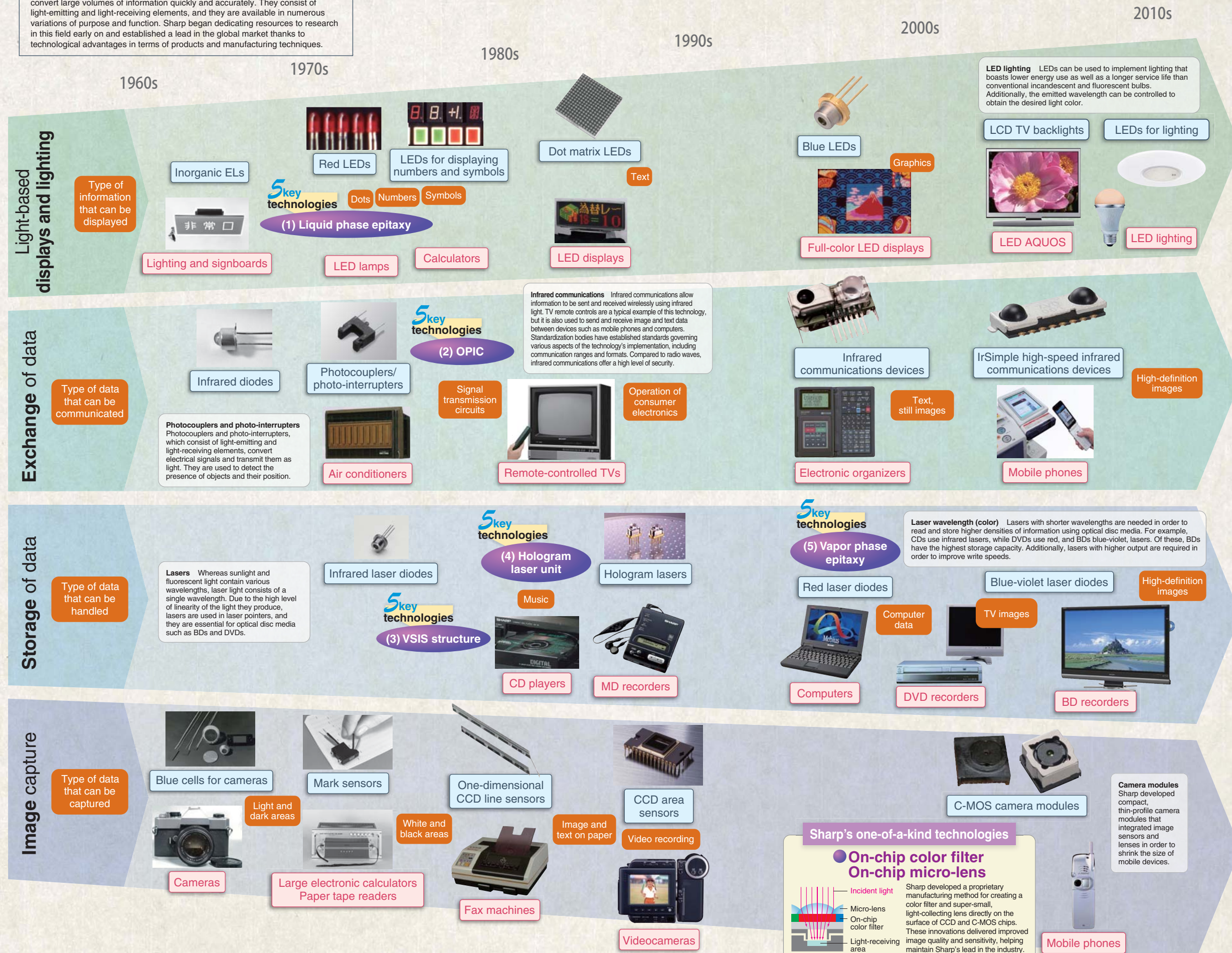

Sharp's One-of-a-Kind Technologies That Bolster Its Lead in Optoelectronics



1 Liquid phase epitaxy (Manufacturing technology)
 This method for forming light emitter p-n junctions at the same time as crystal is grown allows growth of extremely high-quality crystal. Sharp's patents in the area of crystal growth propelled the company to a leading position in the industry.

2 OPIC (optical IC) (Product technology)
 OPICs integrate a light-receiving element and signal processing circuit onto a single chip. Integration with an IC reduces the effects of external interference and allows output signals to be directly linked to a microcontroller. The design was instrumental in the development of more compact, more reliable, and more inexpensive devices.

3 VSIS structure (V-channeled substrate inner stripe) (Manufacturing technology)
 The creation of a V-shaped groove on a P-type gallium arsenide substrate allows the formation of a series of thin layers, providing stable laser light with a long service life.

4 Hologram laser unit (Product technology)
 A hologram laser unit incorporates a light-emitting laser element and a light-receiving signal-reading element into a single package. In addition to allowing more compact pickups, the design is distinguished by its reduction of the need to perform optical adjustment during the assembly process.

Inside structure of a hologram laser

3 Vapor phase epitaxy (Manufacturing technology)
 Vapor phase epitaxy technology is used to form thin films by growing crystals of the vaporized material on a substrate. Sharp has drawn on its expertise in the area of crystal growth technologies to establish a lead over competitors and seize high market share.

Enhancing Key Devices Such as LCDs Using the Spiral Strategy to Build a New Sharp

In 1992, the Sharp Makuhari Building was completed in Makuhari, Chiba Prefecture. As a monument commemorating the 80th anniversary of the company's founding, it became home to departments developing the multimedia technologies anticipated for the 21st century.

In the midst of an economic downturn following the collapse of Japan's bubble economy, Sharp formed alliances with leading companies in Japan and abroad; the company aimed at new development by promoting STAR 21, a creative enterprise concept. The advanced information age—in the form of the Internet—had arrived, and Sharp embarked on a full-fledged expansion of its TFT LCD business and information equipment business (which included PCs).

Improving and upgrading LCD application products made them into hit products—in particular, the LCD ViewCam—around the globe.

CAD screen showing the LCD ViewCam design

1 The 80th Anniversary of Sharp's Founding

Completion of the Sharp Makuhari Building

■ An Intelligent Building for the 21st Century

In 1992, Sharp celebrated the 80th anniversary of its founding. In July of that memorable year, the Sharp Makuhari Building was completed in Makuhari, Chiba, on Tokyo Bay. This building, intelligently designed for the 21st century, not only served as a new base for conducting R&D and for receiving and disseminating information to Japan and abroad; it also fulfilled some of the functions of the Tokyo Branch and became home to a number of sales departments. With a design incorporating feedback and suggestions from young employees, the building featured comfortable and functional office space as well as a smart, modern appearance.

At the opening ceremony and morning gathering held on July 8, 1992, President Tsuji expressed the hopes and expectations for this new strategic hub: "This building is a monument commemorating the 80th anniversary of our founding. It is a legacy reflecting the successes of those who came before us and who laid the foundations of our company. Our mission now is to leap forward into the 21st century."

At the same time the new building was opened, the Multimedia Systems Research and Development Center was



The Sharp Makuhari Building was completed in Mihama-ku, Chiba City, Chiba Prefecture

launched as a new organization under the umbrella of the Corporate Research and Development Group. It was tasked with expanding business through the further development and fusion of technologies in the video, information, and telecommunications sectors. Its aim was to become an engine for creating new products for the multimedia age.

The building was wired with a cabling system for



Ribbon-cutting ceremony held to celebrate completion of the Makuhari Building on October 27, 1992

SS-NET*, a proprietary information and communication network that Sharp had brought to market. SS phones—special multifunction digital telephones for use with SS-NET—made it possible to control building systems such as air conditioning.

In conjunction with the completion of the new building, Sharp also established employee dormitories and company housing at 11 locations in the surrounding area. To reduce the cost of the investment, these buildings were sublet—an unusual step for Sharp.

One of the themes in the construction of the Makuhari Building was to move hand-in-hand with the local community. Consequently, the Sharp High Technology Hall was incorporated into the building as a facility open to the general public. Here, children and local residents could experience Sharp's state-of-the-art technologies. Visitors were able to enjoy vivid images on new LCD systems, such as a large 220-inch screen video projection system employing three high-definition LCD projectors.

■ Redesign of Uniforms and Choosing the Company Song

In Japan, Sharp took the opportunity of the 80th anniversary of its founding to redesign its uniforms and institute a company song aimed at raising employee morale and further enhancing the corporate image. The company held an in-house design contest, and new summer and winter uniforms were adopted based on the design chosen as the best from among the more than 3,000 works submitted.

High Technology Hall in the Makuhari Building allowed visitors to enjoy learning about Sharp's cutting-edge technologies

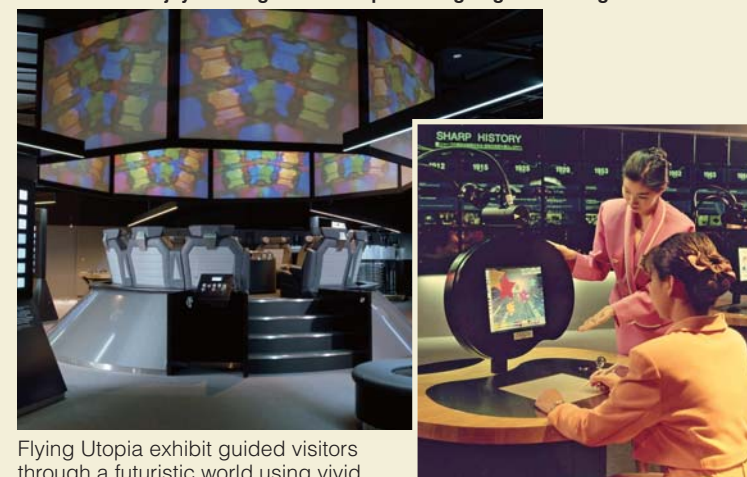

Flying Utopia exhibit guided visitors through a futuristic world using vivid images and powerful sound

Hyper Creator let visitors enjoy the experience of computer design

Also, the company song, *Beyond the Light*, was created by drawing on the results of an employee survey. Its pop style was different from that of conventional company songs.

Growth of In-House IT Systems

In the 1990s, an idea constantly addressed in the company's basic policies was how to improve production engineering—the capabilities regarded as the source of a manufacturer's competitiveness. To make sure that it had competency in production engineering commensurate with the increasing sophistication of its products, Sharp pushed forward to construct Sharp IMS (Intelligent Manufacturing System), a proprietary advanced design and production system. The system linked various types of information via computer, for example, development and design, production management, and production equipment. Sharp IMS was created based on the idea that having all production operations strengthened in a balanced manner would enable Sharp to establish a competitive advantage.

In 1989, Sharp embarked on the development of a global network linking all its business locations around the world using dedicated telecommunications lines. All company sites around the globe would be able to use the same line to send and receive different types of information—including voice, facsimile, and computer data—via the company's own infrastructure. This meant that required management information could be obtained whenever needed. Starting with a communications link opened between Japan and North America in December 1989, the network was subsequently deployed in Europe and Asia. By the end of April 1992, it covered 62 bases in 30 countries.

In addition, Sharp developed Integrated OA (Office Automation), a system employing computer networks to streamline office operations. Following a trial period of roughly one year beginning in the autumn of 1989, Integrated OA began service in November 1990 with e-mail. It was later expanded and upgraded to include electronic bulletin board services, followed by schedule management, business travel applications and expense reimbursements, and other office operations.

In May 1996, Sharp was among the first to establish an online presence in the early days of the commercial Internet. Sharp's website focused on presenting new technologies and

new products, and also contained a corporate profile and job availability information. An English-language version was posted at the same time. In 1997, Sharp launched a website specifically catering to material procurement.

* SS-NET (Sharp Super Network) was an integrated communications system that enabled high-speed two-way simultaneous communication of voice, data, and image information over ordinary (twisted pair) phone lines.

2 Putting Innovation into Action by Appreciating Customers' Point of View and through Creative Synergy

Innovation and Collaboration toward Becoming a Creative Company

■ NEWING Product Strategy

In 1991, President Tsuji issued a call to action: "At Sharp, we have a tradition of creating new products ahead of others. Now is the time to demonstrate the true value of this tradition." He called for each business group to create at least one SE (Super Excellent) product per year that proposed an innovative new lifestyle. Billed as the NEWING Product Strategy, it was deployed across the company.

President Tsuji also emphasized the importance of making products tailored to the user's point of view. In encouraging the company to properly meet users' needs, he repeatedly stated that, "To get information, it is important to place yourself in the thick of things." He encouraged employees to visit places where consumers actually live their lives and shop; to get a sense of how things are changing and gather information; and to take advantage of this in product development.

In 1991 when this strategy was launched, Sharp introduced the CJ-A30/31 pocket cordless phone with answering machine function, which featured an easily portable handset. In 1992, Sharp released the portable WV-S200 word processor with handwritten input via a pen-stylus, along with the 36C-SE1 HDTV (with built-in basic MUSE decoder).



The 36C-SE1 HDTV (with built-in basic MUSE decoder) created new demand by fulfilling users' needs, and became a hit product

■ STAR 21 Program

In 1991, to build a "new Sharp" oriented towards the 21st century, the company launched the STAR 21 program, a new concept in corporate creativity. All corporate business activities were undertaken with the intention of contributing to society and to the happiness of each employee; Sharp was striving to evolve and develop even further as a good corporate citizen. The STAR acronym, defined below, provided action guidelines for all employees.

Strategic & Creative Mind
Develop creatively rich, strategic initiatives

Total Customer Satisfaction
Ensure that customers feel highly satisfied

Advanced Technology
Use advanced technology to create demand

Rapid Action
Take quick action in response to changes in the environment

To achieve this corporate vision, in July 1992, Sharp instituted a program to put STAR into practice as a company-wide movement. Under this program, employees pursued the collective goal of making Sharp the company most trusted by customers. Small-group activities were vigorously developed throughout the company to work toward this goal. Beginning in April 1993, "hybrid" small-group activities that operated in a collaborative manner between departments were implemented under the theme of rebuilding business and management from the viewpoint of customers. The company also promoted rebuilding business and management based on a two-pronged strategy of offense and defense.

■ Achieving Results through Creative Synergy

President Tsuji made extensive use of the phrase "creative synergy" to mean creating new value by working in close cooperation with one another. Individual workers were urged to manifest their creativity and originality to the maximum extent possible, as well as gather collective wisdom that would transcend the barriers of the workplace or business division. The President believed that creative synergy would enable working groups to achieve results that were greater than the sum of their inputs. The Sharp Taskforces were a perfect example of creative synergy within the company.

Against a backdrop of rapid technological innovation in the electronics industry—and faced with difficulties in providing all needed technologies in-house—Sharp collaborated with leading companies at home and abroad. Bringing together their signature technologies and specialized expertise, Sharp and its partners pursued creative synergies to tackle areas that were difficult to deal with alone. In the 1990s, Sharp extensively promoted partnerships with leading overseas companies.

In 1992, Sharp signed a long-term business partnership agreement with Intel Corporation of the US, with a major focus on R&D and the production of flash memory*¹. By merging the technologies of both companies, this partnership served to grow the flash memory business. Another aim of the partnership was to develop proprietary new application products that used the jointly developed technologies. Sharp also promoted a series of other partnerships, including one with Apple Computer, Inc. for development and production of personal information tools, and another with AT&T Corporation for joint development of next-generation videophone technology.

A Commitment to Quality Assurance and Environmental Protection

■ Acquiring ISO 9000 Series Certification

To improve product reliability and customer satisfaction, Sharp began the Customer Communication System (CCS) in 1992. CCS was a new customer information system that communicated the candid opinions of users and dealers to business divisions. This feedback was then faithfully reflected in product planning, design, and production, as well as in responses to the marketplace.

From February 1990, all production facilities in Japan and abroad began activities to acquire certification under the ISO 9000 series of international standards for quality assurance management. In April 1990, the microwave oven plant at SUKM, Sharp's production subsidiary in the UK, gained ISO 9002 certification—a first for a Japanese-affiliated company in the UK. In Japan, the Communication and Audio Systems Group acquired ISO 9002 certification in November 1991, making it the first Japanese domestic equipment manufacturer to do so. Since then, all business sites in Japan and abroad have obtained such certification.

■ Formulating a Basic Environmental Philosophy

To respond to environmental issues on a company-wide basis, Sharp instituted a system in April 1991 to oversee product quality and reliability and environmental issues. This way the company strengthened its systems for managing and providing guidance on product quality—from production of products to their final disposal—and environmental issues.

In 1992, Sharp formulated its Basic Environmental Philosophy (a strong commitment to creating an environmentally conscious company with Sincerity and Creativity) as well as a set of basic principles for environmental protection. In 1993, it announced a voluntary program consisting of four items—including promoting protection of the ozone layer and reducing industrial waste—and worked toward their achievement.

In addition, Sharp sought certification under ISO 14001, a set of international standards for evaluating and certifying a company's environmental management systems. In November 1995, SUKM gained certification under BS



Registration certificate issued by JACO for third-party certification under BS 7750, which the Communication and Audio Systems Group acquired

7750*², the UK's environmental management system standards. This aided the company in preparing for the enactment of ISO 14001 (in 1996). Earlier, in September 1995, the Communication and Audio Systems Group acquired third-party certification under the BS 7750 standards from the Japan Audit and Certification Organization for Environment and Quality (JACO); it was the first Sharp business unit to do so. Since then, the entire company has worked to acquire ISO 14001 certification.

Responding to the Great Hanshin-Awaji Earthquake

Early on the morning of January 17, 1995, a major earthquake struck the southern part of Hyogo Prefecture. It inflicted enormous damage to the northern part of Awaji Island and throughout the Osaka-Kobe area and claimed over 6,400 lives.



Devastation around the Sharp Kobe Building

Sharp lost one of its employees in the disaster, and Sharp employee housing, dealers, and material suppliers suffered serious damage. Meanwhile, company premises—such as the Head Office, production facilities, and the Sharp Kobe Building in Kobe's badly affected Higashinada-ku district—escaped serious structural damage.

In Kobe, the few employees who made it to work on the day of the earthquake moved quickly to confirm the safety status of employees and check the situation with dealers. Some employees worked to rescue victims from collapsed houses and helped in fire-fighting efforts to prevent the spread of blazes. The next day, some 250 crisis support team members were dispatched from the Head Office and Sharp factories to the disaster area to deliver relief supplies to affected dealers, suppliers, and employees, and to aid in recovery efforts.

In addition, Sharp responded to a request from Hyogo Prefecture to help victims among the general public, and delivered more than 100 million yen worth of Sharp products such as washing machines to the prefectural government. Donations totaling 34.56 million yen were received from Sharp executives—as well as from employees and business partners in Japan and abroad—and this was distributed as special disaster relief payments to affected citizens and employees.

In the midst of a major disaster in which municipal functions were completely paralyzed, Sharp employees helped one another, and at the same time, provided support to the people around them. They were able to overcome this crisis by the entire company making a concerted effort.

*1 Flash memory is a type of non-volatile semiconductor memory that allows data to be freely stored or erased, but that retains data even when the device's power supply is turned off.

*2 BS 7750 was a standard related to environmental management systems published by the British Standards Institution in 1992. BS 7750 formed the template for the International Organization for Standardization's ISO 14001 certification (enacted in 1996), which became a common standard around the world.

3 Development and Production of LCDs and Solar Cells

The Evolving LCD Business

■ Expanding Production of TFT LCDs

In 1991, the year after the Liquid Crystal Display Group was established, a color TFT LCD plant (the NF-1 line) began operation at Tenri. This production facility harnessed technology that could use the full surface area of first-generation glass substrates (320 × 400 mm) to yield four 8.4-inch LCDs per substrate. The plant's supply capacity and cost competitiveness led to a leap in Sharp's market share.

With rival companies investing in plant and equipment and achieving per-substrate yields of four 9.4-inch LCD panels, Sharp began operation of a new production line (the NF-3 line) in August 1994—one capable of producing four 10.4-inch LCDs from a second-generation glass substrate (360 × 465 mm). The NF-3 line introduced single-substrate processing. Under this method, glass substrates were processed one at a time, making it possible to increase the size of the glass. This provided a solution to excessive equipment costs—which had been a problem in conventional simultaneous multi-substrate processing—and worked to boost the percentage of capacity utilized. By March 1995, production capacity at the two lines had grown to 240,000 units/month (in 10-inch-class panel equivalents).

Subsequently, the Mie Plant (Taki-cho, Mie Prefecture), which had become fully operational in October 1995, used 2.5-generation glass substrates (400 × 505 mm) to produce large-format color TFT LCDs sized 11.3 inches and larger. The introduction of CIM (computer-integrated manufacturing), along with a super-intelligent automated transport system that crisscrossed all processes, further increased production efficiency.



Microfabrication processing line for color TFT LCDs (Tenri Plant)

LCDs for laptops continued to grow larger in size, while replacement demand began to emerge as desktop PC monitors shifted away from large CRTs. Under these circumstances, Sharp adopted a strategy ahead of its competitors to constantly be introducing larger LCDs and achieving even lower production costs.

■ Evolution of TFT LCD Technology

Sharp developed a Super VA (Viewing Angle) LCD that enabled wide viewing angles by dividing each pixel in the LCD array into left and right domains and aligning the liquid crystal molecules at different angles.

Sharp also developed the Super HA (High Aperture Ratio) LCD. This yielded a bright display using an ingenious electrode structure inside each pixel that broadened the area through which light could pass (i.e., it offered a high aperture ratio). In 1996, Sharp announced the Super-V LCD, which merged these technologies to provide a display featuring both wide viewing angles and high brightness.

In 1997, Sharp announced success in the joint development*¹ of a 42-inch plasma-addressed liquid crystal (PALC) display that used plasma discharge instead of TFTs as the electronic switch driving the LCDs. Although commercialization of this LCD was shelved, this success proved that large screens were possible, and marked the dawn of the era of large-screen LCD TVs.

■ Development of New Mobile LCDs

In 1994, Sharp developed the industry's first reflective color TFT LCD that was easily viewable even outdoors and that did not require a backlight. It was intended for use in mobile devices such as Sharp's Zaurus, a then-new mobile information tool. Giving the TFT pixel electrodes high reflectivity and using a mixture of pigments in the liquid crystal material made it possible to have a bright, vivid color display. Sharp also started mass production of Advanced TFT displays that added the functionality of a backlit transmissive LCD for use in dark locations.

While burnishing its reputation as a pioneer in the field of LCDs, Sharp was able to offer a total lineup, ranging from large TFT LCDs to mobile LCDs and STN LCDs. The LCD business grew tremendously, with sales of LCDs going from 136 billion yen in fiscal 1992 to 226 billion yen in fiscal 1997—nearly doubling in just five years—and accounting for nearly 15% of total sales company-wide.



Space-saving CE-LT14M color display using a 13.8-inch Super-V LCD (1997)

Expanding Solar Power Systems to Residential Uses

■ Introduction of Residential Solar Power Systems

In April 1994, the Agency for Natural Resources and Energy under the Ministry of International Trade and Industry (now METI) created a subsidized program for residential PV systems that marked the start of the residential solar power market in Japan. In addition, the fact that the industry had established grid interconnect technologies to enable home-generated electricity to be combined with commercial (utility-supplied) power also served as a boost to the start of residential PV applications.

In 1994, Sharp introduced a new residential solar power system consisting of monocrystalline solar cells with high conversion efficiency and a compact power conditioner (inverter) to handle the grid interconnection. Sharp's Sunvista residential solar power system—along with other examples of advanced PV systems, such as houses with pre-installed solar power systems—won awards in the New Energy Foundation's Commendation for 21st Century New Energy Equipment/System program (New Energy Awards) for six years in a row, beginning the first year the awards were instituted (fiscal 1996).



Example of a residential solar power system (1994)

■ Improving the Conversion Efficiency of Polycrystalline Solar Cells

Sharp set out to achieve higher conversion efficiencies in polycrystalline solar cells. In 1996, the company developed UDS (unidirectional solidification) polycrystalline solar cells with a crystal size of approximately 70 cm²—about 30 times larger in area than conventional cells. This was achieved by developing a method to cool molten silicon so that the crystal orientation remained constant. Even though polycrystalline silicon was used, the module conversion efficiency was near that of monocrystalline cells and, at 15%, the best in the industry.

■ Expanding Solar Cell Production Capacity

In 1998, Sharp constructed Shinjo Plant No. 3, a solar cell plant in Shinjo-cho (now Katsuragi City), Nara Prefecture. It was one of the world's largest dedicated solar cell production facilities, with a production capacity that expanded from an initial base of 20 MW of polycrystalline solar cells to 150 MW per year.

Toward Increased Production of Electronic Devices

■ Entering the Flash Memory Business

In February 1992, Sharp entered into a business partnership with Intel Corporation, the largest semiconductor maker in the US, for research and development, production, and mutual supply of flash memory. Flash memory enables data to be written and reprogrammed at will, yet it retains data even when power is switched off. With sales of 46.5 billion yen in fiscal 1996, production value showed remarkable growth, and flash memory became a mainstay of Sharp's semiconductor business. At the Fukuyama Plant, where flash memory devices were produced, Plant No. 3 became operational in 1993 with new equipment using 0.6 μm process design rules*²; this was followed by Plant No. 4 in 1999, which used 0.25 μm rules.

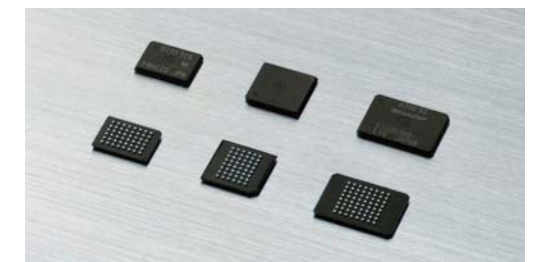

Flash memory contributed to the creation of unique products

■ Developing Semiconductors to Contribute to Greater Functionality in Equipment

To respond to the ever-shrinking size of equipment, Sharp developed SST (Super Slim TCP [tape carrier package]) technology that enabled the industry's narrowest tape-based package (with a width of 8 mm). In addition, the company created a chip-scale package (CSP) with external dimensions very close to those of the silicon die itself. The LZ2353, a high-resolution (410,000-pixel) 1/3-inch (about 8.5 mm) CCD image sensor, was developed in 1992 for use in camera-integrated video tape recorders.

Sharp also successfully developed a red laser diode, which was integrated into hologram laser pick-ups used in DVD players. The company also developed data transmission devices that worked by transmitting and receiving infrared light. These were embedded in numerous products, such as word processors and mobile information tools.

Feature-rich optoelectronic devices created by Sharp boasted the world's top market share for 20 consecutive years*³ beginning in 1986.

*¹ A joint development of Philips Electronics N.V. and Sony Corporation.

*² Process design rules define the minimum width and spacing of transistor elements in an IC device.

*³ Source: Gartner (March 2011).

Note Optical Semiconductor (including Photovoltaic Solar Cells) is based on Gartner's "old" definition and that Gartner now excludes solar cell devices in their new definition set, which can be found in Gartner's publication "Market Definitions and Methodology: Semiconductor Devices and Applications" January 18, 2011 (ID: G00209322).

4 A Blossoming Spiral Strategy

Aiming for Personal Informatization

■ Pursuing a Spiral Strategy

During this period, Sharp laid out a spiral strategy as a new approach to product engineering. The idea was to develop key devices with key technologies at their core and then put them to practical use in creating uniquely featured products not made by any other company. Those products, in turn, would promote the further evolution of key technologies and key devices. Repeating this process for both products and devices gave rise to a virtuous synergistic spiral.

■ Debut of the Zaurus, a New Mobile Information Tool

In April 1992, Sharp announced its Pi²T (personal information and intelligent tool) concept to support “personal informatization.” In essence, this tool would support smart, information-intensive lifestyles and personal communications, and it would be easy to use for anyone, anytime, anywhere.

The precursor to Pi²T was the PV-F1 electronic management organizer, introduced in July 1992. Although it offered features such as handwritten input and schedule management, it was bulky, heavy, and carried a high price tag. Sales duly flagged.

Evolving from the PV-F1 was a new personal information tool, the PI-3000 LCD Pencom Zaurus, which made its debut in October 1993. It featured a compact size small enough to fit in a suit pocket, weighed only 250 g, and had a low price of 65,000 yen. Its advertising catch phrase promised that, “With one of these, you won’t need anything else.” It sold well as an advanced information tool sought after by companies and individuals aiming to improve work efficiency.

Following this, Sharp incorporated new features into the Zaurus that were slightly ahead of the times—for example, facsimile transmission, PC communication, and Internet access—and it became a popular product with businesspeople. In October 1996, sales of the Zaurus in Japan topped one million units. Sharp also developed Zaurus models for corporate users and overseas markets.



The PI-3000 could exchange data with a PC via infrared communication (top); A hands-on Zaurus event at Haneda Airport, Tokyo (March 1994)

■ Debut of the Mebius Notebook PC

In 1995, Sharp launched the AV1/590CD (PC-A330) Mebius notebook PC as a core Pi²T product. Armed with big, bright, and beautiful LCD screens, subsequent Sharp notebook PCs gained immense popularity.



The AV1/590CD notebook PC used an 11.3-inch SVGA (800 × 600-dot) color TFT LCD that was 40% brighter than previous Sharp LCDs

■ Evolution of Word Processors

Sharp was a leader in the word processor industry, maintaining the top market share for more than 10 years beginning in fiscal 1987 (according to a survey by Nikkei Inc.). With the rise of the personal computer, stand-alone word processor shipments peaked in 1989 and began to decline, but by offering useful new features, Sharp models continued to enjoy strong support.

In 1992, Sharp introduced the WV-S200, the first model to offer input via a stylus, and the WD-A751, which allowed handwritten editing using the stylus. In 1996, Sharp introduced the MR-1, which boasted functions such as Internet access and PC communication.

■ Debut of Digital Copiers

In 1994, Sharp introduced the AR-5040 digital copier, which made physical copies after first storing digital images of the originals on a built-in hard drive. The AR-5030FR, which added facsimile functions to the copier, was introduced the following year, marking the dawn of Sharp’s MFPs (multifunction printers).



The AR-5130 digital copier could also be used as a computer printer (1996)

■ Evolution of System Products

On POS terminals, CRTs were gradually being replaced by LCD screens. The RZ-A765, introduced in 1992 and equipped with a duty (passive-matrix) color LCD, and the RZ-A505, introduced in 1995 with an 8-inch color TFT LCD, were two such examples.

Proprietary AV Products Taking Full Advantage of the Evolution of LCDs

■ Debut of the “Shoot, Watch, and Enjoy” LCD ViewCam

The LCD ViewCam video camera was born from the idea that a mother should be able to record videos of her children easily, without having to strain by looking through a tiny viewfinder. This was made possible by replacing the viewfinder with an LCD monitor. During development of the device, two technical challenges had to be overcome. The first was making the LCD monitor easily viewable even in bright outdoor light. This was achieved by applying a five-layer anti-reflection film to the LCD panel. The second challenge concerned broken electrical connections between the rotating parts (where the LCD viewfinder and deck section joined the camera unit). This problem was overcome by developing a special structure with non-breaking wire.

The VL-HL1 LCD ViewCam eventually made its debut in October 1992, under a promotional concept of “shoot, watch, and enjoy.” New ways of using the product emerged naturally—for example, using it to record wedding guests’ messages—and it became a huge hit. In September 1994, less than two years after its introduction, cumulative production reached one million units. Overseas exports accounted for 480,000 units of the total, and the VL-HL1 had grown into a global product.



Many visitors to Electronics Show '92 picked up the VL-HL1 LCD ViewCam and couldn't take their eyes off the LCD monitor

■ Development of the LCD TV

Up to this point, the LCD TV market had been dominated by small-screen models. But in 1995, Sharp introduced the Window series of LCD TVs, which included the 10.4-inch LC-104TV1 model. Featuring a thin-profile design with a full-color TFT LCD, these models were promoted as personal TVs that could be set up almost anywhere.

■ Portable MD Player Created through Concurrent Development

In 1993, the debut of the MD-S10, the world’s smallest and lightest portable MD (MiniDisc) player, rocked the

industry. A concurrent development system was used to conduct R&D and design at the same time. With production beginning the instant development was completed, the unit enjoyed a successful early introduction. Sharp developed a miniature hologram laser and an OPIC photodetector element for use in the optical pickup that read data from the MiniDisc, enabling the creation of a small, lightweight unit. The MD-S10 exemplifies well Sharp’s spiral strategy, in which products and devices evolve together.



The MD-S10 MD player came with a remote control equipped with an LCD

Home Appliances Destined to Become New Necessities

In 1992, Sharp introduced the ES-BE65 fully automatic washing machine. Conventional washing machines in Japan had a dual-layer tub construction, with a spin tub placed inside a washing tub. Sharp developed a water-saving tub with a single-layer structure that eliminated the holes in the spin tub. This design saved about 30% on water and detergent usage. It also prevented mold from forming due to detergent residue—a frequent problem with the dual-layer construction.

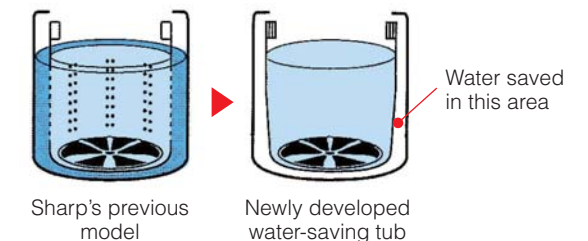

In 1993, Sharp introduced the SJ-V45K refrigerator, which used a newly developed CFC-free vacuum insulation material. Compared to conventional urethane foam, its heat-insulating properties were about 2.5 times higher. The SJ-V45K had the same exterior dimensions as conventional models but a larger interior capacity. In addition, eliminating the use of CFCs in urethane foam formation improved the environmental performance of the refrigerator. Building on this foundation, Sharp devised a new compressor control system and developed the SJ-SE40R refrigerator, which was No. 1 in the industry for energy savings.

Beginning in the spring of 1996, the Appliance Systems Group launched a New Necessities strategy proposing new lifestyles. Representative of this was the AY-H28FX air conditioner, introduced in October 1996. In addition to conventional dehumidifying, heating, and cooling functions, it also featured—for the first time in the industry—a ventilation function and a humidifying function that did not require a water supply. By capturing water from the air, the unit could provide heating humidification without the inconvenience of dealing with a water supply. Further, users could enjoy constant ventilation without having to open windows.

5 The Sharp Brand Spreads around the World

Strengthening Systems Overseas

■ Expanding Product Offerings for Overseas Markets

During this period, Sharp introduced to the world LCD application products that created new markets. The company's efforts not only helped greatly to increase sales, but also to improve the Sharp brand image. The popular LCD ViewCam, introduced in Japan in 1992, was released in the US the following year and subsequently launched around the world. An overseas version of the Zaurus, the ZR-5000, was introduced in the US in January 1995. In this fashion, Sharp would tailor a number of its existing products to respond to the different needs of specific markets.

In the 1990s, personal incomes in Asian countries were on the rise, increasing the area's attractiveness as a target for sales. At the hub of this region was Sharp Electronics (Malaysia) Sdn. Bhd. (SEM), established in 1995. SEM undertook design and development of TVs, VCRs, and audio equipment for Sharp's Asian production bases. It also supplied components for manufacture and repair to Sharp's production sites around the world.



Q Beat series color TVs for the Asian market were designed and developed by SEM (1998). They were made and sold in countries such as Thailand, Indonesia, India, and Malaysia.

■ Expansion of Overseas Bases

To expand production in consuming areas in Asia, Sharp established Sharp Thebnakorn Manufacturing Thailand (STTM^{*1}) in 1992. As the manufacturing division of STCL—Sharp's sales subsidiary in Thailand—STTM was tasked with the production of color TVs. In 1994 in Indonesia, Sharp established P.T. Sharp Yasonta Indonesia (SYI^{*2}) for the production of color TVs and refrigerators and P.T. Sharp Yasonta Antarnusa (SYA^{*2}) for sales.

Asia was experiencing rapid growth as a production base for the electronics industry, and expanding and upgrading the production and sales system for electronic devices in the region became an urgent task. Sharp Electronics

Components (Taiwan) Corporation (SECT) was established in Taiwan in 1992 as a sales subsidiary for electronic components. Then, in 1995 in Indonesia, P.T. Sharp Semiconductor Indonesia (SSI) was established as a manufacturing company for ICs and optoelectronic devices. Sharp's objective was to expand business in the field of electronic components.

In the US, the North American Free Trade Agreement (NAFTA) came into effect in 1994, and US investment in Mexico increased. A number of manufacturers began setting up *maquiladoras* (manufacturing operations in a free trade zone) in Mexico. In 1997, Sharp established Sharp Electrónica Mexico S.A. de C.V. (SEMEX), and in addition to manufacturing TVs and vacuum cleaners mainly for the US market, it also shipped products within Mexico as well as to Central and South America.

In addition, in 1997, Sharp established Sharp Middle East Free Zone Establishment (SMEF), a sales company based in Dubai, United Arab Emirates. SMEF managed the Middle East, Africa, and Central Asia markets, and worked to expand sales throughout the region.

Expanding Business in China, Focusing on the Coastal Region

Sharp embarked on an aggressive business expansion in China, where remarkable economic growth had been continuing under the country's reforms and open-door policies.

Sharp worked aggressively to expand business by keeping in step with development policies along the Changjiang (Yangtze River) coast of China—an area that had been strongly promoted by the Chinese government—and by moving to form strategic partnerships (joint ventures) to harness the mutually complementary strengths of Sharp and local companies. In addition, Sharp developed two basic policies for expanding business in China: 1) focus on the Changjiang (Yangtze River) area to locate bases of operation, and 2) manufacture multiple products at each plant. In China, the government generally instructed each plant to produce only a single item. Yet Sharp took the bold step of manufacturing multiple items at a single plant, explaining to the government that it was possible to both maintain stable operations and boost the plants' efficiency.

First, in 1992, Sharp established Shanghai Sharp Air-Conditioning Systems Co., Ltd. (SSAC) for the production of air conditioners. In 1994, the name was changed to Shanghai Sharp Electronics Co., Ltd. (SSEC), and in 1996, the company added production of refrigerators and washing machines. This plant was set up in the Pudong New Area, an area of Shanghai earmarked for development. Sharp was one of the first Japanese companies to establish a presence there. In 1993, the company established Sharp Office Equipments (Changshu) Co., Ltd. (SOCC) in Changshu as a manufacturing base for copiers. With the goal of exporting its products to the world, SOCC was established as a fully owned subsidiary of Sharp. When asked by the Chinese government to set up an LCD production base as part of a national project, Sharp

established Wuxi Sharp Electronic Components Co., Ltd. (WSEC) in 1994. WSEC was tasked with the manufacture and sales of STN LCDs. Sharp also established Nanjing Sharp Electronics Co., Ltd. (NSEC) in 1996 as a production and sales company for AV products, and Shanghai Sharp Mold and Manufacturing Systems Co., Ltd. (SSMC) in 1997 for the manufacture and sales of molds and other production tooling.



Sharp bases in China (as of 1997)

Mindful of the Three Golden Projects—a series of policy measures announced by the Chinese government in 1993 related to the development of the information superhighway in China—Sharp also pushed forward to strengthen its image as a technology leader. In July 1995, the Sharp Multimedia Technology Exchange and Exhibition was held in Beijing to communicate the attractiveness and technological capabilities of Sharp products.

Since the 1980s, Sharp had built a strong relationship of trust with the Chinese government—in particular, with former President Jiang Zemin (then Minister of Electronic Industries) and former Vice Premier Wu Bangguo (then CPC Shanghai Committee Secretary), who were among the many government officials who visited Sharp bases in Japan. Meanwhile, each base in China contributed to the prosperity of its local region, while laying a foundation for Sharp's business in China.

Establishing a Three-Node R&D System in Japan, the US, and Europe

In 1990, Sharp established Sharp Laboratories of Europe, Ltd. (SLE) in Oxford, UK. It became fully operational in 1992 and conducted research in a number of fields: optoelectronics, in particular new light-emitting devices and blue laser diodes; imaging technologies, including 3D image display systems and ultra-high resolution printing; and information technologies, such as systems for machine translation between European languages.

In 1995, at a time when the US had taken the lead in the field of multimedia technology, Sharp established Sharp Laboratories of America, Inc. (SLA) in Washington State. SLA conducted research related to core technologies for the new information society, such as digital video signal processing technologies.



SLE completed construction of a new building in 1992 and began full-scale operations

Together with facilities in Japan, Sharp established a three-node R&D system in Japan, the US, and Europe. From this system emerged a number of unique Sharp technologies and devices, including elemental technologies for MPEG4^{*3}, seamless image compositing processes, and 3D displays. This system became a foundation upon which Sharp is still building today.

Restructuring the Sales Organization in Japan and Implementing New Measures

In concert with the growth of mass merchandisers in the retail consumer electronics industry, Sharp reorganized its domestic sales subsidiaries. In April 1992, the three sales companies in Japan (with the exception of the Okinawa district) were reorganized into two companies: Sharp Electronics Sales Corporation (SEH), which took charge of local retailers, and Sharp Live Electronics Sales Corporation (SLH), which took charge of retailers operating over a broad territory (including volume retailers). One example of the detailed support that SLH provided was the centralized, nationwide supply of product and promotional information—something that had previously been handled by individual regional companies.

This new structure also supported frontline sales activities through new information tools and communication networks. In 1992, Sharp distributed dedicated electronic organizers to all 2,300 sales representatives in Japan. These devices could, for instance, be programmed with data about best-selling product models based on sales figures entered by sales staff and compiled at the Head Office. In 1997, a satellite-based digital communication service was begun. Videos containing new product introductions or promotional information were assembled and distributed to each location nationwide via a communications satellite.

*1 In 2005, STTM constructed a copier factory and was re-established as Sharp Manufacturing (Thailand) Co., Ltd. (SMTL).

*2 In 2005, SYI and SYA were merged to form P.T. Sharp Electronics Indonesia (SEID).

*3 MPEG4 is a technical standard for video and audio compression/decompression designed for low bit-rate ("slow") communication channels such as mobile phones.

Aiming to Be a One-of-a-Kind Company Issuing the LCD TV Declaration

Based on the One-of-a-Kind Strategy—to create new demand by developing unique technologies and new products that hadn't existed before—Sharp selected and consolidated its business resources on LCD development.

Under its LCD TV declaration, the company succeeded in making technological breakthroughs and developing new markets for LCD TVs.

Other products, such as mobile phones equipped with cameras and air purifiers with Plasmacluster Ion technology, also became hits with consumers.

Meanwhile, Sharp increased corporate value by considering the environment as a driver for growing business and by carrying out a comprehensive brand strategy.

Line art of a camera-equipped flip-type mobile phone

1 Aiming to Be One-of-a-Kind, Rather Than Number One

President Machida Appointed

On June 26, 1998, Corporate Senior Executive Director Katsuhiko Machida was named Sharp president. At the same time, Corporate Advisor Saeki became corporate senior advisor, and President Tsuji became corporate advisor. President Machida, the new leader of the company, had become a corporate senior executive director in 1992 after working in a wide range of areas. He was also group general manager of the International Business Group and the head of overseas operations. He had contributed greatly to the development of Sharp's business in the Chinese market. In 1997, he became responsible for Sharp's home

appliance business and domestic marketing.

Upon becoming president, Machida announced the revised Basic Management Policy (management that is easy to understand, covers the basics, and considers sustainability for growth) and the Guidelines for Business Management (developing unique businesses, autonomous management, fast and efficient operations, and effective global management; and promoting high customer satisfaction). He started traveling around Japan about a month after his appointment, visiting 11 sites to explain his ideas directly to managers.

In January 1999, he announced the Crystal-Clear Company Declaration. It was a call to become the only company of its kind that shines with unique technologies such as LCDs. In February, he started the Crystal Clear Homepage on Sharp's intranet, which included the Machida Channel column where he communicated his message directly.

"One-of-a-kind management" is a way for a smaller company to compete with larger companies and maintain steady revenues with products that are distinctly different and that offer unique features. The strategy is well aligned with the approach to product creation that Sharp has taken ever since its



Starting with a speech at the Mie Plant on August 1, 1998, soon after his appointment, President Machida traveled around the company's facilities to explain his management policy



foundation—an approach symbolized by the words of founder Hayakawa to “make products that other companies want to imitate.”

In August 1998, the company established the Sharp Business Standards and Action Guidelines as standards of conduct for the board of directors and employees to follow in realizing the company's business philosophy and business creed. Following that, Sharp instituted the Sharp Charter of Conduct in April 2003, placing emphasis on the importance of observing regulations and respecting corporate ethics, in an effort to make management more transparent.

Sharp's Declaration for LCD TVs

As part of the one-of-a-kind strategy, President Machida was thorough in selecting business areas and consolidating the company's efforts. Around that time, semiconductors were predominant in Sharp's device business. The LCD business was comparatively small in size, and it was not yet

making a profit. However, Sharp LCDs were leading the world in terms of technology, and Sharp had one of the top shares in the market. President Machida decided that it would not be sustainable for a company of Sharp's size to keep investing in both of these business areas. He dared to choose the LCD business for Sharp's focus as it held great promise for future growth.

This decision was not just a shift towards the LCD business. President Machida boldly declared, “We will replace all TVs sold in the Japanese domestic market with LCD TVs by 2005” and made that the company's new business policy. His declaration was initially greeted with tremendous skepticism from the general public; it was seen as “impossible” or “a pipe dream.” Internally, engineers were perplexed, as there were still so many issues to be

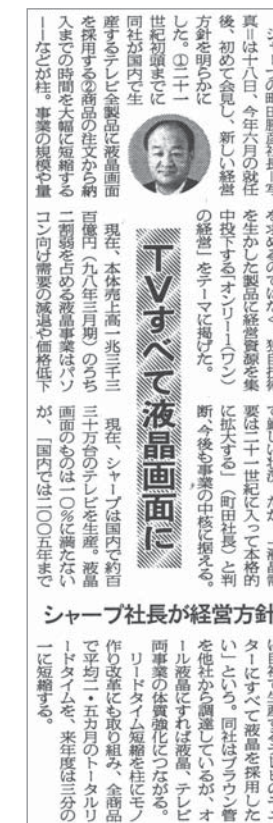

Newspaper article about Sharp's LCD TV declaration (*The Nikkei*, August 19, 1998) (top) and two LCD TV models, the LC-121F1 and LC-150F1

resolved for LCD TVs. However, this clear goal stoked their spirit of endeavor, and the company was soon united in the effort. In fiscal 2004, the percentage of LCD TVs reached approximately 90% of Sharp's total TV sales in Japan, achieving the goal ahead of schedule.

Mastering the Art of Manufacturing

In January 2001, President Machida announced that the company should return to its roots as a manufacturer and master the art of manufacturing in Japan. He noted that mastering the art of manufacturing was what Japan's electronics industry should aim for. This didn't mean they should manufacture everything in Japan. His idea was to use mature technologies to manufacture products at cost-competitive and optimally located overseas plants, thereby contributing to growth in those countries. Meanwhile, he thought the work on creating cutting-edge devices and products that were based on the latest, still-evolving technologies should stay in Japan from development through to production.

Sharp began full-scale implementation of supply chain management (SCM). The purpose of SCM was to supply markets in a timely manner with just enough products as were needed. That required systematizing every step of the business operation, from design and development to procurement, production, and distribution.

The company also implemented the Sharp Direct Manufacturing Method starting in 2001. This production innovation—based on the key word *choku*, meaning “direct” in Japanese—included vertical startup of production^{*1}, direct delivery of components to the manufacturing process^{*2}, and improvement in quality of manufacturing (first-pass yield)^{*3}. The method was introduced at all production sites in Japan and abroad.

In March 2001, Sharp established S.I. Solutions as a joint venture with IBM Japan. The company offered business solutions in the form of enterprise resource planning (ERP)^{*4} and SCM to respond to various needs inside and outside the company.

*1 To start planned production at full volume from the beginning of production for a new product (or new plant opening).

*2 To deliver necessary components directly to the production line in order to eliminate in-process inventory.

*3 The ratio of components put into the production process that pass all inspections in the first round, including inspections in the production process and prior to shipment.

*4 Comprehensive information system to support core business management tasks including sales, production, distribution, inventory, financial accounting, management accounting, and human resource management, with the aim of efficiently utilizing a company's managerial resources.

2 Brand Strategy in Full Force

What to Leave in the 20th Century, What to Take to the 21st Century

As of 1999, Sharp's brand power in Japan was ranked seventh in the industry (according to a brand recognition survey from a professional research organization that the company commissioned). Sharp was not perceived to have a particularly strong presence and was seen as a "faceless" company. In order to raise its brand recognition, the company chose LCDs and LCD TVs as its "face." A new policy was set to advertise only LCD application products and to make the volume of the advertising number one in the industry. The entire advertising and sales promotion budget was devoted to LCD TVs.

Sharp chose Sayuri Yoshinaga, a famous and well-liked actress in Japan, as its image character and spokesperson. The company ran a massive commercial campaign on TV for four consecutive days starting from New Year's Day in 2000—the last year of the 20th century. The campaign carried a memorable catch phrase: "What to leave in the 20th century. What to take to the 21st century." The commercial ran so frequently that anyone who turned on a TV during those four days was sure to see it. Consumers got the impression that the age of the LCD TV had arrived. This campaign also made Sharp's engineers realize that the company was serious and passionate about LCDs.

Improving Corporate Branding

In 2002, the year of Sharp's 90th anniversary, a company-wide campaign called the Be Sharp Initiative was launched with the aim of improving the company's brand power. It was an effort to build a strong brand by creating a new business vision and developing products that reflected that vision. Sharp sought to capitalize on its strengths and engage in corporate activities that would help it gain wider recognition from society and customers as a top-tier company.

In January 2002, the Brand Strategy Planning division was created under the direct control of the president to lead corporate branding activities. It took measures to improve



TV commercial in which Sayuri Yoshinaga calls LCD TVs "what to take to the 21st century," while wrapping up an old CRT TV in a traditional wrapping cloth

Sharp's brand power, providing branding and leadership training. Further, in February 2006, all advertising, sales promotion, and website departments were integrated to become the Global Brand Strategy Group. The group had two objectives for maximizing brand impact. One was to carry out uniform communications from a branding perspective. The other was to develop and execute branding strategies. To achieve optimal end-user impact, a plan was put in place to standardize the content, style, and "measurable volume" of communications across all media, including TV commercials, newspaper and magazine ads, billboards, in-store POP displays, and the Internet.

In November 2002, the company commissioned Hitotsubashi University's Professor Kunio Ito to assist and promote branding activities. He is considered the foremost researcher on corporate branding in Japan, and in cooperation with Nikkei Inc. he has developed a method to measure the value of branding.

President Machida often talked about the importance of branding and showed his firm determination to establish Sharp as a strong brand around the world. To this end, he initiated the company-wide Shine Campaign in April 2004 to raise the quality of the actions of individual employees, believing this would help improve Sharp's brand power. The idea for the campaign was that the Sharp brand would shine

Residential solar power system



Ultra-thin notebook PC



AQUOS LCD TV



1-Bit digital audio system

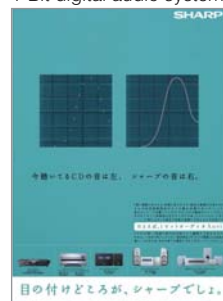

Plasmacluster Ion home appliances



A daily series of newspaper ads introducing one-of-a-kind products (2002)

even more if employees had greater pride and confidence in themselves and the company, while creating one-of-a-kind products.

As a result of company-wide efforts to raise brand recognition, Sharp ranked top in the industry according to a

brand recognition survey in the fall of 2006. This was a big leap from the company's seventh-place ranking in 1999 and reflected the company's success in unifying management policy, business activities, and brand strategy.

3 Human Resource Development Utilizing Diversity and Self-Motivation

Implementing the Sharp Leadership Program

Ever-accelerating technological advances required changes in the way business was conducted, even in areas of marketing and business administration. Sharp implemented a new human resource system so that all employees—the backbone of the company—could respond to these changes, improve their abilities, and work to their full potential.

In April 2001, the Sharp Leadership Program was implemented to nurture the next generation of corporate leaders. It was a selection-based education system for developing the leadership and management skills of employees—from young employees in semi-managerial positions to those in charge of departments—with a view to enabling them to work on the global stage. The Challenge Course was implemented for the early promotion of young talent in semi-managerial positions. The course had two pillars: a performance-based monthly salary system that eliminated seniority-based factors, and educational support programs.

In October 2003, the Master System was implemented to support Sharp in mastering the art of manufacturing. The purpose of the system was to produce excellent technicians who could foster the creation of one-of-a-kind products. In April 2004, four employees who had developed skills and knowledge in areas such as soldering and sheet metal work and who were capable of teaching the younger generation were selected as the first Masters.

In 2005, the Management of Technology (MOT) Program was created to strengthen the education system for corporate managers from technology fields. This system has been helping to develop managers who can create new businesses and revitalize existing businesses from the seeds of groundbreaking technology.

In October 2004, a special department was established to promote better utilization of female employees. The following year, the Company-Wide Affirmative Action Promotion Campaign began, with a remit of ensuring appropriate job placement for talented and motivated female employees. Progress has since been made in expanding the range of job areas open to women and promoting talented female employees to management positions. The company has also been working to improve its measures supporting an optimal work-life balance.

R-CATS Activities Begin

In October 2003, Sharp changed the name of its small-group activities to R-CATS (Revolution Creative Action Teams), and it started an original program involving all employees from all departments.

R-CATS activities are a method of pooling the collective knowledge and ideas of a group. These activities are considered work itself, and participants uncover and tackle issues in their workplace, thereby acquiring problem-solving skills as a group. The intention of R-CATS was to maximize the potential of people and organizations. The program has since been expanded to overseas bases.



Representatives of teams receiving awards at the All-Sharp R-CATS Convention, held for the first time after the organizational change (May 2004)

4 Becoming an Environmentally Advanced Company

Development of Super Green Activities

As society became more environmentally conscious, Sharp established the Environmental Protection Group in October 1997 to promote environmentally sustainable management. Specific measures were developed in four areas: Green Products, Green Factories, Green Mind, and Recycling.

Green Products

Sharp developed environmentally friendly products, such as energy-saving products or recyclable products, and identified them with the Sharp Green Seal as products that had passed an internal certification system. In fiscal 1998, the company issued Green Product Guidelines, compiling design goals for environmentally friendly products.

Green Factories

The company took measures to reduce waste and greenhouse gas emissions and established Green Factory Guidelines in fiscal 1999. The company also implemented the Sharp Environmental Management System at domestic production facilities starting in fiscal 2003, defining more advanced internal standards based on ISO 14001.

Green Mind

Sharp aimed to foster an environmentally conscious corporate culture and encouraged employees to take measures at their workplace and to participate in citizens' group activities for environmental protection. It started publishing the Sharp Environmental Report in 1999, disclosing environment-related information and enhancing communication with stakeholders.

Recycling

The company made progress in material recycling, extracting material resources from used products for reuse in new products. In 2001, it inaugurated its closed-loop recycling technology for plastic used in manufacturing washing machine tubs.

Sharp carried out the 3G-1R strategy—the name derived from the four areas of environmental activity. In 2001, the perspectives of “management” and “distribution” were added and the 3G-1R Strategy was renamed Super Green Activities.



Pellets of recycled plastic

Operation of Kansai Recycling Systems Started

In April 2001, the Home Appliance Recycling Law was enacted in Japan, making recovery and reuse of resources mandatory for air conditioners, TVs, refrigerators, and washing machines. Prior to that, in December 1999, Sharp had collaborated with Mitsubishi Materials Corporation in establishing Kansai Recycling Systems Co., Ltd. in Hirakata City, Osaka. This factory utilized cutting-edge facilities and manual disassembly to maximize the portion of materials recycled. In 2006, Kansai Recycling Systems opened a second factory for recycling TVs in Iga City, Mie Prefecture.

In 2001, an employee at Kansai Recycling Systems released recovered CFC (chlorofluorocarbon) into the air. Sharp, as the largest shareholder, was the brunt of criticism. Learning from this experience, the company renewed its efforts to reinforce a corporate culture respectful towards the environment and compliant with all laws and regulations.

1999 Sharp Environmental Report



5 Growth in the Device Business through Selection and Consolidation

Advancing the LCD Business through the Development of Unique Technologies

Sharp's LCD business proceeded to develop displays not only for PCs—its main LCD application product—but also for new applications such as TVs and mobile phones. To meet a wide range of user needs, Sharp carried out a

strategy of developing a full line of LCDs—STN, TFT, large, and small size for mobile devices.

Developing Advanced Super-V LCDs

With LCDs for TVs in mind, Sharp made further efforts to develop technology to increase contrast, improve response, and create wider viewing angles that were not

possible with conventional TFT LCDs. The defining factor was the alignment method for the liquid crystal molecules. Sharp succeeded in developing the Advanced Super-V LCD, which made it possible for viewers to enjoy high-contrast images from any angle. This LCD was used on the LC-20B1 20-inch AQUOS LCD TV and other models, released in 2001.

They received rave reviews and became a stepping stone towards the growing popularity of LCD TVs. In 2003, the company developed the Mobile Advanced Super-V LCD. Having both reflective and transmissive properties, it was clearly visible in bright and dark environments. This LCD was utilized for products such as car navigation systems and mobile phones.

Development of System LCDs

In 1998, Sharp developed the world's first System LCD, where ICs could be incorporated onto the LCD substrate using CG-Silicon* technology. This technology enabled larger crystal grains for the TFT silicon and a smoother boundary between the grains. It allowed LCD drive circuitry to be built onto the glass substrate, thus improving reliability and lowering production costs, and this made an ultra-high-definition LCD panel possible. Mass production began at the Tenri Plant in 2002, and a dedicated System LCD plant, Mie Plant No. 3, was built the following year.

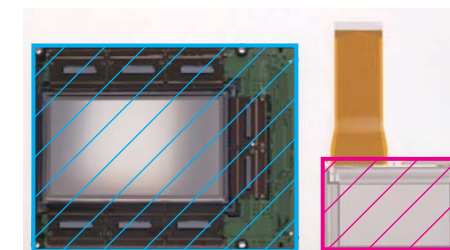

A System LCD (right) has fewer peripheral components and requires a smaller mounting area (shown with diagonal lines) than conventional LCDs. The photographs provide a comparison for LCDs used in projectors.

Development of 3D Image Display Technology

In July 2002, Sharp developed a groundbreaking 3D LCD that didn't require special glasses to be worn by the viewer. Three-dimensional view was achieved by creating a parallax barrier to deliver different images to the left and right eyes. It was used for the SH251iS mobile phone from NTT DoCoMo and for the Sharp PC-RD3D notebook PC. It also received attention from the education and entertainment industries.

Expansion of the Electronic Device Business

Development of 3D Image Display Technology

To further improve LCD image quality, for which Sharp was the world leader, the company developed high-performance LCD drivers. Examples include the LH168D, introduced in 1997, which reduced shadow and flickering between neighboring pixels; and the LH168R, introduced in 1999, which reduced the variance in brightness between pixels.

For imaging devices, Sharp created a lineup that included CCDs as well as C-MOS sensors that were easy to put together with other peripheral circuitry. The company also developed a small camera module, which incorporated a C-MOS sensor, lens, and signal processing LSI in a single unit. Responding to advancements in image quality of camera-equipped mobile phones, Sharp created a small and thin megapixel CCD (i.e., one with more than one million pixels).

In 1998, for the first time in the world, Sharp succeeded in creating a stacked CSP for mobile devices that layered two LSIs to fit in a smaller package. This enabled the creation of smaller devices.

Progress in Laser Diodes for Optical Drives

In infrared lasers for CD-R devices, efforts were made to achieve faster writing speeds by increasing power output. The development of the red lasers needed for DVD devices also progressed. Responding to a surge in demand, Sharp built the Mihara Plant in Hiroshima Prefecture in 2002. In addition to the production of infrared and red lasers, this plant would make blue-violet lasers for Blu-ray Disc devices in the future.

Progress in Creating Energy from Solar Cells

The Japanese government carried out programs to popularize residential photovoltaic power systems. In response, Sharp accelerated efforts to increase conversion efficiency and lower costs in order to expand the market. In 2000, the company developed a solar module that allowed light to pass through it. Able to be used on walls, windows, and building eaves, it created new applications and improved the image of solar cells.

In 2000, Sharp reached a power-producing capacity of 50.4 MW and had a world-leading 17.5% global market share (according to US industry magazine *PV News*). Cumulative production surpassed 1 GW in 2004, and Sharp maintained its number one position in market share for seven consecutive years until 2006.

* CG-Silicon (continuous grain silicon) was developed in cooperation with Semiconductor Energy Laboratory Co., Ltd.

6 Debut of AQUOS LCD TVs

Production and Sales Working Together on LCD TVs

■ Achieving 10,000 Yen per Inch

In January 2001, the introduction of a number of new products heralded the advance of Sharp's LCD TV declaration: the 20-inch LC-20C1, the 15-inch LC-15C1, and the 13-inch LC-13C1. From this point forward, Sharp's LCD TVs bore the nickname AQUOS. It was a newly coined word that combined "aqua" (water) and "quality" to express the image of liquid crystals.

This C1 series delivered a clear image even in a room with bright sunlight coming in. It also surpassed CRT TVs in terms of environmental performance, as it used less energy and fewer resources and offered a longer service life. The series also presented a new style of TV viewing with new functionalities, such as the ability to mount the TV on a wall or floor stand or move it easily from room to room as desired.



A volume display of the AQUOS lineup (at a Joshin Denki store)

■ Moving Toward Larger 30-Inch and 37-Inch Screens

Around that time, most large, flat-panel TVs were plasma TVs. But Sharp started working on producing larger LCD TVs to stoke demand for larger TVs in the home.

In November 2001, the LC-30BV3 was introduced. Using the newly developed 30-inch wide-panel Advanced Super-V Low-Reflection Black TFT LCD (1,280 x 768 pixels), it featured wide viewing angles and high contrast even in a bright room. It was compatible with BS digital broadcasting, which started in Japan in 2000, and displayed high-definition pictures from digital HDTV broadcasts.



Press event announcing the release of a new AQUOS, the LC-30BV3 (September 28, 2001)

In 2002, the 37-inch LC-37BD5 was introduced. It incorporated the HDTV LCD Panel (1,366 x 768 pixels) and also utilized Quick Shoot (QS) technology that ensured clear images even in fast-moving scenes. The shipping volume of AQUOS, including the 37-inch model, reached a million units within just two years of its introduction.



The C1 series aimed at a price range of 10,000 yen per inch—the target for popularizing the lineup. The suggested retail prices were 220,000 yen for the 20-inch model, 155,000 yen for the 15-inch model, and 88,000 yen for the 13-inch model.

A world-renowned product designer, Toshiyuki Kita, designed the product with a unique and subtle style that was seen as warm and appealing.

To raise customer awareness of the products, sales departments carried out the LCD Big Bang Strategy, which involved presenting ideas to retailers on how to effectively display LCD TVs in their stores. LCD TVs started selling well as their attractive features—such as user friendliness and compatibility with other digital devices—were gradually recognized.

In August 2001, Sharp introduced several new models, including the 20-inch LC-20B1 with side speakers. The LC-20B1 incorporated the newly developed Advanced Super-V Low-Reflection Black TFT LCD that enabled a clear, high-contrast image that could be viewed from any angle.

Entering the Mobile Phone Market with Determination

■ Development of a Camera-Equipped Mobile Phone

Sharp's mobile communication terminal business first introduced a mobile phone in 1994 and grew the business centering on PHS (Personal Handy-phone System) devices. However, as Sharp was late to enter the mobile phone market, sales growth was less than desired. As users' interest in PHS waned, sales declined.

In that environment, Sharp was asked by Digital Phone Group—the predecessor of J-Phone (now Softbank Mobile Corporation)—to cooperate in the development of a mobile phone suited to a new text information service called Skyweb. In 1998, Sharp developed the popular J-SH01, which could display text messages that were eight characters by six lines long. Shipping the product in time for the new service was the key to its success; this became the first step for Sharp to grow in the mobile phone business. In December 1999, the company delivered the J-SH02, which was equipped with a color LCD.

Next, Sharp worked with J-Phone to co-develop the industry's first mobile phone equipped with a camera. This was timed to coincide with the development of communications infrastructure that enabled users to send and receive photos as e-mail attachments. The J-SH04 made its debut in November 2000. On the back of J-Phone's sales campaign the following year, sending photos instantly by e-mail quickly became a new norm for communication among young people.

Further, in December 2000, Sharp introduced the J-SH05, a flip-type mobile phone with a TFT LCD that could display 65,536 colors. In June 2001, the company began delivering the J-SH07, a flip-type mobile phone equipped with a camera and TFT LCD.



J-SH04 (left) and J-SH05. There were some months when these two phones occupied the number one and number two positions in J-Phone's sales rankings by model.

■ The Fusion of Technology to Produce Mobile Phones

Sharp's mobile phones grew through the fusion of product and device technologies.

For the camera in the J-SH04, Sharp developed a 1/7-inch 110,000-pixel C-MOS image sensor with a lens incorporated to save energy and make the product smaller. Its energy consumption was roughly one-fifth of Sharp's conventional CCDs, and the thickness was reduced from 10 mm to 5 mm.

Working hard to develop fonts that were easy to read on LCDs, Sharp created the LC Font, which looked bigger than other fonts at the same size. In 2001, LC Font C was developed for color LCDs and included in the J-SH07.

In October 2002, Sharp's service company, SDS, opened a support center for mobile phone repairs and provided after-sales service.

The 1-Bit Amp—Revolutionary Sound Quality

Sharp developed unique technology in the audio area as well. Working in cooperation with Waseda University, the company succeeded in developing 1-Bit digital amplifier technology. This technology enabled playback that was extremely close to the original sound by using a sampling rate of 2.8 million times per second—64 times faster than the CD sampling rate of 44,100 times per second. August 1999 saw the introduction of a high-end 1-Bit amp, the SM-SX100. Its high quality surprised audiophiles and became big news. 1-Bit technology was also energy-efficient: it required only about half the power of an analog amp during normal use. It also enabled engineers to make even smaller products. This technology went on to be used for AQUOS TVs and portable MD audio products.

In November 1998, the cumulative production of Sharp's MD audio products surpassed 5 million units. At that time, the company's domestic market share of portable audio equipment such as MD headphone players was over 20% (based on Sharp research). The company went on to maintain a large market share for the next ten years or so.



The high-end SM-SX100 1-Bit amplifier

7 Plasmacluster Devices and Other Products with Distinctive Features

Debut of a New Type of Appliance

Development of the World's First Plasmacluster Air-Purification Technology

In 1998, Sharp was searching for new technology to make its air purifiers more competitive. Conventional air purifiers took in dirty air and cleaned it with filters, but they could not reach all the dirty air in a room. Sharp sought a method that would work directly on the air.

Researchers found out that when white blood cells attack viruses in the human body, they generate positive ions (H^+) and negative ions (O_2^-). About the same amount of H^+ and O_2^- ions exist in areas filled with clean air, such as in forests, and they are entirely safe for human health. Researchers thought to adopt this method to purify air and started researching ways to release H^+ and O_2^- ions simultaneously. They developed a method of generating the ions using plasma discharge. After repeated experiments, they created the Plasmacluster Ion (PCI) generator.

Sharp commissioned the Ishikawa Health Service Association to test the action of generated ions on airborne mold and bacteria, which are the cause of bad odors. They determined that the ions could, within one hour, eliminate 90% of black mold and bacteria in a room.

Based on such research, Sharp developed "academic marketing." This involved having an independent scientific research organization validate the effectiveness of Sharp products, and it became an important method of promoting them to the general public.

Among heightened expectations for a commercial application, Sharp released the FU-L40X PCI air purifier in October 2000.

In 2001, Sharp used PCI generators in air conditioners, clothes dryer/dehumidifiers, refrigerators, humidifiers, and humidifying ceramic fan heaters. In 2002, more PCI products were introduced, such as cyclonic vacuum cleaners.

Sharp aimed to put PCI wherever there's air and marketed PCI generators to various industries for use in a wide variety of applications, such as toilets with bidet seats, car air conditioners, gas fan heaters, and elevators.

Utilizing Cyclone, Ag⁺, and Other New Technologies

Under a policy stating that "mature products can be transformed into growth products through the development of new technology," Sharp introduced other home appliances in addition to PCI-equipped products.



The EC-AC1 cyclonic vacuum cleaner eliminated the need for paper bags. A high-speed cyclonic airflow centrifugally separated dust from the air, keeping the exhaust air clean. (2000)



The ES-DG703 drum-type washer/dryer gave a long-lasting deodorizing effect to clothes by dissolving Ag⁺ (silver) ions in the rinse water. (2003)



The QW-A60 dishwasher cleaned everyday dishes using salt, with no need for detergents. (2002)

Meanwhile, a new refrigerator production line began operating at the Yao Plant in September 2001. This was done to support a redevelopment project for the Ryuge district in Yao City and also to make production more cost-effective by consolidating the refrigerator plants in one place.

Progress in Personal Information Devices

Creating a Sensation with Uniquely Featured PCs

In 1998, Sharp introduced the Mebius PC-PJ1, an easily portable B5-file-size notebook PC. June 2001 saw the introduction of the Mebius Muramasa PC-MT1-H1, which was just 16.6 mm thick at its thinnest part. The thin design resulted partly from its use of a robust magnesium frame.



At the time, the world's thinnest and lightest notebook PC with a 12.1-inch LCD, the PC-MT1-H1

Development of unique software was carried out along with hardware development to make Sharp PCs more convenient. The Power E/J translation support software was one example; it was included with Mebius products and also sold as a software package.

Raising Value and Enhancing Convenience with Information Services

In March 1999, the Sharp Space Town information service was launched to provide Internet connection services and to distribute applications and content for Zaurus and Mebius products. The coordinated development of software, content, and hardware gave rise to high-value and convenient products and services, such as the Zaurus Library e-book service.

For the Zaurus line, the company developed products with unique features, such as the MI-E1, which had a slide-out keyboard (2000), and the SL-A300, which used the Linux OS (2002).

Keeping a Large Market Share in Facsimiles

Sharp led the home facsimile market, holding the number one market share in Japan for 11 consecutive years from 1996 to 2006 and the number two slot from 2007 to 2011 (as of 2012)*1. During this period, the company introduced numerous products with unique features, such as the UX-E1CL color facsimile (1999) and the UX-W50CL (2001), which was compatible with NTT's L Mode information service.

Development of Business Information Devices

Introducing a Series of Digital MFPs

In 1998, a new series of MFPs (multifunctional printers) was born—a 3-in-1 unit, which combined copier, fax, and printer functions in one. The AR-F280R was an epoch-making product: it wasn't just multifunctional, it was also a space saver. After that, Sharp introduced a number of MFPs with unique features, such as a color model. Sharp's cumulative global copier production surpassed 10 million units in April 2000.



The AR-C150 digital full-color MFP with a tandem-printing engine used four in-line drum for printing (1999)

Adding Information Security Functions to MFPs

Sharp was one of the first companies in the industry that looked into security issues relating to digital MFPs. Because the machines temporarily stored electronic data in internal memory before printing, there was a risk of confidential information being retrieved from the memory (hard disk or other memory).

To meet the procurement standards of the US Department of Defense, Sharp began developing technology that could encrypt digital data for temporary storage and automatically erase that data after using it. In April 2000, the company introduced a data security kit for overseas markets. Acquiring Common Criteria EAL2*2 from a US certification organization in April 2001 enabled Sharp to deliver products to governmental organizations and financial institutions around the world.

SDS—Sharp's sales and service company for MFPs—acquired information security management system certification in 2003 and promoted "Sharp for security" as a selling point.

Efforts for the Public Sector

Around this time, Sharp was receiving positive reviews of its unique system products. In February 1998, SSP delivered a job-finder search engine system to a government employment service center in Osaka. This was well received and led to Sharp delivering such systems to other employment service centers nationwide.

Mechanism to eliminate bacteria using Plasmacluster Ions (conceptual drawing)

Plasmacluster Ions have a long life*, as they are surrounded by water molecules

- 1. Ions are released into the air**
Positive (H^+) and negative (O_2^-) ions are generated through plasma discharge and released into the air.
- 2. Ions decompose mold fungi and bacteria**
When Plasmacluster Ions come into contact with the surfaces of mold fungi and viruses, they turn into highly oxidizing hydroxide (OH) radicals that instantly remove hydrogen (H) from surface proteins, breaking them down.
- 3. Ions return to the air as water**
The OH radicals bond with hydrogen (H) to form water (H_2O), which returns to the air.

* Compared to ions that are not surrounded by water molecules (Sharp study)

*1 Share in the facsimile market from 1996 to 2011.

According to a survey by GfK Japan on sales performance at major consumer electronics retailers in Japan, based on share of sales volume by manufacturer.

*2 The Common Criteria is an international accreditation standard for evaluating the security levels of hardware, software, and information systems. EAL2 means "evaluation assurance level 2."

8 Revamping Overseas Marketing Strategy and Japanese Operations

Global Debut of AQUOS and Four-Region Strategy

■ Debut of AQUOS in the US

Following the domestic debut in January 2001, Sharp proceeded in cultivating overseas markets for AQUOS TVs. Initially, there were numerous challenges.

In the US market, Sharp needed to convince dealers that LCD TVs would surely replace CRT TVs, and that Sharp would make that happen. However, LCD TVs were expensive, with prices between \$4,500 and \$5,000, compared to CRT TVs priced around \$200. And because digital broadcasting had yet to go mainstream, the company couldn't demonstrate the beautiful image quality of AQUOS in stores. Consequently, Sharp had a hard time selling the products.

Initially, Sharp targeted the "innovator" segment—people with an appreciation for design and superior features—and sought to have the TVs displayed in specialist high-end AV stores. In its initial marketing, the company emphasized the luxuriousness, innovative features, and superb design of AQUOS by having them displayed at high-end interior design shops and at selected trade shows. This approach was deemed a success. Prior to the debut of AQUOS, Sharp exhibited LCD products—ranging from 3 inches to 300 inches in screen size—at the 2000 Consumer Electronics Show. Sharp was making a strong impression as the leader in LCD technology.

■ Pan-European Marketing Strategy and Four-Region Strategy

Sharp implemented a pan-European marketing strategy. In 2000, coinciding with the release of its LCD TVs, four of Sharp's sales companies (SEEG in Germany, SUK in the

UK, SEF in France, and SEIS in Italy) carried out a branding campaign under the slogan, "Bringing LCD to Life." In August 2001, the time was ripe for the debut of AQUOS at IFA 2001, Europe's largest exhibition of AV and multimedia products.

Regarding overseas strategy around that time, Sharp was adjusting its approach to newly emerging countries to reflect regional differences in culture, living conditions, and product penetration rate. Through its four-region strategy, the company especially strengthened measures in the four emerging regions of China; the Middle East and Africa; Central and South America; and Central and Eastern Europe (including CIS*) in order to expand business.

In Central and Eastern Europe, Sharp established a branch office of its Austrian sales company, SEA. This was set up in Poland—the biggest market in Eastern Europe—in 2000.

In China, which was becoming increasingly important as a large consumer market, Sharp pursued an expansion strategy centering on value-added products and mainly targeting the wealthy segment of the population. Sharp opened China's first 24-hour call center in 1999. Then, in 2003, it established a home-appliance R&D center to design and develop home appliances for the Chinese market in cooperation with the design and development departments in Japan. Sharp made progress in cultivating the Chinese market with these measures as China accelerated the opening up of its market after joining the World Trade Organization (WTO) in 2001.

Expansion in the four regions was accompanied by the establishment in 1999 of a sales company in South Korea: Sharp Electronics Inc. of Korea (SEI). In 2000, Sharp Business Systems (India) Ltd. (SBI) was established in India as a sales company for information equipment.



At CES in January 2003, a total of 320 AQUOS TVs were on display, with 40 being used to create a giant wall

■ Progress in Overseas Production

To respond to regionalization in the global economy—for example, the elimination of certain regional tariffs—it became an urgent priority for Sharp to develop a new system for production.

LCD TV production began at SEES in Spain in 2002. In 2003, Sharp began collaborating with Loewe Opta GmbH—a German manufacturer of high-end AV equipment—to develop and distribute LCD TVs. SEES produced some of these TVs as well. In the same year, SEMEX in Mexico began production of AQUOS TVs.

As interest in solar power increased in the US, SMCA began production of solar modules in the US in 2003. With demand also increasing in the European market, triggered by the implementation of feed-in tariffs in Germany and other countries, SUKM began production of solar modules in the UK in 2004.

In Asia, the number of manufactured products increased, thanks to rapidly improving technological capabilities. In 1998, for example, SRC in Malaysia began assembling the pickups for MD audio products—a highly skilled process—and then established an integrated production system for MD audio products.



A ceremony to commemorate the start of portable MD recorder production at SRC in 1999

Around this time, the spirit of cooperation was strong among production facilities in Asia. When the currency crisis that started in Thailand spread through Asia in 1997, Sharp companies—especially SEM in Malaysia—responded as a group by rescuing facilities in the country that had deficits in their foreign currency reserves.

Production started in 2001 of Malaysia's first large-scale LSI manufacturer, 1st Silicon (Malaysia) Sdn. Bhd. Sharp had provided technology transfers upon request from the Malaysian government. In 2002, Sharp cooperated with El-Araby, the largest manufacturer of consumer electronics in Egypt, for technological assistance, production, and sales. Production started in 2004, and most of the air conditioners it produced were sold under the Sharp brand in Egypt.

Sharp also established development bases to help in the efficient development of global products. In 1999, Sharp Software Development India Pvt. Ltd. (SSDI) was established in India. It started with the development of software for digital MFPs based on basic designs supplied by SLA in the US. In 2001, Sharp Telecommunications of Europe Ltd. (STE) was established in the UK to develop mobile communications software and provide testing and certification services.

Revolutionizing Sales and Service Systems in Japan

In July 1998, two specialized sales companies were established by combining the related departments of existing sales and service companies in the areas of electronic office equipment (centered on digital MFPs) and solar power systems—two areas that offered promise for future growth. Sharp Document Systems Corporation (SDS) performed sales and maintenance of MFPs and other devices, sold consumables, and provided maintenance of system devices and mobile phones. Sharp Amenity Systems Corporation (SAS) made sales, design, and installation of solar power systems its core business.

In October 1998, Sharp's sales companies for home appliances and information products—formerly SEH and SLH—merged to become Sharp Electronics Marketing Corporation (SEMC) (which covered all of Japan except the Okinawa district). The purpose of this merger was to strengthen the front line of sales and to streamline operations.

Sharp also reviewed customer service from a customer satisfaction perspective and opened the industry's first Comprehensive Call Centers to respond to all inquiries without dividing services by products (e.g. home appliances or information/communication products) or by the nature of the inquiry (e.g. shopping guidance, technical support, or repairs). Centers opened in Yao (Osaka Prefecture) and in Makuhari (Chiba Prefecture) provided smooth assistance that utilized an advanced system. These centers received positive media attention.



The Comprehensive Call Center was systematized so that specialists could provide quick and precise responses

* The CIS (Commonwealth of Independent States) was formed among former Soviet nations.

Chapter 10 | 2004 - 2006

Birth of the “Kameyama Model” Large-Screen AQUOS

The Kameyama Plant carried out integrated manufacturing of TVs, from panel production to final product assembly.

With a state-of-the-art manufacturing process that could only be implemented in Japan, Sharp introduced popular high-quality LCD TVs that came to be known as “Kameyama models.”

Based on the principle that environmental technology is crucial to a company’s growth, Sharp gradually expanded sales of products such as energy-creating solar cells and energy-saving LCD TVs. Sharp strove to become a company with zero global warming impact by offsetting the greenhouse gases emitted from its business activities with an equal proportion of greenhouse gas reductions through its energy-saving and energy-creating products.

In overseas markets, Sharp rapidly expanded business in China.

Internal structure of an LCD, with multiple layers

1 Construction of the Kameyama Plant

Vertically Integrated Plant

■ Increasingly Larger and Higher-Quality Panels

Sharp knew that for LCD TVs to proliferate they must become a household’s main living room TV, and that this would require an abundant supply system for large LCD panels. Digital HD (high-definition) broadcasting was coming to Japan and TVs would have to be able to support large, high-resolution images.

In October 2001, Sharp had a concept for a plant that could produce either eight 32-inch LCD panels or six 37-inch panels from one large glass substrate. These panels offered superior performance to conventional TFT panels in terms of response time, viewing angle, and contrast.

In February 2002, the decision was made to build a new plant in Kameyama City, Mie Prefecture. This would be in close proximity to Sharp’s LCD development and production plants in Mie and Tenri and near a cluster of companies in the same industry.

The project required the close cooperation of Sharp partners, since large-scale equipment and new materials were needed.

■ Construction Starts at Kameyama

In September 2002, the ground-breaking ceremony was

held for the Kameyama Plant. This plant would use sixth-generation glass substrates measuring 1,800 mm x 1,500 mm in a vertically integrated process from panel production to final TV assembly.

The path from initial equipment installation to eventual stable manufacturing was fraught with difficulties. It was no simple task to carry out highly detailed processing of huge glass substrates; nor was it easy to realize TVs with a fast response, wide viewing angle, and high contrast. There was much trial and error at first, since nobody at Sharp had experience with an integrated process covering everything from panel production to final TV assembly. Solving each problem as it arose, Sharp finally established a stable mass-production system for the plant in late 2003.

Operation Starts at Kameyama

■ A Model for Japanese Manufacturing

Sharp continued to improve its products and production lines by combining LCD technology and imaging technology and coordinating among its development and production divisions. Sharp’s aim was to achieve Japanese-style manufacturing through a virtuous circle—what it called a “spiral effect”—of development and manufacturing strengths. After six months of operation, the plant’s yield ratio for LCD panels was approximately 90%.

Sharp also successfully shielded the intellectual property of its valuable production technology, including methods and know-how. Rather than using “as is” the production equipment that it ordered from manufacturers, Sharp ensured production secrecy by incorporating proprietary modifications and firmware installations into the equipment.



Sixth-generation glass substrate (right) from Plant No. 1 and eighth-generation glass substrate (left) from Plant No. 2, which started operations in August 2006

■ Kameyama Brand Large-Screen LCD TVs

The Kameyama Plant began shipping TVs on January 28, 2004. An unusually large contingent of journalists were on hand to cover the event, which marked something of a rebirth in Japanese manufacturing. At stores around the country, consumers began asking for Kameyama models by name. Sharp labeled each TV made here a “World-Class

Kameyama Model” as part of a marketing strategy that capitalized on the factory’s brand power. Kameyama became synonymous with Japanese manufacturing, and in March 2005 made-in-Kameyama AQUOS models reached a cumulative production total of 1 million sets.



POP for Sharp’s Kameyama model

■ Start of Kameyama Plant No. 2

Kameyama Plant No. 1 was suited to producing 32- and 37-inch LCDs, but Sharp needed a system for producing the 40- and 50-inch models in demand as the primary TV in homes around the world. Kameyama Plant No. 2 began operations in August 2006, making TVs using eighth-generation glass substrates measuring 2,160 mm x 2,460 mm—at that time, the largest in the world. To make the next generation of panels, the new plant boasted production technologies such as glass substrate transport equipment, liquid crystal drop apparatus, and inkjet printing for color filters. Through revolutionized production methods, Kameyama Plant No. 2 was able to achieve double the investment efficiency of Plant No. 1. In short, Kameyama was a huge step forward in large-screen TV production.

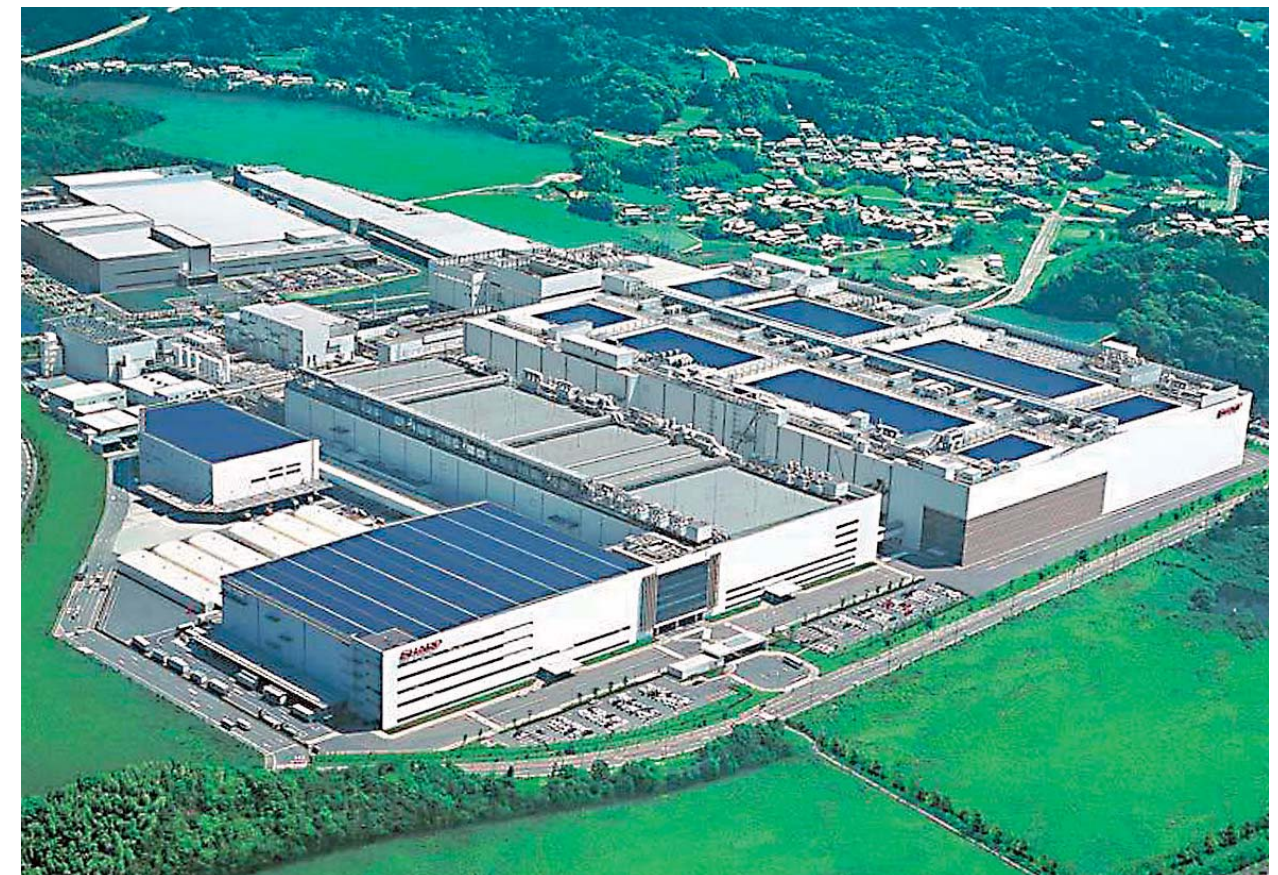

The Kameyama Plant: Plant No. 1 is in the foreground and Plant No. 2 is behind and to the right

2 AQUOS for the World

Environmentally Friendly Plant in the Spotlight

The Kameyama Plant wasn't just a cutting-edge facility that revolutionized manufacturing. It was also Sharp's first Super Green Factory*¹, achieving environmentally friendly operation through reduced CO₂ emissions and 100% recycling of wastewater. It was also specially built to withstand natural hazards such as earthquakes and lightning.

Production process wastewater recycling: Almost 100% of the water used in the LCD panel manufacturing process is purified and recycled. A wastewater collection plant using biotechnology breaks down noxious odors and reduces the amount of organic sludge.

Solar power system: A 5,201 kW-capacity solar power system produces enough electricity for about 1,300 average homes. It contributes to CO₂ emission reductions of 3,400 tons a year.

Fuel cell system: The plant has a 1,000 kW-capacity molten carbonate fuel cell that gives off almost no air pollutants such as NO_x and SO_x. Able to generate electricity at night and on rainy days, the system contributes to CO₂ reductions of approximately 3,000 tons a year.

Cogeneration system: This system uses LNG (liquefied natural gas) delivered by a pipeline to generate approximately 26,400 kW on site. To ensure effective use of energy, the system's waste heat is used for air conditioning and hot water heating.

Zero emissions: Right from the start of operations, the plant achieved zero landfill waste by recycling industrial waste—such as glass fragments mixed with liquid crystals—and by reusing liquid chemical waste.



There are approximately 570 seismic dampers inside the plant for absorbing earthquake vibrations

In recognition of these and other environmental measures, the Kameyama Plant has received numerous industry awards, including the Economy, Trade and Industry Minister's Prize in the 8th Japan Water Awards (sponsored by the Japan Water Award Committee).

A 10,000 kW superconducting magnetic energy storage system can counter sudden drops in line voltage (line-drops) that result from lightning strikes and other natural phenomena. Plant No. 2 has a seismic damper system that can absorb the vibration of an earthquake, and this proved effective in neutralizing an intensity-5 earthquake that struck in April 2007.

AQUOS Lineup Expands

In January 2004, the Kameyama Plant shipped its first AQUOS models: 37-inch LC-37GD1 G Series Advanced Super-V LCD TVs boasting extremely realistic images and the industry's highest resolution of approximately 1.05 million pixels. In August of that year, Sharp released the LC-45GD1, a 45-inch AQUOS with full-HD resolution of 1,920 x 1,080 pixels. Sharp engineers believed that since TV stations were broadcasting with 1,080 vertical lines, TV manufacturers should not offer receivers with fewer lines. Compared to plasma TVs, LCD TVs could offer exquisite detail and thus the ability to reproduce HD broadcasts with all their original beauty.



The LC-37GD1 G Series AQUOS: superior image quality along with energy efficiency and other environmental benefits

Sharp introduced the 65-inch LC-65GE1 in August 2005. With its huge screen sizes, full-HD quality, expansive product lineup, and environmental design, the AQUOS solidified Sharp's position as the leader in flat-panel LCD TVs.

In October 2006, Sharp introduced six models, including the 52-inch LC-52GX1W model, that used Kameyama Plant No. 2 panels and boasted the world's highest contrast ratio and fastest response (at the time)*².

Sharp continued to stoke demand for AQUOS TVs by giving them better images, bigger screens, and greater energy efficiency. In May 2006, the cumulative production total of AQUOS TVs surpassed 10 million sets.

In August 2006, Sharp announced AQUOS FamiLink, which offered control of other products—such as a high-definition recorder—with a single AQUOS remote

controller. People could now enjoy a full range of audio-visual enjoyment with AQUOS at the core.

5-Pronged Worldwide LCD Production System

AQUOS had acquired significant market share in Japan and in 2004 Sharp began a push to make it a globally recognized brand. The message of the 'More to See' campaign was that AQUOS was a high-end TV that showed viewers all the details.

To bring its extensive product lineup closer to consumers, Sharp began selling AQUOS through large-volume retailers such as Best Buy Co., Inc. in the US. As a result of these efforts, Sharp TVs held a dominant 33.5% market share (No. 1) in the first half of 2004, far outcompeting the second-place brand at 14.4%.



President Machida announces Sharp's global LCD TV strategy at the IFA trade show in Germany

On August 31, 2006, at the IFA consumer electronics and appliance show in Berlin, Germany, President Machida announced the company's global strategy for LCD TVs. The same day, it was announced that Sharp would release AQUOS models from the Kameyama Plant No. 2 simultaneously on October 1 in Japan, North America, and China. This marked the end of Sharp's previous policy of releasing products in Japan prior to releasing them elsewhere.

To execute this strategy, Sharp built a five-pronged worldwide production system that enabled the company to promptly meet LCD TV demand in different markets. Peripheral electronic components were mounted onto large LCD panels made at Kameyama Plant No. 2 and the actual TVs were assembled in the region where they were to be sold. The lines of SEMEX in Mexico were updated for

delivering products to the North American market; meanwhile in Europe, Sharp established Sharp Manufacturing Poland Sp. z o.o. (SMPL) for the production of LCD modules (which started in January 2007). SMM in Malaysia and NSEC in China were also given LCD module production capabilities, thus completing Sharp's five-pronged worldwide system.

Evolution in Small- and Medium-Size LCDs

Switchable Viewing Angle LCD and Dual Directional Viewing LCD

Sharp succeeded in developing a technology for controlling the viewing angle of an LCD. In 2005, the company developed the Switchable Viewing Angle LCD, which narrowed the left and right viewing angles to prevent people nearby from seeing the screen. This technology was adapted for use in mobile phones and other products. The Dual Directional Viewing LCD, meanwhile, allowed simultaneous viewing of two different images on one screen—i.e., from the left or right angles. This was used in products such as car navigation systems.

In April 2009, Sharp released a notebook PC with a proprietary optical sensor LCD for the touchpad. This offered beautiful image display, and its touch-sensitive interface made it ideal for handwritten input and gaming.

Sharp Yonago Corporation

In June 2005, Sharp took over a factory from Fujitsu Limited and established Sharp Yonago Corporation. The plant produced small- and medium-size LCDs from 2 to 10.4 inches for use in applications such as mobile phones, car navigation systems, and digital cameras.

*1 A factory that has achieved in-house standards for criteria such as greenhouse gas emission reductions, proper disposal of industrial waste, and efficient use of water.

*2 For digital HD LCD TVs.

3 Continuing Efforts to Protect the Environment

Zero Global Warming Impact Company

In 2004, Sharp announced its goal of becoming a zero global warming impact company by 2010. The aim was, by fiscal 2012, to offset the greenhouse gases emitted from its worldwide business activities (A in the illustration) with an equal proportion of greenhouse gas reductions through customer use of its energy-saving and energy-creating products (B in the illustration). This was in line with the Kyoto Protocol (adopted in 1997) for reducing countries' greenhouse gas emissions.

In 2004, when Sharp made this announcement, it was believed that environmental protection would be costly and would hurt corporate growth. However, Sharp's position was that a company could not grow without environmental technologies.

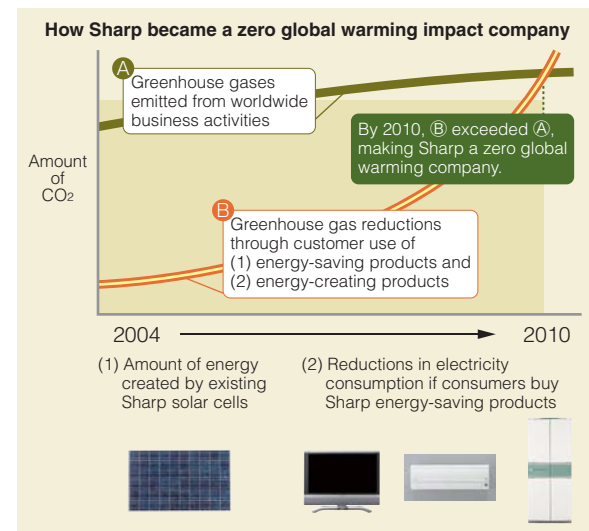

While reducing greenhouse gas emissions from its plants, Sharp also improved the conversion efficiency of its solar cells, expanded its solar power business, and

manufactured and sold more LCD TVs and other energy-saving products. The result was a dramatic reduction in greenhouse gas emissions and the achievement of its environmental vision in fiscal 2008, two years ahead of schedule.

Environmental and Social Contribution Activities

Sharp launched the Solar Academy (environmental education program) in 2004, and in 2006 it teamed up with the Weathercaster Network, a Japanese NPO, to conduct eco-education in elementary schools. From 2009 onwards, Sharp added manufacturing-themed programs for elementary schools and eco-education at schools for the hearing impaired. Sharp bases in China, the US, and other countries also began educational programs for schools.

In June 2003, the Sharp Green Club (SGC) was established as a joint labor-management organization for conducting environment-related activities in the community. Its first outing, in July 2003, drew around 1,300 participants and involved a cleanup of Mount Wakakusa in Nara Prefecture.

Sharp continues to run a number of in-house eco initiatives. Employees carry out green driving practices and took part in Team Minus 6%, an initiative of the Japanese Ministry of the Environment. Since 2005, employees have been dressing lightly in summer and more heavily in winter, so that offices use less electricity for air conditioning.

In October 2008, Sharp established a department to plan and carry out social action programs. Since then, the company has striven to be a good corporate citizen by expanding activities focusing on the environment, education, and social welfare.

by the micro-crystalline thin film. This made it possible to increase conversion efficiency to 11%, 1.5 times the rate of amorphous silicon thin-film cells. Sharp began production of tandem thin-film solar cells in 2005, and by 2008 the initial annual capacity of 15 MW had increased to 160 MW.

Sharp strove to ensure a stable supply of the silicon raw material. For example, it signed a long-term supply contract for silicon wafers with a raw material producer; and in 2007 it opened its Toyama Plant for producing approximately 1,000 tons of silicon raw material annually.

In 2004, Sharp began a joint research project with NEDO—the New Energy and Industrial Technology Development Organization—under which solar power systems were installed at Sharp's main plants.

Meanwhile, Sharp continued to aggressively develop solar products and increase sales of its solar power systems. In 2004, it released a residential module system that integrated with metal roofs. In 2005, it developed new software for helping consumers find a suitable residential solar power system. With this software, the salesperson would input data on the shape and measurements of a customer's roof, and the software would use this data to design a solar power system ideal for that particular home.



Integrated solar power system for use with metal roofs

21st Century Appliances Gain Attention

Sharp began offering consumers a kitchen for the 21st century under the development theme of 'health, environment, and peace of mind' for home appliances.

Superheated Steam Oven: "Roasting" with Water

The AX-HC1 superheated steam oven, released in September 2004, was representative of this new group of products. Developed to give consumers healthy, delicious food, the superheated steam oven surrounded food with superheated steam at around 300°C. By generating about eight times*2 the heat content of standard Sharp convection ovens, the steam ovens effectively roasted food with water.

Development of the superheated steam oven began with the idea of taking a commercial superheated steam cooker, which was used for things like drying fish overnight, and adapting it to household use. As Sharp engineers conducted cooking tests, they were excited to discover that cooking with superheated steam allowed food to maintain vitamin C and other nutrients, and that it melted away excess fat and

salt content. They succeeded in producing a commercial product by developing a proprietary superheated steam generator that efficiently created superheated steam using a 100 V power source. This clearly distinguished Sharp's superheated steam oven from other companies' models, earning it instant popularity and accolades from health-conscious consumers.

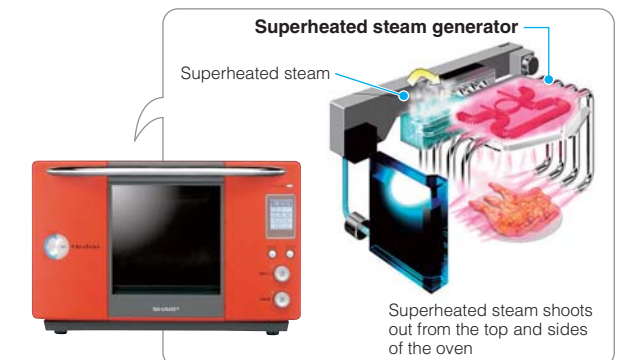

The functional, beautifully designed AX-HC1 and how it worked

In 2004, Sharp released the QW-SV1 dishwasher/dryer, which used salt to make ion-rich hard water for washing dishes. The product earned praise as a powerful and environmentally friendly dishwasher. In 2005, Sharp released the SJ-HV46J, the first refrigerator in the industry with a special compartment that could be turned into a 55°C food warmer. The product was the talk of the industry for its ability to keep dishes in the refrigerator warm and ready to eat.

Ever More Plasmacluster Ion Products

Sharp developed its Plasmacluster Ion technology in 2000, and in the following years, the technology came to be used not just in Sharp air purifiers and air conditioners but also in products from other companies in other industries—for example, in toilets, gas fan heaters, and car air purifiers. In its "academic marketing," Sharp used the results of studies conducted by universities and research institutes to show that, for example, Plasmacluster Ions inhibit the action of airborne viruses*3 and airborne mite allergens*4. In the process, the mechanism*5 of Plasmacluster Ions was also discovered.

4 Focus on Health and Environment Products

Increased Capacities for Solar Cells

The 2004 amendment of Germany's FIT*1 (feed-in-tariff) policy led to a sharp rise in solar cell demand, but there were signs of a shortage in the supply of the silicon used to make these cells. Sharp proceeded to secure access to raw materials and develop new solar cell technologies.

One of these was a technology for thin-film silicon solar cells. Although they had the advantage of using only about 1/100th as much silicon as conventional crystalline solar cells, these amorphous (non-crystalline) silicon thin-film solar cells had a conversion efficiency of 7% to 8%—only about half that of crystalline silicon cells. Sharp thus developed a double-layer crystalline tandem thin-film solar cell in which short wavelength light is absorbed by the amorphous thin film and long wavelength light is absorbed

*1 FIT: A system for spreading the use of renewable energy by guaranteeing to purchase such energy at a fixed price over the long term.

*2 Compared to the heating capacity of a convection oven per 1 m³ when cooking at 230°C. Heat energy of 1 m³ of superheated steam (230°C): 298 kcal; heat energy of 1 m³ of convection oven (230°C): 35 kcal.

*3 Based on studies conducted in 2002 by the Kitasato Research Center of Environmental Sciences.

*4 Based on studies conducted in 2003 by the Graduate School of Advanced Sciences of Matter, Hiroshima University.

*5 Based on studies conducted in 2004 at Aachen University of Applied Sciences, Germany (airborne bacteria, airborne viruses).

5 Expanding Information and Communications Business

Rocketing Mobile Phone Business

■ Sharp Becomes Leading Mobile Phone Supplier in Japan

Despite entering the mobile phone market late, by fiscal 2005 Sharp was shipping more phones than any other company in the Japanese market (according to MM Research Institute, Ltd.). Factors contributing to this success included the development of products with appealing new functions and the delivery of them to the market up to six months earlier than rival products.

Behind this strategy were proprietary device technologies such as LCDs and CCD/C-MOS cameras; vertical integration, in which technologies and their application products moved in an upward spiral of evolution; and lateral integration, whereby the most effective use was made of information-processing and imaging technologies fostered in Sharp's other company departments. Also crucial to creating attractive products was the application of high-density mounting technologies.

The area of LCDs is one such example. By equipping its phones with TFT color LCDs in place of earlier STN color LCDs, Sharp earned a reputation for being light years ahead of the competition in terms of image quality. It then cemented its reputation in 2004 when it began giving its phones Mobile Advanced Super-V LCDs, which boasted high contrast and wide viewing angles. Developments in phone camera technology allowed Sharp to come out with ever-more advanced products: 1-megapixel cameras in 2003, 2× optical zoom in 2004, and 5-megapixel cameras with 3× optical zoom in 2006.

Sharp began supplying KDDI Corporation with the W41SH mobile phone in 2006. Having already supplied products to Softbank Mobile and NTT DoCoMo, Sharp now

delivered its products to all three mobile phone companies in Japan. In 2005, Sharp made the W-ZERO3 mobile communication tool for Willcom, Inc., a PHS provider.

■ AQUOS Phone for One-Seg TV

April 2006 in Japan heralded the start of One-Seg, a technology using a segment of each terrestrial digital television channel's bandwidth to carry broadcasts for mobile devices. Sharp began developing compatible mobile phones to coincide with the start of this service.

Sharp first had to develop a proprietary One-Seg TV tuner that was ultra-compact, energy-efficient, and extremely sensitive. The company also developed its unique "cycloid" style swiveling screen for natural TV watching. The LCD could rotate 90° to a landscape orientation for natural TV viewing. Sharp also applied AQUOS technologies to create a phone with a high-quality TV screen. These development efforts were rewarded when the Vodafone 905SH AQUOS Phone was released in May 2006 to an enthusiastic reception from the market. The company reaped the rewards of this run of new models by shipping more than 10 million phones in Japan in fiscal 2006.



The "cycloid" style of the Vodafone 905SH allowed it to rest stably on a flat surface

Sharp's Personal Communication Systems Division, which handled the mobile phone business, enjoyed skyrocketing sales, going from 20 billion yen in fiscal 1998 to 560 billion yen in fiscal 2006.

CCD/C-MOS Image Sensors Exceed 100 Million Units in Cumulative Sales

Since 1980, Sharp has been continuously expanding its lineup of CCD and other image sensors with ever-higher image quality. Demand jumped suddenly in November 2000 when these image sensors were adopted for camera-equipped mobile phones. In January 2004, Sharp

CCD/C-MOS image sensors reached the 100-million plateau in cumulative sales.

Camera modules for mobile phones were required to be increasingly more compact and higher in resolution. In response to these market needs, in 2006 Sharp released the LZOP3953, the industry's smallest 1/3.2-inch (optical sensor size), 2-megapixel C-MOS camera module; and the LZOP3954, the smallest camera module offering an auto-focus function.

Sharp also ventured outside mobile phones, achieving success in image sensors for products such as digital cameras and security cameras. In fiscal 2010, cumulative shipment of image sensors hit 800 million.

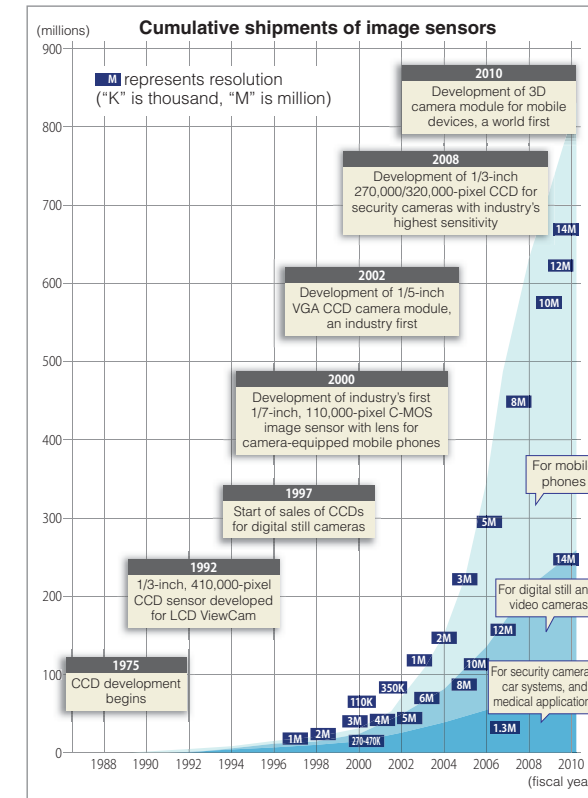

The Advance of Information Products

■ Sharp Announces Color Renaissance Concept

In March 2005, the Document Systems Group announced the Color Renaissance concept. With offices gradually moving from monochrome to color document products, digital MFPs were becoming more than just tools to make offices more efficient; they were increasingly incorporating features such as environmental performance and information security, and they were offering customers color capabilities, high image quality, and business solutions.

The development of Sharp's Mycrostoner dramatically improved image quality and environmental performance. Document devices used about 30% less of the toner, and its grains were approximately 50% finer than those of Sharp's previous products. The toner could also faithfully reproduce intermediate colors, such as skin tones, and produce copies with crisp, clear text and graphics. In November 2005, Sharp released the MX-2700FG and other models using

Mycrostoner. Since then, Sharp has been spurring a new era in office documents as it markets products under its ECOLUTION slogan. This represents three elements: ecology (the environment), a revolution of new technologies, and solutions for open systems.



The MX-2700FG provided options for protecting users' data

■ Birth of the Information Display

Major growth was occurring in the market for commercial information displays—LCDs that played the role of bulletin boards and posters. In 2005, Sharp released the PN-455, a 45-inch display that reduced glare from exterior and fluorescent lighting and that provided a high-resolution screen with high image quality that was easy to view even in bright settings. Sharp promoted this product for use in show windows and as LCD posters. With the 2006 release of the PN-655 65-inch display, commercial users could give powerful business presentations, several designers could check a CAD drawing on the same monitor, and videoconference participants felt like they were all in the same room.

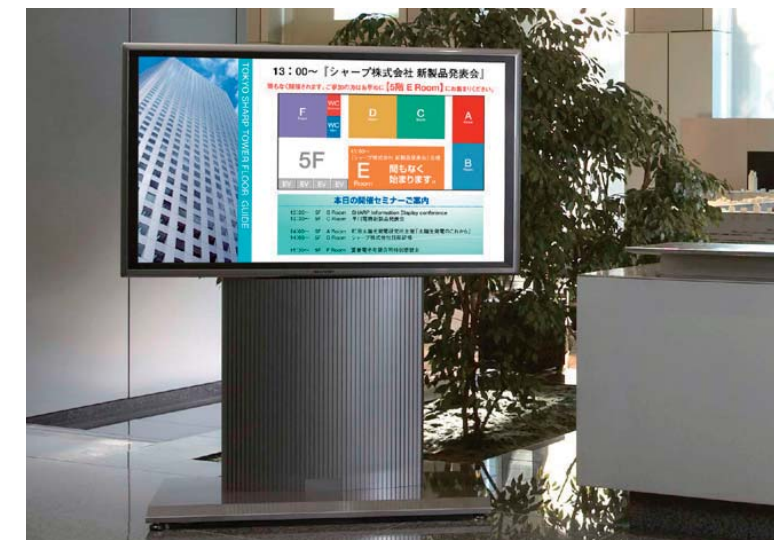

The PN-655 information display with a full-HD panel (1,920 x 1,080 pixels)



- (1) SH505i equipped with a megapixel CCD camera and System LCD (2003)
- (2) W-ZERO3 WS003SH equipped with a 3.7-inch Mobile Advanced Super-V LCD and a slide-out QWERTY keyboard (2005)
- (3) W41SH used Mobile Advanced Super-V LCDs for the main and sub displays (2006)

6 Boosting Corporate Value and Stressing Social Responsibility

Reforming Management

■ Strengthening Corporate Governance

Sharp has striven over the years to improve corporate governance through management that is more transparent, objective, and sound. One measure to this end was taken in June 2003, when the company shortened the director appointment term from two years to one year. This was done with the aim of boosting management mobility and flexibility and clarifying management responsibilities for each new fiscal year. Sharp has also built an internal control* system to ensure compliancy with Japanese laws such as the Companies Act (enacted in 2006) and the Financial Instruments and Exchange Act (2007). In July 2006, Sharp's Advisory Board was established to reflect opinions from outside experts in company management decisions. This system was dropped in June 2009 in favor of the appointment of outside directors.

■ eS-SEM Strategic Management System

In 2004, Sharp introduced the eS-SEM (e-Sharp Strategic Enterprise Management) system—based on a balanced scorecard concept—to ensure it could achieve sustainable growth. eS-SEM was a means to incorporate company-wide strategies into the action plans of all Sharp divisions and individual employees. It was also a way of ensuring that those strategies would be steadily implemented. All work would be implemented in a strategic manner, and this would lead to the creation of greater corporate value. There were four strategic focuses to eS-SEM. The first was financial success in the form of increased profits and sales. The other three represented the roads to achieving this success: customers, work processes, and human resources and reform. How well company divisions and individuals did in these four focus areas was reflected in their respective performance evaluations.

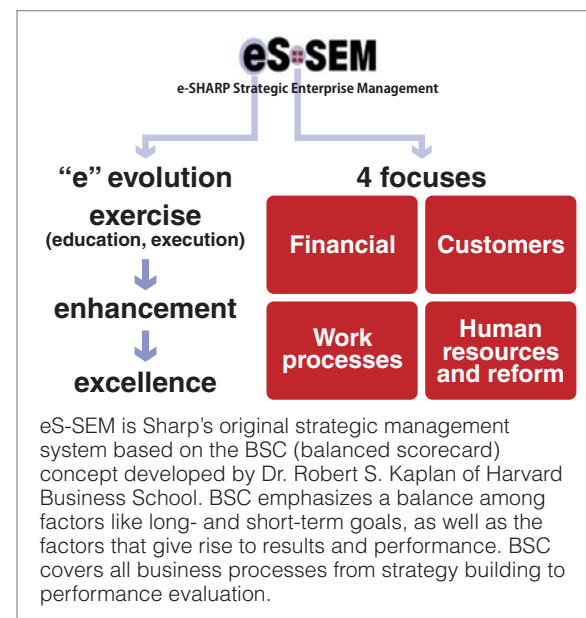

Becoming a Trusted Company

■ Company-Wide Focus on CSR

In October 2003, Sharp established the CSR Promotion Division to be in charge of all matters related to CSR (corporate social responsibility). Sharp's CSR concerns go beyond the Sharp Group to cover all business partners and all aspects of the value chain, from materials procurement to final sales to end users. Sharp also holds employee training to ensure that corporate ethics and compliance are firmly rooted in corporate culture.

As a result of these efforts, in 2005 Sharp was No. 1 overall in *Nikkei Business* magazine's CSR survey of the 2,178 companies listed on the first and second sections of the Tokyo Stock Exchange.

As part of its compliance program, Sharp has also strengthened its system for managing information security and protecting personal information.

■ Aiming to be No. 1 in Customer Satisfaction

In October 2005, the name of the Reliability Control Group was changed to the CS Promotion Group. That same year, Sharp also initiated a quality-innovation strategy for creating No. 1-quality products, and a CS-innovation strategy for becoming No. 1 in customer satisfaction. These strategies were a major reason that Sharp was, for three consecutive years from fiscal 2009, ranked No. 1 in a *Nikkei Business* magazine survey of after-sales service in key product categories such as flat-panel TVs, Blu-ray Disc/DVD/HDD recorders, washer/dryers, and air conditioners.



Sharp service engineers' goal is to keep customers waiting for product repairs for as little time as possible

* Internal control: An in-house system of proactive measures by a company to avoid and eliminate management risk and scandals. Under Japan's Companies Act (enacted May 2006), the boards of directors of large corporations (companies capitalized at more than 500 million yen, or with debts totaling more than 20 billion yen) were obligated to pass resolutions on basic policies for the establishment of internal control systems. Starting in fiscal 2010, the Financial Instruments and Exchange Act obligated listed companies (including consolidated subsidiaries) to submit internal control reports and undergo internal control audits by outside auditors.

7 Growth of the Chinese Market and International Business Measures

Growth of Business in China

China's real GDP grew at a rate of more than 10% in 2003, as the country rapidly became a global economic force. Sharp sought to achieve brand appeal among China's wealthy consumers with the market introduction of LCD TVs and other one-of-a-kind products in Beijing and in coastal cities like Shanghai and Guangzhou.

In 2004, with digital broadcasting about to take off, Sharp released the G Series AQUOS LCD TVs in Shanghai and Beijing. AQUOS represented a new generation of TVs and soon became a status symbol. Sharp also released the Ag+ (silver) ion washing machine that year. This product was a huge hit in China, because it effectively eliminated odors from laundry items—a big plus in a country where many people hang up clothes on closed balconies.



130 dealers showed up at a negotiation gathering held after the press announcement for the G Series AQUOS in Shanghai

SOCC, Sharp's production subsidiary for copiers, was working to educate its dealers about Sharp products. The company earned respect by doing everything possible to boost dealer profits through events such as joint product sales fairs and product exhibitions. At the same time Sharp expanded its sales network by utilizing its advantage of having factories in China—which allowed the company to promptly supply parts—and by establishing a nationwide service network to carry out prompt maintenance. As a result, despite Sharp's late entry into China's copier market, it earned not just a large market share but also a stellar reputation in the field of copiers.

In October 2005, Sharp Electronics Sales (China) Co., Ltd. (SESC) was established to consolidate the marketing functions previously conducted by three companies: SSEC (appliances), SOCC (copiers), and NSEC (AV products). SESC came about after laws were passed in China in 2004 allowing for the establishment of integrated sales companies. In 2004, Sharp established Sharp Technical Components (Wuxi) Co., Ltd. (STW) for the manufacture of LCD TV backlights.

Restructuring of Overseas Business

Sharp was hard pressed to reorganize itself to keep up with major changes in the international business environment: the rise of manufacturers in Korea and Taiwan, greater purchasing power by major distributors, and growth in newly emerging economies.

One measure that Sharp took was reorganization of its sales system in Europe. In 2007, SEEG in Germany was split into sales companies in charge of appliances, information products, and solar power systems. The year before that, SUK moved its headquarters from Manchester to London, where key business partners were concentrated. Reorganization at SEC in the US included creating separate divisions to market each product group and implementing a direct-sales business model for document products and other Sharp offerings.

Sharp also focused its overseas business on copiers, LCD TVs, and solar cells. In fiscal 2006, these three product categories accounted for approximately 70% (about 574 billion yen) of all Sharp overseas sales on a monetary basis—sales figures were up approximately 1.7 times over fiscal 2004.

Sharp made a foray into the European mobile phone market with the October 2002 release of the GX10 mobile phone with color LCD for carrier Vodafone Group Plc. In September 2004, T-Mobile USA, Inc. released the PV-100 smartphone, nicknamed the Sidekick II. Young people responded especially favorably to this phone's communication capabilities for e-mail and instant messaging. The Sidekick III was released in June 2006 and sales figures of about 1 million attested to the popularity of this Sharp phone.



The PV200, or Sidekick III, was lauded for a design that included a trackball for ease of operation

Promoting Efforts to Make Sharp an Environmentally Advanced Company Restructuring Business by Shifting to Areas Where Sharp Excels

Sharp constructed a “manufacturing complex for the 21st century” in Sakai City, Osaka.

In addition to producing large-size LCDs there based on 10th-generation glass substrates,

Sharp made the Sakai plant a major base dealing also with solar cells—a product category with technology related to that used in LCD panels.

In tune with the environmental era, Sharp also worked aggressively to expand business in environmental and health products.

In the midst of these efforts, widespread turmoil in financial and capital markets led to a major deterioration in the global economy.

At the same time, a shift to digital media was leading to comprehensive structural changes in the electronics industry.

Sharp swiftly and boldly confronted the challenge of business restructuring.

Schematic structure of the DL-L601N LED lamp

1 Strong Financial Results and Radical Changes in the Business Environment

President Katayama Appointed

On April 1, 2007, President Katsuhiko Machida was appointed chairman, and Corporate Senior Executive Director Mikio Katayama was appointed president. This transition marked the beginning of a two-person executive system comprising a chairman and a president. This change was undertaken in light of the fact that Sharp’s growth in size—it now posted consolidated sales in excess of 3 trillion yen annually—had made it difficult for the president working alone to grasp the full scope of operations.

Moreover, as business operations had expanded and Sharp’s presence had grown stronger, the president faced increasing demands to perform public relations duties.



Start of a new management system with Chairman Machida (left) and President Katayama

President Katayama joined Sharp in 1981, beginning his career as an engineer working primarily in the LCD division. In addition to managing the expansion of the LCD business at the Tenri, Mie, and Kameyama Plants, he also oversaw the TV business and achieved impressive results in

both device and product fields. When he became president, he was a young 49 years of age. His motto would be: “There are no limits to technology.”

In January 2008, looking ahead to 2012, the 100th anniversary of the company’s founding, he defined two visions: “Realize a truly ubiquitous society* with the world’s No. 1 LCDs” and “Contribute to the world through environment- and health-conscious business, focusing on energy-saving and energy-creating products.”

In June 2008, the executive officer system was introduced to accelerate decision-making and strengthen the system for conducting the company’s operational activities.

Record Sales and Business Restructuring

■ Net Sales Surpass 3.4 Trillion Yen

With strong sales of both one-of-a-kind products such as LCD TVs and mobile phones, as well as high-value-added devices, Sharp’s consolidated net sales for fiscal 2006 were 3.1277 trillion yen, surpassing the 3 trillion yen mark for the first time. Further, consolidated net sales for fiscal 2007 were 3.4177 trillion yen, with net income of 101.9 billion yen, marking record highs for five consecutive years.

However, in the second half of 2007, global financial and capital markets were plunged into turmoil in the wake of the subprime loan problem in the US, and the global economy rapidly slipped into a steep recession. In 2008, the

collapse of Lehman Brothers triggered a global financial crisis, and the yen’s ensuing rise on foreign exchange markets—coupled with sluggish consumption and intensifying price competition—caused Sharp to experience a decline in profits. Consolidated net sales for fiscal 2008 were 2.8472 trillion yen (down 16.7% compared to the previous year), with an operating loss of 55.4 billion yen and a net loss for the year of 125.8 billion yen. It was the first time the company posted a loss for its bottom line since it was listed on the Tokyo Stock Exchange in 1956.

■ Embarking on Restructuring the LCD Business

As market conditions weakened further, Sharp launched a reorganization of its LCD plants in January 2009, suspending operations at Kameyama Plant No. 1 and consolidating production at Plant No. 2. Additional emergency measures were implemented, such as shifting personnel to priority areas and reducing overall costs. Meanwhile, in the electronic device field, the company formed partnerships with leading overseas companies as part of a system of local production for local consumption. In addition to this, Sharp’s LED and solar cell business grew, and in fiscal 2009, the company returned to profitability, with operating income of 51.9 billion yen and net income of 4.3 billion yen. In fiscal 2010, despite a drop in sales as a result of the Great East Japan Earthquake—and also taking into account restructuring costs for the LCD business—sales and profits increased over the previous fiscal year.

However, slower growth in the LCD TV market led to a significant deterioration in the balance of supply and demand, and prices for LCD panels fell. At the beginning of fiscal 2011, the company was forced to suspend production at its large-size LCD plant, owing to lower demand, increased inventory levels, and a disruption in the supply of materials and components resulting from the Great East Japan Earthquake. Sharp took further steps to restructure its LCD business, focusing on strengthening its mobile LCD business and its large-size LCD business for panels 60 inches and larger—areas where Sharp’s technological superiority could be demonstrated (see page 11-04).

In the US, sales of large-screen TVs in the 60-inch-and-larger class remained strong; but in Japan, unit sales volume and unit prices fell drastically, and sales for Sharp plummeted. Demand stagnated for large-size LCDs

used in TVs, and the company became unable to maintain a sufficient level of operations at its production facilities. Sales of mobile phones in Japan and global sales of solar cells also fell significantly. Consolidated net sales for fiscal 2011 were 2.4558 trillion yen (down 18.7% compared to the previous year), and the net loss for the year of 376 billion yen was the company’s largest ever.

Aiming to Become an Eco-Positive Company

■ Setting a New Vision

Having accomplished ahead of schedule its environmental vision of having its energy-creating and energy-saving products more than balance out its greenhouse gas emissions by 2010, Sharp declared a new environmental vision in fiscal 2009 of becoming an Eco-Positive Company. Under this vision, Sharp set a goal for fiscal 2012 of having the amount contributed to reducing greenhouse gas emissions by the company’s shipped energy-creating and energy-saving products be more than double the amount of greenhouse gas emissions from the company’s business activities. In 2010, this Eco-Positive Company vision was laid down as Sharp’s corporate vision, defining the ideal corporate image that the company would work to achieve.

■ Strengthening Compliance

In December 2006, Sharp was the subject of an investigation by antitrust authorities in Japan, the US, and Europe on suspicion of involvement in a price-fixing cartel for TFT LCDs. This prompted the company to restructure its compliance system across the entire group and place more emphasis on education. First, a manual was prepared to ensure compliance with antitrust laws around the world, and training was conducted at sites nationwide. In addition, e-learning sessions on compliance with antitrust laws have since been implemented for all employees every year since 2009, in an effort to ensure compliance to the greatest extent possible.

* A “ubiquitous” society is one in which everyone—and everything—is connected; a society in which information can be freely exchanged without barriers anywhere, by anyone.

Reconstruction Support for the Great East Japan Earthquake

On March 11, 2011, a massive earthquake struck eastern Japan, with its epicenter off the coast of Sanriku in the Tohoku area. The tsunami that followed the earthquake caused catastrophic damage along the Pacific coast from the Tohoku area to the Kanto region. To make matters even worse, a serious accident involving the release of radioactive material occurred at the Fukushima No. 1 nuclear power plant operated by Tokyo Electric Power Co.

To aid the recovery of affected areas, Sharp made a corporate donation of 100 million yen, which was supplemented by donations of around 42 million yen from Sharp Group employees. Sharp also donated products and Sharp employees volunteered for reconstruction activities. In addition, service personnel from all over the country rushed to Sharp service centers in the Tohoku region to provide support repairing victims’ household appliances.



One form of aid was a solar power system for disaster relief that combined solar cells and storage batteries. Produced in collaboration with Shin-Kobe Electric Machinery Co., Ltd., these systems were donated to emergency shelters. The stored power generated from sunlight was used for purposes such as charging mobile phones and watching television.

2 Developing the LCD TV and Large-Size LCD Business

Construction of Green Front Sakai

In July 2007, Sharp announced that it would develop a cluster of state-of-the-art plants—hailed as a “manufacturing complex for the 21st century”—that would accommodate companies from a variety of industries based in Sakai City, Osaka Prefecture. It was conceived as a production facility that would adopt the vertically integrated production system used at the Kameyama Plant—where LCD TVs were produced start-to-finish—and move it further upstream. The complex would incorporate associated infrastructure facilities, along with the manufacturing plants of materials and equipment providers. The designated site for the complex was approximately 1.27 million m² in area, almost four times the size of the Kameyama Plant.

Here, Sharp built the Sakai Plant, a production facility for both energy-saving LCD panels and energy-creating solar cells. The fact that TFT LCD panels and thin-film solar cells were both based on the same thin-film technology meant that there was potential for the horizontal deployment of production technologies. It also meant that infrastructure facilities could be shared, thereby delivering improvements in both production efficiency and investment efficiency. The LCD panel plant was the first in the world to adopt 10th-generation glass substrates (2,880 mm × 3,130 mm in size), and it began mass production of large-size panels sized 40 inches and larger.

On April 1, 2009, Sharp Display Products Corporation (SDP) was established as a production company for LCDs. SDP took over the LCD panel plant from Sharp via a corporate divestiture, and on December 29, 2009, SDP accepted an investment from Sony Corporation and became a joint venture of the two companies.

On October 1, 2009, the LCD panel plant became operational with an investment of approximately 380 billion yen. The plant served to energize the local economy in Sakai



Ceremony to mark the first shipment of LCD panels from the plant (October 16, 2009)



Aerial view of Green Front Sakai (as of 2011). The area within the dashed lines and the rooftop solar panels are conceptual renderings showing the appearance when finally completed.

City and Osaka Prefecture: it prompted employment growth and development of infrastructure such as roads, and it had a ripple effect on local industry.

Sharp named the new manufacturing complex “Green Front Sakai.” The name was intended to convey Sharp’s intention to foster a more eco-conscious society by producing LCD panels and solar cells—products with outstanding environmental performance—in an environmentally friendly facility. Steps were taken to put energy conservation into practice to the greatest extent possible. For example, all on-site lighting (approximately 100,000 units) would be in the form of LED lamps.

The solar cell plant at Green Front Sakai became operational on March 29, 2010.

Unceasing Business Innovation

■ Boom and Bust in the Japanese Flat-Panel TV Market

Replacement purchases driven by the home appliance Eco-Point system (see page 11-08) and migration to digital terrestrial broadcasting produced a boom in domestic sales of flat-panel TVs: in 2010, industry-wide shipments in Japan increased by 84.9% compared to the previous year. Sharp met market demand by expanding and upgrading its production systems and broadening its product lineup. However, a rebound effect occurred in 2011 when the boom came to an end, and demand quickly cooled.

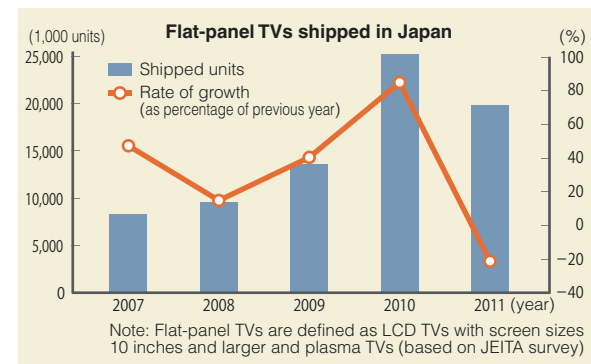

■ LCD TVs That Are Portable and Can Be Placed Anywhere

The Freestyle AQUOS made its debut in June 2011 as a product intended to generate new demand in anticipation of



LC-40F5 40-inch wall-mounted installation (2011)

changes in the market environment. The lineup included 20- to 60-inch models introduced sequentially, featuring a compact design and a separate display section and tuner unit. These models could be placed wherever the user wanted to view them—even mounted on a wall.

■ Order Received for LCD Panel Production Project in China

In the midst of intensifying competition in the LCD TV market, structural reforms in the LCD business moved forward.

On August 31, 2009, Sharp contributed to a new sixth-generation LCD panel production project in Nanjing, China. Sharp provided production technology to Nanjing CEC-PANDA LCD Technology Co., Ltd.—an LCD business company established by the City of Nanjing and the Nanjing China Electronics Panda Group Corporation—and sold sixth-generation production equipment incorporating state-of-the-art production technology from Kameyama Plant No. 1. Sharp also agreed to cooperate with production, which began in May 2011.

■ Strengthening Mobile LCDs and 60-Inch-Plus Large LCDs

In 2011, the supply of LCD panels of the sizes used in mass-market TVs far exceeded demand. In response, Sharp launched a strategy of concentrating on high-resolution mobile LCDs and 60-inch-plus large-size LCDs, both of which were growth areas for business.

First, Sharp took steps to shift its production systems from LCDs of the size used in mass-market TVs to small and mid-size LCDs for use in mobile devices. At the Kameyama Plant, production equipment for CG-Silicon LCDs was introduced at Plant No. 1, while Plant No. 2 shifted to producing mobile LCD panels by upgrading its production lines to manufacture IGZO LCDs.

At the same time, Sharp also moved to prioritize production of 60-inch-plus large-size panels. The market for these panels was growing, and the strengths of the Sakai Plant could be used to full advantage in their production. They were also supplied for use in digital signage and other commercial applications. In 2011, Sharp introduced 70- and 80-inch LCD TVs in the US market, accelerating the company’s large-size LCD panel strategy.

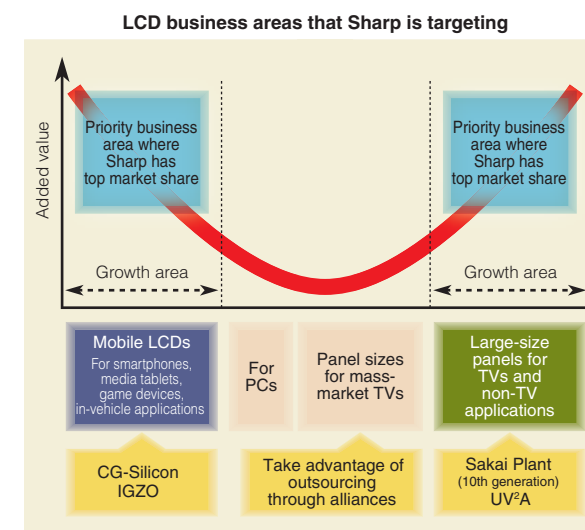

Sharp's Unique LCD Technologies (2007-2011)

LCD panels for use in TVs required larger sizes and higher resolutions, as well as technologies for better contrast, to enable viewers to enjoy impressive images. Small and mid-size LCDs for mobile phones and other devices demanded thinner profiles, lighter weight, lower power consumption, and higher display performance. Sharp responded by developing new technologies to meet these needs.

■ 108-Inch LCD

In 2007, Sharp developed an LCD TV with a screen size of 1,344 mm vertically × 2,386 mm horizontally. In June 2008, this TV was introduced as an LCD monitor for business and commercial applications.

■ New Mobile Advanced Super-V LCD

In 2007, Sharp developed a display for small- and medium-size LCDs that offered image quality approaching that of AQUOS TVs. The new display featured a contrast ratio of 2000:1 and a viewing angle of 176°.

■ Double-Speed Advanced Super-V LCD

Incorporated into the AQUOS R Series in 2007, this LCD panel supported 120 frames-per-second playback (i.e., 120 Hz) by generating an intermediate image between adjacent frames in TV broadcast content (frame interpolation). Viewers could enjoy smooth action, even for fast-moving scenes.

■ Mega-Contrast Advanced Super-V LCD

Incorporated into the AQUOS X Series in 2008, this technology achieved a contrast ratio of more than 1,000,000:1. LED backlights were driven independently for each RGB color to deliver deep, rich blacks.

■ UV²A Technology

This photo-alignment technology enabled precise control of the alignment of liquid crystal molecules, delivering high contrast, fast response speeds, energy savings, and greater production efficiency. Sharp introduced this technology to LCD production in 2009.

■ Four-Primary-Color Technology

Sharp added yellow (Y) to the traditional red (R), green (G), and blue (B) primary colors of the pixels in the LCD. Images benefit from the vivid rendering of colors such as brilliant gold.

Note: Four-primary-color technology is Sharp's own color reproduction system for LCDs and differs from the three-primary-color concept of light and color.



■ Ultra-High Resolution LCD

In 2006, Sharp developed an ultra-high resolution LCD with approximately 8.84 million pixels—over four times the number of pixels in the full HD format. In 2011, Sharp developed an 85-inch Super Hi-Vision (ultra-high definition) LCD with 33 million pixels—16 times higher resolution than full HD.

■ Small and Mid-Size LCDs Using IGZO (practical application)

In 2011, Sharp achieved high resolution, high image quality, and low power consumption using oxides of indium (In), gallium (Ga), and zinc (Zn) as the material of the TFT in the LCD panel.

3 Developing the Solar Cell Business Encompassing the Entire Value Chain

Renewable Energy Attracts Attention

Global interest in renewable energy was increasing. In Europe, adoption of feed-in tariffs (FIT) was widespread, particularly in Germany; and in the US, a Green New Deal policy was announced that would create jobs by increasing the energy-saving efficiency of government facilities and by increasing the use of alternative energy. As a result, the market for solar cells expanded in a single stroke.

In Japan, an accident occurred at the Fukushima No. 1 nuclear power plant as a result of the Great East Japan Earthquake, and in August 2011, the Law Concerning Special Measures for Renewable Energy was passed. Under the law, power companies were mandated to buy electricity derived from renewable energy sources such as wind or solar for a certain period of time at a fixed price. The widespread adoption of solar photovoltaic power generation subsequently attracted significant attention.

As solar cells had become a topic of intense interest, Sharp was recognized with an IEEE Milestone in 2010 for the company's achievements in the commercialization and industrialization of solar cells from 1959 to 1983. This recognition represented high praise for Sharp's contribution to the solar cell industry, with products for applications ranging from lighthouses and space satellites to residential power generation systems.



Solar power plant constructed in southern Italy

Aiming to Become a Total Solution Company

The expansion of the solar cell market prompted the entry into the market of European, American, and Chinese manufacturers. Global competition immediately intensified.

In 2008, Sharp announced a new policy direction for its solar cell business. The goal was to achieve solar power generating costs on a par with conventional power generation—that is, “grid parity”—and to generate new revenue by becoming a total solar power solution company.

Becoming a “total solution company” entailed a departure from being a simple solar cell manufacturer and an expansion of business along the entire value chain of solar power generation. It encompasses building production equipment in-house for solar cells and modules; constructing power plants; providing maintenance for solar facilities; and running an IPP* business. By acquiring leading partners in Europe, the US, and Asia, Sharp actively worked to expand its business along these lines (see table below).

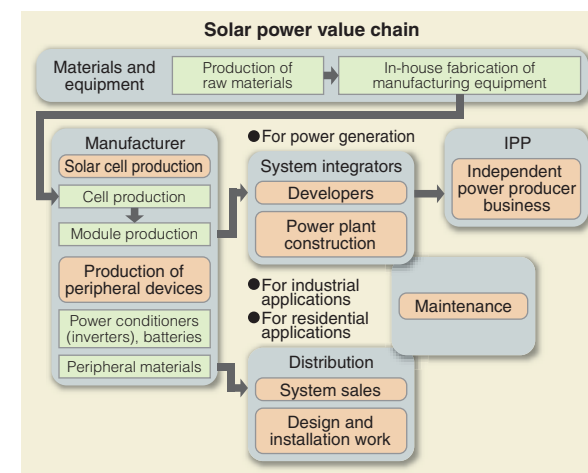

State-of-the-art thin-film solar cell plant at 3Sun (Catania, Sicily, Italy)

Business expansion aiming to make Sharp a total solar power solution company

| Business Area | Country | Date Established | Major Collaboration Partner | Specific Business Details |
|---------------------------------------|----------|-------------------------------------|---|---|
| IPP business | Italy | July 2010 | EGP (Enel Green Power S.p.A.) | Established Enel Green Power & Sharp Solar Energy S.r.l. (ESSE), a joint venture company Constructed solar power plant in Altomonte, Italy |
| Production of solar cells and modules | Italy | July 2010 | EGP, STMicroelectronics (STMicroelectronics N.V.) | Established 3Sun S.r.l., a joint venture company Constructed thin-film solar cell plant in Catania, Sicily, Italy |
| Power plant construction | Thailand | July 2010 | NED (Natural Energy Development Co., Ltd.) | Constructed solar power plant and supplied thin-film solar modules and peripheral systems |
| Maintenance | Thailand | March 2011 | — | Established Sharp Solar Maintenance Asia Co., Ltd. (SSMA) for inspection and maintenance services |
| Developer | US | November 2010 (date of acquisition) | — | Acquired Recurrent Energy, LLC as a wholly owned subsidiary Developed and sold solar power plants in collaboration with electric power utilities |

Technologies and Production of Thin-Film and Crystalline Solar Cells

Looking toward achieving grid parity, Sharp strengthened its initiatives for technological development and production of both thin-film and crystalline silicon solar cells.

For thin-film solar cells, Sharp introduced the NA-8501P crystalline thin-film solar module in 2005. This module utilized crystalline thin-film tandem solar cells based on a proprietary structure that combined amorphous silicon and crystalline thin-film silicon technologies. It achieved a conversion efficiency 1.5 times greater than conventional amorphous silicon modules.

To expand production, Sharp added a new production line at the Katsuragi Plant in 2008. This line produced second-generation thin-film solar cells that used large glass substrates (1,000 mm × 1,400 mm) that were equivalent to 2.7 times the previous size. In 2010, the company also built a new factory at Green Front Sakai.

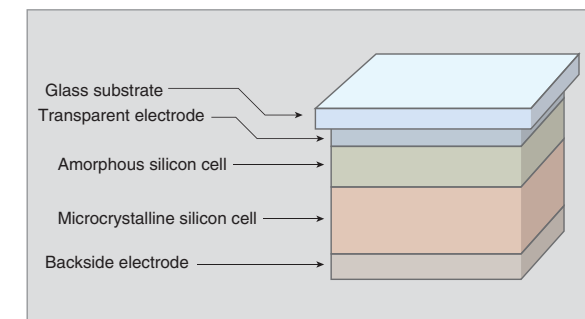

Crystalline thin-film tandem solar cells use a dual-layer cell structure to generate electricity from sunlight over a wide range of wavelengths (schematic diagram)

In 2010, in the field of crystalline solar cells, Sharp succeeded in developing Blacksolar—a new high-efficiency single-crystal solar cell. Mass production began at Green Front Sakai the following year. The new cell offered unprecedented performance capabilities. It increased the amount of light gathered by using a back contact structure that eliminated electrodes on the light-exposed surface. Further advances were also made in improving power generation on residential roof surfaces. Sharp's Roofit design system made efficient use of available rooftop installation space regardless of the shape or size of the roof.

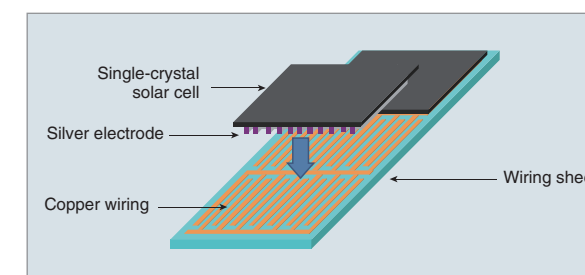

In a Blacksolar PV cell, the silver electrode and copper wiring are directly connected, and the line width is thicker, reducing the loss of generated power (schematic diagram)

Developing an Energy Solutions Business

Expectations for alternative energy were running high among the general public. There was intense interest not only in how to capture solar power, but also in how to store it and utilize it efficiently.

As a core technology for managing energy in residential solar power systems, Sharp developed the home energy management system (HEMS). This system controls appliances and equipment in the home and, by making use of information technology and sensors, enables even greater power savings without compromising comfort. To serve as a proof-of-concept laboratory for this idea, Sharp constructed the Sharp Eco House at Green Front Sakai. This experimental house uses a solar power system large enough to meet the electricity needs of a typical household.

In June 2011, Sharp began using the Eco House to test technologies that minimize power consumption and ensure the comfort of living spaces. Tremendous interest was generated in using the HEMS to connect Sharp's latest energy-saving appliances via a network, making it possible to use media tablets and AQUOS LCD TVs to graphically represent the power consumption of each device. This visual depiction was anticipated to change residents' awareness of energy conservation and result in greater energy savings. Here, in the future, Sharp also plans to test technologies for optimally controlling the power consumption of home appliances and equipment; technologies for linking solar cells and storage batteries; and energy-saving technologies that harness the ability of certain home appliances and devices to use solar-generated DC power directly, without the need to convert it to AC power.



Sharp Eco House at Green Front Sakai



Using a media tablet to operate home appliances

* An IPP (independent power producer) builds power generation facilities and sells the generated electric power.

4 Consistent Efforts Focused on the Environment and Solutions

Products Contributing to Health and the Environment

■ Establishing the Health and Environment Systems Group

In April 2008, Sharp took the constructive step of eliminating the Appliance Systems Group and establishing the Health and Environment Systems Group. Responding to consumers' growing awareness of health and environmental issues—and taking advantage of Sharp's proprietary technologies, such as Plasmacluster Ion (PCI) technology, LED lighting technology, and superheated steam technology—the company worked to develop health- and environment-conscious products that were different from the simple home appliances of the past.

■ Expanding the Plasmacluster Ion Business

Sharp instigated an “academic marketing” approach in order to generate measurable data to promote its PCI products. In August 2008, Sharp announced that the effect of decomposing and eliminating viruses increased with higher concentrations of PCI*¹. Moreover, it was confirmed in February 2010 that high PCI concentrations provided the attractive added benefit of moisturizing the skin*².

The first products to incorporate PCI-generating functions were air purifiers and air conditioners, but Sharp expanded its product lineup to include standalone PCI generators in October 2008.



PCI generator lineup for home use, ranging from portable personal devices to models for spaces up to 23 m² in area (February 2012)

At the end of December 2010, cumulative sales of PCI generators and products equipped with PCI functions (including products from Sharp and other manufacturers) reached 30 million units.

■ Entering the LED Lighting Market

In September 2008, Sharp introduced LED lighting for offices, factories, and commercial spaces, and in August 2009, LED lamps for the home. By bringing down costs and offering products at an attractive price, Sharp succeeded in generating new demand for LED lamps for home use and contributed to meeting demand for energy-saving products.

Subsequently, in September 2010, Sharp introduced the industry's first LED ceiling lights for use as primary in-home lighting. These ceiling lights boasted a thin, beautiful design that emitted surface light uniformly. They also offered automatic dimming and color-adjustment functions that enabled users to save energy effortlessly and enjoy enhanced lifestyle rhythms.

Pursuing an Aggressive Mobile Phone Strategy

■ Top Mobile Phone Market Share in Japan for Six Straight Years

With changes in the marketing techniques of telecom carriers leading to longer replacement cycles, sales of mobile phones in Japan took a downward turn beginning in fiscal 2008. Even in this environment, Sharp maintained its hold on the No. 1 market share for units shipped in Japan—a position it held from fiscal 2005 until fiscal 2010*³.

Smartphone models from overseas manufacturers debuted in Japan in late 2008, following which smartphones spread rapidly. In this category, Sharp introduced models equipped with features popular in conventional handsets, including the Osaifu-Keitai mobile payment system, One-Seg mobile terrestrial digital TV function, and data transfer via infrared communications. In the first half of fiscal 2011, Sharp's 22.7% of the domestic smartphone market gave it the No. 1 ranking in terms of shipped units; the company would go on to finish No. 2 for the year*³.

In addition to mobile phone models developed for overseas markets such as Taiwan and Hong Kong, Sharp also began developing models for China in June 2008. The company expanded its lineup to include mid-range to high-end models.

■ Entering the e-Book Business

Sharp launched an e-book service in December 2010 and introduced two models of the GALAPAGOS, a dedicated e-reader tablet. The company also started a unique service that included automatic scheduled delivery of newspapers and magazines. In August 2011, Sharp released a special version of the tablet with high-speed Wi-Fi connectivity. At the same time, the responsibility for sales was shifted from Sharp to selected telecom carriers. In December, Sharp worked to further enhance the service by providing content such as videos and music.

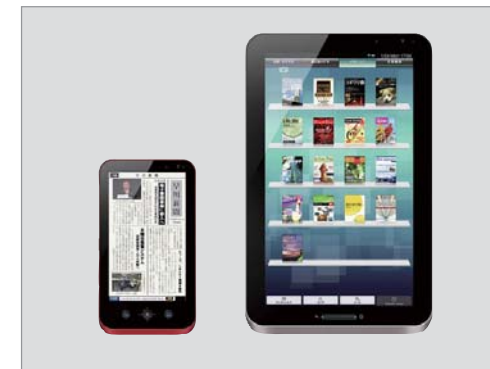

Initial models of the GALAPAGOS tablets, dedicated readers for Sharp's e-bookstore service. EB-W51GJ 5.5-inch model (left) and EB-WX1GJ 10.8-inch model

Full-Scale Deployment of the Corporate Sales Business

■ Initiatives in the Japanese Corporate Market

In fiscal 2007, Sharp captured a dominant 43.9% share of the LCD TV market in Japan (based on Sharp research). Sales of AQUOS LCD TVs in particular received a further fillip in 2009, when the Japanese government enacted its Eco-Point program. This economic stimulus package used a system of incentives to encourage citizens to purchase energy-saving and eco-friendly home appliances such as air conditioners, refrigerators, and TVs compatible with digital broadcasting. However, when the home appliance portion of the Eco-Point program came to an end in March 2011, and when analog TV broadcasting ended in the summer of that year, sales and prices of flat-panel TVs plummeted. Sharp's domestic sales departments suffered a heavy blow.

With government subsidies for residential solar power systems being cut in October 2005, Sharp Amenity Systems Corporation (SAS)—a seller and installer of solar power systems—was forced to scale back its operations. Beginning in November 2009, the feed-in tariff (power buyback) program was expanded and upgraded, and the residential market in Japan picked up again. However, expanding sales encouraged domestic and foreign manufacturers to enter the market, and Sharp found itself caught in a swirling vortex of intense competition.

■ Establishment of the Corporate Sales Group

Amid expectations that Japanese domestic demand for consumer electronics would shrink, Sharp worked to shift from traditional sales to consumers (B2C) to sales to corporations and government (B2B). In October 2008, Sharp renamed the OEM Sales Group—which comprised a corporate sales department and an OEM sales department—the Corporate Sales Group. It pushed forward to build a structure to sell business solutions, centered on information displays, LED lighting, PCI products, and solar power systems.

■ Further Expansion of the B2B Business

In April 2011, Sharp moved to centralize the points of contact for major corporations by bringing Sharp Amenity Systems (SAS), Sharp Document Systems (SDS), and Sharp

System Products (SSP)—subsidiaries formerly under the control of the Domestic Sales and Marketing Group—under the umbrella of the Corporate Sales Group. In a related move in September 2010, Sharp had established iDeep Solutions Corporation, a company that specialized in providing TeleOffice video- and web-conference systems.

In 2008, Fuyo General Lease Co., Ltd. acquired a 65% interest in Sharp Finance Corporation. The synergy of know-how between the two companies strengthened the foundations of Sharp's leasing business and enhanced its ability to respond to customer needs.

■ Development of Products Aimed at Corporate Customers

Professional information displays continued to grow larger in size. In July 2008, Sharp introduced a 108-inch LCD monitor aimed at businesses. It was at the time the world's largest commercial display. In June 2010, Sharp announced a new product: a multi-display system that combined ultra-narrow-bezel 60-inch LCDs to achieve a single giant screen. Installation examples included a video wall inside the ticket gate of the Yaesu Central Exit of JR Tokyo Station, which comprised eighteen 60-inch units creating a 330-inch-equivalent screen; and an immersive video space attraction at the Huis Ten Bosch theme park in Nagasaki, which used 156 60-inch units. In September 2011, Sharp introduced a 70-inch touchscreen display that could also be used as an electronic whiteboard. The lineup was subsequently expanded to include 60- and 80-inch models.



Sharp aimed to generate new demand with the 80-inch PN-L802B touchscreen LCD monitor. It gave this large display the nickname BIG PAD in Japan. (January 2012)

Sharp also put energy into placing MFPs in convenience stores. As of March 31, 2011, its installed base of approximately 18,000 units accounted for approximately 40% of convenience stores in Japan. In June 2011, Sharp moved to create new added value by allowing users to upload text, image, and photo data via the Internet and print it out at affiliated stores.

*1 Comparing the effects, after 10 minutes, of ion concentrations of approximately 7,000 ions/cm³ versus 50,000 ions/cm³ in an enclosed space with a volume of one cubic meter.

*2 Based on the rate of change in skin moisture after 60 minutes at an ion concentration of approximately 25,000 ions/cm³ in a space approximately 10 m² in area.

*3 Based on a market share survey by MM Research Institute, Ltd.

5 Focusing on Asia and Emerging Markets

Breakthrough in the Chinese Market

■ Expanding Sales of AQUOS LCD TVs and Mobile Phones

The Chinese market experienced a boom ahead of major national projects such as the Beijing Olympics in 2008 and the Shanghai World Expo in 2010. Against this background, SESC, Sharp's sales subsidiary in China, concentrated on introducing high-value-added products and strengthening brand equity.

To make inroads in China's intensely competitive LCD TV market, Sharp emphasized the key benefits of AQUOS TVs—in particular, their high-quality, Japan-made LCD panels. Beginning in September 2007, SESC launched an advertising campaign featuring René Liu, a popular actress and singer in China. Thanks to aggressive marketing, shipments of AQUOS in fiscal 2007 increased to about three times the level of the previous year.



An intensive PR campaign presented a unified brand image across a variety of media platforms, including TV commercials, newspaper and magazine ads, outdoor advertising, in-store presentations, and brochures

In the same year, Sharp also launched the AQUOS Experience Tour, in which a large truck-trailer carrying AQUOS TV models toured inland cities identified as fast-growing new markets. Each venue drew a huge turnout and was crowded with visitors. Taking advantage of the heightened visibility that the AQUOS tour brought to the Sharp brand, the company began selling mobile phones in China in June 2008.

■ Strengthening the Sharp Presence in China

In January 2011, Sharp established Sharp Laboratories of China Co., Ltd. (SLC), a research and development center in Shanghai.

SLC reinforced R&D, the first link in the manufacturing chain, and promoted local production for local consumption in China by localizing product planning, production, and sales in that country. The establishment of SLC completed a reinforced four-node R&D system that also included centers in Japan, the US, and the UK. In October 2010, Sharp also established Sharp Electronics Research & Development (Nanjing) Co., Ltd. (SERD) in Nanjing to conduct design and development of LCD products.



SLC develops cutting-edge technologies that contribute to the creation of products specifically designed for the Chinese market and conducts R&D on themes that lie at the heart of Sharp's global business activities

Beginning in 2007, Sharp held a series of environmental forums in major cities in China. At these forums, central and local government officials and the media were introduced to Sharp's environmental efforts, including its leading-edge products and technologies. In 2008, the company also began making environmental education presentations in elementary schools.

Sharp has also been active in community service projects. In 2006, it established the Sharp Charity Foundation, which provides funding for scholarships and engages in tree-planting activities. And when the Sichuan Earthquake struck in May 2008, Sharp Corporation and nine affiliated companies in China contributed relief funds totaling some 2 million yuan.

■ Establishing a Head Office in the China Region

China's economic development was remarkable over the five years from 2006, with annual GDP growth averaging 11.2%. In 2010, China surpassed Japan in nominal GDP, and became the world's second largest economy.

With the aim of building a locally self-sufficient business model in this market, Sharp established Sharp (China) Investment Co., Ltd. (SCIC), which began operations in Beijing on October 1, 2011. SCIC was positioned as the head office in the China region, overseeing 13 companies: six manufacturing bases, five sales subsidiaries, and two R&D bases. This new regional head office—the first of its kind for Sharp—included strategic planning and asset management among its responsibilities.

Pursuing New Business

■ Business Restructuring by Priority Market

With growth in developed markets slowing to a crawl, Sharp quickly developed a strategy centered on growth markets, and emerging economies in particular. Traditionally, Sharp had pursued a simple two-pronged strategy encompassing domestic and overseas business. But a need had arisen for a structure that could be fine-tuned to more closely match regional characteristics and product attributes.

To that end, on April 1, 2010, Sharp reorganized the International Sales and Marketing Group and a portion of the International Production Planning Group into the North & South America Group (based in New Jersey), the Europe Group (based in Hamburg), and the China Group (based in Shanghai). Sharp also set up the Global Market Development Group—Emerging Markets, Asia, Oceania (based at the Sharp Head Office). In October 2011, the ASEAN Group (based in Kuala Lumpur) and the Middle East and Africa Group (based in Dubai) were added. Each group would conduct business activities tailored to the characteristics of their region and would work to strengthen management efficiency.

Sharp then developed a sales network that emphasized emerging markets where high growth was expected. For example, Russia's national income more than doubled in real terms in the eight years from 2001 to 2008, and the width of the top- and middle-income brackets increased. Vietnam, meanwhile, has maintained an economic growth rate in excess of 5% per year since gaining full membership in the World Trade Organization (WTO) in 2007. To expand its own closely tailored business activities in such promising emerging markets, Sharp established the four new sales bases listed below, beginning in 2007. At the same time, it opened a series of sales and representative offices in the Middle East, Africa, and Central and South America, thereby establishing a solid foothold in emerging markets in those regions.

Four newly established sales bases (2007–2011)

| Year Established | Company Name | Country |
|------------------|--|---------|
| 2007 | Sharp Electronics Russia LLC (SER) | Russia |
| 2009 | Sharp Electronics (Vietnam) Company Limited (SVN) | Vietnam |
| 2009 | Sharp Corporation Mexico, S.A. de C.V. (SCMEX) | Mexico |
| 2011 | Sharp Brasil Comércio e Distribuição de Artigos Eletrônicos Ltda. (SBCD) | Brazil |

In its business activities in emerging economies, including areas where it already had a sales network, Sharp embraced the concept of creating products designed specifically to meet the needs of the consuming area and promoted local production for local consumption in those countries. Countries often placed high tariffs on imported finished goods to protect their own industries. Sharp therefore pushed forward to develop country-specific business strategies; for example, promoting the "kit" business model whereby Sharp would supply the parts and a local subcontractor would assemble the finished products.



An example of a locally tailored product is the Alexander series of slim-design color CRT TVs that were a hit in the Indonesian market. These models enjoyed high ratings for their feature-rich design and impressive sound.

In the developed markets of Europe and the US, revenue from solar-related products and LCD TVs grew sluggishly due to intensifying price competition. For this reason, Sharp strengthened its sales activities targeted at corporate customers. It expanded its direct sales business, based on mainstays such as document systems and information displays. And to further expand its markets, Sharp also moved to acquire more dealers. The goal was to build a highly profitable business model based on a series of products and services positioned from upstream to downstream in the value chain. In other words, in addition to product sales and service, Sharp would provide support through product leasing and sales of accessories, and it would also offer total product solutions.

■ Global Human Resource Development

Sharp also focused on nurturing talented professionals capable of supporting the globalization of its business.

In 2004, Sharp founded the SHINE (Sharp International New Experience) program, a training system to allow young employees to gain work experience and learn a language abroad. In addition, since 2008, Sharp has instituted training for employees who expect to be assigned overseas. It has also deployed company-wide programs to strengthen foreign language skills.

In 2011, Sharp introduced the GRID (Global-mind Regional Market Innovators' Development) program to further accelerate the development of human resources. This system involved training staff and sending them overseas—in particular, to emerging markets.

Striving to Rebuild Financial Results and Confidence Looking Ahead to the Next 100 Years, Embarking on New Growth

In 2012, Sharp faced severely adverse conditions as it marked the milestone of the 100th anniversary of its founding. The future of the world economy was bleak, particularly in Europe, and the value of the yen remained stubbornly high. In addition, management confronted difficult challenges, with the competitive environment in the electronics industry changing dramatically as the shift to digital media continued. A new management structure was initiated, centered on President Okuda, and the company began efforts to restore confidence and revive financial results by accelerating the pace of business restructuring. Sharp deployed an aggressive strategy to take up the challenge of a new business model, including a partnership with the Hon Hai Group. Looking ahead toward growth over the next 100 years, Sharp took a new step forward toward “value creation” that serves people in the global community.

NED's mega-solar project in Lop Buri Province in central Thailand (aerial view)

1 Aiming to Become a Global Company That Can Compete on the World Stage

President Okuda Appointed

Sharp responded to changes in the competitive environment of the electronics industry by working to build a foundation on which to compete globally. Key initiatives included restructuring its LCD business and promoting local production for local consumption in both its solar cell and LCD businesses. However, in fiscal 2011, the economic climate grew even more severe, with a worsening financial crisis in Europe and an unprecedented appreciation in the value of the yen. In addition, rapid changes in the market environment for digital consumer electronics caused market conditions in Japan to deteriorate much faster than expected in the LCD TV and communication and information fields.

Against this backdrop, on April 1, 2012, the company appointed Executive Managing Officer Takashi Okuda as president. President Katayama was named chairman, and Chairman Machida was named corporate advisor. Under the new system, in which President Okuda took center stage, Sharp launched initiatives that prioritized rebuilding confidence in the company and reviving financial results. In addition to taking urgent measures by initiating a restructuring of Sharp's solar cell and large LCD businesses, President Okuda swiftly deployed an aggressive strategy aimed at new growth for the future. This strategy will aim to restructure Sharp into a global company that can compete on the world stage by establishing one business model for

success in the category of commoditized digital products and another business model for creating new one-of-a-kind products.



A new executive system began under Chairman Katayama and President Okuda (right)

In his career at Sharp, President Okuda has been responsible for various domestic and international business groups where he has overseen all aspects of business, including production and the opening up of strategic markets. In particular, he made his mark in the Procurement

Group, at SEM (an R&D and parts supply company in Malaysia), and in the Audio-Visual Systems Group. By spending time on-site in the field, he has developed an approach to business that is sensitive to the voices of the marketplace and he has embraced a hands-on approach that encourages the ingenuity of employees. Addressing employees following his appointment, President Okuda declared, “There is treasure to be found out in the field, and it is our employees who work in the field who know this best and who will enable us to take advantage of it. In the future, as we seek to implement various changes, I want each individual to focus his or her attention not at the desk, but on-site, away from the office, out in the field.”

President Okuda visited major offices in Japan, including the Head Office, to explain to employees—and managers in particular—the initiatives and policies that Sharp would implement to achieve an early turnaround in financial results. Looking to rebuild confidence and business performance, he conveyed in detail how employees should tackle this task. He called for all employees to form a single cohesive group and work as hard as they could to demonstrate a steady recovery in financial results to the public.



Attending a nationwide general sales managers conference in April 2012, President Okuda (front left) encouraged participants to keep evolving Sharp's business

Launching a Framework to Compete in Global Markets

■ Building a Partnership with the Hon Hai Group

Up to now, Sharp has worked to expand its business by contributing to society through the creation of one-of-a-kind devices and products. Yet, in this age of increasingly commoditized digital products, the commercial success of a product is determined more by its production volume than by its uniqueness. In these types of business areas, rather than do everything on its own—from R&D and design to production, sales, and service—Sharp needed a strong partner and a new framework that would generate mutually beneficial synergies.

Accordingly, on March 27, 2012, Sharp signed an agreement with the Hon Hai Group to form a strategic global partnership incorporating capital investment from that group and cooperation in the area of digital products such as LCDs. The Hon Hai Group, which comprises Hon Hai Precision Industry Co., Ltd. and other companies, is one of the world's largest electronics manufacturing services

(EMS). The aim of its partnership with Sharp was to deliver sought-after products to the market in a speedy and timely fashion. This would be achieved by creating strategic vertical integration on a global level, bringing together Sharp's strengths in product development and the Hon Hai Group's high level of competency in production technology and cost competitiveness.

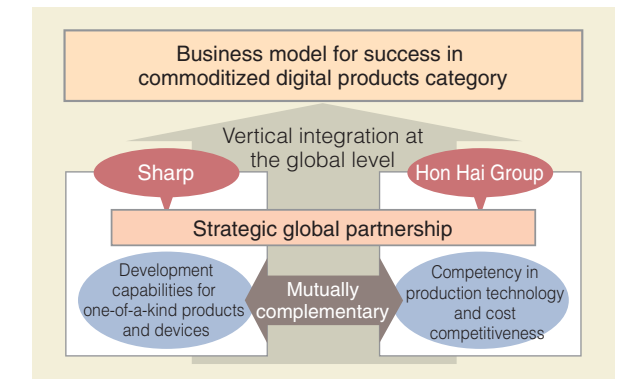

Vertical integration at the global level

In the past, Sharp has enjoyed an excellent business relationship with the Hon Hai Group, having supplied it with Sharp devices and having contracted it to manufacture Sharp products. The new agreement would serve to further develop this relationship.

Aside from the business collaboration, the partnership also involved the issuing of new Sharp shares to the Hon Hai Group through a third-party allotment*. In return, Sharp would receive an investment of approximately 66.9 billion yen, which would be used to advantage in the creation of new business and in the development of new technologies.

A further aspect of the partnership entailed an alliance related to SDP, which produced LCDs at the Sakai Plant. Under this agreement, the Hon Hai Group would invest approximately 66.0 billion yen in SDP (Sharp Display Products Corporation; now Sakai Display Products Corporation) and would procure ultimately up to 50% of the LCD panels and LCD modules manufactured by SDP. Working as equal partners, Sharp and Hon Hai would share the management of business operations. In addition to having a positive impact on the stability of operations at the Sakai Plant, it is expected that this partnership will enhance materials procurement capabilities and cost competitiveness.

■ Further Restructuring of the Sakai Plant

In May 2012, Sharp entered into an agreement with Toppan Printing Co., Ltd. and Dai Nippon Printing Co., Ltd., to merge the LCD color filter business at the Sakai Plant into SDP. The aim was to further improve operational efficiency for large-sized LCDs—for which color filters are a key element—and enhance the competitiveness of this business.

In addition, all SDP shares held by Sony Corporation were transferred to SDP, dissolving the joint venture of the two companies.

* Issuance of new shares through third-party allotment is a method of corporate financing through a private placement of shares. It raises capital by giving the rights to acquire new shares to a specific third party, regardless of whether that party is a shareholder. New shares or treasury shares that the company will dispose of are allocated to the party who applied to acquire the shares.

2 Swiftly Pursuing Business Restructuring

Implementing a Series of New Policy Measures in Overseas Markets

Sharp regards business expansion and overseas business restructuring as essential to the company's sustainable growth and is further accelerating the implementation of these initiatives.

■ Stepped-up Production in Indonesia and China

Indonesia, a country with an emerging economy that has undergone significant economic development, has seen a steady increase in domestic consumption. In fiscal 2011, sales at SEID, Sharp's Indonesian sales and production subsidiary, grew by nearly 20% compared to the previous year, and further improvements in financial results are expected in the future.

Sharp has a major presence in Indonesia. In 2011, it took a leading 35.9% share of the refrigerator market and a 28.7% share for washing machines (according to research by GfK). For the sake of further expansion, Sharp decided in March 2012 to build a new plant for SEID in Karawang to boost production of refrigerators and washing machines. The new facility will have a production capacity of 220,000 refrigerators and 140,000 washing machines per month. Construction is underway, with operations slated to begin before the end of 2013.



Conceptual rendering of new SEID plant

In April 2012, SOCC, Sharp's office equipment manufacturing company in China, began operations at a second production facility to manufacture digital color MFPs and toner cartridges.

Although Sharp copiers and MFPs are produced at four locations worldwide—Japan, China (SOCC), France (SMF), and Thailand (SMTL)—SOCC alone among these serves as a supply base for the entire global market, and even before now has played a central role.

With the newly constructed Plant No. 2 becoming operational, production capacity of the SOCC complex as a whole will increase from 400,000 units to 650,000 units a year. SOCC can now handle demand for color MFPs not only from the traditional markets of Europe and North

America, but also from China—a reflection of that country's burgeoning economic growth.



Plant No. 2 at SOCC began operations in April 2012

■ Intensifying Development of Marketing Strategies for Asia

The ASEAN region—namely, Indonesia, Philippines, Vietnam, and Thailand—represents a vast market of approximately 600 million people, yet there is still a low penetration rate in these countries for major product categories such as TVs, refrigerators, and washing machines. The potential demand is huge, with further economic development expected, along with a rise in the penetration rate for the aforementioned products.

Since setting up its ASEAN Group in 2011, Sharp has been working to expand the size of its business in the area, make the transition to a regionally self-sufficient production system, and establish Sharp as a leading brand. Further, Sharp has been deploying one-of-a-kind marketing, and introducing one-of-a-kind and high-value-added products specifically designed for the region.

On top of this, Sharp is deploying a pan-ASEAN brand strategy as one measure to strengthen its sales promotion activities. To improve brand awareness across the ASEAN region, advertising that was previously produced independently in each country has now been unified at the Brand Strategy Promotion Center under the umbrella of SEM, Sharp's subsidiary in Malaysia.

■ Establishing a European Head Office

As part of the restructuring of European operations, Sharp Electronics (Europe) Limited (SEE) was established in the UK in May 2012. SEE was tasked with assuming governance functions and ownership of subsidiaries in Europe, with its operations set to begin in the fall of 2012. The aim was to ensure that business was rooted in the European market, by promoting the delegation of authority and strengthening governance and management structures. SEE has been positioned as the head office in the European region. Under its auspices are 12 business units from various countries, including two production subsidiaries, nine sales companies, and three technology development centers. SEE will be responsible for corporate governance, strategic planning, and money management for these entities. To improve the efficiency of business operations, SEE will also be providing shared support services for the business operations of all bases in Europe. This will include legal affairs, intellectual property rights management, human resources, public relations, and brand strategy development.

Sharp has also been working to move away from Japan-led business operations and make the transition to locally self-sufficient businesses based on a system of regional business groups. In April 2012, the Audio-Visual Systems Group transferred some of its functions to SCIC, Sharp's head office in China. With SCIC—established in 2011—and the newly established SEE, Sharp is working to realize rapid business development based on faster decision-making in response to developments in the marketplace.

Debut of New Products and Devices, and Deploying a New Business Model

■ Starting Production of LCD Panels That Use Oxide Semiconductors

In March 2012, Sharp converted a production line at Kameyama Plant No. 2 and began mass production of high-performance LCD panels using an oxide semiconductor (IGZO)—a world-first accomplishment for which the company had long been preparing. Full-scale production began in April.

This new LCD reduces power consumption by increasing the amount of transmitted light per pixel and shrinking the size of the TFTs. It can also deliver higher resolutions, owing to its ability to support smaller pixel sizes. Another outstanding feature is that even higher levels of touchscreen performance are possible.



IGZO LCD (right) achieves lower power consumption compared to existing products

With these three outstanding features, IGZO LCDs lend themselves equally well to application in high-resolution notebook PCs, high-definition LCD monitors, and mobile devices such as media tablets—the product markets for which are all anticipated to grow in the future. Mass production of these innovative displays represents a major step forward in restructuring the LCD business.

■ Solar Cells and Energy-Related Business

Sharp is also pushing ahead to implement business innovations in the areas of solar cells and energy solutions. ESSE (Enel Green Power & Sharp Solar Energy S.r.l.)—an independent solar power producer previously established as a joint venture with EGP (Enel Green Power)—began operations at the end of March 2012, operating solar power plants at five sites in Italy with a total installed capacity of 14.4 MW. With the inclusion of an existing solar power plant, six sites are now operating commercially and providing a capacity of 20 MW—making ESSE now a full-fledged IPP (independent power producer). In the future, ESSE plans to expand its solar power business in Europe, particularly in the Mediterranean area, by leveraging the strengths of thin-film solar cells manufactured by 3Sun, a joint venture in Italy.

Sharp has developed and introduced the HEMS (home energy management system) for residential applications. Designed for use in conjunction with a solar power system, the HEMS can visually render power generation and power consumption in real time. With this system, users can monitor the amount of electricity being generated and sold back to the utility as well as the amount being consumed by each home appliance. HEMS will provide solid support for a way of living now spreading across Japan in which a home's occupants are more aware of the need to reduce energy use. The system can be installed easily using power-measuring taps attached to electrical outlets. Appliances and equipment such as TVs, air conditioners, and refrigerators are then plugged into the taps. HEMS offers a variety of functions, including the ability to use a media tablet to check the real-time power consumption of each appliance.

■ Adding New PCI Application Products to the Lineup

In the PCI product category, Sharp introduced a line of Plasmacluster Fans and Plasmacluster Slim Ion Fans to provide greater comfort and meet demands for energy-saving functionality. In addition, Sharp has also introduced a robotic vacuum cleaner appliance as its first home appliance robot capable of following spoken commands.



Robotic vacuum cleaner responds to voice commands

■ Strengthening Promotion for Large TVs in Japan and Overseas

In June 2012, Sharp introduced into the Japanese market an 80-inch LCD TV—the largest screen size in Japan—to enable viewers to enjoy ever-more impressive images. This model had previously been introduced in the US and China. With its large screen and high image quality, it offered a new level of TV enjoyment in the living room.



The overwhelming size of the screen offers a new TV lifestyle

Company Profile

■Name

Sharp Corporation

■Head Office

22-22 Nagaïke-cho, Abeno-ku,
Osaka 545-8522, Japan
Tel: +81-6-6621-1221

■Representatives

Mikio Katayama, Chairman
Takashi Okuda, President

■Operations

Consumer/Information Products

• **Audio-Visual and Communication Equipment**
LCD color TVs, color TVs, projectors, DVD recorders, Blu-ray Disc recorders, Blu-ray Disc players, mobile phones, mobile communications handsets, electronic dictionaries, calculators, facsimiles, telephones

• **Health and Environmental Equipment**

Refrigerators, superheated steam ovens, microwave ovens, air conditioners, washing machines, vacuum cleaners, air purifiers, dehumidifiers, humidifiers, electric heaters, small cooking appliances, Plasmacluster Ion generators, LED lights, solar-powered LED lights, network control units

• **Information Equipment**

POS systems, handy data terminals, electronic cash registers, information displays, digital MFPs (multifunction printers), options and consumables, software, FA equipment, ultrasonic cleaners

Electronic Components

• **LCDs**
TFT LCD modules, Duty LCD modules, System LCD modules

• **Solar Cells**
Crystalline solar cells, thin-film solar cells

• **Other Electronic Devices**
CCD/C-MOS imagers, LSIs for LCDs, microprocessors, flash memory, analog ICs, components for satellite broadcasting, terrestrial digital tuners, RF modules, network components, laser diodes, LEDs, optical pickups, optical sensors, components for optical communications, regulators, switching power supplies

■Founded

September 15, 1912

■Capital Stock

204,676 million yen
(rounded down to the nearest million)
(As of March 31, 2012)

■Website

<http://sharp-world.com/>

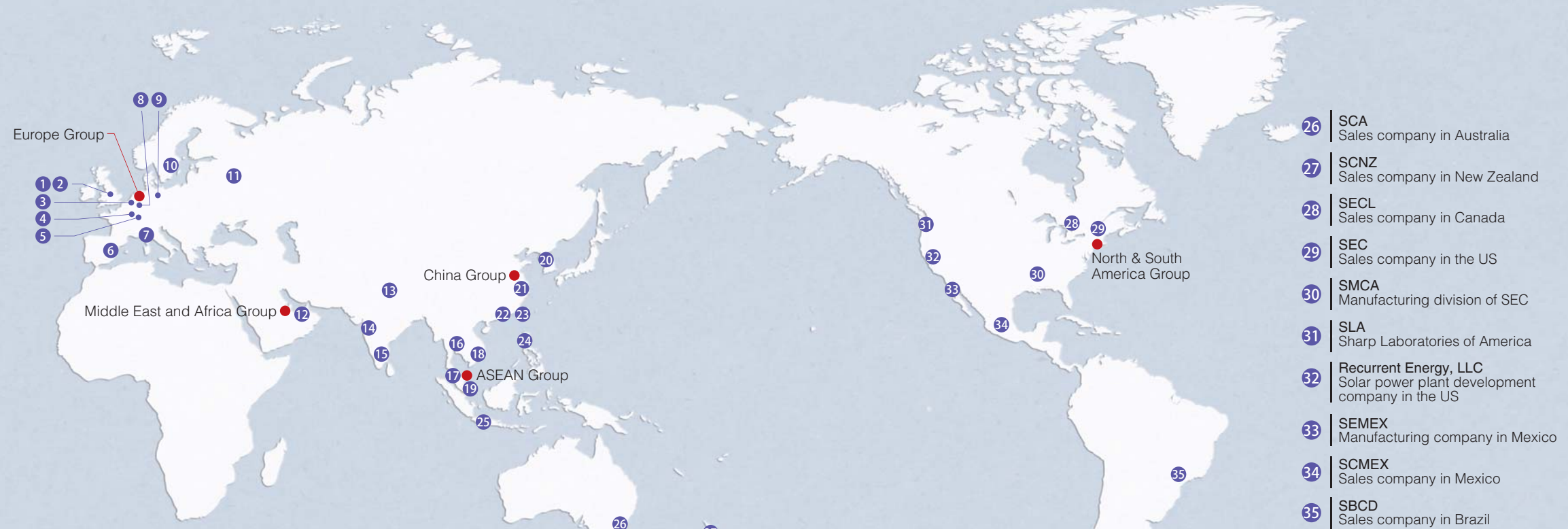

Major Overseas Bases

- | | | | |
|--|---|--|--|
| 1 SEE European headquarters | 10 SEN Sales company in Sweden | 19 SRS Sales company in Singapore SESL Sales company in Singapore | 22 SRH Sales company in Hong Kong |
| 2 SUK Sales company in the UK SIF Finance company in the UK SLE Sharp Laboratories of Europe STE Communications technology development company in the UK SUKM Manufacturing division of SUK | 11 SER Sales company in Russia | 20 SKC Manufacturing company in Korea SEI Sales company in Korea | 23 SECT Sales company in Taiwan SCOT Sales company in Taiwan |
| 3 SEB Sales company in the Netherlands | 12 SMEF Sales company in the UAE | 21 SCIC Chinese headquarters SSEC Manufacturing company in China SOCC Manufacturing company in China WSEC Manufacturing company in China NSEC Manufacturing company in China SSMC Manufacturing company in China SES Sales company in China STW Manufacturing company in China SESC Sales company in China SERD Design and development company in China SLC Technology development company in China | 24 SPC Sales and manufacturing company in the Philippines |
| 4 SEF Sales company in France SMF Manufacturing company in France | 13 SBI Sales company in India | | 25 SEID Sales and manufacturing company in Indonesia SSI Manufacturing company in Indonesia |
| 5 SEZ Sales company in Switzerland | 14 SIL Manufacturing company in India | | |
| 6 SEES Sales and technology development company in Spain | 15 SSDI Software development company in India | | |
| 7 SEIS Sales company in Italy ESSE Independent solar power producer in Italy | 16 SATL Manufacturing company in Thailand STCL Sales company in Thailand SMTL Manufacturing company in Thailand SSMA Solar power plant maintenance company in Thailand | | |
| 8 SEEG Sales company in Germany | 17 SOEM Manufacturing company in Malaysia SEM R&D and parts supply company in Malaysia SRSSC Sales company in Malaysia SMM Manufacturing company in Malaysia | | |
| 9 SMPL Manufacturing company in Poland | 18 SVN Sales company in Vietnam | | |

Major Bases in Japan

- | |
|--|
| 1 Head Office |
| 2 Tokyo Branch (Makuhari Building) |
| 3 Tokyo Ichigaya Building |
| 4 Tochigi Plant |
| 5 Kameyama Plant |
| 6 Mie Plant |
| 7 Advanced Development and Planning Center |
| 8 Nara Plant |
| 9 Katsuragi Plant |
| 10 Yao Plant |
| 11 Green Front Sakai |
| 12 Fukuyama Plant |
| 13 Mihara Plant |
| 14 Hiroshima Plant |

Major Overseas Bases



Sales company SEC in the US



Sales company SEEG in Germany



Sales company SESC in China



Sales and manufacturing company SEID in Indonesia



Manufacturing company SATL in Thailand



SMCA, manufacturing division of SEC



Sales company SECL in Canada



Sales company SUK in the UK



Sales company SMEF in the UAE



Manufacturing company SSEC in China



Manufacturing company SEMEX in Mexico



Manufacturing company SMPL in Poland



Sales company SCA in Australia



Manufacturing company SMM in Malaysia



Manufacturing company SOCC in China

| Country or Region | Company Name | Year Established (registered) | Business Activities |
|-------------------|---|-------------------------------|----------------------------------|
| 1 UK | SEE Sharp Electronics (Europe) Limited | 2012 | European headquarters |
| | SUK Sharp Electronics (U.K.) Ltd. | 1969 | Sales |
| | SIF Sharp International Finance (U.K.) PLC | 1990 | Financing |
| | SLE Sharp Laboratories of Europe, Ltd. | 1990 | R&D |
| | STE Sharp Telecommunications of Europe Ltd. | 2001 | Technology development |
| | SUKM Sharp Manufacturing Company of U.K. | 1985*1 | Manufacturing*2 |
| 2 Netherlands | SEB Sharp Electronics Benelux B.V. | 1991 | Sales |
| 3 France | SEF Sharp Electronics France S.A. | 1971*3 | Sales |
| | SMF Sharp Manufacturing France S.A. | 1989 | Manufacturing |
| 4 Switzerland | SEZ Sharp Electronics (Schweiz) AG | 1986 | Sales |
| 5 Spain | SEES Sharp Electrónica España S.A. | 1986 | Sales, technology development |
| 6 Italy | SEIS Sharp Electronics (Italia) S.p.A. | 1990 | Sales |
| | ESSE Enel Green Power & Sharp Solar Energy S.r.l. | 2010 | Independent solar power producer |
| | 3Sun 3Sun S.r.l. | 2010 | Manufacturing |
| 7 Germany | SEEG Sharp Electronics (Europe) GmbH | 1968 | Sales |
| 8 Poland | SMPL Sharp Manufacturing Poland sp. z o.o. | 2006 | Manufacturing |
| 9 Sweden | SEN Sharp Electronics (Nordic) AB (SEN) | 1979 | Sales |
| 10 Russia | SER Sharp Electronics Russia LLC | 2007 | Sales |
| 11 UAE | SMEF Sharp Middle East Free Zone Establishment | 1997 | Sales |
| 12 India | SBI Sharp Business Systems (India) Ltd. | 2000 | Sales |
| | SIL Sharp India Limited | 1989 | Manufacturing |
| | SSDI Sharp Software Development India Pvt. Ltd. | 1999 | Software development |
| 13 Thailand | SATL Sharp Appliances (Thailand) Ltd. | 1987 | Manufacturing |
| | STCL Sharp Thai Co., Ltd. | 1989 | Sales |
| | SMTL Sharp Manufacturing (Thailand) Co., Ltd. | 2005 | Manufacturing |
| | SSMA Sharp Solar Maintenance Asia Co., Ltd. | 2011 | Solar maintenance |
| 14 Malaysia | SOEM S & O Electronics (Malaysia) Sdn. Bhd. | 1974 | Manufacturing |
| | SEM Sharp Electronics (Malaysia) Sdn. Bhd. | 1995 | R&D, parts supply |
| | SRSSC Sharp-Roxy Sales & Service Company (Malaysia) Sdn. Bhd. | 1985 | Sales |
| | SMM Sharp Manufacturing Corporation (M) Sdn. Bhd. | 1989 | Manufacturing |
| | SVN Sharp Electronics (Vietnam) Company Limited | 2009 | Sales |

| Country or Region | Company Name | Year Established (registered) | Business Activities |
|---|--|---|----------------------|
| 15 Singapore | SRS Sharp-Roxy Sales (Singapore) Pte., Ltd. | 1986 | Sales |
| | SESL Sharp Electronics (Singapore) Pte., Ltd. | 1987 | Sales |
| 16 Korea | SKC Sharp Korea Corporation | 1973 | Manufacturing |
| | SEI Sharp Electronics Incorporated of Korea | 1999 | Sales |
| 17 China | SCIC Sharp (China) Investment Co., Ltd. | 2011 | Chinese headquarters |
| | SSEC Shanghai Sharp Electronics Co., Ltd. | 1992 | Manufacturing |
| | SOCC Sharp Office Equipments (Changshu) Co., Ltd. | 1993 | Manufacturing |
| | WSEC Wuxi Sharp Electronic Components Co., Ltd. | 1994 | Manufacturing |
| | NSEC Nanjing Sharp Electronics Co., Ltd. | 1996 | Manufacturing |
| | SSMC Shanghai Sharp Mold and Manufacturing Systems Co., Ltd. | 1997 | Manufacturing |
| | SES Sharp Electronics (Shanghai) Co., Ltd. | 2000 | Sales |
| | STW Sharp Technical Components (Wuxi) Co., Ltd. | 2004 | Manufacturing |
| | SESC Sharp Electronics Sales (China) Co., Ltd. | 2005 | Sales |
| | SERD Sharp Electronics Research & Development (Nanjing) Co., Ltd. | 2010 | Design, development |
| SLC Sharp Laboratories of China Co., Ltd. | 2011 | Technology development | |
| 18 Hong Kong | SRH Sharp-Roxy (Hong Kong) Ltd. | 1987 | Sales |
| 19 Taiwan | SCOT Sharp Corporation Taiwan | 1990 | Sales |
| | SECT Sharp Electronic Components (Taiwan) Corporation | 1992 | Sales |
| 20 Philippines | SPC Sharp (Phils.) Corporation | 1982 | Manufacturing, sales |
| 21 Indonesia | SEID P.T. Sharp Electronics Indonesia | 1994 | Manufacturing, sales |
| | SSI P.T. Sharp Semiconductor Indonesia | 1995 | Manufacturing |
| 22 Australia | SCA Sharp Corporation of Australia Pty. Ltd. | 1971 | Sales |
| 23 New Zealand | SCNZ Sharp Corporation of New Zealand Ltd. | 1988 | Sales |
| 24 Canada | SECL Sharp Electronics of Canada Ltd. | 1974 | Sales |
| 25 US | SEC Sharp Electronics Corporation | 1962 | Sales |
| | SMCA Sharp Manufacturing Company of America | 1979*1 | Manufacturing*4 |
| | SLA Sharp Laboratories of America, Inc. | 1995 | R&D |
| | Recurrent Energy Recurrent Energy, LLC | 2006*5 | Plant development |
| | 26 Mexico | SEMEX Sharp Electrónica Mexico S.A. de C.V. | 1997 |
| 27 Mexico | SCMEX Sharp Corporation Mexico, S.A. de C.V. | 2009 | Sales |
| 28 Brazil | SBCD Sharp Brasil Comércio e Distribuição de Artigos Eletrônicos Ltda. | 2011 | Sales |

*1 Start of operations *2 Manufacturing division of SUK *3 Acquired a local dealer and made it a sales subsidiary in 1990 *4 Manufacturing division of SEC *5 Acquired 100% ownership in 2010
As of May 31, 2012

Major Bases in Japan



Head Office (Abeno-ku, Osaka)



Advanced Development and Planning Center (Tenri, Nara)



Green Front Sakai (Sakai, Osaka)

The area within the dashed lines and the rooftop solar panels are conceptual renderings showing the appearance when finally completed.



Tokyo Branch (Makuhari Building)
(Mihama-ku, Chiba)



Tokyo Ichigaya Building
(Shinjuku-ku, Tokyo)



Tochigi Plant (Yaita, Tochigi)



Kameyama Plant (Kameyama, Mie)



Mie Plant (Taki, Mie)



Nara Plant (Yamato-koriyama, Nara)



Katsuragi Plant (Katsuragi, Nara)



Yao Plant (Yao, Osaka)



Fukuyama Plant (Fukuyama, Hiroshima)



Mihara Plant (Mihara, Hiroshima)



Hiroshima Plant (Higashi-hiroshima, Hiroshima)

| | Site Name | Start of Operations | Address | Main Products |
|----|--|---------------------|---|--|
| 1 | Head Office | 1924 | 22-22 Nagaike-cho, Abeno-ku, Osaka 545-8522 | - |
| 2 | Tokyo Branch (Makuhari Building) | 1992 | 1-9-2 Nakase, Mihama-ku, Chiba-shi, Chiba Prefecture 261-8520 | - |
| 3 | Tokyo Ichigaya Building | 1974 | 8 Ichigaya-Hachiman-cho, Shinjuku-ku, Tokyo 162-8408 | - |
| 4 | Tochigi Plant | 1968 | 174 Hayakawa-cho, Yaita-shi, Tochigi Prefecture 329-2193 | AV equipment |
| 5 | Kameyama Plant | 2004 | 464 Kohgawa, Shiraki-cho, Kameyama-shi, Mie Prefecture 519-0198 | LCDs, others |
| 6 | Mie Plant | 1995 | 1177-1 Gosana, Taki-cho, Taki-gun, Mie Prefecture 519-2192 | LCDs |
| 7 | Advanced Development and Planning Center | 1970 | 2613-1 Ichinomoto-cho, Tenri-shi, Nara Prefecture 632-8567 | LCDs, others |
| 8 | Nara Plant | 1959 | 492 Minosho-cho, Yamato-koriyama-shi, Nara Prefecture 639-1186 | Information equipment, others |
| 9 | Katsuragi Plant | 1981 | 282-1 Hajikami, Katsuragi-shi, Nara Prefecture 639-2198 | Solar cells, others |
| 10 | Yao Plant | 1958 | 3-1-72 Kitakamei-cho, Yao-shi, Osaka Prefecture 581-8585 | Health and environmental equipment, others |
| 11 | Green Front Sakai | 2009 | 1 Takumi-cho, Sakai-ku, Sakai-shi, Osaka Prefecture 590-8522 | LCDs and solar cells |
| 12 | Fukuyama Plant | 1985 | 1 Asahi, Daimon-cho, Fukuyama-shi, Hiroshima Prefecture 721-8522 | Electronic devices |
| 13 | Mihara Plant | 2002 | 247 Sojo, Nutanishi-cho, Mihara-shi, Hiroshima Prefecture 729-0474 | Electronic devices |
| 14 | Hiroshima Plant | 1967 | 2-13-1 Hachihonmatsu-lida, Higashi-hiroshima-shi, Hiroshima Prefecture 739-0192 | Communication equipment |

| Major Affiliated Companies | Year Established (registered) | Location | Main Business Activities |
|---|-------------------------------|---------------------|--|
| Sharp Electronics Marketing Corporation | 1948 | Abeno-ku, Osaka | Sales of consumer electronics and office equipment |
| Sharp System Products Co., Ltd. | 1969 | Mihama-ku, Chiba | Sales of system products, development and sales of software |
| Sharp Manufacturing Systems Corporation | 1970 | Yao, Osaka | Manufacture and sales of molds and manufacturing equipment |
| Sharp Amenity Systems Corporation | 1968 | Hirano-ku, Osaka | Sales of solar power systems, air conditioning/electrical installation |
| Sharp-Engineering Corporation | 1962 | Hirano-ku, Osaka | After-sales service of consumer electronics |
| Sharp Document Systems Corporation | 1977 | Mihama-ku, Chiba | After-sales service and sales of office equipment, sales of supplies |
| Sharp Niigata Electronics Corporation | 1970 | Minami-ku, Niigata | Manufacture and sales of electronic components |
| Sharp Trading Corporation | 1985 | Abeno-ku, Osaka | Sales and import of consumer electronics, office equipment, and electronic components |
| Sharp Business Computer Software Inc. | 1979 | Sumida-ku, Tokyo | Development of software |
| Sharp Yonago Corporation | 2005 | Yonago, Tottori | Manufacture and sales of electronic components |
| SD Future Technology Co., Ltd. | 2006 | Kameyama, Mie | R&D and design of parts for electronic components |
| Sharp Mie Corporation | 1991 | Tsu, Mie | Manufacture and sales of electronic components |
| Sharp Display Products Corporation | 2009 | Sakai, Osaka | Development, manufacture, and sales of LCDs |
| iDeep Solutions Corporation | 2010 | Minato-ku, Tokyo | Sales and lease of video conferencing systems |
| iDeep Global Labs Corporation | 2010 | Shinagawa-ku, Tokyo | Development and sales of video conferencing systems and video conferencing software |
| Sharp Support & Service Corporation | 2010 | Mihama-ku, Chiba | After-sales service of office equipment |
| Galapagos Networks Co., Ltd. | 2010 | Minato-ku, Tokyo | Operation of e-bookstore service |
| Sharp Tokusen Industry Co. | 1982 | Abeno-ku, Osaka | Assembly of electrical equipment, others |
| SI Solutions Co., Ltd. | 2001 | Abeno-ku, Osaka | Consultation and contract work on design, development, implementation, operation, and maintenance of information systems |
| Sharp Finance Corporation | 1982 | Abeno-ku, Osaka | Credit sales and lease of consumer electronics, real estate rental, insurance agency |
| Sharp Electronics Sales Okinawa Corporation | 1967 | Naha, Okinawa | Sales of consumer electronics, office equipment, and solar power systems |

As of May 31, 2012

Changes in Capital, Business Performance, and Number of Employees (1)

| Fiscal Term | Fiscal Year | Accounting Period (year/month) | Capital (thousand yen) | Gross Profit (thousand yen) | Operating Income (thousand yen) | Profit Ratio (%) | Profit before Tax (thousand yen) | Profit Ratio (%) | Net Income (thousand yen) | Profit Ratio (%) | No. of Employees (persons) |
|-------------|-------------|--------------------------------|------------------------|-----------------------------|---------------------------------|------------------|----------------------------------|------------------|---------------------------|------------------|----------------------------|
| 1 | 1935 | 35/ 5 - 35/ 5 | 500 | 168 | — | — | — | — | 2 | 1.2 | — |
| 2 | 1935 | 35/ 6 - 35/11 | 500 | 699 | — | — | — | — | 14 | 2.0 | — |
| 3 | 1936 | 35/12 - 36/ 5 | 500 | 1,653 | — | — | — | — | 14 | 0.8 | — |
| 4 | 1936 | 36/ 6 - 36/11 | 500 | 1,429 | — | — | — | — | 1 | 0.1 | — |
| 5 | 1937 | 36/12 - 37/ 5 | 700 | 1,812 | — | — | — | — | 20 | 1.1 | — |
| 6 | 1937 | 37/ 6 - 37/11 | 700 | 2,133 | — | — | — | — | 35 | 1.6 | — |
| 7 | 1938 | 37/12 - 38/ 5 | 700 | 2,191 | — | — | — | — | 25 | 1.1 | — |
| 8 | 1938 | 38/ 6 - 38/11 | 700 | 2,449 | — | — | — | — | 36 | 1.5 | — |
| 9 | 1939 | 38/12 - 39/ 5 | 700 | 3,593 | — | — | — | — | 40 | 1.1 | — |
| 10 | 1939 | 39/ 6 - 39/11 | 700 | 4,779 | — | — | — | — | 51 | 1.1 | — |
| 11 | 1940 | 39/12 - 40/ 5 | 700 | 4,776 | — | — | — | — | 55 | 1.2 | — |
| 12 | 1940 | 40/ 6 - 40/11 | 1,000 | 5,535 | — | — | — | — | 57 | 1.0 | — |
| 13 | 1941 | 40/12 - 41/ 5 | 1,000 | 6,049 | — | — | — | — | 75 | 1.2 | — |
| 14 | 1941 | 41/ 6 - 41/11 | 1,000 | 6,220 | — | — | — | — | 136 | 2.2 | — |
| 15 | 1942 | 41/12 - 42/ 5 | 1,000 | 6,886 | — | — | — | — | 100 | 1.5 | — |
| 16 | 1942 | 42/ 6 - 42/11 | 1,000 | 6,948 | — | — | — | — | 100 | 1.4 | — |
| 17 | 1943 | 42/12 - 43/ 5 | 1,000 | 6,978 | — | — | — | — | 82 | 1.2 | — |
| 18 | 1943 | 43/ 6 - 43/10 | 3,000 | 3,983 | — | — | — | — | 246 | 6.2 | — |
| 19 | 1943 | 43/11 - 44/ 3 | 3,000 | 5,406 | — | — | — | — | 611 | 11.3 | — |
| 20 | 1944 | 44/ 4 - 44/ 9 | 7,500 | 11,013 | — | — | — | — | 1,225 | 11.1 | — |
| 21 | 1944 | 44/10 - 45/ 3 | 7,500 | 13,877 | — | — | — | — | 2,087 | 15.0 | — |
| 22-23 | 1945 | 45/ 4 - 46/ 3 | 8,300 | 35,754 | — | — | — | — | 830 | 2.3 | — |
| 24 | 1946 | 46/ 4 - 46/ 8 | 8,300 | 23,149 | — | — | — | — | 687 | 3.0 | — |
| Fiscal Term | Fiscal Year | Accounting Period (year/month) | Capital (million yen) | Gross Profit (million yen) | Operating Income (million yen) | Profit Ratio (%) | Profit before Tax (million yen) | Profit Ratio (%) | Net Income (million yen) | Profit Ratio (%) | No. of Employees (persons) |
| 25-28 | 1946-48 | 46/ 8 - 48/12 | 30 | 782 | — | — | — | — | 15 | 1.9 | — |
| 29 | 1948 | 48/12 - 49/ 3 | 30 | 252 | — | — | — | — | 3 | 1.2 | — |
| 30 | 1949 | 49/ 4 - 49/ 9 | 30 | 390 | — | — | — | — | 7 | 1.8 | 678 |
| 31 | 1949 | 49/10 - 50/ 3 | 30 | 279 | — | — | — | — | -4 | -1.4 | — |
| 32 | 1950 | 50/ 4 - 50/ 9 | 30 | 219 | — | — | — | — | -29 | -13.2 | 355 |
| 33 | 1950 | 50/10 - 51/ 3 | 30 | 327 | — | — | — | — | 3 | 0.9 | 348 |
| 34 | 1951 | 51/ 4 - 51/ 9 | 30 | 522 | — | — | — | — | 13 | 2.5 | 482 |
| 35 | 1951 | 51/10 - 52/ 3 | 30 | 739 | — | — | — | — | 54 | 7.3 | 689 |
| 36 | 1952 | 52/ 4 - 52/ 9 | 30 | 1,004 | — | — | — | — | 90 | 9.0 | 722 |
| 37 | 1952 | 52/10 - 53/ 3 | 30 | 1,206 | — | — | — | — | 93 | 7.7 | 878 |
| 38 | 1953 | 53/ 4 - 53/ 9 | 30 | 1,493 | — | — | — | — | 83 | 5.6 | 853 |

| Fiscal Term | Fiscal Year | Accounting Period (year/month) | Capital (million yen) | Net Sales (million yen) | Export Rate (%) | Operating Income (million yen) | Profit Ratio (%) | Profit before Tax (million yen) | Profit Ratio (%) | Net Income (million yen) | Profit Ratio (%) | No. of Employees (persons) |
|-------------|-------------|--------------------------------|-----------------------|-------------------------|-----------------|--------------------------------|------------------|---------------------------------|------------------|--------------------------|------------------|----------------------------|
| 39 | 1953 | 53/10 - 54/ 3 | 120 | 897 | — | 156 | 17.4 | — | — | 147 | 16.4 | 929 |
| 40 | 1954 | 54/ 4 - 54/ 9 | 120 | 839 | 0.9 | 127 | 15.1 | — | — | 123 | 14.7 | 864 |
| 41 | 1954 | 54/10 - 55/ 3 | 120 | 1,134 | 1.3 | 185 | 16.3 | — | — | 168 | 14.8 | 1,346 |
| 42 | 1955 | 55/ 4 - 55/ 9 | 250 | 1,609 | 2.9 | 293 | 18.2 | — | — | 280 | 17.4 | 1,392 |
| 43 | 1955 | 55/10 - 56/ 3 | 250 | 2,185 | 1.4 | 349 | 16.0 | — | — | 330 | 15.1 | 1,681 |
| 44 | 1956 | 56/ 4 - 56/ 9 | 250 | 2,160 | 2.2 | 315 | 14.6 | — | — | 310 | 14.4 | 1,958 |
| 45 | 1956 | 56/10 - 57/ 3 | 500 | 2,699 | 3.3 | 331 | 12.3 | — | — | 317 | 11.7 | 2,503 |
| 46 | 1957 | 57/ 4 - 57/ 9 | 500 | 3,288 | 2.9 | 361 | 11.0 | — | — | 355 | 10.8 | 2,312 |
| 47 | 1957 | 57/10 - 58/ 3 | 1,000 | 3,415 | 7.7 | 381 | 11.2 | — | — | 360 | 10.5 | 2,613 |
| 48 | 1958 | 58/ 4 - 58/ 9 | 1,000 | 4,438 | 13.6 | 565 | 12.7 | — | — | 557 | 12.6 | 2,973 |
| 49 | 1958 | 58/10 - 59/ 3 | 1,000 | 8,286 | 10.3 | 1,417 | 17.1 | — | — | 1,399 | 16.9 | 3,947 |
| 50 | 1959 | 59/ 4 - 59/ 9 | 2,000 | 9,772 | 14.3 | 1,506 | 15.4 | — | — | 1,433 | 14.7 | 5,165 |
| 51 | 1959 | 59/10 - 60/ 3 | 2,000 | 10,150 | 12.8 | 1,274 | 12.6 | — | — | 1,268 | 12.5 | 4,457 |
| 52 | 1960 | 60/ 4 - 60/ 9 | 2,000 | 10,273 | 15.8 | 1,180 | 11.5 | — | — | 1,212 | 11.8 | 5,276 |
| 53 | 1960 | 60/10 - 61/ 3 | 2,000 | 10,824 | 15.2 | 1,315 | 12.1 | — | — | 1,239 | 11.4 | 6,111 |
| 54 | 1961 | 61/ 4 - 61/ 9 | 4,000 | 12,000 | 14.7 | 1,363 | 11.4 | — | — | 1,327 | 11.1 | 6,092 |
| 55 | 1961 | 61/10 - 62/ 3 | 4,000 | 13,333 | 14.6 | 1,429 | 10.7 | — | — | 1,403 | 10.5 | 7,005 |
| 56 | 1962 | 62/ 4 - 62/ 9 | 4,000 | 15,214 | 16.3 | 1,455 | 9.6 | — | — | 1,402 | 9.2 | 6,932 |
| 57 | 1962 | 62/10 - 63/ 3 | 6,000 | 16,253 | 18.8 | 1,507 | 9.3 | — | — | 1,420 | 8.7 | 7,505 |
| 58 | 1963 | 63/ 4 - 63/ 9 | 6,000 | 16,908 | 18.6 | 1,600 | 9.5 | — | — | 1,473 | 8.7 | 7,167 |
| 59 | 1963 | 63/10 - 64/ 3 | 6,000 | 17,341 | 17.4 | 1,088 | 6.3 | 930 | 5.4 | 600 | 3.5 | 8,097 |
| 60 | 1964 | 64/ 4 - 64/ 9 | 6,000 | 15,039 | 19.7 | 698 | 4.6 | 526 | 3.5 | 401 | 2.7 | 7,136 |
| 61 | 1964 | 64/10 - 65/ 3 | 6,000 | 15,171 | 22.4 | 795 | 5.2 | 543 | 3.6 | 403 | 2.7 | 6,591 |
| 62 | 1965 | 65/ 4 - 65/ 9 | 6,000 | 14,238 | 24.1 | 812 | 5.7 | 550 | 3.9 | 405 | 2.8 | 6,062 |
| 63 | 1965 | 65/10 - 66/ 3 | 6,000 | 15,013 | 26.9 | 1,145 | 7.6 | 781 | 5.2 | 501 | 3.3 | 6,593 |
| 64 | 1966 | 66/ 4 - 66/ 9 | 6,000 | 19,156 | 38.9 | 1,426 | 7.4 | 1,088 | 5.7 | 668 | 3.5 | 6,922 |
| 65 | 1966 | 66/10 - 67/ 3 | 6,000 | 22,928 | 35.1 | 1,945 | 8.5 | 1,716 | 7.5 | 1,066 | 4.6 | 8,213 |
| 66 | 1967 | 67/ 4 - 67/ 9 | 6,000 | 26,596 | 28.9 | 2,681 | 10.1 | 2,472 | 9.3 | 1,517 | 5.7 | 8,325 |
| 67 | 1967 | 67/10 - 68/ 3 | 10,000 | 30,268 | 27.3 | 3,268 | 10.8 | 2,728 | 9.0 | 1,708 | 5.6 | 10,724 |
| 68 | 1968 | 68/ 4 - 68/ 9 | 10,000 | 41,617 | 36.6 | 4,521 | 10.9 | 3,409 | 8.2 | 2,189 | 5.3 | 11,653 |
| 69 | 1968 | 68/10 - 69/ 3 | 10,000 | 46,753 | 39.2 | 4,726 | 10.1 | 3,752 | 8.0 | 2,352 | 5.0 | 13,923 |
| 70 | 1969 | 69/ 4 - 69/ 9 | 10,500 | 57,197 | 41.3 | 5,537 | 9.7 | 3,915 | 6.8 | 2,550 | 4.5 | 13,907 |
| 71 | 1969 | 69/10 - 70/ 3 | 10,500 | 63,624 | 34.2 | 6,091 | 9.6 | 4,311 | 6.8 | 2,721 | 4.3 | 15,442 |
| 72 | 1970 | 70/ 4 - 70/ 9 | 10,500 | 75,924 | 42.9 | 7,166 | 9.4 | 5,269 | 6.9 | 3,169 | 4.2 | 14,931 |
| 73 | 1970 | 70/10 - 71/ 3 | 10,500 | 73,170 | 42.6 | 6,815 | 9.3 | 4,861 | 6.6 | 2,961 | 4.0 | 13,623 |
| 74 | 1971 | 71/ 4 - 71/ 9 | 11,552 | 70,151 | 50.8 | 4,304 | 6.1 | 2,621 | 3.7 | 1,826 | 2.6 | 13,834 |
| 75 | 1971 | 71/10 - 72/ 3 | 11,552 | 63,923 | 39.6 | 2,580 | 4.0 | 1,424 | 2.2 | 1,054 | 1.6 | 12,744 |
| 76 | 1972 | 72/ 4 - 72/ 9 | 11,552 | 70,948 | 42.5 | 2,550 | 3.6 | 1,802 | 2.5 | 1,272 | 1.8 | 12,096 |
| 77 | 1972 | 72/10 - 73/ 3 | 11,552 | 72,856 | 41.8 | 2,459 | 3.4 | 1,902 | 2.6 | 1,307 | 1.8 | 11,604 |
| 78 | 1973 | 73/ 4 - 73/ 9 | 11,552 | 76,847 | 39.9 | 2,876 | 3.7 | 2,427 | 3.2 | 1,652 | 2.1 | 11,285 |
| 79 | 1973 | 73/10 - 74/ 3 | 11,767 | 87,519 | 38.7 | 3,417 | 3.9 | 2,600 | 3.0 | 1,660 | 1.9 | 11,307 |

Changes in Capital, Business Performance, and Number of Employees (2)

| Consolidated | | | | | | | | | | | | |
|--------------|-------------|--------------------------------|-----------------------|-------------------------|--|--------------------------------|------------------|--------------------------------|------------------|--------------------------|------------------|----------------------------|
| Fiscal Term | Fiscal Year | Accounting Period (year/month) | Capital (million yen) | Net Sales (million yen) | Non-consolidated: Export Rate (%) Consolidated: Overseas Rate (%) | Operating Income (million yen) | Profit Ratio (%) | Recurring Profit (million yen) | Profit Ratio (%) | Net Income (million yen) | Profit Ratio (%) | No. of Employees (persons) |
| 80 | 1974 | 74/ 4 - 74/ 9 | 11,806 | 100,635 | 40.1 | 2,950 | 2.9 | 2,671 | 2.7 | 1,581 | 1.6 | 11,070 |
| 81 | 1974 | 74/10 - 75/ 3 | 11,806 | 89,529 | 35.9 | 1,816 | 2.0 | 1,752 | 2.0 | 1,035 | 1.2 | 9,804 |
| 82 | 1975 | 75/ 4 - 76/ 3 | 12,145 | 201,790 | 41.8 | 4,569 | 2.3 | 3,681 | 1.8 | 2,725 | 1.4 | 10,111 |
| 83 | 1976 | 76/ 4 - 77/ 3 | 14,767 | 285,046 | 53.7 | 9,986 | 3.5 | 10,643 | 3.7 | 5,763 | 2.0 | 11,061 |
| 84 | 1977 | 77/ 4 - 78/ 3 | 16,375 | 300,779 | 54.8 | 10,810 | 3.6 | 13,058 | 4.3 | 7,448 | 2.5 | 11,038 |
| | | | | 347,883 | 51.9 | 17,814 | 5.1 | 16,293 | 4.7 | 8,273 | 2.4 | — |
| 85 | 1978 | 78/ 4 - 79/ 3 | 20,054 | 339,634 | 50.6 | 12,203 | 3.6 | 16,534 | 4.9 | 8,647 | 2.5 | 11,403 |
| | | | | 409,417 | 50.0 | 18,403 | 4.5 | 19,473 | 4.8 | 10,621 | 2.6 | — |
| 86 | 1979 | 79/ 4 - 80/ 3 | 26,766 | 395,246 | 48.2 | 17,199 | 4.4 | 23,574 | 6.0 | 12,525 | 3.2 | 12,092 |
| | | | | 514,884 | 53.7 | 29,469 | 5.7 | 32,821 | 6.4 | 16,747 | 3.3 | — |
| 87 | 1980 | 80/ 4 - 81/ 3 | 31,714 | 501,402 | 56.2 | 19,250 | 3.8 | 29,243 | 5.8 | 16,288 | 3.2 | 13,327 |
| | | | | 623,866 | 58.4 | 36,727 | 5.9 | 38,722 | 6.2 | 24,204 | 3.9 | — |
| 88 | 1981 | 81/ 4 - 82/ 3 | 34,065 | 580,087 | 57.2 | 24,295 | 4.2 | 38,887 | 6.7 | 20,383 | 3.5 | 14,153 |
| | | | | 732,332 | 57.3 | 53,176 | 7.3 | 60,008 | 8.2 | 29,160 | 4.0 | 23,295 |
| 89 | 1982 | 82/ 4 - 83/ 3 | 35,454 | 649,332 | 54.7 | 27,927 | 4.3 | 45,513 | 7.0 | 26,350 | 4.1 | 15,216 |
| | | | | 898,041 | 54.5 | 53,548 | 6.0 | 62,188 | 6.9 | 29,896 | 3.3 | — |
| 90 | 1983 | 83/ 4 - 84/ 3 | 39,448 | 756,559 | 56.9 | 29,947 | 4.0 | 52,173 | 6.9 | 29,137 | 3.9 | 16,889 |
| | | | | 1,017,292 | 55.5 | 59,950 | 5.9 | 72,781 | 7.2 | 38,069 | 3.7 | 27,029 |
| 91 | 1984 | 84/ 4 - 85/ 3 | 50,341 | 909,581 | 61.7 | 37,043 | 4.1 | 63,384 | 7.0 | 33,853 | 3.7 | 17,927 |
| | | | | 1,166,651 | 59.2 | 65,444 | 5.6 | 82,420 | 7.1 | 39,903 | 3.4 | 28,634 |
| 92 | 1985 | 85/ 4 - 86/ 3 | 50,584 | 955,253 | 60.4 | 27,476 | 2.9 | 64,370 | 6.7 | 34,735 | 3.6 | 18,046 |
| | | | | 1,216,048 | 58.5 | 43,416 | 3.6 | 69,044 | 5.7 | 35,935 | 3.0 | 29,320 |
| 93 | 1986 | 86/ 4 - 87/ 3 | 51,648 | 868,587 | 53.0 | 6,904 | 0.8 | 37,821 | 4.4 | 20,104 | 2.3 | 17,379 |
| | | | | 1,148,681 | 49.5 | 16,446 | 1.4 | 41,236 | 3.6 | 20,775 | 1.8 | 29,879 |
| 94 | 1987 | 87/ 4 - 88/ 3 | 90,677 | 872,707 | 47.4 | 10,254 | 1.2 | 38,276 | 4.4 | 18,857 | 2.2 | 17,470 |
| | | | | 1,225,186 | 44.7 | 20,668 | 1.7 | 44,044 | 3.6 | 20,341 | 1.7 | 29,209 |
| 95 | 1988 | 88/ 4 - 89/ 3 | 109,328 | 992,665 | 47.7 | 27,777 | 2.8 | 55,234 | 5.6 | 26,232 | 2.6 | 18,282 |
| | | | | 1,258,898 | 48.7 | 47,546 | 3.8 | 64,606 | 5.1 | 29,103 | 2.3 | 32,345 |
| 96 | 1989 | 89/ 4 - 90/ 3 | 166,110 | 1,057,282 | 46.3 | 48,787 | 4.6 | 72,403 | 6.8 | 37,536 | 3.6 | 19,549 |
| | | | | 1,367,916 | 49.0 | 79,670 | 5.8 | 91,052 | 6.7 | 41,720 | 3.0 | 33,858 |
| 97 | 1990 | 90/ 4 - 91/ 3 | 170,877 | 1,152,678 | 44.8 | 50,157 | 4.4 | 80,225 | 7.0 | 44,340 | 3.8 | 20,894 |
| | | | | 1,532,571 | 48.7 | 76,041 | 5.0 | 91,141 | 5.9 | 46,918 | 3.1 | 36,532 |
| 98 | 1991 | 91/ 4 - 92/ 3 | 172,351 | 1,202,014 | 45.1 | 43,275 | 3.6 | 70,647 | 5.9 | 36,063 | 3.0 | 21,521 |
| | | | | 1,554,920 | 47.8 | 61,640 | 4.0 | 73,572 | 4.7 | 39,057 | 2.5 | 40,910 |
| 99 | 1992 | 92/ 4 - 93/ 3 | 173,088 | 1,152,887 | 48.9 | 24,812 | 2.2 | 44,538 | 3.9 | 25,021 | 2.2 | 22,252 |
| | | | | 1,508,326 | 50.6 | 48,728 | 3.2 | 51,589 | 3.4 | 29,612 | 2.0 | 41,863 |

| Consolidated | | | | | | | | | | | | |
|--------------|-------------|--------------------------------|-----------------------|-------------------------|--|--------------------------------|------------------|--------------------------------|------------------|--------------------------|------------------|----------------------------|
| Fiscal Term | Fiscal Year | Accounting Period (year/month) | Capital (million yen) | Net Sales (million yen) | Non-consolidated: Export Rate (%) Consolidated: Overseas Rate (%) | Operating Income (million yen) | Profit Ratio (%) | Recurring Profit (million yen) | Profit Ratio (%) | Net Income (million yen) | Profit Ratio (%) | No. of Employees (persons) |
| 100 | 1993 | 93/ 4 - 94/ 3 | 191,718 | 1,170,221 | 48.6 | 31,196 | 2.7 | 45,321 | 3.9 | 25,529 | 2.2 | 22,615 |
| | | | | 1,518,088 | 49.2 | 48,614 | 3.2 | 49,421 | 3.3 | 31,792 | 2.1 | 42,896 |
| 101 | 1994 | 94/ 4 - 95/ 3 | 195,378 | 1,261,562 | 48.2 | 56,062 | 4.4 | 67,073 | 5.3 | 34,631 | 2.7 | 23,005 |
| | | | | 1,617,620 | 48.8 | 80,311 | 5.0 | 77,223 | 4.8 | 44,508 | 2.8 | 43,895 |
| 102 | 1995 | 95/ 4 - 96/ 3 | 198,325 | 1,281,752 | 44.0 | 57,919 | 4.5 | 70,530 | 5.5 | 39,372 | 3.1 | 23,416 |
| | | | | 1,650,708 | 47.2 | 87,797 | 5.3 | 86,915 | 5.3 | 45,294 | 2.7 | 44,789 |
| 103 | 1996 | 96/ 4 - 97/ 3 | 204,021 | 1,375,634 | 43.9 | 58,712 | 4.3 | 71,400 | 5.2 | 39,844 | 2.9 | 23,456 |
| | | | | 1,790,580 | 48.0 | 91,262 | 5.1 | 88,631 | 4.9 | 48,546 | 2.7 | 45,091 |
| 104 | 1997 | 97/ 4 - 98/ 3 | 204,035 | 1,332,152 | 47.0 | 22,382 | 1.7 | 33,338 | 2.5 | 18,330 | 1.4 | 23,474 |
| | | | | 1,790,542 | 52.2 | 55,034 | 3.1 | 50,601 | 2.8 | 24,788 | 1.4 | 48,001 |
| 105 | 1998 | 98/ 4 - 99/ 3 | 204,045 | 1,306,157 | 45.9 | 7,593 | 0.6 | 15,661 | 1.2 | 2,918 | 0.2 | 23,661 |
| | | | | 1,745,537 | 50.9 | 38,127 | 2.2 | 26,102 | 1.5 | 4,631 | 0.3 | 48,820 |
| 106 | 1999 | 99/ 4 - 00/ 3 | 204,066 | 1,419,522 | 41.3 | 43,619 | 3.1 | 45,021 | 3.2 | 24,142 | 1.7 | 23,740 |
| | | | | 1,854,774 | 47.5 | 74,460 | 4.0 | 58,745 | 3.2 | 28,130 | 1.5 | 49,748 |
| 107 | 2000 | 00/ 4 - 01/ 3 | 204,095 | 1,602,974 | 37.2 | 72,405 | 4.5 | 67,283 | 4.2 | 34,902 | 2.2 | 23,229 |
| | | | | 2,012,858 | 42.9 | 105,913 | 5.3 | 80,728 | 4.0 | 38,527 | 1.9 | 49,101 |
| 108 | 2001 | 01 / 4 - 02/ 3 | 204,675 | 1,372,309 | 38.4 | 48,333 | 3.5 | 43,298 | 3.2 | 10,235 | 0.7 | 22,710 |
| | | | | 1,803,798 | 45.5 | 73,585 | 4.1 | 48,889 | 2.7 | 11,311 | 0.6 | 46,518 |
| 109 | 2002 | 02/ 4 - 03/ 3 | 204,675 | 1,552,211 | 41.8 | 76,772 | 4.9 | 72,801 | 4.7 | 28,409 | 1.8 | 22,718 |
| | | | | 2,003,210 | 47.2 | 99,466 | 5.0 | 81,920 | 4.1 | 32,594 | 1.6 | 46,633 |
| 110 | 2003 | 03/ 4 - 04/ 3 | 204,675 | 1,804,907 | 45.8 | 97,947 | 5.4 | 99,750 | 5.5 | 54,641 | 3.0 | 22,724 |
| | | | | 2,257,273 | 49.3 | 121,670 | 5.4 | 111,601 | 4.9 | 60,715 | 2.7 | 46,164 |
| 111 | 2004 | 04/ 4 - 05/ 3 | 204,675 | 2,084,928 | 44.2 | 124,891 | 6.0 | 125,687 | 6.0 | 69,680 | 3.3 | 22,838 |
| | | | | 2,539,859 | 47.6 | 151,020 | 5.9 | 140,511 | 5.5 | 76,845 | 3.0 | 46,751 |
| 112 | 2005 | 05/ 4 - 06/ 3 | 204,675 | 2,283,109 | 46.0 | 132,474 | 5.8 | 137,114 | 6.0 | 83,954 | 3.7 | 22,949 |
| | | | | 2,797,109 | 50.1 | 163,710 | 5.9 | 150,852 | 5.4 | 88,671 | 3.2 | 46,864 |
| 113 | 2006 | 06/ 4 - 07/ 3 | 204,675 | 2,595,470 | 47.7 | 143,708 | 5.5 | 147,144 | 5.7 | 92,808 | 3.6 | 22,793 |
| | | | | 3,127,771 | 51.2 | 186,531 | 6.0 | 170,584 | 5.5 | 101,717 | 3.3 | 48,927 |
| 114 | 2007 | 07/ 4 - 08/ 3 | 204,675 | 2,768,797 | 48.5 | 120,947 | 4.4 | 116,262 | 4.2 | 80,737 | 2.9 | 22,674 |
| | | | | 3,417,736 | 53.5 | 183,692 | 5.4 | 168,399 | 4.9 | 101,922 | 3.0 | 53,708 |
| 115 | 2008 | 08/ 4 - 09/ 3 | 204,675 | 2,254,395 | 49.4 | -87,739 | -3.9 | -109,008 | -4.8 | -131,524 | -5.8 | 22,825 |
| | | | | 2,847,227 | 54.3 | -55,481 | -1.9 | -82,431 | -2.9 | -125,815 | -4.4 | 54,144 |
| 116 | 2009 | 09/ 4 - 10/ 3 | 204,675 | 2,147,682 | 41.6 | -16,977 | -0.8 | -15,707 | -0.7 | -17,449 | -0.8 | 22,331 |
| | | | | 2,755,948 | 48.1 | 51,903 | 1.9 | 30,995 | 1.1 | 4,397 | 0.2 | 53,999 |
| 117 | 2010 | 10/ 4 - 11/ 3 | 204,675 | 2,431,217 | 40.7 | 10,014 | 0.4 | 26,445 | 1.1 | 12,458 | 0.5 | 21,844 |
| | | | | 3,021,973 | 47.3 | 78,896 | 2.6 | 59,124 | 2.0 | 19,401 | 0.6 | 55,580 |
| 118 | 2011 | 11/ 4 - 12/ 3 | 204,675 | 1,873,629 | 45.9 | -114,927 | -6.1 | -91,774 | -4.9 | -359,846 | -19.2 | 21,538 |
| | | | | 2,455,850 | 51.9 | -37,552 | -1.5 | -65,437 | -2.7 | -376,076 | -15.3 | 56,756 |

Note: 1. As of fiscal 1988 (the 95th term), the method of processing net sales pertaining to credit sales by domestic consolidated subsidiaries has been changed according to a notice on accounting standards in the credit industry issued by the Ministry of International Trade and Industry (now Ministry of Economy, Trade and Industry). 2. For capital and non-consolidated performance, figures less than one million are discarded. Consolidated performance figures are rounded off to the nearest million. 3. The numbers of employees denote the numbers at the end of each fiscal term.

A History of Innovation, Born from Sincerity and Creativity

1912 1915 1925 1929 1953 1960



Tokubijo snap buckle requiring no fastening holes



Hayakawa mechanical pencil, later called the Sharp Pencil



Japan's first domestically produced crystal radio



Sharp Dyne AC vacuum-tube radio



Japan's first mass production of TVs



Mass production of color TVs

1962 1963 1964 1966



Ultrasonic washer for cleaning large clocks



Japan's first mass production of microwave ovens



Mass production of standardized solar modules



World's first all-transistor-diode desktop calculator

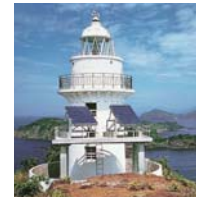

Ogami Island Lighthouse equipped with 225W solar cells, the world's largest (at the time) (photo courtesy of Japan Coast Guard)



Japan's first home microwave oven with a turntable

1969 1970 1972 1973



World's first calculator incorporating LSIs



Double LED capable of simultaneously emitting visible light and near-infrared light



World's first color TV to display the channel number on the screen



Battery-operated compact electronic cash register



Plain paper copier incorporating IC control



World's first pocket calculator with an LCD

1974 1976 1978 1979



Success in reproducing TV images using high-brightness, long-life, thin-film EL elements (product shown is from 1977)



First solar-powered calculator



Refrigerator with the most frequently used compartments located at the top



TV-in-TV for watching two programs at the same time



Front-loading VCR priced in the affordable 150,000-yen price range



Portable stereo system with dual cassettes for creating original cassette tapes

1979 1980 1981



Pocket electronic translator for Japanese-English translations



Japanese word processor



World's first microwave oven with a sensor for automatic cooking



Color TV with built-in VCR



Pocket computer with BASIC programming capability



World's first stereo system that could automatically play both sides of a vinyl record

1981 1982 1983 1984



World's smallest and lightest (at the time) plain paper copier



Personal computer



Laser diode with a proprietary structure that gave it long life



World's first combination PC and TV

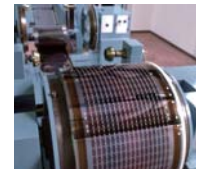

Amorphous silicon solar cells mass-produced using an innovative roll-to-roll process



Kerosene heater with a function for absorbing odors when the heater was turned off

1986 1987 1988 1989



3-in-1 facsimile with fax, copier, and phone functions



3-inch color TFT LCD TV



Electronic organizer capable of kanji (Japanese character) display



Word processor equipped with an AI dictionary for converting entire typed clauses into kanji



Development of a thin, large-screen 14-inch color TFT



LCD projection system for 100-inch big-screen home entertainment

1989 1990 1991 1992



Industry's first low-power cordless phone with an answering machine function



Industry's first dual-swing refrigerator with doors that opened from both the left and right



World's thinnest (at the time) home facsimile



The 'dream' wall-mounted 8.6-inch LCD TV, an industry-first



Notebook-PC-type English-to-Japanese translation system, the industry's smallest and lightest



LCD ViewCam, which allowed users to shoot video while watching an LCD viewfinder and enabled instant playback of just-taken footage

1992 1993 1995 1996



Fully automatic washing machine with a hole-less tub to save water and detergent



World's smallest and lightest (at the time) MD headphone player



Zaurus personal information tool, which combined essential business functions in one compact unit



Refrigerator using non-CFC vacuum insulation



Notebook PC incorporating a large, high-resolution color TFT LCD



Air conditioner with the industry's first humidifying and ventilation functions

1997 1999 2000 2001



High-reflective Super Mobile LCD for the outdoor display of bright color images without the need for a backlight



World's first 1-bit amp utilizing 2.8 MHz high-speed sampling and 7th order delta-sigma modulation



Industry's first camera-equipped mobile phone (for J-Phone)



Plasmacluster air purification technology, which used positive and negative ions to eliminate airborne mold



Cyclonic vacuum cleaner, which used centrifugal force to separate dust and air, keeping exhaust air clean



AQUOS, the LCD TV for the 21st century

1979 1980 1981

2004 2005 2006 2008 2009



Pocket electronic translator for Japanese-English translations



Japanese word processor



World's first microwave oven with a sensor for automatic cooking



Color TV with built-in VCR



Pocket computer with BASIC programming capability



World's first stereo system that could automatically play both sides of a vinyl record



High-definition LCD TV boasting 3.15 million pixels (the first Karneyama Model TV)



Superheated steam oven for 'roasting' food with water



Full-color digital MFP employing Mycrostoner



One-Seg-compatible mobile phone with a rotating screen (for Vodafone)



108-inch commercial-use LCD monitor, the world's largest (at the time)



Energy-saving, long-life, mercury-free environmentally friendly LED lamps

1981 1982 1983 1984

2010 2011 2012



World's smallest and lightest (at the time) plain paper copier



Personal computer



Laser diode with a proprietary structure that gave it long life



World's first combination PC and TV

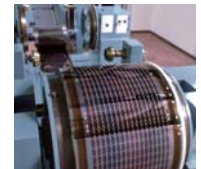

Amorphous silicon solar cells mass-produced using an innovative roll-to-roll process



Kerosene heater with a function for absorbing odors when the heater was turned off



Multi-screen display system with the world's thinnest (at the time) system frame width of 6.5 mm



AQUOS Quattron 3D LCD TV incorporating a four-primary-color 3D LCD



GALAPAGOS media tablet



Industry's first LED ceiling light



Freestyle AQUOS, which could be carried around easily



80-inch professional touchscreen LCD monitor

Chronology (Developments at Sharp)

| | Developments at Sharp (for Sharp products, see pages Chronology-01 and 02) | World Events |
|------|--|---|
| 1912 | <ul style="list-style-type: none"> • Founder, Tokuji Hayakawa, invents the Tokubijo snap buckle and acquires utility model design patent • Establishes metalworking shop in Matsui-cho, Honjo-ku, Tokyo (now Shin-ohashi, Koto-ku, Tokyo) on September 15 | |
| 1914 | <ul style="list-style-type: none"> • Moves to Hayashi-cho, Honjo-ku, Tokyo (now Tachikawa, Sumida-ku, Tokyo) • Installs one-horsepower electric motor | <ul style="list-style-type: none"> • World War I begins |
| 1915 | <ul style="list-style-type: none"> • Invents Hayakawa Mechanical Pencil and begins export to the US and Europe • Establishes Hayakawa Brothers Company | <ul style="list-style-type: none"> • Telephone line established between New York and San Francisco |
| 1920 | <ul style="list-style-type: none"> • Establishes branch factory in Oshiage, Tokyo (now Yahiro, Sumida-ku, Tokyo) | <ul style="list-style-type: none"> • League of Nations established |
| 1923 | <ul style="list-style-type: none"> • All factories destroyed during Great Kanto Earthquake • Dissolves Hayakawa Brothers Company and relocates to Osaka | <ul style="list-style-type: none"> • Great Kanto Earthquake (magnitude 7.9) |
| 1924 | <ul style="list-style-type: none"> • Establishes Hayakawa Metal Laboratories in Tanabe-cho, Higashinari-gun, Osaka Prefecture (now the location of the Head Office) | |
| 1925 | <ul style="list-style-type: none"> • Succeeds in assembling first Japan-made crystal radio set; begins mass production and sales • Establishes sales office in Utsubo, Osaka | <ul style="list-style-type: none"> • Japan's General Election Law established • Tokyo station begins radio broadcasts in Japan |
| 1926 | <ul style="list-style-type: none"> • Begins export of radio sets and components to China, Southeast Asia, India, and South America • Establishes Tokyo office in Hayashi-cho (Honjo-ku, Tokyo), a former site of the company's factory • Adopts assembly-line production for radios | <ul style="list-style-type: none"> • Japan Broadcasting Corporation (NHK) established |
| 1927 | <ul style="list-style-type: none"> • Holds Sharp radio trade fairs in Kyushu, Japan and Shanghai, China | |
| 1929 | <ul style="list-style-type: none"> • Releases AC vacuum-tube radios | <ul style="list-style-type: none"> • Wall Street Crash; world economy enters the Great Depression |
| 1930 | <ul style="list-style-type: none"> • Hayakawa tours Hong Kong • Begins attaching repair warranty notices to radios. Retailers would notify the company of repairs they did by sending back these notices to the company. | |
| 1931 | <ul style="list-style-type: none"> • Establishes sales agency in Hong Kong | <ul style="list-style-type: none"> • Manchurian Incident |
| 1933 | | <ul style="list-style-type: none"> • Japan withdraws from League of Nations • New Deal economic programs begin in the US |
| 1934 | <ul style="list-style-type: none"> • Establishes Shanghai office • Constructs Hirano Plant in Osaka | |
| 1935 | <ul style="list-style-type: none"> • Hayakawa Metal Industry Institute Co., Ltd. incorporated with capital of 300,000 yen (May 1) | <ul style="list-style-type: none"> • Youths' School Ordinance issued in Japan |
| 1936 | <ul style="list-style-type: none"> • Installs intermittent belt conveyor system • Makes Yokohama Motor Parts Manufacturing a subsidiary • Changes company name to Hayakawa Industrial Co., Ltd. • Establishes branch offices in Taipei and Seoul | <ul style="list-style-type: none"> • February 26 Incident in Japan |
| 1937 | <ul style="list-style-type: none"> • Establishes Hayakawa Commercial School for Youth | <ul style="list-style-type: none"> • Sino-Japanese War begins |
| 1941 | | <ul style="list-style-type: none"> • Pacific War begins |
| 1942 | <ul style="list-style-type: none"> • Changes company name to Hayakawa Electric Co., Ltd. | <ul style="list-style-type: none"> • War-time confiscation of metals begins in Japan |
| 1943 | <ul style="list-style-type: none"> • Head office building completed | |
| 1944 | <ul style="list-style-type: none"> • Establishes Hayakawa Electric branch factory • Establishes Izumi Plant in Izumi-cho (now Izumi City), Osaka (sold in 1948) | |
| 1945 | <ul style="list-style-type: none"> • Establishes Kyoto Plant in Shimogyo-ku (now Minami-ku), Kyoto (sold in 1947) | <ul style="list-style-type: none"> • Pacific War ends • United Nations established |
| 1946 | <ul style="list-style-type: none"> • Forms labor union • Designated special accounting company | <ul style="list-style-type: none"> • World's first electronic calculator built at University of Pennsylvania, US • Act on corporations' accounting emergency measures issued in Japan |
| 1947 | | <ul style="list-style-type: none"> • Invention of the transistor in the US |
| 1948 | <ul style="list-style-type: none"> • Establishes Sharp Shoji | <ul style="list-style-type: none"> • GHQ announces 9 principles for stabilizing the Japanese economy |
| 1949 | <ul style="list-style-type: none"> • Released from special accounting company designation • Public stock offering, company listed on Osaka Securities Exchange | <ul style="list-style-type: none"> • Dodge Line implemented in Japan • Single exchange rate of US1\$ = 360 yen implemented • Founding of People's Republic of China |

| | Developments at Sharp | World Events |
|------|--|--|
| 1950 | <ul style="list-style-type: none"> • Plant to employ the visually impaired incorporated as Tokusen Metal Limited Partnership • Establishes business principles called the Five Accumulations of Competency | <ul style="list-style-type: none"> • Korean War begins; military procurement sparks economic boom • NHK Tokyo begins experimental television broadcasts in Japan |
| 1951 | <ul style="list-style-type: none"> • Successfully develops prototype TV set | <ul style="list-style-type: none"> • Broadcasts by private radio stations begin in Japan • San Francisco Peace Treaty signed |
| 1952 | <ul style="list-style-type: none"> • Begins publication of <i>Sharp News</i>, an information magazine for retailers • Special bus begins touring the country to advertise Sharp radios and TVs • Signs cooperative agreement with RCA of the US for TV technology • Forms Sharp Friends Club to strengthen ties between dealers, retailers, and the company | <ul style="list-style-type: none"> • Japan joins IMF (International Monetary Fund) and IBRD (International Bank for Reconstruction and Development) |
| 1953 | <ul style="list-style-type: none"> • Begins full-scale mass production of first Japan-made TV sets (TV3-14T) | <ul style="list-style-type: none"> • Full-scale TV broadcasts begin in Japan • 1953 dubbed the start of Japan's electric appliance age |
| 1954 | <ul style="list-style-type: none"> • Constructs TV plant at the head office (now Tanabe Plant, Osaka) and installs endless conveyor system • Opens Ikutoku-en nursery school | <ul style="list-style-type: none"> • Bell Laboratories of the US develops solar cells |
| 1955 | <ul style="list-style-type: none"> • Formulates in-house standards (HS: Hayakawa Standards) | <ul style="list-style-type: none"> • Japan joins GATT (General Agreement on Tariffs and Trade) |
| 1956 | <ul style="list-style-type: none"> • Spins off sales division to establish Sharp Electric Co. • Constructs new building for Osaka Head Office • Constructs new building for Tokyo Branch in Taito-ku, Tokyo | <ul style="list-style-type: none"> • Japan joins United Nations • Japan economic white paper states "Japan is no longer in a post-war period" |
| 1957 | <ul style="list-style-type: none"> • Establishes Tokyo Sharp Geppan to sell Sharp products on monthly installment system; Sharp Geppan companies subsequently established nationwide • Constructs Hirano Plant No. 2 in Higashi-sumiyoshi-ku (now Hirano-ku), Osaka • Releases transistor radios • Establishes laboratory | <ul style="list-style-type: none"> • USSR launches Sputnik 1, the world's first artificial satellite • Act on temporary measures for promoting electronics industry issued in Japan |
| 1958 | <ul style="list-style-type: none"> • Begins publication of <i>Mado</i>, an in-house magazine • Sharp Electric merges with Hayakawa Dengyo, a company that sold fluorescent lighting • Sharp Shoji and QRK Shokai (exclusive Sharp dealer) combined to form Osaka Sharp Sales (regional sales companies subsequently established) • Institutes Sharp Friend Shop system; Sharp Friend Shop Associations formed nationwide | <ul style="list-style-type: none"> • EEC (European Economic Community) inaugurated • Japan issues 10,000-yen bill • Texas Instruments of the US develops ICs (integrated circuits) |
| 1959 | <ul style="list-style-type: none"> • Begins R&D on solar cells • Constructs Yao Plant as company moves to become a comprehensive consumer electronics manufacturer • Expands sales network in Southeast Asia by signing dealer agreements with Sampo Electronics and Roxy Electric | <ul style="list-style-type: none"> • Metric system adopted in Japan • Wedding of the Crown Prince and Princess in Japan |
| 1960 | <ul style="list-style-type: none"> • Constructs Yamato-koriyama Plant No. 1 (now Nara Plant) • Establishes corporate health insurance association • Introduces IBM computer at the head office | <ul style="list-style-type: none"> • Color TV broadcasts begin in Japan • Japanese cabinet announces policy of doubling national income |
| 1961 | <ul style="list-style-type: none"> • Establishes Central Research Laboratories | |
| 1962 | <ul style="list-style-type: none"> • Establishes Sharp Electronics Corporation (SEC) in the US, the company's first overseas sales base • Begins mass production of commercial-use microwave ovens (R-10) • Osaka Municipal Hayakawa Welfare Hall completed with construction funds donated by President Hayakawa • Builds shrine on Mt. Koya for holding Buddhist memorial services for deceased employees | <ul style="list-style-type: none"> • Cuban missile crisis • Number of television subscribers in Japan reaches 10 million people |
| 1963 | <ul style="list-style-type: none"> • Establishes service company in Osaka • Company reorganized into three divisions: radio, home appliances, and industrial equipment • Establishes Sharp Tokyo Product Center | <ul style="list-style-type: none"> • Japan acquires GATT Article 11 status • US President Kennedy assassinated • First satellite broadcast between Japan and the US |
| 1964 | <ul style="list-style-type: none"> • Release world's first all-transistor diode electronic desktop calculator (CS-10A) as company moves to become a comprehensive electronics manufacturer • Builds mass-production line for solar cells | <ul style="list-style-type: none"> • Japan acquires IMF Article 8 status and joins OECD • Tokaido Shinkansen bullet train begins operations in Japan • Summer Olympics held in Tokyo |
| 1965 | <ul style="list-style-type: none"> • Institutes 70 Strategy to strengthen distribution system • Launches ATOM Unit program | |
| 1966 | <ul style="list-style-type: none"> • Releases home-use microwave oven with a turntable (R-600) | <ul style="list-style-type: none"> • Population of Japan exceeds 100 million |
| 1967 | <ul style="list-style-type: none"> • Launches 55 Campaign that included Sharp technology fairs to celebrate 55th anniversary of company's founding • Constructs Hiroshima Plant to mass produce transistor radios • Sharp Electric absorbed into Hayakawa Electric • Sharp Electronic Sales Okinawa Corporation established in Okinawa, then under US rule | <ul style="list-style-type: none"> • Kennedy Round agreements to liberalize trade signed • EC (European Community) established • Basic Act for Environmental Pollution Control enacted in Japan • ASEAN (Association of Southeast Asian Nations) formed |
| 1968 | <ul style="list-style-type: none"> • Establishes Hayakawa Electric Europe GmbH (HEEG) (name changed to Sharp Electronics [Europe] GmbH [SEEG] in 1970) as sales base in West Germany • Holds first Basic Management Policy Conference • Constructs Tochigi Plant to mass produce color TVs • Establishes Business Cooperation Centers nationwide | <ul style="list-style-type: none"> • Consumers Protection Basic Act enacted in Japan • Air Pollution Control Act enacted in Japan • Prototype LCD produced at RCA in the US • Anti-dumping lawsuit filed by US Electronics Industry Association against Japanese TV manufacturers • Japan's GNP becomes No. 2 among free nations of the world |

| | Developments at Sharp | World Events |
|------|--|--|
| 1969 | <ul style="list-style-type: none"> • Launches MI campaign • Signs cooperative technical agreement with North American Rockwell Corporation on ICs • Osaka Municipal Abeno Youth Center completed with construction funds donated by President Hayakawa • Establishes office equipment sales companies in Tokyo, Osaka, and Nagoya • Establishes Sharp Electronics (U.K.) Ltd. (SUK) as sales base in the UK • Develops world's first GND (gallium arsenic negative-resistance light-emitting diode) semiconductor • Releases world's first electronic calculator incorporating MOS LSIs (QT-8D) | <ul style="list-style-type: none"> • US Apollo 11 lands on the moon and man walks on its surface for the first time |
| 1970 | <ul style="list-style-type: none"> • Changes company name to Sharp Corporation • Establishes Sharp Precision Machinery Co., Ltd. (name changed to Sharp Manufacturing Systems Corporation in 1994) • Senior Executive Director Akira Saeki named president, President Tokuji Hayakawa named chairman • Constructs Advanced Development and Planning Center • Implements business group system • Releases gallium arsenide double LED | <ul style="list-style-type: none"> • Japan World Expo '70 held in Senri, Osaka (77 countries participate and visitors number 64.21 million in 6 months) |
| 1971 | <ul style="list-style-type: none"> • Establishes Sharp Corporation of Australia Pty. Ltd. (SCA) as sales base in Australia | <ul style="list-style-type: none"> • President Nixon announces economic policies to defend the US dollar ("Nixon Shock") • Exchange rate adjusted to 308 yen per US dollar under the Smithsonian Agreement (yen adjusted by 16.88%) • US trade deficit for the first time in 80 years |
| 1972 | <ul style="list-style-type: none"> • Releases company's first copier • Launches new sales company system (regional sales companies consolidated into 16 companies by region) • Launches S734 Project for developing COS calculators • Adds Sharp Grand Award to annual employee commendation • Opens Consumer Information Centers at nine service companies throughout Japan • Establishes Sharp System Products Co., Ltd. • Forms Sharp Employee Stockholder Association | <ul style="list-style-type: none"> • Winter Olympics in Sapporo • US returns Okinawa to Japan • Japan-China diplomatic relations restored • US-China joint communiqué announced |
| 1973 | <ul style="list-style-type: none"> • Establishes Business Philosophy, Business Creed, and Basic Business Principles • Sets up employee savings scheme • Establishes Sharp Data Corporation (SDA) (name changed to Sharp Korea Corporation [SKC] in 1984) as manufacturing base in Korea • Begins production of C-MOS LSIs; releases pocket-sized COS calculator with LCD | <ul style="list-style-type: none"> • Japan shifts the yen to floating exchange rate system • First oil crisis; OPEC raises crude oil prices and declares production cuts; shortage of goods and soaring prices |
| 1974 | <ul style="list-style-type: none"> • Holds first company-wide QC circle convention • Constructs Sharp Tokyo Building • Establishes Sharp Electronics of Canada Ltd. (SECL) as sales base in Canada • Establishes Sharp-Roxy Corporation (M) Sdn. Bhd. (SRC) as manufacturing base in Malaysia (name changed to S&O Electronics [Malaysia] Sdn. Bhd. [SOEM] in 2008) • Launches ELM products • Formulates company-wide quality standards (SS: Sharp Corporation Standards) | <ul style="list-style-type: none"> • Large-Scale Retail Store Law enacted in Japan • Japanese economy registers negative growth for the first time since WWII |
| 1975 | <ul style="list-style-type: none"> • Begins mass production of color TVs at SCA in Australia | <ul style="list-style-type: none"> • Vietnam War ends |
| 1976 | <ul style="list-style-type: none"> • Launches New Life product strategy • Sharp solar cells installed on Ume, Japan's first operational ionosphere-observing satellite | <ul style="list-style-type: none"> • Japan's trade surplus increases; voluntary export restraints demanded by the US and Europe |
| 1977 | <ul style="list-style-type: none"> • Establishes Sharp System Service • Launches Sharp Taskforce (<i>Kin-Pro</i>) system • Tokusen Metal Limited Partnership certified as special subsidiary of Sharp Corporation | <ul style="list-style-type: none"> • Japan voluntarily restrains exports of color TVs to the US |
| 1978 | | <ul style="list-style-type: none"> • Japan-China Treaty of Peace and Friendship signed |
| 1979 | <ul style="list-style-type: none"> • Establishes Sharp Electronics (Svenska) AB (SES) (name changed to Sharp Electronics [Nordic] AB [SEN] in 2000) as sales base in Sweden • Sharp Manufacturing Company of America (SMCA) starts operations as production division of SEC • Establishes SBC Software | <ul style="list-style-type: none"> • Diplomatic relations restored between China and the US for the first time in 30 years (US breaks diplomatic relations with Taiwan) • Second oil crisis • 5th G7 Summit held in Tokyo |
| 1980 | <ul style="list-style-type: none"> • Announces one-trillion yen initiative • Forms Sharp Fellowship Society • Launches New Business product strategy under a "new business style" concept • Chairman Tokuji Hayakawa passes away • Establishes Sharp Business Co., Ltd. • Establishes Sharp-Roxy Electronics Corporation (M) Sdn. Bhd. (SREC) as manufacturing base in Malaysia (merged into SMM in 2009) | <ul style="list-style-type: none"> • Iran-Iraq War begins • Revision to the foreign exchange law in Japan; liberalization of capital transactions |
| 1981 | <ul style="list-style-type: none"> • Establishes Sharp Consumer Electronics Co., Ltd. • Constructs Shinjo Plant (now Katsuragi Plant) in Nara • Constructs mass-production plant for EL displays (starts full-scale operations in 1983) • Develops laser diode with VSIS architecture | <ul style="list-style-type: none"> • Trade dispute over automobiles between Japan and the US; trade friction intensifies |
| 1982 | <ul style="list-style-type: none"> • Establishes Sharp (Phils.) Corporation (SPC) as manufacturing base in the Philippines • Establishes Sharp Finance Corporation | <ul style="list-style-type: none"> • CDs (compact disks) go on sale |

| | Developments at Sharp | World Events |
|------|---|---|
| 1982 | <ul style="list-style-type: none"> • Establishes Sharp-ECD Solar Co., Ltd. as joint venture with Energy Conversion Devices Inc. of the US • Sharp multinet system goes online • Tokusen Metal Limited Partnership reorganized into Sharp Tokusen Industry Co. | |
| 1983 | <ul style="list-style-type: none"> • Establishes Sharp Engineering Corporation • EL displays installed on the Space Shuttle | <ul style="list-style-type: none"> • Game console released by toy manufacturer become huge hit in Japan |
| 1984 | | |
| 1985 | <ul style="list-style-type: none"> • Sharp Manufacturing Company of U.K. (SUKM) starts operations as production division of SUK • Holds comprehensive technology exhibitions in Beijing and Shanghai • Establishes Sharp-Roxy Appliances Corporation (M) Sdn. Bhd. (SRAC) as manufacturing base in Malaysia (ceases operations in 2002) • Establishes Sharp-Roxy Sales & Service Company (M) Sdn. Bhd. (SRSSC) as sales base in Malaysia • Establishes Creative Lifestyle Focus Center • Constructs Fukuyama Plant • Establishes Sharp Trading Corporation • Builds prototype of 3-inch color LCD TV | <ul style="list-style-type: none"> • Mikhail Gorbachev elected General Secretary of the Communist Party of the USSR • NTT (Nippon Telegraph and Telephone Corporation) and JT (Japan Tobacco Inc.) launched as public corporations • Yen rises rapidly following the Plaza Accord |
| 1986 | <ul style="list-style-type: none"> • Builds "futuristic electric house" on the grounds of Yao Plant • Establishes Sharp Electronics (Schweiz) AG (SEZ) as sales base in Switzerland • Establishes Sharp Electronics GmbH (SEA) as sales base in Austria (merges with SEEG in 2004 to become SEEG Austria Branch) • Establishes Sharp-Roxy Sales (Singapore) Pte., Ltd. (SRS) as sales base in Singapore • Establishes Sharp Electrónica España S.A. (SEES) as manufacturing and sales base in Spain (ceases manufacturing in 2011) • Senior Executive Director Haruo Tsuji named president, President Akira Saeki named chairman • Establishes Sharp Electronics Taiwan Co., Ltd. (SET) as manufacturing base in Taiwan (liquidated in 2010) • Launches Liquid Crystal Display Division | <ul style="list-style-type: none"> • Space Shuttle Challenger explodes after takeoff, killing all 7 crew members • Publication of the Maekawa Report calling for expanding domestic demand in Japan • Meltdown at Chernobyl nuclear power plant in the USSR releases radioactivity across Europe • US-Japan Semiconductor Agreement signed • US increases net foreign debt |
| 1987 | <ul style="list-style-type: none"> • Establishes Sharp Electronics Sales Corporation • Establishes Sharp Appliances (Thailand) Limited (SATL) as manufacturing base in Thailand • Establishes Sharp Electronics (Singapore) Pte., Ltd. (SESL) as kit export base in Singapore • Chairman Akira Saeki appointed as corporate advisor • Establishes Sharp-Roxy (Hong Kong) Ltd. (SRH) as sales base in Hong Kong | <ul style="list-style-type: none"> • Dow Jones Industrial Average drops 22.6% on 'Black Monday', the largest one-day percentage decline ever • Land prices skyrocket in Tokyo area |
| 1988 | <ul style="list-style-type: none"> • The <i>Sharp Columbus</i>, a promotional event boat, cruises the waters of Japan for 18 months • Establishes Sharp Corporation of New Zealand Ltd. (SCNZ) as sales base in New Zealand • Establishes Sharp Precision Manufacturing (U.K.) Ltd. (SPM) as manufacturing base in the UK (liquidated in 2010) • Introduces in-house recruiting system • Develops hologram laser unit jointly with Philips International B.V. of the Netherlands • Proclaims goal of becoming comprehensive electronics manufacturer on the strength of its optoelectronics technologies • Develops world's first 14-inch color TFT LCD | <ul style="list-style-type: none"> • Iran-Iraq War ends after 8 years |
| 1989 | <ul style="list-style-type: none"> • Establishes Sharp Manufacturing France S.A. (SMF) as manufacturing base in France • Establishes Sharp Thebnakorn Co., Ltd. (STCL) as sales base in Thailand (name changed to Sharp Thai Co., Ltd. [STCL] in 2007) • Establishes Kalyani Sharp India Limited (KSIL) as manufacturing base in India (name changed to Sharp India Limited [SIL] in 2005) • Establishes Sharp Manufacturing Corporation (M) Sdn. Bhd. (SMM) as manufacturing base in Malaysia | <ul style="list-style-type: none"> • US and Japan launch Structural Impediments Initiative • Fall of the Berlin Wall • Malta Summit between leaders of the US and the USSR brings Cold War to an end • Tokyo Stock Exchange average closes at a record high |
| 1990 | <ul style="list-style-type: none"> • Establishes Sharp Corporation (Taiwan) (SCOT) as sales base in Taiwan • Establishes Sharp Laboratories of Europe, Ltd. (SLE) as base to conduct basic research in the UK • Launches Liquid Crystal Display Group • SUKM receives the UK Queen's Award for Export and Technology • Establishes Sharp International Finance (U.K.) Plc. (SIF) as financial subsidiary in the UK • Establishes Sharp Burotype Machines S.A. (SBM) as sales base in France (name changed to Sharp Electronics France S.A. [SEF] in 1991) • Establishes Sharp Electronics (Italia) S.p.A. (SEIS) as sales base in Italy • Company-wide small-group activities renamed Sharp CATS (Creative Action Teams) • Establishes childcare leave system • Achieves non-consolidated net sales of 1 trillion yen (fiscal 1989) | <ul style="list-style-type: none"> • USSR amends constitution; Gorbachev becomes first USSR president • Iraq invades Kuwait, resulting in the Gulf Crisis • East and West Germany reunite for the first time in 44 years • Volume controls on Japan's real estate investment lead to the bursting of the bubble economy |
| 1991 | <ul style="list-style-type: none"> • Establishes Sharp Electronics Benelux B.V. as sales base in the Netherlands • Begins production at color TFT LCD plant (NF-1 production line) at Advanced Development and Planning Center | <ul style="list-style-type: none"> • Gulf War begins as multinational forces invade Iraq • End of 69-year history of USSR; establishment of CIS |

| | Developments at Sharp | World Events |
|------|---|---|
| 1992 | <ul style="list-style-type: none"> Establishes Sharp Electronic Components (Taiwan) Corporation (SECT) as electronic components sales base, and Sharp Technology (Taiwan) Co., Ltd. (STT) as IC design and development base (STT liquidated in 2007) Ties up with Intel Corporation in flash memory business Establishes Sharp Live Electronics Sales Corporation Establishes Shanghai Sharp Air-Conditioning Systems Co., Ltd. (SSAC) as manufacturing base in China (name changed to Shanghai Sharp Electronics Co., Ltd. [SSEC] in 1994) Constructs Makuhari Building Establishes Sharp Thebnakorn Manufacturing (Thailand) (STTM) as production division of STCL | <ul style="list-style-type: none"> At the Earth Summit in Rio de Janeiro, Brazil, the UNFCCC (United Nations Framework Convention on Climate Change) was adopted European currency crisis |
| 1993 | <ul style="list-style-type: none"> Begins production at Fukuyama Plant using 0.6 μm process design rules Establishes Sharp Office Equipments (Changshu) Co., Ltd. (SOCC) as manufacturing base in China | <ul style="list-style-type: none"> Maastricht Treaty creates the EU (European Union) |
| 1994 | <ul style="list-style-type: none"> Develops industry's first reflective TFT LCD requiring no backlight Establishes Wuxi Sharp Electronic Components Co., Ltd. (WSEC) as manufacturing base in China Establishes P.T. Sharp Yasonta Indonesia (SYI) as manufacturing base, and P.T. Sharp Yasonta Antarnusa (SYA) as sales base in Indonesia (the two merged to form P.T. Sharp Electronics Indonesia [SEID] in 2005) | <ul style="list-style-type: none"> Start of residential PV monitoring program in Japan NAFTA (North American Free Trade Agreement) comes into force |
| 1995 | <ul style="list-style-type: none"> Establishes Sharp Laboratories of America, Inc. (SLA) as research base in the US Establishes P.T. Sharp Semiconductor Indonesia (SSI) as manufacturing base for semiconductors in Indonesia Begins operations at Mie Plant for mass production of LCDs Establishes Sharp Electronics (Malaysia) Sdn. Bhd. (SEM) as combined R&D base and parts supplier in Malaysia | <ul style="list-style-type: none"> WTO (World Trade Organization) launched 7.3-magnitude earthquake strikes Osaka-Kobe area in Japan Microsoft Windows® 95 released, spurring PC sales |
| 1996 | <ul style="list-style-type: none"> Establishes Nanjing Sharp Electronics Co., Ltd. (NSEC) as manufacturing base in China Official Sharp Internet website opens | <ul style="list-style-type: none"> Start of the IT bubble A string of bankruptcies of financial companies and bad loans cause financial instability in Japan |
| 1997 | <ul style="list-style-type: none"> All Sharp production bases in Japan certified for ISO 14001 Establishes Shanghai Sharp Mold and Manufacturing Systems Co., Ltd. (SSMC) as manufacturing base in China Establishes Sharp Electrónica Mexico S.A. de C.V. (SEMEX) as manufacturing base in Mexico Launches Environmental Protection Group and starts 3G-1R Strategy Introduces integrated distribution system in Japan | <ul style="list-style-type: none"> Hong Kong reverts to China Asian currency crisis Kyoto Protocol adopted at COP3 (third session of the Conference of the Parties to the UNFCCC) |
| 1998 | <ul style="list-style-type: none"> Establishes Sharp Middle East Free Zone Establishment (SMEF) as sales base in Dubai, United Arab Emirates Jointly develops world's first CG-Silicon (continuous grain silicon) technology with Semiconductor Energy Laboratory Co., Ltd. Develops and begins mass production of world's first stacked CSP (chip size package) Establishes Sharp Document Systems Corporation and Sharp Amenity Systems Corporation Corporate Senior Executive Director Katsuhiko Machida named president, President Haruo Tsuji named corporate advisor Formulates Sharp Business Standards and Action Guidelines Establishes Sharp Electronics Marketing Corporation President Machida declares that by 2005 all TVs Sharp sells in Japan will be LCD TVs | <ul style="list-style-type: none"> Winter Olympics held in Nagano, Japan Japan's Home Appliance Recycling Law enacted Russian currency crisis Japan's trade surplus reaches a record high (13 trillion 985.1 billion yen) |
| 1999 | <ul style="list-style-type: none"> Launches Sharp Space Town information service Develops 1-bit amplifier technology for reproducing ultra high-fidelity sound Establishes Sharp Electronics Inc. of Korea (SEI) as sales base in Korea Establishes Sharp Software Development India Pvt. Ltd. (SSDI) as software development company in India Publishes first Environmental Report | <ul style="list-style-type: none"> EU announces the euro as its official currency; enters circulation in January 2002 Dow Jones Industrial Average closes above \$10,000 for the first time Turkey and Taiwan struck by 7.6-magnitude earthquakes Over 40% of Japanese have mobile phones |
| 2000 | <ul style="list-style-type: none"> Launches advertising campaign for AQUOS, calling it a TV for the 21st century Establishes Sharp Microelectronics of China (Shanghai) Co., Ltd. (SMC) as sales base in China (name changed to Sharp Electronics [Shanghai] Co., Ltd. [SES] in 2003) Establishes Sharp Business Systems (India) Limited (SBI) as sales base in India Becomes world's largest manufacturer of solar cells. Maintains this position for seven consecutive years, until 2006 | <ul style="list-style-type: none"> No major problems as a result of Y2K computer bug BS (broadcast satellite) television begins in Japan IT bubble bursts, causing IT slump |
| 2001 | <ul style="list-style-type: none"> Releases TVs with Advanced Super-V LCD Establishes S.I. Solutions jointly with IBM Japan Kansai Recycling Systems Co., Ltd. starts operations (established in 1999) Establishes Sharp Telecommunications of Europe, Ltd. (STE) as mobile telecommunications development base in the UK Establishes usability labs Establishes Comprehensive Call Centers (Customer Assistance Centers) for handling customer inquiries Establishes BRM (business risk management) Committee | <ul style="list-style-type: none"> 9/11 terrorist attacks in New York and Washington, D.C. |
| 2002 | <ul style="list-style-type: none"> Ties up with El-Araby Group for air conditioning business in Egypt Operations begin at Mihara Plant Develops 3D LCD that can be switched between 2D and 3D formats | <ul style="list-style-type: none"> Circulation of euro currency begins in the EU FIFA World Cup held jointly by Korea and Japan |

| | Developments at Sharp | World Events |
|------|---|--|
| 2003 | <ul style="list-style-type: none"> Revises Sharp Business Standards and Action Guidelines; enacts Sharp Charter of Corporate Behavior Launches Sharp Green Club (SGC) SEMEX in Mexico begins production of AQUOS LCD TVs Establishes consumer electronics R&D center in China Constructs Mie Plant No. 3 to manufacture System LCDs Changes name of small-group activities to R-CATS and starts unique activities Establishes CSR Promotion Division Develops reflective/transmissive Mobile Advanced Super-V LCD | <ul style="list-style-type: none"> Joint US-British forces attack Iraq Terrestrial digital television broadcasts begin in Tokyo, Osaka, and Nagoya in Japan |
| 2004 | <ul style="list-style-type: none"> Starts eS-SEM strategic management system Operations begin at Kameyama Plant Establishes Sharp Technical Components (Wuxi) Co., Ltd. as manufacturing base in China Opens AQUOS Plaza sites in Tokyo, Nagoya, and Osaka for the repair of large-screen AQUOS LCD TVs Announces environmental vision of becoming a zero global warming impact company by 2010 (achieved in 2008) | <ul style="list-style-type: none"> Massive undersea earthquake (magnitude 9.0) off Sumatra and massive tsunami in countries around Indian Ocean Avian influenza runs rampant throughout Asia Full-scale start of Germany's feed-in tariff policy for promoting renewable energy |
| 2005 | <ul style="list-style-type: none"> Takes part in Team Minus 6%, Cool Biz, and Warm Biz, three initiatives of Japan's Ministry of the Environment Establishes Sharp Electronics Sales (China) Co., Ltd. (SESC) as sales base in China Launches Sharp Yonago Corporation Establishes Sharp Manufacturing (Thailand) Co., Ltd. (SMTL) as manufacturing base in Thailand (reorganization of STTM) Establishes Sharp Group Charter of Corporate Behavior and Sharp Code of Conduct Electronic calculators recognized as IEEE Milestone | <ul style="list-style-type: none"> Kyoto Protocol enters into force |
| 2006 | <ul style="list-style-type: none"> Establishes Sharp Manufacturing Poland Sp. z o.o. (SMPL) as manufacturing base in Poland Kameyama Plant wins the Economy, Trade and Industry Minister's Prize in the 8th Japan Water Award Teams up with NPO Weathercaster Network to begin eco-education in elementary schools in Japan | <ul style="list-style-type: none"> RoHS Directive takes effect in Europe Start of One-Seg, the terrestrial digital TV broadcast service for mobile devices in Japan |
| 2007 | <ul style="list-style-type: none"> Corporate Senior Executive Director Mikio Katayama named president, President Katsuhiko Machida named chairman Establishes Sharp Electronics Russia LLC (SER) as sales base in Russia SEEG split into three separate entities for consumer electronics, information products, and solar power systems Establishes Toyama Plant to manufacture silicon for solar cells | <ul style="list-style-type: none"> Subprime mortgage crisis in the US leads to worldwide financial chaos |
| 2008 | <ul style="list-style-type: none"> Introduces executive officer system Establishes Health and Environment Systems Group Sharp Corporation attains Privacy Mark certification Announces goal of becoming a total solutions provider for solar power | <ul style="list-style-type: none"> Magnitude-8.0 earthquake in Sichuan, China Summer Olympics held in Beijing Financial services firm Lehman Brothers of the US declares bankruptcy; burst of the real estate bubble triggers worldwide financial crisis |
| 2009 | <ul style="list-style-type: none"> Establishes Sharp Electronics (Vietnam) Company Limited (SVN) as sales base in Vietnam Announces new environmental vision of becoming an Eco-Positive Company Starts production of LCD panels at Green Front Sakai | <ul style="list-style-type: none"> WHO raises influenza pandemic alert to phase 6 Eco-Point system introduced in Japan to stimulate consumer electronics sales |
| 2010 | <ul style="list-style-type: none"> Akira Saeki, corporate senior advisor and former president, passes away Develops high-conversion-efficiency solar cells Starts production of solar cells at Green Front Sakai Solar cell business recognized as IEEE Milestone Establishes Sharp Corporation Mexico, S.A. de C.V. (SCMEX) as sales base in Mexico Establishes Enel Green Power & Sharp Solar Energy S.r.l. (ESSE) as independent power producer in Italy Establishes 3 Sun S.r.l. as manufacturing base in Italy Establishes Sharp Electronics Research & Development (Nanjing) Co., Ltd. (SERD) as design and development base in China Acquires Recurrent Energy, LLC, a US developer of solar power plants | <ul style="list-style-type: none"> China's GDP surpasses that of Japan to become world's second largest economy |
| 2011 | <ul style="list-style-type: none"> Establishes Sharp Laboratories of China Co., Ltd. (SLC) as R&D base in China Establishes Sharp Solar Maintenance Asia Co., Ltd. (SSMC) as maintenance company for solar power plants in Thailand Establishes Sharp Brasil Comércio e Distribuição de Artigos Eletrônicos Ltda. (SBCE) as sales base in Brazil Establishes Sharp (China) Investment Co., Ltd. (SCIC) as Chinese headquarters Establishes HEMS Alliance with nine other companies | <ul style="list-style-type: none"> Magnitude-9.0 earthquake and subsequent tsunami cause widespread damage in Japan, including at a nuclear power plant Large scale flooding in Thailand Euro currency crisis deepens and spreads to more and more countries Analog television broadcasts end in most of Japan |
| 2012 | <ul style="list-style-type: none"> Executive Managing Officer Takashi Okuda named president, President Mikio Katayama named chairman Establishes strategic global partnership with world's leading EMS Hon Hai Group of Taiwan Starts mass production of LCD panels using IGZO (oxide semiconductor) technology Establishes Sharp Electronics (Europe) Limited (SEE) as European headquarters in the UK | <ul style="list-style-type: none"> Japan's feed-in tariff law takes effect Summer Olympics held in London |