

SHARP

MX-4501N/3500N

Digital Full Colour Multifunctional System



Advance Your Business with Secure, Multifunction Colour



MX-4501N



MX-4501N MX-3500N



The validation obtained by this product concerning information security is the result of an evaluation based on standards and methods prescribed by the Target of Evaluation. It certifies that the product conforms to security assurance requirements.

COPY

NETWORK PRINT

NETWORK SCAN

SHARPEDESK

Let the synergy of colour and multifunction take your business to new heights

Colour is a powerful communication tool that can give your business an extra edge in getting your message through. With the MX-4501N and MX-3500N, you can bring the advantages of colour to your office without compromising productivity, quality or cost.

Fast output speeds for colour and B/W documents, high-quality imaging technology and a host of productivity-boosting features make copy/print jobs effortless. And with the optional Fiery® Print Controller, your entire office can benefit from powerful network printing solutions.

In addition to advanced printing and copying, the MX-4501N and MX-3500N feature an integrated document management system that seamlessly streamlines office workflow, while their multi-layered security functions ensure that your business is protected.

MX-4501N/3500N

Digital Full Colour Multifunctional System

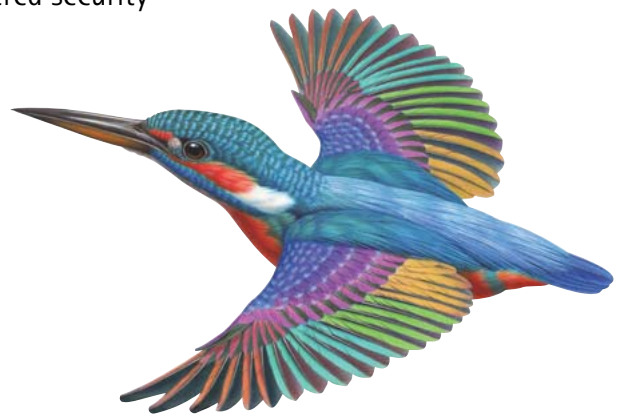

Easy to Use and Environmentally Conscious

The MX-4501N and MX-3500N are easy to use for everyone in your office, regardless of ability or experience. Users can navigate quickly and easily through more advanced functions with the help of an easy-to-read 8.9-inch touch-screen LCD with customisable keys.

The MX-4501N and MX-3500N are also conscious of the environment by using newly developed supplies such as a low-consumption toner and feature a design that supports the RoHS directive and offers one of the lowest standby power consumption rates available.



MX-4501N

NETWORK PRINTING	COPYING	IMAGE SENDING	DOCUMENT MANAGEMENT	SECURITY	ENVIRONMENT & USER-FRIENDLY	OPTIONS	SPECIFICATIONS
P. 3-4	P. 5	P. 6	P. 7	P. 8	P. 9	P. 10	back cover

NETWORK PRINTING

Productive & Superb Quality

Speedy Printing and Data Processing

The tandem printing engine with four in-line drums helps the MX-4501N/3500N deliver a fast output of **35 ppm in full colour and 45/35 ppm in B/W***. Its short, straight paper path minimises paper jams to save you paper and toner costs. And the MX-4501N/3500N's RIP Once/Print Many function only needs to download print data once from the PC for printing, enabling multi-page documents to be printed directly from the MX-4501N/3500N's hard disk. Printed documents are automatically **collated** and output in the proper page order, with each set **stacked offset** for easier retrieval.

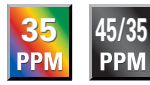

* A4 (8 1/2" x 11"), portrait

Large Paper Capacity

For high-volume work, the MX-4501N/3500N can accommodate an optional 3,500-sheet large-capacity tray and stand with 2 x 500-sheet paper drawers for a total capacity of **5,600 sheets**. The **Auto Tray Switching** function automatically switches to another paper tray filled with the same size paper, allowing you to do extra-large volume jobs without worrying about running out of paper.



High-Quality Imaging with Mycrostoner

The MX-4501N/3500N adopts **Mycrostoner**, a new toner of smaller particle size that clearly reproduces thin lines, small characters and halftone colours. The **oil-less toner** also produces vivid, natural-looking colour printouts that you can easily write messages or post sticky notes on.

Automated Job Finishing

The MX-4501N/3500N makes it easy to create professional-looking booklets. Working together with the highly productive built-in stackless duplex module, the optional **Saddle Stitch Finisher** folds and staples sets of documents to make completed booklets. A space-efficient **Finisher** is also available for jobs that require only simple sorting and stapling. And, a **Punch Module** allows you to punch holes in documents for easy filing.



A Variety of Job Finishing Options

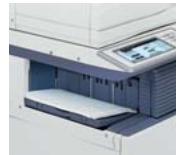
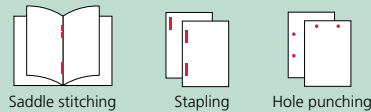

Network Tandem Function

When two MX-4501N/3500Ns are connected to the same office network, you can use both simultaneously to double output to up to **70 ppm in colour and 90/70 ppm in B/W**. With simple operation, you can quickly complete large-volume jobs to meet tight deadlines.

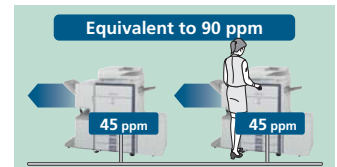

Proof Printing

To prevent the waste of large-volume misprints, the MX-4501N/3500N lets users output only the first set to check the content, adjust settings if necessary, and then initiate output of the rest of the job from the LCD control panel.

Versatile

PCL5c/PCL6 and PS3

The MX-4501N/3500N supports **PCL5c** and **PCL6** printer languages. For compatibility with **PostScript 3**, the MX-PKX1 PS3 Expansion Kit is available.

USB Memory Direct Print

The MX-4501N/3500N offers a whole new level of convenience with a USB port for printing data directly from USB memory devices — an indispensable function for users who are in a hurry or who want quick machine access without a PC. Once the device is connected, the MX-4501N/3500N guides users through simple operations on the LCD control panel.



Various Print Applications

- **Tab Print** can print directly onto tabs on document separators and insert them into assigned positions, enabling you to create professional-looking documents.
- **PDF/TIFF/JPEG Direct Print** prints PDF, TIFF or JPEG files without using the printer driver or opening applications. Note: Direct PDF printing requires optional MX-PKX1. May not support all PDF, TIFF and JPEG formats.
- **Carbon Copy Print** mode automatically outputs multiple printouts of the same data on plain and/or coloured paper; convenient for invoices and purchase orders.
- **Form Overlay** can store office document formatting such as letterheads and overlay contents in colour, eliminating the need for pre-printed paper.
- **Barcode font** compatibility (with optional AR-PF1 Barcode Font Kit)





Network-Ready

Supports Most Office Environments

The MX-4501N/3500N works as a network printer with the most commonly used network operating systems and protocols and even in mixed network OS environments. With a 64-bit, 600 MHz CPU, you get powerful network printing via 100Base-TX and 10Base-T Ethernet standards.

Other Key Features

- Duplex printing, auto colour selection
- N-up printing, Pamphlet Style printing, cover/transparency insertion

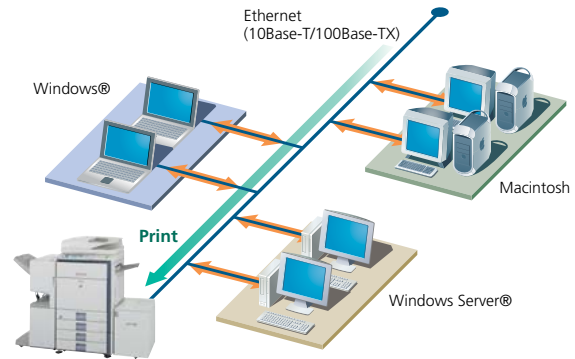

Fiery® Print Controller

The optional MX-PEX1 Fiery Print Controller upgrades the MX-4501N/3500N's network printing capabilities, combining streamlined productivity with powerful tools for managing and manipulating workflow.

Command Workstation® *

This feature enables the centralised management of multiple Fiery print controllers, allowing maximum control of print jobs.



* Command Workstation® LE for Macintosh

Job Monitor

The Job Monitor conveniently allows users to track the status of print jobs sent to the MX-4501N/3500N directly from a PC, helping to prevent misprints by alerting users if an error occurs.



Accurate Colour Reproduction

ColorWise® Pro Tools provide advanced calibration, colour editing and profile management utilities to give expert users precise control over colour quality. **ColorWise®** is a colour management system that allows casual users to maintain accurate colour output across multiple platforms and applications without difficulty.

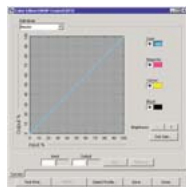

Faster Multi-Page Printing

RIP-While-Print® enables the MX-PEX1 to begin processing pages while current pages are printing, while **Continuous Print** stores processed pages in memory before printing them out, eliminating the need to cycle down the MX-4501N/3500N between different print jobs.

Genuine Adobe® PostScript®3™

The MX-PEX1 supports genuine PostScript3 for compatibility with more fonts and better graphics handling.

Fast Variable Data Printing**

Fiery **FreeForm™**, a unique and productive solution for variable data printing, makes creating full-colour customised documents easy and efficient. Once a master document is stored on the MX-PEX1, FreeForm saves time by pairing variable or personal data with the master rather than making each document one by one.

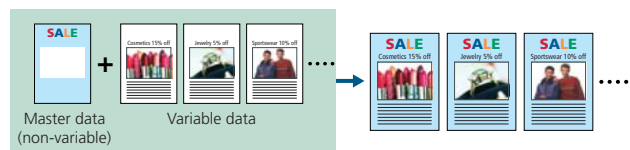

Fiery Options

EFI Impose™

EFI Impose is a powerful bundle of imposition tools that allow you to assemble and edit documents before processing or RIPping, regardless of the originating application or platform.



Graphic Arts Option**

Graphic Arts Option provides easy-to-use Fiery utilities including **Spot-On®** for accurate and consistent colour matching, **Hot Folders** to eliminate repetitive tasks for streamlined workflow, and **Auto Trapping** to avoid gaps between two neighbouring colours printed.

- **Secure Erase** deletes and overwrites all traces of job data from the hard disk, ensuring that all evidence of the job is removed.
- The core module of the **Velocity™** workflow software, **Velocity Balance™** provides centralised management of multiple printers and intelligent distribution of print jobs.
- **EFI Color Profiler™ Kit** ensures accurate and consistent colour across multiple printers and monitors.

** For PostScript only

COPYING



Speedy Copying and Quick First Copy Time

The MX-4501N/3500N has a quick first copy time of **6.9 seconds** in full colour and 4.1/4.7 seconds in B/W to save valuable time when performing multiple short-run jobs. And with a continuous copy rate of **35 cpm in full colour** and **45/35 cpm in B/W***, you can do more copy jobs in less time.

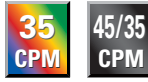

* A4 (8 1/2" x 11"), portrait

Productive Collated Output from Memory

The MX-4501N/3500N's Scan Once/Print Many function only requires a single scan of a multi-page original for copying. The machine then automatically outputs collated sets of copies in the proper page order without the aid of a sorter (**electronic sorting**). Each set is slightly shifted apart from the previous (offset stacking) for easy retrieval. Up to **999 copies** can be made directly from memory.



Automatic Document Feeding

The MX-4501N comes standard with a highly efficient **150-sheet DSPF** (duplex single pass feeder), which **scans both pages** of two-sided documents **up to A3** (11" x 17") in size in one pass. Doing away with the reversing circuit minimises paper misfeeds and vastly improves reliability. The MX-3500N is equipped with a **100-sheet RSPF** (reversing single pass feeder).



Built-in Stackless Duplex Module

The MX-4501N/3500N can make **two-sided copies** using its built-in stackless duplex module, effectively reducing paper costs as well as saving filing space. Duplex copying is even more effective when used together with the DSPF/RSPF.

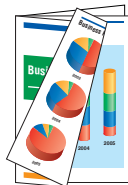

Enhanced Sharp Auto Colour Mode

Sharp Auto Colour Mode analyses the content of an original document and automatically recognises the type of original. It then selects the optimum copy mode to produce copies that are faithful to the original. The MX-4501N/3500N's Enhanced Sharp Auto Colour Mode advances this excellent function even further, making it possible to even clearly reproduce characters with colour or halftone dots in the background.

Enhanced Sharp Auto Colour Mode

Text comes out crisp and clear

Many
one of

Background colour remains intact

Job Build for Large-Volume Scanning

The MX-4501N/3500N easily handles large-volume copy jobs exceeding the DSPF/RSPF's 150/100-sheet*1 capacity. For example, a 270-sheet original can be scanned as batches of 150 + 120 (or 100 + 100 + 70) sheets and automatically stored on the MX-4501N/3500N's hard disk*2. Users can then print the entire document in a single run.

*1: A4 (8 1/2" x 11")

*2: The number of pages that can be stored for the Job Build function depends on the machine's HDD capacity and other conditions.

Auto Colour Selection

The MX-4501N/3500N automatically distinguishes whether the pages in a document are colour or B/W. Even if multi-page originals include a combination of colour and B/W pages, the MX-4501N/3500N selects the ideal mode for each page and outputs copies to match the original.

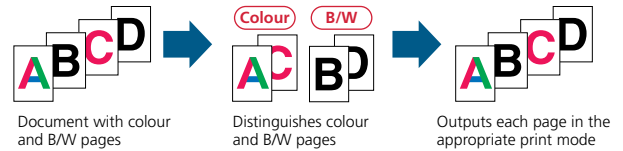

Image Editing Functions

The MX-4501N/3500N includes colourful editing functions made possible by digital technology.

- **Multi-Page Enlargement** divides an image onto separate sheets for making posters up to A0 x 2 (44" x 68") in size.
- **Image Repeat** places multiple copies of an image onto a single sheet.
- **Mirror Image** makes a reverse image of the original.
- **XY Zoom** adjusts the horizontal and vertical ratios independently.
- **B/W Reverse** reverses the black and white of an image. Please see specifications for a list of available functions.

Various Copy Applications

- **Book Copy** is convenient for compiling copies of a book or bound originals into pamphlet format.
- **Card Shot** enables one-touch copying of both sides of a card (credit cards, ID cards, etc.) onto a single page.
- **Colour Stamp** lets you choose from four categories: date, page number, text or stamps such as "URGENT." Each category can be assigned one colour from a choice of four colours.
- **Mixed Size Original Copy** mode automatically distinguishes documents of mixed sizes (such as A3/B4, B4/A4, etc.) fed through the DSPF/RSPF and chooses the appropriate paper. Note: Some restrictions apply when combining paper sizes of different format series.

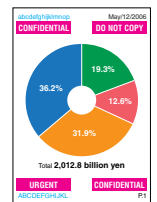

Other Key Features

- Automated job finishing, network tandem copying, proof copying
- Accepts paper sizes from A5R (5 1/2" x 8 1/2R") to A3 wide (12" x 18") and heavy paper up to 209 g/m²

IMAGE SENDING

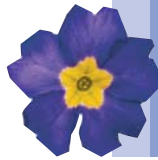

Multiple Distribution of Scanned Files



With the touch of a few buttons, you can choose different ways to distribute your scanned documents. **Scan to E-mail** sends documents as an e-mail attachment. **Scan to FTP Server** scans documents directly to an FTP server for storage. **Scan to Desktop** sends scanned documents directly to your PC desktop. **Scan to Network Folder** sends files to a shared folder on a networked Windows PC. **Scan to USB Memory** scans documents directly to USB memory devices. And **Scan to Internet Fax** enables you to send faxes via the Internet.

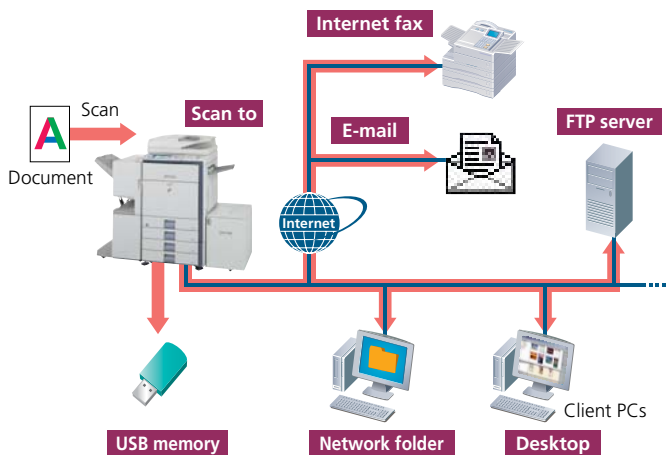

LDAP Support



Built-in LDAP (lightweight directory access protocol) support eliminates the need to enter or register full addresses. By entering the first few letters of the recipient's name, the MX-4501N/3500N displays a list of possible matches from your company's LDAP server. Selected addresses can be stored to the MX-4501N/3500N's address book.



A3 Colour Network Scanning



The MX-4501N/3500N works as a **full-colour network scanner** that can be used with any Windows PC on the network. Converting any type of paper-based document, up to A3 (11" x 17") in size, into an editable digital file is as easy as making a copy. Seamlessly integrating paper-based documents and digital files makes it easy to share data and improve workflow.

Efficient Duplex Scanning



With the MX-4501N's 150-sheet DSPF, you can scan both sides of a page at once. This speed and simplicity lets you quickly scan two-sided originals at amazing speed.

Easy Text Entry



Users can enter an e-mail subject title, file name or message directly from the MX-4501N/3500N's LCD control panel or preset frequently used subject titles and messages for easy one-touch entry. Plus, users can also register footers to send with e-mail.

TWAIN Support



With support for the TWAIN standard, the MX-4501N/3500N lets you import scanned images to a commercially available TWAIN-compliant application (pull scan).

Internet Fax and PC-Internet Fax



Save time and money by faxing over the Internet*. The **Internet Fax** function sends and receives faxes faster and at a lower cost than conventional phone line faxing, while the **PC-Internet Fax** function allows you to send a document created on your PC directly to a recipient's fax machine via the Internet while retaining original document quality.

* Requires optional MX-FWX1.

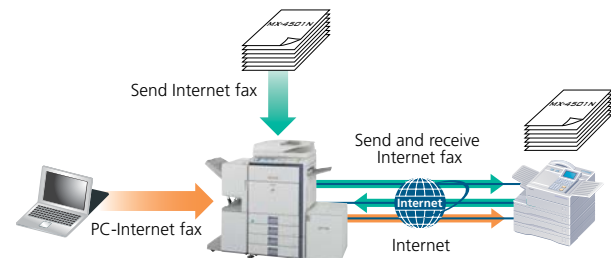

Other Key Features

- **One-touch auto dial keys** register up to **999** numbers for frequently used destinations
- **Inbound routing** lets you check incoming Internet faxes via e-mail before printing to avoid unnecessary output
- **Broadcast transmission** to up to 500 destinations
- **Programme keys** (up to 48 keys) are available to set up frequently used transmissions for instant recall
- **Mixed size original scanning** automatically distinguishes documents of mixed sizes fed through the DSPF/RSPF
- **Long originals** up to 800 mm can be sent using the DSPF/RSPF

Note: Internet faxing is available in B/W only.

DOCUMENT MANAGEMENT



Document Management on the Hard Disk

You can save processed job data in designated folders on the MX-4501N/3500N's built-in hard disk, making it easy to instantly recall saved documents or jobs for printing and sending at a later time. This contributes greatly to efficient sharing and distribution of information in your business operations.

Easy Access to Stored Files

Documents that are stored on the hard disk can be quickly searched and accessed from the control panel display or through a Web browser.

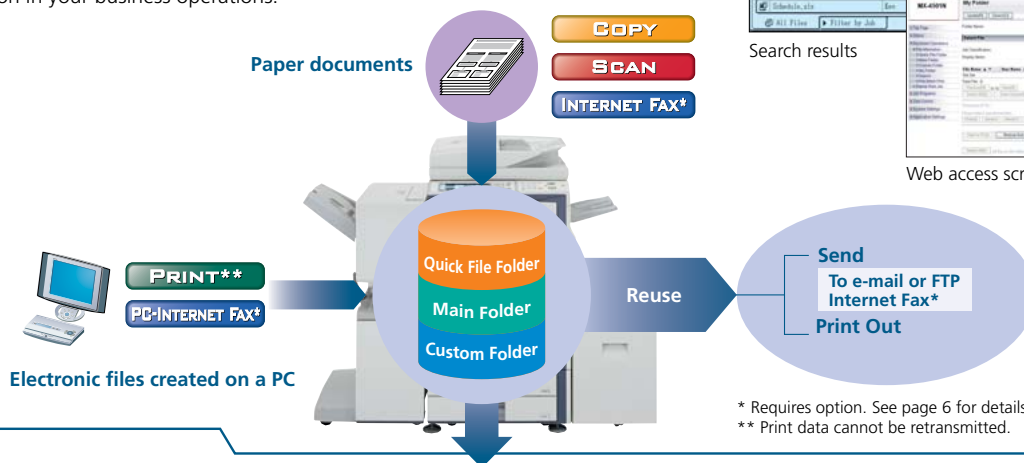

* Requires option. See page 6 for details.
** Print data cannot be retransmitted.

Quick Filing

Up to **1,400 pages** or 1,000 files*¹ that have been copied, printed, scanned or faxed (Internet fax/PC-Internet fax)*² can be stored by job on the hard disk in a Quick File Folder. You can reuse saved data with simple operation without having to reload or rescan the original.

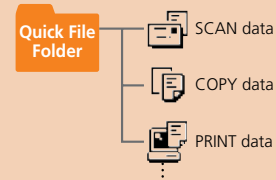

Advanced Filing Function

Up to **4,200 pages** or 3,000 files*¹ (1,400 pages or 1,000 files for the MX-3500N) that have been copied, printed, scanned or faxed (Internet fax/PC-Internet fax)*² can be stored by job on the hard disk in up to 500 folders with customised names and locations. Enhanced security features require users to enter a 5 to 8-digit password to access secure folders, protecting your sensitive data. Storage options include:

- **Main Folder** – You can store processed files by user name in the main public folder and share them across the workgroup. Any file name and a PIN code can be assigned to each saved job.
- **Custom Folder** – Up to 500 private folders (named as desired) can be created within the Custom Folder. When saving a file in a private folder, any file name can be assigned. A PIN code can be applied to both private folders and files.

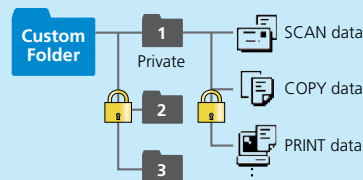
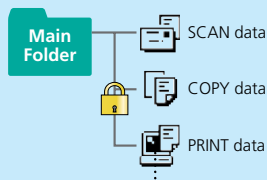

*1: Measured using Sharp's standard chart (A4 with 6% coverage, B/W). The Quick File Folder shares the HDD with the Job Build function; up to 10GB of data storage is available when using both functions. The storage capacity will be less for colour pages.

*2: For Internet fax/PC-Internet fax jobs, only transmitted data (not received faxes) can be saved in the Document Filing function.

Sharpdesk for Total Document Management

Sharpdesk is an original Sharp application that provides integrated desktop management of documents in over **200 file formats**, including scanned paper-based documents and those created with popular applications such as Word. It allows you to organise, edit, search and distribute your documents, all with simple drag-and-drop operation.

- Intuitive desktop display features **thumbnail** viewing
- Sharpdesk Imaging provides **annotation** tools for paper-free proofreading
- Sharpdesk **Composer** combines different types of files into a single document
- **Optical character recognition** converts documents into editable text files
- **Output zone** distributes files to e-mail, printers and other applications
- **File search** allows searching by file name, keyword or thumbnail

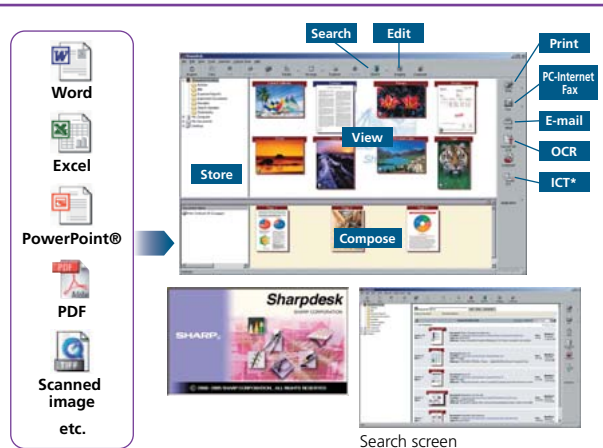

* Image Compression Tool for converting images into high-compression PDF files.

SECURITY



Industry-Leading Multi-Layered Security

With multiple levels of network and data security to cover a wide range of security needs, Sharp offers award winning security solutions to help protect your business assets and bring peace of mind. The MX-4501N/3500N safeguards sensitive data with powerful, enhanced security functions that eliminate the worry of unauthorised use and guarantee greater protection for your confidential information.

Data Security Kit

Digital copier/printers or multifunction products can retain hundreds of pages of confidential information from previous jobs on their hard disks or internal memory. To safeguard this information from unauthorised access, the optional **Data Security Kit** automatically **encrypts and erases** the data after each job is complete as well as data stored both on the hard disk and in the address book.

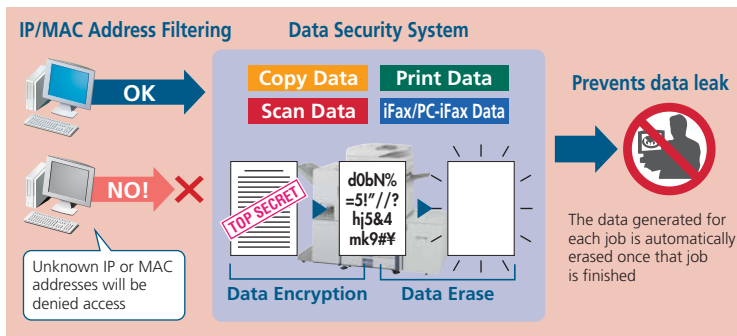

IP/MAC Address Filtering

The embedded Network Interface provides highly secure operation by restricting access to the MX-4501N/3500N on your office network. Only PCs that have either their **IP address** or **MAC (media access control) address** registered are allowed to use the MX-4501N/3500N. Attempted access from an unknown IP or MAC address will be denied, preventing unauthorised use.

Encrypted PDF with Password Protection

To prevent unauthorised viewing of confidential image data, the MX-4501N/3500N enables users to password protect and encrypt PDF data. By setting a password when scanning, users can transmit a PDF over the network in encrypted format. Then, after transmission, viewers will only gain access to the encrypted PDF after successfully re-entering the chosen password.

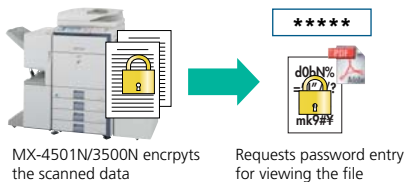

Print Hold and Confidential Print

To keep others from seeing confidential documents as they are being printed out, the MX-4501N/3500N's **Print Hold** function stores print data on its hard disk and withholds output until the user executes a print command from the control panel. For added security, the **Confidential Print** function requires the user to enter in a PIN (personal identification number) at the machine before printing can begin.

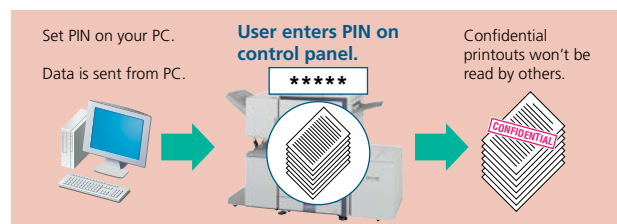

Document Control Function

Document Control prevents unauthorised copying, scanning and filing of confidential documents. This is how it works: the MX-4501N/3500N embeds copy prevention data onto a document when it is first copied or printed. It will then detect this data, for example, the next time someone tries to make a copy of the document. Any unauthorised attempts to copy a Document Controlled-document will simply be cancelled or result in the output of a blank page.

Note: Requires optional Data Security Kit. May not work for certain types of documents and paper.

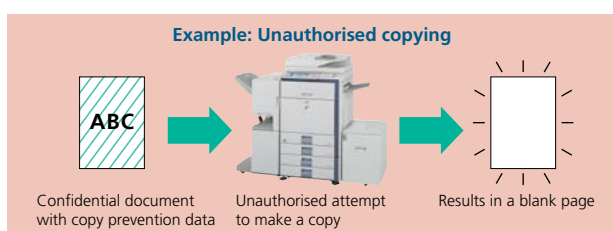

Secure Socket Layer

A newly introduced SSL (Secure Socket Layer) enables the encryption of data communications to prevent data leakage through the network when printing via IPP or browsing secure Web pages (HTTPS).

User Authentication

The MX-4501N/3500N prevents unauthorised operation, including use of the LDAP function, by requiring **passwords** for machine access. The MX-4501N/3500N can also register up to 1,000 users in **three access levels** as Administrator, User and Guest.



User authentication

ENVIRONMENT & USER-FRIENDLY



Environmentally Advanced

Environmentally Conscious Supplies

Integrating Sharp's newly developed, environmentally advanced supplies, the MX-4501N/3500N takes ecological performance to a whole new level. The revolutionary Mycrostoner offers a significantly **lower consumption rate** than conventional toners in a smaller cartridge that uses less packaging materials, while the **longer-life photoconductor** delivers higher performance than previous models. Combining earth-friendly features with an ecologically sound design, the MX-4501N/3500N minimises burden on the environment while lowering consumption and costs.



Compact Size

The 4-in-1 multifunction MX-4501N/3500N helps you optimise office space thanks to its size, which is among the most compact in its class, and fits nicely in almost any office.

Easy Operation

User-Friendly Operation Panel

The MX-4501N/3500N's control panel features a wide, clear **8.9-inch touch-screen LCD** with easy-to-follow guidance that takes users step-by-step through the necessary procedures. Based on the concept of universal design, the MX-4501N/3500N is easy to use for everyone, including beginners or the physically challenged. Features include easy-to-press indented keys and adjustable notification sounds for settings like zoom and exposure.

Customisable Keys on the LCD Control Panel

Working with the user authentication function, the MX-4501N/3500N enables both users and administrators to register up to **1,000 user-specific** default settings on the LCD control panel and customise **short-cut keys** in the lower right corner of the default screen for each mode.

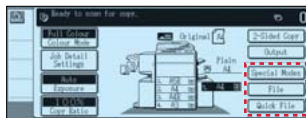

Job Status Screen

Whether printing or copying, the control panel displays a list of all jobs, showing you at a glance the jobs in progress and the position of your job in the queue.

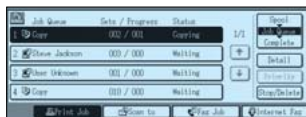

Printer Status Monitor

If the MX-4501N/3500N is low on paper or toner, the **Printer Status Monitor** will alert you in the form of easy-to-understand graphics, allowing you to avoid problems before they arise.

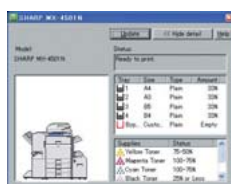

Printer Status Monitor

Environmentally Conscious Design

- With a standby power consumption of less than 12W in network standby, the MX-4501N/3500N leads the industry in energy savings for colour multifunction machines.
- Conforming to the **Energy Star** programme, an international system identifying energy-efficient products, the MX-4501N/3500N has two levels of **energy-saving modes** to reduce or shut off electricity after a period of inactivity. And to further cut back on running costs, by pressing the **manual energy save key** after a job is finished, the MX-4501N/3500N immediately enters auto power shut-off mode.
- In **support of the RoHS directive**, which restricts the use of hazardous substances, Sharp has fully eliminated harmful lead and chromium in all MX-4501N/3500N parts and materials.



Integrated Web-Based Device Management

- Administrators can set up many features from either over the network or from the control panel of the MX-4501N/3500N, including address book control, document filing management, user control (accounting) and e-mail alert and status settings.
- **Printer Administration Utility** makes printer networks easier to manage by allowing network administrators to customise monitored items and view settings such as the IP address directly from their PC through a standard Web browser.



Web-based device management

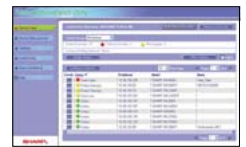

Web-based PAU 4.0

Device Cloning

Machine settings can be copied conveniently to another MX-4501N/3500N via a Web browser, making it easy to clone machines in a networked environment.

Sharp OSA (Open Systems Architecture)

The MX-4501N/3500N features the innovative Sharp OSA* that allows third-party software developers to create custom applications. Sharp OSA gives you direct access to business applications and/or external account software right from the LCD, offering a new realm of control and convenience.

* Requires optional MX-AMX2 and/or MX-AMX3



OPTIONS



System Configuration

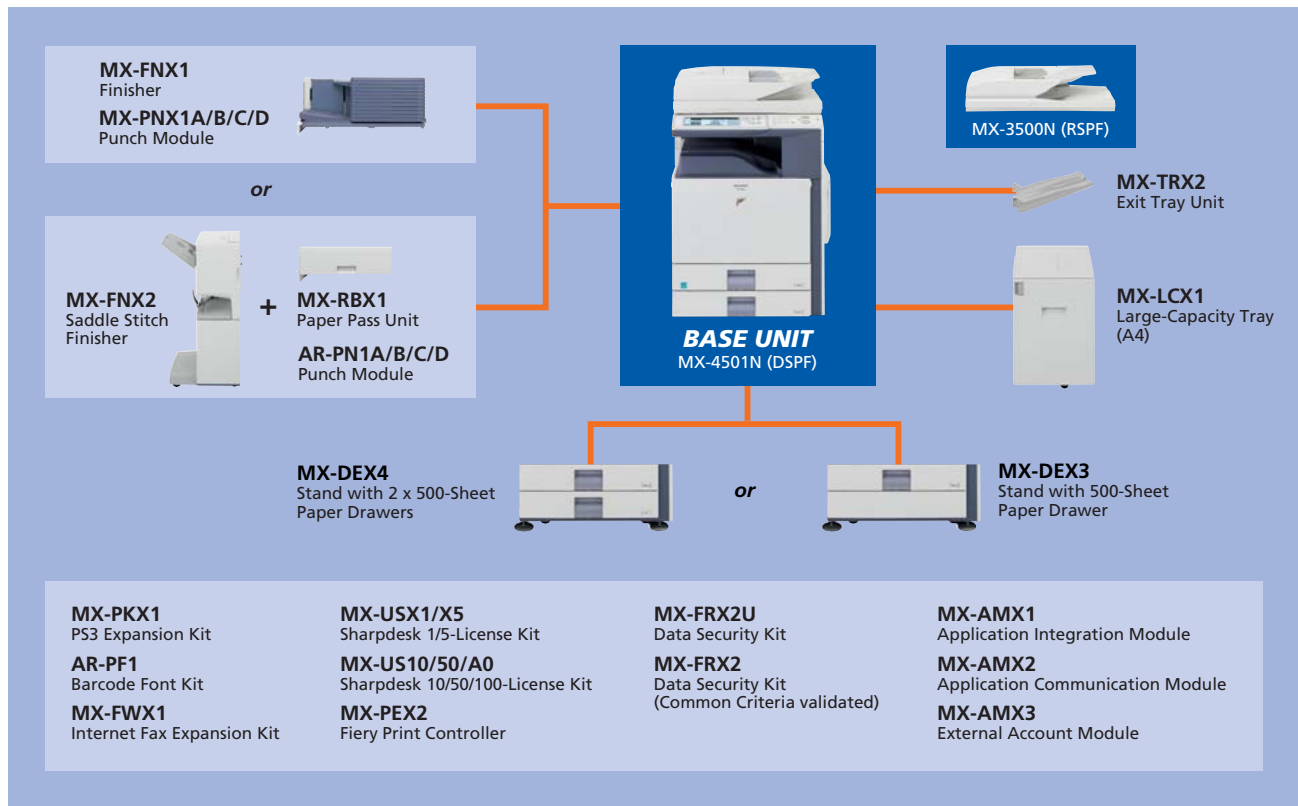

The MX-FRX2 and MX-AMX2/3 cannot be attached at the same time. Some options may not be available in some areas.

Specifications for Options

MX-FNX1 Finisher

Paper size	Non offset Offset/staple	A3W to A5R* (12" x 18" to 5 1/2" x 8 1/2R") A3 to B5 (11" x 17" to 8 1/2" x 11R")
Paper capacity (max.)		500 sheets (A4 or smaller), 250 sheets (B4 or larger)
Stapling capacity		50 sheets (A4 or smaller), 30 sheets (B4 or larger)
Staple position		3 locations (front, rear or both)

MX-FNX2 Saddle Stitch Finisher

Paper size	Non offset Offset/staple	A3W to A5R* (12" x 18" to 5 1/2" x 8 1/2R") A3 to B5R (11" x 17" to 8 1/2" x 11R")
Paper capacity (max.)	Offset tray	1,000 sheets (A4 or smaller, except A5R), 500 sheets (A5R, B4 or larger)
	Saddle stitch tray	10 sets of 6-10 sheets, 20 sets of 1-5 sheets
Stapling capacity		30 sheets (A4 or smaller), 25 sheets (B4 or larger)
Staple position		3 locations (front, rear or both)

* Except A5 size

Punch Modules

Model name	For the MX-FNX1	MX-PNX1A	MX-PNX1B	MX-PNX1C	MX-PNX1D
	For the MX-FNX2	AR-PN1A	AR-PN1B	AR-PN1C	AR-PN1D
Number of holes		2	3	4	4 (wide)
Paper weight		55 to 209 g/m ²			

MX-DEX3 Stand with 500-Sheet Paper Drawer

Paper size	A3 to B5R (11" x 17" to 7 1/4" x 10 1/2R")
Paper capacity	500 sheets (80 g/m ²)

MX-DEX4 Stand with 2 x 500-Sheet Paper Drawers

Paper size (upper and lower tray)	A3 to B5R (11" x 17" to 7 1/4" x 10 1/2R")
Paper capacity (upper and lower tray)	500 sheets each (80 g/m ²)

MX-LCX1 Large-Capacity Tray

Paper size	A4, B5 (8 1/2" x 11")
Paper capacity	3,500 sheets (80 g/m ²)

Sharpdesk 3.2 System Requirements

CPU and memory	Depend on operating system used
Hard disk	300MB or more available space (including sample image files and help files)
Monitor	SVGA resolution or better and capable of displaying more than 256 colours (True Color recommended)
Supported OS	Windows® 98 Second Edition, Windows® Me, Windows® 2000 Professional, Windows® XP Professional, Windows® XP Home Edition, Windows Vista™*
Network protocols	TCP/IP (using Network Scanner Tool)

* Windows Vista 64 bit is supported as 32-bit compatible mode. Sharpdesk Composer does not support Windows Vista 64 bit.

SPECIFICATIONS (tentative)

General	
Type	Desktop
Engine speed*1	[MX-4501N] Colour: max. 35 cpm/ppm, B/W: max. 45 cpm/ppm [MX-3500N] Colour: max. 35 cpm/ppm, B/W: max. 35 cpm/ppm
Paper size	Max. A3 wide (12" x 18"), min. A5R (5 1/2" x 8 1/2R")
Paper capacity	Standard: 1,100 sheets (two 500-sheet trays and 100-sheet multi-bypass tray), maximum: 5,600 sheets
Warm-up time	Less than 240 sec.
Memory	Copier memory: Standard 768MB Printer memory: Standard 640MB [MX-4501N] 80GB HDD*2 [MX-3500N] 40GB HDD*2
Power requirements	Rated local AC voltage ±10%, 50/60 Hz
Power consumption (max.)	1.84 kW (200 to 240V), 1.44 kW (100 to 127V)
Dimensions (W x D x H)	[MX-4501N] 645 x 670 x 960 mm (25 25/64" x 26 3/8" x 37 51/64") [MX-3500N] 645 x 670 x 950 mm (25 25/64" x 26 3/8" x 37 13/32")
Weight	[MX-4501N] Approx. 123 kg (271 lbs.) [MX-3500N] Approx. 114 kg (251 lbs.)
Features	Card shot, edge/centre erase, job build, pre-heat/auto power shut-off modes, user authentication (1,000 accounts)

Copier	
Original paper size	Max. A3 (11" x 17")
First copy time*3	Full colour: 6.9 sec., B/W: 4.1/4.7 sec.
Continuous copy	Max. 999 copies
Resolution	Scan: 600 x 600 dpi, 600 x 300 dpi Print: 600 x 600 dpi
Gradation	Equivalent to 256 levels
Zoom range	25 to 400% (25 to 200% using DSPF/RSPF) in 1% increments
Preset copy ratios	Metric: 10 ratios (5R/5E), inch: 8 ratios (4R/4E)
Features*4	Auto paper selection (mixed/random size feeding), auto magnification selection, paper type selection, auto tray switching, rotation copy, electronic sorting, network tandem copy, book copy, margin shift, dual page copy, multi-shot (4-in-1, 2-in-1), cover/transparency/tab page insertion, pamphlet copy, 2-sided copy orientation change, XY zoom, B/W reverse, mirror image, duplex copy, toner save mode, reserved copy, job programme, image repeat, irregular original/paper size input, stamps (date, page number, text, stamp), multi-page enlargement, tab copy, centering, proof copy, document control, auto colour selection, enhanced Sharp auto colour mode, auto calibration

Document Filing	
Document filing capacity	[MX-4501N] Main and custom folders: 30GB, 4200 pages*5 or 3000 files [MX-3500N] Main and custom folders: 10GB, 1400 pages*5 or 1000 files
Stored jobs	Quick file folder: 10GB, 1400 pages*5 or 1000 files
Storage folders	Copy, print, scan
Confidential storage	Quick file folder, main folder, custom folder (max. 500 folders) Password protection

- * 1 : Copy mode: When copying same document continuously on portrait A4 (8 1/2" x 11") plain paper in non-offset mode. Print mode: When printing same document continuously on portrait A4 (8 1/2" x 11") plain paper in non-offset mode, excluding processing time.
- * 2 : 1GB = One billion bytes when referring to hard drive capacity. Actual formatted capacity is less.
- * 3 : Portrait feeding of A4 (8 1/2" x 11") sheets from 1st paper tray, using document glass, without Auto Colour Selection and Auto Colour mode, polygon in rotation.
- * 4 : Some features require option(s).
- * 5 : Measured using Sharp's standard chart (A4 with 6% coverage, B/W). The Quick File Folder shares the HDD with the Job Build function; up to 10GB of data storage is available when using both functions. The storage capacity will be less for colour pages.
- * 6 : Optional MX-FWX1 required.
- * 7 : Optional MX-PKX1 required for Mac OS and EtherTalk.
- * 8 : Optional MX-PKX1 required.
- * 9 : Some features are not available according to the printer driver used.

- Design and specifications are subject to change without prior notice.
- Windows, Windows Server, and Windows Vista are either registered trademarks or trademarks of Microsoft Corporation in the United States and/or other countries. All other brand names and product names may be trademarks or registered trademarks of their respective owners.
- The Energy Star logo is a certification mark and may only be used to certify products that have been determined to meet the Energy Star programme requirements. Energy Star is a US registered mark. The Energy Star guidelines apply to products only in the US, Europe, Australia, New Zealand and Japan.

Network Scanner	
Scan method	Push scan (via operation panel), pull scan (with TWAIN-supporting application)
Resolution	Push scan: 100, 200, 300, 400, 600 dpi Pull scan: 75, 100, 150, 200, 300, 400, 600 dpi 50 to 9600 dpi
File formats	TIFF, PDF, encrypted PDF, JPEG (colour only)
Scanner utilities	Sharpdesk
Scan destinations	Scan to e-mail, desktop, FTP server, network folder, USB memory
Features	Internet fax*6, PC-Internet fax transmission*6, enhanced Sharp auto colour mode, mixed size original scanning, LDAP support, direct entry (address, subject, message), 999 one-touch dials, 500 group dials, 48 job programmes, broadcasting, long original scanning (max. 800 mm), auto colour selection

Network Printer	
Resolution	600 x 600 dpi
Enhanced resolution	600 x 1200 dpi for B/W printing with PS Expansion Kit
Interface	USB 1.1 (Windows® 98/Me/2000/XP, Windows Server™ 2003) USB 2.0 high-speed (Windows® 2000/XP) 10Base-T/100Base-TX
Supported OS*7	Windows NT® 4.0 SP5 or later, Windows Server® 2003, Windows® 98/Me/2000/XP, Windows Vista™, Mac OS 9.0 to 9.2.2, Mac OS X 10.1.5, 10.2.8, 10.3.3 to 10.3.9, 10.4
Network protocols*7	TCP/IP, IPX/SPX (NetWare), NetBEUI, EtherTalk (AppleTalk)
Printing protocols	LPR, Raw TCP (port 9100), POP3 (e-mail printing), HTTP, Novell Printserver application with NDS and Bindery, FTP for downloading print files, EtherTalk printing, IPP
PDL emulation	Standard: PCL 6/5c Option*8: PS3 emulation
Available fonts	80 fonts for PCL, 136 fonts for PS3 emulation*8
Features*4 *9	Network tandem print, RIP Once/Print Many, job retention (print hold, proof print, confidential print), direct PDF/TIFF/JPEG printing, carbon copy print, duplex print, printer administration utility and status monitor, IP/MAC address filtering and port/protocol management, font and form download, pamphlet style, binding edge, N-up (2/4/6/8/9/16), paper/output tray selection, cover insertion, transparency interleave, fit to page, watermarks, offset output, form overlay, auto configuration, barcode font compatibility, tab print, poster print

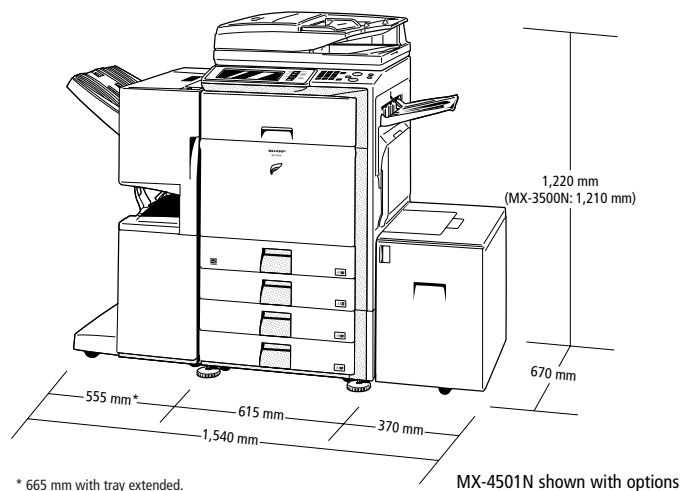

SHARP

Distributed by:

