

< Appendix >

Table of contents

1. Abstract

1.1. Features.	Attachment-3
1.2. I ² C bus interface.	Attachment-4
1.2.1. Write Format.	Attachment-4
1.2.2. Read Format.	Attachment-4
1.2.3. Others and Notes.	Attachment-4

2. Description of functions

2.1. Ambient light sensor (ALS) mode.	Attachment-5
2.2. Proximity sensor (PS) mode.	Attachment-5
2.3. Software-shutdown mode.	Attachment-5
2.4. Hardware-shutdown.	Attachment-5
2.5. Auto-shutdown/Continuous operation.	Attachment-5
2.6. Operating mode selection.	Attachment-5
2.7. Number of measurement cycles (Persistence).	Attachment-5
2.8. Resolution/Measuring time.	Attachment-5
2.9. Maximum measurable range.	Attachment-5
2.10. Intermittent operating function.	Attachment-5
2.11. LED drive peak current setting.	Attachment-5
2.12. INT terminal output type setting.	Attachment-5
2.13. LED modulation frequency(duty) setting.	Attachment-6
2.14. Software reset.	Attachment-6
2.15. Interrupt function :ALS mode.	Attachment-6
2.16. Interrupt function :PS mode.	Attachment-6

3. Basic operation

3.1. Ambient light sensor mode (ALS).	Attachment-7
3.2. Proximity sensor mode (PS).	Attachment-7
3.3. PS and ALS alternating mode (PS&ALS).	Attachment-7
3.4. Count value checking mode (debug mode for PS).	Attachment-8

4. Register Mapping

4.1. Register Mapping.	Attachment-9
4.2. Precautions for Register setting.	Attachment-9
4.3. Register Functions.	Attachment-9
4.4. Register settings for Basic operation.	Attachment-10
4.4.1. Software-shutdown :OP[3].	Attachment-10
4.4.2. Auto-shutdown/Continuous operation :OP[2].	Attachment-10
4.4.3. Operating mode selection :OP [1:0].	Attachment-10
4.4.4. Number of measurement cycles setting :PRST[1:0].	Attachment-10
4.4.5. Interrupt type setting :INTTYPE.	Attachment-11
4.4.6. Intermittent operating function :INTVAL[1:0].	Attachment-11
4.4.7. INT terminal setting :PIN[1:0].	Attachment-12
4.4.8. Software reset :RST.	Attachment-12

5. Register settings for PS

5.1. Output value of sensing result for detection/non-detection	:PROX.	Attachment-13
5.2. Output value of PS interrupt result	:FLAG_P.	Attachment-13
5.3. Resolution/Measuring duration setting for PS mode	:RES_P [2:0].	Attachment-13
5.4. Maximum measurable range	:RANGE_P[2:0].	Attachment-13
5.5. LED drive peak current setting	:IS [1:0].	Attachment-14
5.6. LED modulation frequency(duty) setting	:FREQ.	Attachment-14
5.7. Proximity low threshold (Loff)	:PL[15:0].	Attachment-14
5.8. Proximity high threshold (Lon)	:PH[15:0].	Attachment-14
5.9. PS Detection result	:D2[15:0].	Attachment-14

6. Register settings for ALS

6.1. Output value of ALS interrupt result	:FLAG_A.	Attachment-15
6.2. Resolution/Measuring duration setting for ALS mode	:RES_A [2:0].	Attachment-15
6.3. Maximum measurable range for ALS mode	:RANGE_A[2:0].	Attachment-15
6.4. ALS interrupt low threshold	:TL[15:0].	Attachment-15
6.5. ALS interrupt high threshold	:TH[15:0].	Attachment-15
6.6. ALS Detection result	:D0[15:0],D1[15:0].	Attachment-16

7. INT terminal output mode

7.1. Detection result output mode for PS.	Attachment-17
7.2. Interrupt output mode.	Attachment-17

8. Average consumption current in operation

8.1. Average consumption current in operation.	Attachment-18
8.2. Average consumption current at ambient light sensor (ALS) mode.	Attachment-18
8.3. Average consumption current at proximity sensor (PS) mode.	Attachment-18

9. Countermeasure against external light noise in PS mode

9.1. Countermeasure against external light noise in PS mode.	Attachment-19
---	---------------

10. Recommended operating mode/Procedure of register setting

10.1. Shutdown mode.	Attachment-19
---------------------------	---------------

11. Sample programs

11.1. Sample program of function.	Attachment-20
11.2. Sample program for PS and ALS alternating mode.	Attachment-21
11.3. Sample program for ALS mode.	Attachment-23

12. Recommended Window Size (Reference)

12.1. Without light shield.	Attachment-25
12.2. With light shield.	Attachment-26

13. Data (Reference)

13.1. LED drive peak current.	Attachment-27
13.1.1. LED drive peak current vs. VLED (Vcc=VLED).	Attachment-27
13.1.2. LED drive peak current vs. Vcc (VLED=3V).	Attachment-27
13.2. Spectral Responsivity.	Attachment-28
13.3. Proximity sensor (PS) mode.	Attachment-28

1. Abstract

GP2AP030A00F is ambient light sensor and proximity sensor with function ambient light sensing and proximity sensing by setting register.

Proximity sensor (PS) mode: Judgment result of object existence can be referred by reading register value(16bit) via I²C bus interface. INT terminal can be changed either interrupt output or sensing result output (detection/non-detection status) by setting register in PS mode.

Ambient light sensor (ALS) mode: Detection result of ambient light can be referred by reading register value(16bit) via I²C bus interface. INT terminal can be changed interrupt output by setting register in PS mode.

This product is possible to operate both PS and ALS modes alternately.

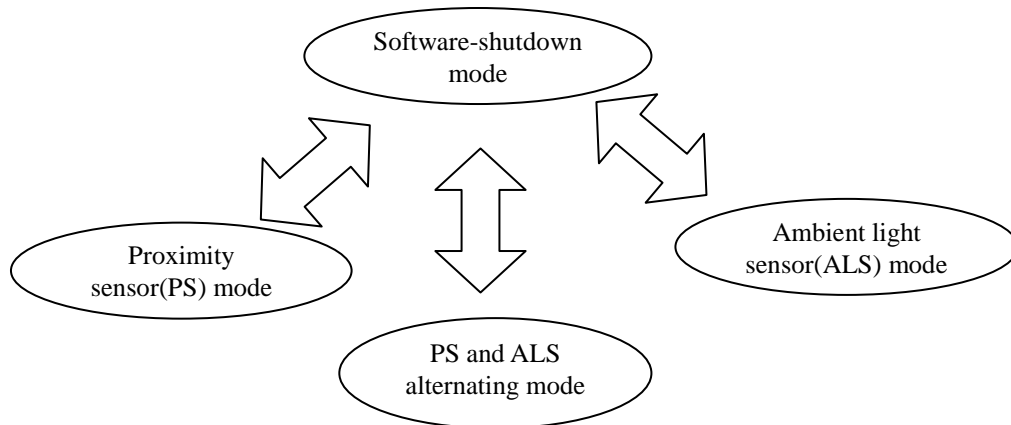

Fig.1 Operating mode of GP2AP030A00F(PS and ALS sensor)

1.1. Features

• Design

This product is composed of following two chips in one package, which is IC with a built-in photodiode (PD) (Clear (visible and infrared) photodiode and Infrared photodiode) for ambient light sensors and proximity sensors, and infrared LED.

Achieving Small all-in-one package by Doubly-integrally-molded, transparent resin and light shield resin.

Spectral sensitivity(ALS) of the human eye without infrared light effects can be obtain by deducting Infrared Photodiode from Clear photodiode.

• I²C bus interface

This product has 7bit slave address adherence to I²C bus interface and can change register value for each function via I²C bus.

• INT terminal setting

INT terminal can be changed either interrupt output or sensing result output (detection/non-detection status) by setting register in PS mode. ALS mode has only interrupt output setting.

• Power save mode

Software-shutdown /Hardware-shutdown

• Slave address

Enable to set 2 settings by ADDR terminal setting.

1.2. I²C bus interface

This product has 7bit slave address adherence to I²C bus interface and can change register value for each function via I²C bus. Besides, illuminance detection result and judgment result for detection/non-detection status can be read via I²C bus.

Table 1 Terminals for I2C bus interface are as follows.

Pin Name	Description
SCL	I ² C Clock
SDA	I ² C Data bus

Basic data format are as follows.

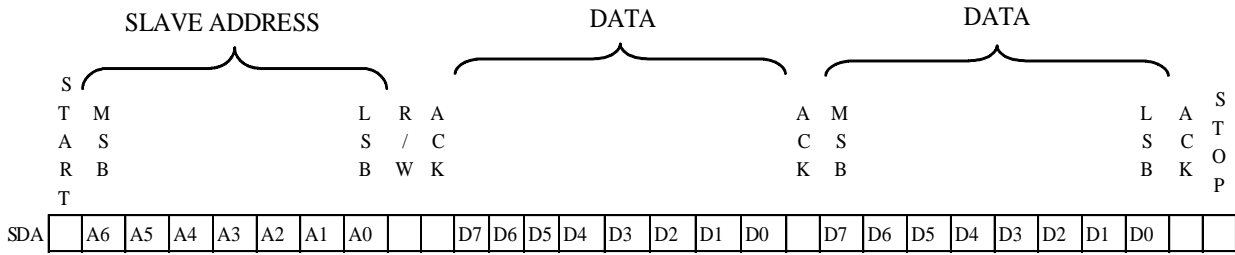

Fig.2 I²C Basic data format

DATA: Data which write into internal register/read from internal register.
 SLAVE ADDRESS : Enable to set 2settings by ADDR terminal setting.

Table 2 I²C slave address

ADDR terminal setting	A6	A5	A4	A3	A2	A1	A0	R/W
Lo LEVEL/OPEN	0	1	1	1	0	0	1	X
Hi LEVEL	1	0	0	0	1	0	0	X

R/W : Read:X=1, Write:X=0

1.2.1. Write Format

Write value in register and enable to write the next address sequentially after writing data. Data writing will be end with inputting stop-condition.

WordAddress:00H PROX, FLAG_P and FLAG_A register in 00H are read only.

WordAddress:0CH~11H D0[15:0], D1[15:0] and D2[15:0] registers from 0CH to 11H are read only.

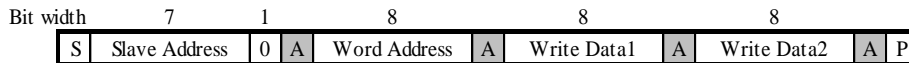

A: ACK,NA: NACK, S: START, P: STOP, X: don't care

□: Master output ■: Slave output

Fig.3 I²C write format

1.2.2. Read Format

Enable to read data in register. Following address can be read sequentially by inputting ACK after reading data.

Reading data will be stopped by inputting NACK.

Stop-condition after setting Word address can be deleted since it corresponds to repeat-start-condition. Reading read data is done by not opening I²C bus interface.

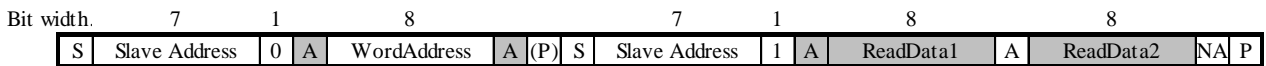

A: ACK, NA: NACK, S: START, P: STOP, X: don't care

□: Master output ■: Slave output

Fig.4 I²C read format

1.2.3. Others and Notes

This product doesn't support Clock-stretch function and General-call-address function.

2. Description of functions

2.1. Ambient light sensor (ALS) mode

Ambient light sensing results can be read at D0[15:0] and D1[15:0] register through I²C bus interface.

The device outputs raw data of CLEAR photodiode sensitive to both visible and infrared spectrum and IR photodiode sensitive to only infrared spectrum during ambient light sensing. It is necessary for device host (user side) to get illuminance value with calculation of both CLEAR data at D0[15:0] and IR data at D1[15:0].

The device outputs interrupt signal to INT terminal in case that D0[15:0] exceed/fall below judgment threshold level(TH[15:0]/TL[15:0]) set before sensing operation.

2.2. Proximity sensor (PS) mode

Proximity sensing results can be read at D2[15:0] register through I²C bus interface.

The device outputs interrupt signal or detection/non-detection status on INT terminal in which case D2[15:0] exceed/fall below judgment threshold level(PH[15:0]/PL[15:0]) set before sensing operation.

2.3. Software-shutdown mode

This product has shutdown function by which all circuits except I²C go into shutdown mode and cease to draw supply current. In this case, I²C communication is available. Current consumption (I_{dd-s}) in shutdown mode is less than 5uA when I²C bus interface is not used.

2.4. Hardware-shutdown

All the circuits can be completely stopped by stopping the power supply to the terminal Vcc, and the current consumption can completely be cut.

2.5. Auto-shutdown/ Continuous operating function

Select continuous operation or auto-shutdown after one time operation by setting OP[2] register.

2.6. Operating mode selection

Operating modes are decided by setting OP[1:0] registers. Please select either mode, PS&ALS alternating mode, ALS only mode or PS only mode. In addition to these modes, you can set counts value checking mode (debug mode for PS) to confirm the reflection counts from the panel when your product is developed.

2.7. Number of measurement cycles(Persistence)

Select number of measurement cycles by setting PRST[1:0] register(1time, 4times, 8times, and 16times). Sensor outputs interrupt signal or judgment result of detection/non-detection state by detecting threshold setting cycles continuously. This function helps to decrease malfunction by noise such as flash of camera.

2.8. Resolution/Measuring time

ALS mode : Resolution and measuring time can be changed by setting RES_A[2:0] register.

PS mode : Resolution and measuring time can be changed by setting RES_P[2:0] register.

2.9. Maximum measurable range

ALS mode : Maximum measurable range can be changed by setting RANGE_A[2:0] register.

PS mode : Maximum measurable range can be changed by setting RANGE_P[2:0] register.

2.10. Intermittent operating function

This function is to reduce average consumption current by stopping part of circuit intermittently, and this is different from software shutdown function. Intermittent operating duration can be changed by setting INTVAL[1:0] register.

Setting a longer intermittent operating duration makes LED average consumption current lower. However, update period of the detection result becomes long. It will make response time of detecting longer.

2.11. LED drive peak current setting

Change drive peak current by setting IS[1:0] register. (LED drive peak current is 16.3mA, 32.5mA, 65mA and 130mA)

2.12. INT terminal output type setting

INT terminal can be changed either interrupt output or sensing result output (detection/non-detection status) by setting PIN[1:0] register in PS mode. ALS mode has only interrupt output setting.

2.13. LED modulation frequency (duty) setting

LED modulation frequency setting can be changed by setting **FREQ** register.
(Freq:327.5kHz, 81.8kHz at pulse width:1.5usec only)
Setting a lower modulation frequency makes LED average consumption current lower.

2.14. Software reset

All registers can be initialized by writing 1 to **RST** register.
RST register value also becomes 0 automatically which is initial value.

2.15. Interrupt function :ALS mode

Interrupt function becomes available by setting **TH[15:0]** register and **TL[15:0]** register in ALS mode.
Interrupt signal is outputted to **INT** terminal in case that detection result (**D0[15:0]** value) is less than **TL[15:0]** setting value or more than **TH[15:0]** value.

2.16. Interrupt function :PS mode

Interrupt function becomes available by setting **PH[15:0]** register and **PL[15:0]** register in PS mode.
Interrupt signal or detecting/non-detecting judgment result is outputted to **INT** terminal in case that detection result (**D2[15:0]** value) is less than **PL[15:0]** setting value or more than **PH[15:0]** value.
Enable to change desirable threshold in detecting distance and hysteresis by setting **PH[15:0]** and **PL[15:0]** registers.
However, detecting distance depends on LED output power as well. It can be changed by setting **IS[1:0]** register.

3. Basic operation

3.1. Ambient light sensor (ALS) mode

There are 2 photodiodes, CLEAR(sensitive to visible and infrared spectrum) and IR photodiodes (sensitive to only infrared spectrum) in this sensor. Illuminance value can be obtained by calculation from CLEAR and IR data. The device continues to execute integration operation until set measuring time(100msec, recommended) passes, and then outputs the results of CLEAR photodiode at D0[15:0] register and IR photodiode at D1[15:0] register. Illuminance value can be obtained by some calculation using D0[15:0] and D1[15:0].

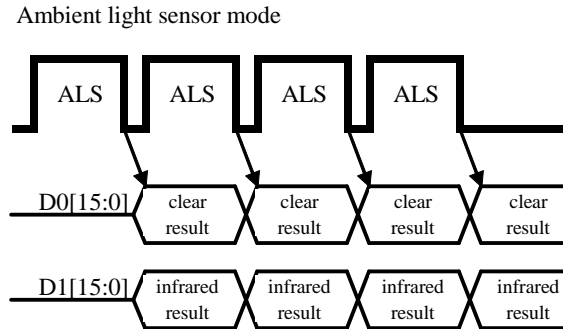

Fig.5 Output results for ALS mode

3.2. Proximity sensor mode (PS)

In PS mode, the device can detect proximity objects by which integrates incident light in IR(infrared) photodiode during the time without emission of LED (LED off) and the time with emission of LED (LED on) in order to eliminate the influence of ambient light.

In PS mode, the way of detection is as follows;

- [1]Obtain detection result1 at LED off which integrates incident light amount in PD for PS during a set period (recommended value: 1.56ms). (Detection result1 is not outputted to register).
- [2]Obtain detection result2 at LED on which integrates incident light amount in PD for PS during a set period (recommended value: 1.56ms). (Detection result2 is not outputted to register).
- [3]Then, obtain detection result3 by subtracting Detection result2 and result1. So this value has external light cancellation. By using this value, proximity sensing judgment is done if reflective object is there or not.

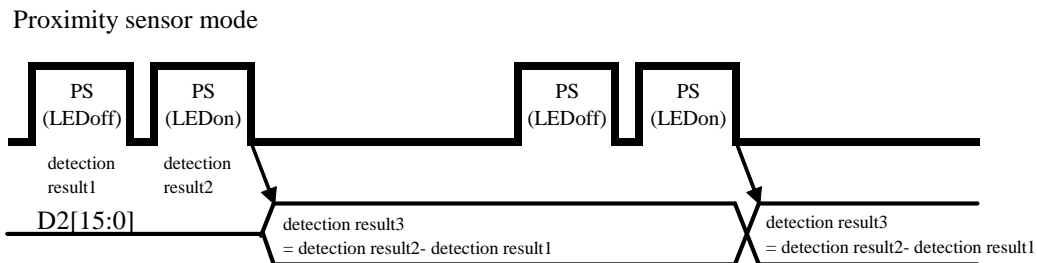

Fig.6 Output results for PS mode

3.3. PS and ALS alternating mode (PS&ALS)

This product is possible to operate both PS and ALS modes alternately.

In PS and ALS alternating mode, the way of detection is as follows;

- [1]Obtain detection result1 at LED off which integrates incident light amount in PD for PS during a set period (recommended value: 1.56ms). (Detection result1 is not outputted to register).
- [2]Obtain detection result2 at LED on which integrates incident light amount in PD for PS during a set period (recommended value: 1.56ms). (Detection result2 is not outputted to register).
- [3]Then, obtain detection result3 by subtracting Detection result2 and result1. So this value has external light cancellation. By using this value, proximity sensing judgment is done if reflective object is there or not.
- [4]The device integrates incident light in CLEAR photodiode and IR photodiode during a set period (recommended value: 25msec), and then outputs the detection results to D0[15:0] and D1[15:0] respectively.

The raw integrated data of CLEAR photodiode and IR photodiode can be obtained in D0[15:0] and D1[15:0] respectively.

ALS and PS mode

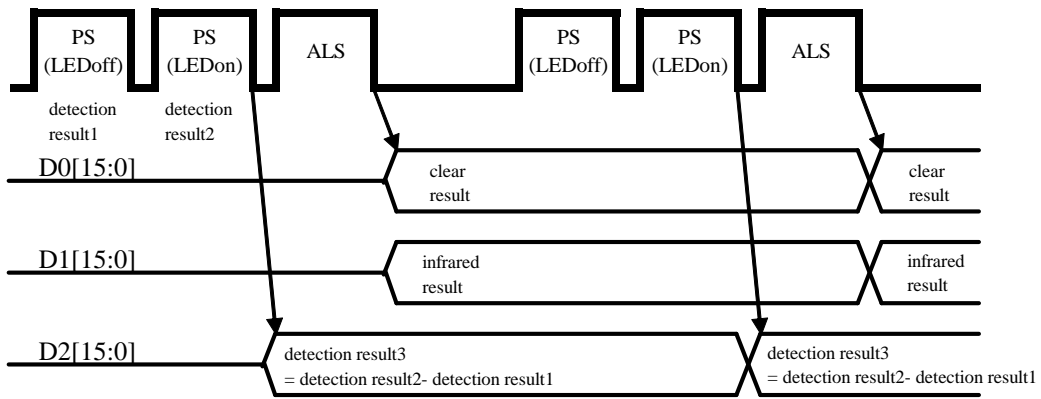

Fig.7 Output results for PS and ALS alternating mode

3.4. Count value checking mode (debug mode for PS)

Count value checking mode (debug mode for PS) can be used when developing your product.

Enable to output detection result1(LEDOff) to D1[15:0] and detection result2(LEDOn) to D2[15:0] by setting “11” in OP[1:0] register.

If you use this mode, you can examine the counts reflected from panel by subtracting result1 from result2.

4. Register Mapping

4.1. Register Mapping

When Vcc power is supplied, GP2AP030A00F starts up with initializing all registers.

Table 3 Register Mapping

ADDRESS	DATA								Initial Value	R/W
	D7	D6	D5	D4	D3	D2	D1	D0		
00H	OP3	OP2	OP1	OP0	PROX	FLAG_P	FLAG_A	0	H'00	R/W R+clear
01H	PRST1	PRST0	RES_A2	RES_A1	RES_A0	RANGE_A2	RANGE_A1	RANGE_A0	H'00	R/W
02H	0	INTTYPE	RES_P2	RES_P1	RES_P0	RANGE_P2	RANGE_P1	RANGE_P0	H'00	R/W
03H	INTVAL1	INTVAL0	IS1	IS0	PIN1	PIN0	FREQ	RST	H'00	R/W
04H	TL7	TL6	TL5	TL4	TL3	TL2	TL1	TL0	H'00	R/W
05H	TL15	TL14	TL13	TL12	TL11	TL10	TL9	TL8	H'00	R/W
06H	TH7	TH6	TH5	TH4	TH3	TH2	TH1	TH0	H'FF	R/W
07H	TH15	TH14	TH13	TH12	TH11	TH10	TH9	TH8	H'FF	R/W
08H	PL7	PL6	PL5	PL4	PL3	PL2	PL1	PL0	H'00	R/W
09H	PL15	PL14	PL13	PL12	PL11	PL10	PL9	PL8	H'00	R/W
0AH	PH7	PH6	PH5	PH4	PH3	PH2	PH1	PH0	H'FF	R/W
0BH	PH15	PH14	PH13	PH12	PH11	PH10	PH9	PH8	H'FF	R/W
0CH	D0_7	D0_6	D0_5	D0_4	D0_3	D0_2	D0_1	D0_0	H'00	R
0DH	D0_15	D0_14	D0_13	D0_12	D0_11	D0_10	D0_9	D0_8	H'00	R
0EH	D1_7	D1_6	D1_5	D1_4	D1_3	D1_2	D1_1	D1_0	H'00	R
0FH	D1_15	D1_14	D1_13	D1_12	D1_11	D1_10	D1_9	D1_8	H'00	R
10H	D2_7	D2_6	D2_5	D2_4	D2_3	D2_2	D2_1	D2_0	H'00	R
11H	D2_15	D2_14	D2_13	D2_12	D2_11	D2_10	D2_9	D2_8	H'00	R

4.2. Precautions for Register setting

- Please start setting registers after power-supply voltage becomes stable up to 90% or more set value. Please wait for some 1msec before setting registers from power-on.
- PROX, FLAG_P and FLAG_A registers are able to be cleared by writing 0 data in each register. (but these registers can't be written 1 data.)
- Please don't set the address 12H and the larger ones. (Test registers are assigned in those addresses)

4.3. Register Functions

Functions and set contents of the registers are shown below.

Table 4 description of the register function

ADDR	register	function	setting
00H	OP3	Software shutdown	0:shutdown, 1:operation
	OP2	Auto shutdown/Continuous operation	0:auto shutdown, 1:continuous operating function
	OP[1:0]	Operating mode selection	00:ALS and PS alternating, 01:ALS, 10:PS, 11: debug mode
	PROX	PS: detection/non-detection	0:non-detection, 1:detection
	FLAG_P	PS: interrupt result	0:non-interrupt, 1:interrupt
	FLAG_A	ALS: interrupt result	0:non-interrupt, 1:interrupt
01H	PRST[1:0]	Number of measurement cycles	00 : once, 01 : 4 cycles, 10 : 8 cycles, 11 : 16 cycles
	RES_A[2:0]	ALS:Resolution	000:8bits(0.39msec) - 111:19bits(800msec)
	RANGE_A[2:0]	ALS:Maximum measurable range	000:×1 - 111:×128
02H	INTTYPE	Interrupt type setting	0:level, 1:pulse
	RES_P[2:0]	PS:Resolution	100:8bits(0.39msec) - 111:16bits(100msec)
	RANGE_P[2:0]	PS:Maximum measurable range	000:×1 - 111:×128
03H	INTVAL[1:0]	Intermittent operating	00:0, 01:4 times, 10:8 times, 11:16 times
	IS[1:0]	ILED drive peak current setting	00:16.3mA, 01:32.5mA, 10:65mA, 11:130mA
	PIN[1:0]	INT terminal setting	00:ALS or PS, 01:ALS, 10:PS, 11:PS(Detection/Non-detection)
	FREQ	LED modulation frequency	0:327.5kHz, 1:81.8kHz
	RST	Software Reset	0:not reset, 1:reset
04H,05H	TL	ALS:low threshold setting	16bits counts setting
06H,07H	TH	ALS:High threshold setting	16bits counts setting
08H,09H	PL	PS:low threshold setting(Loff)	16bits counts setting
0AH,0BH	PH	PS:High threshold setting(Lon)	16bits counts setting
0CH,0DH	D0	ALS result:Clear	16bits output data from Clear PD
0EH,0FH	D1	ALS result :IR	16bits output data from IR PD
10H,11H	D2	PS result	16bits output data in PS mode

4.4. Register settings for Basic operation

4.4.1. Software-shutdown: OP[3] (ADDRESS:00H)

Control power supply to the circuit. LED drive circuit is always off in shutdown mode. After power on, start with shutdown mode.

OP [3] register (Address 00H)

- 0: shutdown mode
- 1: operating mode.

4.4.2. Auto-shutdown/Continuous operation: OP[2] (ADDRESS:00H)

Select auto-shutdown mode or continuous operating mode. After shutdown, OP[3] register will be automatically cleared.

OP [2] register (Address 00H)

- 0: auto shutdown mode
- 1: continuous operating mode.

4.4.3. Operating mode selection: OP [1:0] (ADDRESS:00H)

Select ALS mode or PS mode or alternating mode(PS + ALS).

OP [1:0] register (Address 00H)

- 01: ALS mode
 - Detection result of clear photodiode is output to D0[15:0] register (Address 0CH, 0DH).
 - Detection result of infrared photodiode is output to D1[15:0] register (Address 0EH, 0FH).
- 10: PS mode
 - Sensing result of detection/non-detection is output to PROX register(Address 00H).
 - Detection result of distance is output to D2[15:0] register (Address 10H, 11H).
- 00: PS and ALS alternating mode
- 11: Test mode for PS
 - Confirmation of LEDoff and LEDon counts respectively resulting in PS counts.

4.4.4. Number of measurement cycles setting: PRST[1:0] (ADDRESS:01H)

Select number of measurement cycles by setting PRST[1:0] register. Output interrupt result or judgment result for detection/non-detection in case detection result is over threshold continuously more than the set cycles in

PRST[1:0] register.

PRST[1:0] register(Address 01H):

- 00: 1cycle
- 01: 4cycles,
- 10: 8cycles
- 11: 16cycles

- Algorithm for detecting object in PS is as follows.

<Judge the change from non-detecting status to detecting status>

Detection result is over high threshold (Lon) N times continuously : Detection
Other : Non-detection

<Judge the change from detecting status to non-detecting status>

Detection result is over low threshold (Loff) N times continuously : Non-Detection
Other : Detection

- Algorithm for detecting object in ALS is as follows.

<Judge the change from low illuminance to high illuminance>

Detection result is over high threshold (th) N times continuously : Output interrupt
Other : Non-output

<Judge the change from high illuminance to low illuminance>

Detection result is over low threshold (tl) N times continuously :Output interrupt
Other : Non-output

4.4.5. Interrupt type setting: INTTYPE (ADDRESS:02H)

Select level interrupt type or pulse interrupt type.
INTTYPE register (Address 02H)

0: level interrupt type

In this case, transition from H to L in INT terminal become occurring interrupt signal and INT terminal will hold L level until interrupt is cleared.

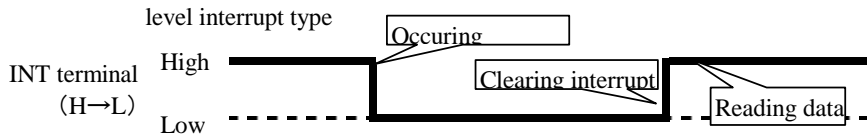

Fig.8 Interrupt output (level interrupt type)

1: pulse interrupt type

In this case, L pulse output in INT terminal become occurring interrupt signal and INT terminal will not hold L level. Therefore we need not to clear interrupt flag(FLAG_P, FLAG_A). FLAG_P and FLAG_A are cleared automatically in 1 clock (about 1.5us).

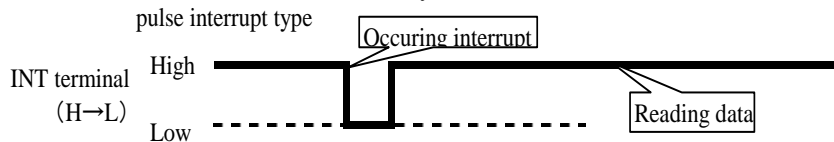

Fig.9 Interrupt output (pulse interrupt type)

4.4.6. Intermittent operating function: INTVAL[1:0] (ADDRESS 03H)

Enable to change intermittent operating periods by setting INTVAL [1:0] register (Address 03H).

00: 0 time, 01: 4 times, 10: 8 times, 11: 16 times

Intermittent operating will be done during setting period in RES_A[2:0] and RES_P(Resolution/measuring time) by the number of times set by INTVAL [1:0] register.

For ALS mode, in case of RES_A [2:0]=011 16bit setting(measuring period 100msec) and INTVAL [1:0]=01(4 intermittent operating cycles), quiescent operation time will be 400msec(=100msec × 4 times).

For PS mode, in case of RES_P [2:0]=010 12bit setting(measuring period 6.25msec) and INTVAL [1:0]=01(4 intermittent operating cycles), quiescent operation time will be 25msec(=6.25msec × 4 times).

For ALS mode and PS mode sequentially, in case of RES_A[2:0]=011 16bit setting(measuring period 100msec) ,RES_P [2:0]=010 12bit setting(measuring period 6.25msec) and INTVAL [1:0]=01(4 intermittent operating cycles), quiescent operation time will be 25msec(=6.25msec × 4 times). PS mode condition takes priority.

Although setting a longer intermittent operating period contributes to reduce average consumption current, it makes update period and response time for detection longer as a result. Need to set it considering your actual conditions in use.

Ambient light sensor (ALS) mode INTVAL[1:0]=01 : 4 times setting

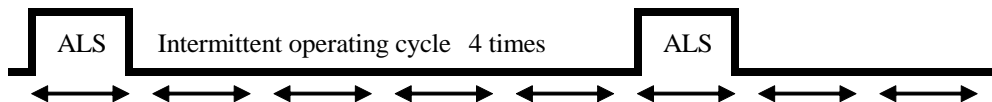

Proximity sensor (PS) mode INTVAL[1:0]=01 : 4 times setting

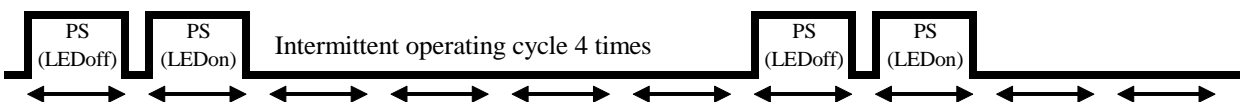

Proximity and Ambient light sensor (PS & ALS) mode INTVAL[1:0]=01 : 4 times setting

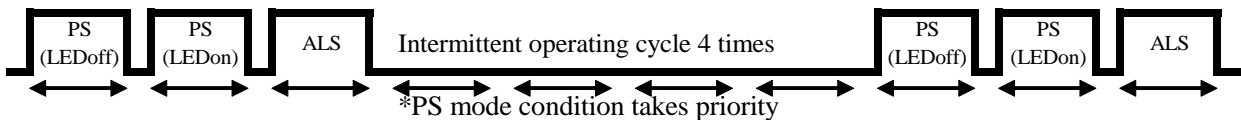

Fig.10 intermittent operating for each mode

4.4.7. INT terminal setting: PIN[1:0] (ADDRESS 03H)

Select output mode in INT terminal by setting PIN register (Address 03H).

The outputs by INCLUSIVE-OR(FLAG_P, FLAG_A), FLAG_P, FLAG_A, PROX can be selected.

Table 5 INT terminal setting

PIN[1:0]	Setting	Output data
00	Interrupt output for PS mode and ALS mode	FLAG_P or FLAG_A
01	Interrupt output for ALS mode only	FLAG_A
10	Interrupt output for PS mode only	FLAG_P
11	Detection/Non-detection judgment output	PROX

4.4.8. Software reset: RST (ADDRESS 03H)

Initialize all registers by writing 1 in RST register. RST register is also initialized automatically and becomes 0.

5. Register settings for PS

5.1. Output value of sensing result for detection/non-detection: PROX (ADDRESS 00H)

Sensing result for detection/non-detection is output in PS mode. There is a function which clears data by writing 0 in PROX register.

PROX register(Address 00H): 0: non-detection, 1: detection

5.2. Output value of PS interrupt result: FLAG_P (ADDRESS 00H)

FLAG_P register is output interrupt result for PS mode.

There is a function which clears by writing 0 in d FLAG_P register.

FLAG_P register (Address 00H) : 0: non-interrupt, 1: interrupt

5.3. Resolution/Measuring duration setting for PS mode: RES_P [2:0] (ADDRESS 02H)

Select measuring resolution and measuring duration for PS mode by setting RES_P [2:0] register (Address 02H).

2 times of measuring duration is required for PS mode since detection result is gotten by subtraction of result 1 (LEDOff) and result 2 (LEDon)

If resolution is low, measuring tolerance becomes large. Please have an adjustment at your system.

Table 6. Resolution/Measuring duration setting for PS mode

RES_P[2:0]	Resolution	Measuring time	Remarks
		PS mode	
000	16bit	100msec × 2	recommended
001	14bit	25msec × 2	
010	12bit	6.25msec × 2	
011	10bit	1.56msec × 2	
100	8bit	0.39msec × 2	Not Allowed
101	6bit	0.097msec × 2	Not Allowed
110	4bit	0.024msec × 2	Not Allowed
111	2bit	0.006msec × 2	Not Allowed

* Grayed-out portions is not recommended.

5.4. Maximum measurable range for PS mode: RANGE_P[2:0] (ADDRESS 02H)

Select maximum measurable range for PS mode by setting RANGE_P [2:0] register (Address 02H).

Detect with a set range in PS mode. Maximum count value is outputted in case of incident light exceeding maximum measurable range.

It is possible to have countermeasure for external light by setting a large count value at maximum measurable range.

In case external light exceeds maximum sensing range, “non-detection” will be output because both detection result 1 (LEDOff) and detection result 2 (LEDon) become maximum count values, and the subtraction result(detection result 2 – result 1) become 0.

Changing maximum measurable range, detection result count in PS mode is also change. In case of considering 000: ×1 setting as ×1 time, count would be 1/2 times at 001: ×2 setting, 1/4 times at 010: ×4 setting. Adjusting detecting distance by proximity low threshold PL[15:0] and PH[15:0]. It is necessary to set them considering the condition in the actual use and evaluating at your system.

If you set Auto Light Cancellation mode, you should be at least four times(×4) the maximum measurable range setting for PS mode(RANGE_P [2:0]).

Table 7. Maximum measurable range for PS mode

RANGE_P[2:0]	Maximum measurable range	Remarks
	PS mode	
000	×1	
001	×2	
010	×4	recommended
011	×8	recommended
100	×16	
101	×32	
110	×64	
111	×128	

* Grayed-out portions is not recommended.

5.5. LED drive peak current setting IS [1:0] (ADDRESS 03H)

Enable to select LED drive peak current by setting IS [1:0] register (Address 03H) in PS mode. In case of changing this setting, the count obtained by subtraction detection result 1 (LEDOff) from detection result 2 (LEDOn) at PS mode will change correspond to the set LED drive peak current.

In case of considering 00:16.3mA setting as x1 time, count will increase 2times at 01:32.5mA setting, 4times at 10:65mA setting, x8 times at 11:130mA setting. Please adjust detecting distance with proximity low threshold PL[15:0] and proximity high threshold PH[15:0].

LED drive peak current will depend on Vcc voltage. (Refer to 13.1. LED drive peak current data)

Table 8. LED drive peak current

IS[1:0]	LED drive peak current	Remarks
00	16.3 mA	
01	32.5 mA	
10	65 mA	
11	130 mA	recommended

* Grayed-out portions is not recommended.

5.6. LED modulation frequency(duty) setting: FREQ (ADDRESS 03H)

Select modulation frequency of LED driving period.

FREQ register (Address 03H): 0: 327.5kHz (Duty during a PS measurement: 25.0%)

1: 81.8kHz (Duty during a PS measurement: 6.3%)

Changing modulation frequency setting, count obtained by subtraction detection result1 (LEDOff) from detection result2 (LEDOn) will be changed correspond to LED modulation frequency setting.

Considering 1:81.8kHz setting as x1 time, the count at 0:327.5kHz setting would be x4 times. Please adjust detecting distance with proximity low threshold PL[15:0] and proximity high threshold PH[15:0].

327.5kHz setting helps to adjust threshold value at long distance in PS because the count which subtracted detection result1 (LEDOff) from detection result2 (LEDOn) would increase by x4 times. In this case, average consumption current increase by x4 times, therefore it is necessary to consider your setting by evaluating your system and condition.

The duty and average consumption current under LED drive is shown under below.

Table 9. Duty and average consumption current under LED drive

INTVAL[1:0]	LED driving duty		LED Average consumption current [mA]							
			IS[1:0]=00(16.3mA)		IS[1:0]=01(32.5mA)		IS[1:0]=10(65mA)		IS[1:0]=11(130mA)	
	FREQ=0	FREQ=1	FREQ=0	FREQ=1	FREQ=0	FREQ=1	FREQ=0	FREQ=1	FREQ=0	FREQ=1
00	25.0%	6.3%	4.08	1.03	8.13	2.05	16.25	4.10	32.50	8.19
01	8.3%	2.1%	1.35	0.34	2.70	0.68	5.40	1.37	10.79	2.73
10	5.0%	1.3%	0.82	0.21	1.63	0.42	3.25	0.85	6.50	1.69
11	2.8%	0.7%	0.46	0.11	0.91	0.23	1.82	0.46	3.64	0.91

* Grayed-out portions is not recommended.

5.7. Proximity low threshold (Loff):PL[15:0] (ADDRESS 08H, 09H)

Sets proximity low threshold in PL[15:0] register at PS mode.

Please set it with confirming at optical mounting condition in the actual use.

5.8. Proximity high threshold (Lon):PH[15:0] (ADDRESS 0AH, 0BH)

Sets proximity high threshold in PH[15:0] register at PS mode.

Please set it with confirming at optical mounting condition in the actual use.

5.9. PS Detection result: D2 [15:0] (ADDRESS 10H,11H)

[PS mode]

Detection result3 of proximity sensing is output to D2[15:0] register (Address 10H, 11H).

Detection result1 and result2 is not output to register.

Detection result3 is defined as follows,

$$\text{Detection result3} = \text{Detection result2(LEDOn)} - \text{Detection result1(LEDOff)}$$

In this case, 2 times of measuring duration is required for PS mode.

Proximity sensor (PS) mode

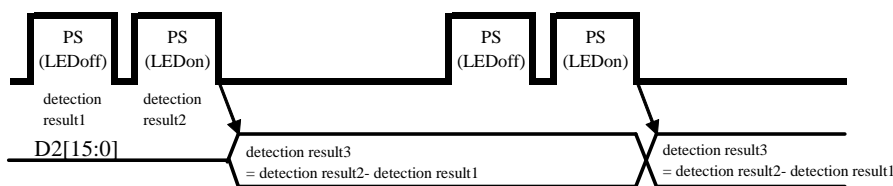

Fig.11 Sensing results output for PS mode (ALC=0)

6. Register settings for ALS

6.1. Output value of ALS interrupt result: FLAG_A (ADDRESS 00H)

FLAG_A register is output interrupt result for ALS mode.

There is a function which clears by writing 0 in d FLAG_A register.

FLAG_A register (Address 00H): 0: non-interrupt, 1: interrupt

6.2. Resolution/Measuring duration setting for ALS mode: RES_A [2:0] (ADDRESS 01H)

Select measuring resolution and measuring duration for ALS mode by setting RES_A [2:0] register (Address 01H).

If resolution is low, measuring tolerance becomes large. Please have an adjustment at your system.

Table 10. Resolution/Measuring duration setting for ALS mode

RES_A[2:0]	Resolution	Measuring time	Remarks
		ALS mode	
000	19bit	800msec	
001	18bit	400msec	
010	17bit	200msec	
011	16bit	100msec	recommended
100	14bit	25msec	recommended
101	12bit	6.25msec	
110	10bit	1.56msec	
111	8bit	0.39msec	

* Grayed-out portions is not recommended.

6.3. Maximum measurable range for ALS mode: RANGE_A[2:0] (ADDRESS 01H)

Select maximum measurable range for ALS mode by setting RANGE_A [2:0] register (Address 01H).

Detect with a set range in ALS mode. Maximum count value is outputted in case of incident light exceeding maximum measurable range.

It is possible to have countermeasure for external light by setting a large count value at maximum measurable range.

It is necessary to set them considering the condition in the actual use and evaluating at your system.

Table 11. Maximum measurable range for ALS mode

RANGE_A[2:0]	Maximum measurable range	Remarks
	ALS mode	
000	×1	
001	×2	
010	×4	
011	×8	recommended
100	×16	
101	×32	
110	×64	
111	×128	

6.4. ALS interrupt low threshold: TL[15:0] (ADDRESS 04H,05H)

Sets interrupt low threshold in TL[15:0] register at ALS mode.

Please set it with confirming at optical mounting condition in the actual use.

6.5. ALS interrupt high threshold: TH[15:0] (ADDRESS 06H,07H)

Sets interrupt high threshold in TH[15:0] register at ALS mode.

Please set it with confirming at optical mounting condition in the actual use.

6.6. ALS Detection result: D0 [15:0], D1 [15:0] (ADDRESS 0CH,0DH,0EH,0FH)

Detection result of clear photodiode is output to D0[15:0] register (Address 0CH, 0DH).

Detection result of infrared photodiode is output to D1[15:0] register (Address 0EH, 0FH).

The results of without infrared light can be obtained by some calculation using D0[15:0] and D1[15:0].

The results of without infrared light = $\alpha * D0[15:0] - \beta * D1[15:0]$

α and β factor are decided by ratio of D1 [15:0]/D0 [15:0].

These factors are shown below in the case of no panel.

These factors might be necessary to be adjusted according to the case panel in use.

Table 12. α and β factor for illuminance calculation

Ratio of Data1[15:0]/ Data0[15:0]	α	β
Ratio ≤ 0.67	6.650	9.653
$0.67 < \text{Ratio} \leq 0.90$	1.805	1.977
$0.90 < \text{Ratio}$	0.000	0.000

Ambient light sensor (ALS) mode

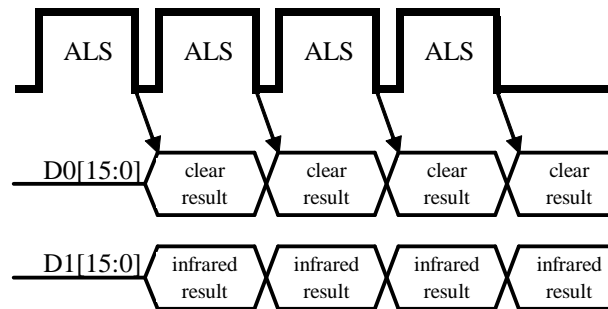

Fig.12 Sensing results output for ALS mode

7. INT terminal output mode

7.1. Proximity detection/non-detection sensing result output mode

INT terminal operates with sensing result output mode by setting PIN[1:0] register(Address 03H)
 11:detection/non-detection sensing result output mode. Sensing result whether or not object is detected is able to be read out via I²C bus interface and output from INT terminal with negative logic.

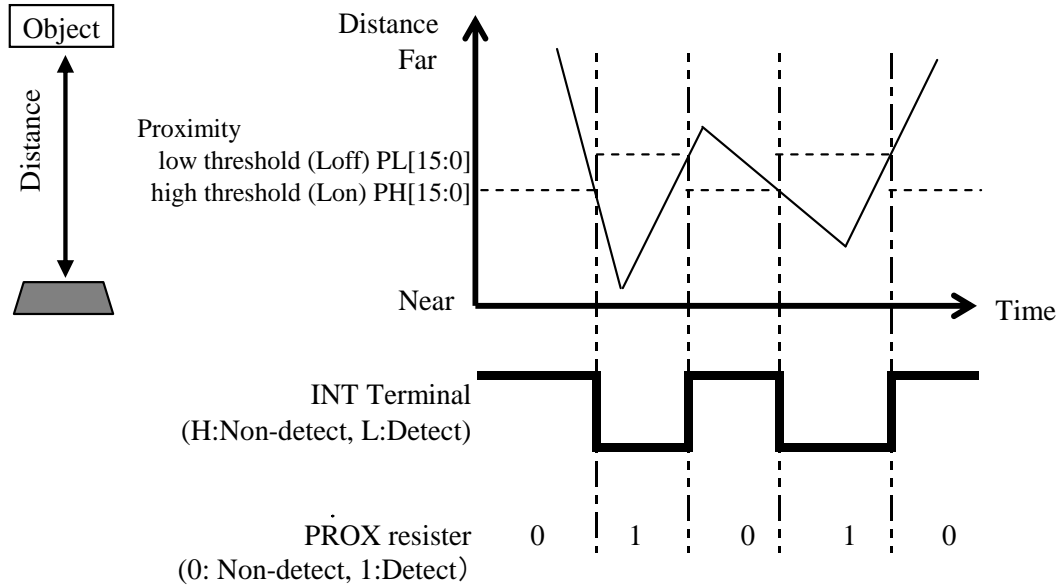

Fig.13 Detection result output mode

7.2. Interrupt output mode

Operates as interrupt output mode by setting PIN[1:0] register (Address 03H) 00,01,10: interrupt output mode. There are two kinds of output mode(level interrupt & pulse interrupt, see 4.4.5. Interrupt type setting). Below is a description of the level interrupt type.

The result of interrupt judgment for ALS mode is written into FLAG_A register (Address 00H), and is read out from I²C bus interface. (0: Non-interrupt, 1: interrupt.)

In this case, transition from H to L in INT terminal become occurring interrupt signal and INT terminal will be hold L level until interrupt is cleared. Interrupt will be cleared in writing 0 data in FLAG_A register.

The result of interrupt judgment for PS mode is written into FLAG_P register (Address 00H), and is read out from I²C bus interface. (0: Non-interrupt, 1: interrupt.)

In this case, transition from H to L in INT terminal become occurring interrupt signal and INT terminal will be hold L level until interrupt is cleared. Interrupt will be cleared in writing 0 data in FLAG_P register.

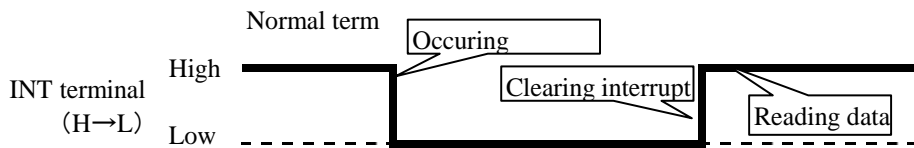

Fig.14 Interrupt output (level interrupt type)

Detecting operation will continue while INT terminal is L level. Update ALS detection result D0[15:0],D1[15:0] and sensing result of object detection/non-detection status. Therefore, host needs to read data after FLAG_A and FLAG_P register clear.

For example, as shown in below diagram,

Interrupt occurs with FLAG_P=1: interrupt

Actual object moves “Detection” to “Non-detection” to “Detection” while interrupt is cleared.

In this case, while INT terminal (FLAG_P register) is hold, PROX value will be updated with result of judgment for detection/non-detection of object.

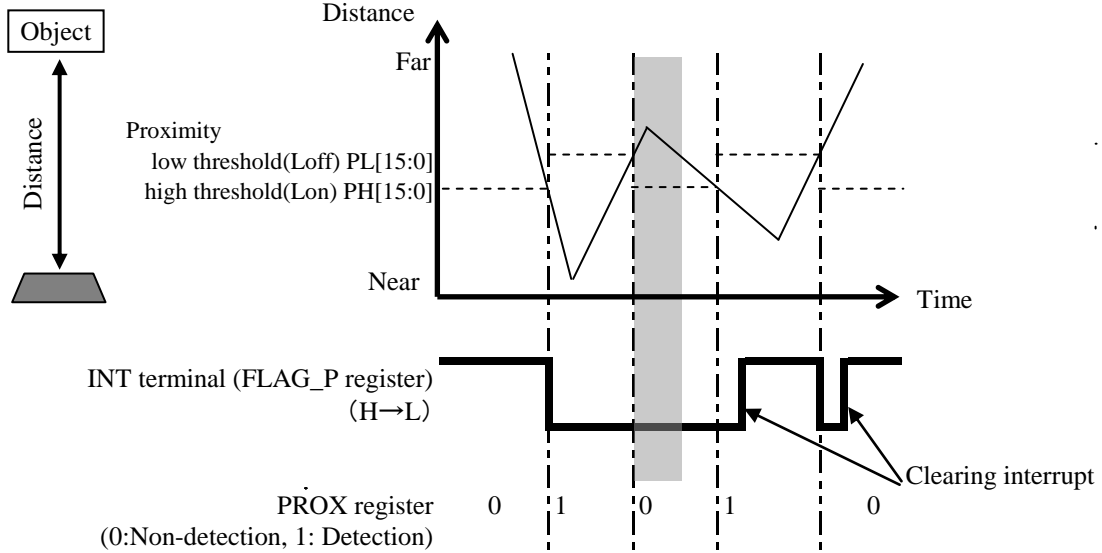

Fig.15 Interrupt output mode (level interrupt type)

8. Average consumption current in operation

8.1. Average consumption current in operation

Average consumption current in operation is the sum of the average current consumption value with Vcc terminal and LED consumption. The LED driven current flows from LEDA terminal to GND terminal.

8.2. Average consumption current at ambient light sensor (ALS) mode

Average consumption current at ALS mode is typical 65uA.

Using intermittent operating function, Consumption current can be typical 30uA in intermittence duration.

8.3. Average consumption current at proximity sensor (PS) mode

In case of continuous operation, average consumption current in LED is estimated as below.

[LED average consumption current]
 = LED drive peak current × LED modulating frequency setting / (intermittence operating times+2)

[LED drive peak current]: IS[1:0] register. (00 : 16.3mA, 01 : 32.5mA, 10 : 65mA, 11 : 130mA)

[LED modulating frequency]: FREQ register.

0 : 327.5kHz LED is driven with 1.5usec on time at 327.5kHz

Averaging consumption current in LED will be half.

1 : 81.8kHz LED is driven with 1.5usec on time at 81.8kHz.

Averaging consumption current in LED will be 1-8 time.

[Intermittence operating cycle] : Enable to set with INTVAL[1:0]

00 : 0times, 01 : 4times, 10 : 8times, 11 : 16times

For example,

[LED drive peak current]	: 16.3mA	IS[1:0]=00
[LED modulated frequency setting]	: 81.8kHz	FREQ=1
[Intermittence operating time]	: 4times	INTVAL[1:0]=01

In the above case,

[LED averaging consumption current] = 16.3mA × 0.125 / (4 + 2) = 0.339mA

Also, using auto-shut down function, it will be automatically shutdown after one operation. Utilizing it with adjusting your system, it contributes to reduce averaging consumption current in LED.

9. Countermeasure against external light noise in PS mode

9.1. Countermeasure against external light noise in PS mode

This product makes judgment of detection/non-detection by integrating light amount in PD for setting duration. In PS mode, eliminate external noise by subtracting output at LEDon and LEDoff. In case of exceeding maximum detectable range, judgment result will be non-detect status because both LEDoff and LEDon are maximum counts due to over detectable range and subtract value will be 0.

Maximum detectable range is changed by setting RANGE_P[2:0] register. It contributes to make countermeasure with setting large value in maximum detectable range.

10. Recommended operating mode/Procedure of register setting

When the ALS mode and PS mode switch, please shut down and switched again..

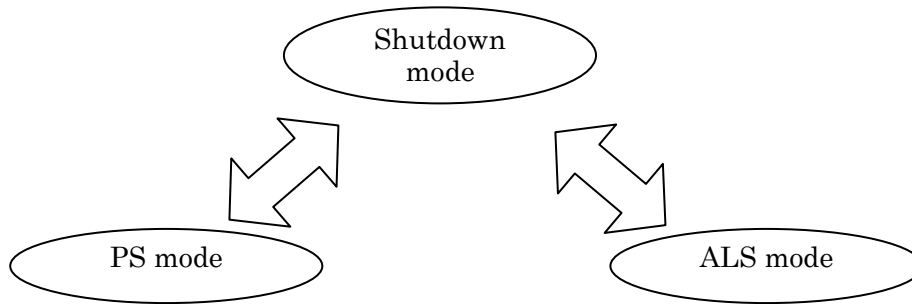

Fig.16 Recommended operating mode

10.1. Shutdown mode

Below is an example of shutdown mode.

If you shut down, the INT terminal states are maintained. If the INT terminal is L level, due to the increased power consumption, it is recommended that you clear the interrupt.

Table 13 example of setting for Shutdown mode

setting	example	register
Operation mode	Shutdown	OP[3]=b'0
Detection/non-detection sensing result	Clear	PROX=b'0
Detecting interrupt result (PS)	Clear	FLAG_P=b'0
Detecting interrupt result (ALS)	Clear	FLAG_A=b'0

Table 14 example of register setting table for Shutdown mode

Register ADDRESS	Register SYMBOL	Register value		Remarks
		bite	Hex	
00H	COMMAND I	b'0000 0000	h'00	

11. Sample programs

11.1. Sample program of function.

```
#include <stdlib.h>

////////// Parameter define
#define ADDR_SLAVE_W 0x88 //slave address of GP2AP030A00F for write mode
#define ADDR_SLAVE_R 0x89 //slave address of GP2AP030A00F for read mode

#define I2C_ACK (0)

int16 data_read( int addr);
{
    int16 read_data = 0x0000;
    unsigned char ack;

    i2c_start(); //start condition
    ack = i2c_write(ADDR_SLAVE_W); //slave address send
    if (ack != I2C_ACK) {
        m_ErrorMsg();
    }
    ack = i2c_write(addr); //word address send
    if (ack != I2C_ACK) {
        m_ErrorMsg();
    }
    i2c_stop();

    i2c_start();
    ack = i2c_write(ADDR_SLAVE_R); //slave address send
    if (ack != I2C_ACK) {
        m_ErrorMsg();
    }
    read_data = i2c_read(0); //nack
    i2c_stop();
    return read_data;
} //End of data_read function

void data_write(int word_addr, int write_data)
{
    unsigned char ack;

    i2c_start(); //start condition
    ack = i2c_write(ADDR_SLAVE_W); //slave address send
    if (ack != I2C_ACK) {
        m_ErrorMsg();
        return;
    }
    ack = i2c_write(word_addr); //word address send
    if (ack != I2C_ACK) {
        m_ErrorMsg();
        return;
    }
    ack = i2c_write(write_data); //write data send
    if (ack != I2C_ACK) {
        m_ErrorMsg();
        return;
    }
    i2c_stop();
    return;
}
```

}

11.2. Sample program for PS and ALS alternating mode

Table 15 example of sample program setting for PS mode

setting	Example	register
Operation mode	Operation status(active)	OP[3]=b'1
Operation mode	Continuous operation	OP[2]=b'1
Operation mode	PS and ALS mode	OP[1:0]=b'00
Number of detection*1	×4(initial setting)	PRST[1:0]=b'01
Resolution(ALS)	14bit(Measuring time25msec)	RES_A[2:0]=b'100
Maximum detectable range(ALS)	×8(initial setting)	RANGE_A[2:0]=b'011
Resolution(PS)	10bit(Measuring time1.56msec ×2)	RES_P[2:0]=b'011
Maximum detectable range(PS)	×4	RANGE_P[2:0]=b'010
Intermittence duration	0time	INTVAL[1:0]=b'00
LED drive peak current	130mA	IS[1:0]=b'11
INT terminal setting	PS(Detection/Non-detection)	PIN[1:0]=b'11
LED modulation frequency	327.5kHz	FREQ=b'0
Low threshold (PS)	10 counts(Loff 80mm)	TL[15:0]=b' 0000 0000 0000_1010(d'10)
High threshold (PS)	10 counts(Lon 60mm)	TH[15:0]=b'0000 0000 0000_1010(d'10)

*1 Non-detection state is set to 4 cycles. Detection state is set to 1 cycle. Please refer to the following sample program.

----- Sample program for PS and ALS alternating mode -----

```

#define Low_lux_mode 0
#define High_lux_mode 1
#define NO_PROX 0
#define PROX 1
#define NO_INTERRUPT 0
#define INTERRUPT 1

int ALS_MODE = Low_lux_mode;
int PROX_MODE = NO_PROX;

// Initial setting
data_write(0x01, 0x63); // Write 63h in 1st register . . . PRST ×4, ALS mode(res:14bit, range×8)
data_write(0x02, 0x1A); // Write 1Ah in 2nd register . . . PS mode(res:10bit, range×4)
data_write(0x03, 0x3C); // Write 3Ch in 3rd register . . . 130mA, Detection/Non-detection judgment
data_write(0x08, 0x0A); // Write 0Ah in 8th register . . . PS mode LTH:10
data_write(0x09, 0x00); // Write 00h in 9th register . . . PS mode
data_write(0x0A,0x0A); // Write 0Ah in 10th register . . . PS mode HTH:10
data_write(0x0B,0x00); // Write 00h in 11th register . . . PS mode
data_write(0x00, 0xC0); // Write C0h in 00th register . . . PS and ALS alternating mode

for(;;) {
    switch(INTERRUPT_STATE){
    case NO_INTERRUPT:

        delay_ms(200);
        D0 = data_read(0x0c);
        temp = data_read(0x0d);
        D0 = (temp << 8) | D0
        D1 = data_read(0x0e);
        temp = data_read(0x0f);
        D1 = (temp << 8) | D1
    }
}

```

```

if(ALS_mode == Low_lux_mode){
    if(D0 > 16000){
        ALS_mode = High_lux_mode;    // Low -> High lux mode

        data_write(0x00, 0x0C);        //shutdown
        if(PROX == NO_PROX)
            data_write(0x01, 0x67);    //prst 4, 14bit , ×128
        else
            data_write(0x01, 0x27);    //prst 1, 14bit , ×128
        data_write(0x00, 0xCC);
    }else{
        ratio = (float)data_als1/(float)data_als0;
        if(ratio<=0.67)
            lux = (6.650*(float)data_als0 – 9.653*(float)data_als1);
        else if(ratio>=0.9)
            lux = 0;
        else
            lux = (1.805*(float)data_als0 – 1.977*(float)data_als1);
    }
}
}else{
    if(D0 < 1000){
        ALS_mode = Low_lux_mode;    // High ->Low lux mode
        data_write(0x00, 0x0C);        //shutdown
        if(PROX == NO_PROX)
            data_write(0x01, 0x63);    //prst 4, 14bit , ×8
        else
            data_write(0x01, 0x23);    //prst 1, 14bit , ×8
        data_write(0x00, 0xCC);
    }
    else{
        ratio = (float)data_als1/(float)data_als0;
        if(ratio<=0.67)
            lux = 16*(6.650*(float)data_als0 – 9.653*(float)data_als1);
        else if(ratio>=0.9)
            lux = 0;
        else
            lux = 16* (1.805*(float)data_als0 – 1.977*(float)data_als1);
    }
}
}
break;

case INTERRUPT:
    data = data_read(10h);
    if((data & 0x08) == 0x08){
        PROX_MODE = PROX;
        DISPLAY CONTROL;
        if(ALS_MODE == Low_lux_mode)
            data_write(0x01,0x23);        //prst 1, 14bit , ×8
        else
            data_write(0x01, 0x27);        //prst 1, 14bit , ×128
    }
    else if((data & 0x08) == 0x00){
        PROX_MODE = NO_PROX;
        DISPLAY CONTROL;
        if(ALS_MODE == Low_lux_mode)
            data_write(0x01,0x63);        //prst 4, 14bit , ×8
        else
            data_write(0x01, 0x67);        //prst 4, 14bit , ×128
    }
}
break;

```

```

}
}
----- end of Sample program for PS and ALS alternating mode -----

```

11.3. Sample program for ALS mode

Below is a sample program.

Table 16 example of sample program setting for ALS mode

setting	example	register
Operation mode	Operation status(active)	OP[3]=b'1
Operation mode	Continuous operation	OP[2]=b'1
Operation mode	ALS mode	OP[1:0]=b'01
Resolution(ALS)	14bit(Measuring time25msec)	RES_A[2:0]=b'100
Maximum detectable range(ALS)*1	×8(initial setting)	RANGE_A[2:0]=b'011

*1 The range(×8 or ×128) is switched according to the D0 data.

Low_lux_mode:×8,High_lux_mode:×128

```

----- Sample program for ALS mode -----
#define Low_lux_mode 0
#define High_lux_mode 1

int ALS_MODE = Low_lux_mode;

// Initial setting
data_write(0x01, 0x23); // Write 23h in 1st register . . . ALS mode(res:14bit, range×8)
data_write(0x00, 0xD0); // Write D0h in 00th register . . . ALS mode
for(;;) {
    delay_ms(200);
    D0 = data_read(0x0c);
    temp = data_read(0x0d);
    D0 = (temp << 8) | D0
    D1 = data_read(0x0e);
    temp = data_read(0x0f);
    D1 = (temp << 8) | D1
    if(ALS_mode == Low_lux_mode){
        if(D0 > 16000){
            ALS_mode = High_lux_mode; // Low -> High lux mode
            data_write(0x00, 0x0C); //shutdown
            data_write(0x01, 0x27); //prst 1, 14bit , ×128
            data_write(0x00, 0xCC);
        }else{
            ratio = (float)data_als1/(float)data_als0;
            if(ratio<=0.67)
                lux = (6.650*(float)data_als0 - 9.653*(float)data_als1);
            else if(ratio>=0.9)
                lux = 0;
            else
                lux = (1.805*(float)data_als0 - 1.977*(float)data_als1);
        }
    }else{
        if(D0 < 1000){
            ALS_mode = Low_lux_mode; // High ->Low lux mode
            data_write(0x00, 0x0C); //shutdown
            data_write(0x01, 0x23); //prst 1, 14bit, ×8
            data_write(0x00, 0xCC);
        }
        else{
            ratio = (float)data_als1/(float)data_als0;
            if(ratio<=0.67)

```

```
        lux = 16*(6.650*(float)data_als0 - 9.653*(float)data_als1);  
    else if(ratio>=0.9)  
        lux = 0;  
    else  
        lux = 16*(1.805*(float)data_als0 - 1.977*(float)data_als1);  
    }  
}
```

----- End of Sample program for ALS mode -----

12. Recommended Window Size (Reference)

12.1. Without light shield

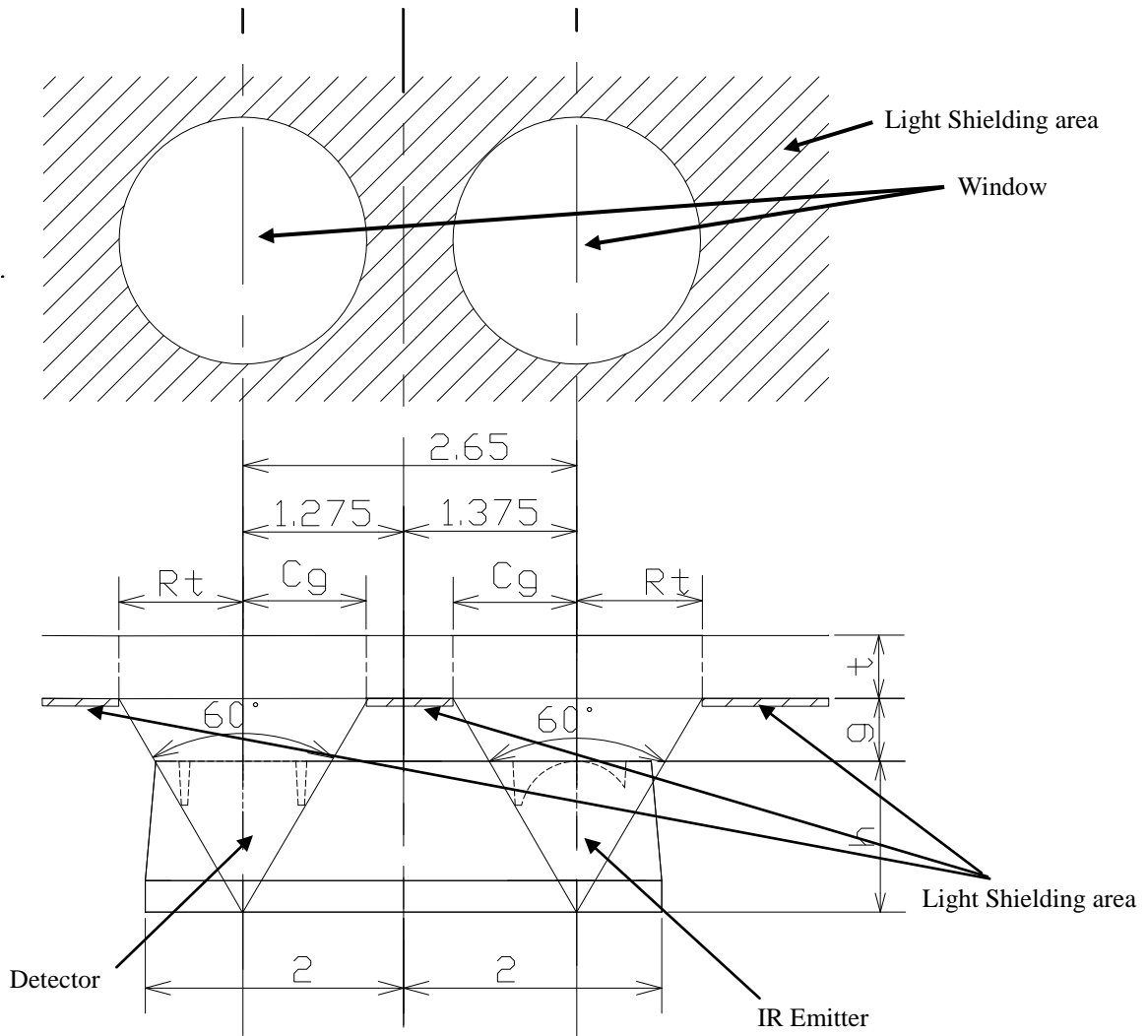

GP2AP030A00F

$h = n \times r / (n - 1) = 1.2\text{mm}$
 $n = 1.58$ n : mold resin refractive index
 $r = 0.45$ r : radius
 $Cg = (h+g) \times \tan 30$
 $Rt = (h+g) \times \tan 30$
 $g \leq 0.4\text{mm}$ (recommended) g : distance between sensor and panel
 $t \leq 0.7\text{mm}$ (recommended) t : thickness of panel
 $g+t \leq 1.1\text{mm}$ (recommended)

Fig.17 Recommended window size (Without light shield)

1. Please print or tape up not to transmit infrared.
2. Please execute the Light Shielding between windows.
3. Even recommended window size may cause malfunction depending on the reflection from the panel.
In this case, it is effective to be extended the printing area between windows, but affects detection distance and ALS output.
4. Please confirm that there is no problem with an actual machine in consideration of the implementation gap, the misalignment of the windows and voltage variation.
5. The recommended transmissivity ($400\text{nm} \leq \lambda \leq 1100\text{nm}$) of the window is more than 85%.
6. In case that malfunction is not resolved under the window design described above, the light shield is recommended to set, which described below : 12.2. With light shield.

12.2. With light shield

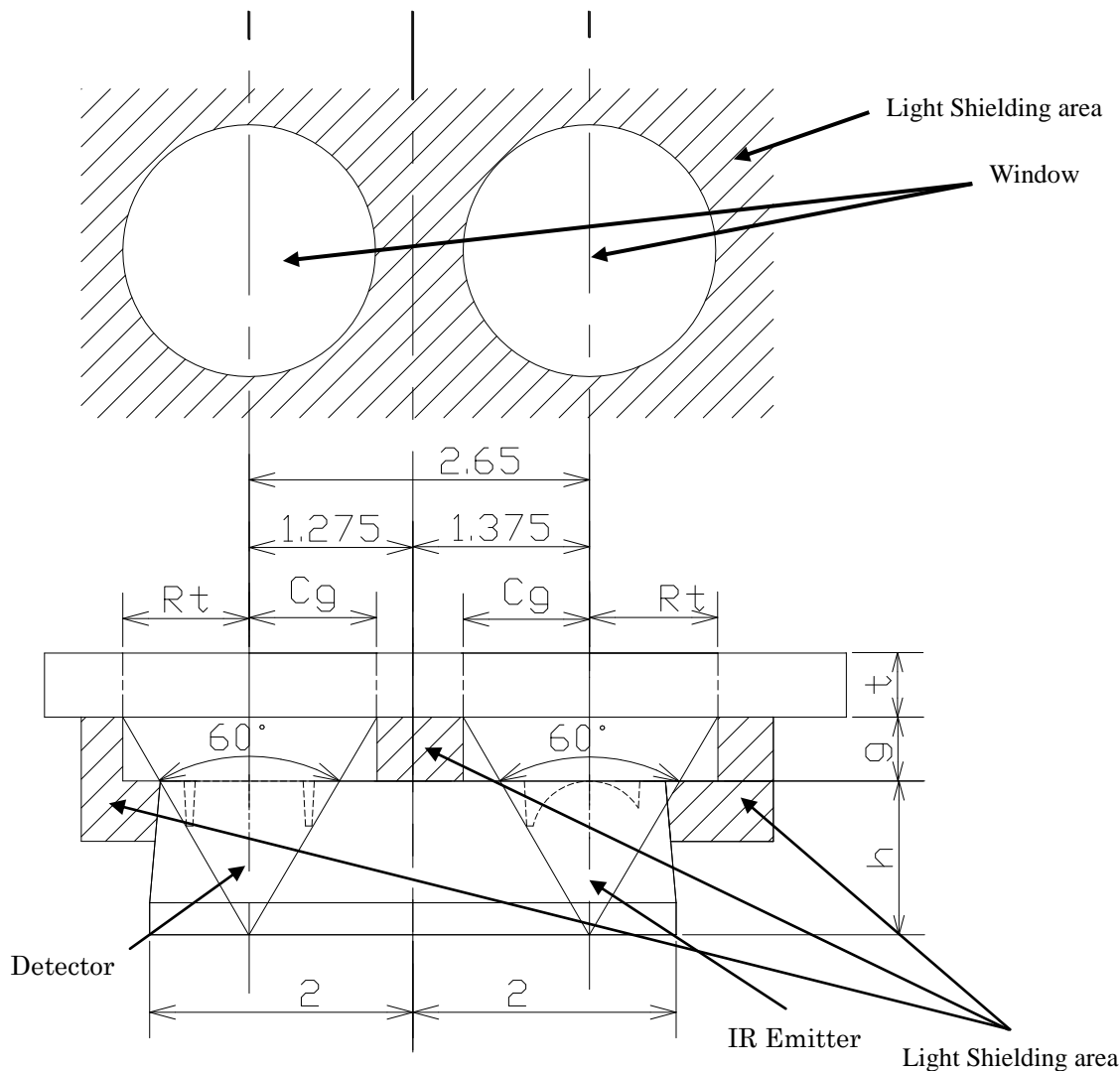

GP2AP030A00F

$h = n \times r / (n - 1) = 1.2\text{mm}$
 $n = 1.58$ n : mold resin refractive index
 $r = 0.45$ r : radius
 $Cg = (h+g) \times \tan 30$
 $Rt = (h+g) \times \tan 30$
 g : thickness of light shield(recommended material : Silicon)
 $t \leq 0.7\text{mm}$ (recommended) t : thickness of panel

Fig.18 Recommended window size (With light shield)

1. The light shield is recommended to be set to decrease the reflected light from the window.
2. The light shield is recommended to be made by a black Silicon material that doesn't transmit infrared.
3. Even recommended window size may cause malfunction depending on the reflection from the panel.
In this case, it is effective to be extended the printing area between windows, but affects detection distance and ALS output.
4. Please confirm that there is no problem with an actual machine in consideration of the implementation gap, the misalignment of the windows and voltage variation.
5. The recommended transmissivity ($400\text{nm} \leq \lambda \leq 1100\text{nm}$) of the window is more than 85%.

13. Data (Reference)

13.1. LED drive peak current

13.1.1. LED drive peak current vs. VLED (Vcc=VLED)

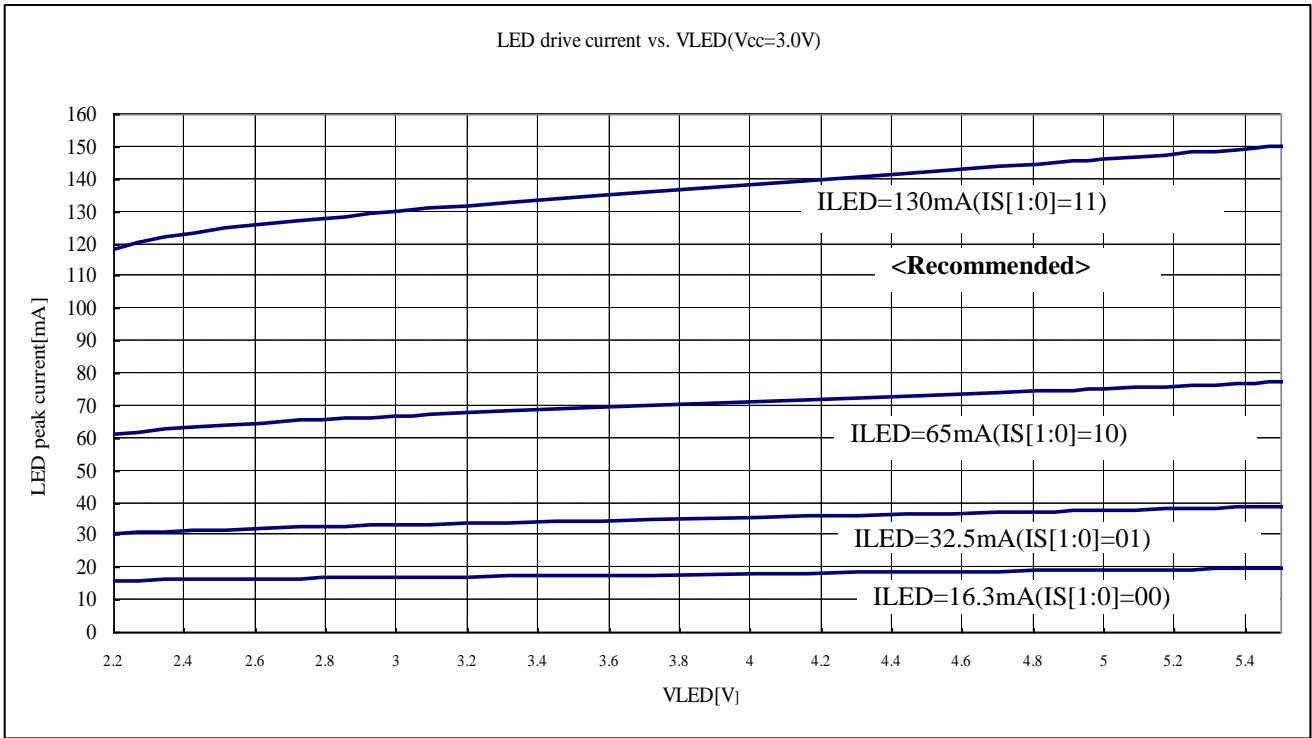

Fig.19 LED drive peak current vs. VLED

13.1.2. LED drive peak current vs. Vcc (VLED=3V)

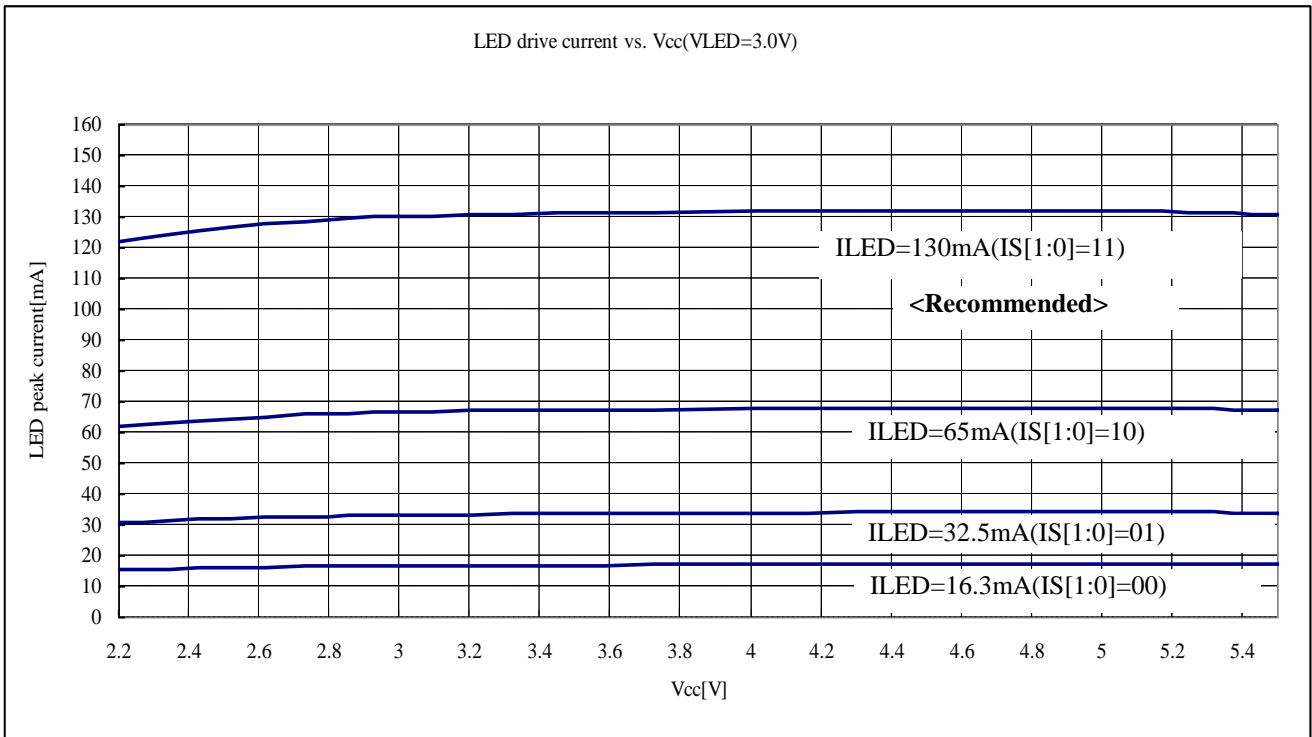

Fig.20 LED drive peak current vs. Vcc

13.2. Spectral Responsivity

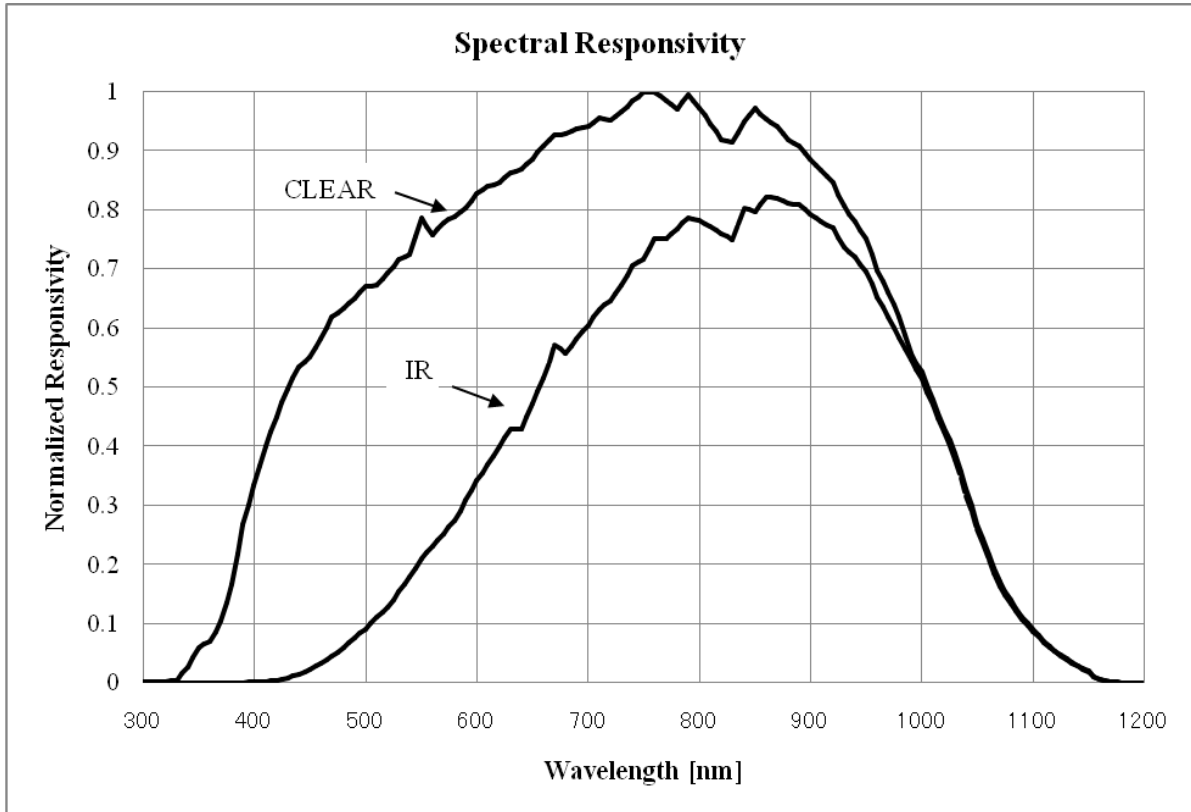

Fig.21 Spectral Responsivity

13.3. Proximity sensor (PS) mode

Sensor output counts vs. distance

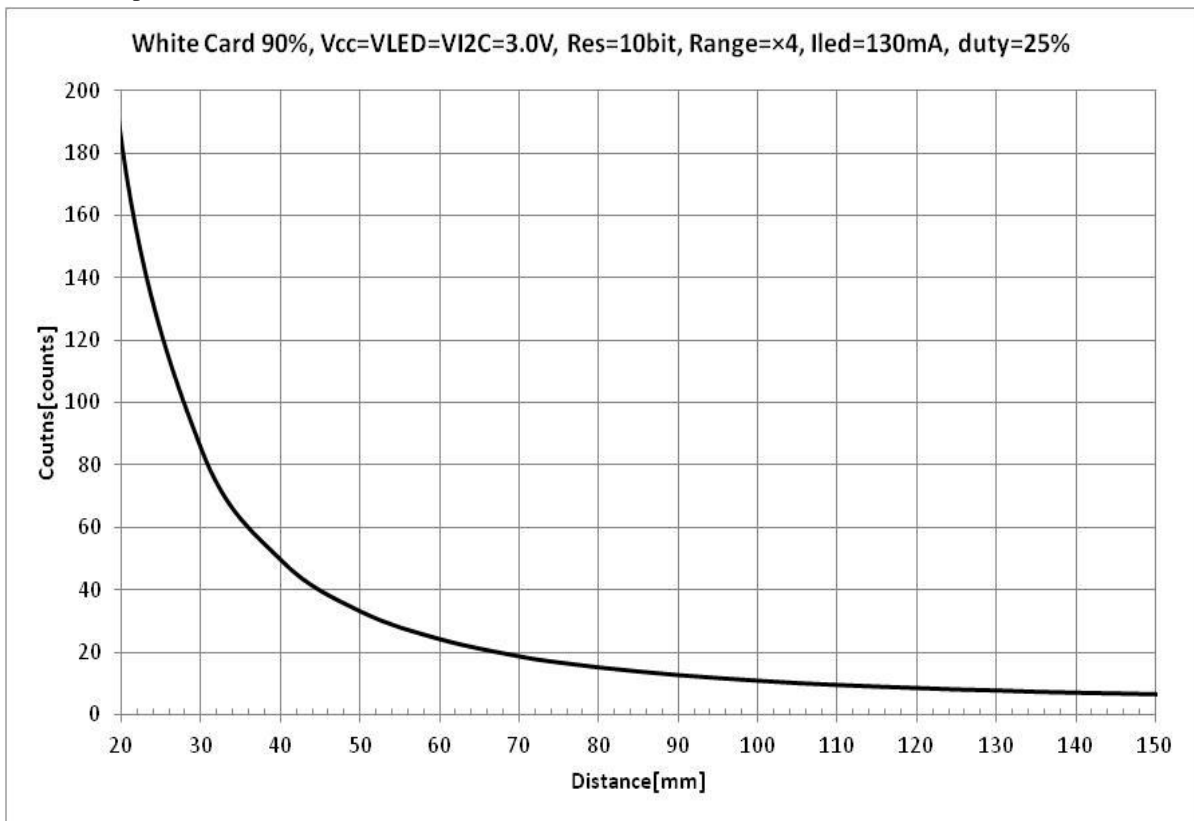

Fig22 Sensor output counts vs. distance