

Compact image sensor camera IV-S30 Series

Controller: IV-S31MX/S32MX/S33MX

User's Manual (Function and Operation)



Thank you for purchasing the SHARP IV-S30 compact image sensor camera (IV-S31MX/S32MX/S33MXcontroller). Read this introductory user's manual carefully to thoroughly familiarize yourself with the functions and proper procedures for operation.

Store this user's manual in a safe place. We are confident that the manual will be helpful whenever you encounter a problem.

In addition to this manual, there are two other IV-S30 (IV-S31MX/S32MX/S33MX controller) manuals as follows. Read them in conjunction with this manual.

- IV-S30 (IV-S31MX/S32MX/S33MX) — User's Manual (Introduction and Hardware: **This manual**)
 — User's Manual (Function and Operation)
 — Instruction Manual

Manual type	Major subjects	How to use
IV-S30 (IV-S31MX/S32MX/S33MX) User's Manual (Introduction and Hardware)	<ul style="list-style-type: none"> - Outline of the IV-S30 (features and functions) - Description of the hardware - Startup method - General performance specifications. - Example of operation and instruction 	<ul style="list-style-type: none"> - Become acquainted with the IV-S30 - Learn how to install the IV-S30 and wire it up - When mastering the outline of operation.
IV-S30 (IV-S31MX/S32MX/S33MX) User's manual (Function and Operation)	<ul style="list-style-type: none"> - Detailed explanations of all the measurement functions. - How to make menu selections for each measurement - Details of inputting and outputting data and communications with other devices. - Troubleshooting 	<ul style="list-style-type: none"> - Learn how to specify measurement /inspection conditions, good or NG judgment conditions, etc. - Learn how to connect a programmable controller or personal computer. - Learn what to do if a problem occurs.

Notes

- This manual was written with the utmost care. However, if you have any questions or inquiries concerning the product, please feel free to contact our dealers or service agents.
- Copying all or part of this booklet is prohibited.
- The contents of this manual may be revised or modified for improvement without prior notice.

Chapter 1: Setting and Operating Outline

Chapter 2: Setting the Operating and System Conditions

Chapter 3: Setting Measurement Conditions

Chapter 4: Positional Deviation Measurement

Chapter 5: Degree of Match Inspection

Chapter 6: Lead Inspection

Chapter 7: BGA/CSP Inspection (IV-S32MX/S33MX)

Chapter 8: Area Measurement by Binary Conversion

Chapter 9: Object Counting by Binary Conversion

Chapter 10: Object Identification by Binary Conversion

Chapter 11: Existence Inspection by Point Measurement

Chapter 12: Multiple Positional Measurement

Chapter 13: Multiple Degree of Match Inspection

Chapter 14: Distance and Angle Measurement

Chapter 15: Numerical Calculations

Chapter 16: PC Function

Chapter 17: Setting the Input/Output Conditions

Chapter 18: Communication (General Purpose Serial Interface)

Chapter 19: Computer Link

Chapter 20: Troubleshooting

Alphabetical Index

Table of Contents

Chapter 1: Setting and Operating Outline	1-1 to 30
1-1 Setting and operating procedures	1-1
1-2 Method for selecting the menu configuration	1-2
[1] Menu configuration	1-4
[2] Configuration of the setting conditions	1-5
[3] Configuration of Set Wizard	1-6
1-3 Description of the Operation screen	1-10
1-4 Setting the measurement programs	1-13
1-5 Common operations for each menu	1-14
[1] Operations to return to the operation screen	1-14
[2] Saving data	1-14
1-6 Power ON setting menu	1-15
[1] Operations menu lock	1-15
[2] Change the Japanese or English display mode	1-15
1-7 Remote keypad (IV-S30RK1)	1-16
1-8 Register and display NG images	1-17
[1] How to register NG images (IV-S32MX/S33MX)	1-17
[2] How to display NG images	1-19
[3] Initializing the NG images (IV-S32MX/S33MX)	1-23
1-9 Operation flow	1-24
[1] Power ON and main loop processing	1-24
[2] Operation flow after the measurement start input is turned ON	1-26
1-10 Table of controller functions	1-29
Chapter 2: Setting the Operating and System Conditions	2-1 to 2
2-1 Setting the operating conditions	2-1
[1] Monitor output	2-2
[2] Image capture	2-4
[3] Message display	2-5
[4] Pattern display	2-6
[5] Binary image display	2-7
[6] θ angle correction image display	2-8
[7] Operation main display	2-9
[8] Evaluation change display	2-10
[9] PC monitor screen	2-11
[10] Through display	2-11
[11] Extension functions	2-12
2-2 Setting the system conditions	2-14
[1] Manually setting the object type	2-14
[2] Gain/offset adjustment	2-15
[3] Setting the system time (IV-S32MX/S33MX)	2-16
2-3 Camera settings	2-17
[1] Camera selection (IV-S32MX/S33MX)	2-17
[2] Image capture mode (IV-S33MX)	2-18
[3] Camera synchronization (IV-S33MX)	2-19
2-4 Editing Operation screen	2-21
2-5 Option	22

Chapter 3 : Setting Measurement Conditions	3-1 to 41
3-1 Outline	3-1
3-2 Shared settings	3-4
[1] Camera selection	3-4
[2] Window shape selection and settings	3-5
[3] Image settings	3-10
[4] Evaluation conditions	3-18
[5] Image pre-processing	3-20
[6] Image adjustment	3-25
[7] Binary image mask	3-26
[8] Position correction	3-31
[9] Title registration	3-34
3-3 Input & Output / System settings	3-35
[1] Illuminance (light level) monitor	3-35
[2] Setting the shutter speed	3-37
[4] NG image registration (IV-S32MX/S33MX)	3-39
[5] Halt on NG measurement	3-40
 Chapter 4: Positional Deviation Measurement	 4-1 to 13
4-1 Outline	4-1
4-2 Setting operation	4-2
[1] Set the register conditions for a gray search	4-4
[2] Setting the register conditions for edge detection	4-7
 Chapter 5: Degree of Match Inspection	 5-1 to 9
5-1 Outline	5-1
5-2 Setting operation	5-2
 Chapter 6: Lead Inspection	 6-1 to 8
6-1 Outline	6-1
6-2 Setting operation	6-2
 Chapter 7: BGA/CSP Inspection (IV-S32MX/S33MX)	 7-1 to 8
7-1 Outline	7-1
7-2 Setting operation	7-2
 Chapter 8: Area Measurement by Binary Conversion	 8-1 to 9
8-1 Outline	8-1
8-2 Setting operation	8-2
 Chapter 9: Object Counting by Binary Conversion	 9-1 to 8
9-1 Outline	9-1
9-2 Setting operation	9-2
 Chapter 10: Object Identification by Binary Conversion	 10-1 to 9
10-1 Outline	10-1
10-2 Setting operation	10-2
 Chapter 11: Existence Inspection by Point Measurement	 11-1 to 9
11-1 Outline	11-1
11-2 Setting operation	11-2

Chapter 12: Multiple Positional Measurements	12-1 to 11
12-1 Outline	12-1
12-2 Setting operation	12-2
[1] Set the register conditions for a gray search	12-5
[2] Setting the register conditions for edge detection	12-7
Chapter 13: Multiple Degree of Match Inspection	13-1 to 8
13-1 Outline	13-1
13-2 Setting operation	13-2
Chapter 14: Distance and Angle Measurement	14-1 to 8
14-1 Outline	14-1
14-2 Setting operation	14-2
Chapter 15 Numerical Calculations	15-1 to 15
15-1 Outline	15-
15-2 The individual numerical calculations for each measuring program	15-1
15-3 Final numerical calculations	15-9
15-4 Setting examples	15-11
Chapter 16: PC Function	16-1 to 18
16-1 Outline	16-1
16-2 Operation cycle	16-1
[1] Power ON sequence	16-2
[2] PC scan cycle	16-2
[3] Measurement processing cycle	16-2
16-3 Ladder circuit program creation	16-3
[1] Procedure for creating measurement output condition and a ladder circuit	16-3
[2] A list of the "OUTPUT COND" screen displays	16-9
[3] Procedure for creating the final output conditions in a ladder circuit	16-11
16-4 Program examples (shape and positional deviation inspection)	16-16
16-5 Examples of a final output conditions ladder circuit	16-17
16-6 PC monitor screen	16-18
Chapter 17: Setting the Input/Output Conditions	17-1 to 32
17-1 Outline	17-1
17-2 Measurement start input and result output settings	17-5
17-3 CCD trigger	17-18
[1] Outline	17-18
[2] Setting procedure	17-18
17-4 Setting for serial communications	17-21
17-5 Computer link	17-22
17-6 Output block assignment (Computer link output and general purpose serial output)	17-23
[1] Data in specified blocks	17-23
[2] Setting (operating) procedure	17-24
17-7 Setting the data output	17-26
[1] Select "ANY" for the serial output	17-26
[2] Select "YES" or "NO" for output data	17-27
17-8 Calibrating the IV-S30	17-28

Chapter 18: Communication (General Purpose Serial Interface) 18-1 to 17

18-1 List of processing functions 18-1
18-2 Data flow 18-3
 [1] Measurement execution 1: Command codes 10, 11, or 12 18-3
 [2] Measurement execution 2: Response processing for command 11 18-3
 [3] Measurement execution 3: Command 14 18-4
 [4] Processing other than measurement execution processing 18-4
18-3 Communication format 18-5
18-4 Processing functions 18-7
 [1] Measurement execution functions 18-7
 [2] Result reading 18-9
 [3] Setting, initialization, and diagnosis of the operation screen 18-12
 [4] Setting numerical data of the any output measuring 18-16

Chapter 19: Computer Link 19-1 to 35

19-1 Compatible models 19-1
19-2 Data flow 19-2
19-3 Register setting 19-3
19-4 Measurement data blocks 19-5
 [1] Number of blocks 19-5
 [2] Contents of the measurement result block (for each measurement function) 19-6
19-5 Specifications for any output data 19-17
19-6 Interface 19-20
 [1] Setting items for the IV-S30 19-20
 [2] Connection with a Sharp PC 19-21
 [3] Connection with a Mitsubishi PC 19-27
 [4] Connection with an OMRON PC 19-30
19-5 Program examples 19-32

Chapter 20: Troubleshooting 20-1 to 6

[1] Symptoms and checks 20-1
[2] Causes of termination codes (when an error occurs) and remedies 20-3
[3] Maintenance 20-6

Alphabetica Index I-1 to 8

Chapter 1: Setting and Operating Outline

1-1 Setting and operating procedures

This paragraph describes the rough operation sequence of the IV-S30.

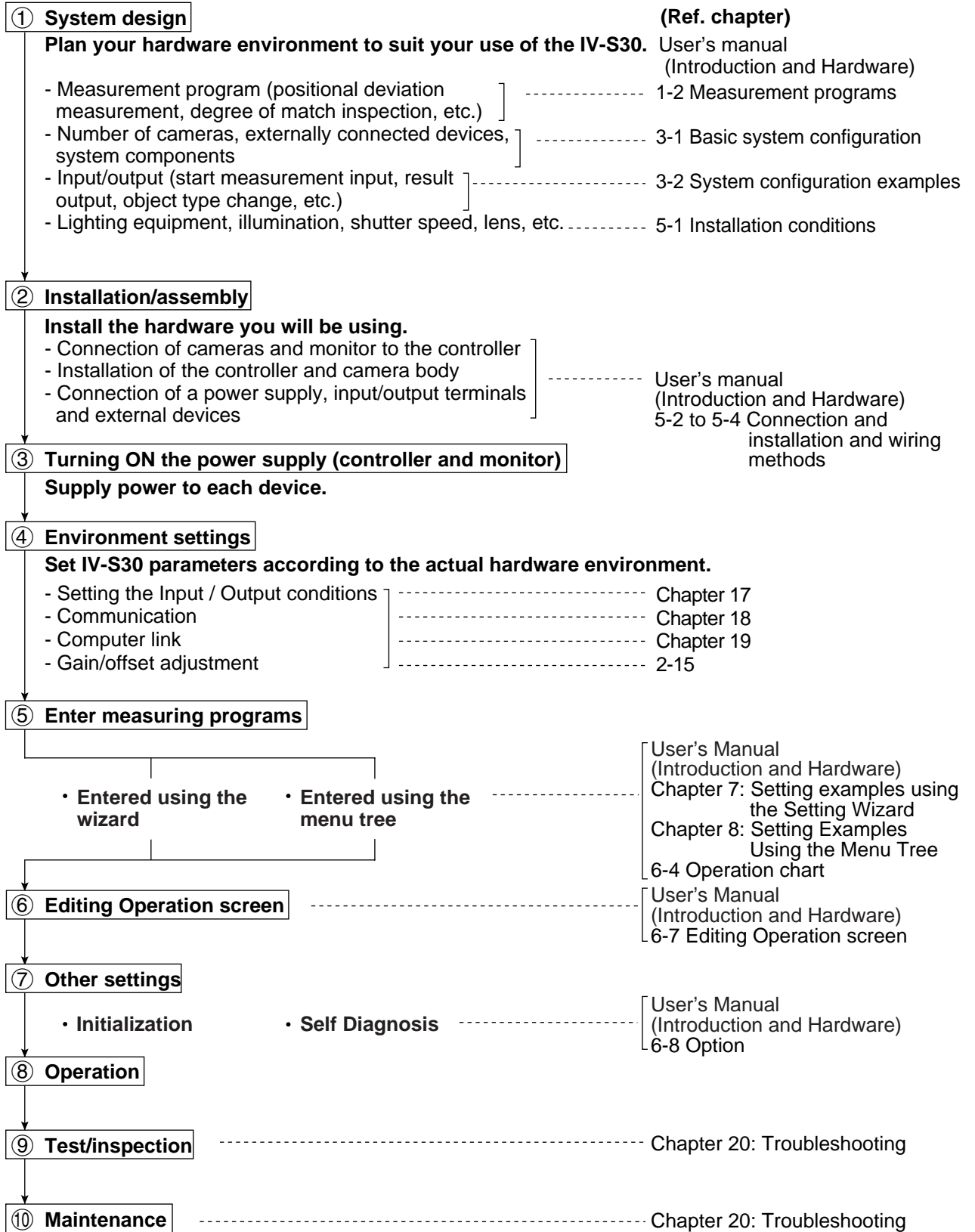

1-2 Method for selecting the menu configuration

(1) Set wizard

The IV-S30 has a "Set Wizard" function to assist beginners in setting the measurement conditions.

Select "SET WIZARD" from the "MAIN MENU" and the wizard will show the items needed for each step. You only need to make selections according the instructions on the screen. Using the wizard, you can establish the minimum required settings for making measurements.

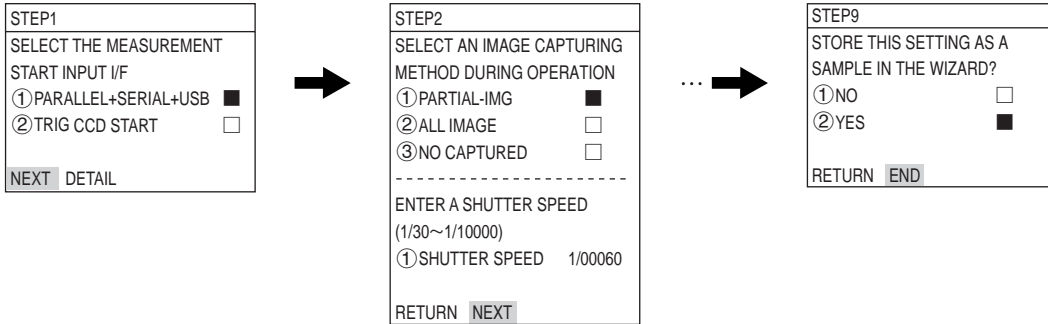
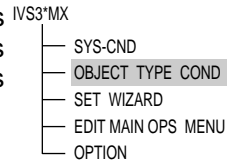

The steps that the set wizard takes you through are displayed as lists on the "operation chart." At any point you can return to the previous step to make a change if you want to.

- TYPE00
- Start
- STEP1:PARALLEL+SERIAL+USB
- STEP2:CAPTURE IMG/PARTIAL-IMG
- STEP3:MEAS1/CAM1
- STEP4:MEAS1/BIN-AREA
- STEP5:MEAS1/WINDOW/MASK,1
- STEP6:MEAS1/MEAS CND
- STEP7:MEAS1/EVALUATION
- STEP8:MEAS1/CALC
- STEP9:MEAS1/OUT
- STEP10:FINAL NUMERIC CALC
- STEP11:FINAL OUTPUT COND
- STEP12:
- STEP13:OUT/SERIAL OUTPUT
- STEP14:OPS MENU COND
- STEP15:
- STEP16:
- STEP17:TITLE/YES
- End

Wizard

The "Wizard" is a program that helps users make settings for measurement operations easily and without making mistakes. The controller asks you a series of questions at each step and you simply answer these to complete the settings.

The wizard is convenient for making settings when beginners and inexperienced operators are operating the machine. However, operators who are familiar with the operation may save a lot of time by using other setting methods.

(2) Menu tree

The IV-S30 has a menu tree which is shown the hierarchy of choices on each screen. To return to the previous screen or go to next screen, select the corresponding item on the menu tree.

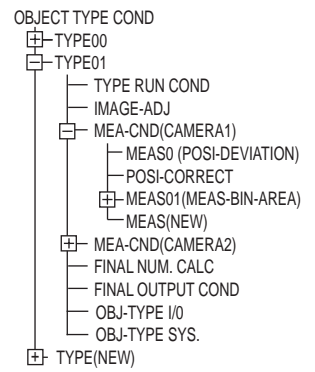

How to enter the menu tree

On the "MAIN MENU" select "OBJECT TYPE COND" to enter the menu tree.

⊕ and ⊖ mean that a sub menu is available inside the menu.

Select ⊕ and press the SET key or the right arrow key, the next level of menu will be opened.

When ⊖ is shown, it means that the lower menu level is already open.

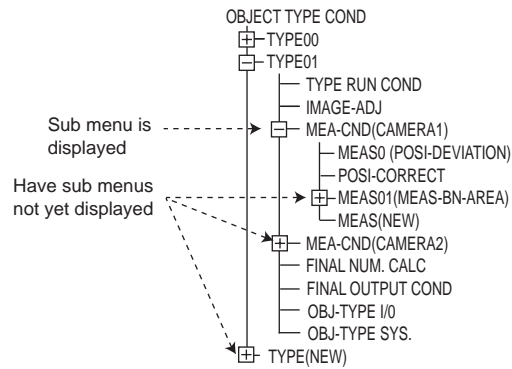
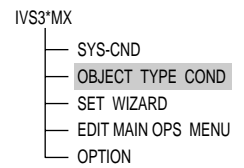

1

[1] Menu configuration

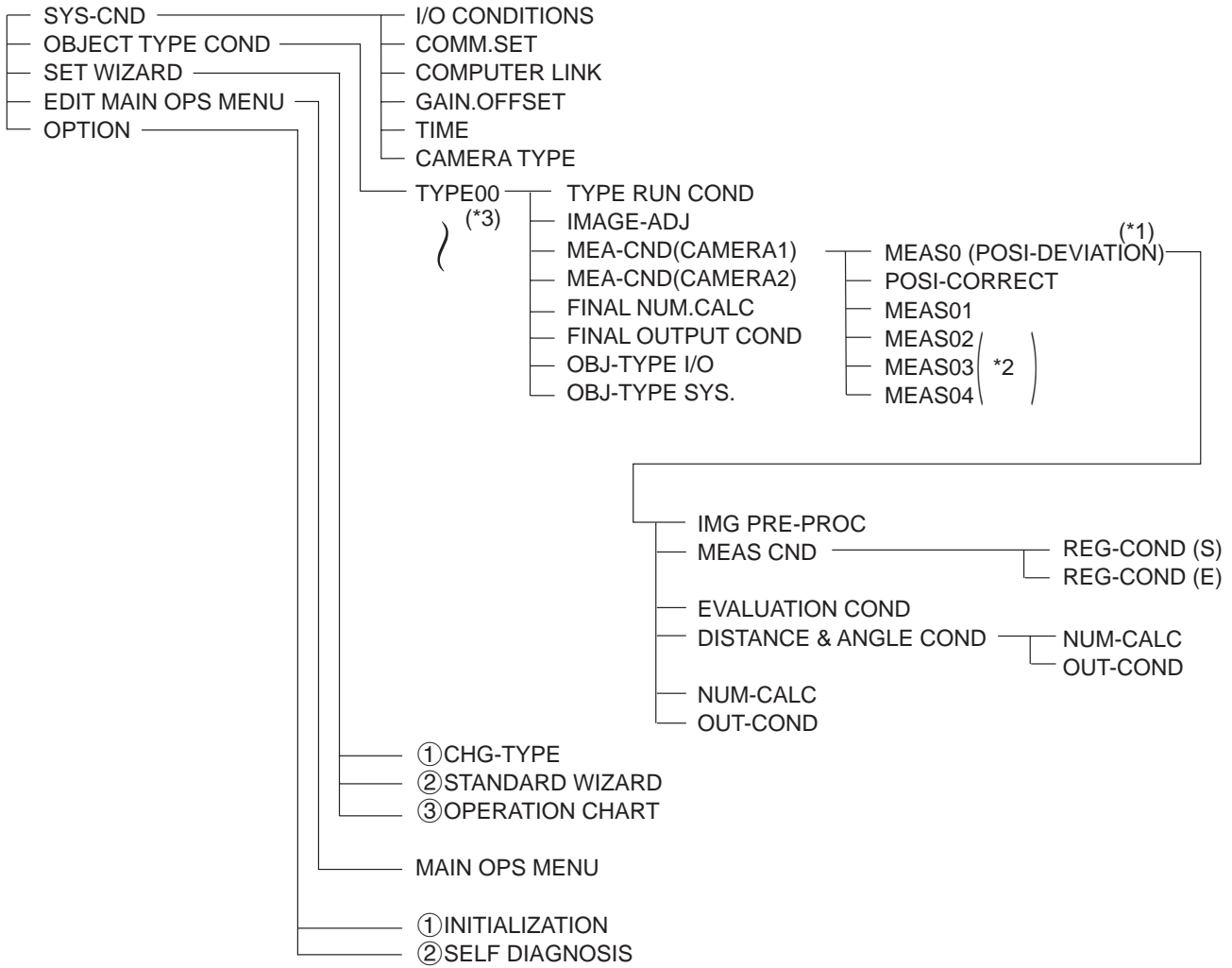

*1: MEAS0 is only for making for "positional deviation measurements."
 *2: MEAS01 to 04 can be set to make any type of measurement from "positional deviation measurements" to "multiple degree of match inspections."
 *3: Maximum 16 object types (IV-S31MX), or 32 object types (IV-S32MX/S33MX) can be registered.

[2] Configuration of the setting conditions

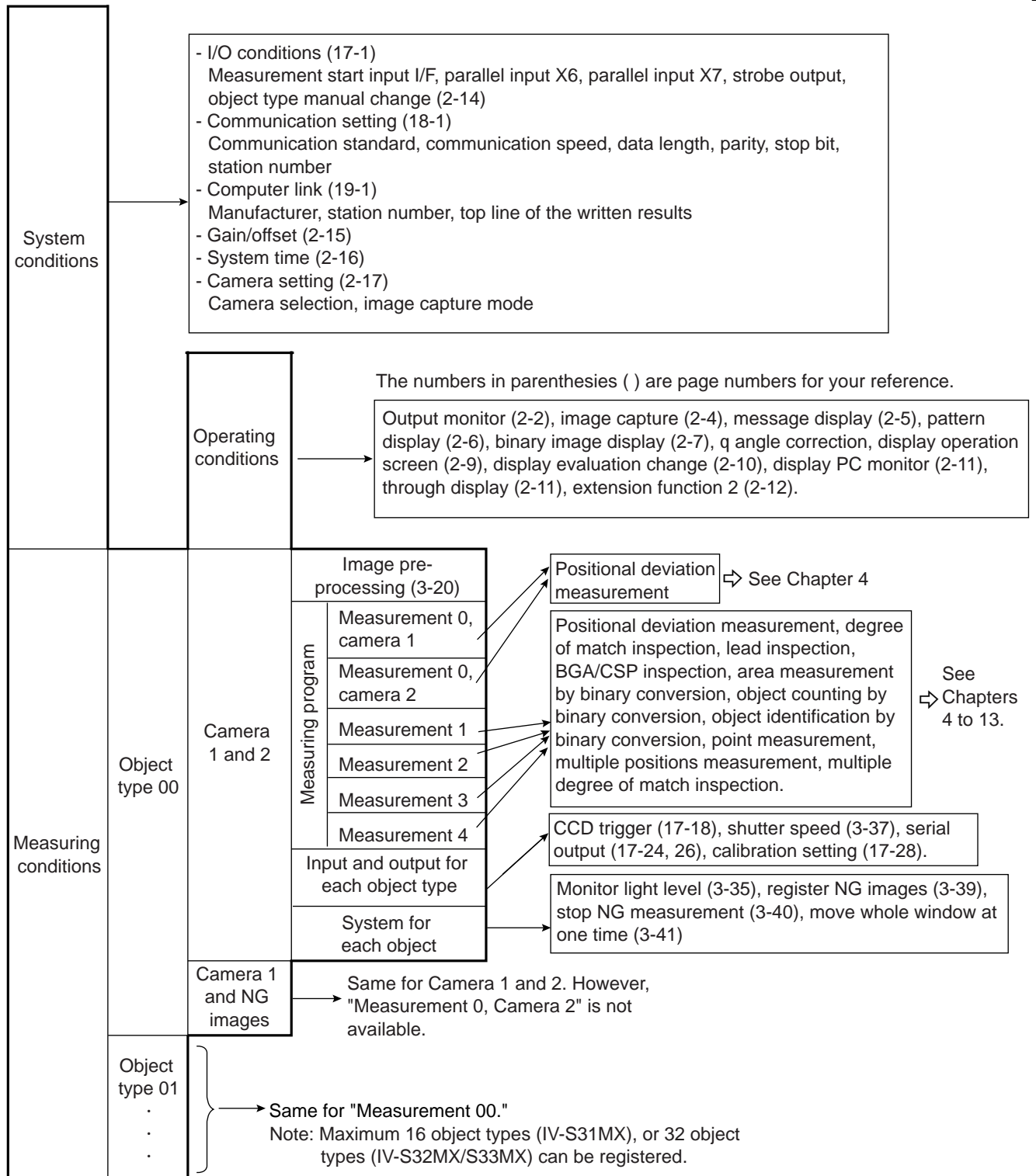

[3] Configuration of Set Wizard

The Set Wizard has the following screen configuration.

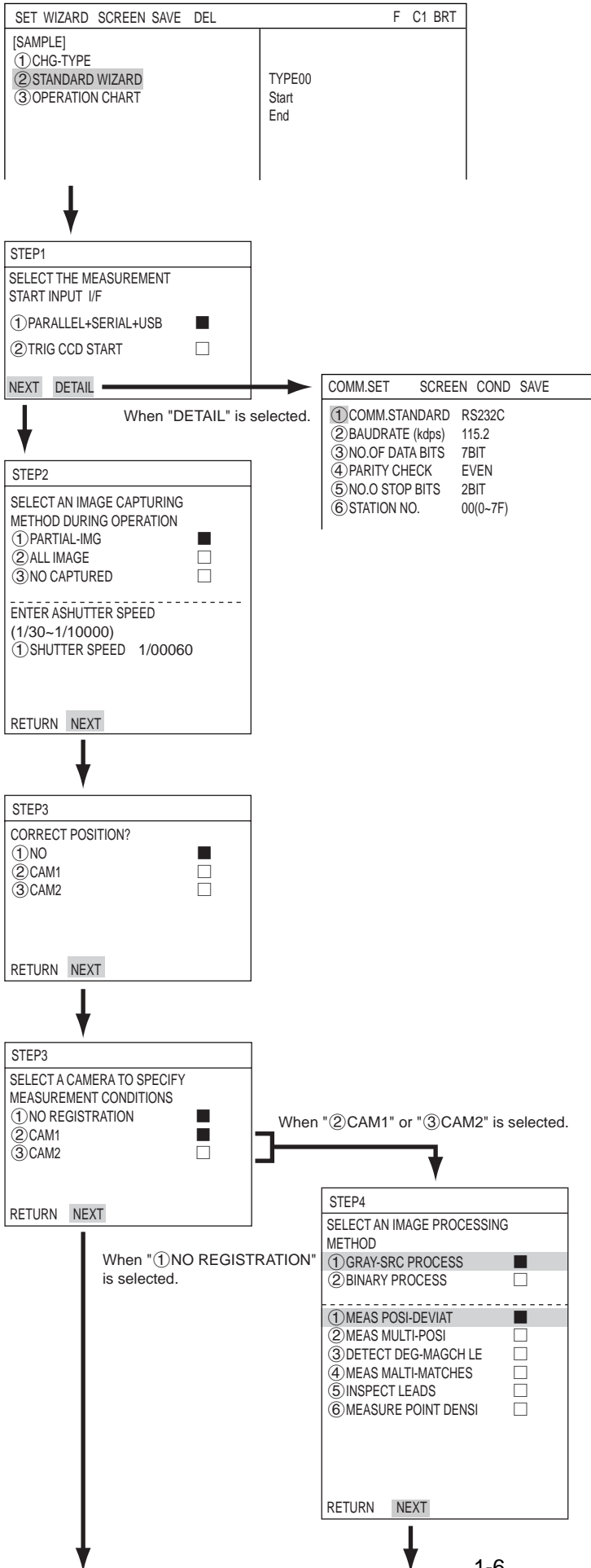

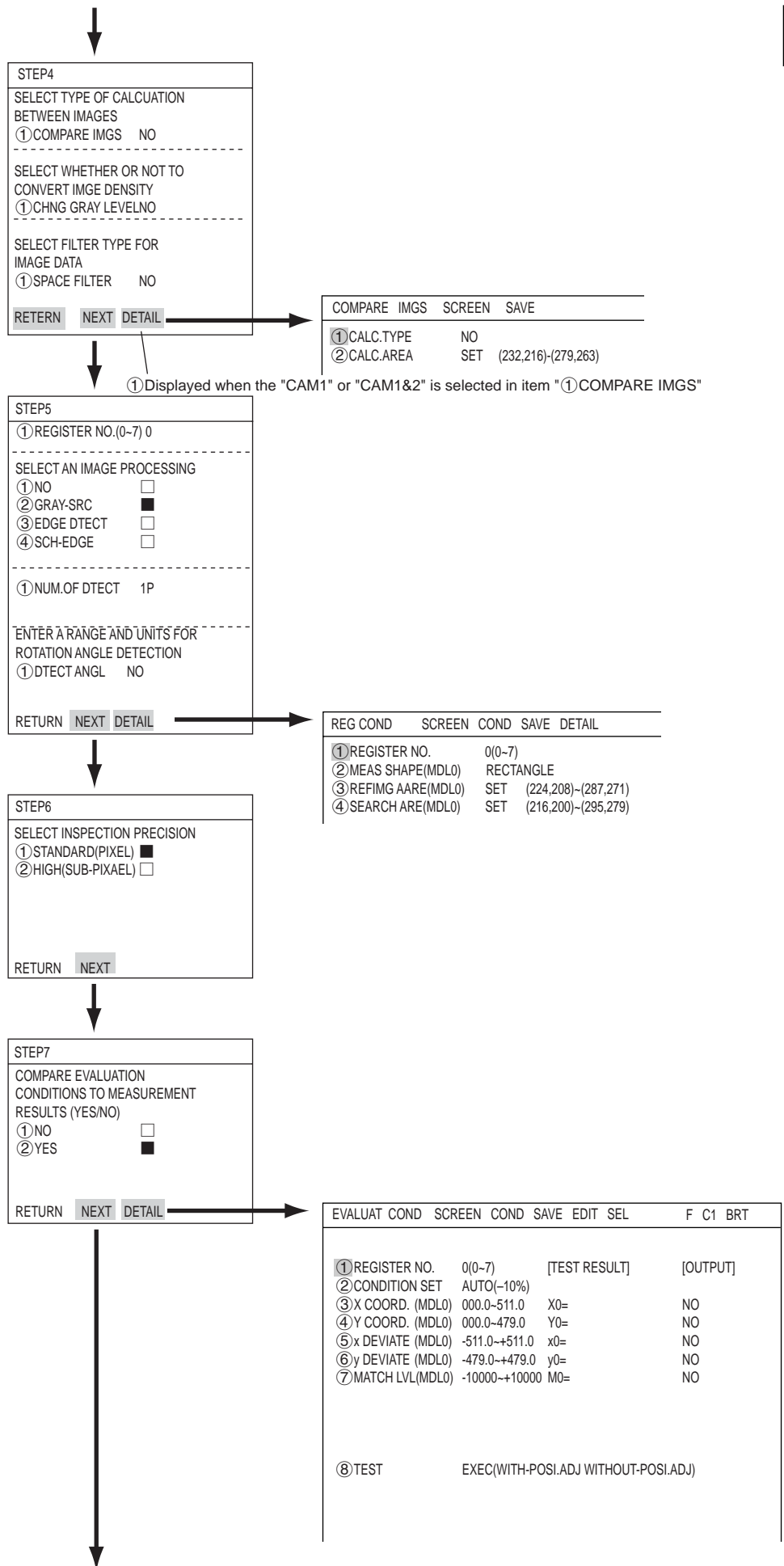

1

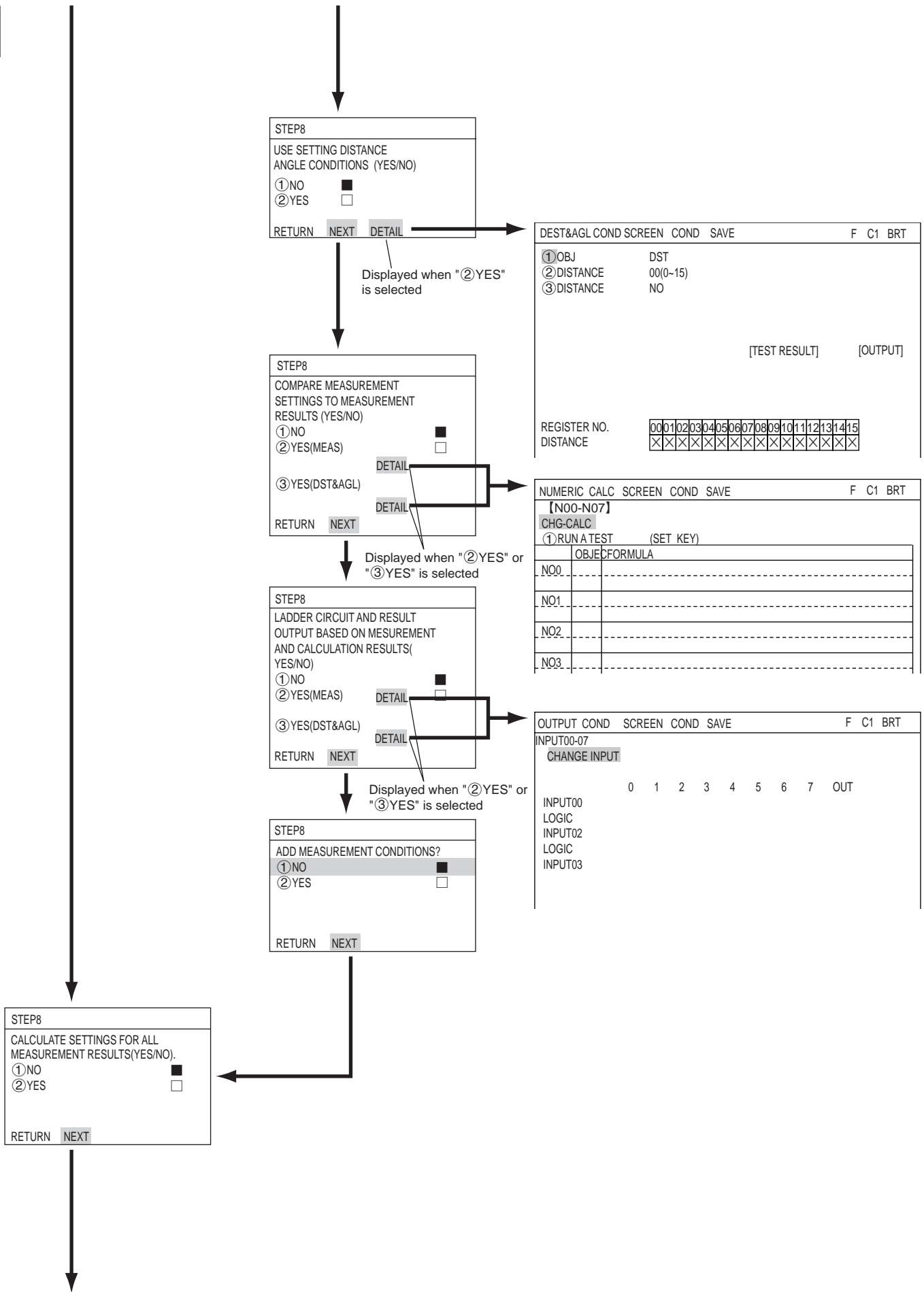

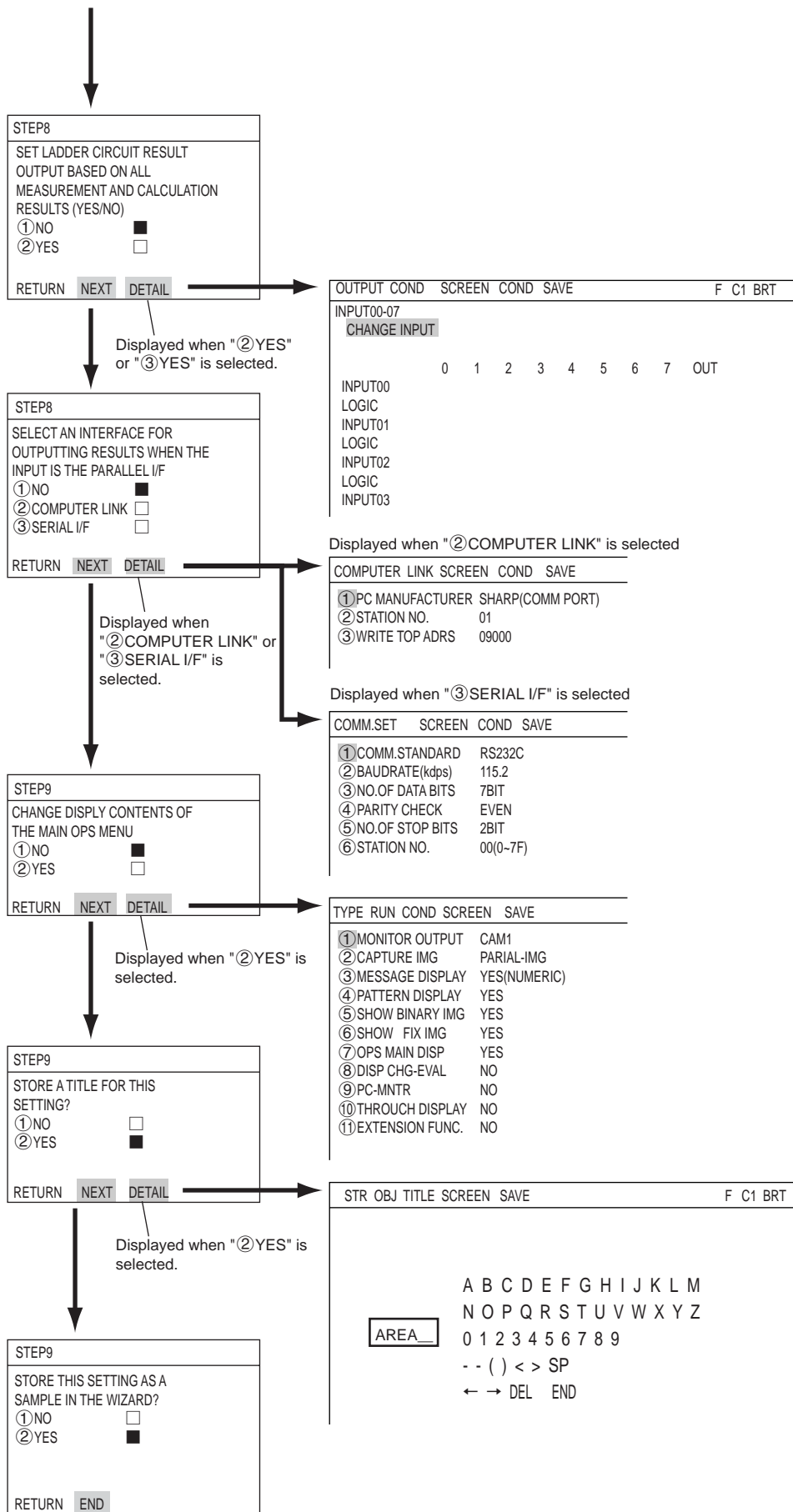

1-3 Description of the Operation screen

When the IV-S30 is started, the operation screen shown below will appear. Each area of the operation screen is described below.

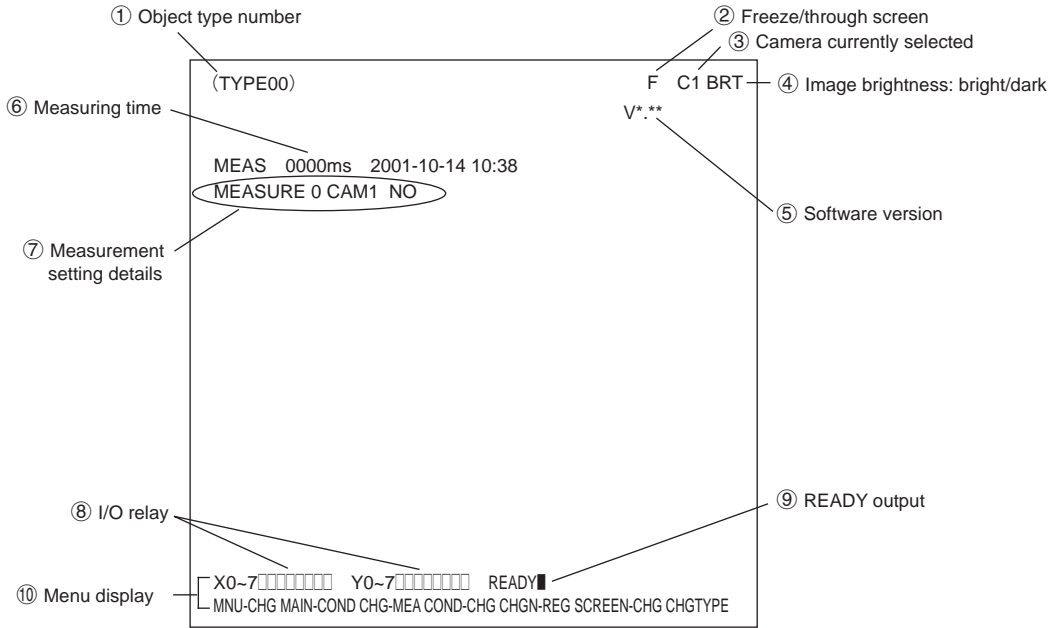

① Displays the number of the currently selected object. (Object numbers can range from 00 to 15 for the IV-S31MX and from 0 to 31 for the IV-S32MX/S32MX.)

② Select whether to display captured images on the screen as freeze images or through images.

Display method	Description
Through image	- Displays the stream of images captured by the camera. - Used for adjusting the camera focus and image properties.
Freeze image	- Displays the single image captured at the start of making measurements. - Used to set each of the measurement conditions and operating conditions.

To switch the image between "Through" and "Freeze" modes, press the SEL key on the remote keypad, and then press the up and down arrow keys.

③ Indicates which camera is currently selected
 C1: Camera 1 (the camera connected to the "CAMERA1" connector)
 C2: Camera 2 (the camera connected to the "CAMERA2" connector)

④ The brightness of the captured image can be set to one of two levels.

Screen display	Description
Bright	Display the captured image without changing its brightness.
Dark	Display the captured image at 1/2 the actual brightness

How to select the brightness level

On any screen, except the operation screen, move the cursor to the "F" (freeze) or "T" (through) position on the upper part of the screen by pressing the SEL key. Then, press the left or right arrow key to move the cursor to the "BRT" (bright) or "DRK" (dark) indicator. Press the up or down arrow key to switch between bright and dark.

- ⑤ Displays the software version.
- ⑥ Displays the measurement time currently assigned.

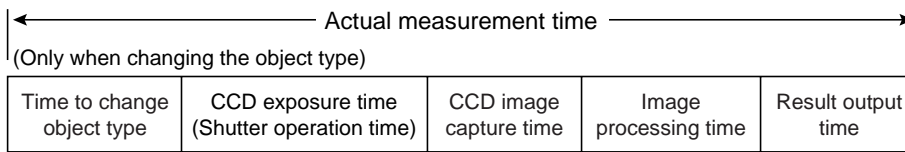

- Serial communication time is not included.
- Set the controller as follows to reduce the measurement time.
 1. Increase the shutter speed.
 2. Select the "partial" image capture feature for the CCD.
 3. Select "NO" for the measurement results display (message display, pattern display, and binary image display).

- ⑦ Display setting details of each measurement.

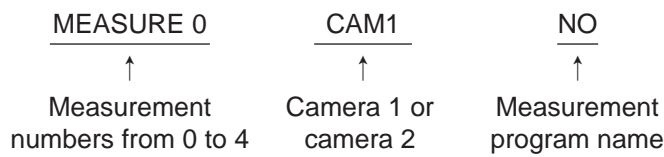

- ⑧ Displays the status of input relays X0 to X7: OFF [], ON [].
Displays the status of output relays Y0 to Y7: OFF [], ON [].
- ⑨ Displays the status of the ready output: OFF [], ON [].
- ⑩ The menu bar at the bottom has two rows. When this menu is selected, the second row will appear.

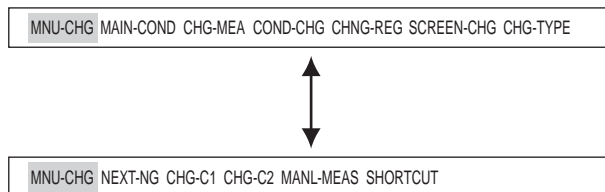

The details of each item on this menu bar are shown on the next page.

■ Details of each item on the menu bar

Item on the menu bar	Description	Display detail on the screen
MAIN-COND (main conditions)	Displays the MAIN screen.	
CHG-MEA (Change measurement)	Press the up and down arrow keys to change the display of the evaluation results for each measurement number. (Measurement 0 camera 1 -> measurement 0 camera 2 -> Measurement 1 -> Measurement 2 -> Measurement 3 -> Measurement 4)	
COND-CHG (Change the measurement conditions)	Displays the condition change selection list. Change the conditions that get displayed by pressing the up and down arrow keys. For details about the measurement conditions, see pages 8-3 and 8-8 in Introduction and Hardware and Chapter 3 in this manual. For details about the distance and angle conditions, see page 14-2 in this manual. For details about the numeric value calculation conditions, see page 15-7 in this manual.	
CHNG-REG (change registration)	Change the display of the set of stored details between [A00] - [A07] and [A08] - [A15] using the up and down arrow keys	
SCREEN-CHG (change screen)	Displays the screen change selection list. Select a screen using the up and down arrow keys. Note: The OPS-MAIN, JDG-COND-CHG, and PC-MNTR do not appear on the popup menu unless "YES" is selected for each corresponding item on "TYPE RUN COND" menu. Only the currently available screens are listed. When an NG image is stored, "NG-IMG-DISP" can be selected. Press the SET key and the monitor will change to the NG image display screen.* ⇒ See page 1-22 in this manual	
CHG-TYPE (change the object type)	Displays the object type selection list. Select an object type by pressing the up and down keys. This is enabled when Manual Object Type Change is set to "YES."	
NEXT-NG * (change the NG image)	List the NG screens that can be selected. Select a screen using the up and down keys.	
CHG-C1 (change the Camera 1 image position)	Moves the image from Camera 1 up and down the screen using the up and down arrow keys. Note: This is enabled when "CAM1&2" or "CAM1&NG IMG" is selected in ①MONITOR OUTPUT on the TYPE RUN COND menu (operating conditions).	
CHG-C2 (change the Camera 2 image position)	Moves the image from Camera 2 up and down the screen using the up and down arrow keys. Note: This is enabled when "CAM1&2" or "CAM1&NG IMG" is selected in ①MONITOR OUTPUT on the TYPE RUN COND (operation conditions).	
MANL-MEAS (Manual measurement)	Manually move the two crosshair cursors, and measure distance between these two points, as well as coordinate distance on X and Y axes. Note: Unless "MANL-MEAS" is selected on the "①EXTENSION FUNC" line in the TYPE RUN COND (operation conditions), this screen cannot be displayed.	
SHORTCUT	Displays a short cut screen.	<p style="text-align: right;">【PLACE】</p>

* Only the IV-S32MX/S33MX can display and use this function

1-4 Setting the measurement programs

To execute a specific measurement program (positional deviation measurement, degree of match inspection, etc.), select MEASUREMENT 0 to 4 on the "MEA-CND" line.

- MEASUREMENT 0 only allows you to measure positional deviation.
- For details about the settings for each measurement program, see Chapters 4 to 14.
- Specify the conditions for distance and angle measurement in the positional deviation measurement, the degree of match inspection, object identification by binary conversion (MEAS GRAV CENTR: YES), multiple position measurement, and for multiple degree of match inspection.

(1) Operation main screen (see page 1-10).

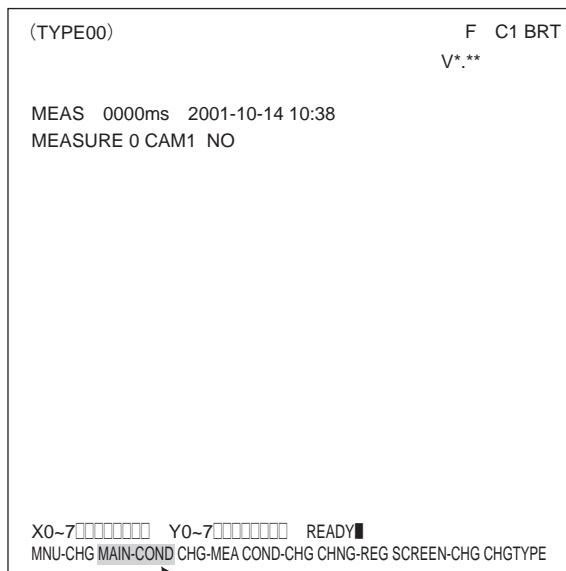

Move the cursor to the "MAIN COND" item using the left and right arrow keys and press the SET key.

(2) Select the "OBJECT TYPE COND" using the up and down arrow keys and press the SET key.

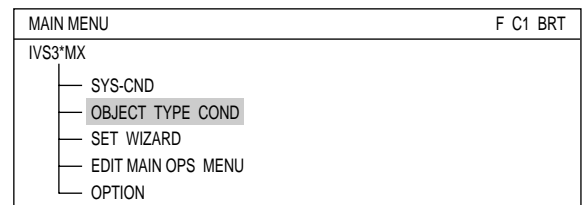

(3) Move the cursor to the "TYPE(NEW)" item on the "OBJECT TYPE COND" line and press the SET key.

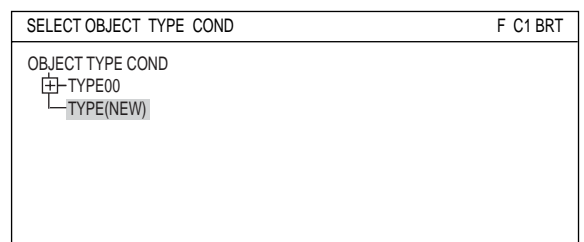

(4) Move the cursor to "TYPE00" on the "SELECT OBJECT TYPE COND" line and press the SET key. To select "TYPE01" and others, move the cursor to "TYPE(NEW)" and press the SET key.

(5) Select "MEAS0 to 4" (MEAS0 is only used for positional deviation measurements) on the "MEAS COND (CAM1)" line and a popup menu will appear. Select any desired measurement program from this popup menu and then press the SET key.

1-5 Common operations for each menu

[1] Operations to return to the operation screen

You can return to the operation screen, MAIN MENU, or setting screen from any menu by a single operation.

■ Menu display

[TYPE RUN COND] menu

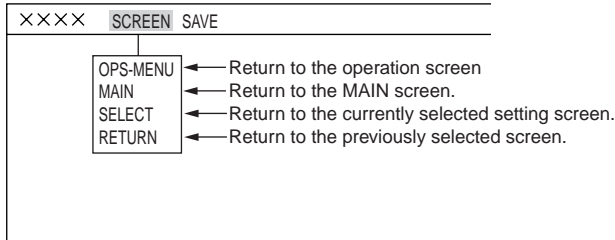

[2] Saving data

All of the data such as measurement and evaluation conditions entered on the "TYPE RUN COND," "MEA-CND," and "SYSTEM COND" menus, can be saved into the IV-S30 flash memory.

■ Operation procedure

[SYS-CND] menu

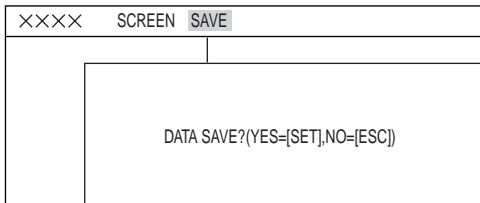

- On each menu screen, move the cursor to "SAVE" using the up/down and left/right keys, and press the SET key.
 - The following message will be displayed on the lower part of the screen.

DATA SAVE? (Do you want to save the data?) (YES=[SET]/NO=[ESC])

- Press the SET key.
 - The IV-S30 will start saving the data and the progress will be displayed on the bottom of the screen.

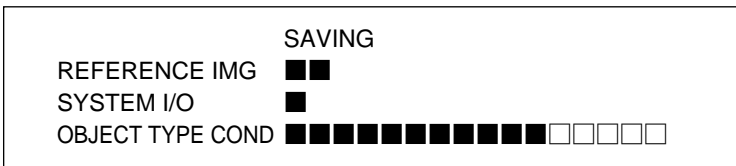

When the data has been saved in the IV-S30 flash memory, the display will change from "SAVING" to "COMPLETE SAVE."

1-6 Power ON setting menu

[1] Operations menu lock

To prevent accidental changes to conditions you have set, the operation screen can be locked so that the screen cannot be changed to setting screen. The operation can only be carried out on the [POWER ON SETTING] menu.

■ Display procedure

Follow the procedure described below when turning ON the power to the controller (IV-S31MX/S32MX/S33MX), and the [POWER ON SETTING] menu will be displayed on the monitor.

1. Turn ON the power to the IV-S30 controller, while holding down the ESC key.
2. Keep pressing the ESC key down for approx. 9 sec., after turning ON the power and the menu will be displayed.

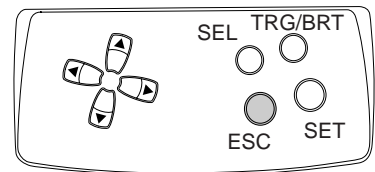
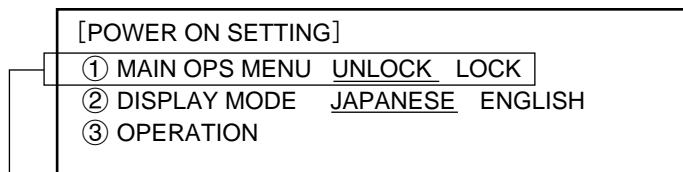

① MAIN OPS MENU	Description
UNLOCK	All of the operating conditions for the IV-S30 can be changed.
LOCK	The MAIN OPS MENU is locked and no change can be made.

■ Operation procedure

1. On the [POWER ON SETTING] menu, move the cursor to item "①MAIN OPS MENU" with the up and down keys, and press the SET key.
 2. Move the cursor to "UNLOCK" or "LOCK" with the left and right keys, and press the SET key.
 3. Move the cursor to item "③OPERATION" with the up and down keys, and press the SET key. Press the SET key once more.
- ⇒ The IV-S30 saves the settings in the flash memory and the screen will return to the operation screen.

■ Display when the operation screen is locked

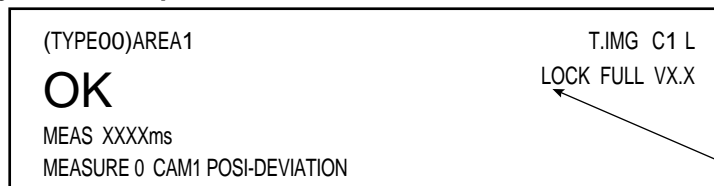

"LOCK" will be displayed on the MAIN OPS MENU

[2] Change the Japanese or English display mode

Change display between Japanese and English. Use the [POWER ON SETTING] menu for the selection.

■ Display procedure

Follow the procedure described below when turning ON the power to the controller(IV-S31MX/S32MX/S33MX), and the [POWER ON SETTING] menu will be displayed on the monitor.

1. Turn ON the power to the controller, while holding down the ESC key.
2. Keep pressing the ESC key down for approx. 9 sec., and the following menu will be displayed.

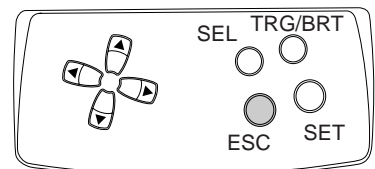
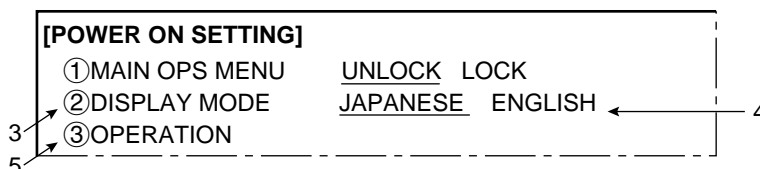

■ Operating procedure

3. Move the cursor to item "②DISPLAY MODE" (display mode) with the up and down keys, and press the SET key.
 4. Move the cursor to "JAPANESE" or "ENGLISH" with the left and right keys.
 5. Move the cursor to "③OPERATION" using up and down keys and press the SET key. Then, again press the SET key.
- ⇒ The screen will change to operation screen.

1-7 Remote keypad (IV-S30RK1)

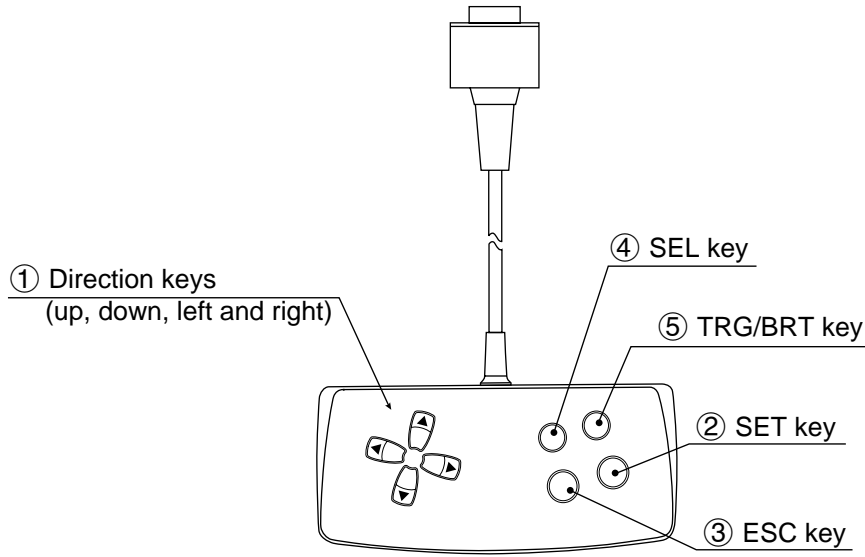

Key name	Function	Description
① Direction keys* (up, down, left and right)	Selecting an item on a menu screen	Select an item with the up, down, left and right keys.
	Setting a window	Set each coordinate.
	Setting a value	- Select a digit or an item with the left and right keys, and then specify a value with the up and down keys. - Specify a value with the up, down, right and left keys.
	To enter nested menus	_____
② SET key	Determine a highlighted item	_____
	Determine the setting value	_____
③ ESC key	Returning a setting to its original state before being changed	On the REG-COND screen, - Press the left arrow key + ESC key to change between a display of all items and just one item at a time.
	Returning to the previous menu	
④ SEL key	Use to select the display of object images: choose between "F" (Freeze) and "T" (Through) and between "BRT" (bright) and "DRK" (dark).	- When the screen is changed from "Through" to "Freeze," the IV-S30 will capture an image. - Change the brightness of the image displayed on the screen. On the setting screen, - Press the left arrow key and the SEL key to change between Through and Freeze. - Press the right arrow key and the SEL key to change between Bright and Dark.
⑤ TRG/BRT key	Start measurement input	Press this key on the run screen, and a new measurement is triggered.
	Move the cursor to the function menu at the upper area.	_____
	Displays popup menu.	

* The direction keys have an auto-repeat function.

1-8 Register and display NG images

NG image refers to any image that the controller has determined to be unacceptable after making the measurements.

- NG images are registered in the controller's memory. By replaying the NG images, you can review the points with problems.

This section describes how to register, display, and initialize NG images. Depending on type of the controller (IV-S31MX/S32MX/S33MX) you are using, some settings are not available.

Item			IV-S31MX	IV-S32MX	IV-S33MX	Reference page
Register NG images			.	○	○	1-17
NG images display	MAIN OPS menu screen	Display when an NG image occurs	○*	○*	○	1-19 to 1-21
		Display history	.	○*	○	1-21
	NG image display screen		.	○	○	1-22
Initialize NG images			.	○	○	1-22

* The left and right split screen display is not available using the monitor output.

[1] How to register NG images (IV-S32MX/S33MX)

When the IV-S32MX/S33MX is used, select "YES" for NG image registration. NG images will be registered in the controller's memory as they occur.

To make this setting, select "①REGST NG IMG" on the [OBJ-TYPE SYS.] menu.

⇒ See page 3-39.

● NG screen setting procedure

On the "SELECT OBJECT TYPE " screen, select "MEA-CND (CAMERA2)" and press the TRG/BRT key. From the popup menu, select "NG IMGS" and press the SET key.

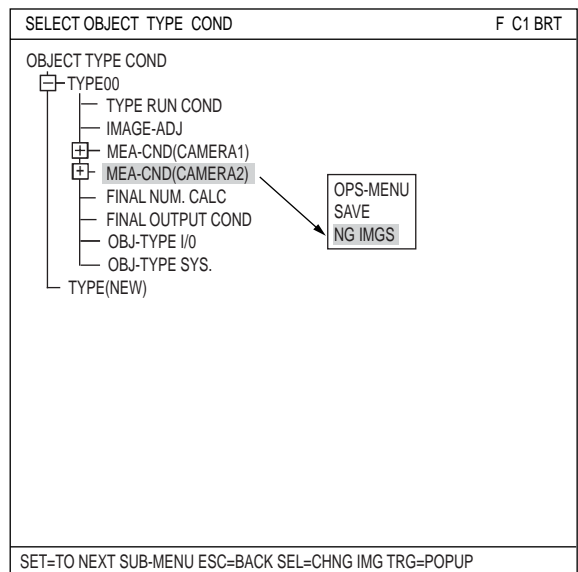

When the message shown on the right appears, press the SET key.

BY CHANGING A SETUP, THE CONTENTS OF SETTING IN A CAMERA 2 WILL BE INITIALIZED. DO YOU CHANGE IT?

YES=SET, NO=ESC

1

The "MEA-CND (CAMERA2)" item will change to "MEA-CND (NG IMGS)," and show that the NG image function has been selected.

- Up to 128 NG images can be registered at one time (the NG image numbers are 0 to 127). When 128 NG images are registered, the oldest NG image will be deleted and replaced by the 129th NG image. (All of numbers assigned to the NG images will be decremented by one.)
The actual total number of NG images that can be registered may be less than the 128, depending on the size of the images registered.

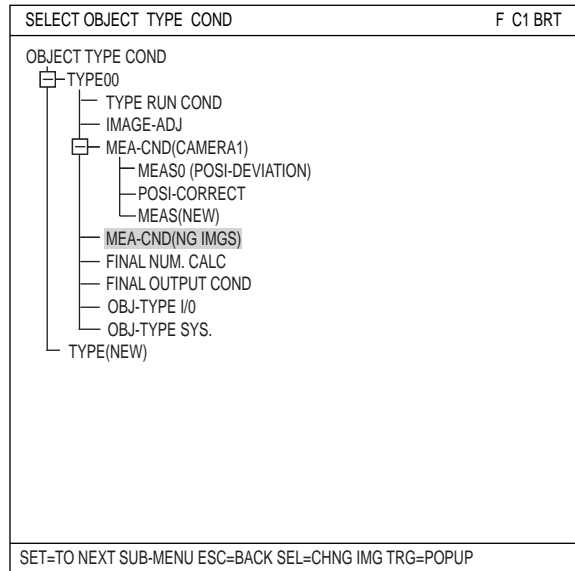

[Limitation] The total number of NG images sizes can only occupy a maximum 8, full-size screens (1,966,080 pixels: 512 x 480 x 8). The maximum screen size is 512 x 480 pixels.
Example: When the NG image size is 256 x 240 pixels, the controller can register up to 32 images. (256 x 240 x 32 = 1,966,080)

[2] How to display NG images

NG images can be displayed on the operation main screen and on the NG image display screen (IV-S32MX/S33MX).

(1) Displaying NG images on the MAIN OPS menu

An NG image (the latest or any previous NG image) recorded with camera 1 can be displayed on the monitor while conducting measurements from the operation main screen.

- This function only refreshes the NG image if another NG is captured. The screen is not refreshed with normal image measurement results. Thus, this method is useful for an operation that has a short cycle time and needs to process another workpiece soon after saving the NG image.
- When the measuring is stopped, NG images can also be displayed on the NG image display screen. ⇨ See page 1-22.

The setting procedures are as follows:

1. Select "CAM1&NG-IMG" from the monitor output.
⇨ See page 1-17 to1-18
2. Set the monitor output to "NG-IMGS" or "CAM1&NG-IMG."
Select "①MONITOR OUTPUT" on the [TYPE RUN COND] menu.
⇨ See page 2-3.

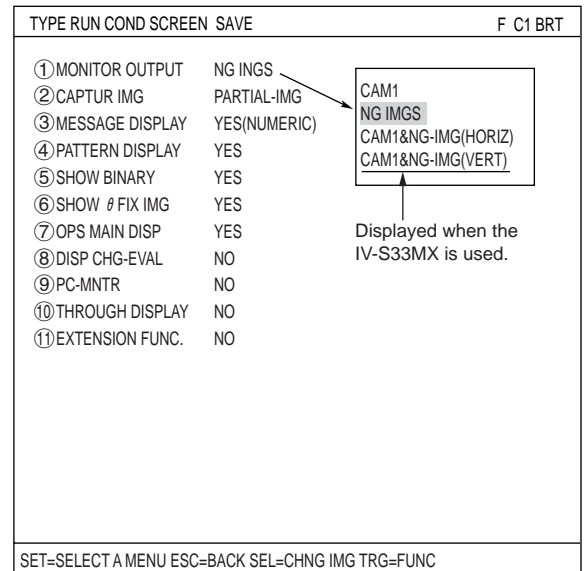

● When the IV-S33MX is used

① MONITOR OUTPUT	Description
CAM1	Display the camera 1 image on the whole screen.
NG-IMGS	Display the NG image on the whole screen.
CAM1&NG-IMG (HORIZ)	Display the camera 1 image on upper half, and the NG image on lower half.
CAM1&NG-IMG (VERT)	Display the camera 1 image on left half, and the NG image on right half.

● When the IV-S31MX/S32MX is used

① MONITOR OUTPUT	Description
CAM1	Display the camera 1 image on the whole screen.
NG-IMGS	Display the NG image on the whole screen.
CAM1&NG-IMG	Display the camera 1 image on upper half, and the NG image on lower half.

3. Return to the operation main screen (page 1-10) and start making measurements.
Shown below are examples of the NG image display.

● When the IV-S33MX is used

- Display example when the monitor output is set to "CAM1&NG-IMG (HORIZ)."

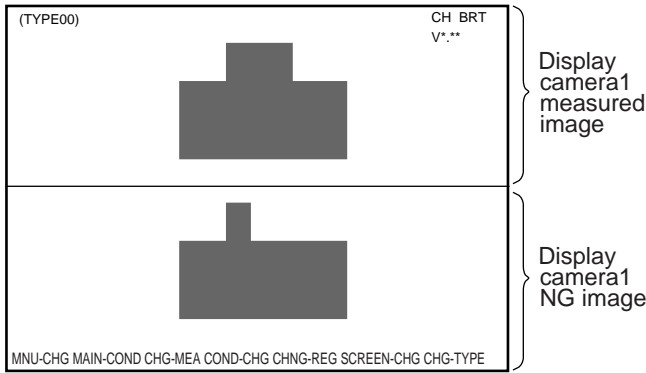

- Display example when the monitor output is set to "CAM1&NG-IMG (VERT)."

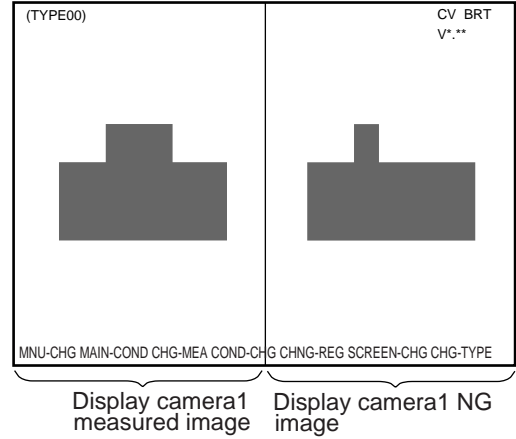

- Display example when the monitor output is set to "NG-IMG."

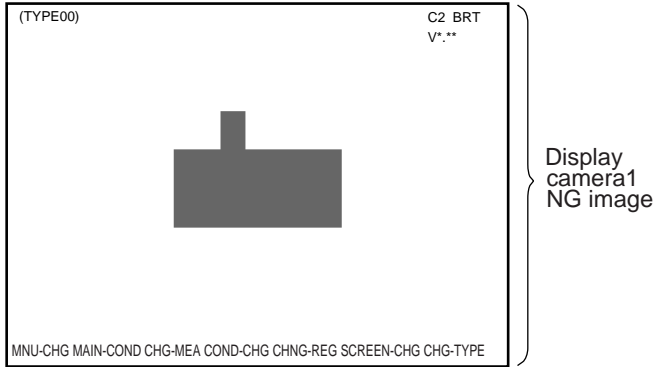

● When the IV-S31MX/32MX is used

- Display example when the monitor output is set to "CAM1&NG-IMG."

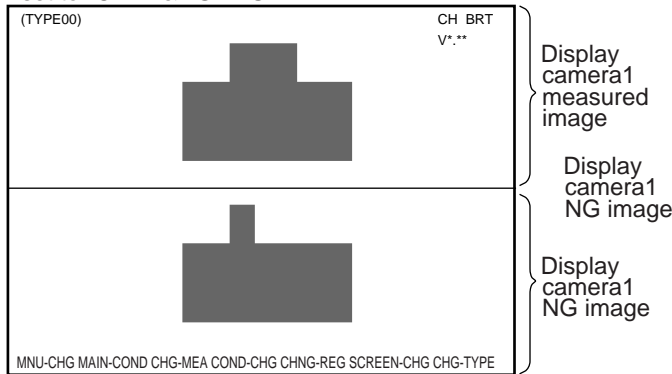

- Display example when the monitor output is set to "NG-IMG."

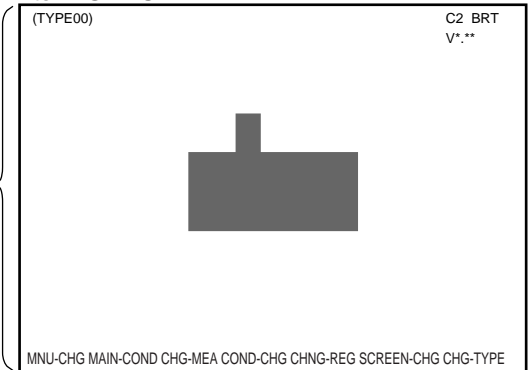

■ **Display when an NG image is captured**

The controller automatically refreshes the NG image each time a new NG image is captured.

[An example of the split screen display (above and below)]

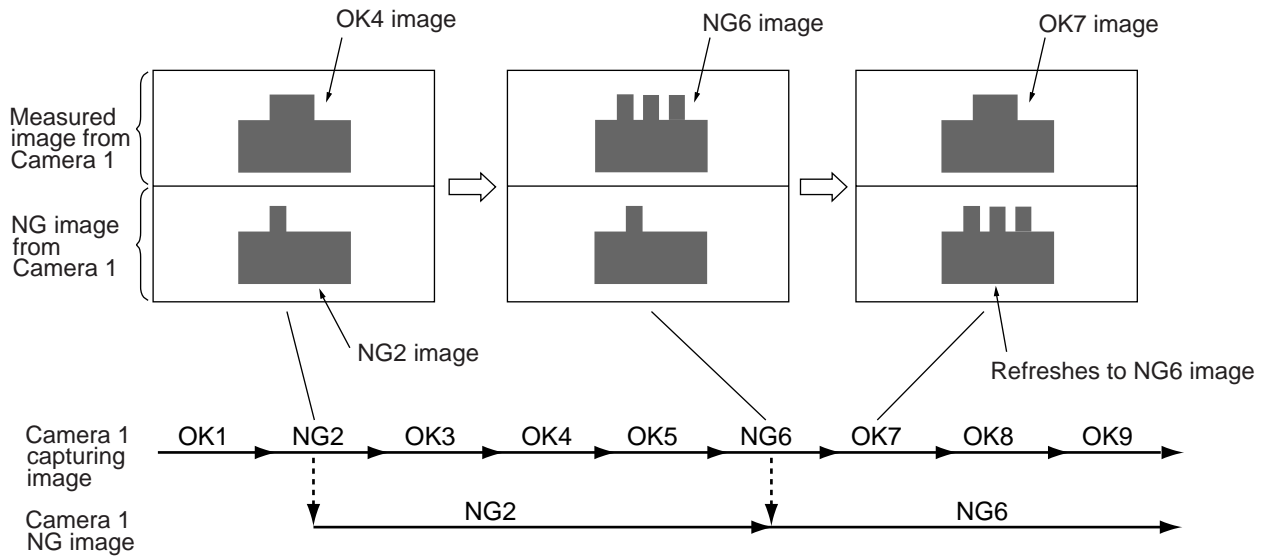

■ **Display history of NG images (IV-S32MX/S33MX)**

When the IV-S32MX/S33MX is used, move the cursor to the menu bar "SCREEN-CHG" on the operation main screen, using the left and right key. Select the "NG-IMG-DISP" from the popup menu to display previous NG images.

[An example of scrolling the split screen display (above and below)]

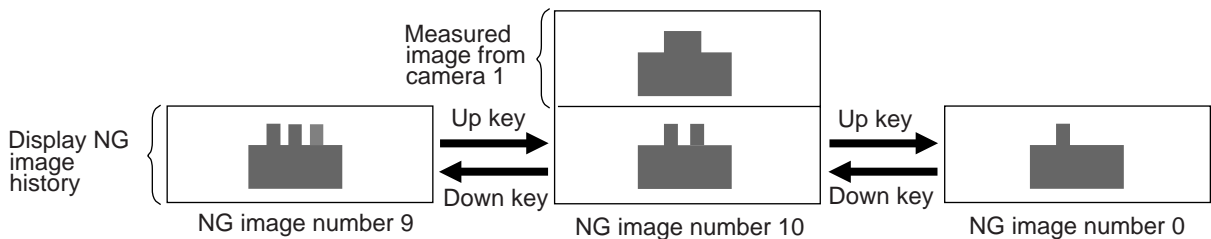

- When a maximum of 10 NG images is registered.

When a new NG image is captured while displaying the history, it will be added to the history.

Note

- When "PARTIAL-IMG" is selected for image capturing (page 2-4), the NG images stored have the maximum rectangular area set in measurements 0 to 4.
- When "CAM1&NG-IMG" is selected for the monitor output, only one camera* can be used for each measurement (0 to 4) and for image pre-processing.

* The camera connected to the camera 1 connector (CAMERA 1).

(2) Displaying images on the NG image display screen(IV-S32MX/S33MX)

When the IV-S32MX/S33MX is used, move the cursor to the menu bar "SCREEN-CHG" on the operation main screen (page1-10) and press the SET key. Select the "NG-IMG-DISP" from pop-up menu. The screen will change to the NG image display. When the measurement stops, the NG image will be displayed.

- To display NG images while measuring, display them on the operation main screen. - See page 1-18.

Note: Please be aware of the following.

1. Change the image display mode in the upper right of the screen to "F.IMG" (freeze image) by pressing the SET key.
2. You cannot measure objects while an NG image is being displayed on the NG image display screen.

- ① Display the NG image number and the number of NG images that have been registered.
The NG image number can be selected by selecting "NEXT-NG" on the menu bar.
- ② Displays the date and time the NG image was captured.
Example: 2000-10-01 10:25 ⇨
October 1st, 2000,
AM10:25.

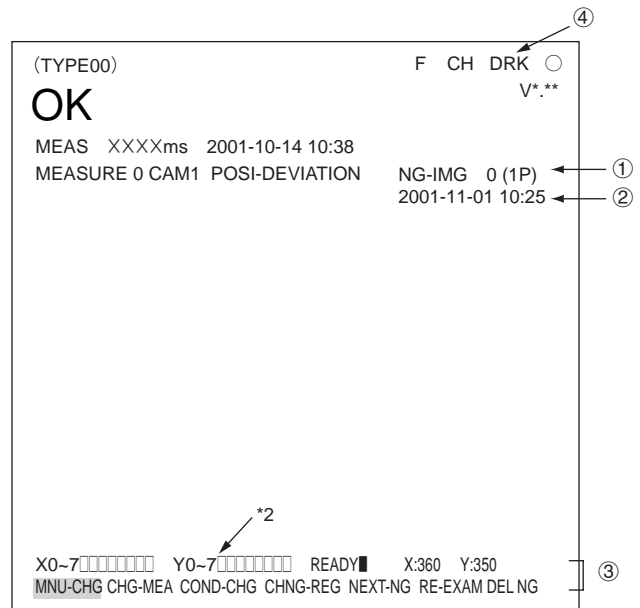

Displayed when the menu is changed.

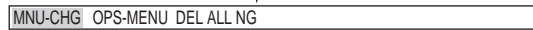

③ Menu bar

Menu bar	Details
CHG-MEA (change measurement)	Change the evaluation result display for the measurement numbers using the up and down keys. (MEASURE0 CAM1 fi MEASURE0 CAM2 fi MEASUREMENT1 fi MEASUREMENT2 fi MEASUREMENT3 fi MEASUREMENT4 fi)
COND-CHG (change measurement condition)	Change the operation menu using the up and down keys. "Display NG image" fi change evaluation conditions fi Page 2-10 - The operating screen display must be set to "YES." ⇨ See page 2-10. - For information about the evaluation condition change screen, see page 1-6. - On the evaluation condition change screen, press the SET key. The cursor will move to the setting change screen.
CHNG-REG (change register)	Change the measurement result display of the registered numbers in the measurement program using the up and down keys.
NEXT-NG (change NG image)	Change the registered number for the NG image being displayed using the up and down keys. ⇨ See the next page.
RE-EXAM (replay)	Replay the measurements made on the NG image selected with "NEXT-NG", by pressing the SET key.
DEL NG (delete NG image)	Press the SET key. Only the NG image selected with "NEXT-NG" will be deleted.
DEL ALL N (delete all NG images)	Press the SET key. All the registered NG images will be deleted.
OPS-MENU	Press the SET key, the screen will return to the operation main screen.

- ④ When "CAM1&2" is selected on the "①MONITOR OUTPUT" line (TYPE RUN COND menu), the camera numbers (CH) will be displayed on the screen next to the images from those cameras.

■ Display of the Change NG image operation

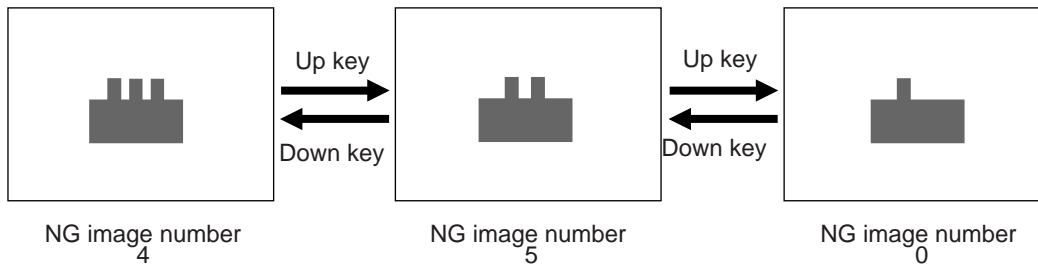

- When max. 5 NG images are registered.

Note

- When "PARTIAL-IMG" is selected for the image capturing mode (page 2-4), the stored NG images have the maximum rectangular area set by measurements 0 to 4.

[3] Initializing the NG images (IV-S32MX/S33MX)

When the IV-S32MX/S33MX is used, NG images can be initialized with any of the following methods:

1. Item "①INITIALIZATION", on the [OPTION] menu, will execute an "NG-IMG-INIT". ⇨ Page 2-22.
2. Execute a "DEL NG" (delete NG image) or "DEL ALL N" (delete all NG images) on the menu bar of the NG image display screen. ⇨ See the previous page.
3. When the object type number is changed, the registered NG images are initialized.

1-9 Operation flow

[1] Power ON and main loop processing

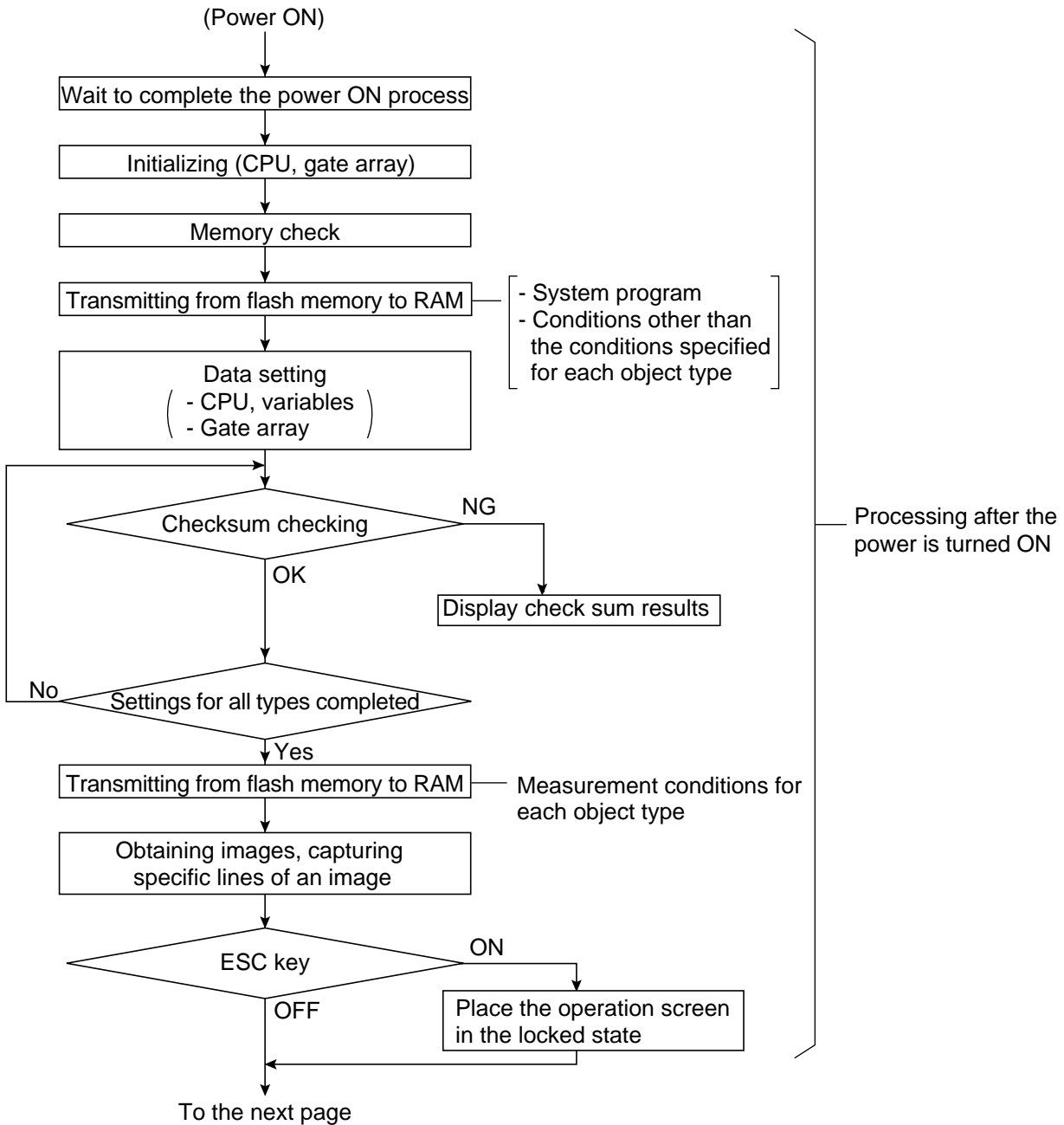

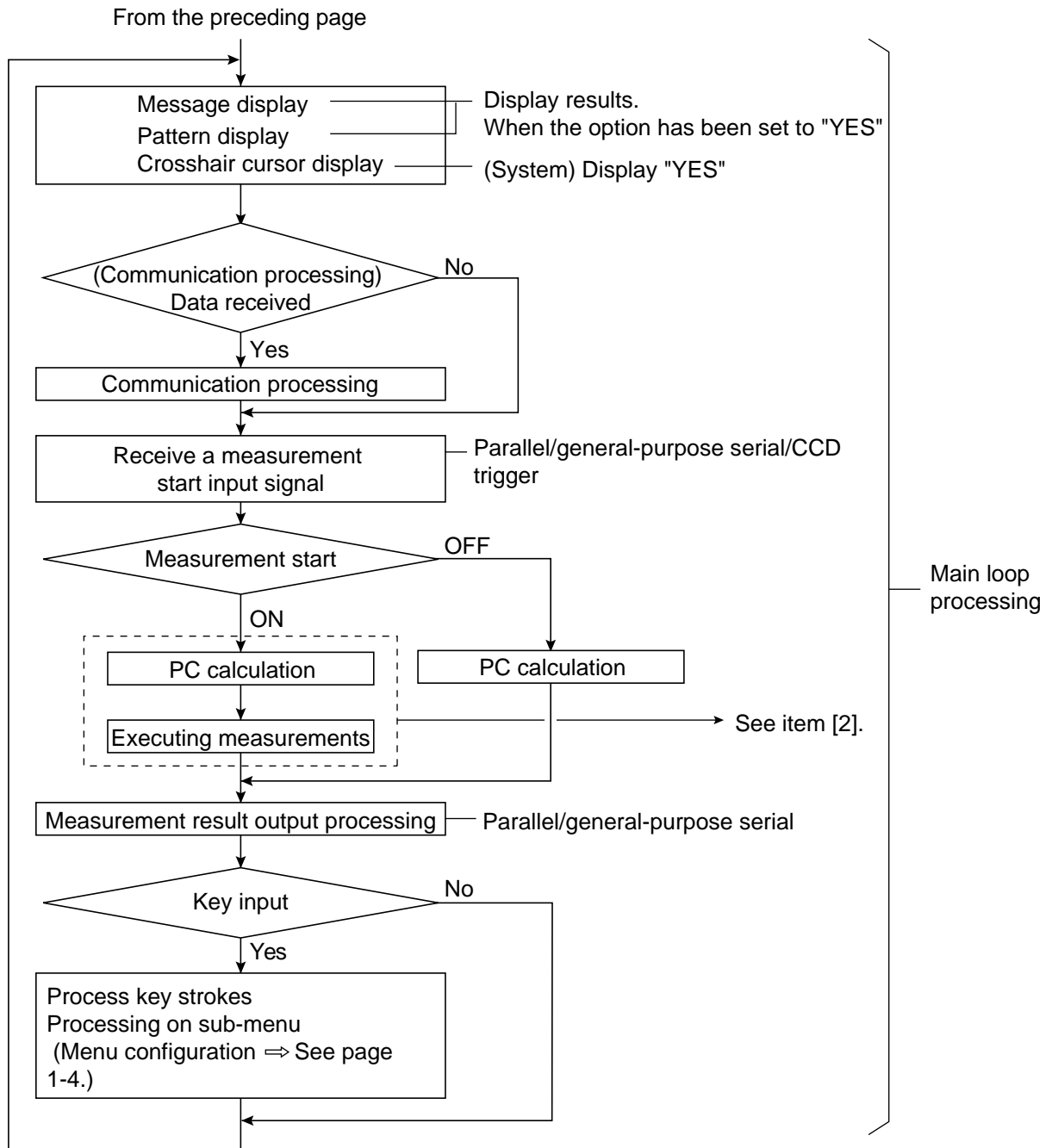

1

[2] Operation flow after the measurement start input is turned ON.

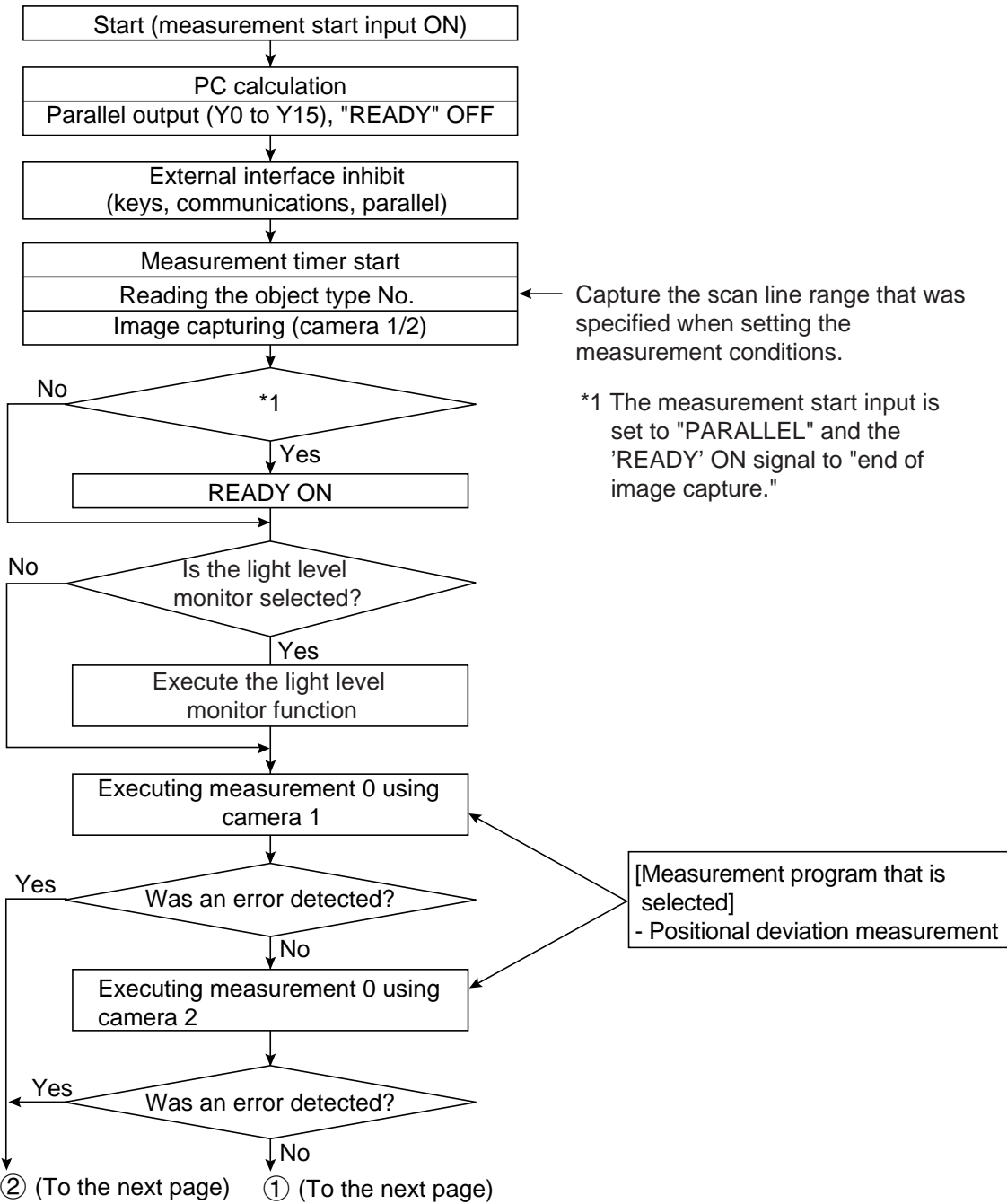

② (From the preceding page) ① (From the preceding page)

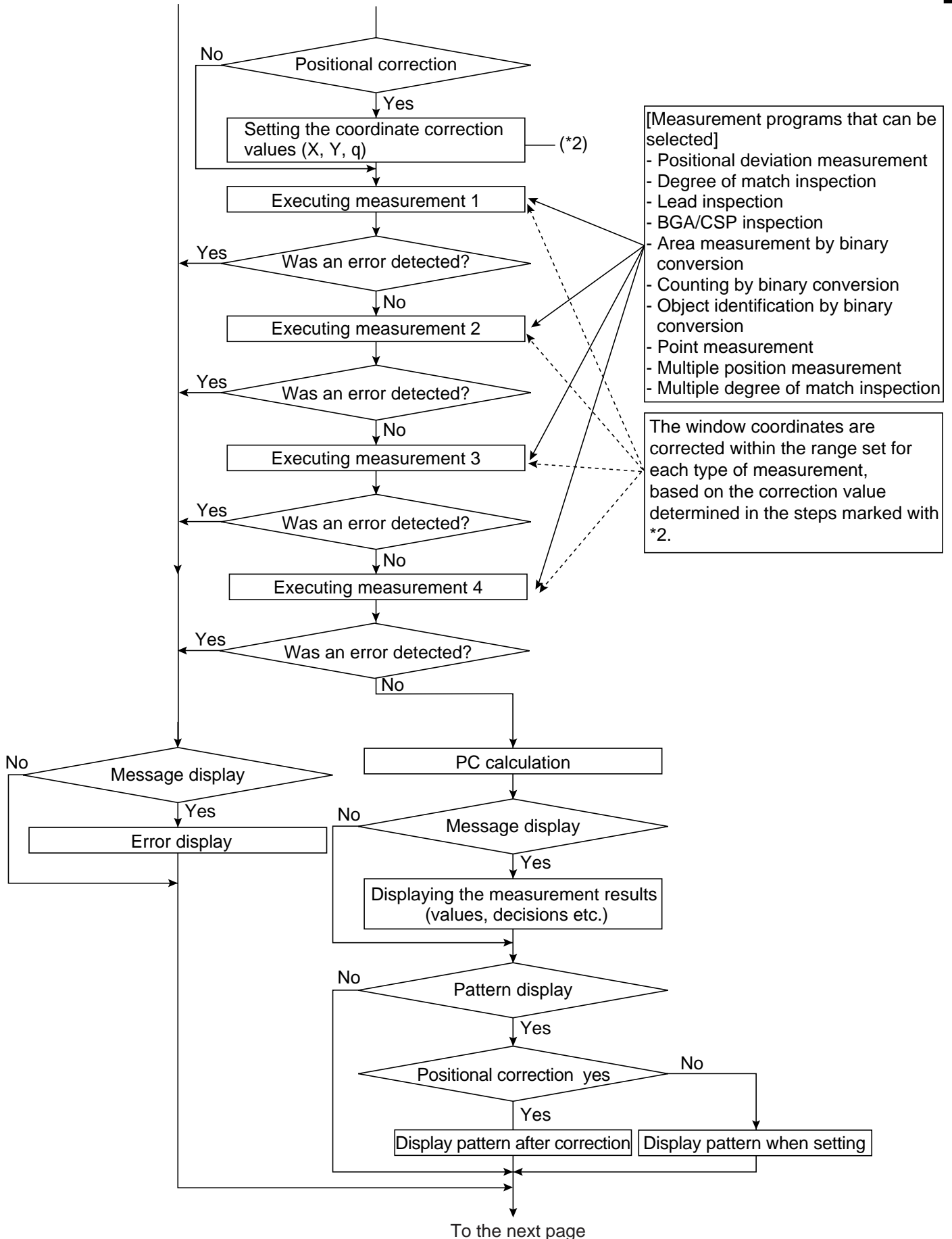

- [Measurement programs that can be selected]
- Positional deviation measurement
 - Degree of match inspection
 - Lead inspection
 - BGA/CSP inspection
 - Area measurement by binary conversion
 - Counting by binary conversion
 - Object identification by binary conversion
 - Point measurement
 - Multiple position measurement
 - Multiple degree of match inspection

The window coordinates are corrected within the range set for each type of measurement, based on the correction value determined in the steps marked with *2.

To the next page

1

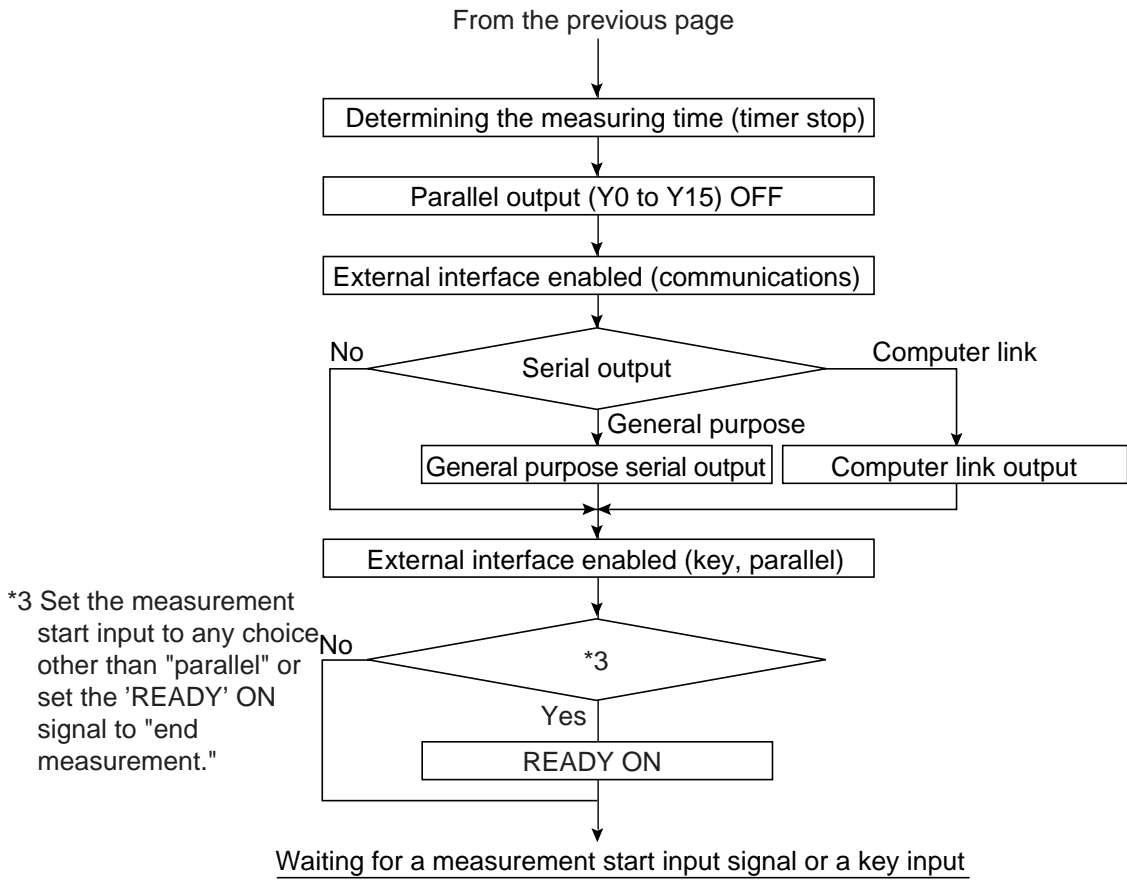

- When the stop NG measurement option is set to "YES" (page 3-40), the controller stops measuring when an error occurs.

1-10 Table of controller functions

Shown below are the functions for the individual controllers (IV-S31MX/S32MX/S33MX).

- For details about the controller hardware (cameras, peripheral devices), see the "IV-S30 (IV-S31MX/S32MX/S33MX) User's Manual, Instruction and Hardware."

Item		Specifications		
		IV-S31MX	IV-S32MX	IV-S33MX
Image sampling system		256 level gray scale, binary conversion, edge detection		
Image memory		One screen for displaying captured images. One monochrome screen for displaying camera information and messages		
No. of assignable object type		16 object types	32 object types	
Maximum number of reference images stored / number of whole screens stored		300 / 3 screens	600 / 8 screens	
Image scan time	Standard camera (IV-S30C1/C2)	33.3 ms *2		
	High-speed camera (IV-S30C3/C4)	---		16.7 ms [full mode] 8.3 ms [half mode] *2
	Commercially available EIA camera	---		33.3 ms [full mode] 16.7 ms [half mode]
Gray search time *1		18 ms	12 ms	9 ms
Gray search, edge detection precision		Pixel, sub-pixel		
Image pre-processing	Shading correction	Dividing, subtracting, and filtering		
	Comparative calculation between images	Subtracting, absolute value of difference (between camera 1 and reference image, between camera 2 and reference image, between camera 1 and camera 2)		
	Gray level changes	Magnification by "n" processing, g (+/-) correction, histogram widening, mid-range emphasis		
	Space filter	Smoothing (center/average), edge emphasis, edge extraction, horizontal edge, vertical edge		
Binary threshold value		Fixed and threshold value corrections (variation difference/variation rate)		
Binary noise elimination		Expansion ⇨ contraction, contraction ⇨ expansion, area filter		
Binary image mask		Specified window(rectangle, circle, oval), any binary image mask		
Positional correction method		X/Y correction, rotation correction		
Measurement program	Positional deviation measurement	XY coordinate, deviation amount in X and Y axes, degree of match (1-point search, 2-point search, 1-point edge, 2-point edge, 1-point search and 1-point edge) Angle: ±15 , ±30 , ±45 , 360 (1-point search, 1-point search + 1-point edge) [Maximum 8 windows x 2 models]		
	Degree of match inspection	Degree of match, XY coordinate, density (1-point search, 2-point search) [Maximum 16 windows x 2 models]		
	Area measurement by binary conversion	Area [Maximum 16 windows]		
	Object counting by binary conversion	Quantity (maximum 3,000 items per window), total area [Maximum 4 windows]		
	Object identification by binary conversion	Quantity (maximum 128 per window), total area, area of each object identified, gravity center, main axis angle, fillet diameter, peripheral length, center point [Maximum 4 windows]		
	Point measurement	Number in binary image (maximum 256 points), average density (Maximum 128 points)		
	Lead inspection	Number of leads, distance between leads (max., min.), lead width (max., min.), lead length (max., min.) [Maximum 16 windows]		
	BGA/CSP inspection	Number of labels, total area, area of each label, XY pitch (max., min.) XY fillet diameter (max., min.), [Maximum 4 windows] (IV-S32MX/S33MX only)		
	Multiple position inspection	Number of objects (max. 128), degree of match, XY coordinate (1-point search, 1-point edge) [Maximum 4 windows]		
	Multiple degree of match inspection	Number of objects (max. 128), degree of match, XY coordinate (1-point search) [Maximum 4 windows]		

*1. The gray search time is true when the search area is 256 x 256 pixels, the model size is 64 x 64 pixels, and the contraction function is set to 3.

*2. Variable, with partial-image capturing.

Item	Specifications		
	IV-S31MX	IV-S32MX	IV-S33MX
Number of measurement programs	Maximum 6 per object type (measurement 0 - camera 1, measurement 0 - camera 2, measurements 1 to 4) Note: Measurement 0 is only used for positional deviation measurement.		
Window shape	Rectangle, circle, oval (when using area measurement by binary conversion, object counting by binary conversion, object identification by binary measurement), polygon window (3 to 32 sided polygons: When binary area measurement, counting after binary conversion, object identification (labeling) after binary conversion, or BGA/CSP inspection is selected.)		
Distance and angle measurement	Measure distance (between two points, X coordinate, Y coordinate), measure angle (3 points, 2 points against horizontal line, 2 points against vertical line), auxiliary point (center, circle center, gravity center, line over 2 points, crossing point of two straight lines)		
Arithmetic operation	Four basic operations (+, -, X, /), root, absolute value, TAN, ATAN, maximum, minimum, average, total.		
NG image memory function	---	Maximum 128 images (8 whole screens)	
Calendar timer	---	Year, month, day, hour, minute	
Other functions	Display measuring time, light level monitor function, crosshair cursor display, change display language between Japanese and English, Run screen lock function, setting menu display "yes/no", change image display (through/freeze), change image brightness (bright/dark)		
Micro PC section	Input relays	Parallel input: 8 points (X0 to X7)	
	Output relays	Parallel output: 8 points (Y0 to Y7)	
	Auxiliary relays	General-purpose serial interface, computer link: 16 points (Y0 to Y15)	
	Timers	128 points (C0 to C127), special area 18 points (C110 to C127)	
	Counters	8 points (TM0 to TM7), timer setting range: 0.01 to 9.99 seconds (countdown timer)	
External interface	Parallel interface	Input: 8 points, 12/24 VDC, approx. 7 mA (24VDC) Output: 9 points, 12/24 VDC, max. 100 mA, FET output	
	General-purpose serial interface	RS232C/RS422 (2.4 to 115.2 kbps)	
	Computer link	Built-in compatibility with certain SHARP, OMRON, and Mitsubishi models	
	USB	USB device node, 12 Mbps	
Image output	1 channel, EIA 525 lines, 2:1 interlace		
Number of cameras	Maximum of 2		
Make settings	Using the IV-S30RK1 remote keypad and/or the IV-S30SP parameter setting support software		
Measurement start input	Internal trigger	CCD trigger (using the CCD camera)	
	External trigger	Trigger input (parallel I/F), general-purpose serial I/F, keypad trigger (for manual measuring)	
Terminal block	Interrupt processing input	1 point: External trigger (X0)	
	Inputs	7 points: Object type change (X1 to X4), external input (X5 to X7)	7 points: Object type change (X1 to X5), external input (X6 and X7)
	Common for input	1 point: + or - common	
	Output	9 points: 1 READY, 8 user settable logical outputs (Y0 to Y7)	
	Common for output	1 point: + or - common	
	Power supply	2 points: +24 VDC, 0 V	

Chapter 2: Setting the Operating and System Conditions

2-1 Setting the operating conditions

Set the following operating condition items on the [TYPE RUN COND] menu for each object type.

Item to set	Reference page
Monitor output	2-2
Image capture	2-4
Message display	2-5
Pattern display	2-6
Binary image display	2-7
q angle correction image display	2-8
Operation main display	2-9
Evaluation change display	2-10
PC monitor screen	2-11
Through display	2-11
Extension function	2-12

How to display the TYPE RUN COND screen

On the "MAIN MENU," select "OBJECT TYPE COND", "TYPE 00", and "TYPE RUN COND" in this order.

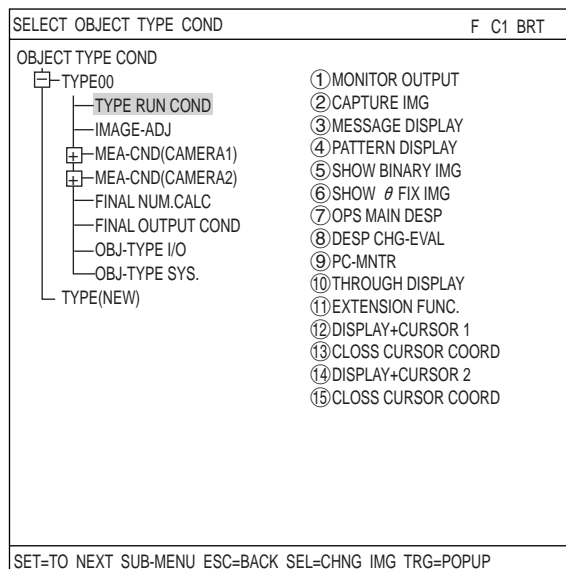

The "TYPE RUN COND" screen will appear.

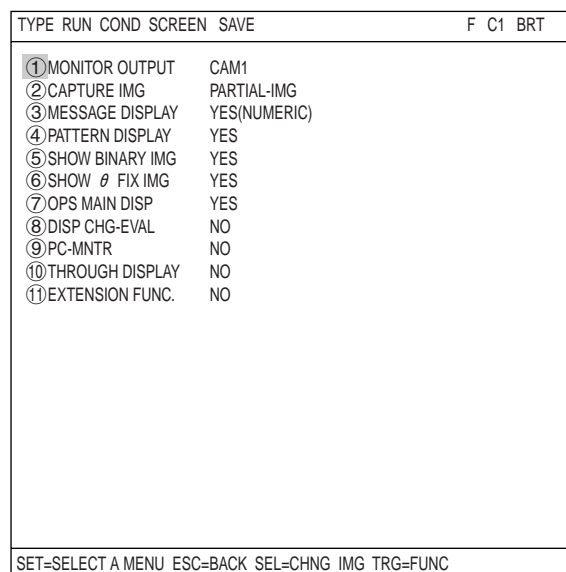

[1] Monitor output

When two cameras have been connected to IV-S31MX/S32MX/S33MX, you can switch back and forth between the image from the cameras on one monitor. Also, the monitor screen can be divided into two parts to display the two images simultaneously.

- Purpose of the setting

To set the conditions in which an image captured during measurement will be displayed on the operation screen.

- Output monitor switching

There are two methods for changing the monitor output: change the TYPE RUN COND settings, use external input signals through the parallel port to make changes from outside.

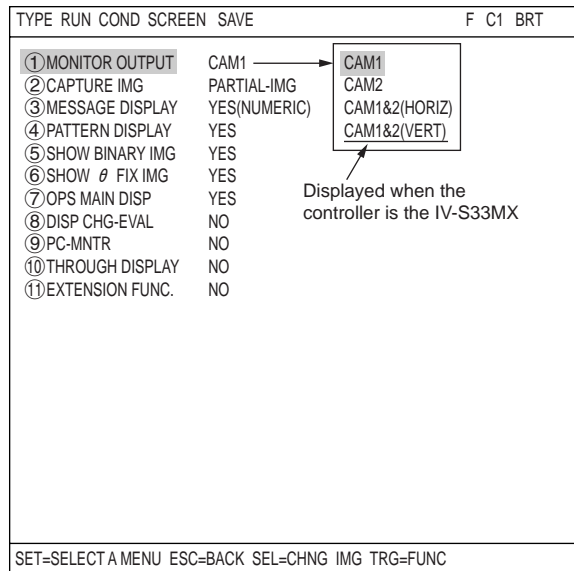

(1) Change the monitor output by changing the TYPE RUN COND settings

Select the "①MONITOR OUTPUT" item on the "TYPE RUN COND" screen and then select an item from the popup menu.

① MONITOR OUTPUT	Description
CAM1	Display the camera 1 image on the whole screen.
CAM2	Display the camera 2 image on the whole screen.
CAM1&2(HORIZ)	Display the camera 1 image on upper half, and the camera 2 image on lower half.
CAM1&2(VERT)	Display the camera 1 image on left half, and the camera 2 image on right half.*

*When IV-S33MX is used.

■ Display examples on the operation screen

- Camera 1 on the whole screen

(When "CAM1" has been specified in item ①MONITOR OUTPUT.)

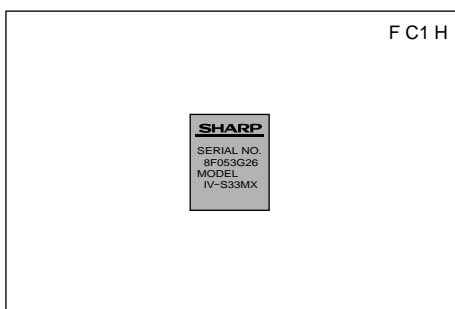

- Camera 2 on the whole screen.

(When "CAM2" has been specified in item ①MONITOR OUTPUT.)



- Simultaneous display on a divided screen

(When "CAM1&2(HORIZ)" has been specified in item "①MONITOR OUTPUT.")

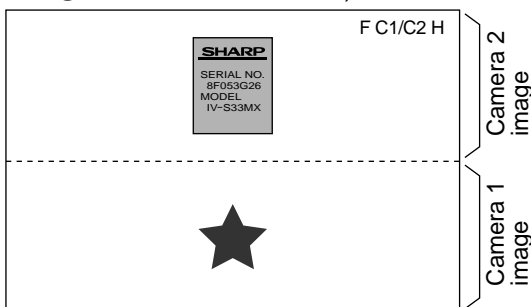

- Simultaneous display on a divided screen

(When "CAM1&2 (VERT)" has been specified in item "①MONITOR OUTPUT.")

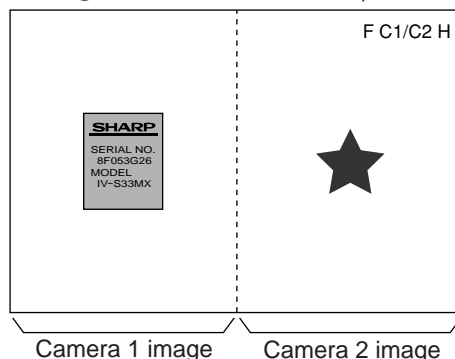

(2) Output monitor switching by parallel input

On the operation screen, select "MAIN-COND" -> "SYS-CND" -> "I/O CONDITIONS" in that order. Move the cursor to the "⑤PARALLEL INP X7" line using up/down arrow keys and press the SET key. Select "CHNG-IMG-OUT-CAM" on the popup menu that is displayed and then press the SET key.

Every time the X7 signal is turned from OFF to ON, the selected camera display will be changed.

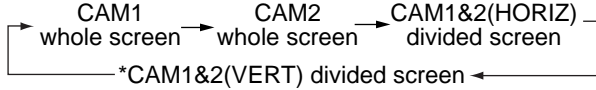

*When the IV-S33MX is used.

The display example of the operation screen is the same as in section (1).

I/O CONDITION SCREEN COND SAVE		F C1 BRT
① MEAS INP I/F	PARALLEL+SERIAL+USB	
② OUT I/F(PARAL.)	NO	
③ MANL TYPE CHNG	NO	
④ PARALLEL INP X6	EXT-INP	
⑤ PARALLEL INP X7	CHNG-IMG-OUT-CAM	<div style="border: 1px solid black; padding: 2px;"> EXT-INP CHNG-IMG-OUT-CAM CAM-MEAS 2 IMAGES </div>
⑥ STROBE OUT	NO	
⑦ 'READY'ON	CAPTURE COMPLETE	

SET=SELECT A MENU ESC=BACK SEL=CHNG IMG TRG=FUNC

[2] Image capture

In item "②CAPTURE IMG" on the "TYPE RUN COND" screen, specify the range which will be captured during operation.

TYPE RUN COND SCREEN SAVE		F C1 BRT
① MONITOR OUTPUT	CAM1	
② CAPTURE IMG	PARTIAL-IMG	→ PARTIAL-IMG
③ MESSAGE DISPLAY	YES(NUMERIC)	WHOLE-IMG
④ PATTERN DISPLAY	YES	NO
⑤ SHOW BINARY IMG	YES	
⑥ SHOW θ FIX IMG	YES	
⑦ OPS MAIN DISP	YES	
⑧ DISP CHG-EVAL	NO	
⑨ PC-MNTR	NO	
⑩ THROUGH DISPLAY	NO	
⑪ EXTENSION FUNC.	NO	

CAPTURE IMG	Description
PARTIAL-IMG (partial image)	- An image of the specified lines, required for inspection or measurement, will be captured. - The processing time is shorter than in the "WHOLE-IMG" mode. Note: When the IV-S33MX is used and "EIA" is selected for the camera, "PARTIAL-IMG" cannot be selected. (The "PARTIAL-IMG" selection is not displayed.)
WHOLE-IMG (whole image)	- A whole image will be captured, irrespective of the window settings for inspection or measurement. - This mode is used to monitor portions of an image outside the window set up for inspection or measurement
NO (no image)	- No image will be captured during operation. Measurements will be carried out with an image being displayed. - This mode only used to carry out measurements on an image transmitted from a personal computer to the IV-S30.

Example of a comparison of the capture times

- When "WHOLE-IMG" is selected
 - IV-S33MX
 - 16.7 ms (high-speed camera and full mode)
 - 8.3 ms (high-speed camera and half mode)
 - 33.3 ms (standard camera)
 - IV-S31MX/S32MX
 - 33.3 ms (standard camera)

Capture whole image

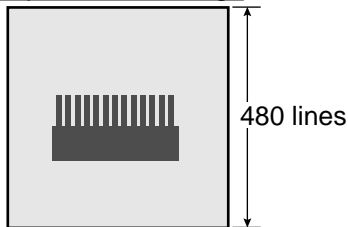

- Image capture mode (full/half mode)
⇒ See page 2-20.

- When the "PARTIAL-IMG" is selected (when there are 240 scan lines)

- IV-S33MX
 - 8.3 ms (high-speed camera and full mode)*
 - 4.2 ms (high-speed camera and half mode)*
 - 12.5 ms (high-speed camera and full + half mode)*
- IV-S31MX/S32MX
 - 16.6 ms (standard camera)

Capture partial image

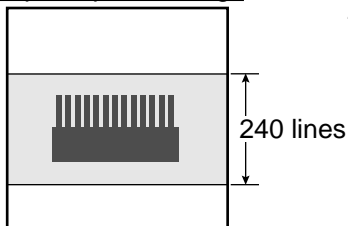

* The image capture time may vary with the position of the partial image. (In the following case, maximum 0.4 ms)

[3] Message display

Select "YES" or "NO" to display messages on the operation screen.

MESSAGE DISPLAY	Description
YES (NUMERIC)	All data will be displayed.
YES (NO NUMERIC)	Data other than the numerical result will not be displayed.
NO	No messages will be displayed.

Setting to "NO" reduces the processing time.
 Processing time:
 YES(NUMERIC) > YES(NO NUMERIC) > NO

TYPE RUN COND SCREEN SAVE F C1 BRT

① MONITOR OUTPUT	CAM1
② CAPTURE IMG	PARTIAL-IMG
③ MESSAGE DISPLAY	YES(NUMERIC)
④ PATTERN DISPLAY	YES
⑤ SHOW BINARY IMG	YES
⑥ SHOW θ FIX IMG	YES
⑦ OPS MAIN DISP	YES
⑧ DISP CHG-EVAL	NO
⑨ PC-MNTR	NO
⑩ THROUGH DISPLAY	NO
⑪ EXTENSION FUNC.	NO

YES(NUMERIC)
 YES(NO NUMERIC)
 NO

SET=SELECT A MENU ESC=BACK SEL=CHNG IMG TRG=FUNC

2

■ Display examples

- When "YES(NUMERIC)" is selected

F C1 L
V:..*

OK
 MEAS XXXXms XXXX-XX-XX XX:XX
 MEASURE 0 CAM1 POSI-DEVIATION

REGST.NO 0(0-7)

X0=176.0 OK

Y0=322.0 OK

x0=+000.0 OK

y0=+000.0 OK

M0=+10000 OK

B0=+001.7 OK

X1=534.0 OK

Y1=480.0 OK

x1=+001.0 OK

y1=+001.0 OK

M1=+09999 OK

+

+

X0-7 ██████████ Y0-7 ██████████ READY []
 MNU-CHG MAIN-COND CHG-MEA COND-CHG CHNG-REG SCREEN-CHG CHG-TYPE

- When "YES(NO NUMERIC)" is selected

F C1 L
V:..*

OK
 MEAS XXXXms XXXX-XX-XX XX:XX
 MEASURE 0 CAM1 POSI-DEVIATION

+

+

X0-7 ██████████ Y0-7 ██████████ READY []
 MNU-CHG MAIN-COND CHG-MEA COND-CHG CHNG-REG SCREEN-CHG CHG-TYPE

Can be deleted by pressing the SET key.

- When "NO" is selected

+

+

Press the
SET key

→

Press the
ESC key

←

+

+

X0-7 ██████████ Y0-7 ██████████ READY []
 MNU-CHG MAIN-COND CHG-MEA COND-CHG CHNG-REG SCREEN-CHG CHG-TYPE

The menu bar will disappear.

The menu bar will be displayed.

[4] Pattern display

Select "YES" or "NO" to determine whether to show the pattern display (solid lines and dashed lines of the rectangles in the window) over an image displayed on the operation screen.

Note: When the "CAM1&2(HORIZ/VERT)" or "CAM1&NG IMG(HORIZ/VERT)" is selected on the "①MONITOR OUTPUT" (page 2-2), pattern display cannot be selected.

PATTERN DISPLAY	Description
YES	Displays patterns in the window, such as the rectangles defined for the inspection area and the search area.
NO	Patterns will not be displayed on the operation screen.

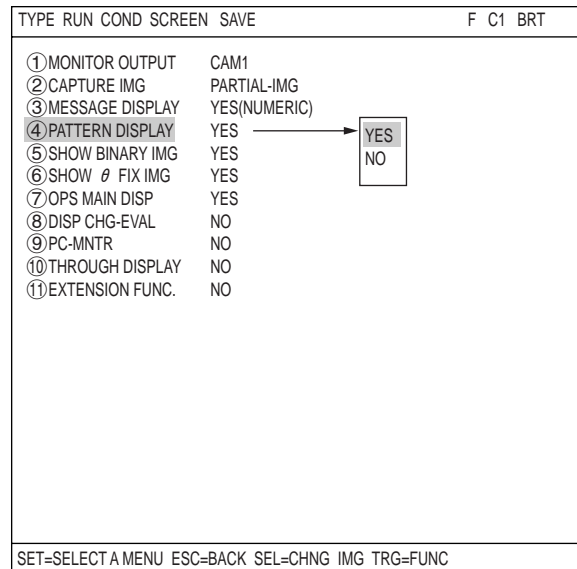

■ Display examples

- When "YES" is selected for PATTERN DISPLAY.

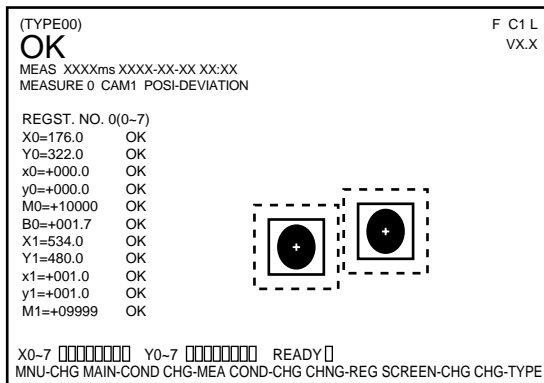

- When "NO" is selected for PATTERN DISPLAY.

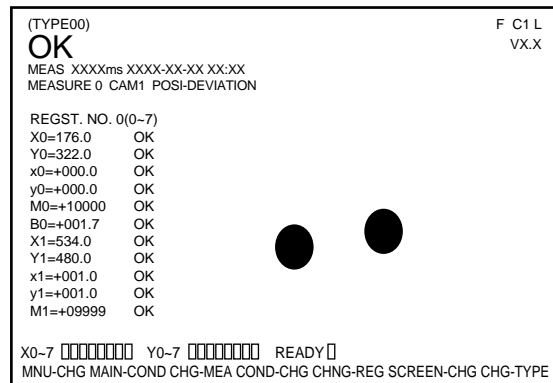

[5] Binary image display

Select "YES" or "NO" to display a binary image on the operation screen.

Note: When "CAM1&2(HORIZ/VERT)" or "CAM1&NG IMG(HORIZ/VERT)" is selected on the "MONITOR OUTPUT" (page 2-2), the binary image display cannot be selected.

- When "NO" is selected on the "④PATTERN DISPLAY," the "⑤SHOW BINARY IMG" item will not appear.

SHOW BINARY IMG	Description
YES	A binary image will be displayed on the operation screen.
NO	A binary image will not be displayed on the operation screen.

TYPE RUN COND SCREEN SAVE		F C1 BRT
① MONITOR OUTPUT	CAM1	
② CAPTURE IMG	PARTIAL-IMG	
③ MESSAGE DISPLAY	YES(NUMERIC)	
④ PATTERN DISPLAY	YES	
⑤ SHOW BINARY IMG	YES	<input type="checkbox"/> YES <input type="checkbox"/> NO
⑥ SHOW θ FIX IMG	YES	
⑦ OPS MAIN DISP	YES	
⑧ DISP CHG-EVAL	NO	
⑨ PC-MNTR	NO	
⑩ THROUGH DISPLAY	NO	
⑪ EXTENSION FUNC.	NO	

SET=SELECT A MENU ESC=BACK SEL=CHNG IMG TRG=FUNC

■ Display examples

- When "YES" is selected for the "⑤ SHOW BINARY IMG"

- When "NO" is selected for the "⑤ SHOW BINARY IMG"

[6] θ angle correction image display

Select "YES" or "NO" to display a θ angle corrected image on the operation screen.

2

SHOW FIX q IMG	Description
YES	A q angle corrected image will be displayed on the operation screen.
NO	A q angle corrected image will not be displayed on the operation screen.

```

TYPE RUN COND SCREEN SAVE                                F C1 BRT
① MONITOR OUTPUT    CAM1
② CAPTURE IMG      PARTIAL-IMG
③ MESSAGE DISPLAY   YES(NUMERIC)
④ PATTERN DISPLAY   YES
⑤ SHOW BINARY IMG   YES
⑥ SHOW  $\theta$  FIX IMG YES → YES
⑦ OPS MAIN DISP     YES
⑧ DISP CHG-EVAL    NO
⑨ PC-MNTR          NO
⑩ THROUGH DISPLAY   NO
⑪ EXTENSION FUNC.  NO
    
```

SET=SELECT A MENU ESC=BACK SEL=CHNG IMG TRG=FUNC

■ Display examples

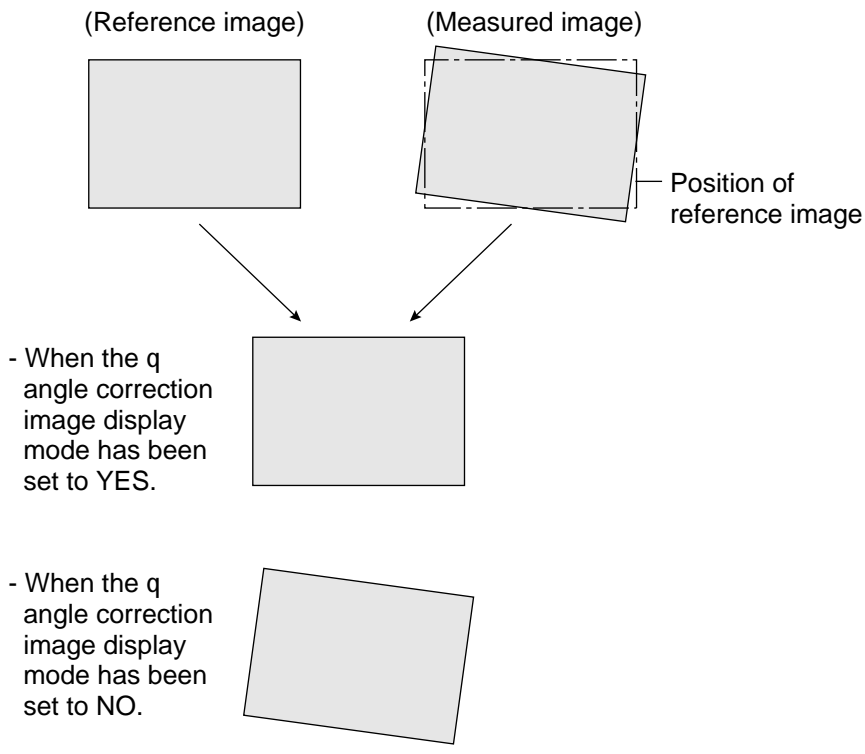

[7] Operation main display

When the operation screen was set to display other screens (such as the "DISP CHG-EVAL" and "PC-MNTR" screens), this item should be selected to return to the main display from other screens. On the "TYPE RUN COND" screen, select "⑦ OPS MAIN DISP" and then "YES" on the popup menu. That will return you to the main operation screen.

Note: When other screens are set to "YES" (such as the "⑧ DISP CHG-EVAL" and "⑨ PC-MNTR" screens), make sure to select "YES" from the "⑦ OPS MAIN DISP".

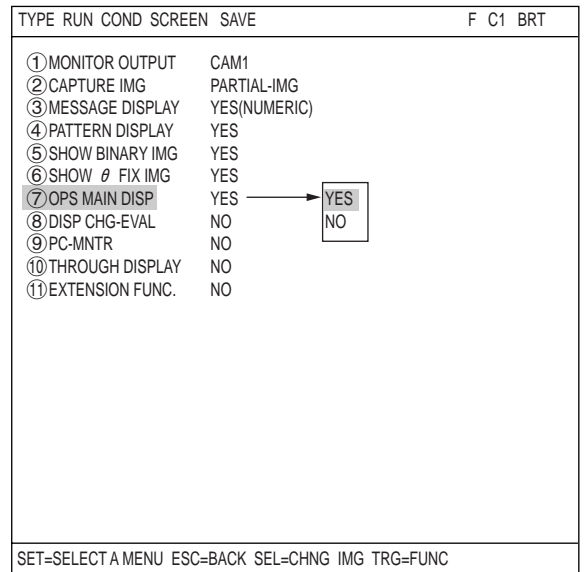

Press the TRG/BRT key to move the cursor to the upper function menu. Select "SCREEN" and press the SET key. Then select "OPS-MENU."

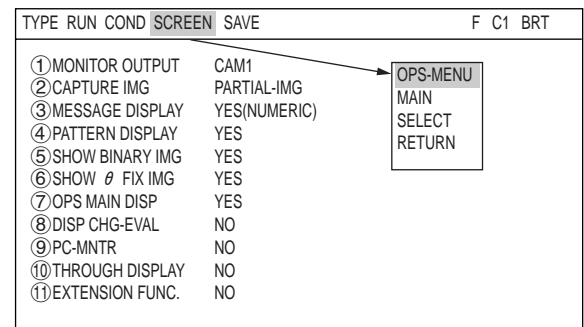

Select "SCREEN-CHG" on the lower menu on the operation screen and press the SET key. "OPS-MAIN" will be displayed in the lower right corner of the screen. While the "OPS-MAIN" line is highlighted, press the SET key. The main display will then change back to the operation screen from the other screens (e.g. the JDG-COND-CHG and PC-MNTR screens).

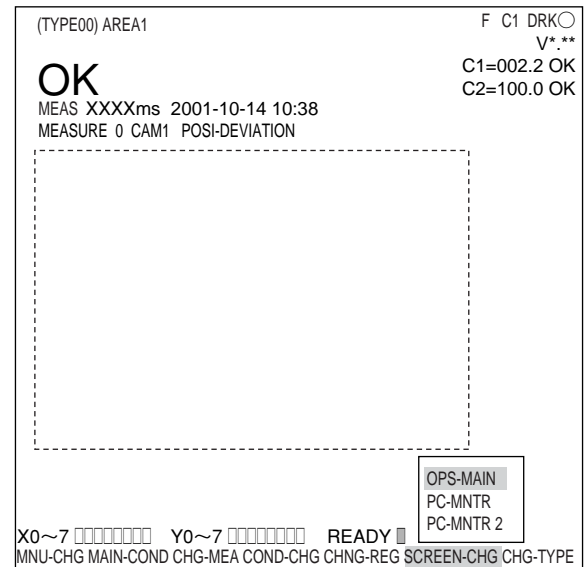

[8] Evaluation change display

Specify whether the evaluation condition change menu can be displayed on the operation screen or not.

Select the "⑧DISP CHG-EVAL" line on the "TYPE RUN COND" screen and select "YES" on the popup menu.

2

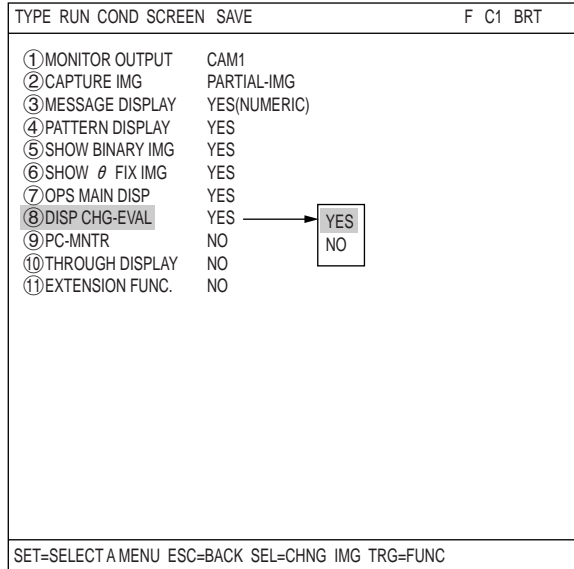

Press the TRG/BRT key to move the cursor to the upper function menu. Select "SCREEN" and press the SET key. Then select "OPS-MENU."

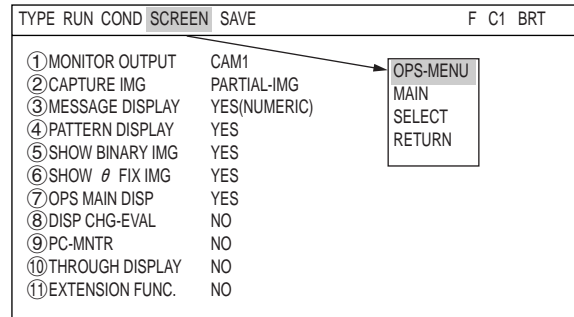

Select "SCREEN-CHG" on the lower menu on the operation screen, and press the SET key. "JDG-COND CHG" will be displayed in the lower right corner of the screen. You can display the evaluation condition change menu by pressing the up and down keys.

- Press the SET key. The cursor will move to the area containing the phrase "evaluation condition change menu during operation." You can change the settings for the evaluation conditions.
- At this time, the screen display will look the same as the normal operation main screen, except for the area marked "evaluation condition change menu shown during operation."

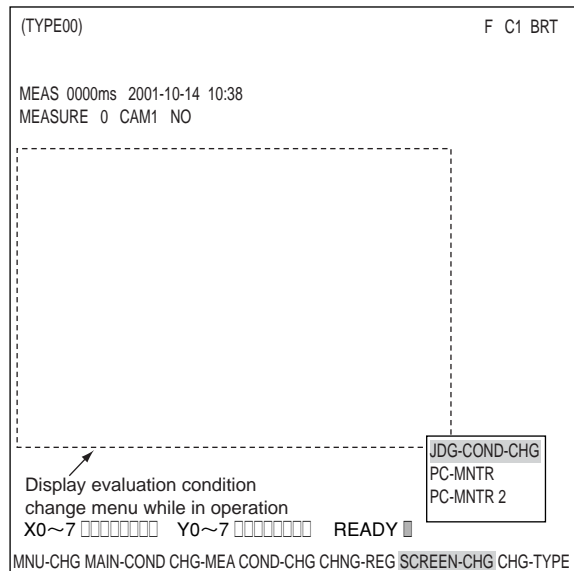

[9] PC monitor screen

Specify whether to display the PC monitor on the operation screen.

Select the "⑨PC-MNTR" line on the "TYPE RUN COND" screen and select "YES" on the popup menu. Now the PC monitor screen can be displayed.

Select "SCREEN-CHG" on the lower menu bar of the operation screen and then select "PC-MNTR" on the popup menu. The PC monitor will be displayed.

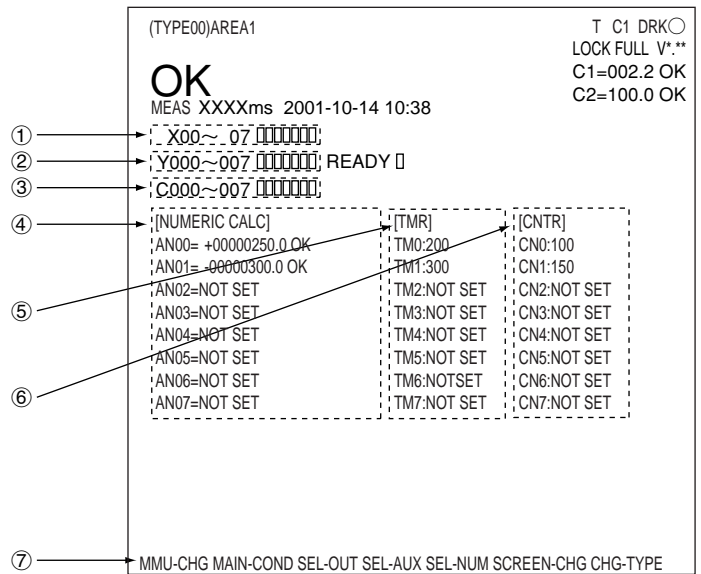

- ① The ON (■) or OFF (□) status of the input relays (X00 to X07) is displayed.
- ② The ON (■) or OFF (□) status of the output relays (Y00 to Y15) is displayed.
- ③ The ON (■) or OFF (□) status of the auxiliary relays (C000 to C127) is displayed.
- ④ The results (AN00 to AN15) of the final numerical calculations are displayed.
- ⑤ The current timer value is displayed.
- ⑥ The current counter value is displayed.
- ⑦ Menu bar

Menu bar	Description
SEL-OUT	Change the output relay address (Y00 to Y15) using the up and down keys (in units of 8 points).
SEL-AUX	Change the auxiliary relay address (C000 to C127) using the up and down keys (in units of 8 points).
SEL-NUM	Change the final numerical calculation address (AN00 to AN15) using the up and down keys (in units of 8 points).

The other data displayed is the same as on the operation screen. ⇨ See page 1-10.

[10] Through display

Select the desired measurement image status (FREEZE or THROUGH) by choosing either "YES" or "NO" on the operation screen.

THROUGH DISPLAY	Description
NO	Measurements can be made on a frozen image.
YES	Measurements can be made on a through image.

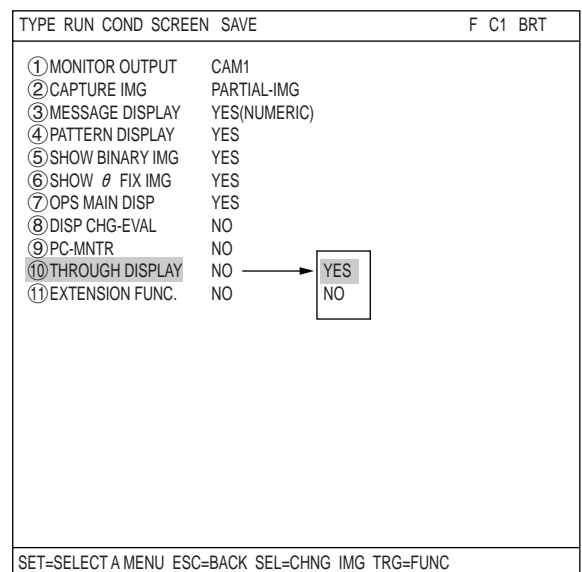

[11] Extension functions

The extension function has crosshair cursor display and manual display functions.

(1) Crosshair cursor display

The crosshair cursor can be displayed on any position.

- "1" equals a 16-pixel line. "2" equals a full line.
- The initial coordinates of the crosshair cursor center are (256,240)

■ Operation procedure

1. On the "TYPE RUN COND" screen, move the cursor to item "①EXTENSION FUNC." using the up and down keys, and press the SET key.
2. Select "DISPLAY+CURSOR" on the popup menu and press the SET key.
3. Press the SET key on the "⑫DISPLAY+CURSOR 1" line and select "1" or "2" on the popup menu. Then press the SET key.
4. Select "⑬CROSS CURSOR COORD" and press the SET key. Now, the crosshair appear on the screen. Move the crosshair cursor using the up/down/left/right arrow keys. (It moves one pixel at a time)
5. When the cursor is positioned where you want it, press the SET key to confirm the position.

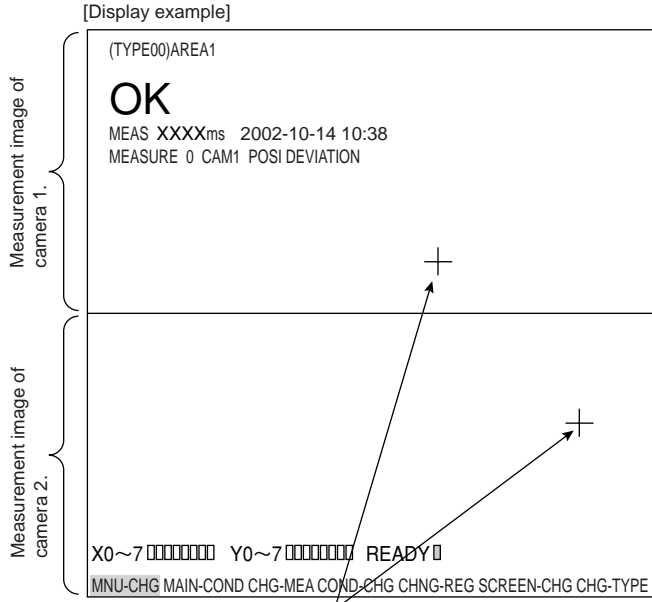

Displays two crosshair cursors.

If you select "⑭DISPLAY+CURSOR 2," you can display two cursors when you output monitor images from Cameras 1 and 2.

TYPE RUN COND SCREEN SAVE		F C1 BRT
① MONITOR OUTPUT	CAM1	
② CAPTURE IMG	PARTIAL-IMG	
③ MESSAGE DISPLAY	YES(NUMERIC)	
④ PATTERN DISPLAY	YES	
⑤ SHOW BINARY IMG	YES	
⑥ SHOW θ FIX IMG	YES	
⑦ OPS MAIN DISP	YES	
⑧ DISP CHG-EVAL	NO	
⑨ PC-MNTR	NO	
⑩ THROUGH DISPLAY	NO	
⑪ EXTENSION FUNC.	DISPLAY+CURSOR	
⑫ DISPLAY+CURSOR 1	1	1
⑬ CLOSS CURSOR COORD	SET (256,240)	2
⑭ DISPLAY+CURSOR 2	NO	

NO
DISPLAY+CURSOR
 MANL-MEAS

SET=SELECT A MENU ESC=BACK SEL=CHNG IMG TRG=FUNC

(2) Manual measurement

With this function, you can measure distance between two points, the distance between X coordinates, or the distance between Y coordinates that were selected manually on the operation main screen.

Operation procedure

1. Select "⑪ EXTENSION FUNC." on the "TYPE RUN COND" menu using the up and down arrow keys. Then press the SET key.
2. Select "MANL-MEAS" on the popup menu and press the SET key.

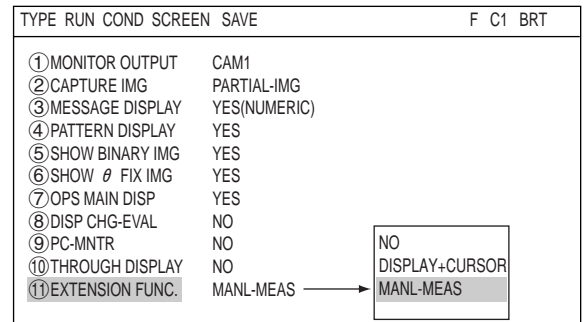

3. Move the cursor to the upper function menu by pressing the TRG/BRT key and select "SCREEN." Then press the SET key. Select "OPS-MENU" on the popup menu and return to the operation screen.

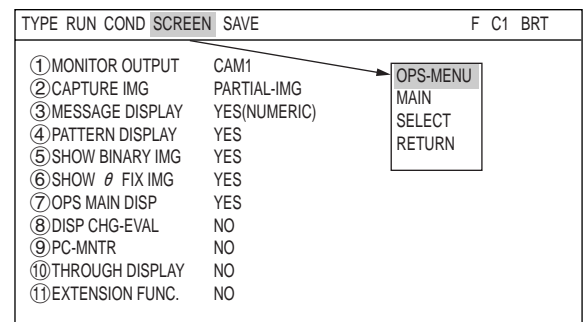

4. Move the cursor to the "MNU-CHG" (menu change) item on the bottom of the operation screen and press the SET key to change the bottom menu display. Move the cursor to "MANL-MEAS" (manual measurement) and press the SET key.

5. The menu items for manual measurements will appear on the screen.
6. Select "① CURSOR1-COORD" or "② CURSOR2-COORD" and press the SET key.
7. Move cursor 1 or cursor 2 using the up/down/left/right keys. (They move one pixel at a time.)
⇒ The distance between the two points, and between the X coordinates and Y coordinates for the two points, will change on real time basis.

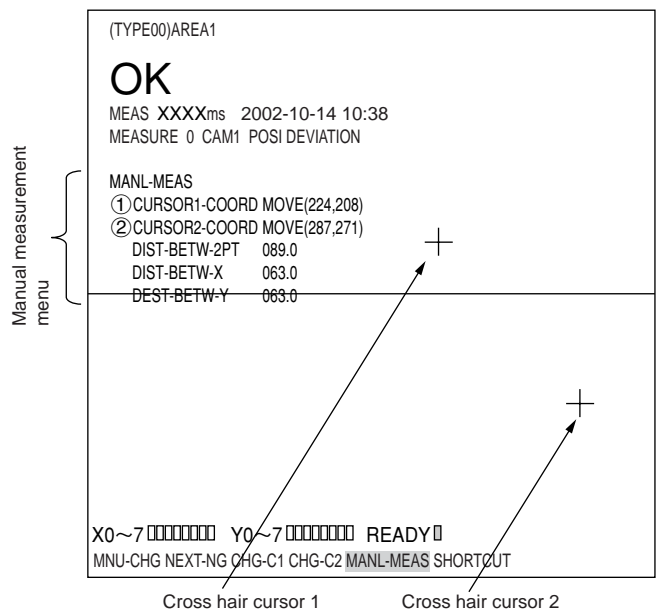

8. After the positions of the points are determined, press the SET key.
9. When the operation is complete, press the ESC key.
⇒ The manual measurement menu items will disappear.

2-2 Setting the system conditions

Set the following items on the "SYS-CND" menu to set the system conditions for the controller.

■ Setting item

- Input/output conditions
- Communication setting
- Computer link
- Gain/offset
- Time
- Camera type

■ For the following items, see the pages listed below.

- Input/output conditions ⇨ Chapter 17
- Communication setting ⇨ Chapter 18
- Computer link ⇨ Chapter 19

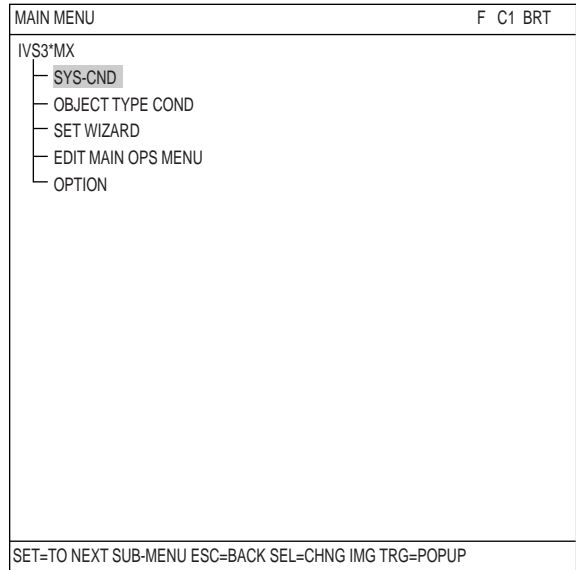

[1] Manually setting the object type

On the operation screen, the object type (IV-S32MX/ S33MX: 00 to 31, IV-S31MX: 00 to 15) can be changed manually (using the remote keypad).

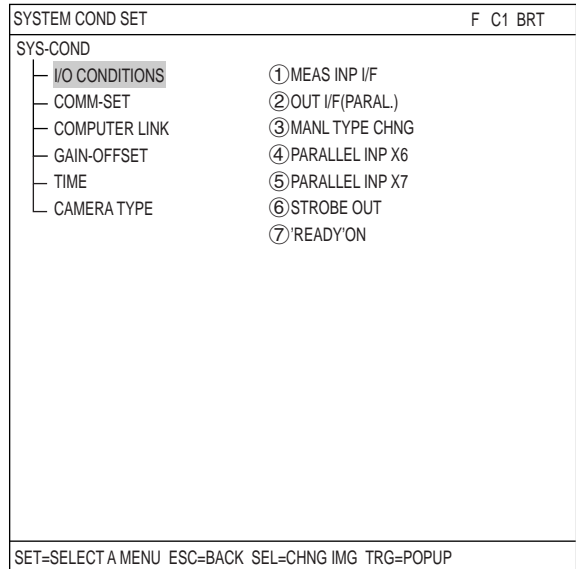

On the MAIN MENU, select "SYS-CND" -> "I/O CONDITIONS" -> "③MANL TYPE CHNG" in that order and then select "YES" or "NO" on the popup menu.

MANL TYPE CHNG	Description
YES	The type can be manually changed on the operation screen. Note: If the "③MANL TYPE CHNG" is set to "YES," the type cannot be changed with an external interface (parallel I/O or general purpose serial interface).
NO	The type cannot be manually changed on the operation screen.

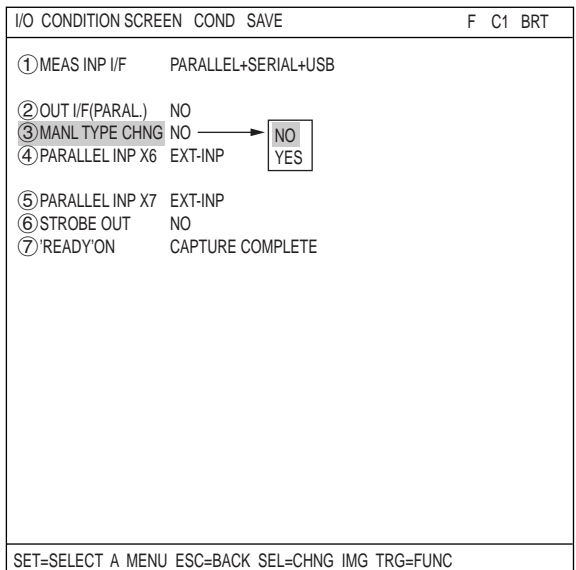

[2] Gain/offset adjustment

The gain and offset of the IV-S30 can only be adjusted by our service engineers. Users must not try to change them.

The data which can be adjusted is shown below for reference purpose only.

Generally, an image from the CCD camera can be optimized by adjusting the optical system, such as the lens iris. To make fine adjustments, the IV-S30 is equipped with functions to adjust the offset and gain of image signals from cameras 1 and 2 and the contrast on an external monitor screen.

- The gain and offset are adjusted by checking the display on the screen.
- The screen is kept in the through mode.

● **Setting method**

On the MAIN MENU, select "SYS-CND" -> "GAIN OFFSET" and the following message will appear on the screen.

CHANGING A SETUP MAY LEAD TO A MACHINE FAILURE. DO YOU CHANGE IT?

(YES=SET,NO=ESC)

GAIN-OFFSET	SCREEN	COND	SAVE	F C1 BRT
① OFFSET	(CAM1)	+(↑) -(↓)	(026)	
② GAIN	(CAM1)	+(↑) -(↓)	(245)	
③ OFFSET	(CAM2)	+(↑) -(↓)	(026)	
④ GAIN	(CAM2)	+(↑) -(↓)	(245)	
⑤ CONTRAST	(MNTR)	+(↑) -(↓)	(055)	

SET=VALUE INPUT ESC=BACK SEL=CHNG IMG TRG=FUNC

Pres the SET key the "GAIN OFFSET" screen at the right appears.

Gain and offset adjustment	Details of adjustment (selection)
① OFFSET (CAM1)	The offset for camera 1 is adjusted with the up and down keys. - The complete signal level is shifted leaving the amplitude of the image signals from the CCD camera unchanged. As the offset value is increased, the whole screen will becomes more white.
② GAIN (CAM1)	The gain for camera 1 is adjusted with the up and down keys. - The amplitude of the image signals from the CCD camera is changed. As the gain value is reduced, the screen will become lighter, and as the gain value is increased, the screen will become darker.
③ OFFSET (CAM2)	The offset for camera 2 is adjusted with the up and down keys. - The adjustment procedure is the same as that in Item ①.
④ GAIN (CAM2)	The gain for camera 2 is adjusted with the up and down keys. - The adjustment procedure is the same as that in Item ②.
⑤ CONTRAST (MNTR)	The monitor contrast is adjusted with the up and down keys. - The intensity of image signals sent to the monitor is adjusted. As the contrast value is increased, the contrast on the screen will become stronger.

[3] Setting the system time (IV-S32MX/S33MX)

When the IV-S32MX/S33MX is used, set the time displayed on the monitor.

When delivered, the IV-S30 is set to Japanese standard time. If the time in your location is different, please adjust the time.

■ Operating procedure

1. Select "TIME" on the "SYS-CND" menu and press the SET key.
2. Move the cursor to "Minute," "Day," "Hour," "Month," and "Year" using the left and right keys, and enter the correct value at each location using the up and down keys.
Y = 1999 to 2098
M = 01 to 12
D = 01 to 31
H = 00 to 23
MIN. = 00 to 59
3. Press the SET key. The time will be set and the system will start using the new time.

TIME	SCREEN COND SAVE	F C1 DRK
① TIME	2001-10-24 15:29	
SET=VALUE INPUT ESC=BACK SEL=CHNG IMG TRG=FUNC		

2-3 Camera settings

[1] Camera selection (IV-S32MX/S33MX)

The cameras that are compatible with the controller (IV-S31MX/S32MX/S33MX) are as follows:

Controller	Compatible cameras
IV-S31MX	IV-S30C1 (standard camera)
IV-S32MX	IV-S30C2 (micro camera)
IV-S33MX	IV-S30C1 (standard camera)
	IV-S30C2 (micro camera)
	IV-S30C3 (high-speed camera)
	IV-S30C4 (micro, high-speed camera)
	EIA cameras (commercially available)

* Mixed use of different camera types is not supported.

- **When the IV-S31MX/S32MX is used**

The IV-S31MX/S32MX can only support standard cameras (IV-S30C1/C2). That is why no setting alternatives are shown for the camera type.

- **When the IV-S33MX is used**

The IV-S33MX can be connected to standard cameras (IV-S30C1/C2), high-speed cameras (IV-S30C3/C4), and commercially available EIA cameras. Select the camera specifications (camera synchronization, image capture mode) in "CAMERA TYPE" on the "SYS-CND" screen, according to the camera you are using.

■ Operating procedure

1. Select the "①SELECT CAMERA" item on the "SYS-CND" screen and press the SET key.
2. Select the camera type you will use: "STANDARD", "HIGH SPEED", or "EIA."

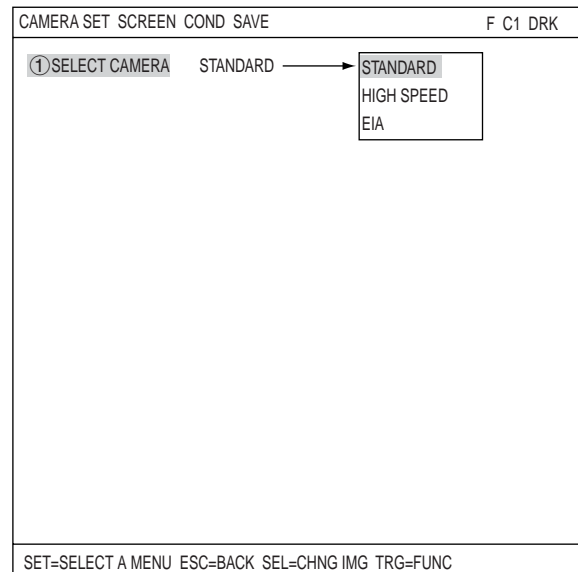

Compatible cameras		IV-S30C1 (standard) IV-S30C2 (micro)	IV-S30C3 (high-speed) IV-S30C4 (micro and high-speed)	EIA camera (commercially available)
Camera settings (system conditions)	Camera selection	Standard	High speed	EIA
	Camera synchronization ⇒ See page 2-15	---	---	External or internal synchronization
	Image capture mode ⇒ See page 2-18	---	Full, half, or full + half mode	Full or half mode

[2] Image capture mode (IV-S33MX)

When you are using the IV-S33MX controller and IV-S30C3/C4 high-speed camera or an EIA camera, you have to select an image capture mode.

Image capture mode	Details
Full	Capture all of the lines in the image
Half	Capture the odds lines in the image
Full + half *	In the partial image mode, the measurement target lines are in full mode and the others are in half mode

* The "Full+half" can be selected when "①SELECT CAMERA" is set to "HIGH-SPEED."

■ Comparative examples of image capture times

① When a standard camera is used and the partial image size is 50 % (240 lines / 480 lines).



Image --- 33.3 ms capture time

16.7 ms

- For details about whole and partial images ⇨ See page 2-4.

② When a high-speed camera is used and the partial image size is 50 % (240 lines / 480 lines).

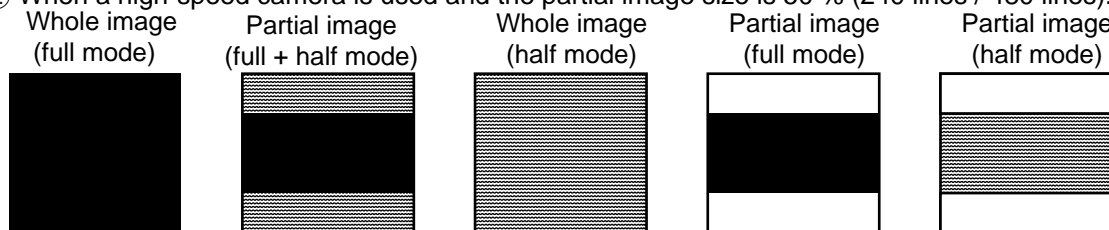

Image --- 16.7 ms capture time

12.5 ms

8.3 ms

8.3 ms

4.2 ms

■ Processing details of the image capture mode

Image capture mode	Full	Full + half	Half
Image capture	- Transfer the specified lines	- Transfer only the full mode area	- Correct the specified area and transfer - The even line image will be supplemented by the odd line image.
Process for setting up the screen	- Put all of the captured line area in the full mode	- Put all of the captured line area in the full mode	- Put all of the captured line area in the half mode.
Process from run to setting up the screen	---	- Delete the half mode area	---

[3] Camera synchronization (IV-S33MX)

When an EIA camera is used with the IV-S33MX controller, you have to set the camera synchronization mode (internal or external synchronization).

(1) Internal and external synchronization details

① Internal synchronization

This mode uses the CCD image capture timing inside the camera, and captures images automatically.

- To send a captured image to the IV-S33MX, first the IV-S33MX must send a trigger to the camera. Then the camera will wait until the first line from its CCD is being to begin the capture and image transmission. Due to this process (camera synchronization time + monitor output synchronization time), the shutter time may fluctuate (maximum: 33.3 +16.6 ms).
- When two cameras are connected, both camera 1 and camera 2 cannot open the shutter at the same time. Therefore, there will be difference of shutter timing described above.

② External synchronization

The IV-S33MX controls the shutter speed and trigger timing in order to capture images. See the next page for the internal/external synchronization timing charts.

• External synchronization and internal synchronization processing

	Internal synchronization	External synchronization
Shutter time	Fixed by the camera design	Settable from the IV-S33MX
Shutter speed	- Fluctuates with the camera synchronization time and the monitor output synchronization time (maximum 49.9 ms for each camera)	Fixed value (depends on the shutter speed) - When the shutter speed is 1/120, this value is 8.3 ms - Setting range varies with the camera connected.

• Shutter speeds of the recommended cameras

Cameras recommended		Sony XC-75	Tokyo Electronics Industry CS8320B
Shutter speeds	Internal synchronization (selected on the camera)	1/125, 1/250, 1/500, 1/1000 1/2000, 1/4000, 1/10000	1/125, 1/250, 1/500, 1/1000 1/2000, 1/4000, 1/10000
	External synchronization	1/100 to 1/1600	1/125 to 1/1500

(2) Setting the IV-S30EA1 and IV-S33MX for use with an EIA camera

Set the IV-S30EA1 camera converter, and the IV-S33MX controller to internal or external synchronization, to match the EIA camera you have.

Item	Setting details		Reference
	For internal synchronization	For external synchronization	
EIA camera (commercially available)	Set to "Internal synchronization" mode	Set to "External synchronization" mode	*1
IV-S30EA1 mode switch (MODE)	INT	EXT	*2
IV-S33MX camera setting (system condition)	Camera selection: EIA Camera synchronization: Internal synchronization	Camera selection: EIA Camera synchronization: External synchronization	Page 2-19

* 1: For example, set the Tokyo Electronics Industries CS8320B camera dip switches as follows:

Function [Dip switch SW4]	Use internal synchronization	Use external synchronization
γ correction [1]	OFF	OFF
CCD storage mode [2]	OFF (frame storage)	ON (field storage)
Restart and reset [3]	OFF	ON
Special shutter [4]	OFF	ON
VD output/FLD output [6]	OFF (VD output)	OFF (VD output)

* 2: See the IV-S30 (IV-S31MX/S32MX/S33MX) User's Manual (Introduction and Hardware).

(3) Timing chart

■ Internal synchronization

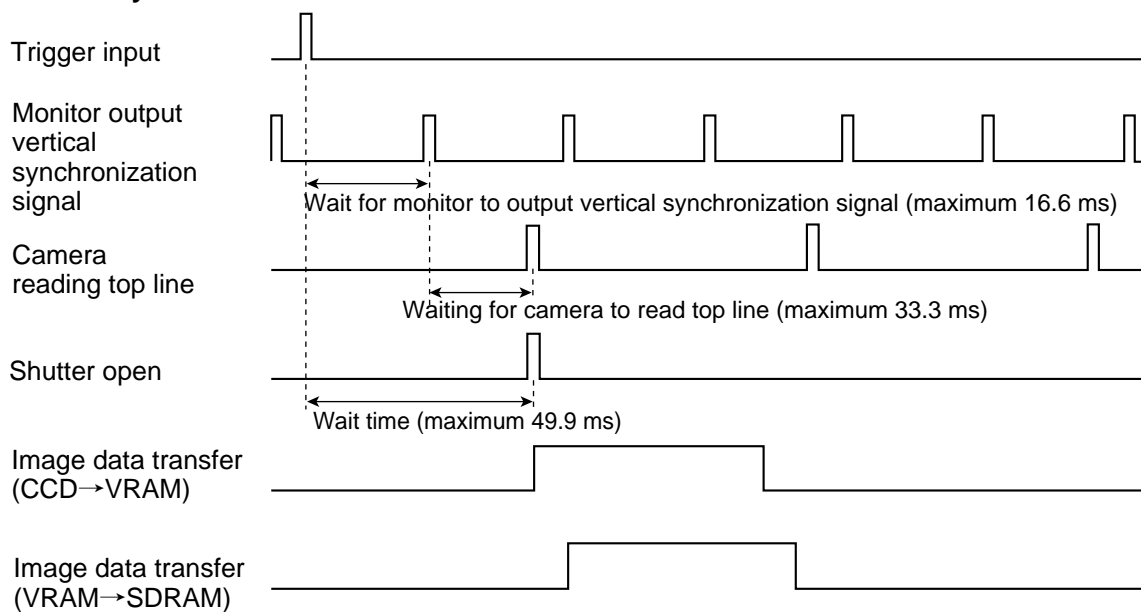

■ External synchronization

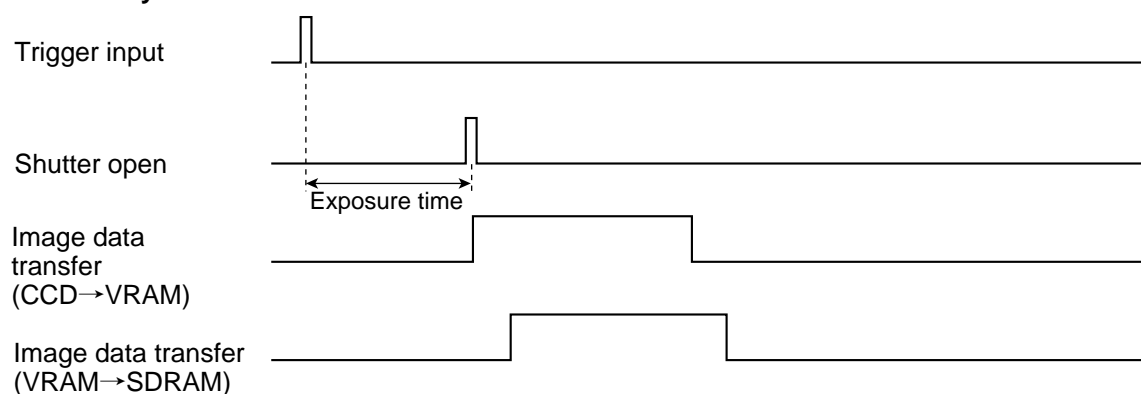

Note: When an EIA camera is used, the last (lowest) line (line 479) may not be captured successfully due to the camera's characteristics.

2-4 Editing Operation screen

In this controller, the operation screen display can be changed. You can move, enlarge, reduce, or hide any block of text

- (1) Move the cursor to "MAIN-MENU" on the operation screen and press the SET key.
- (2) Move the cursor to "EDIT MAIN OPS MENU" and press the SET key.

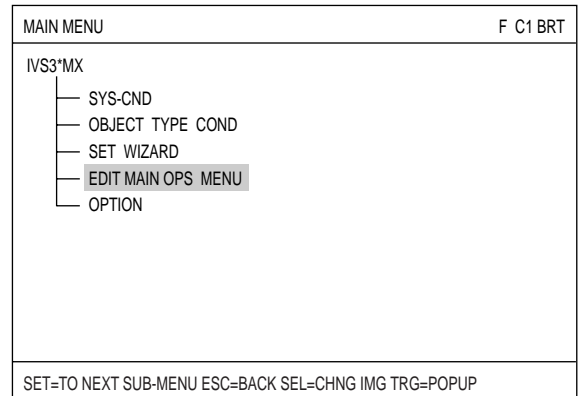

- (3) Now the operation screen will appear. Select a block of text you want to edit using the up, down, left, and right arrow keys, and press the SET key. A pop up menu will appear and you can select from move, enlarge, reduce, and hide. (In this example, the block of text "OK" is selected.)

- **MOVE**

Select "MOVE" using the SET key. Now the highlighted block of text can be moved using the up, down, left, and right arrow keys. When the text is in the desired new position, press the SET key again.

- **MAGNIFICATION/REDUCTION**

Move the cursor to the "MAGNIFICATION" or "REDUCTION" line and press the SET key. The highlighted block of text can be enlarged or reduced.

- **NON-DISP**

Move the cursor to the "NON-DISP" line and press the SET key. The highlighted block of text will be deleted.

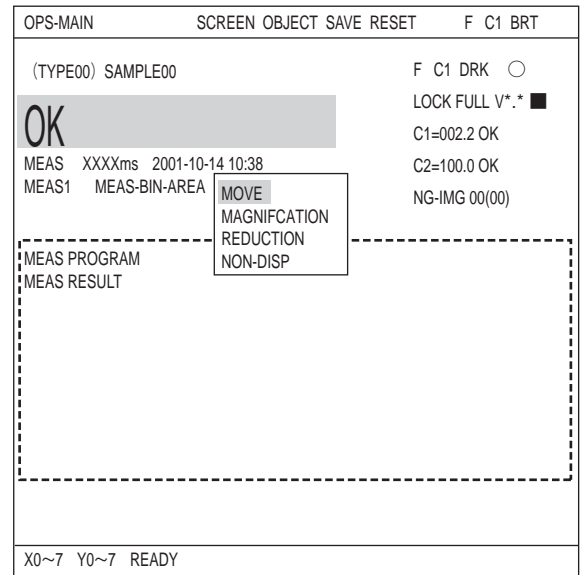

2-5 Option

With the IV-S30, you can initialize the measurement settings, and run a self-diagnosis from the option menu.

Setting method

1) Display the "OPTION" from the "MAIN MENU."

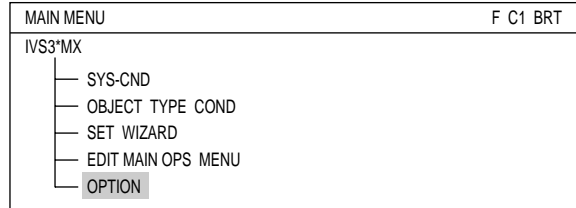

2) Select the operation you want, such as "①INITIALIZATION" or "②SELF DIAGNOSIS."

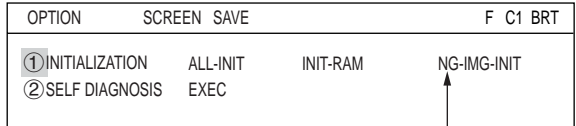

Displayed when the controller is the IV-S32MX/S33MX

① INITIALIZATION

Select any of the "ALL-INT" (initialize both FROM and RAM), "INT-RAM" or "NG-IMG-INT"(IV-S32MX/S33MX) and the following message will appear.

① MEM INIT?(YES=[SET], NO=[ESC])

Press the SET key to start the initialization. The bar shown below will appear and display the progress of the initialization.



After the initialization is complete, the word "INITIALIZING" will change to "COMPLETE INIT." Press the ESC key to return to main screen.

② SELF DIAGNOSIS

Select "②SELF DIAGNOSIS" and press the SET key twice. The controller will execute a self-diagnosis and display the results of the diagnosis, as shown right. If the diagnosis results are normal, "OK" will be displayed. If the results are abnormal, "NO" will be displayed.

When the diagnosis is complete, the "DIAGNOSING" display will change to "COMPLETE DIAGNOSIS."

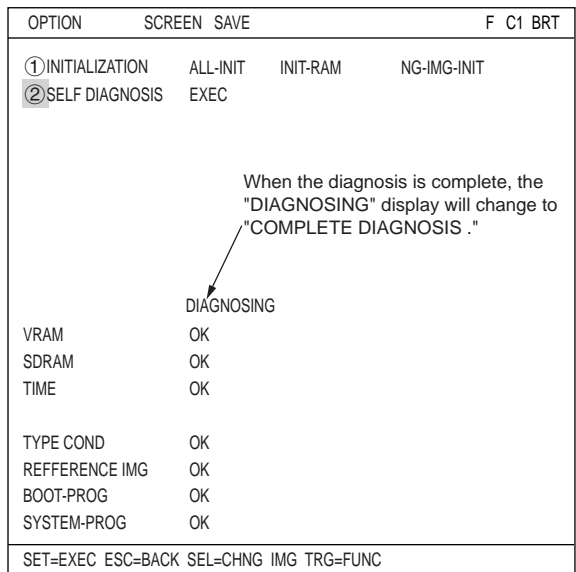

When the diagnosis is complete, the "DIAGNOSING" display will change to "COMPLETE DIAGNOSIS."

Chapter 3 : Setting Measurement Conditions

3-1 Outline

The measuring conditions for each object type are set on the "OBJECT TYPE COND" (conditions for object type) menu.

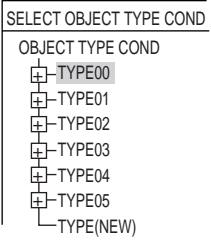

Available object type numbers

IV-S31MX	0 to 15
IV-S32MX	0 to 31
IV-S33MX	

How to enter the setting screen

On the MAIN MENU, move the cursor to "OBJECT TYPE COND" and press the SET key. The "SELECT OBJECT TYPE COND" screen will appear. Select "TYPE00," "MEA-CND(CAMERA1)," and "MEAS0" or "MEAS(NEW)."

Note: "MEAS0" is only used for measuring positional deviation.

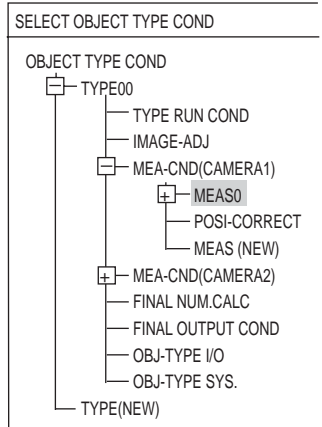

Choose a measurement program from the popup menu at "① MEAS SELECTION" to bring up the "MEAS CND" screen.

⇒ For details, see Chapter 8: "Setting Example Using the Menu Tree" in the Instruction and Hardware.

Note: New measurement programs are allocated to "MEAS01" through "MEAS04." The smallest measurement number available (from 1 to 4) will be assigned. "MEAS0" is dedicated to positional deviation measurements.

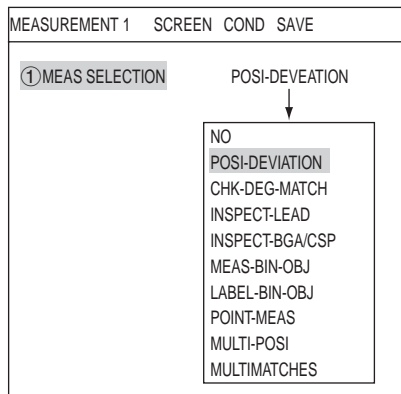

■ Setting procedure

A general outline of the setting procedures is shown below. For details, see each chapter.

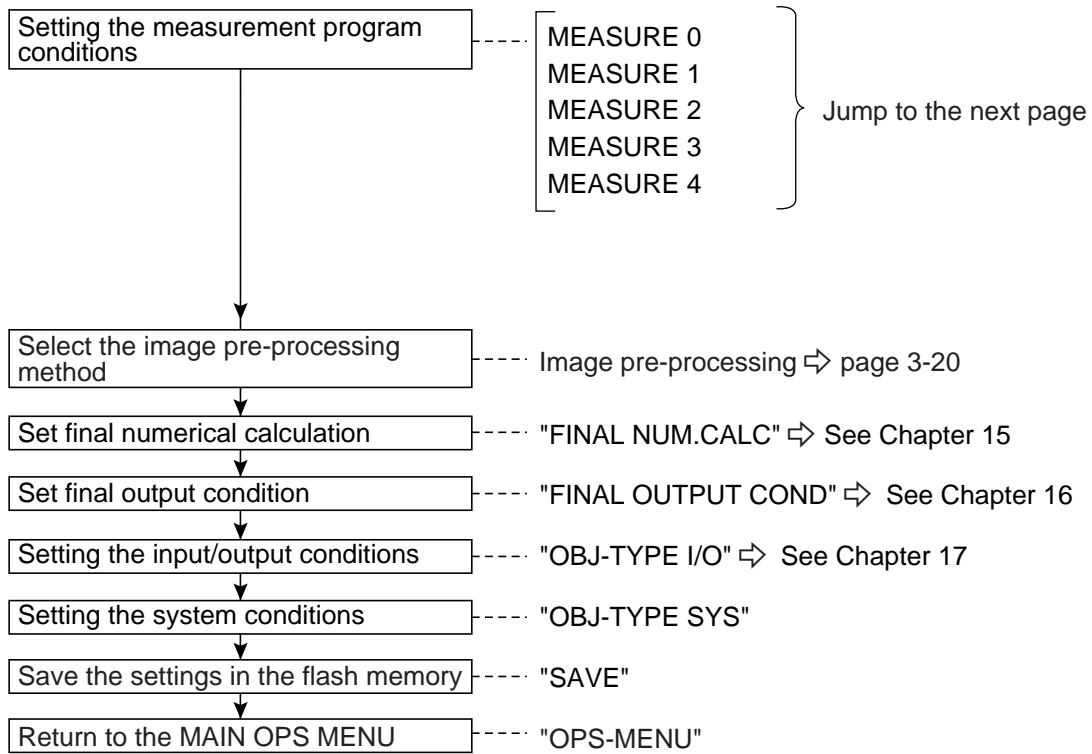

3

■ Outline of setting the measurement program

The measurement program can be specified from "MEAS0" through "MEAS4." (Camera1/camera 2)

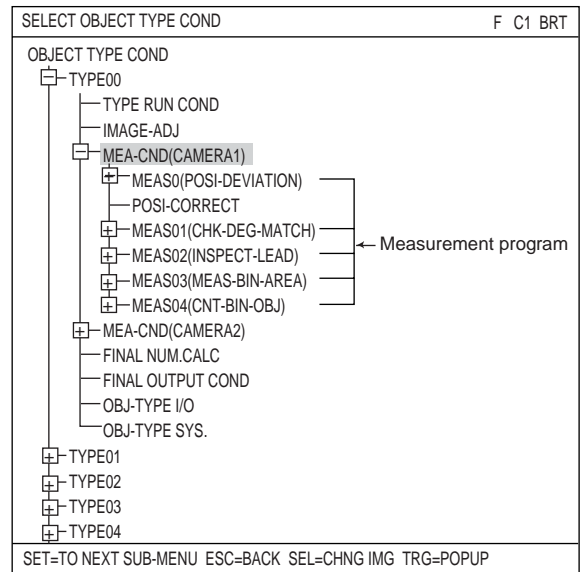

When you want to specify the measurement conditions using "POSI-DEVIATION."

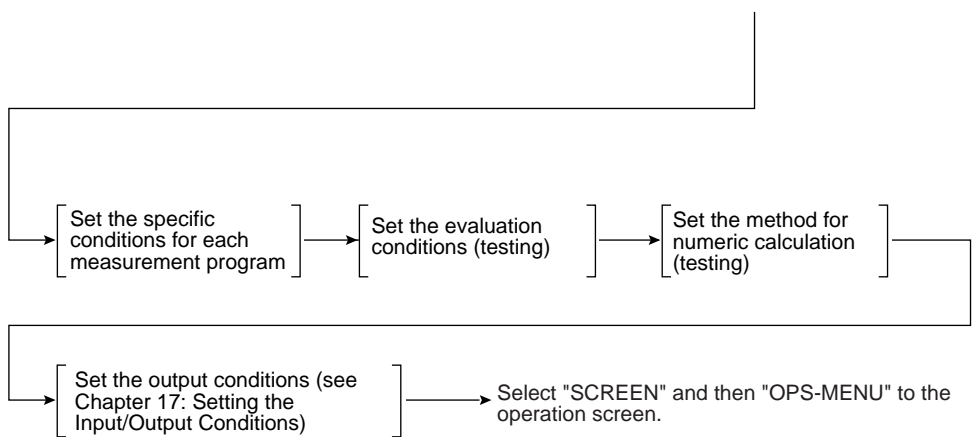
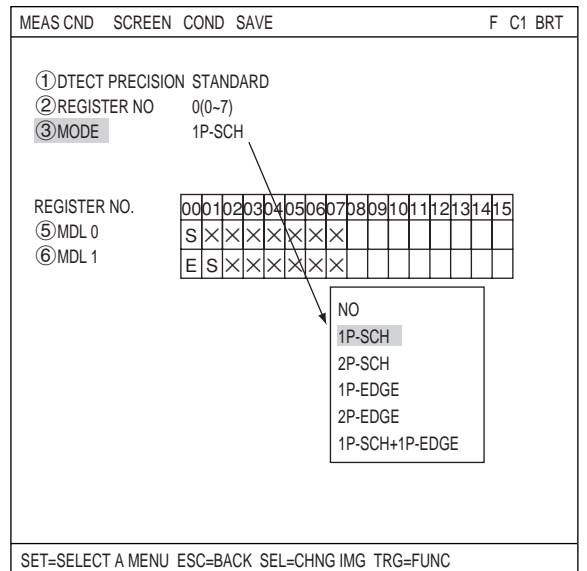

3-2 Shared settings

[1] Camera selection

Specify which cameras to use (Camera 1, Camera 2) in "MEA-CND" on the "OBJECT TYPE COND" menu for each object type.

SELECT CAMERA	Description
CAM1&2	Camera 1 and camera 2 can be used for measurements (0 to 4) and for image pre-processing.
CAM1&NG-IMG	Only camera 1 can be used for measurements (0 to 4) and image pre-processing. Using camera 1, NG images can be displayed on the monitor. - See page 1-19.

Note: Before choosing the NG screen, you will first have to change Camera 2 to NG screen.

⇒ For details, see page 1-17

When the select camera is changed from "CAM1&2" to "CAM1&NG-IMG," the setting details for "MEASURE0 CAM2" and "MEASUREMENT1 to 4" are initialized.

Setting method

To set the output to the monitor, select "①MONITOR OUTPUT" on the "TYPE RUN COND" menu.

1. On the "OBJECT TYPE COND" screen, select "TYPE00" and "TYPE RUN COND."

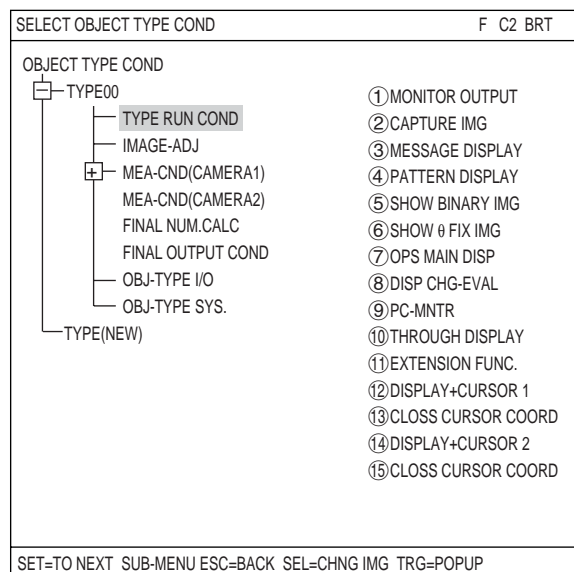

2. On the "TYPE RUN COND" screen, select "①MONITOR OUTPUT." Then, select "NG-IMGS" from the popup men.

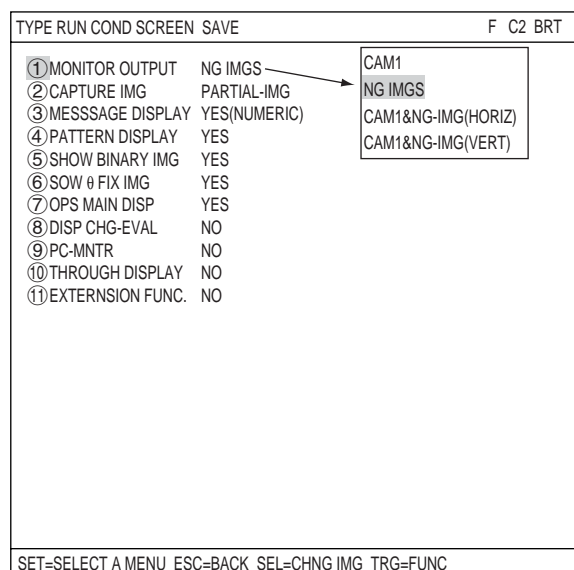

■ Relationship between the camera selection and the monitor output

Select camera on the "MEA-CND" menu	"MONITOR OUTPUT" on the [TYPE RUN COND] menu	
CAM1&2	CAM1	
	CAM2	
	CAM1&2 *1	
	CAM1&2 (VERT)	*2
	CAM1&2(HORIZ)	
CAM1&NG-IMG	CAM1	
	NG-IMG	
	CAM1&NG-IMG *1	
	CAM1&NG-IMG (VERT)	*2
	CAM1&NG-IMG(HORIZ)	

*1 When the IV-S31MX/S32MX is used.
*2 When the IV-S33MX is used.

[2] Window shape selection and settings

This section describes how to select and set the window shapes used for image processing (e.g. rectangular windows, horizontal or vertical line boundaries, circle windows, elliptical windows, and polygonal windows). This can be done using the up, down, left, and right setting keys on the remote key pad.

EX: Registr conditions of "Positional deviation measurement."

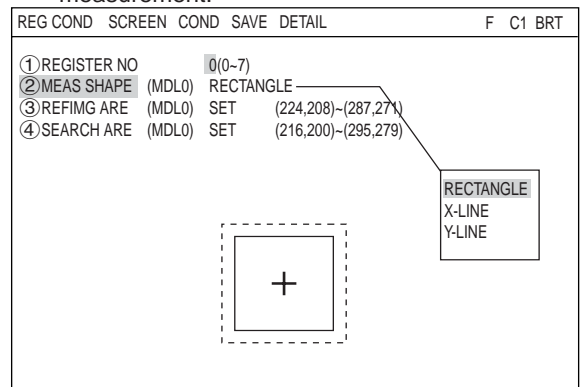

Line type	Image processing used	Measurement programs
Solid lines	Reference image for gray scale search and binary image matching	Positional deviation measurement (gray scale search), degree of match inspection, lead inspection, multiple position measurement (gray scale search), and multiple degree of match inspection.
	Window containing a binary image	Area measurement by binary conversion, object counting by binary conversion, object identification by binary conversion.
Dotted lines	Gray scale search area detection	Positional deviation measurement (gray scale search), degree of match inspection, lead inspection (criteria search), multiple position measurement (gray scale search) and multiple degree of match inspection.
	Edge of an area detection	Positional deviation measurement (edge detection), multiple position measurement (edge detection).
	Binary image window mask	Area measurement by binary conversion, object counting by binary conversion, object identification by binary conversion.

(1) Rectangular window

■ How to set a rectangular window

1. Moving the mask

- Up key

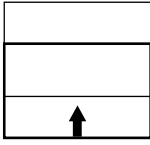

- Down key

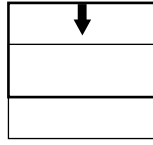

- Left key

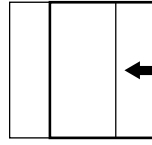

- Right key

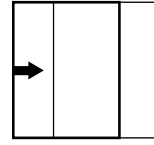

2. Specifying the upper left corner

- Up key

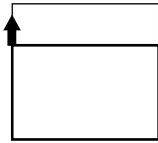

- Down key

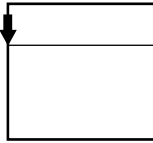

- Left key

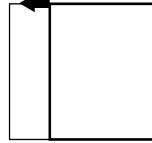

- Right key

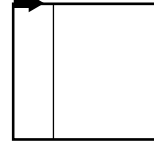

3. Specifying the lower right corner

- Up key

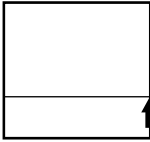

- Down key



- Left key

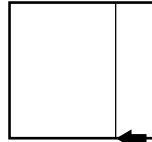

- Right key

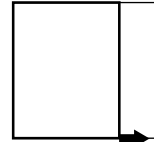

■ To register reference images

To register reference images, the system should be in the "Freeze" mode.

⇒ See page 1-10

■ Window specifications

	Line type	Move	Size	Minimum	Maximum
Reference image	Solid line	One pixel at a time	In unit of one pixel	16 x 16 (pixel)	X x Y (X*Y = 65536 pixels)
Search area	Dotted line	One pixel at a time	In unit of one pixel	16 x 16 (pixel)	512 x 480 pixels

(2) Horizontal/vertical lines

Line type	Image processing used	Measurement programs
Solid lines	Gray scale search (reference image)	Positional deviation measurement (gray scale search), degree of match inspection, lead inspection (criteria search).
	Edge of an area detection	Lead inspection
Dotted lines	Gray scale search line detection	Positional deviation measurement (gray scale search), degree of match inspection, lead inspection (criteria search).

■ How to set horizontal lines

The following items on the settings menu can be used to define lines: MOVE, S.P.T, E.P.T. Shown here is an example of how to define a solid line.

1. Move

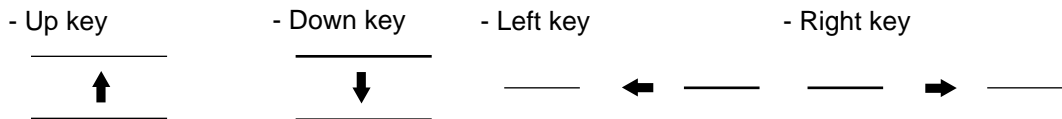

2. Specifying the starting point

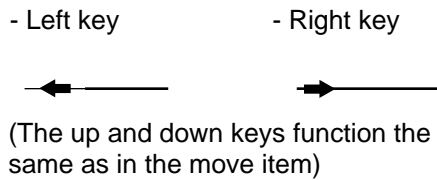

3. Specifying the ending point

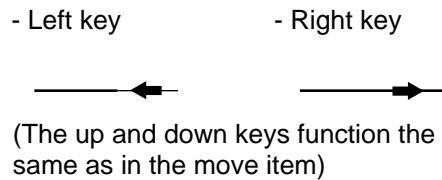

■ How to set vertical lines

1. Move

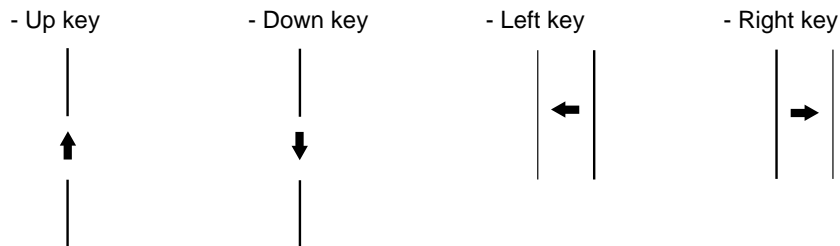

2. Specifying the starting point

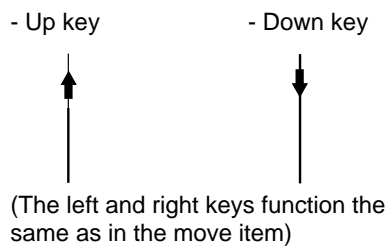

3. Specifying the ending point

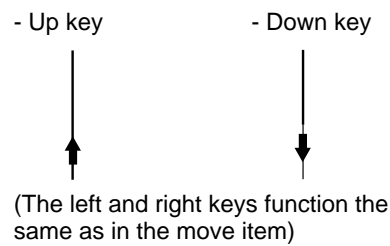

■ To register reference images

To register reference images, the system should be in the "Freeze" mode.
 ⇨ See page 1-10.

■ Window specifications

- Horizontal lines

	Line type	Move	Length	Min. length	Max. length
Reference image	Solid line	Horizontal direction: One pixel at a time	In units of pixels	8 pixels	512 pixels
Search area	Dotted line	Vertical direction: One pixel at a time			

- Vertical lines

	Line type	Move	Length	Min. length	Max. length
Reference image	Solid line	Horizontal direction: One pixel at a time	In units of pixels	8 pixels	480 pixels
Search area	Dotted line	Vertical direction: One pixel at a time			

When setting the horizontal and vertical lines, specify the line length as follows:
The reference image must shorter than the search area lines.

(3) Circle window

Line type	Image processing used	Measurement programs
Solid lines	Window containing a binary image	Area measurement by binary conversion, object counting by binary conversion, object identification by binary conversion
Dotted lines	Binary image window mask	Area measurement by binary conversion, object counting by binary conversion, object identification by binary conversion

■ How to set a circle window

The following items on the settings menu can be used to define the circle window: CENTER, RAD. Shown here is an example of how to define a solid line circle window.

1. Specifying the center

- Up key

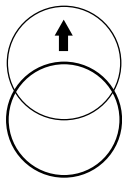

- Down key

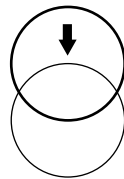

- Left key

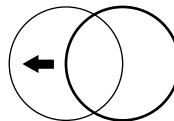

- Right key

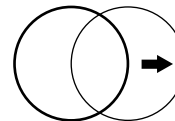

2. Specifying the radius

- Up/right key

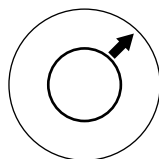

- Down/left key

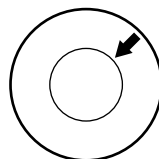

(4) Elliptical window

Line type	Image processing used	Measurement programs
Solid lines	Window containing a binary image	Area measurement by binary conversion, object counting by binary conversion, object identification by binary conversion
Dotted lines	Binary image window mask	Area measurement by binary conversion, object counting by binary conversion, object identification by binary conversion

■ **How to set an elliptical window**

The following items on the settings menu can be used to define the elliptical window: CENTER, RAD. Shown here is an example of how to define a solid line elliptical window.

1. Specifying the center

- Up key

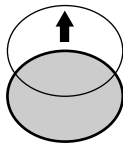

- Down key

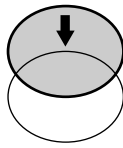

- Left key

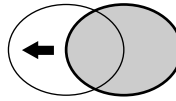

- Right key

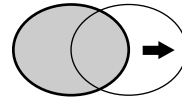

2. Specifying the radius

- Up key

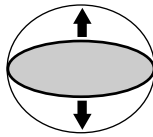

- Down key

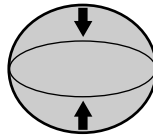

- Left key

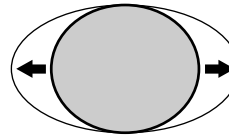

- Right key

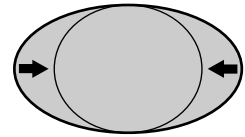

(5) **Polygonal window**

With the binary area measurement function, object counting after binary conversion function, object identification after binary conversion function, or point measurement after binary conversion function, you can create any shape of polygonal window with up to 32 sides, in addition to the rectangles, circles, and ovals that were available in previous versions.

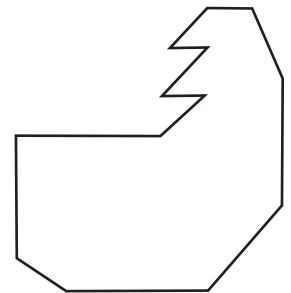

Any polygonal window (up to 32 sides)

■ **How to create a window**

On the "POLYGON" setting screen, specify a coordinate using the up, down, left, and right arrow keys, and then press the SET key. Thereafter, specify points 02, 03 and so on, in numerical order. After specifying the last coordinate, press the SET key again to confirm the polygonal shape you have drawn.

To edit the polygonal shape, select a point to modify using the up and down arrow keys, and press the SET key. A popup menu will appear. Select CHANGE, INSERT or DELETE.

- ① 6P (305,153)
- ② 7P (305,186)
- ③ 8P (272,186)
- ④ 9P (272,211)
- ⑤ 10P (243,211)
- ⑥ 11P (243,236)
- ⑦ 12P (217,239)
- ⑧ 13P (217,239)

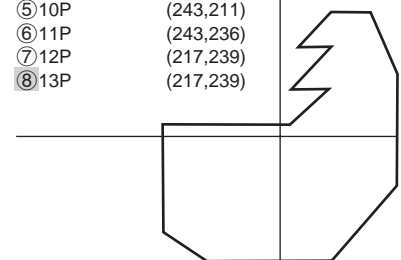

[3] Image settings

What follows is a description of how to use the image settings to control the measuring program.

(1) Pixel contraction and detection precision (gray scale processing)

■ Measurement condition setting screen

The display will change from 1 to 2 to 3 using the up and down arrow keys.

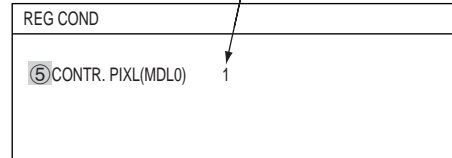
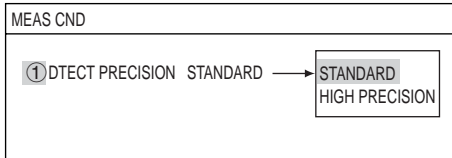

Note: At the "DETAIL" item in the upper function menu, select "CONTR.PIXEL." Then, "5 or 9 CONTR.PIXL" will appear on the screen.

Menu	Description
① DTECT PRECISION (detection precision)	<p>- STANDARD (standard): Detection precision of 1 pixel unit level</p> <p>- HIGH (High precision): Detection precision of 1/10 pixel unit level</p> <p>(High precision) Search coordinates use a sub-pixel level of precision (1/10)</p> <p>(Standard) Search coordinates use a 1 pixel level of precision</p> <p>Reference image</p> <p>Camera image</p> <p>High precision pixel detection</p> <p>Standard pixel detection</p> <p>Point of detection</p> <p>Pixel</p> <p>Point of detection</p>
⑤ ⑨ CONTR. PIXL (Grey search scale conditions)	<p>- 1: Search the scanned image in groups of 2 pixels.</p> <p>- 2: Search the scanned image in groups of 4 pixels.</p> <p>- 3: Search the scanned image in groups of 8 pixels.</p>

- To increase the speed of your search, you must take into account the settings listed below.
 1. When using the high precision setting, a smaller image should be used.
 2. Reduce the size of the scanned image.
 3. After considering what the maximum out of position dimension would be, make the search area as small as possible.
 4. If the size of the object is larger than 8 pixels then set the pixel contraction to "3".

■ Measurement programs which are affected by these settings

Positional deviation measurement (gray scale search), degree of match inspection, lead inspection, multiple position measurement, and multiple degree of match inspection.

(2) Threshold value setting

The IV-S30 treats the "areas darker than the lower limit value" or "brighter than the upper limit value" as "black." It treats that the areas between the upper limit value and lower limit value as "white." However, if the white-black reverse function is enabled, conversion to white/black will be reversed. Normally, if you want to use only one threshold value for binary conversion, set the upper limit value to "255." Then you only need to adjust the lower limit value to a threshold value that works for our application.

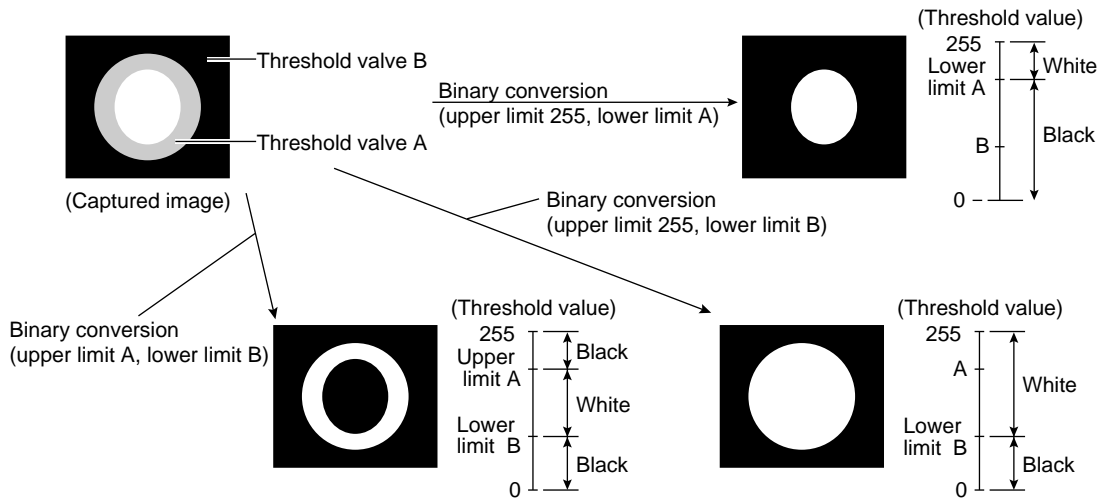

■ **Setting the threshold value automatically**

The binary threshold value can be set automatically.

In the binary area condition of each measurement program, execute the "AUTO REGIST" function (lower limit only or upper and lower limits) and the optimum threshold values will be set in each measurement area automatically.

- The binary area conditions (binary image mask) menu in the binary area measurement.

■ **Measurement programs which are affected by these settings**

BGA/CSP inspection, area measurement by binary conversion, object counting by binary conversion, object identification by binary conversion, point measurement (binary images)

- Binary area condition (binary image mask) menu of the binary area measurement

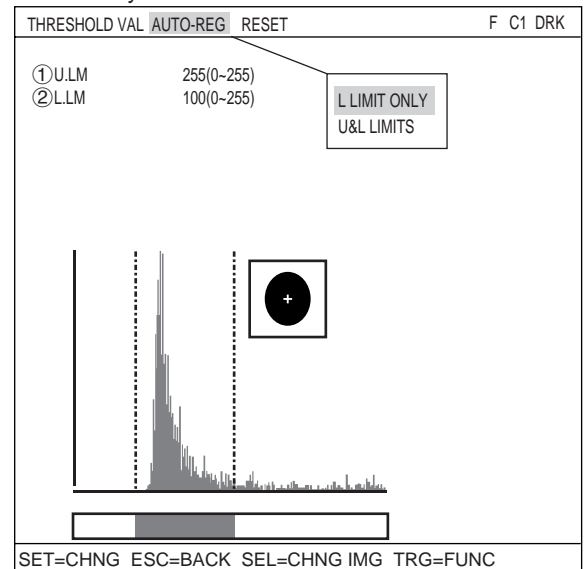

(3) Setting window boundaries (enable/disable)

This function enables and disables the labeling (object identification) of binary images located that cross over the window frame boundary.

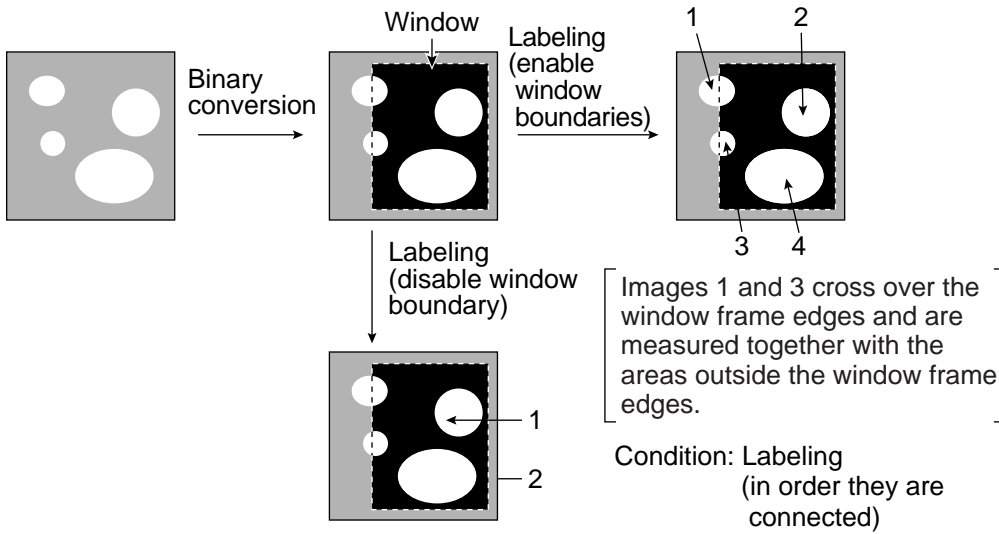

Measurement programs which are affected by these settings

BGA/CSP inspection, object counting by binary conversion, object identification by binary conversion

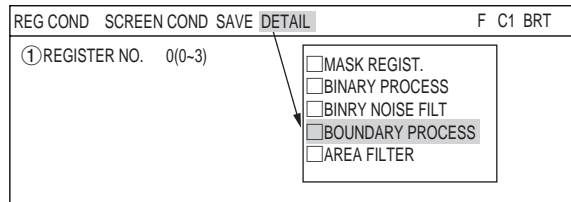

Setting method

Select "DETAIL" in the upper function menu on the REG COND screen. Select "BOUNDARY PROCESS" from the popup menu and then press the SET key.

(4) Object identification and numbering function (labeling)

Object identification and numbering (labeling) is a process for locating separate object and assigning serial numbers (labels) one at a time in a binary image. By this process, multiple objects in the same binary image can be handled separately or as a group.

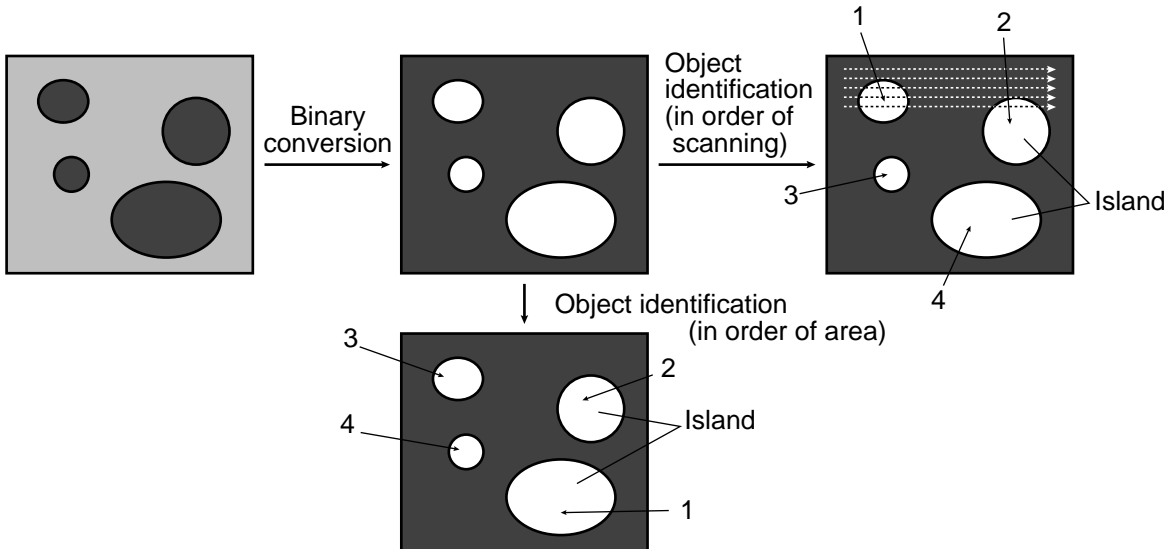

Measurement programs which are affected by these settings

Object counting by binary conversion, object identification by binary conversion

(5) Binary processing (fixed/threshold value correction)

By setting THRESHOLD-ADJ (threshold adjustment function), the IV-S30 can cope with variations in lighting.

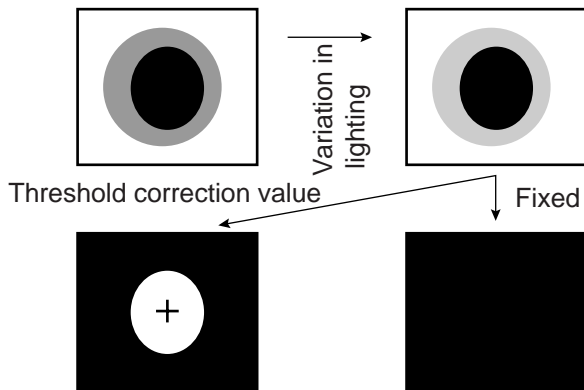

Note: In order to use the THRESHOLD-ADJ(threshold adjustment function), the monitor brightness functions must be selected to measure variations in lighting. If you don't select the monitor brightness function, a LIGHT LVL NOT SET (correcting binary value: monitor illumination not selected) error will occur.

Fails to convert the image due to a variation in lighting

Threshold correction using either VAR-DIFF (enter variations in lighting as value) and VAR-RATE (enter variations in lighting as a rate) can be selected the THRESHOLD-ADJ (the threshold adjustment function).

Set (selection) item		Details of correction
Threshold value adjustment	Variation difference	Correct the threshold value by adding the previously specified threshold value to the light level variation difference. (Measured light level — reference light level) + specified threshold value
	Variation rate	Correct the threshold value by multiplying the previously threshold value to the light level variation rate. (Measured light level ÷ reference light level) x specified threshold value

■ Measurement programs which are affected by these settings

Area measurement by binary conversion, object counting by binary conversion, object identification by binary conversion, point measurement (binary images)

■ Setting method

Select "③THRESHOLD" on the "REG COND" screen and then change the upper and lower limit values using the up, down, left, and right arrow keys.

REG COND	SCREEN COND	SAVE	DETAIL	F	C1	BRT
① MEAS SHAPE	RECTANGLE					
② MEAS AREA	SET (224,208)-(287,271)					
③ THRESHOLD	SET [U.LM255 L.LM100(0~255)]					
④ INVERT B/W	NO					

↑ ↑
Change using the up and down arrow keys.

(6) The expansion/contraction method of eliminating noise in binary images

When converting an image to binary values, it is often the case that dots of noise will show up in the converted image. This noise may be eliminated during pre-processing by using the smoothing function. However, it can also be dealt with through the expansion/contraction noise elimination method.

① **Expansion**

A single white dot, or small groups of white dots, in the middle of a black background can be eliminated from the image.

② **Contraction**

A single black dot, or small groups of black dots, in the middle of a white background can be eliminated from the image.

The IV-S30 has both "contraction → expansion" and "expansion → contraction" functions for eliminating binary noise.

① Expansion → contraction

When isolated dots of noise are eliminated by expansion, the areas enlarged by the expansion are returned to their original size by contracting them again.

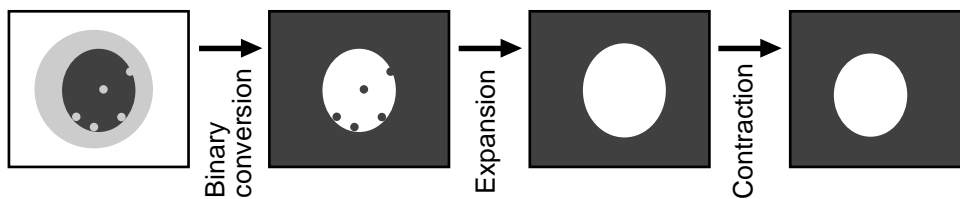

② Contraction → expansion

When isolated white noise is eliminated by contraction, the areas shrunk by contraction are returned to their original size by expanding them again.

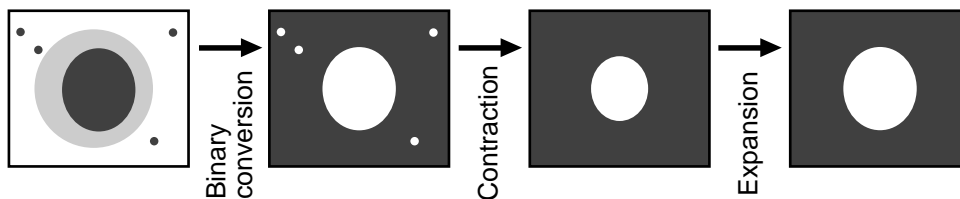

- Number of times of expansion and number of times of contraction can be set independently. When the number of contraction cycles is set to 0, and the number of expansion cycles is one or greater, then only the expansion function will be used. On the other hand, if the number of expansion cycles is set to 0 and the number of contraction cycles is one or greater, then only the contraction function will be used.

■ **Measurement programs which are affected by these settings**

Area measurement by binary conversion, object counting by binary conversion, object identification by binary conversion

■ **Setting method**

Select "DETAIL" in the upper function menu on the REG COND screen, and choose "BINRY NOISE FILT" to change the blank box to a filled box. Then, "⑤BINRY NOISE FILT" will appear on the REG COND screen. Press the SET key on this line and select "EXPD. -> CONTR." or "CONTR. -> EXPD." from the popup menu.

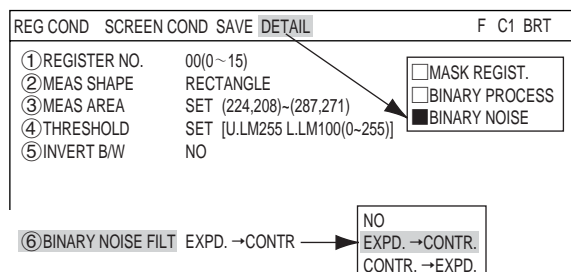

(7) Edge detection

The "edge" refers to the boundaries between the brighter (white) and darker (black) parts in an image. The "edge detection" function is used to detect this boundary by processing the image.

■ An example of detecting a point using the edge detection function and user specified criteria

- **Horizontal transition point from light to dark (moving from left to right)**

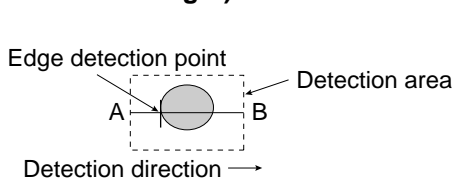

- **Vertical transition point from light to dark (moving from top to bottom)**

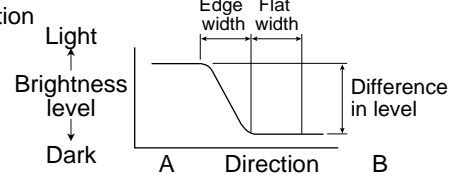
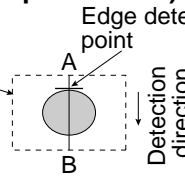

- **Horizontal transition point from light to dark (moving from right to left)**

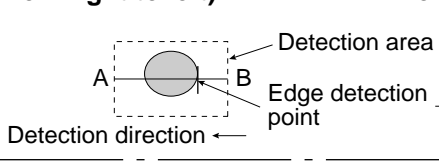

- **Vertical transition point from light to dark (moving from bottom to top)**

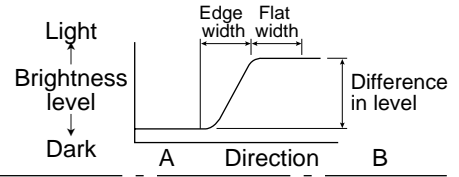
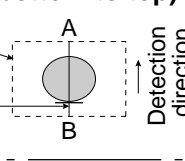

- **Center (dark), horizontal (left and right)**

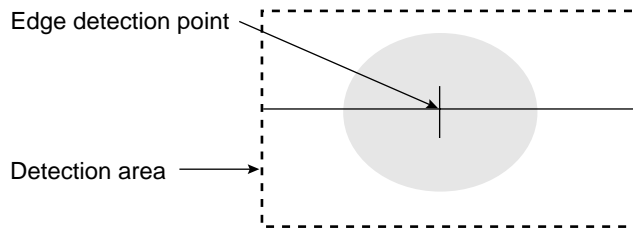

- **Edge detection of the inside and outside edges of a two circles**

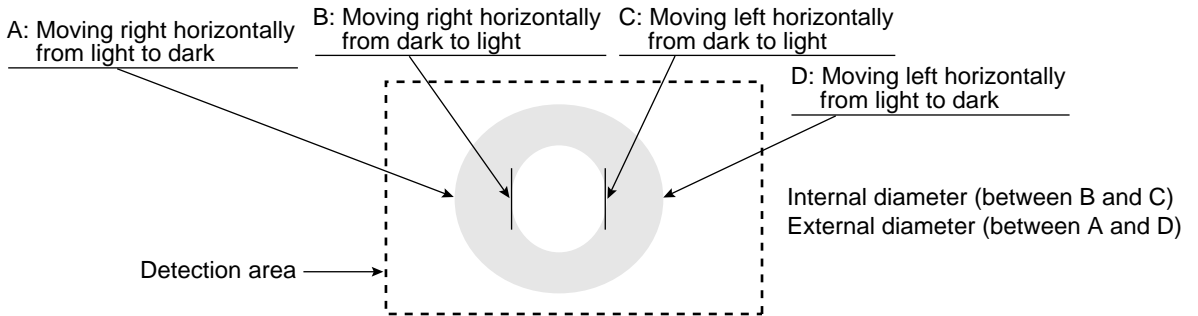

- The edge detection point coordinates are used as a reference point to detect an out of position condition.
- Edge detection in binary images is much quicker than in a gray scale search. However, the binary image detection process is less precise at detecting position.

- Setting the threshold value automatically**
 By executing an "AUTO.REG" (automatic setting) for the edge detection condition in each measurement program, the IV-S30 can automatically detect edges in the measurement areas, and set the optimum threshold values automatically (density difference and edge width).

- Measurement programs which are affected by these settings**
 Positional deviation measurement (edge detection), lead inspection, multiple position measurement (edge detection).

• Edge detection menu of the lead inspection

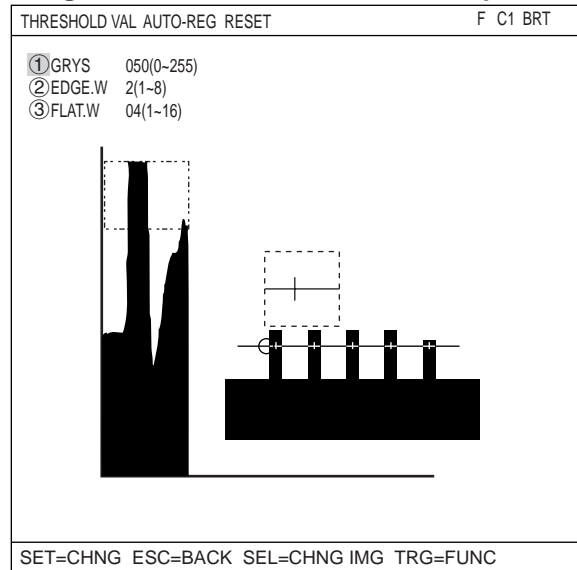

(8) Artifact processing

Artifact processing is a method of processing that eliminates the false detection of the edge of the target object when an artifact is in the line being scanned. This process can be used during edge detection. The real edge of the target object is detected by computing the average duration of the dark area in the scan line, which is much longer for a target object than for an artifact.

■ Example of detection

An example of light to dark averaging (DTCT MODE:BRT DRK) while scanning horizontally (SEARCH DIR:HORIZ), with artifact processing (enabled) (ARTIF).

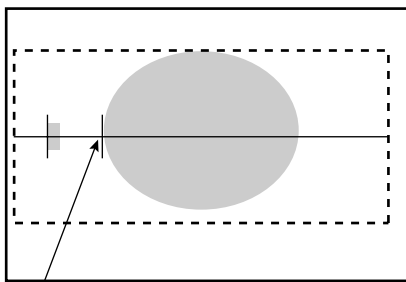

Edge detection point (with artifact processing: enabled)

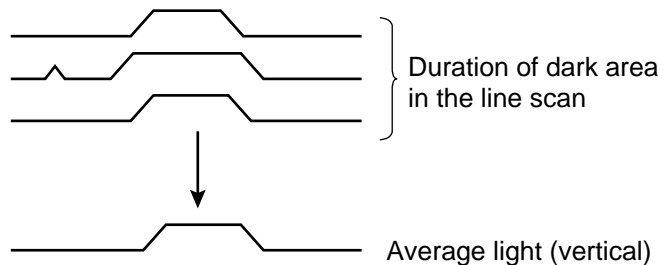

When artifact processing is disabled (NO ARTIF) in the above example, the edge detection point changes.

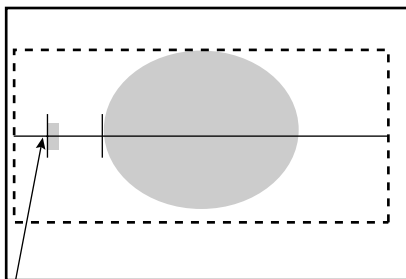

Edge detection point (with artifact processing off)

■ Measurement programs which are affected by these settings

Positional deviation measurement (edge detection), lead inspection, and multiple position measurement (edge detection).

(9) Contrast search in the reference image

Using the reference image area setting in the gray scale search mode, the area of maximum contrast can be identified automatically in the captured image.

- While moving the selected reference image area within the specified search area on the captured image one pixel at a time, the IV-S30 determines the density in each area in the reference image, and automatically picks the area with the largest difference.
- This function may be used for sorting printed objects.

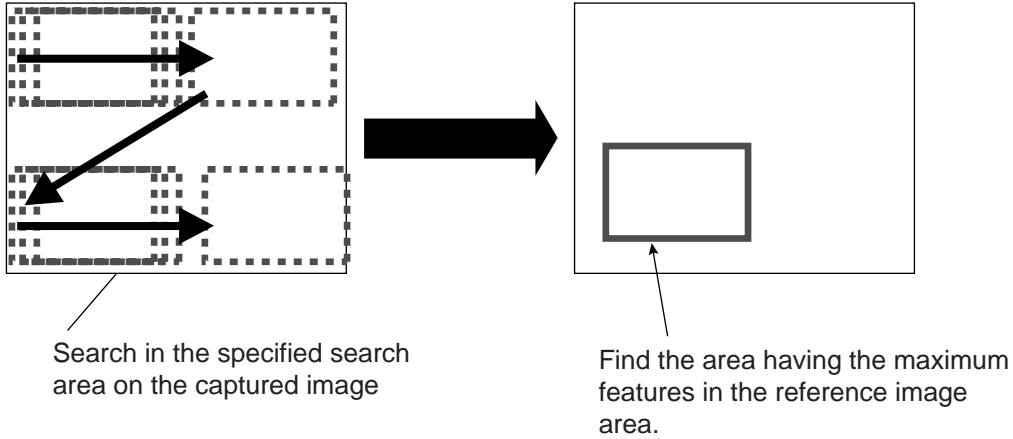

■ **Measurement programs available that use this setting**

Positional deviation measurement (gray scale search), degree of match inspection, multiple position measurements (gray scale search), and multiple degree of match inspection.

■ **Setting method**

Move the cursor to the "④REFERENCE IMG" with up and down arrow keys on the reference image area setting screen. Next, select "CONTRAST SRCH." Finally, press the SET key.

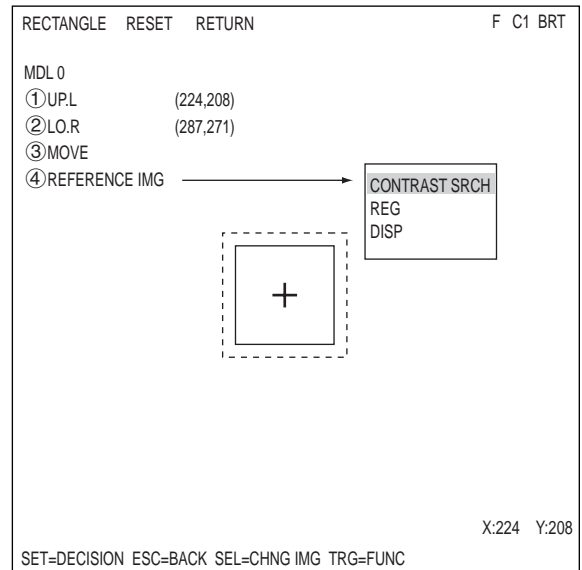

[4] Evaluation conditions

The setting details and procedures for setting the evaluation conditions are the same for all measurement programs.

Evaluation conditions [EVALUATION COND] menu for measuring degree of match

EVALUAT COND SCREEN COND SAVE			
[1] REGISTER	00(0'15)	[TEST RESULT]	[OUTPUT]
[2] CONDITION SET RESET.	AUTO(±10%)		
[3] MATCH LVL (MDL0)	-10000~+10000	M0=+09000	OK; NO
[4] X COORD. (MDL0)	000.0~511.0	X0= 000.0	OK; NO
[5] Y COORD. (MDL0)	000.0~479.0	Y0= 000.0	OK; NO
[6] GLAY LVL (MDL0)	000.0~255.0	G0= 116.0	OK; NO
[7] MATCH LVL (MDL1)	-10000~+10000	M1=+09000	OK; NO
[8] X COORD. (MDL1)	000.0~511.0	X1= 000.0	OK; NO
[9] Y COORD. (MDL1)	000.0~479.0	Y1= 000.0	OK; NO
[10] GLAY LVL (MDL1)	000.0~255.0	G1= 116.0	OK; NO
[11] TEST	EXEC(WITH-POSI. ADJ WITHOUT-POSI.ADJ)		
ESC=BACK SEL=CHNG IMG TRG=FUNC			

The "degree of match + 09000" refers to a degree of match (match between individual pixels) between the registered image and the measured image that is equal to 90.00% or more of the total.

Using the up and down keys, you can set the output to NO (no output), Y0 to 7 (output on these relays), or C000 to C127 (output on these secondary relays), in the output area of the menu.
(If the test result returns OK, then the output is turned ON. If it is NG, then it is turned OFF).

When carrying out a test using item [11] TEST, on the menu, the resulting measurement values and the evaluation (OK or NG) will be displayed.

If you select "WITH-POSI.ADJ," the system will conduct test while adjusting for positional deviation. ⇨ pages 3-31 to 3-33

● Condition setting

Upper and lower limit values of the all evaluation condition items can be set automatically with the following processes.

After testing more than one good workpieces, the IV-S30 automatically set the limits based on the test results.

Condition settings	Details
AUTO (-***%)	<p>- Multiple the specified rate (-%) on the newly tested good workpieces, and compared this value with the range between the current upper and lower limits. If it is outside the upper and lower limits, the IV-S30 renews the maximum or minimum value with this value. At the first setting, the first test result will be the upper and lower limit without any condition.</p> <p>[-***%] The value from -00% to -99% can be entered to the "-***%" in units of 1%. (Default value =-10%) To enter this position, move the cursor to the "AUTO" position and press the up and down keys to change the value. After determining the value, press the SET key, upper and lower limits of each item will be automatically set with this %.</p>

■ **Setting method**

There are two ways to get to the evaluation condition setting screen.

- 1) Select "CND" in the upper function menu on the MEAS CND (or REG COND) screen and press the SET key. Select "EVALUATION" on the pop up menu to go to the "EVALUAT COND" screen.

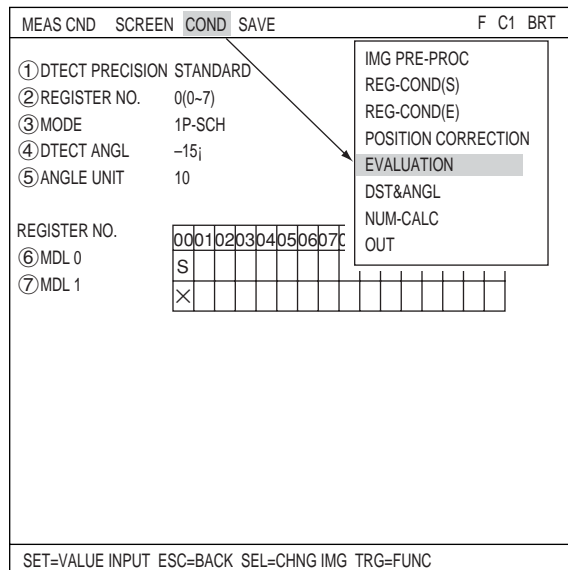

- 2) Move the cursor to the "EVALUATION COND" item on the Menu tree screen and press the SET key.

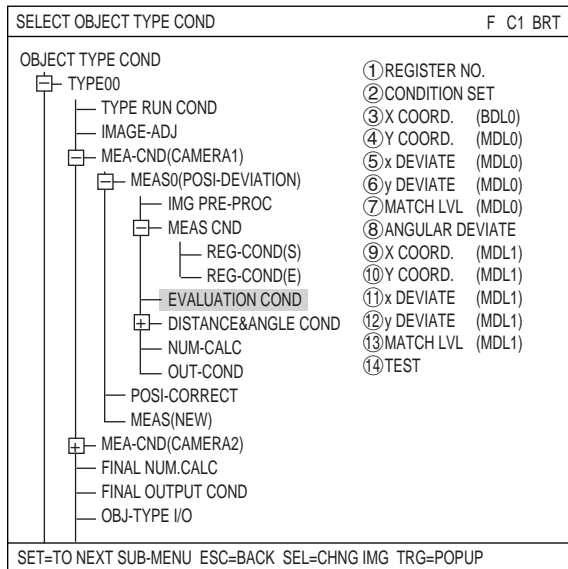

[5] Image pre-processing

A comparative calculation between images, gray level changes, and space filter are available for image pre-processing.

Comparative calculation between images	Subtracting, absolute value of difference (between camera 1 and reference image, between camera 2 and reference image, between camera 1 and camera 2)
Gray level changes	Magnification by "n" processing, g (+/-) correction, histogram widening, midrange emphasis
Space filter	Smoothing (center/average), edge emphasis, edge extraction, horizontal edge, vertical edge

3

How to get to the "IMG PRE-PROC" screen

Select "OBJECT TYPE COND" and then "TYPE00" or "TYPE(NEW)" on the "MAIN COND" screen. Then select "MEA-CND(CAMERA1)" and "MEAS" to open a measurement screen. At the "① MEAS SELECTION" item, press the SET key and choose a measurement program from the popup menu. Note: If the "① MEAS SELECTION" is set to "NO," the image pre-processing cannot be specified.

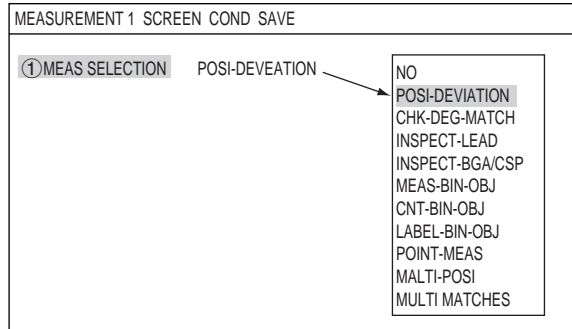

Press the ESC key to return to the OBJECT TYPE COND screen. Then select "IMG PRE-PROC."

Note: If the NG image registration function is specified, "MEA-CND(CAMERA2)" will change to "MEA-CND(NG-IMGS)" and Camera 2 cannot be selected.

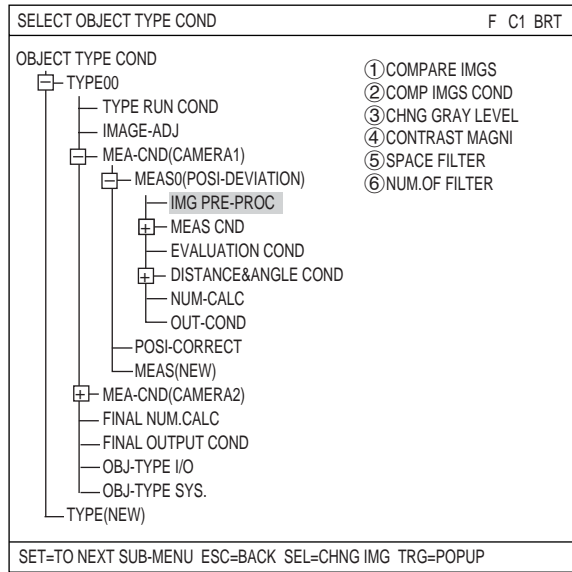
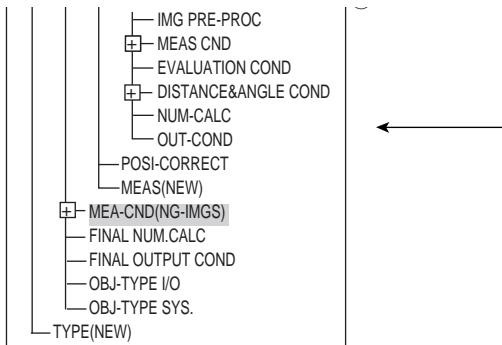

The "IMG PRE-PROC" screen will appear.

- ⇒ For details about "COMPARE IMGS" (compare images), see page 3-21.
- ⇒ For details about "CHNG GRAY LEVEL" (change gray level), see page 3-23.
- ⇒ For details about "SPACE FILTER," see page 3-24.

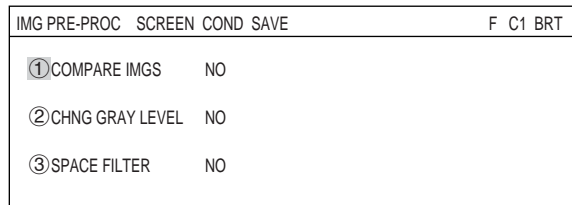

Note: If the NG image registration function is specified, only "CAM1" can be selected for the "① COMPARE IMGS" function.



(1) Comparative calculations between images

It is possible to run calculations on the differences between the images taken by camera 1 and camera 2, as well as on the differences between the current image and the already stored reference image.

There are two types of calculation: "subtraction" and the "absolute value of the differences."

Subtraction	Light level in image 1 (0 to 255) - Light level in image 2 (0 to 255) ⇒ Light level after calculation However, a result less than 0 will give a result of 0.
The absolute value of the differences	Light level in image 1 (0 to 255) - Light level in image 2 (0 to 255) ⇒ Light level after calculation (0 to 255)

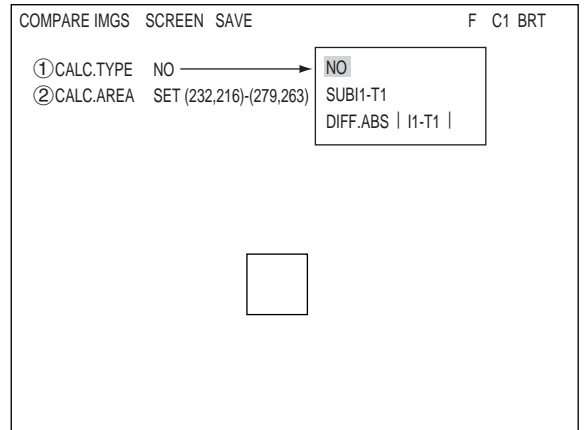

3

■ Example of comparative calculations between images

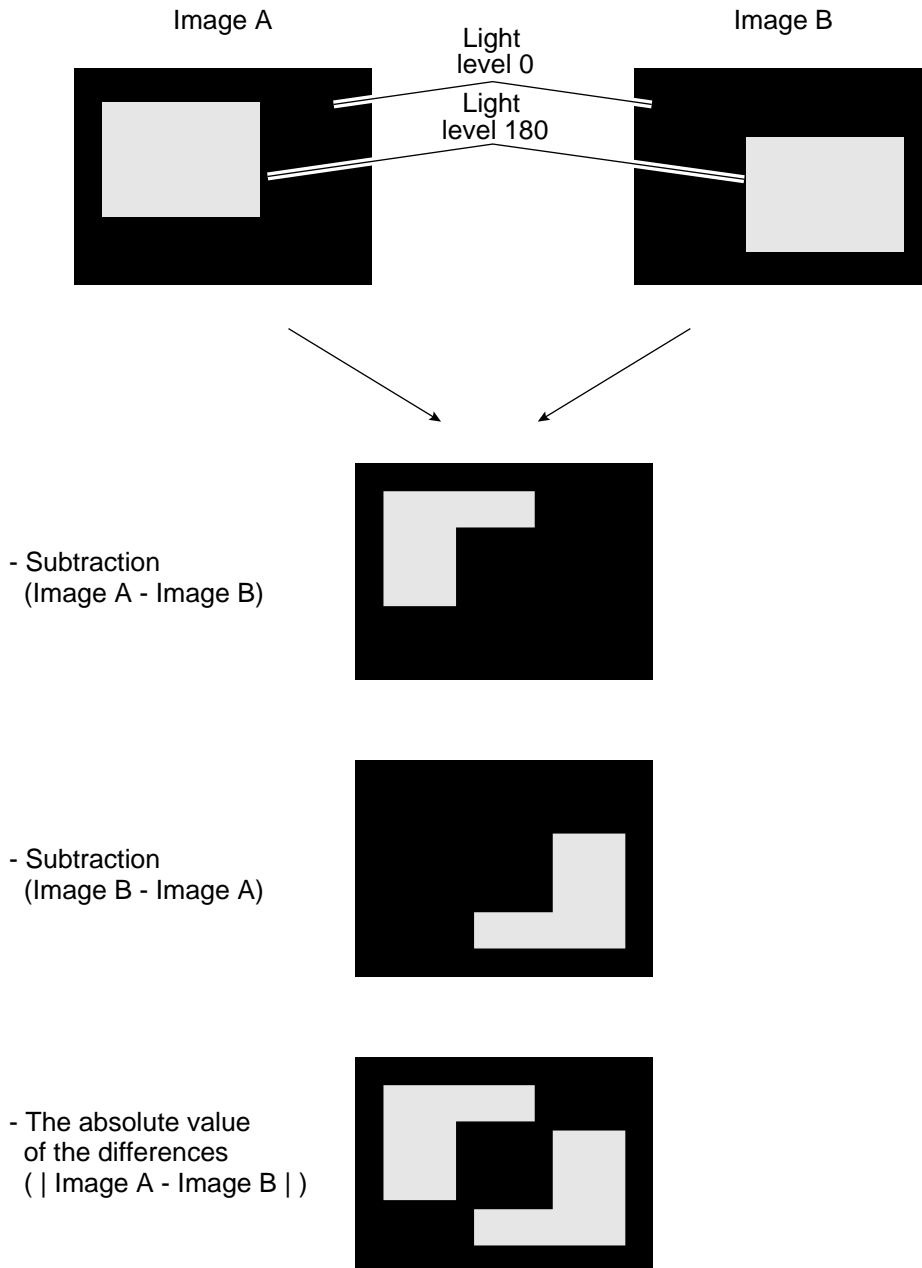

Setting details

1. Select the camera to be used for "①COMPARE IMGS" from the popup menu. Then select the "②COMP IMGS COND" item to get to the setting screen.

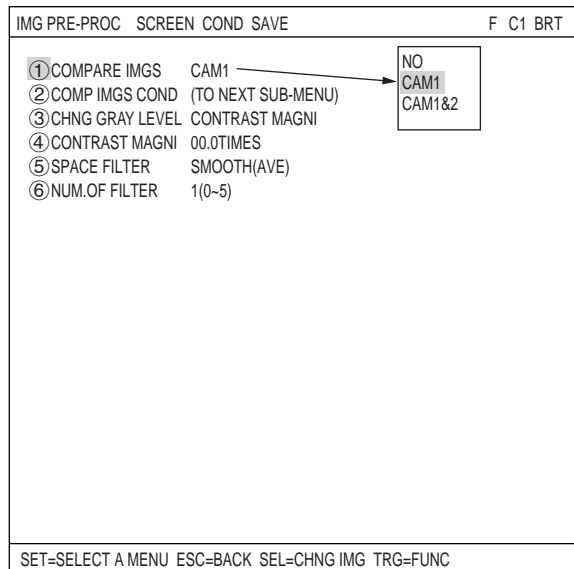

2. Select "①CALC.TYPE" and then set "②CALC.AREA."

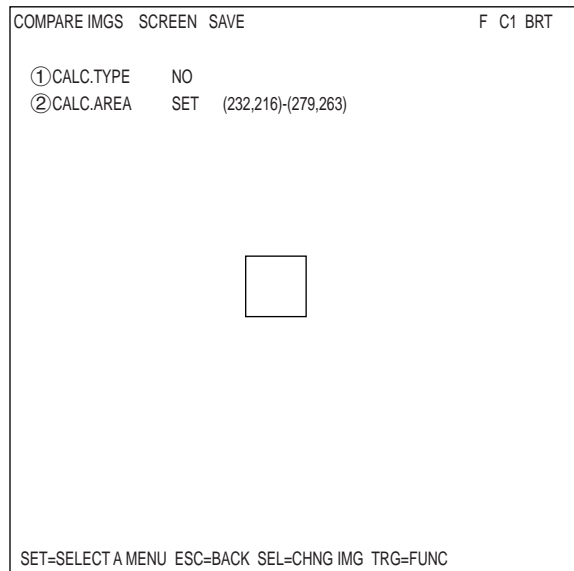

The list of settings which may be selected at item "①COMPARE IMGS" is as follows.

SELECT CAMERA	① CALC.TYPE	Contents
NO (none)	—————	Comparative calculations of differences between images will not be carried out.
CAM 1 (camera 1)	None	Comparative calculations of differences between images will not be carried out.
	Subtraction I1-T1	The reference image T1 (* 1) is subtracted from the image taken by camera 1.
CAM 2 (camera 2)	The absolute value of the difference between I1-T1	The absolute value of the difference is calculated between the reference image T1 (* 1) and the image taken by camera 1.
	None	Comparative calculations of differences between images will not be carried out.
CAM 2 (camera 2)	Subtraction I2-T2	The reference image T2 (* 1) is subtracted from the image taken by camera 2.
	The absolute value of the difference between I2-T2	The absolute value of the difference is calculated between the reference image T2 (* 1) and the image taken by camera 2.
CAM 1&2 (cameras 1 & 2) (*2)	Subtraction I1-I2	The image taken by camera 1 is subtracted from the image taken by camera 2.
	Subtraction I2-I1	The image taken by camera 2 is subtracted from the image taken by camera 1.
	The absolute value of the difference between I2-I2	The absolute value of the difference is calculated between the image taken by camera 1 and the image taken by camera 2.

The reference images T1 and T2 (*1) and the size of the areas covered by I1 and I2 (the images taken by cameras 1 and 2) (*2) may be set in item "②CALC. AREA."

(2) Gray level change

To change the gray level, you can change the "**.*TIMES" (magnification by N processing), the "γ+," "γ-" (γ (positive/negative) correction), the "CHNG-L" (widening histogram), and the "INCRS-M" (mid emphasis) functions.

IMG PRE-PROC SCREEN COND SAVE		F C1 BRT
① COMPARE IMGS	NO	
② CHNG GRAY LEVEL	<input type="checkbox"/> NO <input checked="" type="checkbox"/> CONTRAST MAGNI <input type="checkbox"/> + <input type="checkbox"/> - <input type="checkbox"/> CHNG-L <input type="checkbox"/> INCRS-M	
③ SPACE FILTER		

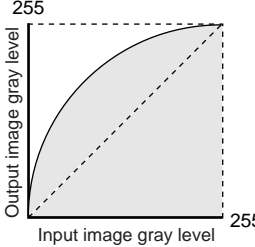
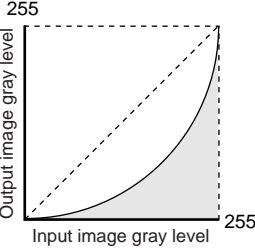
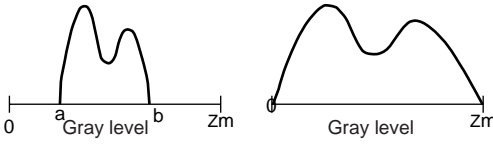
Gray level change	Details						
Magnification by N processing (**.* TIMES)	<p>To improve the contrast (the ratio of high value gray levels to low value gray levels), specify a magnification rate (00.0 to 99.9) for multiplying the image data.</p> <ul style="list-style-type: none"> - If the magnified gray level exceeds 255, the system will correct the value to 255. 						
g (positive/negative) correction	<p>- g positive correction: used when the mid gray level is too low.</p>  <p>- g negative correction: used when the mid gray level is too high.</p> 						
Histogram widening	<p>This is a method to widen the histogram of an image in which the histogram is at part of it, thus improve its contrast.</p>  <p>① Bad contrast image ② Good contrast image</p>						
Mid emphasis	<p>Emphasize the mid gray level.</p> <ul style="list-style-type: none"> - This improves contrast while remaining the background image. - The input image density (G) can be converted to the output image density with the following formulas: <table border="1"> <thead> <tr> <th>Input image gray level(G)</th> <th>Output image gray level</th> </tr> </thead> <tbody> <tr> <td>0 to 127</td> <td>$(G \div 127)^2 \times 127$</td> </tr> <tr> <td>128 to 255</td> <td>$\sqrt{(G - 128) \div 127 \times 127} + 127$</td> </tr> </tbody> </table>	Input image gray level(G)	Output image gray level	0 to 127	$(G \div 127)^2 \times 127$	128 to 255	$\sqrt{(G - 128) \div 127 \times 127} + 127$
Input image gray level(G)	Output image gray level						
0 to 127	$(G \div 127)^2 \times 127$						
128 to 255	$\sqrt{(G - 128) \div 127 \times 127} + 127$						

(3) Space filter

Space filter includes various image manipulation processes that create more readable images by removing noise and distortion in the image data. And, by extracting or emphasizing certain image features, it is easier to evaluate or identify target objects by converting the images into standard patterns.

In the IV-S30, you can select from "smoothing (average, center)," "edge emphasis," "edge extraction," "horizontal edge," and "vertical edge."

IMG PRE-PROC	SCREEN COND	SAVE	F C1 BRT
① COMPARE IMGS	NO		
② CHNG GRAY LEVEL	NO		
③ SPACE FILTER	SMOOTH(AVE)		
④ NUM.OF FILTER	7(0-5)		

NO
SMOOTH(AVE)
SMOOTH(CENT)
EXTRACT EDGE
HORIZ-EDGE
VERT-EDGE

Item	Contents	
Smoothing (center)	- Specify the median pixel gray level from the surrounding 3 x 3 area. - Since noise elements are difficult to select, they will not affect the output.	- Display smooth images with decreased noise. - Used to eliminated surface flaws and unevenness in the reflected light caused by protrusions or dents.
Smoothing (average)	- Specify the average pixel gray level from the surrounding 3 x 3 area. - Since noise elements are included in the average, the noise will affect the output.	- This type of smoothing (averaging) is faster than the median smoothing.
Edge emphasis	- Display images with sharp boundaries between brighter and darker areas. - Used to stabilize and create a binary outline around unclear objects.	
Edge extraction	- Display images after extracting and clarifying the boundaries between the brighter and darker areas.	- Used to measure objects with low contrast.
Horizontal edge	- Horizontal edge extraction: Display only the horizontal boundaries of an object.	
Vertical edge	- Vertical edge extraction: Display only the vertical boundaries of an object.	

■ Example of an image

- No



- Smoothing



- Edge emphasis



- Edge extraction (All)



- Edge extraction (horizontal)



- Edge extraction (vertical)



[6] Image adjustment

■ How to set the image adjustment function

Select "IMAGE-ADJ" on the "SELECT OBJECT TYPE COND" screen and press the SET key.

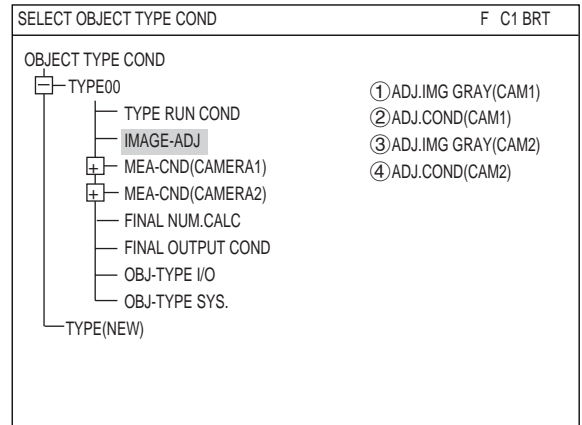

3

● Shading correction

This process removes unevenness from images that have gray level unevenness caused by an illumination.

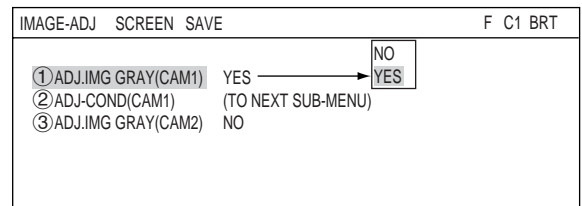

● Adjustment condition

To set the adjustment conditions for gray level corrections, select "②ADJ-COND" and then press the SET key to show the sub menu.

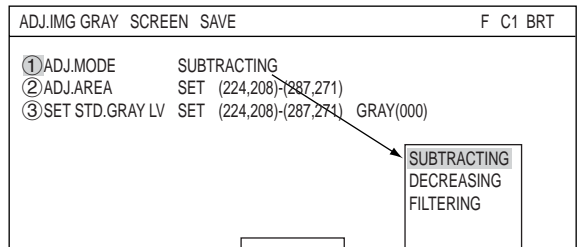

Correction mode	Details
SUBTRACTING	<p>Divide a scanned image with the reference image that expresses changes of dark and bright as a whole, and correct the brightness throughout the image.</p> $\{(Each\ gray\ level\ of\ scanned\ image) \times reference\ gray\ level\} / (Each\ gray\ level\ of\ reference\ image)$ <p>- Divide a scanned image that is shot under the uneven light by a blank image that is shot under the same light condition, you can change the image to the one that is shot under the even light.</p>
DECREASING	<p>Subtract a scanned image with the reference image that expresses changes of dark and bright as a whole, and correct the brightness throughout the image.</p> $\{(Each\ gray\ level\ of\ scanned\ image) + reference\ gray\ level\} - (Each\ gray\ level\ of\ reference\ image)$ <p>- Subtract a scanned image that is shot under the uneven light by a blank image that is shot under the same light condition, you can change the image to the one that is shot under the even light.</p>
FILTERING	<p>Filter a scanned image with the maximum value, and then with an average value, to make a brightness image.</p> <p>[Max. value filter: Max. gray level of 3 x 3] \Rightarrow [Average value filter: Average gray level of 3 x 3]</p> <p>- Use this filter when a brightness distribution image (reference image) for the scanned image cannot be obtained.</p>

[7] Binary image mask

Use the binary image mask when an object to measure by binary conversion cannot be measured using rectangle, cercle, or ellipse window.
Mask a scanned image (AND) with the registered binary image.

Binary image mask	Gray level in the scanned image	Gray level output after masking
1	0 to 255	0 to 255 (gray level in the scanned image)
0	0 to 255	0 (fixed)

■ Measurement programs which are affected by this setting

Area measurement by binary conversion, object counting by binary conversion, object identification by binary conversion, BGA/CSP inspection

■ Setting method

1. On the SELECT OBJECT TYPE COND screen, select "MEAS CND" (measurement conditions) and press the SET key. The MEA-CND screen will appear. Select "①WINDOW" and press the SET key. Select "BINARY-IMG-MASK" from the popup menu.

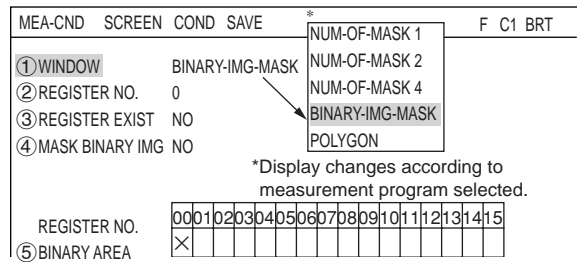

2. Highlight the "④MASK BINARY IMG" item and press the SET key. A popup menu will appear. Select "REF-IMG" or "MANUAL" and the "⑤BIN IMG MASK" line will appear. Selecting "REF-IMG" → See page 3-27 to 28. Selecting "MANUAL" → See page 3-29 to 30.

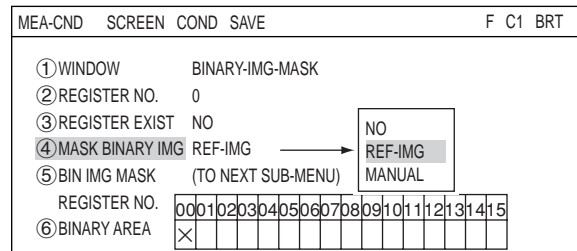

3. Select "⑤BIN IMG MASK" (binary image masking condition) and press the SET key. The, MASK BINARY IMG screen will appear.

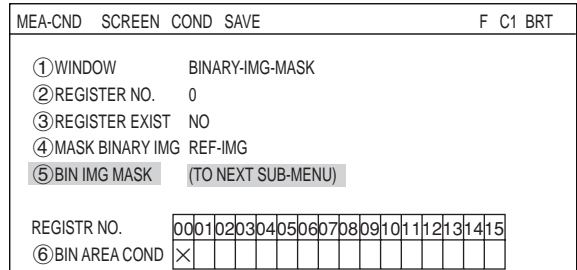

4. Here you can set the masking conditions. First move the cursor to "①MASK AREA" and press the SET key. Specify and confirm the position and size of a masking area. On the "②THRESHOLD" line, adjust the threshold value between 0 and 255. At "③MASK INVERT B/W," select whether or not to invert the masking area. When a mask noise removing method is specified in "④MASK NOISE FILTR," the "⑤NUM.OF MASK FILT" (number of times to filter) line will appear. Set the number of times from 0 to 5.

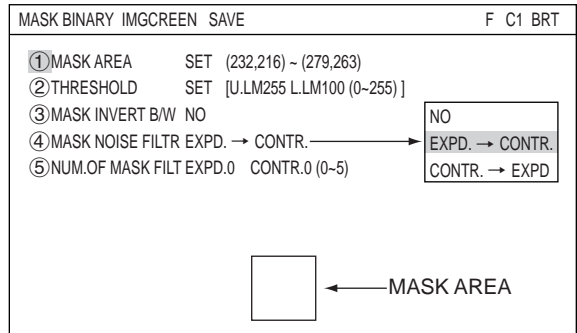

■ Setting example

- When "④ MASK BINARY IMG" is set to "REF-IMG."

Shown below is an example of how to specify a binary image mask for a star shape.

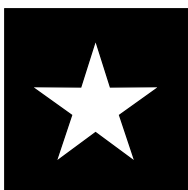

1) Store a binary image mask on the "BINARY IMG MASK" menu (mask setting = standard) shown above.

1. Specify the mask outline for the object to be measured.



2. For correcting minor positional deviations, store an enlarged image as the binary image mask.

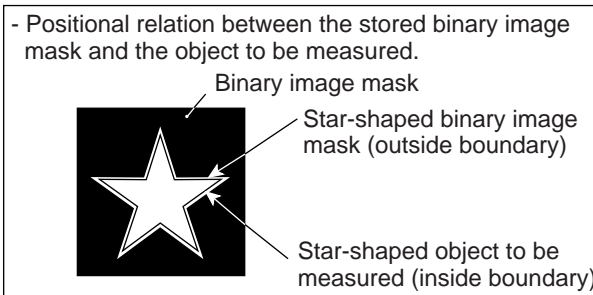
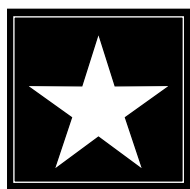

3. Return to the "TYPE MEAS COND" menu. Select "MEAS-COND" in the "⑤ MEAS-BIN-AREA" item

2) Settings on the "TYPE MEAS COND" menu

1. Select "YES" from the popup menu at "③ REGISTER EXIST."
2. Select "○" (00) at the "⑥ BINARY AREA" item and press the SET key to bring up the "REG COND" menu.

REGIST COND	SCREEN	COND	SAVE	F C1 BRT
① WINDOW	BINARY-IMG-MASK			
② REGISTER NO.	0			
③ REGISTER EXIST	YES		YES NO	
④ MASK BINARY IMG	REF-IMG			
⑤ BIN IMG MASK	(TO NEXT SUB-MENU)			
REGISTR NO.	00010203040506070809101112131415			
⑥ BINARY AREA	○			

SET=SELECT(YES/NO) ESC=BACK SEL=CHNG IMG TRG=FUNC

3) Setting the binary area conditions

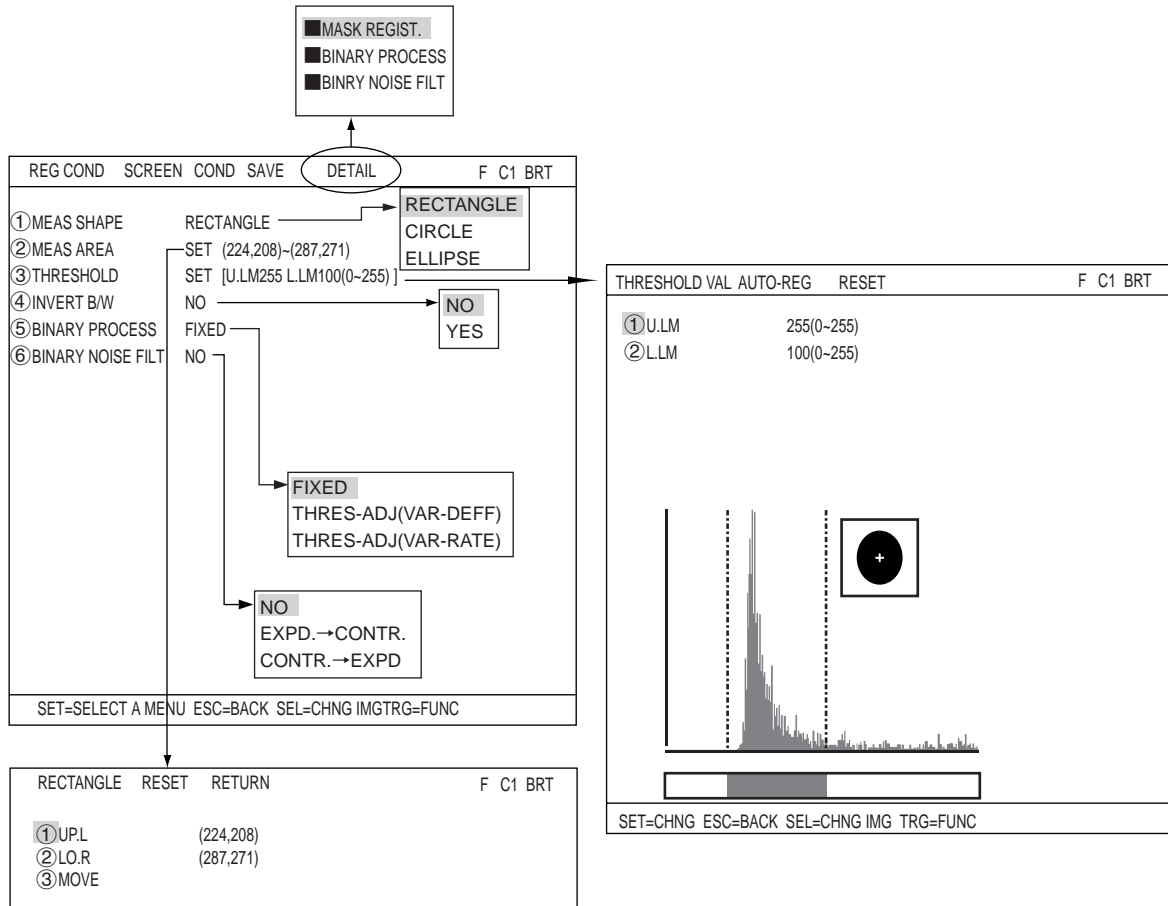

1. Specify a measurement area smaller than the mask area and specify the binary conditions.

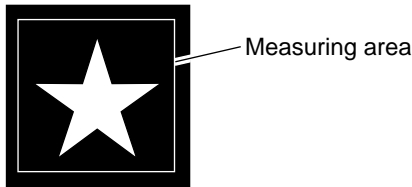

2. Return to the MAIN OPS MENU.

4) Measure the binary area

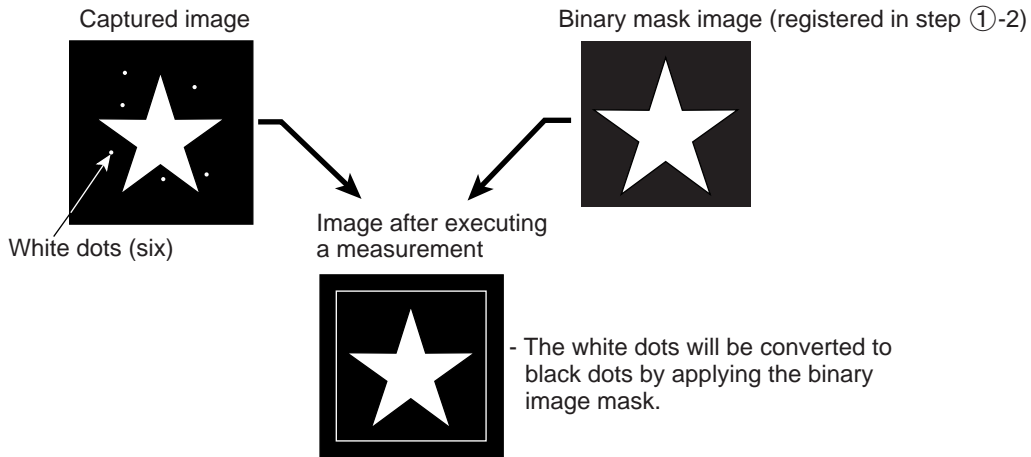

Setting Measurement Conditions

- Select "0" using the up and down keys and then select "MOVE" using the left and right keys. Finally, press the SET key.

3

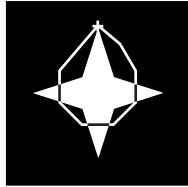

MASK BINARY IMGREEN SAVE		F C1 BRT
① PO01T01	(255,255)	
② PO02T01	(254,226)	
③ PO03T01	(221,226)	
④ PO04T01	(221,251)	
⑤ PO05T01	(274,276)	
⑥ PO06T01	(274,247)	
⑦ PO07T01	(257,247)	
⑧ PO08T01	()	

X:256 Y:240

- Move vertex 02 to 08 a little outside of the first point on the star using the up, down, left, and right keys, and then press the SET key.

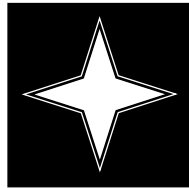

MASK BINARY IMGREEN SAVE		F C1 BRT
① PO01T01	(255,255)	
② PO02T01	(254,226)	
③ PO03T01	(221,226)	
④ PO04T01	(221,251)	
⑤ PO05T01	(274,276)	
⑥ PO06T01	(274,247)	
⑦ PO07T01	(257,247)	
⑧ PO08T01	()	

X:124 Y:276

- After creating a mask area, press the ESC key to return to the "MASK BINARY IMG" screen. Select "③ MASK REGIST" and press the SET key. The cursor will move to the "REG" position. Press the SET key to register the mask.
 - The area inside the mask will change to white. To invert the inside and outside shades (change white to black and black to white), select "YES" on the "② MASK INVERT B/W" line.

MASK BINARY IMG SCREEN SAVE		F C1 BRT
① MASK AREA	SET	
② MASK INVERT B/W	NO	
③ MASK REGIST.	REG DISP	

[8] Position correction

Based on the positional deviation data measurement 0 (positional deviation measurement), the correction of the image coordinates is dealt with using measurements 1 to 4.

(1) Correction details

The types of position correction available are: XY correction, angular correction (standard) and angular correction (high precision)

Type	Details
XY correction	The position is adjusted according to the amount of deviation in X and Y at the first point (model 0) detected in measurement 0. There are three correction directions: X axis correction, Y axis correction and X and Y axis correction. - X axis correction-- Adjusted misalignment in the X axis - Y axis correction-- Adjusted misalignment in the Y axis
Angular correction (standard)	The position is adjusted because of a detected angular deviation q in rotation [2-point search/2-point edge/1-point search + 1-point edge] from measurement 0. - When "YES" is selected in the DTECT ANGL item specifying a "1P-SCH" or a "1P-SCH+1P-EDGE" in measurement 0, the position will be corrected according to the angle detected.
Angular correction (high precision)	The position is adjusted because of a detected angular deviation q in rotation [2-point search/2-point edge/1-point search + 1-point edge] from measurement 0. The high precision angular correction settings allows the IV-S30 to display a very precisely corrected image. But, this selection lowers rotation processing speed. - When "YES" is selected in the DTECT ANGL item specifying a "1P-SCH" or a "1P-SCH+1P-EDGE" in measurement 0, the position will be corrected according to the angle detected.

[Example of a comparison between standard and high precision angular correction]

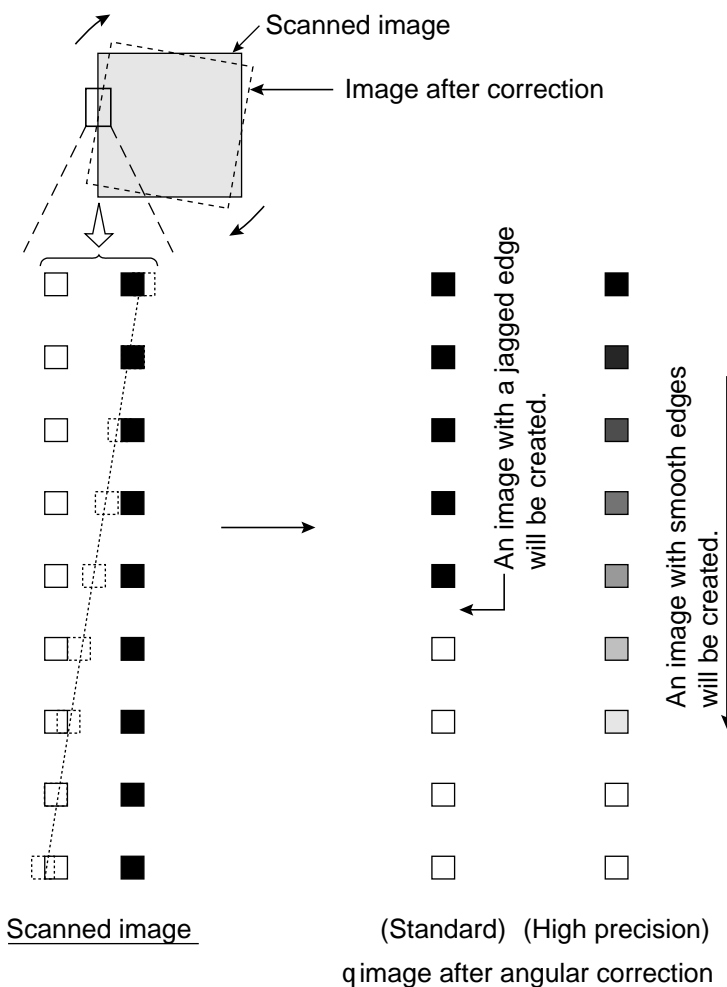

(2) Operation setting details

Select the "POSI-CORRECT" condition item on the "SELECT OBJECT TYPE COND" screen and press the SET key to enter the correction.

POSI-CORRECT SCREEN COND SAVE		F C1 BRT
① CORRECTION REG.	2ND STAGE CORRECTION	NO 1ST STAGE CORRECTION 2ND STAGE CORRECTION
② MODE(1ST)	ANGLE-ADJ.(STANDARD)	
③ X CORRECT ADJ.(1ST)	YES	NO XY-ADJ. ANGLE-ADJ.(STANDARD) ANGLE-ADJ.(HIGH)
④ X CORRECTION	REG0(0-7) MDL0	
⑤ Y CORRECT ADJ.(1ST)	YES	
⑥ Y CORRECTION	REG0(0-7) MDL0	NO XY-ADJ.
⑦ ADJUST ANGL.(1ST)	YES	
⑧ ADJUST ANGL	REG0(0-7) MDL0	
⑨ MODE(2ND)	XY-ADJ.	
⑩ X CORRECT ADJ.(2ND)	YES	NO XY-ADJ.
⑪ X CORRECTION	REG0(0-7) MDL0	
⑫ Y CORRECT ADJ.(2ND)	YES	
⑬ Y CORRECTION	REG0(0-7) MDL0	

SET=SELECT A MENU ESC=BACK SEL=CHNG IMG TRG=FUNC

Setting procedure

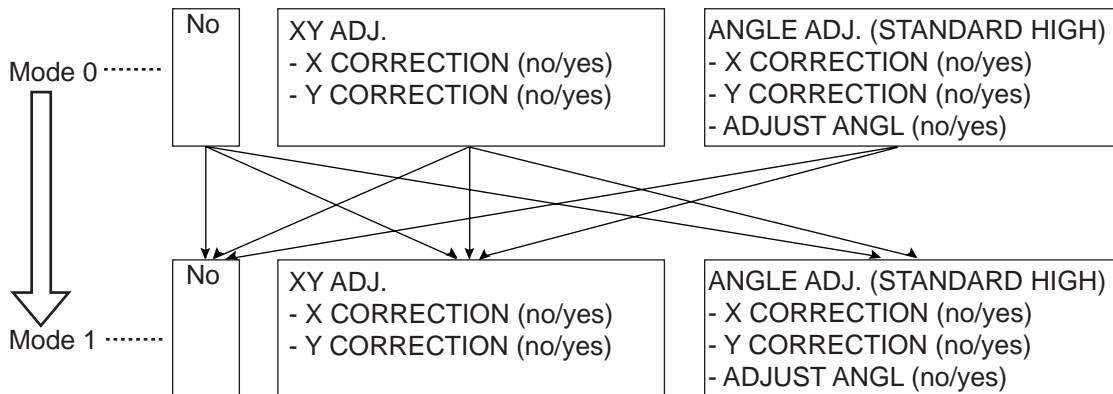

(3) Correction example

Example of correcting the first X and Y point

1. Amount of correction ($X_2 - X_1$, $Y_2 - Y_1$) specified by measurement 0 (positional deviation measurement)

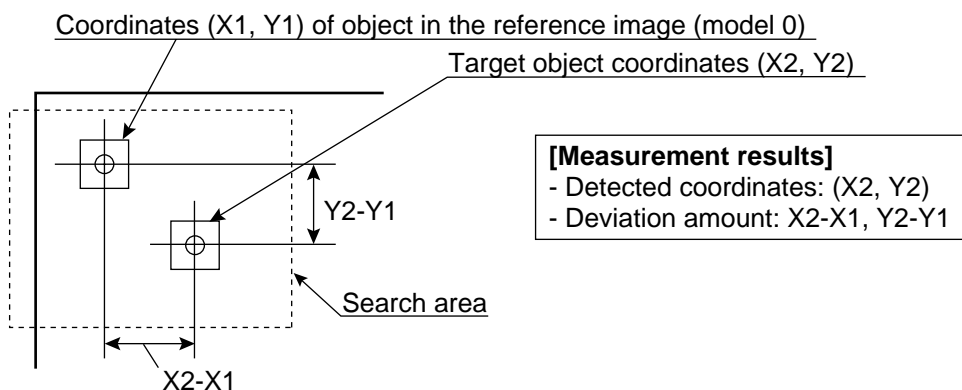

2. Measuring a point using measurement 1

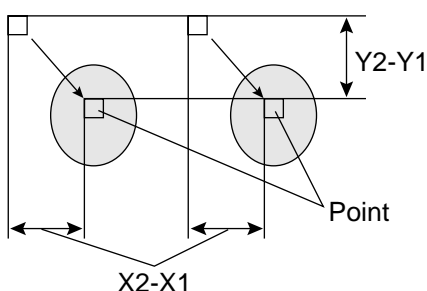

■ Example of angular correction

1. Detection of the amount of angular deviation (using measurement 0, 2 point search (positional deviation measurement)).

- Registration image

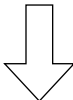
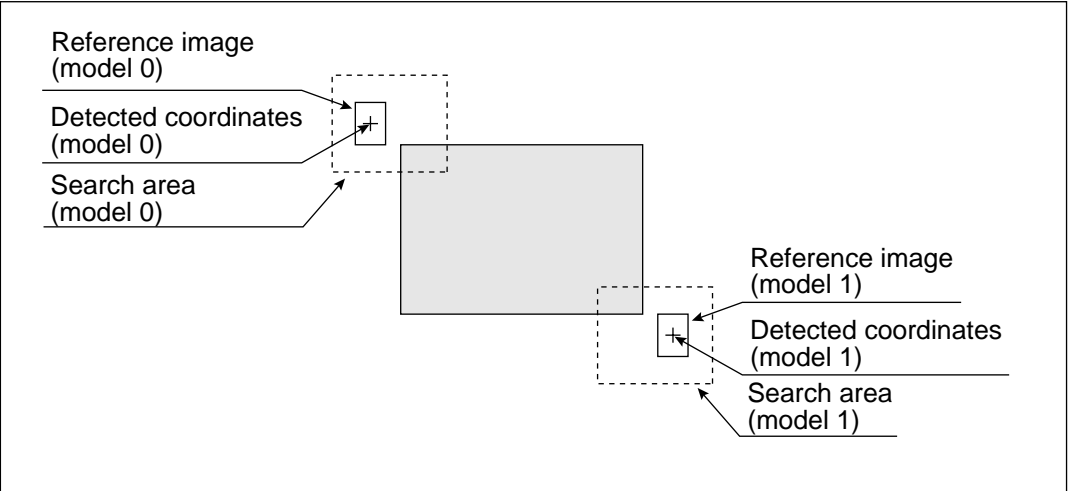

- Measurement image

Detecting the amount of angular deviation

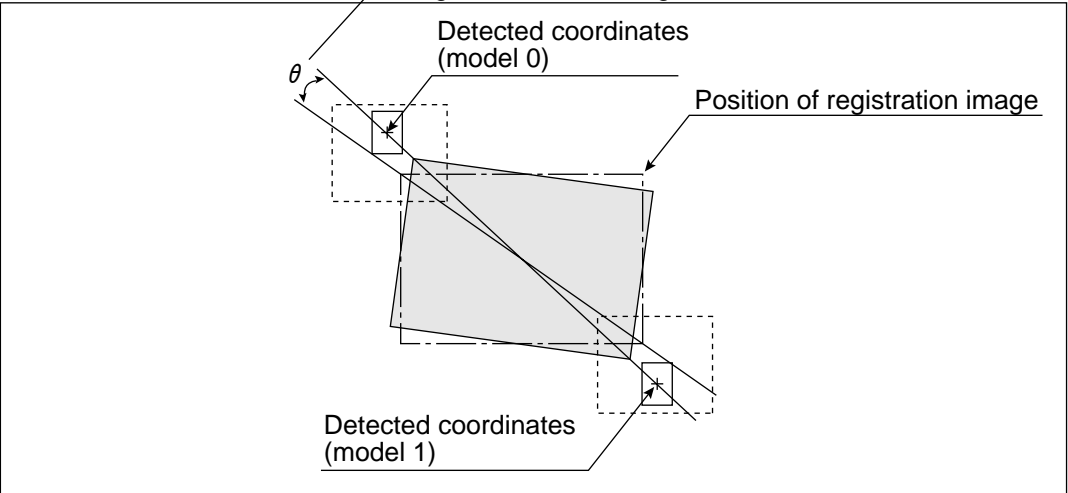

2. Performing measurement 1 to 4 (of distance and angle measurement) on an image that has been rotated around its center by the amount of angular deviation detected in step 1.

- Image that has been rotated around its center in step 1

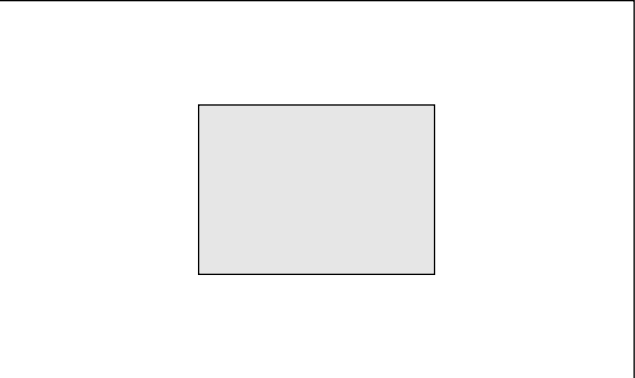

[9] Title registration

A title for a object type number can be entered and saved when the object type number is displayed on the screen.

■ **Purpose**

The title is used to make it easier to control the details of the settings for the object type.

■ **Title characters**

A maximum of 16 letters and symbols may be entered.

■ **Operation method**

Select "OBJECT TYPE COND" on the "MAIN MENU" screen and then select "TYPE00" (the current type). Then press the "TRG/BRT" key. Select "TITLE" from the popup menu and press the SET key.

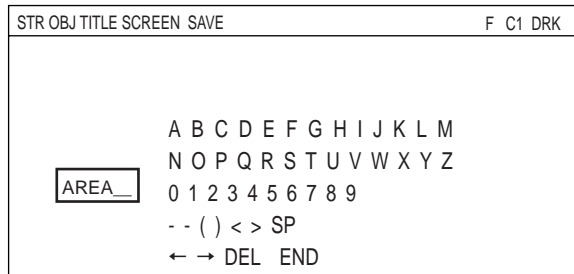
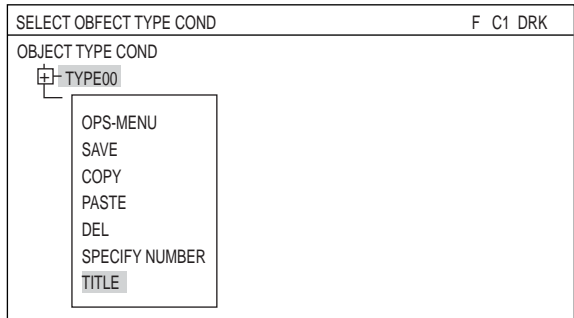

STORE OBJECT TITLE	Setting details
A to Z	These characters and symbols are used to enter the title name.
0 to 9	
= to >	
SP (space bar)	This is used to make spaces.
← →	These are used to move the cursor.
DEL. (delete)	This is used to delete the character to the right of the cursor.
END	Exit the title registration screen.

The title that has been entered will be displayed in the top left corner of the operation screen and "SELECT OBJECT TYPE COND" screen.

Operation screen

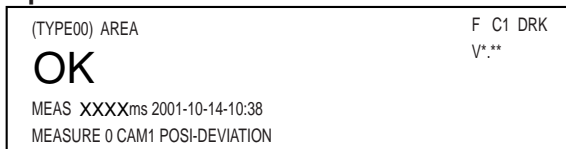

SELECT OBJECT TYPE COND screen

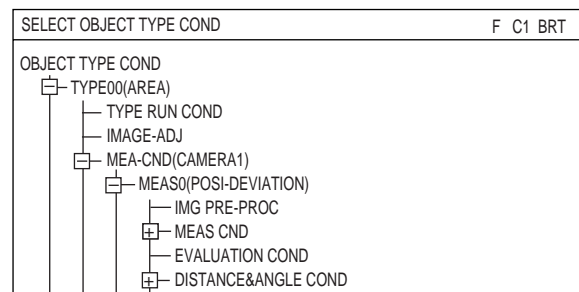

3-3 Input & Output / System settings

[1] Illuminance (light level) monitor

(1) Purpose

1. Allows the system to monitor changes the lighting of the environment

If the light level exceeds the preset lighting range, it will be regarded as a change in the environment and "OVR ILLM RANGE" will be displayed on the MAIN OPS MENU.

2. Automatic adjustment of the threshold values used for binary conversions can follow changes in the lighting environment.

The threshold value is modified from the user's setting due to changes in the actual brightness measured in the environment.

(2) Applications

Used when the level of illumination changed due to changes in voltage or when the influence of sunlight in the workplace cannot be ignored.

(3) Setting procedure

Select "OBJECT TYPE COND" → "TYPE00" (current type) and "OBJ-TYPE SYS," in that order, on the "MAIN MENU" screen.

1. Select "③ MNTR LIGHT LVL (CAM1)" (monitor light level). Select "YES" from the popup menu. Then, the "④ LIGHT LV COND" item will appear on the screen.

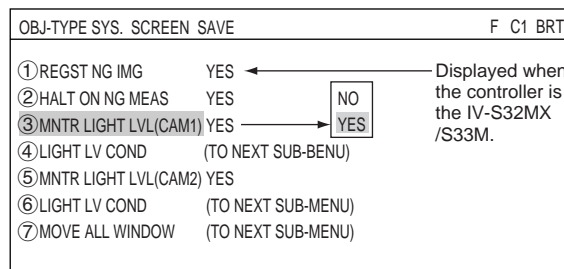

2. Select "④ LIGHT LV COND" and press the SET key. The "LIGHT LV COND" screen and monitoring window will appear.

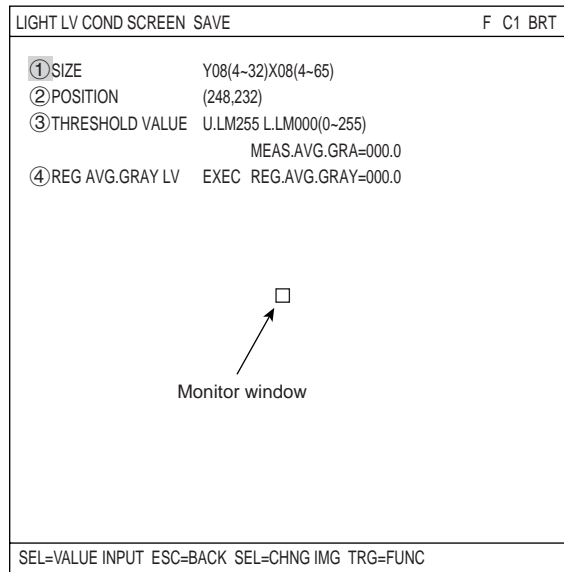

3. Press the SEL key and move the cursor to the upper function menu. Set the image mode to "T" (Through).

4. Select item "①SIZE", and item "②POSITION", using the up and down keys, and press the SET key. Then, set the size and position of the monitoring window using the direction keys.
- The monitoring window should be placed in a location with medium brightness, which does not contain any objects to be measured.
 - The monitor window is a rectangle 4 to 32 pixels tall and 4 to 64 pixels wide (se in multiples of 4 pixels). The monitor window can be moved one pixel at a time.
 - The average light level in the monitoring window is displayed on "MEAS.AVG.GRAYS (average measured light level) in item ③."

[When monitoring changes in the lighting environment] ... If not, go to item 6.

5. Select item "③THRESHOLD VALUE", using the up and down keys, and press the SET key.
- Select the upper and lower limits using the left and right keys, and set the light level range (0 to 255) using the up and down keys. Then, press the SET key.
- ⇒ When the average light level in the monitoring window is out of the preset light level range, "OVR ILLM. RANGE (light level over range)" will be displayed on the MAIN OPS MENU.

[When the threshold value for binary conversion is automatically modified to take into account changes in the lighting environment] If not, go to item 8.

6. Press the SEL key to enter freeze frame the image.
- "F.IMG (freeze)" will be displayed in the upper right corner of the screen.
 - Before reading and storing the next average light level sample, it is necessary to enter the freeze frame.
7. Select item "④REG AVG. GRAY LVL (average light level registration)," using the up and down keys, and press the SET key twice. When the SET key is pressed again, the "REG. AVG. GRAYS (average light level)" will be registered.
- This average light level is required when threshold value correction is selected in the binary conversion method.
 - If the average light level has not been registered, you will see "error 22: BIN MON. LIGHT LVL NOT SET (the light level check function has not been enabled)."
 - The registered light level is the reference value used when threshold values are modified.
 - If the current screen is not a frozen image, "CHANGE TO FREEZE MODE (change to freeze)" will be displayed.
8. Move the cursor to the upper function menu by pressing the TRG/BRT key and select the "SAVE" item using the left and right arrow keys. Then press the SET key.
- A message "SAVE DATA? (YES = [SET], NO = [ESC])" will appear on the screen. Press the SET key to save the data.

After the measurement monitoring function is turned ON and images have been captured, the lighting monitoring function set above will be active.

[2] Setting the shutter speed

The shutter speed can be set independently for each object type.

Since the shutter speed can be set continuously in the range of 1/30 to 1/10,000 of a second, very fine adjustment is possible.

- If you want to measure moving objects and increase the image processing speed, set the shutter speed to around 1/1000 or 1/2000 seconds. However, if you use a faster shutter speed than you need, very bright lights will be necessary, and bright lighting is not economical.
- For details about the relationship between the brightness of objects (objects to be measured) and the shutter speed, see IV-S30 User's Manual (Introduction and Hardware) "5-1 [2] Illumination and shutter speed."

[Example]

- When the shutter speed is slow (1/60 of a second)



The object is blurred across the screen.



- When the shutter speed is fast (1/1000 of a second)

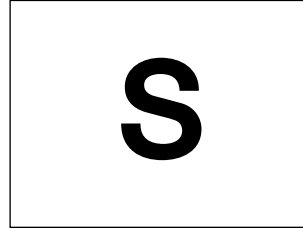

The object is frozen on the screen.

■ Setting procedure

On the MAIN MENU screen, select "OBJECT TYPE COND" Å® "TYPE00" (current type) and "OBJECT TYPE I/O," in that order.

You can specify any value in the range of 1/30 to 1/10000 seconds (initial value 1/60) for the shutter speed.

1. Move the cursor to the "③ SHUTTER SPEED" item on the OBJECT TYPE I/O using the up and down keys, and press the SET key.
2. Press the SET key again, and move the cursor to the digit you want, using the left and right keys.

OBJ-TYPE I/O SCREEN SAVE		F C1 DRK
① TRIG CCD START	BIN	
② CCD TRIG COND	(TO NEXT SUB MENU)	
③ SHUTTER SPEED	1/00060(1/30~1/10000)	
④ SERIAL OUTPUT	ANY	
⑤ CAMNO	NO 1(1~2)	
⑥ CALIBRATION	NO	

1/00060

This cursor will move to the left and right.

3. Set the value using the up and down keys.
4. Repeat steps 3 and 4 to set each digit.
After setting all of the digits, press the SET key.

[3] Copying

When there are many common parameters between object types, it is most efficient to access those existing sets of parameters in order to copy and then modify them.

The parameters of a previously specified object type are copied into another object type, after which they can be modified.

The source of the copy

The measurement conditions of the source object type. (The data is copied from flash memory)



The target of the copy

The measurement conditions of the target object type. (The data is used to simplify setting the target object's parameters)

■ Operation procedure

On the "MAIN MENU" screen, select "OBJECT TYPE COND" and then "TYPE00" (current type). At this point, press the TRG/BRT key to display the popup menu. Select "COPY" from the popup menu and press the SET key.

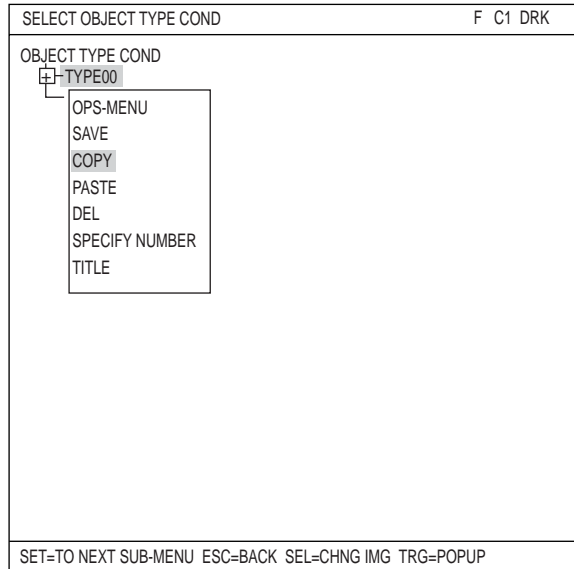

Notes

- Do not disconnect the power while the IV-S30 is copying.
- Once data has been corrupted it will be necessary to start after initializing the setting, all over again. Unless this is done it will not be possible to restart the machine.
- The reference images used for the gray scale search function are not copied with the operation above. Make sure reset them.

[4] NG image registration (IV-S32MX/S33MX)

You can register the NG image (by final evaluation result) while operating the IV-S32MX/S33MX. Select "①REGST NG IMG" of the "OBJ-TYPE SYS." screen for the setting.

■ **Setting method**

1. Select "TYPE00" and then "OBJ-TYPE SYS" on the SELECT OBJECT TYPE COND screen.

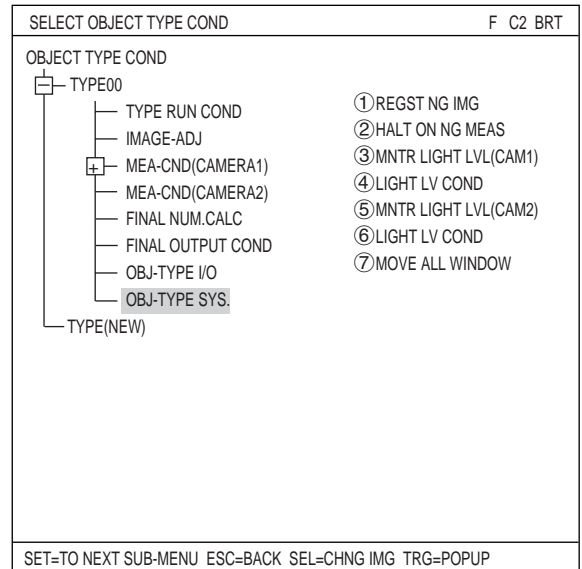

2. Select "①REGST NG IMG" (register NG images) and press the SET key. Then, select "YES" from the popup menu.

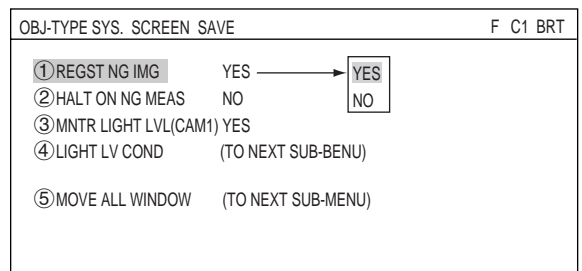

①REGST NG IMG	Description
YES	Register NG images. - 128* is the maximum number of images that can be stored (NG image numbers 0 to 127). If total number of images exceeds 128, the oldest image will be deleted (NG image numbers will be shifted accordingly).
NO	NG images will not be stored.

* A maximum of 128 images can be stored in REGST NG IMG, but the actual number may be smaller, depending on the size of the images to be registered.
 [Limit] When the image size is at the maximum allowed (512 X 480 pixels per screen), a total of 8 images can be stored (1,966,080 pixels = 512 X 480 X 8).
 In another example, if the NG image size is 256 X 240 pixels, a maximum of 32 images of that size can be registered. (256 X 240 X 32 = 1,966,080)

- When the "REGST NG IMG" (NG image registration) is set to "YES" and an NG occurs while measuring, the controller will register the image as an NG image automatically.

[5] Halt on NG measurement

You can stop all measurements when an NG image (according to the final evaluation results) occurs while operating the IV-S30.

Select "②HALT ON NG MEAS" on the "OBJECT TYPE SYS." menu.

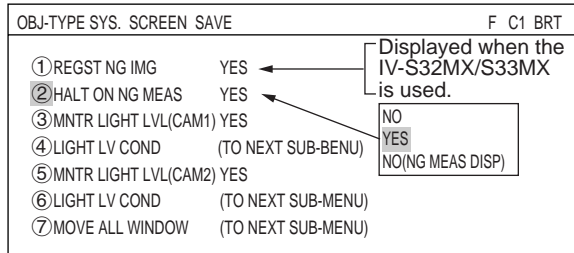

②HALT ON NG MEAS	Description
NO	Even if an NG image (final evaluation result) is detected while operating the IV-S30, the system will continue making measurements.
YES	When an NG image is detected (according to the final evaluation result) while operating the IV-S30, the controller will stop making measurements.
NO(NG MEAS DISP)	Even if an NG image (final evaluation result) is detected while operating the IV-S30, the system will continue making measurements. But, it displays the occurred NG measurements at first.

Shown below is an example of an NG image that occurred during measurement 1.

(Setting whether to stop measurements when an NG occurs)

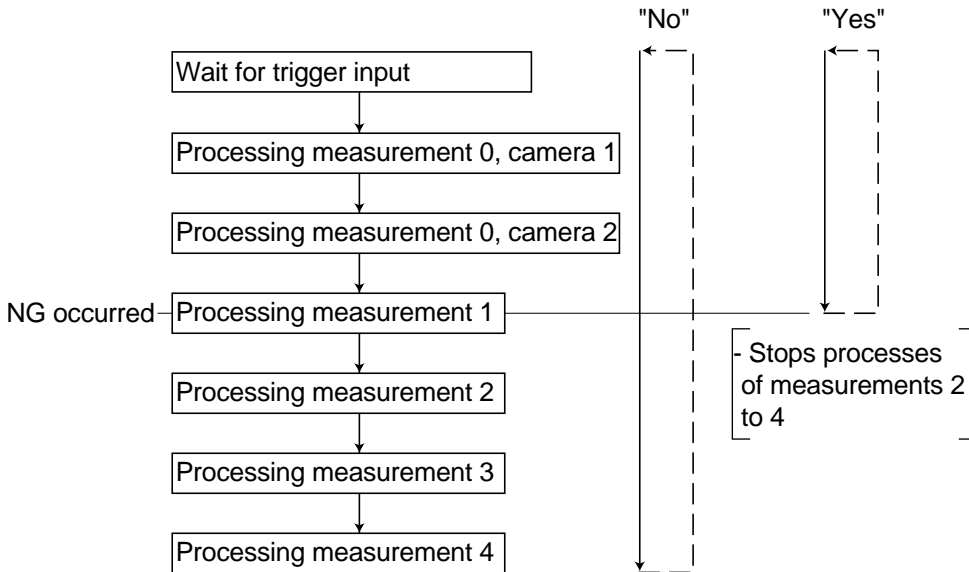

[6] Window group move

All the window positions set in the measurement programs for the same object type number can be shifted horizontally by a specified amount as a group.

[Example of use] Shift the coordinate positions used as data for another object type. (After copying the data between object types, move the windows as a group.)

To set the amount, use "⑦MOVE ALL WINDOW" in the "OBJECT TYPE SYS" menu.

OBJ-TYPE SYS.	SCREEN SAVE	F	C1	BRT
① REGST NG IMG	YES	←		
② HALT ON NG MEAS	YES			
③ MNTR LIGHT LVL(CAM1)	YES			
④ LIGHT LV COND	(TO NEXT SUB-MENU)			
⑤ MNTR LIGHT LVL(CAM2)	YES			
⑥ LIGHT LV COND	(TO NEXT SUB-MENU)			
⑦ MOVE ALL WINDOW	(TO NEXT SUB-MENU)			

Displayed when the IV-S32MX/S33MX is used.

3

1. While "①SELECT CAMERA" is selected, press the up and down arrow keys to select either "CAM1" or "CAM2." Then press the SET key.

Note: When "CAM1&NG IMGs" is selected for the "①MONITOR OUTPUT," the "①SELECT CAMERA" item is limited to "CAM1."

⇒ See page 1-19 for details about the "①MONITOR OUTPUT."

MOVE ALL WIN	SCREEN SAVE	F	C1	BRT
① SELECT CAMERA	CAM1			
② STR COORD POSI	MOVE(256,240) COORDINATES STORED			
③ MOVE ALL WINDOW	MOVE(256,240) EXEC			

2. Select "②STR COORD POSI" (store coordinate position) and press the SET key. Then select "MOVE" by using the left and right arrow keys and finally, press the SET key.
3. Move the cursor (solid line) to the original coordinates before the move using the up, down, left, and right keys, and press the SET key.
4. Select "COORDINATES STORED" using the left and right keys, and press the SET key. After that press the ESC key.
⇒ The coordinates before the move are now registered.
5. Select "③MOVE ALL WINDOW" using the up and down keys and press the SET key. Select "MOVE" using the left and right keys and press the SET key.
6. Move the cursor (dotted line) to the new coordinates you are moving to use the up, down, left, and right keys and press the SET key.

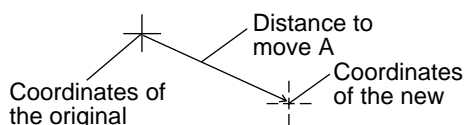

7. Select "EXEC" (execute) using the left and right keys and press the SET key.
⇒ All the windows registered to the same object type will be shifted horizontally at the same time by the distance between the original coordinates to the new coordinates. After the move is complete, a "Window group move is complete" message will be displayed.

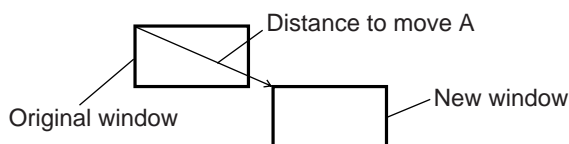

- When some part of the window to be moved will move outside of the image display area, the "Out of range" message will be displayed together with the measurement number and register number. In this case, select "Continue" or "Halt."
If "Continue" is selected, the window will be shifted to the limit within the image display area.

Chapter 4: Positional Deviation Measurement

4-1 Outline

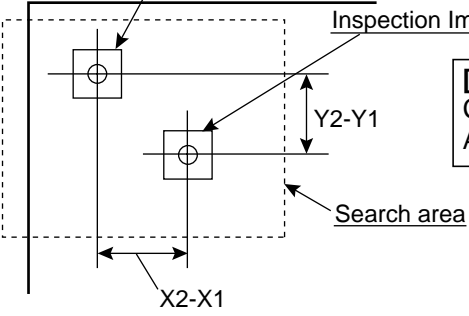
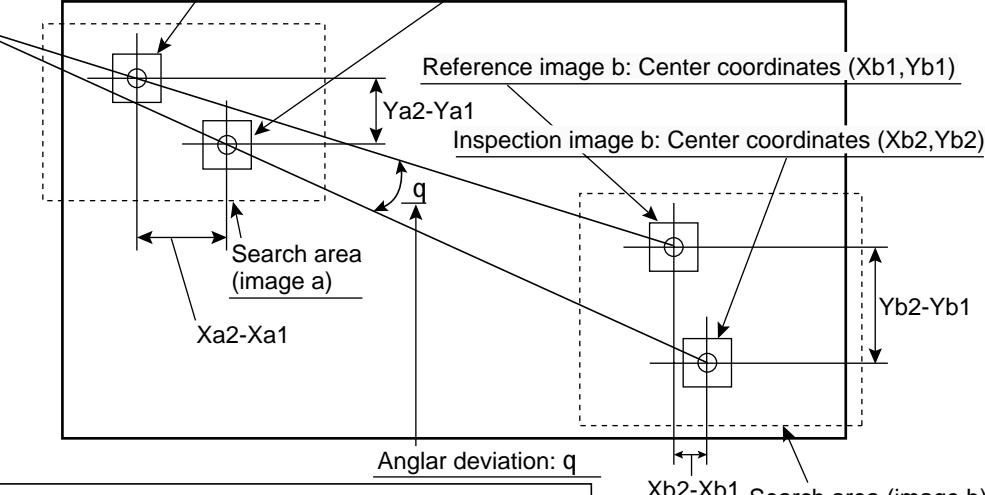
Purpose	<p>The gray scale search function and edge detection function* make possible measuring positional deviation as well as the absolute position.</p> <ul style="list-style-type: none"> - It is also possible to detect the position of sub-pixel units with great accuracy. - A rotation angle of 360° can be detected. (When a one point gray search is selected).
Application	<p>Used to determine the position of machine parts and substrates.</p>
Example	<p>[Determining the location of the positioning (the fiducial mark) mark that identifies the position of the substrate]</p> <p>(1) 1 point search: Detecting the deviation in position in X and Y directions Reference image: Center coordinates (X1,Y1) Inspection Image: Center coordinates (X2,Y2)</p>  <p>[Measured result] Center coordinates: (X2,Y2) Amount of deviation: X2-X1, Y2-Y1</p> <p>(2) 2 point search: Determining positional deviation in X and Y directions as well as rotational deviation Reference image a: Center coordinates (Xa1,Ya1) Inspection image a: Center coordinates (Xa2,Ya2) Reference image b: Center coordinates (Xb1,Yb1) Inspection image b: Center coordinates (Xb2,Yb2)</p>  <p>[Measured results]</p> <ul style="list-style-type: none"> - Center coordinates of image a: (Xa2,Ya2) - Amount of deviation of image a: Xa2-Xa1, Ya2-Ya1 - Center coordinates of image b: (Xb2,Yb2) - Amount of deviation of image b: Xb2-Xb1, Yb2-Yb1 - Deviation angle: q <p>* Gray scale search / edge detection function Gray scale search: Compares a workpiece image with the 256-level gray-scale reference image to find an area that matches the reference image. ⇒ See page G-6 of the User's Manual (Hardware & Instruction). Edge detection: Finds the boundary between light and dark areas in an image. ⇒ See page G-3 of the User's Manual (Hardware & Instruction). - The deviation angle q, determined in the 2-point search, is used to readjust the rotation of the image for measurements 1 to 4.</p>

4-2 Setting operation

■ Setting the measurement conditions

Select "MAIN COND" -> "OBJECT TYPE COND" -> "TYPE00" -> "MEA CND (CAMERA1)" -> "MEAS0," in that order.

On the "① MEAS SELECTION" line, select "POSI-DEVIATION" from the popup menu. Press the ESC key to return to the OBJECT TYPE COND (menu tree) screen, and select the "MEAS CND" item to enter the MEAS CND screen.

⇒ For details, see "Chapter 8: Setting examples using the menu tree" in Introduction and Hardware.

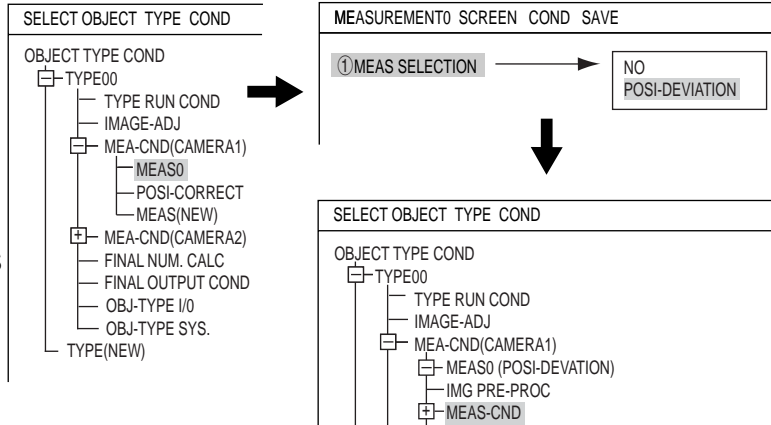

Note: "POSI-DEVIATION" (positional deviation) measurement can be specified in the "MEAS0" (measurement 0) and "MEAS1" (measurement 1) to "MEAS4" (measurement 4) functions. If you choose "MEAS(NEW)," the smallest available measurement number will be chosen automatically ("MEAS1" to "MEAS4").

① DTECT PRECISION

Select detection precision. You can select one of two levels (standard/high), according to your conditions, the desired precision level for detection results, and the detection speed.

⇒ For details, see page 3-10.

② REGISTER NO.

Enter a register number. When making positional deviation measurements, you can select any register from 0 to 7 (a total of 8 registers).

③ MODE

Select a mode for detection.

The details of each mode are as follows.

The screenshot shows the "MEAS CND SCREEN COND SAVE" screen with the following settings:

- ① DTECT PRECISION: STANDARD (with a popup menu showing "STANDARD" and "HIGH")
- ② REGISTER NO.: 0 (0~7)
- ③ MODE: 1P-SCH (with a popup menu showing "NO", "1P-SCH", "2P-SCH", "1P-EDGE", "2P-EDGE", "1P-SCH+1P-EDGE")
- ④ DTECT ANGL: ±15° (with a popup menu showing "NO", "±15°", "±30°", "±45°", "360°")
- ⑤ ANGLE UNIT: 10
- REGISTER NO. table:

0001	0203	0405	0607	0809	1011
S	X	X	X	X	X
MDL 0	X	X	X	X	X
MDL 1	X	X	X	X	X

 The bottom of the screen displays: "SET=SELECT A MENU FOR ESC=BACK SEL=CHNG IMG TRG=FUNC"

Detection Mode	Details	Usable models
NO (None)	Does not detect.	
1P-SCH (1-point search)	Detect the positional deviation of one point in the scanned image compared to a single reference image, after performing a gray search.	Model 0 only
2P-SCH (2-point search)	Detect the positional deviation of two points in the scanned image compared to two reference images, after performing a gray search.	Model 0 and 1
1P-EDGE (1-point edge)	Detect the positional deviation of one point in the scanned image compared to a single reference image, after performing edge detection.	Model 0 only
2P-EDGE (2-point edge)	Detect the positional deviation of two points in the scanned image compared to two reference images, after performing edge detection.	Model 0 and 1
1P-SCH + 1P-EDGE (1-point search and 1-point edge)	Detect the positional deviation of two points, one point after performing a gray search and one point after performing edge detection.	Model 0 and 1

Gray search ⇒ See page 3-10.

Edge detection ⇒ See page 3-15.

③ DTECT ANGL and ④ ANGLE UNIT

When the "1P-SCH" or "1P-SCH + 1P-EDGE" is selected in "③MODE," you can specify angle detection.

⇒ For details about angle detection, see page 4-12.

Select a detection range on the "④DTECT ANGL" line and select the units at "⑤ANGLE UNIT."

REGISTER NO. (⑥MDL 0, ⑦MDL 1)

The specified modes are displayed for each register number on these lines. When a 1-point search or 1-point edge is specified, only "⑥MDL 0" will be available. When a 2-point search, 2-point edge, or 1-point search and 1-point edge is specified, "⑦MDL 1" is also available.

The "S" in the table indicates a gray search, and the "E" indicates edge detection. "X" means not used.

• An example of mode settings

REGISTER NO.	00	01	02	03	04	05	06	07	08	09	10	11	12	13	14	15
⑥MDL0	S	S	S	E	E	X	X	X								
⑦MDL1	S	X	E	E	X	X	X	X								

S : Gray search
 E : Edge detection
 X : No setting

REGISTER0 : 2P-SCH
 REGISTER1 : 1P-SCH
 REGISTER2 : 1P-SCH + 1P-EDGE
 REGISTER3 : 2P-EDGE
 REGISTER4 : 1P-EDGE

■ How to set the register conditions

• How to enter the REG-COND setting screen

There are three methods for getting to the REG-COND setting screen.

- 1) On the MEAS CND setting screen, move the cursor to "⑥MDL 0" or "⑦MDL 1" and press the SET key. The cursor will move into the table. Move the cursor to the "S" or "E" column and press the SET key.

Note: If you press the SET key in the "X" column, the setting will be invalid.

About "S" ⇒ See pages 4-4 to 6.

About "E" ⇒ See pages 4-7 to 8.

- 2) On the MEAS CND setting screen, press the TRG/BRT key to move the cursor to the upper function menu. Select the "COND" item and then select the "REG-COND(S)" or "REG-COND(E)" item and press the SET key.

About "REG-COND(S)"

⇒ See pages 4-4 to 6

About "REG-COND(E)"

⇒ See pages 4-7 to 8.

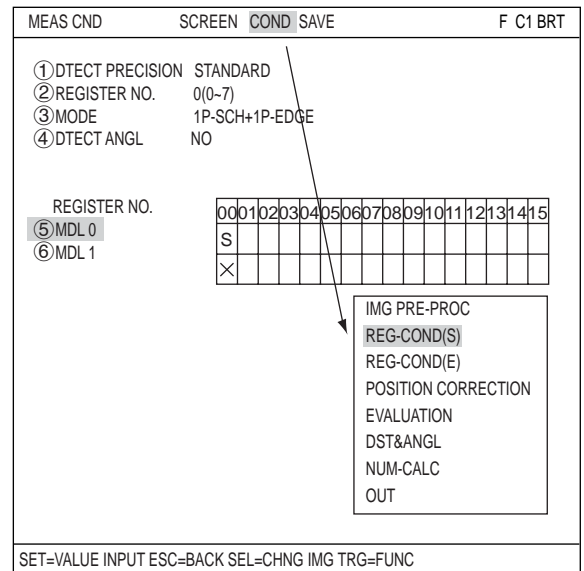

3) On the menu tree, move the cursor to the "MEAS CND" item, and press the right arrow key. The sub menu which contains the "REG-COND(S)" and "REG-COND(E)" items will appear. Move the cursor to either of these items and press the SET key.

About "REG-COND(S)"
 ⇨ See pages 4-4 to 6.
 About "REG-COND(E)"
 ⇨ See pages 4-7 to 8.

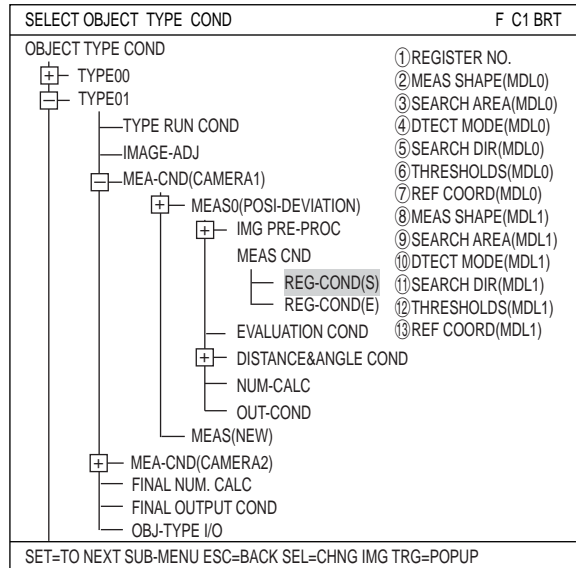

[1] Set the register conditions for a gray search

② MEAS SHAPE

Select a window shape to be used for the positional deviation measurement. Select "RECTANGLE," "X-LINE," or "Y-LINE" from the popup menu on the "②MEAS SHAPE" line.

RECTANGLE	Specify coordinates for the upper left and lower right corners. The window will be a rectangular area defined by these coordinates.
X-LINE	Length of a line from the start point to the end point on the X axis.
Y-LINE	Length of a line from the start point to the end point on the Y axis.

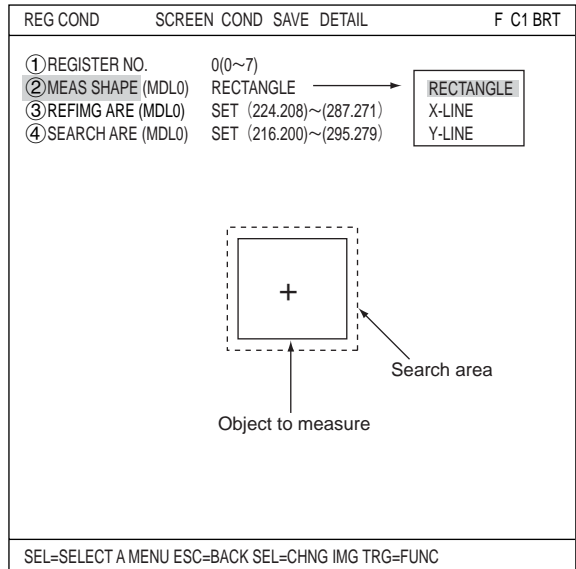

③ REFIMG ARE

Move the cursor to "③REFIMG ARE(MDL0)" and press the SET key. When the SET item is highlighted, press the SET key again to bring up the setting screen.

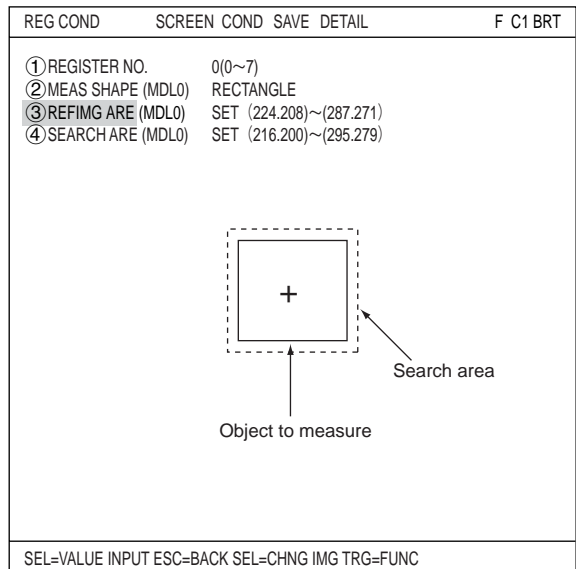

When a rectangle is selected

Specify the upper left and lower right corners of the reference image area. Move the cursor to the "①UP.L" and press the SET key. Lines for the X and Y axes will appear on the reference image area (shown as a solid line). Move the X and Y lines to the desired position using the up/down/left/right arrow keys to set the coordinates for the upper left corner. When correct, press the SET key.

- To leave the coordinates at their previous position, press the ESC key.

Next, move the cursor to the "②LO.R" and press the SET key to determine the lower right corner of the rectangle. The range inside the rectangle of the solid line becomes the reference image.

● Setting screen (RECTANGLE)

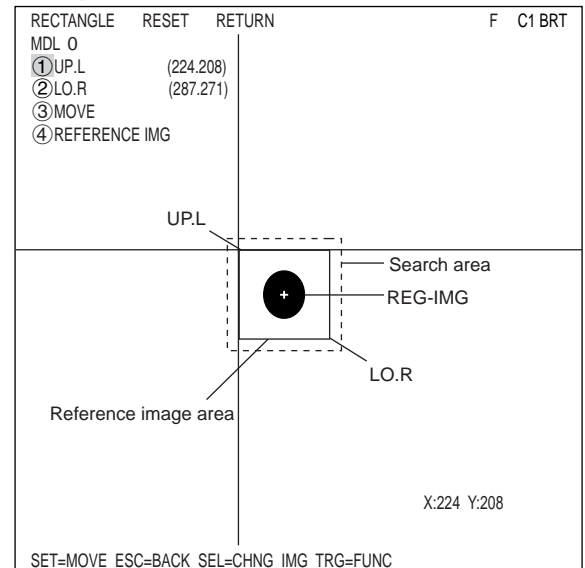

When a horizontal line is selected

Specify the start and end points on the X axis. Specify the start and end points using the up/down/left/right arrow keys. The points will move along the X axis (while keeping the same Y coordinate).

Note: Specify a search area longer than the reference image area. Specifying a shorter search area may cause an error message to be displayed.

● Setting screen (X-LINE)

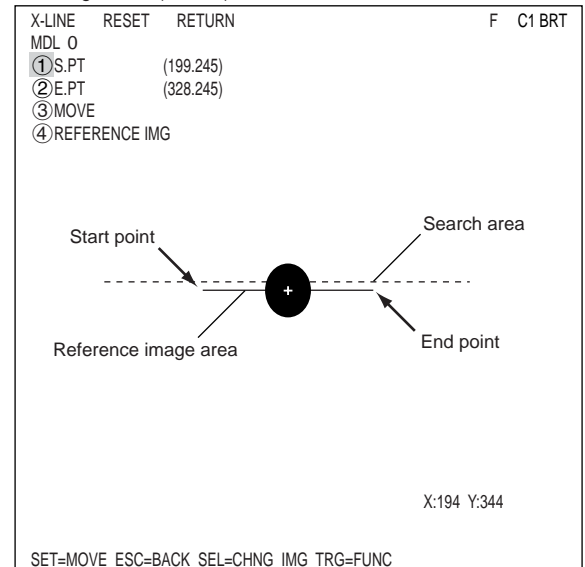

When a vertical line is selected

Specify the start and end points on the Y axis. Specify the start and end points using the up/down/left/right arrow keys. The points will move along the Y axis (while keeping the same X coordinate).

Note: Specify a search area longer than the reference image area. Specifying a shorter search area may cause an error message to be displayed.

● Setting screen (Y-LINE)

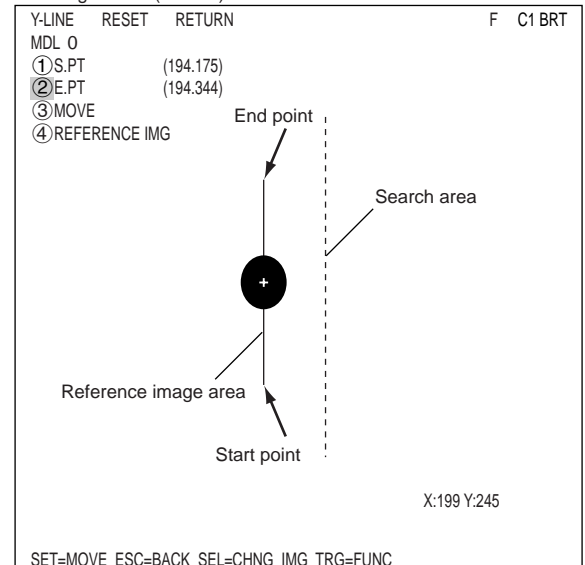

Register a reference image

After setting the reference image area, store an image in the controller as a reference image. Select "④REFERENCE IMG" using the up/down arrow keys and select "REG" from the popup menu.

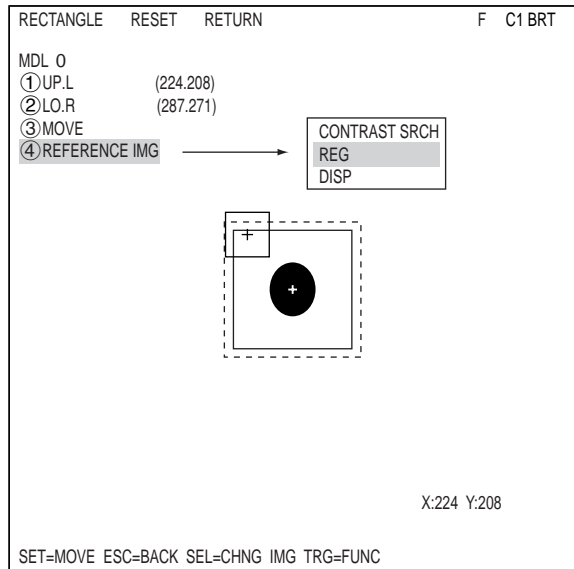

CONTRAST SRCH (contrast search)	After changing to a gray search, automatically search for the area with the most features (maximum contrast) in the captured image.
REG (register)	Store the currently displayed image as a reference image.
DISP (display)	Select any one of the registered reference images using the up/down/left/right arrow keys, the selected reference image will be displayed in the lower right of the screen.

④ SEARCH ARE

Specify the search area (inside the dotted lines) on the "④SEARCH ARE (MDL0)" line, using the same procedures used for setting the reference image area.

If you are selecting a 2-point search, also set the points the same way as for MDL1.

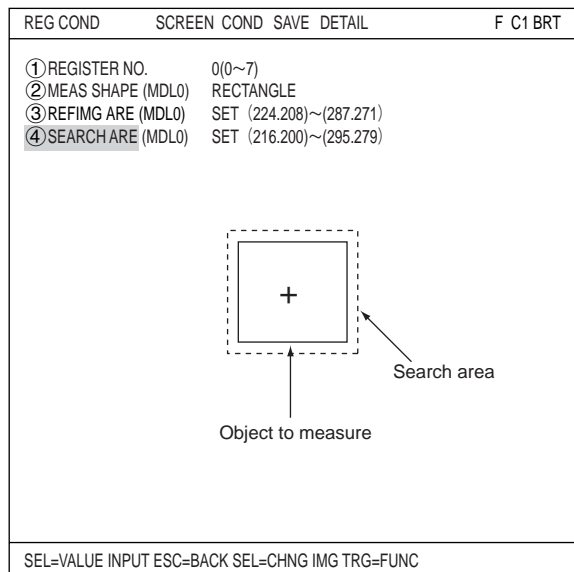

An example of storing

- This is an example of a 2-point search when the detection shape is a rectangle.

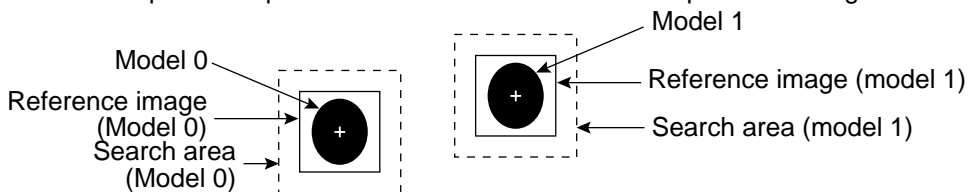

Note: When setting the horizontal and vertical lines, specify the line length as follows:
The reference image must shorter than the search area lines.

⑤ REFIMG

Move the cursor to the function menu on the REG COND screen by pressing the TRG/BRT key. Move the cursor to "DETAIL." Press the SET key on the "REFERENCE IMG" line in the popup menu. The white square on the left will change to a black square. Then, the "⑤REF IMG" item will appear on the screen.

- You can use the same procedures to show "DTECT CRD" (detection coordinates) and "CONTR.PIXL" (contraction pixels) on the screen.

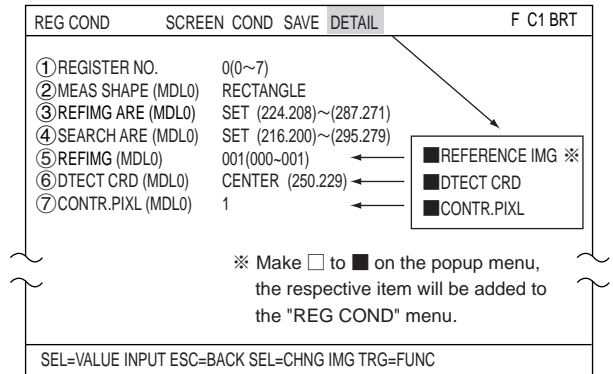

On the "⑤REF IMG" line, select a reference image from the reference images already registered.

Ex : 015 (000 to 026)

Select reference image No. 15 from the 26 registered reference images (000 to 026).

⑥ DTECT CRD (detection coordinates)

Select whether to use the detection coordinates as the center of the reference area or to allow the point to be set freely.

⑦ CONTR.PIXL (contraction pixels)

When "RECTANGLE" was selected at "②MEAS SHAPE," you can select items 1 to 3 below. When "X-LINE" or "Y-LINE" was selected, you can select items 1 or 2 below.

- 1: Search the image in units of 2 pixels.
- 2: Search the image in units of 4 pixels.
- 3: Search the image in units of 8 pixels.

[2] Setting the register conditions for edge detection

② MEAS SHAPE (MDL 1)

Select a measurement shape.

RECTANGLE
 LINE (straight line)
 CIRC-L (circle)
 ELIP-L (ellipse)

Select a pattern to be used for image processing.
 ⇨ See pages 3-5 to 3-9.

NO ARTF/ARTIF: Select whether to detect edge or not with average density.
 ⇨ See page 3-16.

③ SEARCH AREA

Select "③SEARCH AREA (MDL1)" and press the SET key to go to the setting screen.

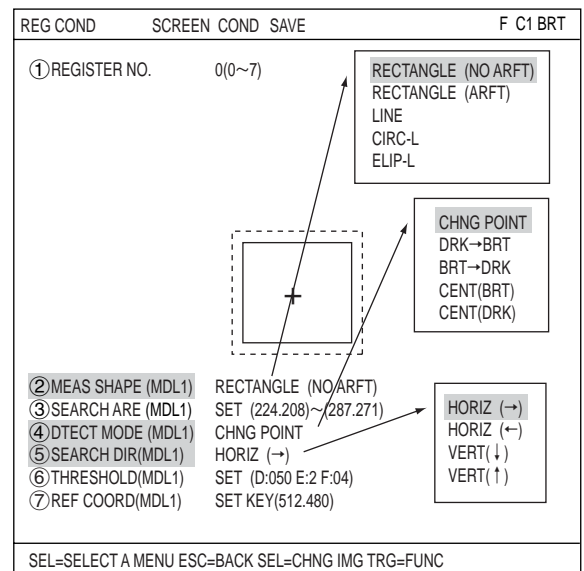

When a rectangle is selected

Highlight "①UP.L" and press the SET key. The X and Y axes will appear in the detection area. Move the X/Y axes using the up/down/left/right arrow keys to identify the upper left corner. When correct, press the SET key.

- To return to the previous coordinates, press the ESC key.

Next, highlight "②LO.R" and press the SET key. Identify the lower right corner the same way.

④ DTECT MODE

Select an image processing method for the edges.

- CHNG POINT
- DRK -> BRT
- BRT -> DRK
- CENT (BRT)
- CENT (DRK)

⇒ See page 3-15.

● Setting screen (RECTANGLE)

RECTANGLE	RESET	RETURN	F C1BRT
MDL 0			
①UP.L	(224.208)		
②LO.R	(287.271)		
③MOVE			
④REFERENCE IMG			

X:224 Y:208

SET=MOVE ESC=BACK SEL=CHNG IMG TRG=FUNC

⑤ SEARCH DIR

Specify a search direction. The direction for searching varies with each detection shape.

● When "RECTANGLE" is selected

Horizontal (→)	Scan the reference line from left to right (→)
Horizontal (←)	Scan the reference line from left to right (←)
Vertical (↓)	Scan the reference line from top to bottom (↓)
Vertical (↑)	Scan the reference line from bottom to top (↑)

● When "LINE" is selected

Start point → End point	Scan along a straight line from the starting point to the end point
End point → Start point	Scan along a straight line from the end point to the starting point

● When "CIRC-L" or "ELIP-L" is selected

Clockwise direction	Scan around the circumference clockwise
Counter-clockwise direction	Scan around the circumference counter-clockwise

⇒ For details, see page 3-15.

⑥ THRESHOLD

Specify a threshold value for binary conversion.

⇒ For details, see page 3-11.

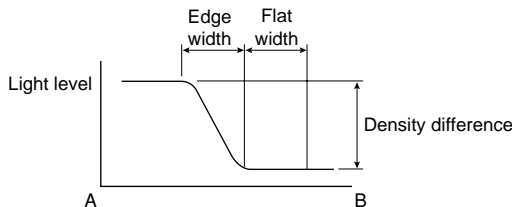

Automatic setting

Select "AUTO-REG" from the upper function menu on the THRESHOLD setting screen. The controller will set the optimum value automatically.

⇒ For details, see page 3-11

⑦ REF COORD (reference coordinates)

You can change the reference coordinates to any desired position.

■ Set the evaluation conditions

● How to move to the evaluation condition setting screen

There are two methods for getting to the evaluation condition setting screen.

- 1) Select "COND" in the upper function menu on the MEAS COND(or REG COND) screen and press the SET key. Select "EVALUATION" on the pop up menu to go to the EVALUAT COND screen.

MEAS COND	SCREEN	COND	SAVE	F C1 BRT
① DTECT PRECISION	STANDARD			
② REGISTER NO.	0(0~7)			
③ MODE	1P-SCH			
④ DTECT ANGL	NO			
⑤ ANGLE UNIT				
REGISTER NO.	000102030405060708			
⑥ MDL 0	S	X	X	X
⑦ MDL 1	X	X	X	X

IMG PRE-PROC
REG-COND(S)
REG-COND(E)
POSITION CORRECTION
EVALUATION
DST&ANGL
NUM-CALC
OUT

SET=SELECT A MENU FOR ESC=BACK SEL=CHNG IMG TRG=FUNC

- 2) Move the cursor to the "EVALUATION COND" item on the Menu tree screen and press the SET key.

SELECT OBJECT TYPE COND	F C1 DRK
OBJECT TYPE COND	
TYPE00	① REGISTER NO.
TYPE RUN COND	② CONDITION SET
IMAGE-ADJ	③ X COORD.(MDL0)
MEAS-CND(CAMERA1)	④ Y COORD.(MDL0)
MEAS0(POSI-DEVIATION)	⑤ x DEVAITE(MDL0)
IMG PRE-PROC	⑥ y DEVAITE(MDL0)
MEAS CND	⑦ MATCH LVL(MDL0)
REG-COND(S)	⑧ ANGULAR DEVIATE(MDL1)
REG-COND(E)	⑨ X COORD.(MDL1)
EVALUATION COND	⑩ Y COORD.(MDL1)
DISTANCE&ANGLE COND	⑪ x DEVAITE(MDL1)
NUM-CALC	⑫ y DEVAITE(MDL1)
OUT-COND	⑬ EDGE DTECT(MDL1)
MEAS(NEW)	⑭ TEST
MEAS-CND(CAMERA2)	
FINAL NUM. CALC	
FINAL OUTPUT COND	
OBJ-TYPE I/O	

SET=TO NEXT SUB-MENU ESC=BACK SEL=CHNG IMG TRG=POPUP

The "EVALUAT COND"(evaluation conditions) screen will appear.

- ⇒ For details about the evaluation conditions, see page 3-18.

EVALUAT COND	SCREEN	COND	SAVE	EDIT	SEL	F C1 BRT
① REGISTER NO.	0(0~7)				[TEST RESULT]	[OUTPUT]
② CONDITION SET	AUTO(-10%)					
③ X COORD.(MDL0)	000.0~511.0	X0=				NO
④ Y COORD.(MDL0)	000.0~479.0	Y0=				NO
⑤ x DEVAITE(MDL0)	-511.0~+511.0	x0=				NO
⑥ y DEVAITE(MDL0)	-479.0~+479.0	y0=				NO
⑦ MATCH LVL(MDL0)	-10000~+10000	M0=				NO
⑧ ANGULAR DEVIATE(MDL1)	-180.0~+180.0	B0=				NO
⑨ X COORD.(MDL1)	000.0~511.0	X1=				NO
⑩ Y COORD.(MDL1)	000.0~479.0	Y1=				NO
⑪ x DEVAITE(MDL1)	-511.0~+511.0	x1=				NO
⑫ y DEVAITE(MDL1)	-479.0~+479.0	y1=				NO
⑬ EDGE DTECT(MDL1)	YES	K1=				NO
⑭ TEST	EXEC(WITH-POSI.ADJ WITHOUT-POSI.ADJ)					

SET=VALUE INPUT ESC=BACK SEL=CHNG IMG TRG=FUNC

■ **Numeric calculation setting**

- Press the TRG/BRT key to move the cursor to the upper function menu, and highlight "COND" using the left and right arrow keys. Press the SET key to show the popup menu. Select "NUM-CALC" from the popup menu.
- Select "NUM-CALC" on the menu tree.
- ⇒ See "Chapter 15: Numerical calculations."

■ **Output condition setting**

- Press the TRG/BRT key to move the cursor to the upper function menu, and highlight "COND" using the left and right arrow keys. Press the SET key to display the popup menu. Select "OUT" from the popup menu.
- Select "OUT-COND" on the menu tree.
- ⇒ See "Chapter 17: Setting the Input/Output Conditions."

■ **Display the measurement results**

Return to the operation screen and press the TRG/BRT key. The measurement results will be displayed on the screen.

Registration number

Detection coordinates in the reference image for model 0

Amount of deviation from the reference image for model 0

Degree of match with the reference image for model 0

Amount of angular deviation

Detection coordinates in the reference image for model 1

Amount of deviation from the reference image for model 1

Degree of match with the reference image for model 1

● 1P-SCH+1P-EDGE

(TYPE00) F C1 BRT
V**

OK

MEAS XXXXms 2002-01-01 10:30
MEASURE 0 CAM1 POSI-DEVIATION

REGISTER NO(0-7)	
[X0=176.0 OK	
[Y0=322.0 OK	
[X0=+000.0 OK	
[Y0=+000.0 OK	
M0=+10000 OK	
B0=+001.7 OK	
[X1=534.0 OK	
[Y1=480.0 OK	
[X1=+001.0 OK	
[Y1=+001.0 OK	
K1=1	

X0-7 [] Y0-7 [] READY []

MNU-CHG MAIN-COND CHG-MEA COND-CHG CHNG-REG SCREEN-CHG CHG-TYPE

⇒ For display examples of measurement results using other modes, see the next page.

The displays for other modes are shown in the next page.

■ 1-point search

Registration number	→	REGST NO. 0(0~7)
Detection coordinates in the reference image for model 0	→	X0=176.0 OK
	→	Y0=322.0 OK
Amount of deviation from the reference image for model 0	→	x0=+000.0 OK
	→	y0=+000.0 OK
Degree of match with the reference image for model 0	→	M0=+10000 OK
* Rotation angle	→	B0=+002.6 OK

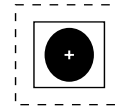

4

* Angle will be displayed when "DTECT ANGL" is set to "YES."

■ 2-point search

Registration number	→	REGST NO. 0(0~7)
Detection coordinates in the reference image for model 0	→	X0=176.0 OK
	→	Y0=322.0 OK
Amount of deviation from the reference image for model 0	→	x0=+000.0 OK
	→	y0=+000.0 OK
Degree of match with the reference image for model 0	→	M0=+10000 OK
Amount of angular deviation	→	B0=+001.7 OK
Coordinates in the detect point for model 1	→	X1=534.0 OK
	→	Y1=480.0 OK
Amount of deviation in the detect point for model 1	→	x1=+001.0 OK
	→	y1=+001.0 OK
The number of the detect point for model 1	→	K1=1 OK

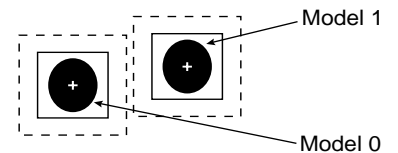

■ 1-point edge

Registration number	→	REGST NO. 0(0~7)
Coordinates in the detect point for model 1	→	X0=176.0 OK
	→	Y0=322.0 OK
Amount of deviation in the detect point for model 1	→	x0=+000.0 OK
	→	y0=+000.0 OK
The number of the detect point for model 1	→	K0=1 OK
	→	B0=

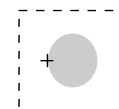

■ 2-point edge

Registration number	→	REGST NO. 0(0~7)
Coordinates in the detect point for model 0	→	X0=176.0 OK
	→	Y0=322.0 OK
Amount of deviation in the detect point for model 0	→	x0=+000.0 OK
	→	y0=+000.0 OK
The number of the detect point for model 0	→	K0=1 OK
Amount of angular deviation	→	B0=+001.7 OK
Coordinates in the detect point for model 1	→	X1=534.0 OK
	→	Y1=480.0 OK
Amount of deviation in the detect point for model 1	→	x1=+001.0 OK
	→	y1=+001.0 OK
The number of the detect point for model 1	→	K1=1 OK

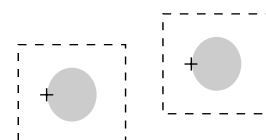



Angle detection

You can detect the angle of an object by selecting 1P-SCH (1-point search) in the POSI-DEVIATION item (measurement 0 to 4) .

(1) Angle detection by object shape

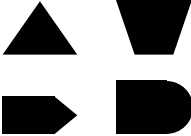
There are some objects whose angle cannot be detected, due to the shape of the object and the compression level used for the gray scale search, as shown in the table below.

Object shape	Angle detection	Difficulty level
	The angle cannot be detected.	×
	The angle can be detected using a compression level of 2 for the gray scale search.	△
	The angle can be detected.	○

- The information given above is true when the measurement conditions are as follows: the size of the reference image to be registered is approximately 64 X 64, and the search size is approximately 100 X 100.

(2) Setting method

On the [MEAS CND] screen, select the "1P-SCH" or "1P-SCH+1P-EDGE" mode on the "③MODE" and then select the "④DTECT ANGL" item. ⇨ See page 4-2.

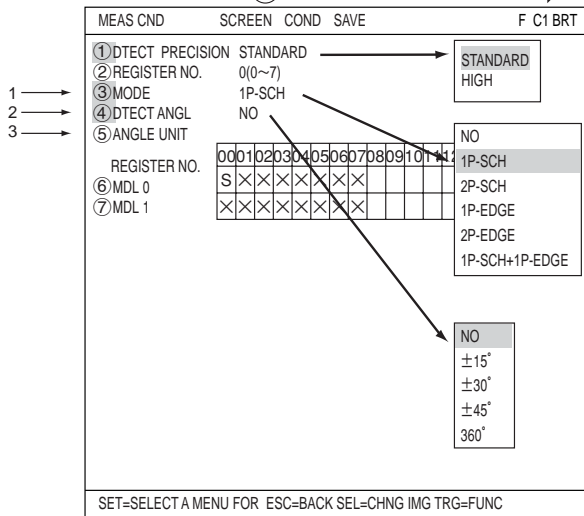

1. Select the "1P-SCH" or "1P-SCH+1P-EDGE" mode on the "③MODE".
2. Select the angle search range (−15°, −30°, −45°, −360°) on the "④DTECT ANGL" item. The larger the angle search range, the slower the processing will be.
3. Select a rotation step size in degrees in "⑤ANGLE UNIT," using the up and down keys. The relationship between the detection range (unit) of the rotation angle and the reference images to be created is shown below:

Rotation angle		Reference image created	
Detection range	Unit	Rotation angle	Quantity
±15°	1	-17, -16, -15, -14, +14, +15, +16, +17	35
	3	-21, -18, -15, -12, +12, +15, +18, +21	15
	5	-25, -20, -15, -10, -5, 0, +5, +10, +15, +20, +25	11
	10	-15, -10, 0, +10, +15	5

To the next page

Rotation angle		Reference image created	
Detection range	Unit	Rotation angle	Quantity
±30°	2	-34, -32, -30, -28, • • • • • +28, +30, +32, +34	35
	3	-36, -33, -30, -27, • • • • • +27, +30, +33, +34	25
	5	-40, -35, -30, -25, • • • • • +25, +30, +35, +40	17
	6	-42, -36, -30, -24, • • • • • +24, +30, +36, +42	15
	10	-30, -20, -10, 0, +10, +20, +30	7
±45°	3	-51, -48, -45, -42, • • • • • +42, +45, +48, +51	35
	5	-55, -50, -45, -40, • • • • • +40, +45, +50, +55	23
	10	-45, -40, -30, -20, -10, 0, +10, +20, +30, +40, +45	11
Full angle	10	-170, -160, -150, • • • • • +150, +160, +170, +180	36

4. On the settings for the gray scale search conditions (page 4-4), register the object by surrounding it with a square window, regardless of the shape of the object to be measured.

● Example

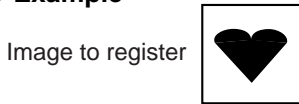

When triggered to store the reference image, the system will store various views of the object in memory by rotating the image, 10 degrees at a time.

● When the angle range is set to -360° (Rotation angle unit : 10)

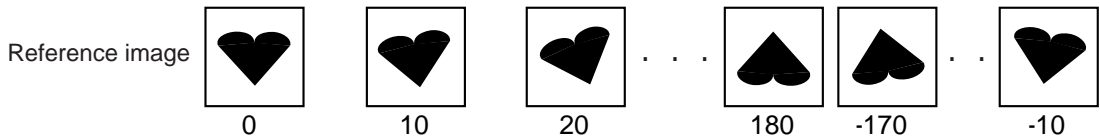

5. Specify a search area that is large enough to include various positional deviations of the object.

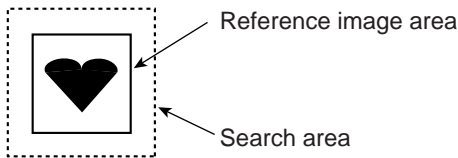

6. When starting the measurement, the system will execute a gray scale search of the captured image based on the stored reference images, which were created by rotating the basic image, 10 degrees at a time in step 3 above.

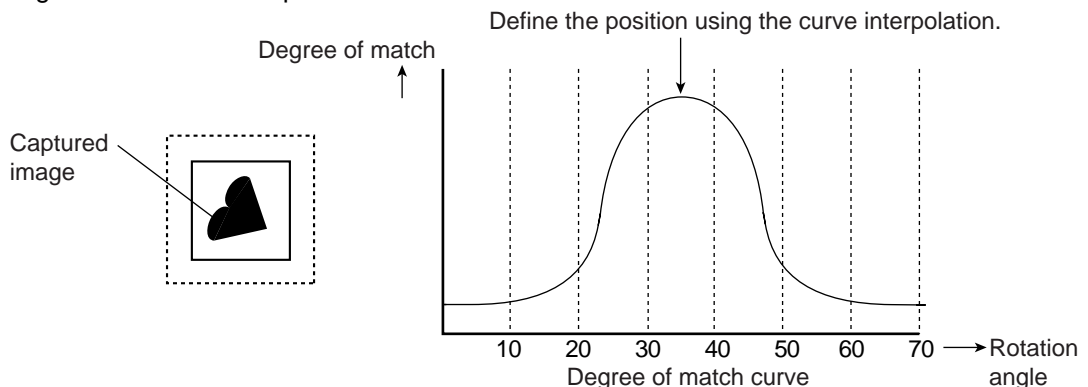

Note: When "NO" is selected for the "DTECT ANGL" (rotation angle detection) in the previous page after registering the reference image, a "Reference image condition mismatch" error will occur when executing the measurement.

Chapter 5: Degree of Match Inspection

5-1 Outline

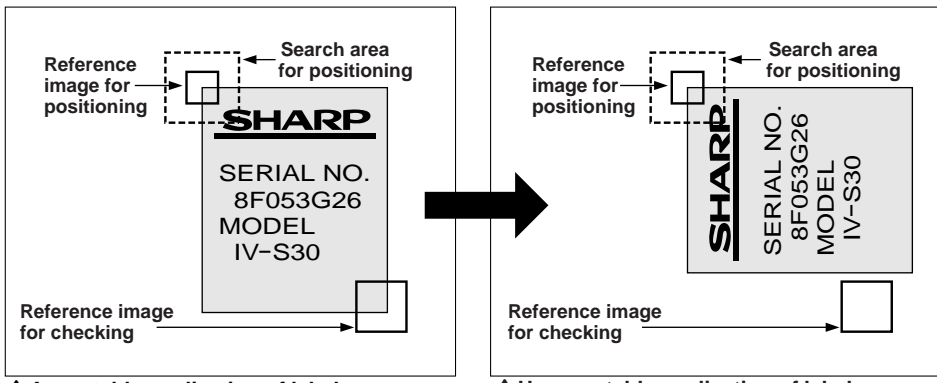
Purpose	The gray search function is capable of finding the differences between the non-defective reference image and the image to be inspected evaluating the degree of match. (The acceptability of the workpiece is evaluated based on its level of similarity to the reference model.)
Applications	Checking for misalignment of labels, checking for entry of wrong parts, checking that electronic components have been precisely mounted on PC boards, checking for misprints, checking for missing metallic parts, such as terminals, and simple inspection of lettering
Examples	<p>[Checking for label misalignment on package]</p>  <p>▲ Acceptable application of label ▲ Unacceptable application of label</p> <p>[Measurement results]</p> <ul style="list-style-type: none"> - Degree of match compared with the reference image - Detected coordinates (X/Y) of the measurement image. - Light level in the measured image (average light level/absolute value of difference) <p>- Checking sequence</p> <ol style="list-style-type: none"> ① A gray search for the reference image for positioning is made. ② After the position of the reference image for checking is corrected based on the coordinates of the reference image for positioning found in step ①, the degree of match is determined. ③ If the degree of match of the reference image for checking is low, the label is regarded as applied incorrectly.

5-2 Setting operation

■ Setting the measurement conditions

● How to enter the measurement conditions setting screen

Select "MAIN-COND" -> "OBJECT TYPE COND" (menu tree)-> "TYPE00" -> "MEA-CND (CAMERA1)" -> "MEAS(NEW)," in that order. Then press the SET key to bring up the "MEAS1" screen.

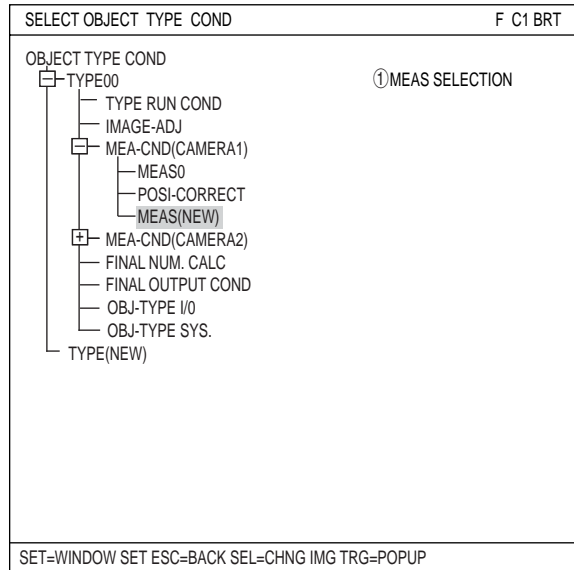

Move to the "①MEAS SELECTION" line on the "MEASUREMENT1" screen and select "CHK-DEG-MATCH" from the popup menu.

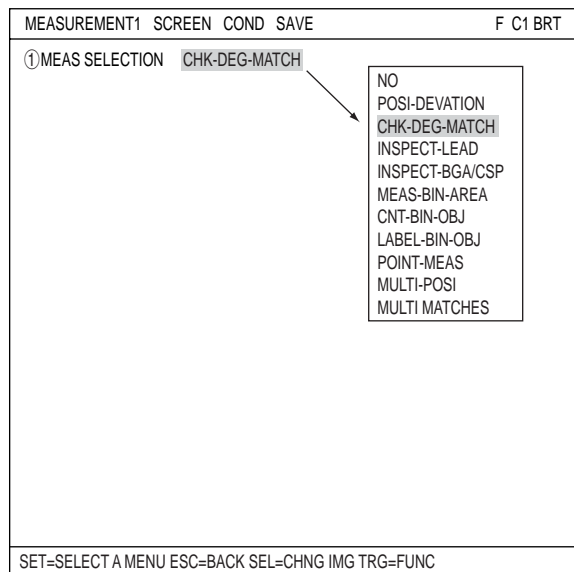

Press the ESC key to return to the OBJECT TYPE COND (menu tree) screen, and select the "MEAS CND" item shown under "MEAS01 (CHK-DEG-MATCH)" to go to the MEAS CND screen.

⇒ For details, see "Chapter 8: Setting Examples Using the Menu Tree" in the Introduction and Hardware.

● **Setting the measurement conditions**

① **DTECT PRECISION**
 Select detection precision. You can select one of two levels (standard/high), according to your conditions, the desired precision level for detection results, and the detection speed.
 ⇨ For details, see page 3-10.

② **REGISTER NO.**
 16 registers are available for the degree of match inspection (Registers 0 to 15). If you want to set the measurement conditions for a different register number, press the SET key to highlight the register number currently selected. Then press the up and down arrow keys to select the register number whose measurement conditions you want to set. Press the SET key to confirm your selection.

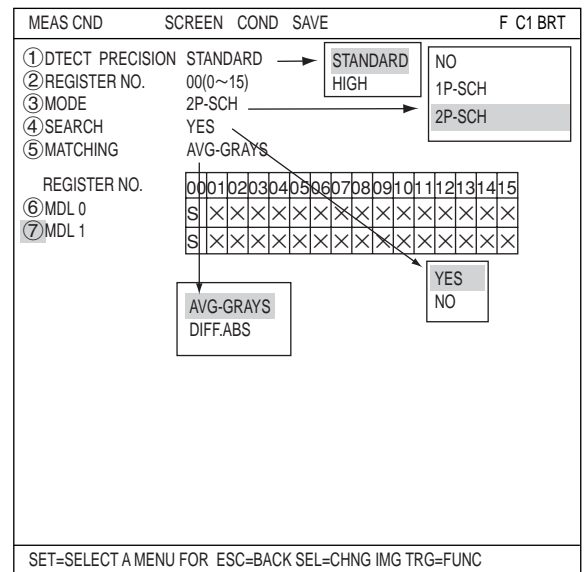

③ **MODE**
 Select a detection mode. Detail of each mode are as follows.

MODE	Details
NO (None)	Does not detect.
1P-SCH (1-point search)	Detect the positional deviation of one point in the scanned image compared to a single reference image, after performing a gray search.
2P-SCH (2-point search)	Detect the positional deviation of two points in the scanned image compared to two reference images, after performing a gray search.

Gray search ⇨ See page 3-10.

④ **SEARCH**
 Specify whether or not to use the search function.

⑤ **MATCHING**
 Select a density for comparison when inspecting the image. The details are as follows.

	Description
Average light level	Obtain average light level of the image in the area detected using the gray search.
Difference absolute value	Calculate the difference of the absolute values from the image detected using the gray search and the reference image. The result is light level difference. By obtaining this value, you can get an idea of the total change in light level. Total light level difference = S (Ni — Nt) Ni : Light level of the captured image (contraction 3) Nt : Light level of the reference image (contraction 3)

REGISTER NO. (⑥MDL 0, ⑦MDL 1)

The specified modes are displayed for each register number on these lines. When a 1-point search is specified, only "⑥MDL 0" will be available. When a 2-point search is specified, "⑦MDL 1" is also available. The "S" in the table indicates a gray search. "X" means not used.

● **An example of mode selection**

REGISTER NO.	00	01	02	03	04	05	06	07	08	09	10	11	12	13	14	15
⑥MDL0	S	S	X	X	X	X	X	X	X	X	X	X	X	X	X	X
⑦MDL1	X	S	X	X	X	X	X	X	X	X	X	X	X	X	X	X

S : Gray search
 X : No setting

↑ REGISTER00 : 1P-SCH
 ↑ REGISTER01 : 2P-SCH

■ How to set the register conditions

● How to enter the REG-COND setting screen

There are three methods for getting to the REG-COND setting screen.

- 1) On the "MEAS CND" setting screen, move the cursor to "⑥MDL 0" or "⑦MDL 1" and press the SET key. The cursor will move into the table. Move the cursor to the "S" column and press the SET key.

Note: If you press the SET key in the "X" column, the setting will be invalid.

MEAS CND	SCREEN	COND	SAVE	F C1 BRT
① DTECT PRECISION	STANDARD			IMG PRE-PROC
② REGISTER NO.	00(0-15)			REG-COND
③ MODE	2P-SCH			EVALUATION
④ SEARCH	YES			DST&ANGL
⑤ MATCHING	AVG-GRAYS			NUM-CALC
				OUT
REGISTER NO.				
⑥ MDL 0	00010203040506070809101112131415			
⑦ MDL 1	S X X X X X X X X X X X X X X X X			
	S X X X X X X X X X X X X X X X			

- 2) On the "MEAS CND" setting screen, press the TRG/BRT key to move the cursor to the upper function menu. Select the "COND" item and then select the "REG-COND" item and press the SET key.

- 3) On the menu tree, move the cursor to the "MEAS CND" item, and press the right arrow key. The sub menu which contains the "REG-COND" items will appear. Move the cursor to this item and press the SET key.

SELECT OBJECT TYPE COND	F C1 DRK
OBJECT TYPE COND	
TYPE00	① REGISTER NO.
TYPE01	② MEAS SHAPE (MDL0)
TYPE RUN COND	③ REFIMG ARE (MDL0)
IMAGE-ADJ	④ SEARCH ARE (MDL0)
MEAS-CND(CAMERA1)	⑤ REFIMG (MDL0)
MEAS0	⑥ DTECT CRD (MDL0)
POSI-CORRECT	⑦ CONTR.PIXL (MDL0)
MEAS01(CHK-DEG-MATCH)	⑧ MEAS SHAPE (MDL1)
IMG PRE-PROC	⑨ REFIMG ARE (MDL1)
MEAS CND	⑩ SEARCH ARE (MDL1)
REG-COND	⑪ REFIMG (MDL1)
EVALUATION COND	⑫ DTECT CRD (MDL1)
DISTANCE&ANGLE COND	⑬ CONTR.PIXL (MDL1)
NUM-CALC	
OUT-COND	
MEAS(NEW)	
MEAS-CND(CAMERA2)	
FINAL NUM. CALC	
FINAL OUTPUT COND	
OBJ-TYPE I/O	

SET=TO NEXT SUB-MENU ESC=BACK SEL=CHNG IMG TRG=POPU

● How to set register conditions

① REGISTER NO.

The currently selected register number is displayed. If you want to set the measurement conditions for a different register number, press the SET key to highlight the register number currently selected. Then press the up and down arrow keys to select the register number whose measurement conditions you want to set. Press the SET key to confirm your selection.

② MEAS SHAPE(MDL0)

Select a shape (rectangle, horizontal line, or vertical line) for the reference image area and search area.

⇒ For details about each shape, see pages 3-5 to 3-9.

REG COND	SCREEN	COND	SAVE	DETAIL	F C1 BRT
① REGISTER NO.	0(0~7)			RECTANGLE	
② MEAS SHAPE (MDL0)	RECTANGLE			X-LINE	
③ REFIMG ARE (MDL0)	SET (224.208)~(287.271)			Y-LINE	
④ SEARCH ARE (MDL0)	SET (216.200)~(295.279)			REFERENCE IMG *	
⑤ REFIMG (MDL0)	001 (000-001)			DTECT COORD	
⑥ DTECT CRD (MDL0)	CENTER (250.229)			CONTR.PIXEL	
⑦ CONTR.PIXL (MDL0)	1				
⑧ MEAS SHAPE (MDL1)	RECTANGLE				
⑨ REFIMG ARE (MDL1)	SET (224.208)~(287.271)				
⑩ SEARCH ARE (MDL1)	SET (216.200)~(295.279)				
⑪ REFIMG (MDL1)	001 (000-001)				
⑫ DTECT CRD (MDL1)	CENTER (250.229)				
⑬ CONTR.PIXL (MDL1)	1				

* Make to on the popup menu, the respective item will be added to the "REG COND" menu.

SEL=SELECT A MENU ESC=BACK SEL=CHNG IMG TRG=FUNC

③ REFIMG ARE (MDL0)

Move the cursor to "③REFIMG ARE(MDL0)" and press the SET key. When the SET item is highlighted, press the SET key again to bring up the setting screen.

● When a rectangle is selected

Specify the upper left and lower right corners of the reference image area.

● Setting screen (RECTANGLE)

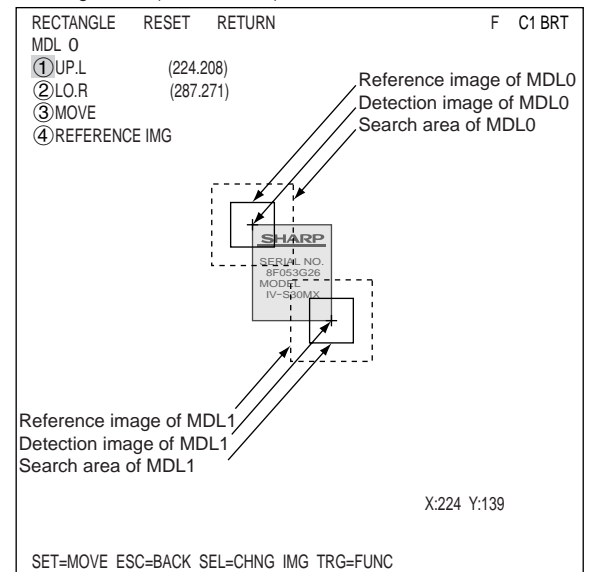

● When a horizontal line is selected

Specify the start and end points on the X axis. Specify the start and end points using the up/down/left/right arrow keys. The points will move along the X axis (while keeping the same Y coordinate).

● Setting screen (X-LINE)

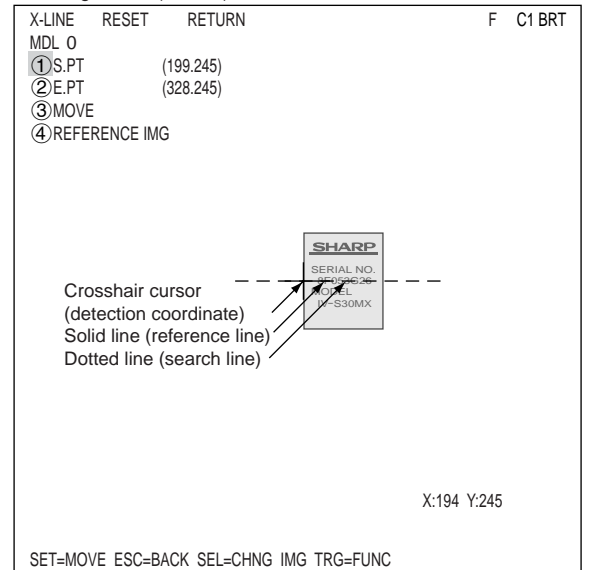

● **When a vertical line is selected**

Specify the start and end points on the Y axis. Specify the start and end points using the up/down/left/right arrow keys. The points will move along the Y axis (while keeping the same X coordinate).

● **Setting screen (Y-LINE)**

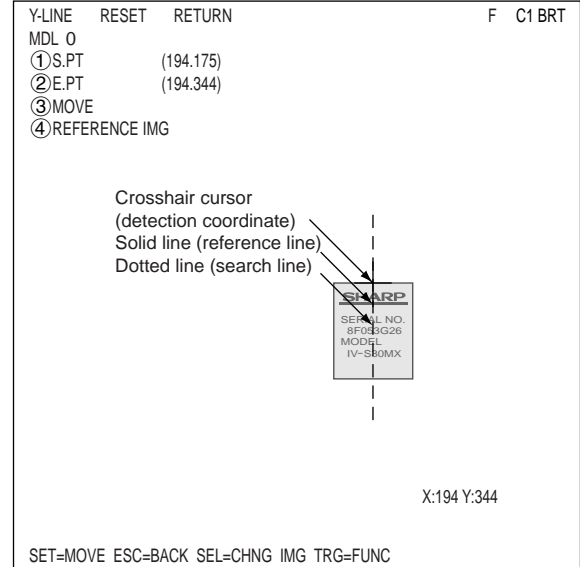

Register a reference image

After setting the reference image area, store an image in the controller as a reference image.

Select "④ REFERENCE IMG" using the up/down arrow keys and select "REG" from the popup menu.

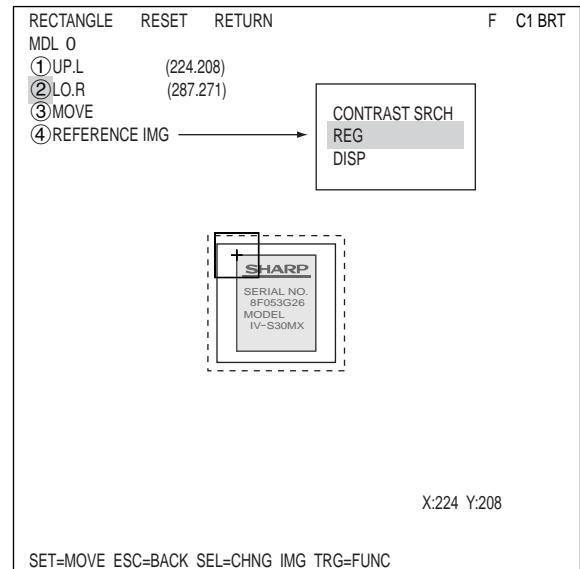

④ **SEARCH ARE**

Specify the search area (inside the dotted lines) on the "④ SEARCH ARE (MDL0)" line, using the same procedures used for setting the reference image area.

Note: Set the menu for MDL1. Setting procedures are the same as MDL0.

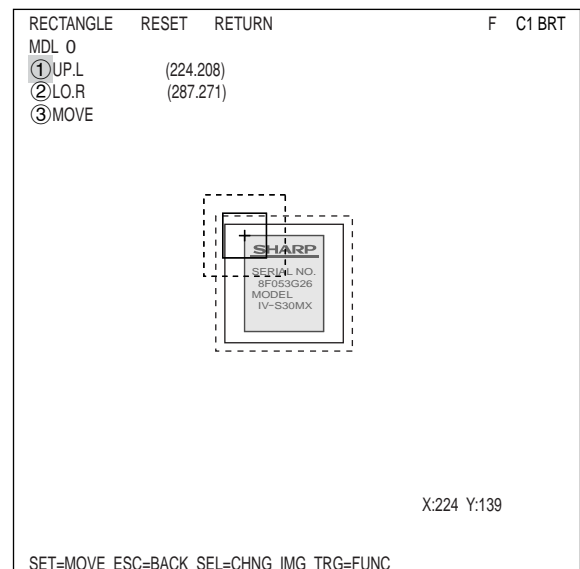

⑤ REFIMG

On the "⑤REF IMG (MDL0)" line, select a reference image from the reference images already registered.

Ex. 015 (000 to 026)

Select reference image No. 15 from the 26 registered reference images (000 to 026).

Note: This item is displayed only when the "REFERENCE IMG" is selected on the "DETAIL" in the upper function menu.

⇒ See page 5-4.

REG COND	SCREEN COND	SAVE DETAIL	F C1 BRT
① REGISTER NO.	00 (0~15)		
② MEAS SHAPE (MDL0)	RECTANGLE		
③ REFIMG ARE (MDL0)	SET (131.122)~(217.201)		
④ SEARCH ARE (MDL0)	SET (119.114~(224.214)		
⑤ REFIMG (MDL0)	15 (000-026)		
⑥ DTECT CRD (MDL0)	CENTER (176.164)		
⑦ CONTR.PIXL (MDL0)			
⑧ MEAS SHAPE (MDL1)	RECTANGLE		
⑨ REFIMG ARE (MDL1)	SET (224.208)~(372.349)		
⑩ SEARCH ARE (MDL1)	SET (276.259)~(381.368)		
⑪ REFIMG (MDL1)	003 (000-026)		
⑫ DTECT CRD (MDL1)	CENTER (334.313)		
⑬ CONTR.PIXL (MDL1)	3		

SEL=SELECT A MENU ESC=BACK SEL=CHNG IMG TRG=FUNC

⑥ DTECT CRD (detection coordinates)

Select whether to use the detection coordinates as the center of the reference area or to allow the point to be set freely.

Note: This item is displayed only when the "DTECT COORD" is selected on the "DETAIL" in the upper function menu.

⇒ See page 5-4.

REG COND	SCREEN COND	SAVE DETAIL	F C1 BRT
① REGISTER NO.	00 (0~15)		
② MEAS SHAPE (MDL0)	RECTANGLE		
③ REFIMG ARE (MDL0)	SET (131.122)~(217.201)		
④ SEARCH ARE (MDL0)	SET (119.114~(224.214)		
⑤ REFIMG (MDL0)	003 (000-026)		
⑥ DTECT CRD (MDL0)	CENTER (176.164)		
⑦ CONTR.PIXL (MDL0)			
⑧ MEAS SHAPE (MDL1)	RECTANGLE		
⑨ REFIMG ARE (MDL1)	SET (224.208)~(372.349)		
⑩ SEARCH ARE (MDL1)	SET (276.259)~(381.368)		
⑪ REFIMG (MDL1)	003 (000-026)		
⑫ DTECT CRD (MDL1)	CENTER (334.313)		
⑬ CONTR.PIXL (MDL1)	3		

SEL=SELECT A MENU ESC=BACK SEL=CHNG IMG TRG=FUNC

⑦ CONTR.PIXL

Select "CONTR.PIXL" (pixel contraction).

Note: This item is displayed only when the "CONTR.PIXEL" is selected on the "DETAIL" in the upper function menu.

⇒ See page 5-4.

⇒ For detail about the the "CONTR.PIXEL," see page 3-10.

REG COND	SCREEN COND	SAVE DETAIL	F C1 BRT
① REGISTER NO.	00 (0~15)		
② MEAS SHAPE (MDL0)	RECTANGLE		
③ REFIMG ARE (MDL0)	SET (131.122)~(217.201)		
④ SEARCH ARE (MDL0)	SET (119.114~(224.214)		
⑤ REFIMG (MDL0)	003 (000-026)		
⑥ DTECT CRD (MDL0)	CENTER (176.164)		
⑦ CONTR.PIXL (MDL0)	3		
⑧ MEAS SHAPE (MDL1)	RECTANGLE		
⑨ REFIMG ARE (MDL1)	SET (224.208)~(372.349)		
⑩ SEARCH ARE (MDL1)	SET (276.259)~(381.368)		
⑪ REFIMG (MDL1)	003 (000-026)		
⑫ DTECT CRD (MDL1)	CENTER (334.313)		
⑬ CONTR.PIXL (MDL1)	3		

SEL=SELECT A MENU ESC=BACK SEL=CHNG IMG TRG=FUNC

■ Numeric calculation setting

- Press the TRG/BRT key to move the cursor to the upper function menu, and highlight "COND" using the left and right arrow keys. Press the SET key to show the popup menu. Select "NUM-CALC" from the popup menu.
- Select "NUM-CALC" on the menu tree.
- ⇒ See "Chapter 15: Numeric calculation."

■ Output condition setting

- Press the TRG/BRT key to move the cursor to the upper function menu, and highlight "COND" using the left and right arrow keys. Press the SET key to display the popup menu. Select "OUT" from the popup menu.
- Select "OUT-COND" on the menu tree.
- ⇒ See "Chapter 17: Set the Input/Output Conditions."

■ Display the inspection results

Return to the operation screen and press the TRG/BRT key. The inspection results will be displayed on the screen.

■ When a 2 point search has been specified

The screenshot displays the following information:

- Final evaluation result:** OK
- Measuring time:** MEAS XXXXms 2001-10-14 10:30
- Measurement program number:** MEASUREMENT 1 CHK-DEG-MATCH
- Registration number:** REGISTER N00(0-15)
- Degree of match with the reference image for model 0:** M0=+09878 OK
- Detection coordinate for model 0:** X0= 288.0 OK, Y0= 190.0 OK
- Average gray level in the reference image for model 0*:** G0= 023.0 OK
- Degree of match with the reference image for model 1:** M1=+09306 OK
- Detection coordinate for model 1:** X1= 389.0 OK, Y1= 355.0 OK
- Average gray level in the reference image for model 1*:** G1= 023.0 OK

Additional screen details include: (TYPE00), F C1 DRK V** at the top right; X0~7, Y0~7, and READY indicators at the bottom; and a menu bar at the very bottom: MNU-CHG MAIN-COND CHG-MEA COND-CHG CHNG-REG SCREEN-CHG CHG-TYPE.

The image shows a SHARP device with two registration points, Model 0 and Model 1, marked on its surface. The device's serial number is 8F053G26 and its model is IV-SB01XX.

Chapter 6: Lead Inspection

6-1 Outline

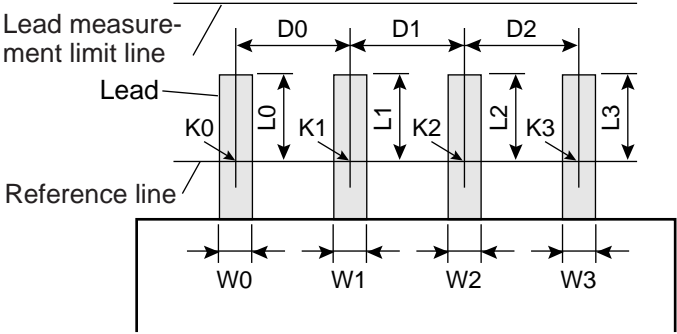
Purpose	Inspect the condition of IC leads and connector pins based on positional information obtained from the gray scale search function. (No. of leads or pins that can be detected: Max. 128 pieces)
Applications	Inspect IC leads or connector pins
Examples	<p>• Inspect the layout of the IC leads and connector pins</p>  <p>[Lead inspection]</p> <ul style="list-style-type: none"> - Number of leads K - D0 to D2: Distance between leads - W0 to W3: Lead width - L0 to L3: Lead length <p>• Inspection procedure</p> <ol style="list-style-type: none"> ① Determine the measurement points (K0 to K3) from the mid points of the leads and the reference line. ② Calculate the maximum and minimum distances between the leads (D0 to D2) on the reference line. ③ Calculate the maximum and minimum lead lengths (L0 to L3), starting from the measurement points (K0 to K3) and measuring toward the lead measurement limit line. ④ Calculate the maximum and minimum lead widths (W0 to W3) from the measurement points.

6-2 Setting operation

■ Setting the measurement conditions

● How to enter the measurement conditions setting screen

Select "MAIN-COND" -> "OBJECT TYPE COND" -> "TYPE00" -> "MEA-CND (CAMERA1)" -> "MEAS(NEW)," in that order. Then press the SET key to bring up the "MEAS1" screen.

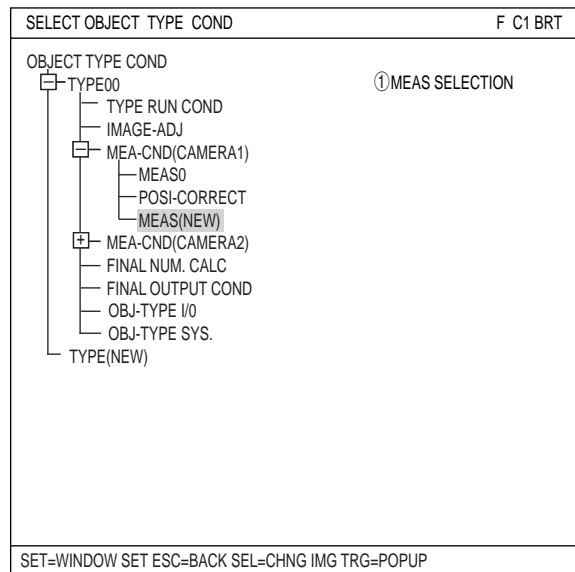

Move to the "①MEAS SELECTION" line on the "MEASUREMENT1" screen and select "INSPECT-LEAD" from the popup menu.

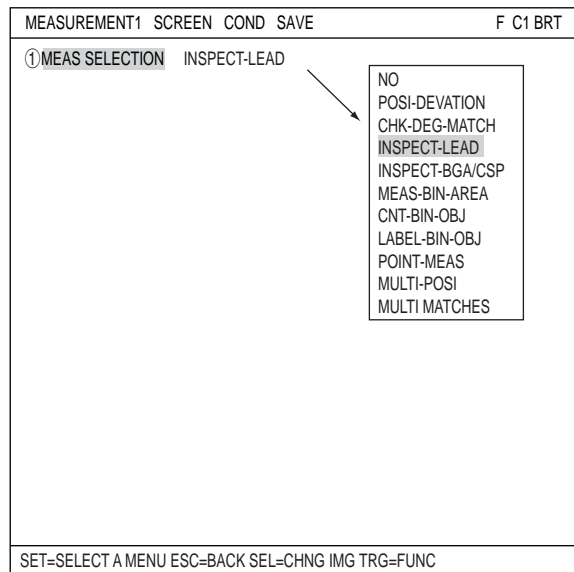

Press the ESC key to return to the "OBJECT TYPE COND" (menu tree) screen, and select the "MEAS CND" item shown under "MEAS01 (INSPECT-LEAD)" to go to the "MEAS CND" screen.

⇒ For details, see "Chapter 8: Setting Examples Using the Menu Tree" in Introduction and Hardware.

● **Setting the measurement conditions**

① **REGISTER NO.**

16 registers are available for the lead inspection (Registers 0 to 15). If you want to set the measurement conditions for a different register number, press the SET key to highlight the register number currently selected. Then press the up and down arrow keys to select the register number whose measurement conditions you want to set. Press the SET key to confirm your selection.

② **REGISTER EXIST**

Select whether to register or not.

③ **DTECT PRECISON**

Select detection precision. You can select one of two levels (standard/high), according to your conditions, the desired precision level for detection results, and the detection speed.
⇒ For details, see page 3-10.

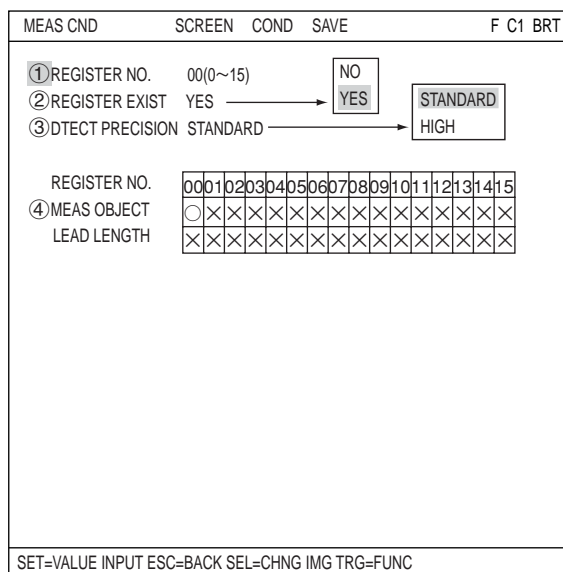

REGISTER NO. (④ MEAS OBJECT, LEAD LENGTH)

Register setting conditions are shown for each register number. Circles mean that "REGISTER NO." has set to "YES."

● **Setting (display) of items to be inspected**

REGISTER NO.	00	01	02	When item "② REGISTER EXIST" has set "YES," a circle is displayed. On the "REG COND" screen, when the "⑦ EXTENSION MEAS" is set to "LEAD-LENGTH," or "BALL-WIDTH," a circle is displayed. ⇒ See ⑦ and ⑧ on page 6-6.
④ MEAS OBJECT	○	○	×	
LEAD LENGTH	○	×	×	

X : No setting

■ **How to set the register conditions**

● **How to enter the REG-COND setting screen**

There are three methods for getting to the REG-COND setting screen.

- 1) On the MEAS CND setting screen, move the cursor to "④ MEAS OBJECT" and press the SET key. The cursor will move into the table. Move the cursor to the "○" column and press the SET key.
Note: If you press the SET key in the "X" column, the setting will be invalid.
- 2) On the "MEAS CND" setting screen, press the TRG/BRT key to move the cursor to the upper function menu. Select the "COND" item and then select the "REG-COND" item and press the SET key.

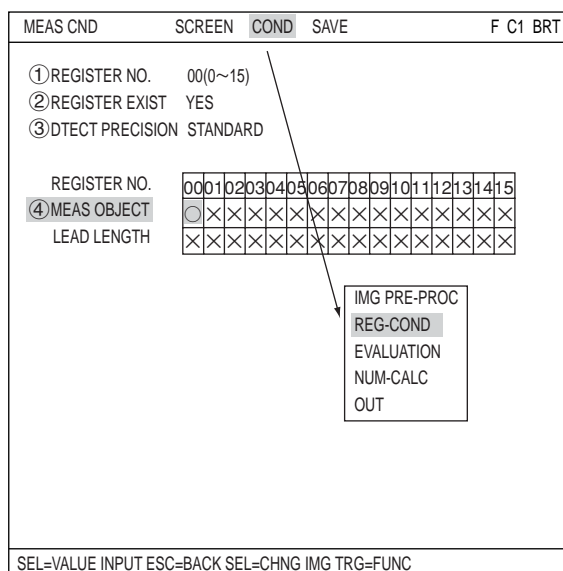

- On the menu tree, move the cursor to the "MEAS CND" item, and press the right arrow key. The sub menu which contains the "REG COND" item will appear. Move the cursor to either of these items and press the SET key.

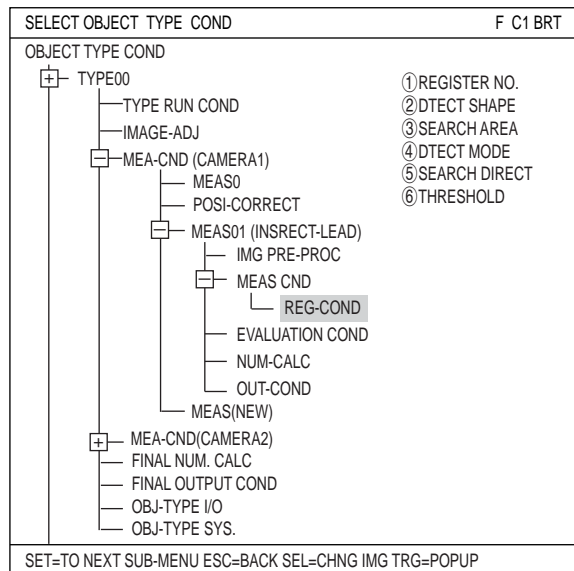

● Set the register conditions

① REGISTER NO.

The currently selected register number is displayed.

If you want to set the measurement conditions for a different register number, press the SET key to highlight the register number currently selected. Then press the up and down arrow keys to select the register number whose measurement conditions you want to set. Press the SET key to confirm your selection.

② DTECT SHAPE

Select a detection shape. Three shapes are available: "RECT(ARTIFACT)," "LINE," and "CIRC-L." Depending on which item is selected, the choices on lines "③SEARCH AREA" and "⑤SEARCH DIRECT" will change.

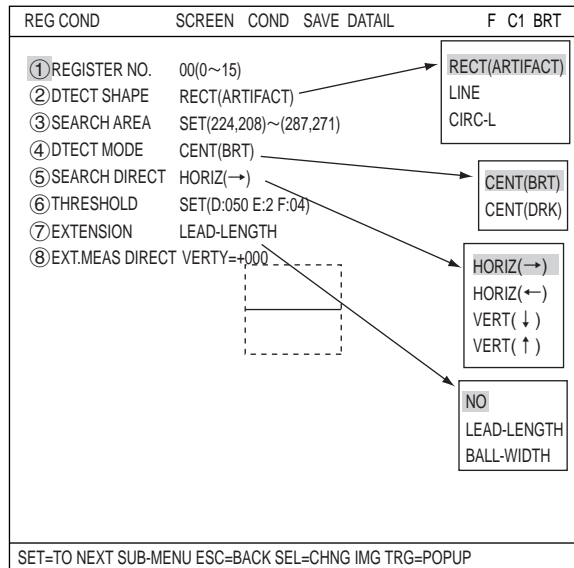

RECT (ARTIFACT)	Specify the coordinates of the upper left and lower right corners. The controller will detect an edge inside this rectangle. For details about processing artifacts, see page 3-16.
LINE	Specify the coordinates of the starting and end points. The controller will detect an edge along this straight line.
CIRC-L	Specify the coordinates of the center and radius. The controller will detect an edge inside this circle.

③ SEARCH AREA

Specify a search area. Move the cursor to this line and press the SET key. The currently SET item will be highlighted. Press the SET key again to enter the setting screen.

● When the "RECT (ARTIFACT)" is selected

Specify the upper left and lower right corners of the rectangular search area.

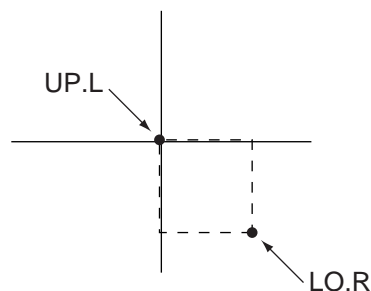

- **When the "LINE" is selected**
Specify the coordinates of the starting and end points.

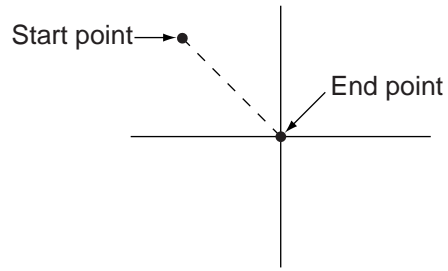

- **When the "CIRC-L" is selected**
Specify the coordinates of the center, radius, and starting point.

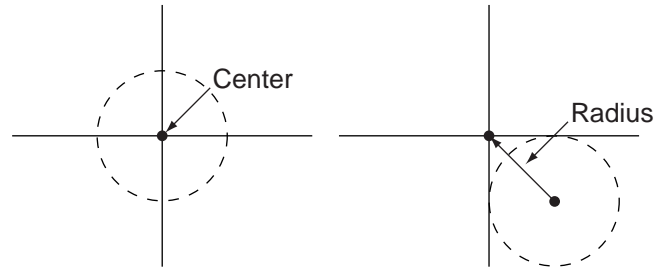

④ **DTECT MODE**

Select a detection mode.

CENT(DRK)	Detect the center of a dark area found by the detection search.
CENT(BRT)	Detect the center of a bright area found by the detection search.

Search direction

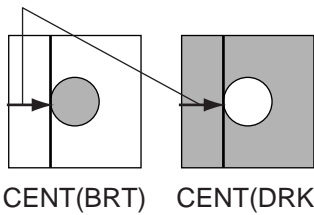

⑤ **SEARCH DIRECT (search direction)**

Specify a search direction. The direction for searching varies with each detection shape.

- **When "RECTANGLE" is selected**

Horizontal (→)	Scan along the reference line from left to right (→)
Horizontal (←)	Scan along the reference line from right to left (←)
Vertical (↓)	Scan along the reference line from top to bottom (↓)
Vertical (↑)	Scan along the reference line from bottom to top (↑)

- **When "LINE" is selected**

Start point → End point	Scan along a straight line from the starting point to the end point
End point → Start point	Scan along a straight line from the end point to the starting point

- **When "CIRC-L" or "ELIP-L" is selected**

Clockwise direction	Scan around the circumference clockwise
Counter-clockwise direction	Scan around the circumference counter-clockwise

■ Example of settings

- Example when ④ DTECT MODE (detection mode) is set to "CENT (BRT)" (center dark) and ⑤ SEARCH DIRECT (search direction) is set to "HORIZ (horizontal)."

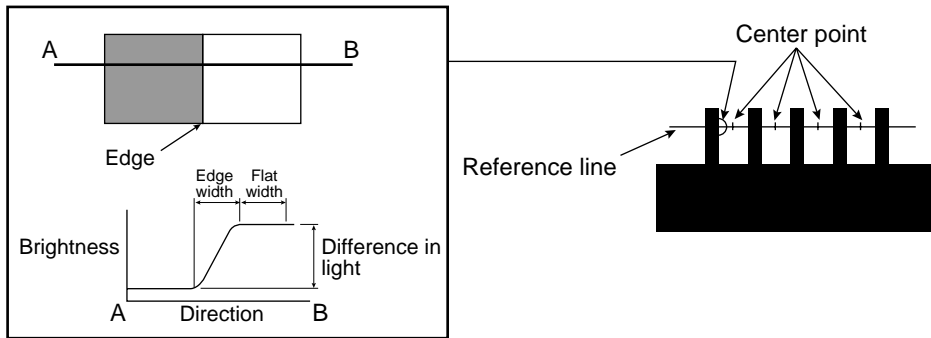

- Example when ④ DTECT MODE (detection mode) is set to "CENT (DRK)" (center dark) and ⑤ SEARCH DIRECT (search direction) is set to "HORIZ (horizontal)."

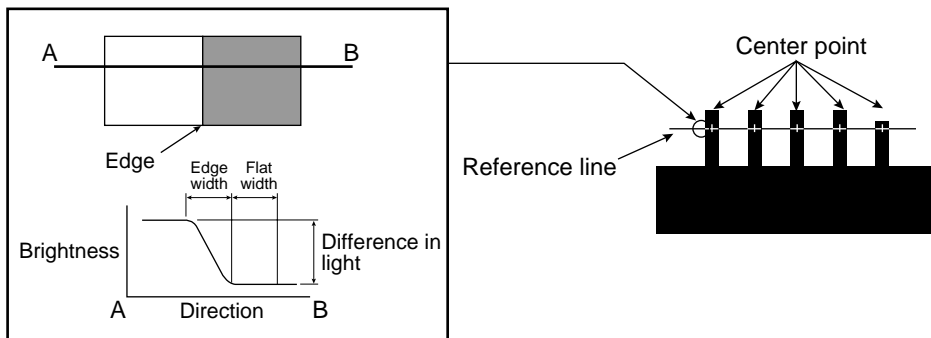

⑥ THRESHOLD

Specify a threshold value. Move the cursor to this line and press the SET key. The currently SET item will be highlighted. Press the SET key again to enter the setting screen.

Move to each of the following items and press the SET key: "①GRYS." (difference of gray level) "②EDGE.W" (edge width), and "③FLAT.W" (flat width). The current value for that item will be highlighted and it can be changed using the up and down keys. After the value is correct, press the ESC key to confirm it.

The values above can be reset to an appropriate level automatically. Move the cursor to the upper function menu by pressing the TRG/BRT key and select "AUTO-REG". Then press the SET key to set the levels automatically.

⇒ For details, see page 3-15.

⑦ EXTENSION MEAS, ⑧ EXT. MEAS DIRECT

Extension measurements can be made for "LEAD-LENGTH" or "BALL-WIDTH" in line "⑦ EXTENSION MEAS". Then, the "⑧EXT. MEAS DIRECT" item will appear. At the "⑧EXT. MEAS DIRECT" item, set the position for the extension measurement direction, relative to the reference line.

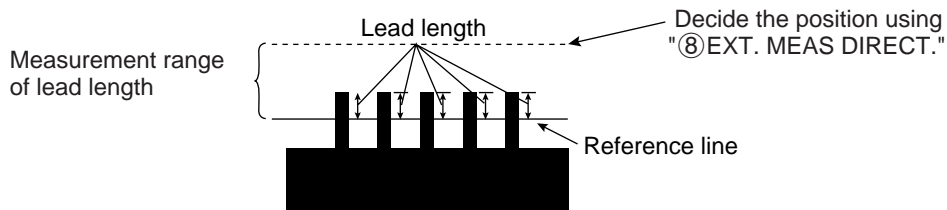

Note: This line is only displayed when "RECT" or "LINE" was selected for the "DTECT SHAPE." To display this line, move the cursor to the upper function menu and select "DETAIL." Press the SET key and select "EXTENSION MEAS" from the popup menu. Then press the SET key.

■ Set the evaluation conditions

● How to move to the evaluation condition setting screen

There are two methods for getting to the evaluation condition setting screen.

- 1) Select "COND" in the upper function menu on the "MEAS CND" (or "REG COND") screen and press the SET key. Select "EVALUATION" on the pop up menu to go to the "EVALUAT COND" screen.

MEAS CND	SCREEN	COND	SAVE	F C1 BRT												
① REGISTER NO.	00(0~15)															
② REGISTER EXIST	YES															
③ DTECT PRECISION	STANDARD															
REGISTER NO.	00	01	02	03	04	05	06	07	08	09	10	11	12	13	14	15
④ MEAS OBJECT	○	×	×	×	×	×	×	×	×	×	×	×	×	×	×	×
LEAD LENGTH	×	×	×	×	×	×	×	×	×	×	×	×	×	×	×	×

IMG PRE-PROC
 REG-COND
EVALUATION
 NUM-CALC
 OUT

SET=SELECT A MENU ESC=BACK SEL=CHNG IMG TRG=FUNC

- 2) Move the cursor to the "EVALUATION COND" item on the menu tree screen and press the SET key.

SELECT OBJECT TYPE COND	F C1 BRT
OBJECT TYPE COND	
<ul style="list-style-type: none"> TYPE00 <ul style="list-style-type: none"> TYPE RUN COND IMAGE-ADJ MEAS-CND (CAMERA1) <ul style="list-style-type: none"> MEAS0 POSI-CORRECT MEAS01 (INSRECT-LEAD) <ul style="list-style-type: none"> IMG PRE-PROC MEAS CND EVALUATION COND NUM-CALC OUT-COND MEAS(NEW) MEAS-CND(CAMERA2) <ul style="list-style-type: none"> FINAL NUM. CALC FINAL OUTPUT COND OBJ-TYPE I/O OBJ-TYPE SYS. TYPE(NEW) 	① REGISTER NO. ② CONDITION SET ③ NUMBER OF OBJ ④ DISTANCE ⑤ LEAD WIDTH ⑥ LEAD LENGTH ⑦ TEST
SET=TO NEXT SUB-MENU ESC=BACK SEL=CHNG IMG TRG=POPUP	

The "EVALUAT COND"(evaluation conditions) screen will appear.

⇒ For details about the evaluation conditions, see page 3-18.

EVALUAT COND	SCREEN	COND	SAVE	EDIT	SEL	F C1 BRT
① REGISTER NO.	00(0-15)	[TEST RESULT]	[OUTPUT]			
② CONDITION SET	AUTO(±10%)					
③ NUMBER OF OBJ	000-128	K=	NO			
④ DISTANCE	000.0-702.0	D=	NO			
⑤ LEAD WIDTH	000.0-702.0	W=	NO			
⑥ LEAD LENGTH	000.0-702.0	L=	NO			
⑦ TEST	EXEC(WITH-POSI.ADJ WITHOUT-POSI.ADJ)					

SET=VALUE INPUT ESC=BACK SEL=CHNG IMG TRG=FUNC

■ Numeric calculation setting

- Press the TRG/BRT key to move the cursor to the upper function menu, and highlight "COND" using the left and right arrow keys. Press the SET key to show the popup menu. Select "NUM-CALC" from the popup menu.
- Select "NUM-CALC" on the menu tree.
- ⇒ See "Chapter 15: Numeric calculation."

■ Output condition setting

- Press the TRG/BRT key to move the cursor to the upper function menu, and highlight "COND" using the left and right arrow keys. Press the SET key to display the popup menu. Select "OUT" from the popup menu.
- Select "OUT-COND" on the menu tree.
- ⇒ See "Chapter 17: Set the Input/Output Conditions."

■ Display the measurement results

Return to the operation screen and press the TRG/BRT key. The measurement results will be displayed on the screen.

■ Example when a straight line is selected as measurement shape

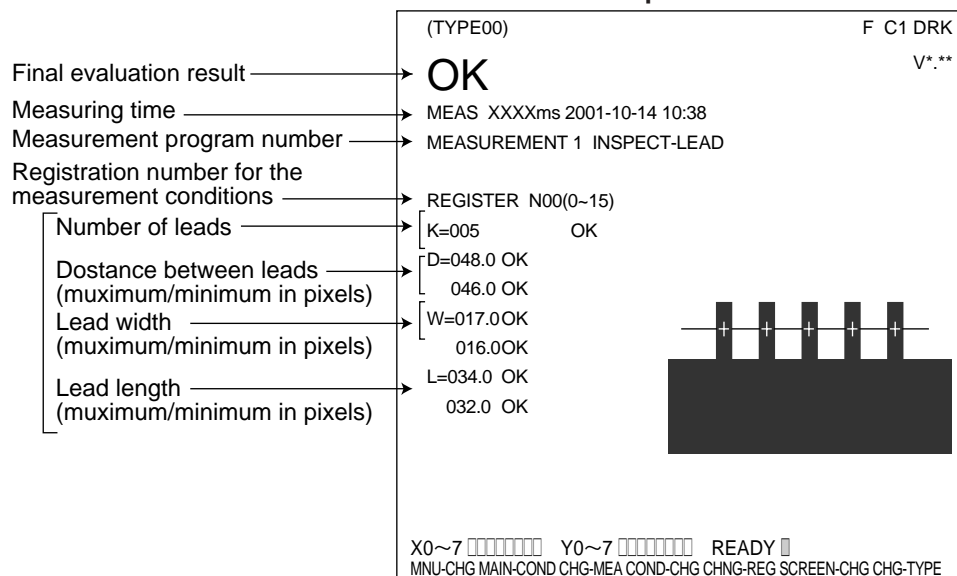

Chapter 7: BGA/CSP Inspection (IV-S32MX/S33MX)

The BGA/CSP inspection is available on the IV-S32MX/S33MX controllers.

7-1 Outline

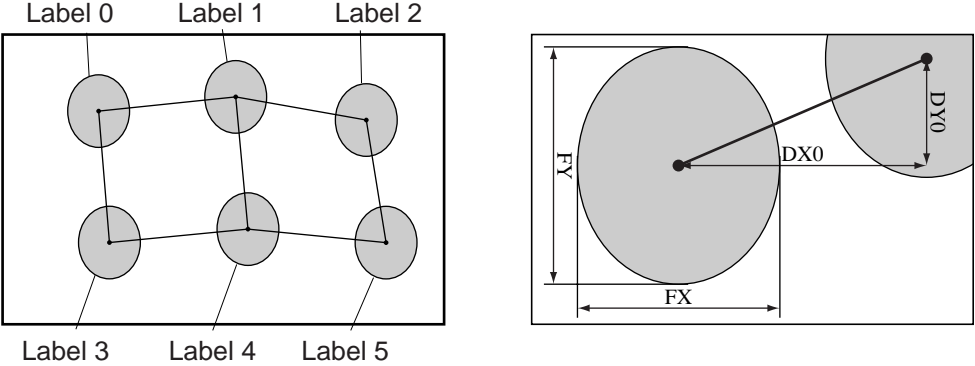
Purpose	The center of gravity, area of each label, number of labels and fillet diameter are measured using the binary label measurement function.
Applications	Inspection of BGA/CSP solder balls
Examples	<p>[Measurement of 6 balls]</p>  <p>[Measurement results]</p> <ul style="list-style-type: none"> - Number of objects: K - Area of each object: R0 to R127 - Distance between centers of gravity: (DX0, DY) to (DX127, DY127) - Fillet diameters: FX, FY <p>- Inspection sequence</p> <pre> graph LR A[Image capture] --> B[Binary conversion] B --> C[Labeling (numbering)] C --> D[Center of gravity measurement] C --> E[Fillet diameter] F[Area of each label] --> G[Ball size] H[Distance between label centers of gravity] --> I[Ball-to-ball distance] H --> J[Number of balls] </pre>

7-2 Setting operation

■ Setting the measurement conditions

● How to enter the measurement conditions setting screen

Select "MAIN-COND" -> "OBJECT TYPE COND" (menu tree)-> "TYPE00" ->"MEA CND (CAMERA1)" -> "MEAS(NEW)", in that order. Then press the SET key to bring up the "MEAS1" screen.

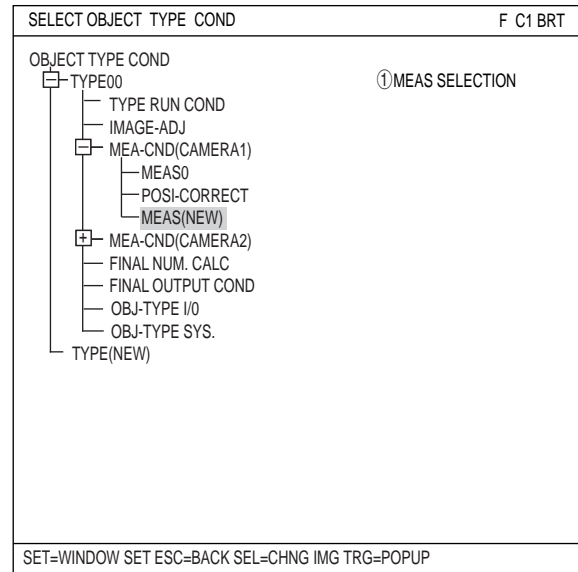

Move to the "①MEAS SELECTION" line on the "MEASUREMENT1" screen and select "INSPECT-BGA/CSP" from the popup menu.

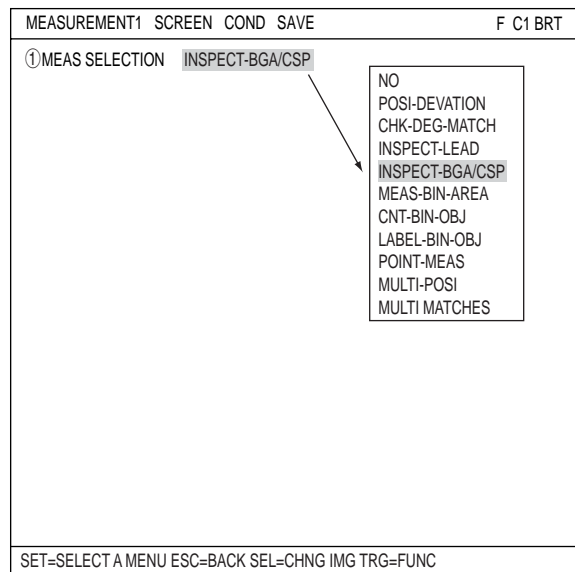

Press the ESC key to return to the "OBJECT TYPE COND" (menu tree) screen, and select the "MEAS CND" item shown under "MEAS01 (INSPECT-BGA/CSP)" to go to the "MEA-CND" screen.
 ⇨ For details, see "Chapter 8: Setting Examples Using the Menu Tree" in the Introduction and Hardware.

How to set the register conditions

How to enter the REG-COND setting screen

There are three methods for getting to the REG-COND setting screen.

- 1) On the "MEA-CND" setting screen, move the cursor to the "④ (or ⑤) BIN AREA COND" and press the SET key. The cursor will move into the table. Move the cursor to the "○" column and press the SET key.

Note: If you press the SET key in the "X" column, the setting will be invalid.

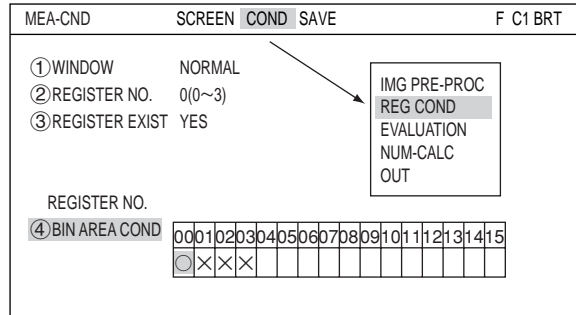

- 2) On the "MEA-CND" setting screen, press the TRG/BRT key to move the cursor to the upper function menu. Select the "COND" item and then select the "REG COND" item and press the SET key.

- 3) On the menu tree, move the cursor to the "MEAS CND" item, and press the right arrow key. The sub menu which contains the "REG COND" item will appear. Move the cursor to this item and press the SET key.

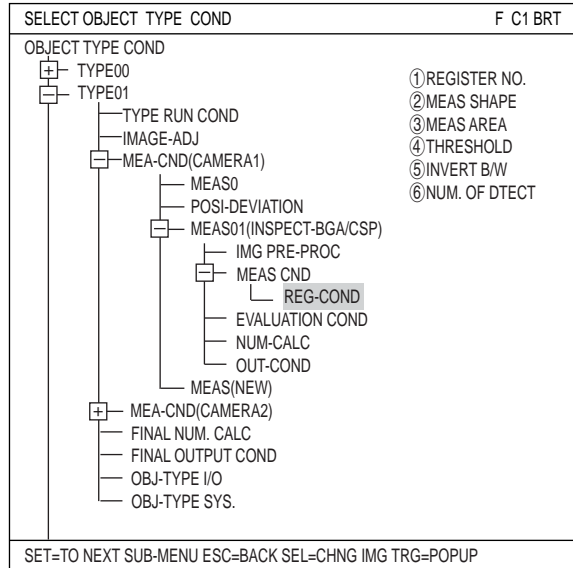

Set the register conditions

① REGISTER NO.

The currently selected register number is displayed.

If you want to set the measurement conditions for a different register number, press the SET key to highlight the register number currently selected. Then press the up and down arrow keys to select the register number whose measurement conditions you want to set. Press the SET key to confirm your selection.

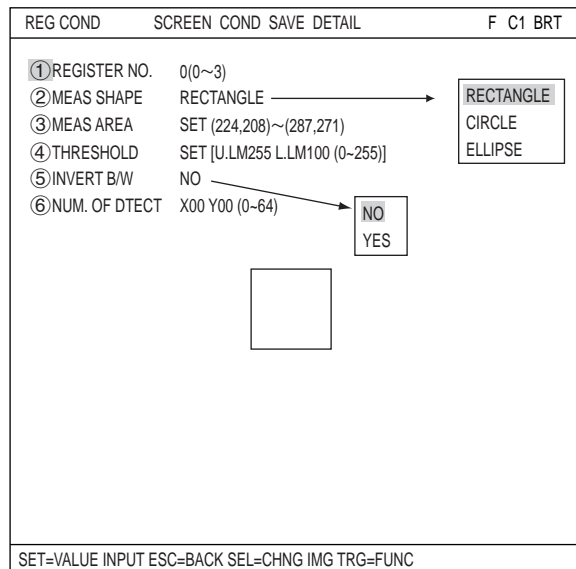

* When the "BINARY-IMG-MASK" or the "POLYGON" is selected at "①WINDOW" on the "MEA-CND" screen, the "①REGISTER NO." line will not be displayed and the other item numbers are decremented by one since the register number for "BINARY-IMG-MASK" and "POLYGON" is fixed.

REG COND	SCREEN COND	SAVE DETAIL	F C1 BRT
① MEAS SHAPE	RECTANGLE		
② MEAS AREA	SET (224,208)~(287,271)		
③ THRESHOLD	SET [U.LM255 L.LM100 (0~255)]		
④ INVERT B/W	NO		
⑤ NUM. OF DTECT	X00 Y00 (0~64)		

SET=VALUE INPUT ESC=BACK SEL=CHNG IMG TRG=FUNC

② MEAS SHAPE

Specify shape of measuring range.

RECTANGLE	Specify the coordinates for the upper left and lower right corners. The measurement area will be the area enclosed by this rectangle.
CIRCLE	Specify the center and the radius. The measurement area will be the area enclosed by this circle.
ELLIPSE	Specify the center and the radius. The measurement area will be the area enclosed by this ellipse.

③ MEAS AREA

Specify a search area.

● When "RECTANGLE" is selected

Specify the upper left and lower right corners of the rectangular search area.

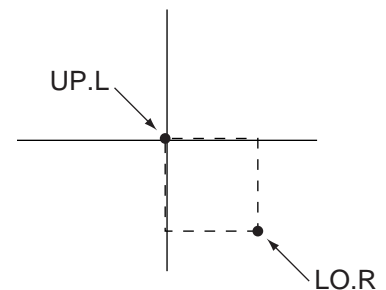

● When "CIRCLE" is selected

Specify the center and the radius.

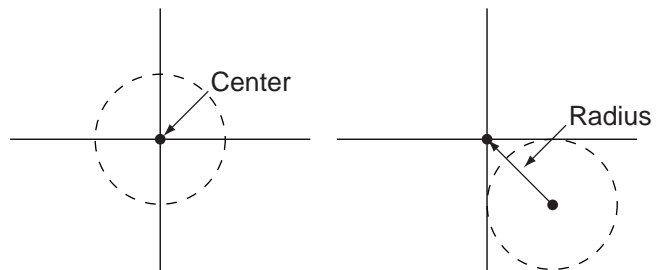

● When "ELLIPSE" is selected

Specify the center and the radius.

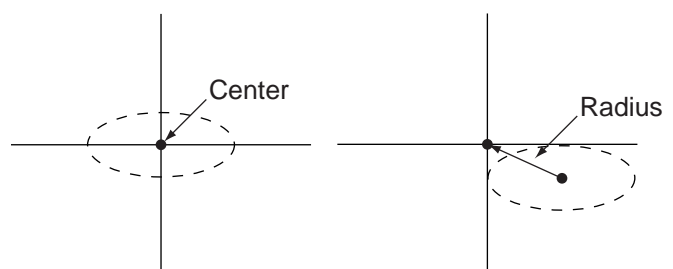

④ **THRESHOLD**

Specify a threshold value.

Move the cursor to "①U.LM" and press the SET key. Then move the cursor to "②L.LM" and press the SET key again. The current value will be highlighted for each item. You can increase or decrease the value by pressing the up and down arrow keys. Press the ESC key to confirm the value you want.

⇒ For details, see page 3-11.

⑤ **INVERT B/W**

Select whether to invert the display of black and white inside the measurement area.

⑥ **NUM. OF DTECT**

Specify the number of solder balls to detect using a matrix (lines x rows). (The balls shown on page 7-1 are arranged in a 3 x 2 matrix. Therefore, in this case specify X = 3 and Y = 2.)

Setting the mask details

On the "REG COND" screen, move the cursor to the upper function menu by pressing the TRG/BRT key. Select "DETAIL" by pressing the left and right arrow keys and then press the SET key. On the popup menu, you can select "MASK REGIST.," "BINARY PROCESS," "BINARY NOISE FILT," "BOUNDARY PROCESS," and "AREA FILTER." The items selected here will be displayed on the "REG COND" menu.

⑦ **MASK NO.**

Select a mask number.

* This is available when "NORMAL" is selected on the "①WINDOW" line.

REG COND	SCREEN COND	SAVE	DETAIL	F	C1	BRT
① REGISTER NO.	0(0~3)					
② MEAS SHAPE	RECTANGLE					
③ MEAS AREA	SET (224,208)~(287,271)					
④ THRESHOLD	SET [U.LM255 L.LM100 (0~255)]					
⑤ INVERT B/W	NO					
⑥ NUM. OF DTECT	X00 Y00 (0~64)					
⑦ MASK NO.	0(0~3)					
⑧ MASK SHAPE	NO					
⑨ BINRY PROCESS	FIXED					
⑩ BINARY NOISE FILT	NO					
⑪ BOUNDARY PROCESS	VALID					
⑫ AREA FILTER	U.LM245760 L.LM000000(0~245760)					

⑦ MASK NO. options: NO, RECTANGLE, CIRCLE, ELLIPSE

⑧ MASK SHAPE options: NO, RECTANGLE, CIRCLE, ELLIPSE

⑨ BINRY PROCESS options: FIXED, NO

⑩ BINARY NOISE FILT options: NO, EXPD.-->CONTR., CONTR.-->EXPD.

⑪ BOUNDARY PROCESS options: VALID, INVALID

⑫ AREA FILTER options: NO, THRES-ADJ (VAR-DIFF), THRES-ADJ (VAR-RATE)

SET=VALUE INPUT ESC=BACK SEL=CHNG IMG TRG=FUNC

⑧ **MASK SHAPE**

Select mask shape.

- Select "NO," "RECTANGLE," "CIRCLE," or "ELLIPSE."
- When "BINARY-IMG-MASK" is selected on the "①WINDOW" line, this line will not appear, since this is already selected on the "MASK BINARY IMG" screen.
- When "POLYGON" is selected on the "①WINDOW" line, specify the polygonal shape of the mask.

⑨ **BINARY PROCESS**

Select a binary processing method. Move the cursor to "FIXED," "THRES-ADJ (VAR-DIFF)" {adjustable threshold value (variation difference)}, or "THRES-ADJ (VAR-RATE)" {adjustable threshold (variation rate)}, and press the SET key to continue.

⇒ For details, see page 3-13.

⑩ **BINARY NOISE FILTER**

Select a binary noise filter type. Move the cursor to "NO," "EXPD. → CONTR." (expansion → contraction), or "CONTR. → EXPD" (contraction → expansion), and press the SET key to continue.

⇒ For details, see page 3-14.

7

⑪ **BOUNDARY PROCESS**

Select whether objects crossing the boundary of the window will be "VALID" or "INVALID."
 ⇨ For details, see page 3-12.

⑫ **AREA FILTER**

This function is used to exclude an object from measurement if its area is outside of the upper or lower limits. Specify a number from 0 to 245760.

■ **Example of register measurement are and area mask**

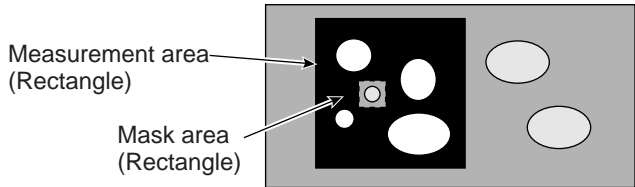

- The inside of the measurement area (excluding the mask area) is converted to binary data.

■ **Set the evaluation conditions**

● **How to move to the evaluation condition setting screen**

There are two methods for getting to the evaluation condition setting screen.

- 1) Select "COND" in the upper function menu on the "MEA-CND" (or "REG COND") screen and press the SET key. Select "EVALUATION" on the pop up menu to go to the "EVALUAT COND" screen.

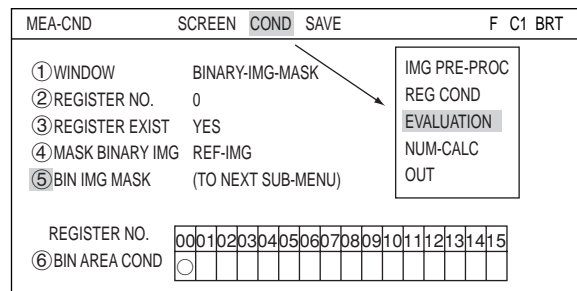

- 2) Move the cursor to the "EVALUATION COND" item on the menu tree screen and press the SET key.

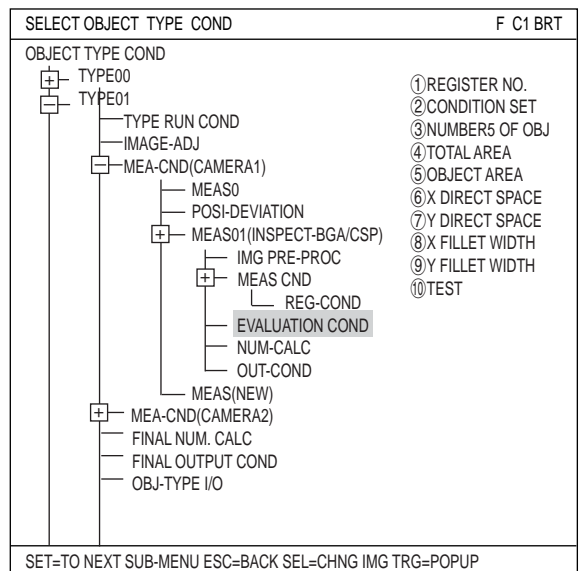

The "EVALUAT COND"(evaluation conditions) screen will appear.
 ⇨ For details about the evaluation conditions, see page 3-18.

EVALUAT COND	SCREEN	COND	SAVE	EDIT	SEL	F	C1	BRT
① REGISTER NO.		0(0-3)			[TEST RESULT]			[OUTPUT]
② CONDITION SET		AUTO(±10%)						
③ NUMBER OF OBJ		000-128			K=			NO
④ TOTAL AREA		000000-245760			A=			NO
⑤ OBJECT AREA		000000-245760			R=			NO
⑥ X DIRECT SPACE		000.0-511.0			DX=			NO
⑦ Y DIRECT SPACE		000.0-479.0			DY=			NO
⑧ X FILLET WIDTH		000-511			FX=			NO
⑨ Y FILLET WIDTH		000-479			FY=			NO
⑩ TEST					EXEC(WITH-POSI.ADJ WITHOUT-POSI.ADJ)			

SET=VALUE INPUT ESC=BACK SEL=CHNG IMG TRG=FUNC

7

Numeric calculation setting

- Press the TRG/BRT key to move the cursor to the upper function menu, and highlight "COND" using the left and right arrow keys. Press the SET key to show the popup menu. Select "NUM-CALC" from the popup menu.
- Select "NUM-CALC" on the menu tree.
- ⇨ See "Chapter 15: Numeric calculation."

Output condition setting

- Press the TRG/BRT key to move the cursor to the upper function menu, and highlight "COND" using the left and right arrow keys. Press the SET key to display the popup menu. Select "OUT" from the popup menu.
- Select "OUT-COND" on the menu tree.
- ⇨ See "Chapter 17: Set the Input/Output Conditions."

Display the inspection results

Return to the operation screen and press the TRG/BRT key. The inspection results will be displayed on the screen.

[Display of the inspection results]

Annotations on the left side of the screenshot:

- Final evaluation result → OK
- Measuring time → MEAS XXXXms 2001-10-14 10:38
- Measurement program number → MEASUREMENT 1 INSPECT BGA/CSP
- Registration number of measurement condition → REGISTER N00(0-15)
- NUMBER OF OBJ → K=006 OK
- TOTAL-AREA → A=008492 OK
- OBJECT-AREA → R=001450 OK
- (Max./Min. : Number of pixels) → 001383 OK
- X DIRECT SPACE → DX=138.2 OK
- (Max./Min. : Number of pixels) → 136.4 OK
- Y DIRECT SPACE → DY=409.6 OK
- (Max./Min. : Number of pixels) → 407.8 OK
- X FILLET WIDTH → FX=031 OK
- (Max./Min. : Number of pixels) → 030 OK
- Y FILLET WIDTH → FY=031 OK
- (Max./Min. : Number of pixels) → 030 OK

Bottom status bar: X0~7 [] Y0~7 [] READY []

Bottom menu: MNU-CHG MAIN-COND CHG-MEA COND-CHG CHNG-REG SCREEN-CHG CHG-TYPE

Chapter 8: Area Measurement by Binary Conversion

8-1 Outline

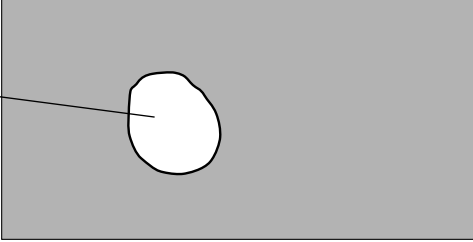
<p>Purpose</p>	<p>This function is used to determine the existence and or size of a workpiece when the workpiece is always found in the same place or when it has a fixed measurement position. - This function measures the area of the white field after the image has been converted to binary values (i.e. black and white).</p>
<p>Applications</p>	<p>Checking for correctly inserted ball bearings, preventing foreign objects from becoming mixed in with parts being processed, distinguishing between different types of waterproof lids, checking the existence of labels on packages, checking the printing on electric cables, checking for adequate coatings of grease and checking the existence of frozen foods.</p>
<p>Examples</p>	<div style="display: flex; align-items: center;"> <div style="margin-right: 20px;"> <p>Workpiece</p>  </div> <div style="margin-left: 20px;"> <p>[Measurement result] - The area of the workpiece</p> </div> </div> <p>- Checking sequence</p> <pre> graph LR A[Capture an image] --> B[Convert it to binary] B --> C[Measure (area)] </pre>

8-2 Setting operation

■ Setting the measurement conditions

● How to enter the measurement conditions setting screen

Select "MAIN-COND" -> "OBJECT TYPE COND" (menu tree)-> "TYPE00" -> "MEA-CND (CAMERA1)" -> "MEAS(NEW)," in that order. Then press the SET key to bring up the "MEAS1" screen.

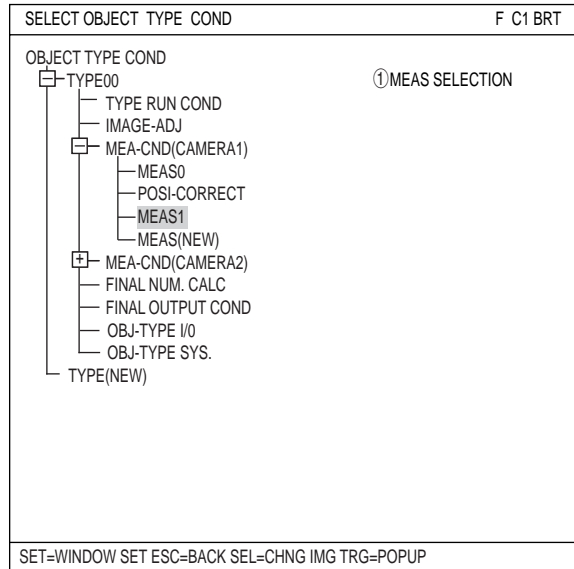

Move to the "①MEAS SELECTION" line on the "MEASUREMENT1" screen and select "MEAS-BIN-AREA" from the popup menu.

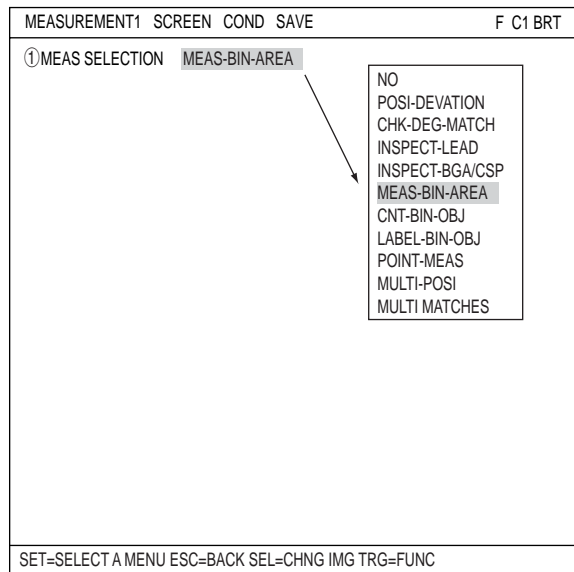

Press the ESC key to return to the OBJECT TYPE COND (menu tree) screen, and select the "MEAS CND" item shown under "MEAS01(MEAS-BIN-AREA)" to go to the MEA-CND screen.

⇒ For details, see "Chapter 8: Setting Examples Using the Menu Tree" in the Introduction and Hardware.

- ① **WINDOW**
 Select a window type. On the popup menu, move the cursor any of "NUM-OF-MASK1,2,4," "BINARY-IMG-MASK," or "POLYGON," and press the SET key to select the item.

MEA-CND	SCREEN COND	SAVE	F C1 BRT
① WINDOW	NUM-OF-MASK 1	→	NUM-OF-MASK 1
② REGISTER NO.	00(0~15)		NUM-OF-MASK 2
③ REGISTER EXIST	NO		NUM-OF-MASK 4
			BINARY-IMG-MASK
			POLYGON
REGISTER NO.	00010203040506070809101112131415		
④ BIN AREA COND	○ × × × × × × × × × × × × × × × ×		
SET=SELECT A MENU ESC=BACK SEL=CHNG IMG TRG=FUNC			

NUM-OF-MASK 1	Bring one mask area inside the measuring area.
NUM-OF-MASK 2	Bring two mask areas inside the measuring area.
NUM-OF-MASK 4	Bring four mask areas inside the measuring area.
BINARY-IMG-MASK	Select this item if the captured image is other than a rectangle, circle, or ellipse. This function masks the captured image using a stored binary image. ⇒ For details, see pages 3-26 to 30.
POLYGON	You can manually create any freeform polygon for the measurement area.

8

- ② **REGISTER NO.**
 Select register number to measure. Number of selectable registers varies with window shape selected.

NUM-OF-MASK 1	0 to 15
NUM-OF-MASK 2	0 to 7
NUM-OF-MASK 4	0 to 4
BINARY-IMG-MASK	0 only
POLYGON	0 only

To save the measurement conditions using a different register number, press the SET key and highlight the number. Change this number by pressing the up and down arrow keys.

- ③ **REGISTER EXIST**
 Select whether to register or not.

REGISTER NO. (④ BIN AREA COND)

Register setting conditions are shown for each register number. Circles mean that "REGISTER EXIST" has set to "YES."

● **Setting (display) of binary area conditions**

REGISTER NO.	00	01	02	03	
④ BIN AREA COND	○	×	×		----- When item "③ REGISTER EXIST" is set to "YES," a circle is displayed.
	×				× : No setting

■ How to set the register conditions

● How to enter the REG-COND setting screen

There are three methods for getting to the REG-COND setting screen.

- 1) On the "MEA-CND" setting screen, move the cursor to the "④BIN AREA COND" and press the SET key. The cursor will move into the table. Move the cursor to the "○" column and press the SET key.

Note: If you press the SET key in the "X" column, the setting will be invalid.

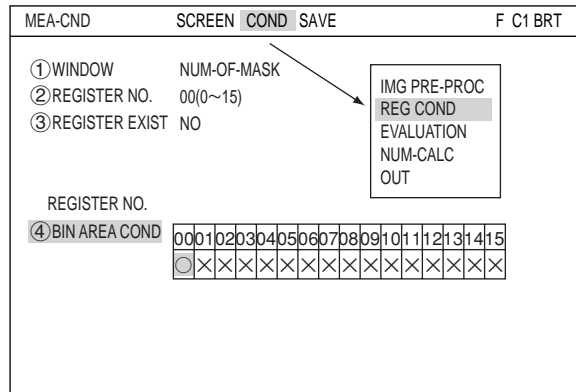

- 2) On the "MEA-CND" setting screen, press the TRG/BRT key to move the cursor to the upper function menu. Select the "COND" item and then select the "REG COND" item and press the SET key.

- 3) On the menu tree, move the cursor to the "MEAS CND" item, and press the right arrow key. The sub menu which contains the "REG COND" item will appear. Move the cursor to this item and press the SET key.

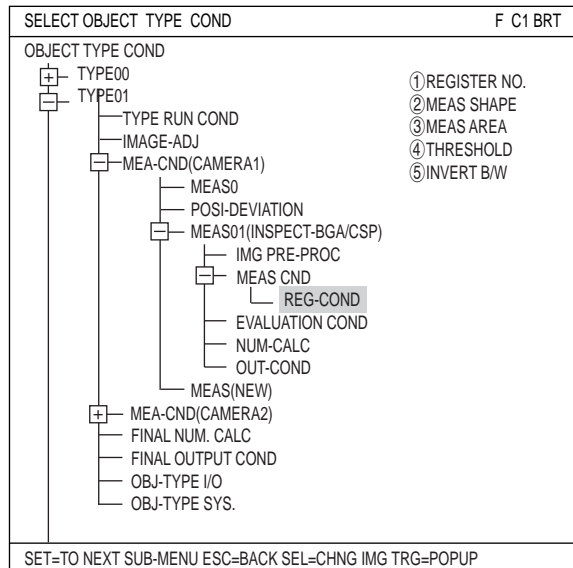

● Set the register conditions

① REGISTER NO.

The currently selected register number is displayed.

If you want to set the measurement conditions for a different register number, press the SET key to highlight the register number currently selected. Then press the up and down arrow keys to select the register number whose measurement conditions you want to set. Press the SET key to confirm your selection.

Note: When the "BINARY-IMG-MASK" or the "POLYGON" is selected at "①WINDOW" on the "MEA-CND" screen, the "①REGISTER NO." line will not be displayed and the other item numbers are decremented by one since the register number for "BINARY-IMG-MASK" and "POLYGON" is fixed.

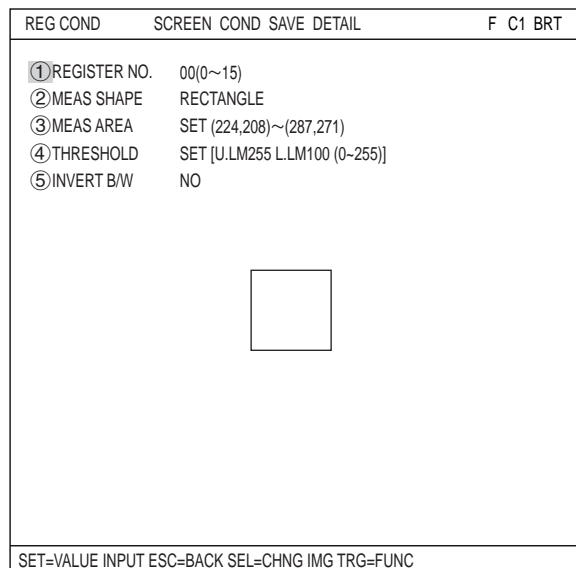

② MEAS SHAPE

Specify shape of measuring range.

RECTANGLE	Specify the coordinates for the upper left and lower right corners. The measurement area will be the area enclosed by this rectangle.
CIRCLE	Specify the center and the radius. The measurement area will be the area enclosed by this circle.
ELLIPSE	Specify the center and the radius. The measurement area will be the area enclosed by this ellipse.

③ MEAS AREA

Specify a search area.

● When "RECTANGLE" is selected

Specify the upper left and lower right corners of the rectangular search area.

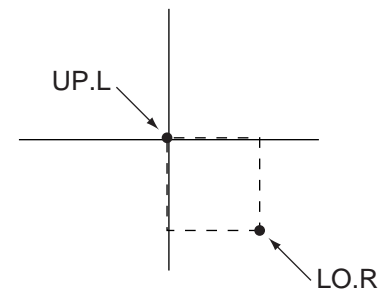

● When "CIRCLE" is selected

Specify the center and the radius.

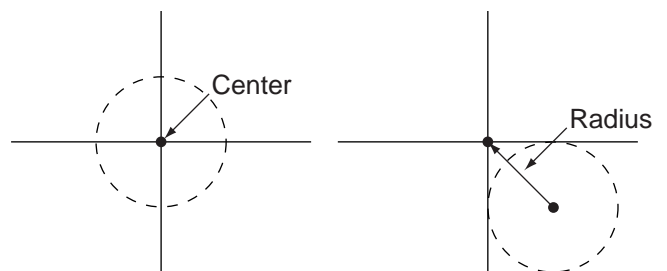

● When "ELLIPSE" is selected

Specify the center and the radius.

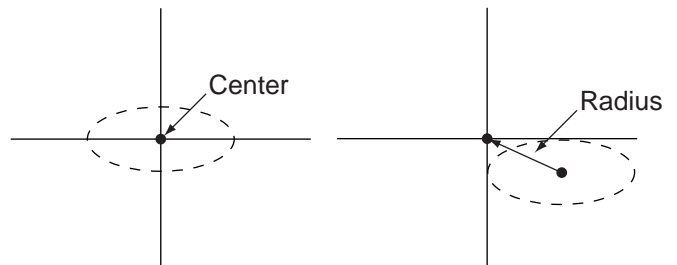

④ THRESHOLD

Specify a threshold value.

Move the cursor to "①U.LM" and press the SET key. Then move the cursor to "②L.LM" and press the SET key again. The current value will be highlighted for each item. You can increase or decrease the value by pressing the up and down arrow keys. Press the ESC key to confirm the value you want.

The values above can be reset to an appropriate level automatically. Move the cursor to the upper function menu by pressing the TRG/BRT key and select "AUTO-REG". Then press the SET key to set the levels automatically.

⇒ For details, see page 3-11.

⑤ INVERT B/W

Select whether to invert the display of black and white inside the measurement area.

Setting the mask details

On the "REG COND" screen, move the cursor to the upper function menu by pressing the TRG/BRT key. Select "DETAIL" by pressing the left and right arrow keys and then press the SET key. On the popup menu, you can select "MASK REGIST.," "BINARY PROCESS," and "BINRY NOISE FILT." The items selected here will be displayed on the "MEA-CND" menu.

⑥ MASK NO.

Select a mask number.

Note: This line is displayed when "NO. OF MASK 2" or "NO. OF MASK 4" is selected at "①WINDOW" on the "MEA-CND" screen.

⑦ MASK SHAPE

Select mask shape.

- Select "NO," "RECTANGLE," "CIRCLE," or "ELLIPSE."
- When "BINARY-IMG-MASK" is selected on the "①WINDOW" line, this line will not appear, since this is already selected on the "MASK BINARY IMG" screen.
- When "POLYGON" is selected on the "①WINDOW" line, specify the polygonal shape of the mask.

⑧ BINARY PROCESS

Select a binary processing method. Move the cursor to "FIXED," "THRES-ADJ (VAR-DIFF)" {adjustable threshold value (variation difference)}, or "THRES-ADJ (VAR-RATE)" {adjustable threshold (variation rate)}, and press the SET key to continue.

⇒ For details, see page 3-13.

⑨ BINARY NOISE FILTER

Select a binary noise filter type. Move the cursor to "NO," "EXPD. → CONTR." (expansion → contraction), or "CONTR. → EXPD" (contraction → expansion), and press the SET key to continue.

⇒ For details, see page 3-14.

● When WINDOW has been set to "NUM-OF- MASK 2"

MEA-CND	SCREEN	COND	SAVE	DETAIL	F C1 BRT
① REGISTER NO.	0(0~7)				
② MEAS SHAPE	RECTANGLE				
③ MEAS AREA	SET (224,208)~(287,271)				
④ THRESHOLD	SET [U.LM255 L.LM100(0~255)]				
⑤ INVERT B/W	NO				
⑥ MASK NO.	0(0~1)				
⑦ MASK SHAPE	NO				
⑧ BINARY PROCESS	FIXED				
⑨ BINARY NOISE FILT	NO				

① MASK REGIST.

② BINARY PROCESS

③ BINRY NOISE FILT

NO
RECTANGLE
CIRCLE
ELLIPSE

FIXED
THRES-ADJ(VAR-DIFF)
THRES-ADJ(VAR-RATE)

NO
EXPD. → CONTR.
CONTR. → EXPD.

SET=SELECT A MENU ESC=BACK SEL=CHNG IMG TRG=FUNC

■ Setting example of measurement area and mask area

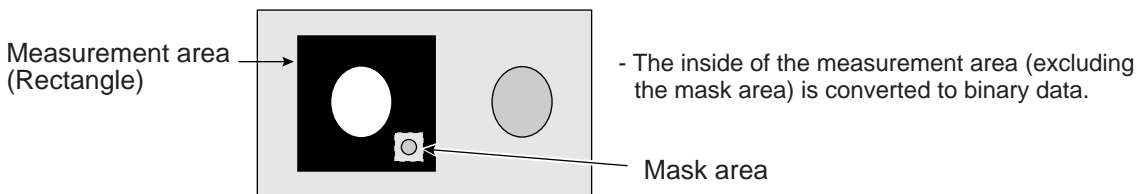

■ Set the evaluation conditions

● How to move to the evaluation condition setting screen

There are two methods for getting to the evaluation condition setting screen.

- 1) Select "COND" in the upper function menu on the MEAS COND (or REG COND) screen and press the SET key. Select "EVALUATION" on the pop up menu to go to the EVALUAT COND screen.

MEA-CND	SCREEN COND SAVE	F C1 BRT
① WINDOW	BINARY-IMG-MASK	<div style="border: 1px solid black; padding: 2px;"> IMG PRE-PROC REG COND EVALUATION NUM-CALC OUT </div>
② REGISTER NO.	0	
③ REGISTER EXIST	YES	
④ MASK BINARY IMG	REF-IMG	
⑤ BIN IMG MASK	(TO NEXT SUB-MENU)	
REGISTER NO.	00010203040506070809101112131415	
⑥ BIN AREA COND	○	
SET=SELECT A MENU ESC=BACK SEL=CHNG IMG TRG=FUNC		

- 2) Move the cursor to the "EVALUATION COND" item on the menu tree screen and press the SET key.

SELECT OBJECT TYPE COND	F C1 BRT
OBJECT TYPE COND + TYPE00 + TYPE01 + TYPE RUN COND + IMAGE-ADJ + MEA-CND(CAMERA1) + MEAS0 + POSI-DEVIATION + MEAS01(MEAS-BIN-AREA) + IMG PRE-PROC + MEAS COND + REG-COND + EVALUATION COND + NUM-CALC + OUT-COND + MEAS(NEW) + MEA-CND(CAMERA2) + FINAL NUM. CALC + FINAL OUTPUT COND + OBJ-TYPE I/O + OBJ-TYPE SYS.	① CHNG REG ② CONDITION SET ③ REGISTER 00 ④ REGISTER 01 ⑤ REGISTER 02 ⑥ REGISTER 03 ⑦ REGISTER 04 ⑧ REGISTER 05 ⑨ REGISTER 06 ⑩ REGISTER 07 ⑪ TEST
SET=TO NEXT SUB-MENU ESC=BACK SEL=CHNG IMG TRG=POPUP	

The "EVALUAT COND" (evaluation conditions) screen will appear.

⇒ For details about the evaluation conditions, see page 3-18.

EVALUAT COND SCREEN COND SAVE EDIT SEL	F C1 BRT
① CHNG REG	[TEST RESULT] [OUTPUT]
② CONDITION SET	AUTO(±10%)
③ REGISTER 00	000000-245760 A00= NO
④ REGISTER 01	000000-245760
⑤ REGISTER 02	000000-245760
⑥ REGISTER 03	000000-245760
⑦ REGISTER 04	000000-245760
⑧ REGISTER 05	000000-245760
⑨ REGISTER 06	000000-245760
⑩ REGISTER 07	000000-245760
⑪ TEST	EXEC(WITH-POSI.ADJ WITHOUT-POSI.ADJ)
SET=EXEC ESC=BACK SEL=CHNG IMG TRG=FUNC	

● Set the evaluation conditions

The display details vary with the setting of each window.

• When WINDOW has been set to "NUM-OF-MASK 1" and "NUM-OF-MASK 2"

EVALUAT	COND	SCREEN	COND	SAVE	EDIT	SEL	F	C1	BRT
①	CHNG REG					[TEST RESULT]		[OUTPUT]	
②	CONDITION SET	RESET	AUTO(+10%)						
③	REGISTER00		000000~245760	A00=000200		OK		NO	
④	REGISTER01		000000~245760	A01=000201		OK		NO	
⑤	REGISTER02		000000~245760	A02=000202		OK		NO	
⑥	REGISTER03		000000~245760	A03=000203		OK		NO	
⑦	REGISTER04		000000~245760	A04=000204		OK		NO	
⑧	REGISTER05		000000~245760	A05=000205		OK		NO	
⑨	REGISTER06		000000~245760	A06=000206		OK		NO	
⑩	REGISTER07		000000~245760	A07=000207		OK		NO	
⑪	TEST			EXEC(WITH-POSI.ADJ				WITHOUT-POSI.ADJ)	

Change the display of items ③ to ⑩ from REGISTER00 to 07" to REGISTER08 to 15."

You can set the output destinations using the up and down keys. (NO, Y0 to Y7, C000 to C127)

• When WINDOW has been set to "NUM-OF-MASK 4"

EVALUAT	COND	SCREEN	COND	SAVE	EDIT	SEL	F	C1	BRT
①	CHNG REG					[TEST RESULT]		[OUTPUT]	
②	CONDITION SET	RESET	AUTO(+10%)						
③	REGISTER00		000000~245760	A00=000200		OK		NO	
④	REGISTER01		000000~245760	A01=000201		OK		NO	
⑤	REGISTER02		000000~245760	A02=000202		OK		NO	
⑥	REGISTER03		000000~245760	A03=000203		OK		NO	
⑦	TEST			EXEC(WITH-POSI.ADJ				WITHOUT-POSI.ADJ)	

You can set the output destinations using the up and down keys. (NO, Y0 to Y7, C000 to C127)

• When WINDOW has been set to "BINARY-IMG-MASK or "POLYGON"

EVALUAT	COND	SCREEN	COND	SAVE	EDIT	SEL	F	C1	BRT
①	CHNG REG					[TEST RESULT]		[OUTPUT]	
②	CONDITION SET	RESET	AUTO(+10%)						
③	REGISTER00		000000~245760	A00=000200		OK		NO	
④	TEST			EXEC(WITH-POSI.ADJ				WITHOUT-POSI.ADJ)	

You can set the output destinations using the up and down keys. (NO, Y0 to Y7, C000 to C127)

■ Numeric calculation setting

- Press the TRG/BRT key to move the cursor to the upper function menu, and highlight "COND" using the left and right arrow keys. Press the SET key to show the popup menu. Select "NUM-CALC" from the popup menu.
- Select "NUM-CALC" on the menu tree.
- ⇒ See "Chapter 15: Numeric calculation."

■ Output condition setting

- Press the TRG/BRT key to move the cursor to the upper function menu, and highlight "COND" using the left and right arrow keys. Press the SET key to display the popup menu. Select "OUT" from the popup menu.
- Select "OUT-COND" on the menu tree.
- ⇒ See "Chapter 17: Set the Input/Output Conditions."

■ Display the measurement results

Return to the operation screen and press the TRG/BRT key. The measurement results will be displayed on the screen.

		(TYPE00)	F C1 BRT
		OK	V*:**
Final evaluation result	→	MEAS XXXXms 2001-10-14 10:38	
Measuring time	→	MEASUREMENT 1 MEAS-BIN-AREA	
Measurement program number	→	A00=005253 OK	
Area for registration number 00	→	A01=002674 OK	
" 01	→	A02=003200 OK	
" 02	→	A03=001884 OK	
" 03	→	A04=	
" 04	→	A05=	
" 05	→	A06=	
" 06	→	A07=	
" 07	→		

in the measurement condition
(Number of pixels)

*The areas will not be displayed for any unspecified registration numbers.



X0~7□□□□□□ Y0~7□□□□□□ READY □

MNU-CHG MAIN-COND CHG-MEA COND-CHG CHNG-REG SCREEN-CHG CHG-TYPE

Chapter 9: Object Counting by Binary Conversion

9-1 Outline

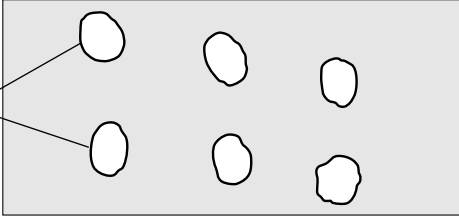
Purpose	Checks the number of objects (max. 3000 items.) when there is more than one object in an image. Measurement of the object's position is optional. - When the specified pixel field has been converted to a binary image, the white areas are measured or identified as separate objects and counted.
Applications	Counting the number of food products or parts.
Examples	<div style="display: flex; align-items: center;"> <div style="margin-right: 20px;">Objects</div>  <div style="margin-left: 20px;"> <p>[Measurement result] - Number of objects/total area</p> </div> </div> <p>- Inspection sequence</p> <pre> graph LR A[Capture an image] --> B[Convert it to a binary image] B --> C[Measure the number of objects/total area] </pre>

9-2 Setting operation

■ Setting the measurement conditions

● How to enter the measurement conditions setting screen

Select "MAIN-COND" -> "OBJECT TYPE COND" (menu tree)-> "TYPE00" -> "MEA-CND (CAMERA1)" -> "MEAS(NEW)," in that order. Then press the SET key to bring up the "MEAS1" screen.

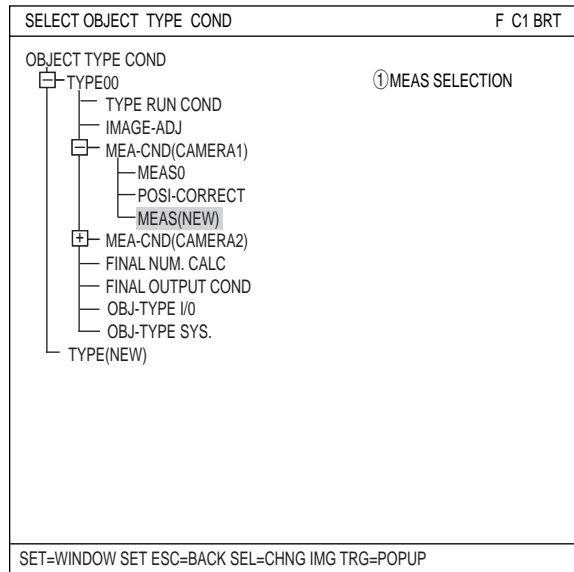

Move to the "①MEAS SELECTION" line on the "MEASUREMENT1" screen and select "CNT-BIN-OBJ" from the popup menu.

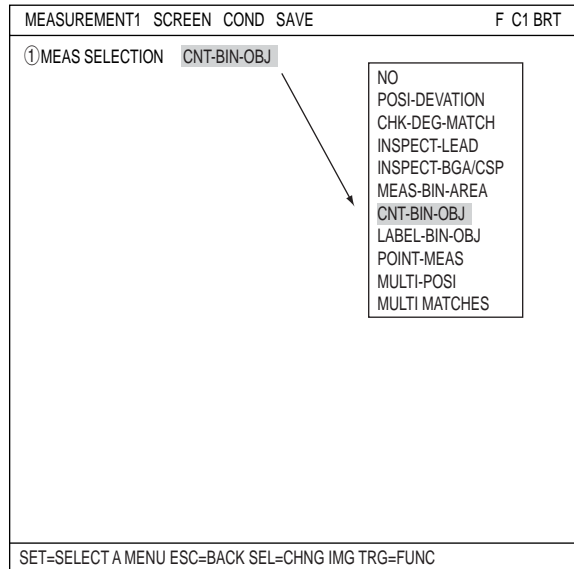

Press the ESC key to return to the OBJECT TYPE COND (menu tree) screen, and select the "MEAS CND" item shown under "MEAS01 (CNT-BIN-OBJ)" to go to the MEA-CND screen.

⇒ For details, see "Chapter 8: Setting Examples Using the Menu Tree" in the Introduction and Hardware.

● **Setting the measurement conditions**

① **WINDOW**

Select a window type. On the popup menu, move the cursor to "NORMAL," "BINARY-IMG-MASK," or "POLYGON," and press the SET key to select the item.

NORMAL	Normal window
BINARY-IMG-MASK	Select this item if the captured image is other than a rectangle, circle, or ellipse. This function masks the captured image using a stored binary image. ⇒ For details, see pages 3-26 to 30.
POLYGON	You can manually create any freeform polygon for the measurement area.

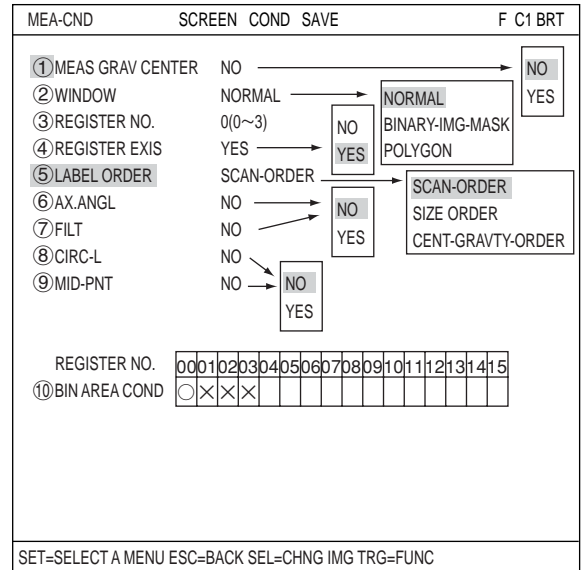

② **REGISTER NO.**

Select register number to measure. Number of selectable registers varies with window shape selected.

NORMAL	0 to 3
BINARY-IMG-MASK	0 only
POLYGON	0 only

To save the measurement conditions using a different register number, press the SET key and highlight the number. Change this number by pressing the up and down arrow keys.

③ **REGISTER EXIST**

Select whether to register or not.

REGISTER NO. (④ BIN AREA COND)

Register setting conditions are shown for each register number. Circles mean that "REGISTER EXIST" has set to "YES."

● **Setting (display) of binary area conditions**

REGISTER NO.	00	01	02	03
④ BIN AREA COND	○	x	x	

----- When item "③ REGISTER EXIST" is set to "YES," a circle is displayed.
x : No setting

■ How to set the register conditions

● How to enter the REG-COND setting screen

There are three methods for getting to the REG-COND setting screen.

- 1) On the "MEA-CND" setting screen, move the cursor to the "④BIN AREA COND" and press the SET key. The cursor will move into the table. Move the cursor to the "○" column and press the SET key.

Note: If you press the SET key in the "X" column, the setting will be invalid.

- 2) On the "MEA-CND" setting screen, press the TRG/BRT key to move the cursor to the upper function menu. Select the "COND" item and then select the "REG COND" item and press the SET key.

- 3) On the menu tree, move the cursor to the "MEAS CND" item, and press the right arrow key. The sub menu which contains the "REG COND" item will appear. Move the cursor to this item and press the SET key.

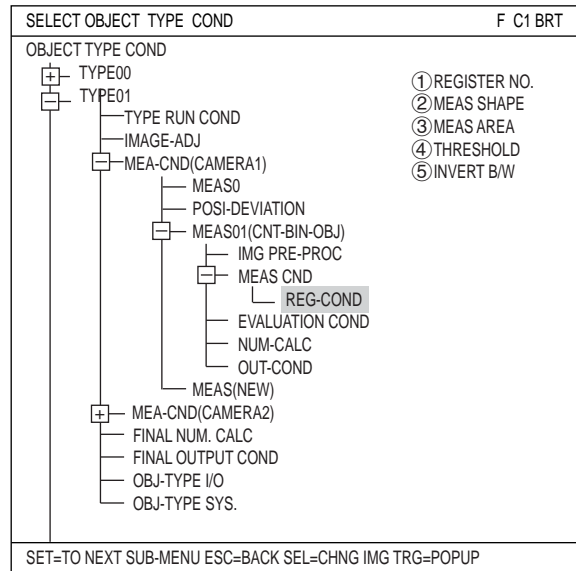
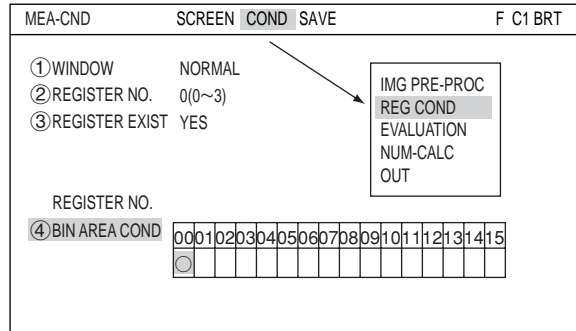

① REGISTER NO.

The currently selected register number is displayed.

If you want to set the measurement conditions for a different register number, press the SET key to highlight the register number currently selected. Then press the up and down arrow keys to select the register number whose measurement conditions you want to set. Press the SET key to confirm your selection.

Note: When the "BINARY-IMG-MASK" or the "POLYGON" is selected at "①WINDOW" on the "MEA-CND" screen, the "①REGISTER NO." line will not be displayed and the other item numbers are decremented by one since the register number for "BINARY-IMG-MASK" and "POLYGON" is fixed.

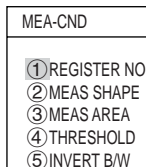
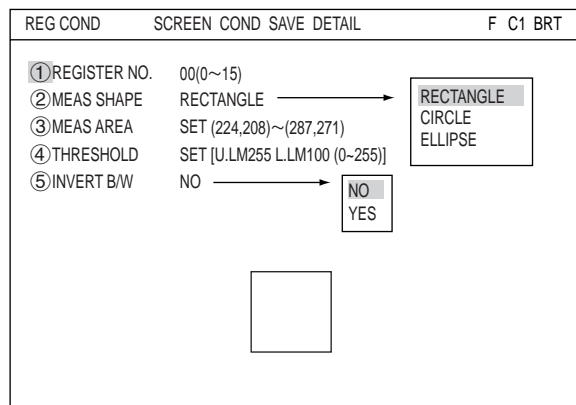

② MEAS SHAPE

Specify shape of measuring range.

RECTANGLE	Specify the coordinates for the upper left and lower right corners. The measurement area will be the area enclosed by this rectangle.
CIRCLE	Specify the center and the radius. The measurement area will be the area enclosed by this circle.
ELLIPSE	Specify the center and the radius. The measurement area will be the area enclosed by this ellipse.

③ MEAS AREA

Specify a search area.

● When "RECTANGLE" is selected

Specify the upper left and lower right corners of the rectangular search area.

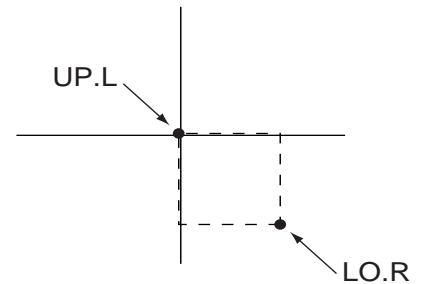

● When "CIRCLE" is selected

Specify the center and the radius.

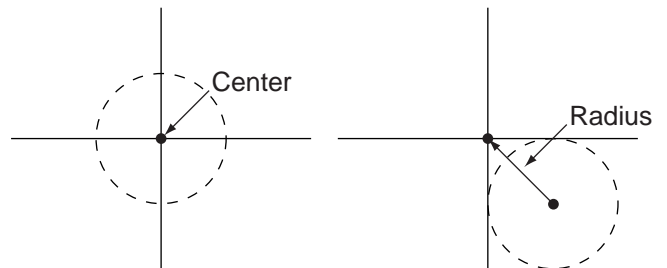

● When "ELLIPSE" is selected

Specify the center and the radius.

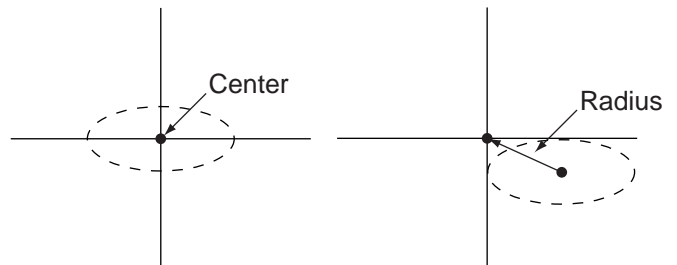

④ THRESHOLD

Specify a threshold value.

Move the cursor to "①U.LM" and press the SET key. Then move the cursor to "②L.LM" and press the SET key again. The current value will be highlighted for each item. You can increase or decrease the value by pressing the up and down arrow keys. Press the ESC key to confirm the value you want.

The values above can be reset to an appropriate level automatically. Move the cursor to the upper function menu by pressing the TRG/BRT key and select "AUTO-REG". Then press the SET key to set the levels automatically.

⇒ For details, see page 3-11.

⑤ **INVERT B/W**

Select whether to invert the display of black and white inside the measurement area.

Setting the mask details

On the "REG COND" screen, move the cursor to the upper function menu by pressing the TRG/BRT key. Select "DETAIL" by pressing the left and right arrow keys and then press the SET key. On the popup menu, you can select "MASK REGIST.," "BINARY PROCESS," "BINRY NOISE FILT," "BOUNDARY PROCESS," and "AREA FILTER." The items selected here will be displayed on the "REG COND" menu.

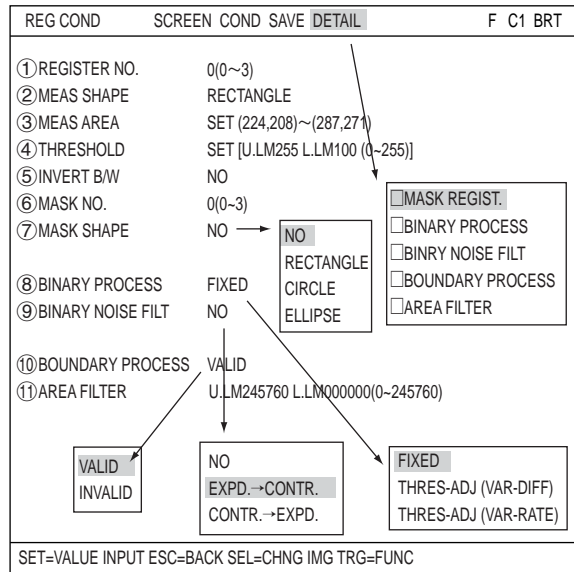

⑥ **MASK NO.**

Select a mask number.

Note: This is available when "NORMAL" is selected on the "①WINDOW" line.

⑦ **MASK SHAPE**

Select mask shape.

- Select "NO," "RECTANGLE," "CIRCLE," or "ELLIPSE."
- When "BINARY-IMG-MASK" is selected on the "①WINDOW" line, this line will not appear, since this is already selected on the "MASK BINARY IMG" screen.
- When "POLYGON" is selected on the "①WINDOW" line, specify the polygonal shape of the mask.

⑧ **BINARY PROCESS**

Select a binary processing method. Move the cursor to "FIXED," "THRES-ADJ (VAR-DIFF)" {adjustable threshold value (variation difference)}, or "THRES-ADJ (VAR-RATE)" {adjustable threshold (variation rate)}, and press the SET key to continue.

⇒ For details, see page 3-13.

⑨ **BINARY NOISE FILTER**

Select a binary noise filter type. Move the cursor to "NO," "EXPD. → CONTR." (expansion → contraction), or "CONTR. → EXPD" (contraction → expansion), and press the SET key to continue.

⇒ For details, see page 3-14.

⑩ **BOUNDARY PROCESS**

Select whether objects crossing the boundary of the window will be "VALID" or "INVALID."

⇒ For details, see page 3-14.

⑪ **AREA FILTER**

This function is used to exclude an object from measurement if its area is outside of the upper or lower limits. Specify a number from 0 to 245760.

■ **Example of register measurement area and area mask**

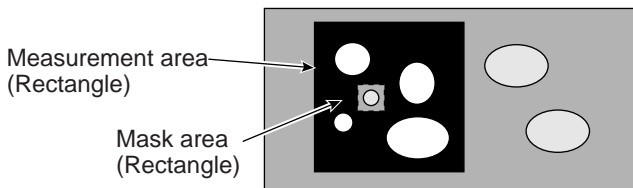

- The inside of the measurement area (excluding the mask area) is converted to binary data.

■ Set the evaluation conditions

● How to move to the evaluation condition setting screen

There are two methods for getting to the evaluation condition setting screen.

- 1) Select "COND" in the upper function menu on the MEA-CND (or REG COND) screen and press the SET key. Select "EVALUATION" on the pop up menu to go to the EVALUAT COND screen.

MEA-CND	SCREEN	COND	SAVE	F C1 BRT
① WINDOW	BINARY-IMG-MASK		IMG PRE-PROC	
② REGISTER NO.	0		REG COND	
③ REGISTER EXIST	YES		EVALUATION	
④ MASK BINARY IMG	REF-IMG		NUM-CALC	
⑤ BIN IMG MASK	(TO NEXT SUB-MENU)		OUT	
REGISTER NO.	00010203040506070809101112131415			
⑥ BIN AREA COND	<input type="checkbox"/>			

SET=SELECT A MENU ESC=BACK SEL=CHNG IMG TRG=FUNC

- 2) Move the cursor to the "EVALUATION COND" item on the menu tree screen and press the SET key.

SELECT OBJECT TYPE COND	F C1 BRT
OBJECT TYPE COND	① REGISTER NO.
TYPE00	② CONDITION SET
TYPE01	③ NUMBER OF OBJ
TYPE RUN COND	④ TOTAL AREA
IMAGE-ADJ	⑤ TEST
MEAS0	
POS-DEVIATION	
MEAS01(CNT-BIN-OBJ)	
IMG PRE-PROC	
MEAS CND	
REG-COND	
EVALUATION COND	
NUM-CALC	
OUT-COND	
MEAS(NEW)	
MEAS-CND(CAMERA2)	
FINAL NUM. CALC	
FINAL OUTPUT COND	
OBJ-TYPE SYS.	

SET=TO NEXT SUB-MENU ESC=BACK SEL=CHNG IMG TRG=POPUP

The "EVALUAT COND"(evaluation conditions) screen will appear.

- ⇒ For details about the evaluation conditions, see page 3-18.

EVALUAT COND SCREEN COND SAVE EDIT SEL	F C1 BRT		
① REGISTER NO.	0(0-3)	[TEST RESULT]	[OUTPUT]
② CONDITION SET	AUTO(±10%)		
③ NUMBER OF OBJ	0000-3000	K=	NO
④ TOTAL AREA	000000-245760	A=	NO
⑤ TEST	EXEC(WITH-POSI.ADJ WITHOUT-POSI.ADJ)		

SET=VALUE INPUT ESC=BACK SEL=CHNG IMG TRG=FUNC

■ **Numeric calculation setting**

- Press the TRG/BRT key to move the cursor to the upper function menu, and highlight "COND" using the left and right arrow keys. Press the SET key to show the popup menu. Select "NUM-CALC" from the popup menu.
- Select "NUM-CALC" on the menu tree.
- ⇒ See "Chapter 15: Numeric calculation."

■ **Output condition setting**

- Press the TRG/BRT key to move the cursor to the upper function menu, and highlight "COND" using the left and right arrow keys. Press the SET key to display the popup menu. Select "OUT" from the popup menu.
- Select "OUT-COND" on the menu tree.
- ⇒ See "Chapter 17: Set the Input/Output Conditions."

■ **Display the measurement results**

Return to the operation screen and press the TRG/BRT key. The measurement results will be displayed on the screen.

Final evaluation result → OK

Measuring time → MEAS XXXXms 2001-10-14 10:38

Measurement program → MEASUREMENT 1 CNT-BIN-OBJ

[K]	of resistration number	0	→	K0=00006	OK
[A]	"	0	→	A0=015781	OK
[K]	"	1	→	K1=00020	OK
[A]	"	1	→	A1=087620	OK
[K]	"	2	→	K2=00010	OK
[A]	"	2	→	A2=042680	OK
[K]	"	3	→	K3=	
[A]	"	3	→	A3=	

in the measurement condition
 [K]=NUMBER OF OBJECTS
 [A]=TORAL AREA
 (Number of pixels)

- Areas will not be displayed for unspecified registration numbers.

(TYPE00)
F C1 BRT
V**

OK

MEAS XXXXms 2001-10-14 10:38

MEASUREMENT 1 CNT-BIN-OBJ

→	K0=00006	OK
→	A0=015781	OK
→	K1=00020	OK
→	A1=087620	OK
→	K2=00010	OK
→	A2=042680	OK
→	K3=	
→	A3=	

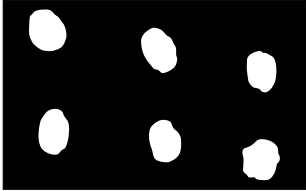

X0~7 ■■■■■■■■ Y0~7 ■■■■■■■■ READY □

MNU-CHG MAIN-COND CHG-MEA COND-CHG CHNG-REG SCREEN-CHG CHG-TYPE

9

Chapter 10: Object Identification by Binary Conversion

10-1 Outline

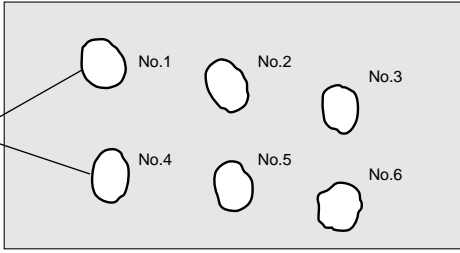
Purpose	<p>When there are several objects and their positions are random, the presence or absence of objects and the size of the objects can be determined.</p> <ul style="list-style-type: none"> - The specified pixel area is converted to a binary image. The number of objects, total size of the white area (the objects) and the area, center of gravity, main axis angle, fillet diameter, circumference and center of each white area can be measured.
Applications	<p>Counting the number of food products or parts, measuring the angle of rotation or the center of gravity of parts, and measuring the size of food products</p>
Examples	<p>[Measurement of 6 objects]</p> <div style="display: flex; align-items: center;"> <div style="margin-right: 20px;">Objects</div>  <div style="margin-left: 20px;"> <p>[Measurement results]</p> <ul style="list-style-type: none"> - Object identification (labeling and numbering), number of objects present, total area. - Area, center of gravity, main axis angle, fillet diameter, circumference, and center of each object (No.1 to No.6). </div> </div> <p>- Inspection sequence</p> <pre> graph LR A[Image capture] --> B[Convert it to a binary image] B --> C[Object identification (labeling and numbering)] C --> D[Measure the area, center of gravity, main axis angle, fillet diameter, circumference, and center] </pre>

10-2 Setting operation

■ Setting the measurement conditions

● How to enter the measurement conditions setting screen

Select "MAIN-COND" -> "OBJECT TYPE COND" (menu tree)-> "TYPE00" -> "MEA-CND (CAMERA1)" -> "MEAS(NEW)," in that order. Then press the SET key to bring up the "MEAS1" screen.

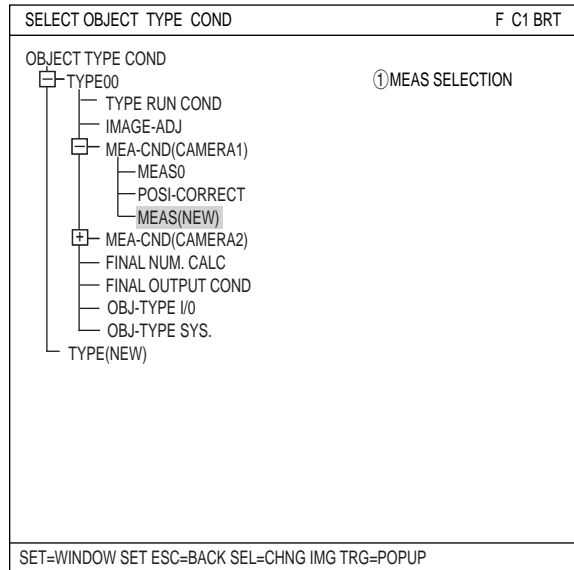

Move to the "①MEAS SELECTION" line on the "MEASUREMENT1" screen and select "LABEL-BIN-OBJ" from the popup menu.

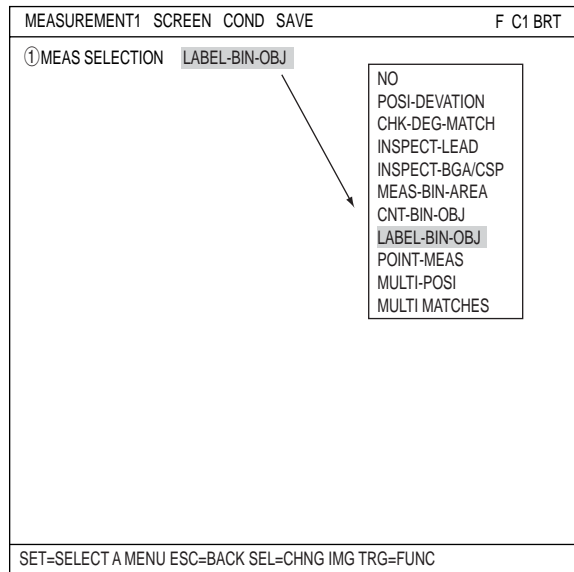

Press the ESC key to return to the OBJECT TYPE COND (menu tree) screen, and select the "MEAS CND" item shown under "MEAS01 (LABEL-BIN-OBJ)" to go to the "MEA-CND" screen.

⇒ For details, see "Chapter 8: Setting Examples Using the Menu Tree" in the Introduction and Hardware.

● Setting the measurement conditions

- ① **MEAS GRAV CENTR**
Select whether or not to measure the center of gravity.

- ② **WINDOW**
Select a window type. On the popup menu, move the cursor to "NORMAL," "BINARY-IMG-MASK," or "POLYGON," and press the SET key to select the item.

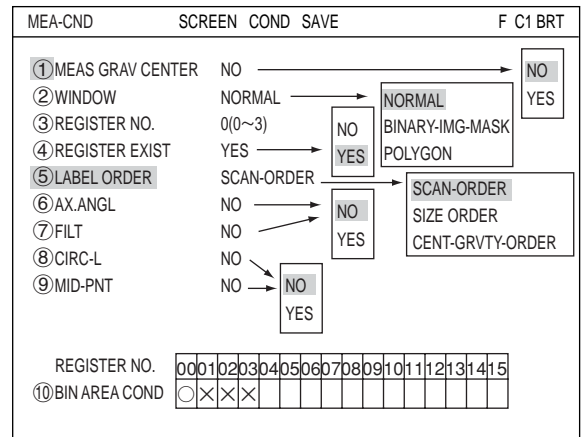

NORMAL	Normal window
BINARY-IMG-MASK	Select this item if the captured image is other than a rectangle, circle, or ellipse. This function masks the captured image using a stored binary image. ⇒ For details, see pages 3-26 to 30.
POLYGON	You can manually create any freeform polygon for the measurement area.

- ③ **REGISTER NO.**
Select register number to measure. Number of selectable registers varies with window shape selected.

NORMAL	0 to 3
BINARY-IMG-MASK	0 only
POLYGON	0 only

To save the measurement conditions using a different register number, press the SET key and highlight the number. Change this number by pressing the up and down arrow keys.

- ④ **REGISTER EXIST**
Select whether or not to register the measurement conditions. When "YES" is selected, items ⑤ to ⑨ will be displayed on the "MEA-CND" menu.

- ⑤ **LABEL ORDER**
Set the order for displaying the measured results. Select "SCAN-ORDER," "SIZE-ORDER," or "CENT-GRVTY-ORDER" and then press the SET key.

SCAN-ORDER	Assigns label numbers in the order in which objects were scanned (from top to bottom) in the measurement range.
SIZE-ORDER	Assigns label numbers by the size of the objects found in the measurement range, from largest to smallest.
CENT-GRVTY-ORDER	Assigns label numbers by the of center gravity of the objects found in the measurement range, from heaviest to lightest.

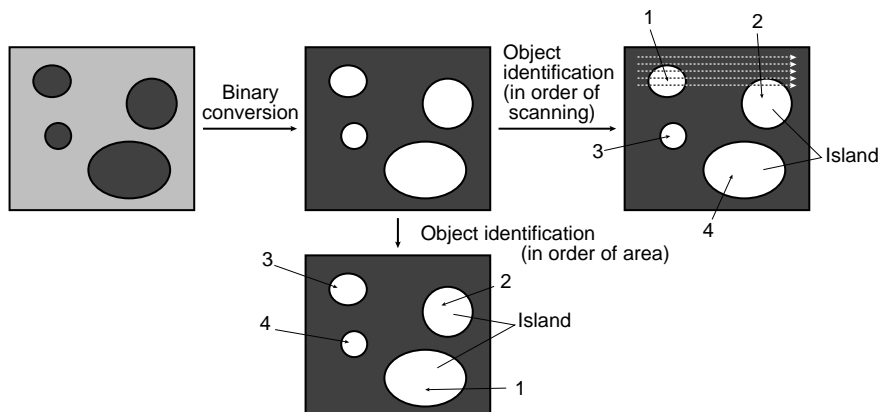

⑥ **AX.ANGL (axis angle)**

Select whether to measure the angle of the longitudinal line (drawn through the gravity center of the workpiece) to the horizontal.

• **Main axis angle**

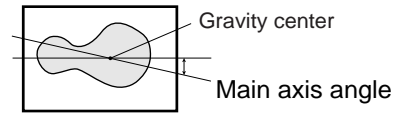

⑦ **FILT (fillet diameter)**

Select whether to measure the diameters of horizontal and vertical fillets on the workpiece.

• **Fillet width**

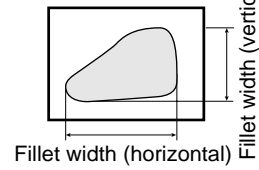

⑧ **CIRC-L (peripheral length)**

Select whether to count the number of pixels in the perimeter of the workpiece.

• **Peripheral**

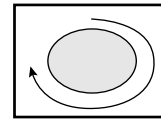

The number of pixels in the boundary line of an object (stepped are counted as $x\sqrt{2}$ pixels)

⑧ **MID-PNT (middle point)**

Select whether to measure the center point of the workpiece.

• **Center of gravity, main axis angle, and center**

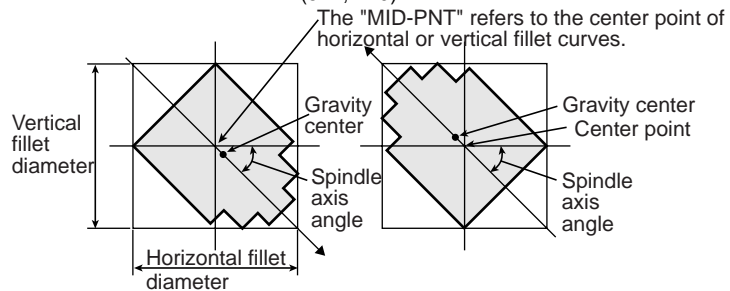
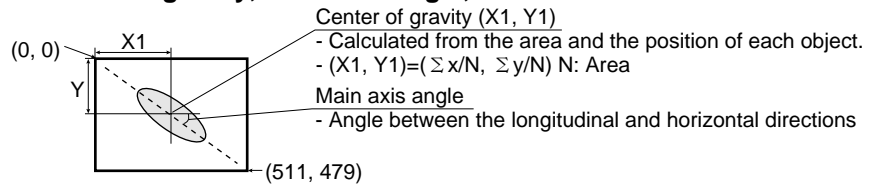

By the combined use of the center point and the center of gravity, a workpiece' orientation can be measured even when it cannot be evaluated by its spindle axis

REGISTER NO. (⑩BIN AREA COND)

Register setting conditions are shown for each register number. Circles mean that "REGISTER EXIST" has set to "YES."

● **Setting (display) of binary area conditions**

REGISTER NO.	00	01	02	03
⑩BIN AREA COND	○	×	×	○

----- When item "④REGISTER EXIST" is set to "YES," a circle is displayed.
 × : No setting

How to set the register conditions

How to enter the REG-COND setting screen

There are three methods for getting to the REG-COND setting screen.

- On the "MEA-CND" setting screen, move the cursor to the "⑩BIN AREA COND" and press the SET key. The cursor will move into the table. Move the cursor to the "○" column and press the SET key.

Note: If you press the SET key in the "X" column, the setting will be invalid.

- On the "MEA-CND" setting screen, press the TRG/BRT key to move the cursor to the upper function menu. Select the "COND" item and then select the "REG COND" item and press the SET key.

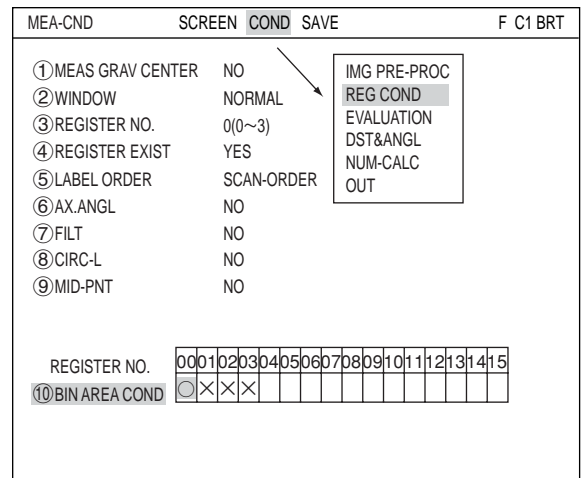

- On the menu tree, move the cursor to the "MEAS CND" item, and press the right arrow key. The sub menu which contains the "REG COND" item will appear. Move the cursor to this item and press the SET key.

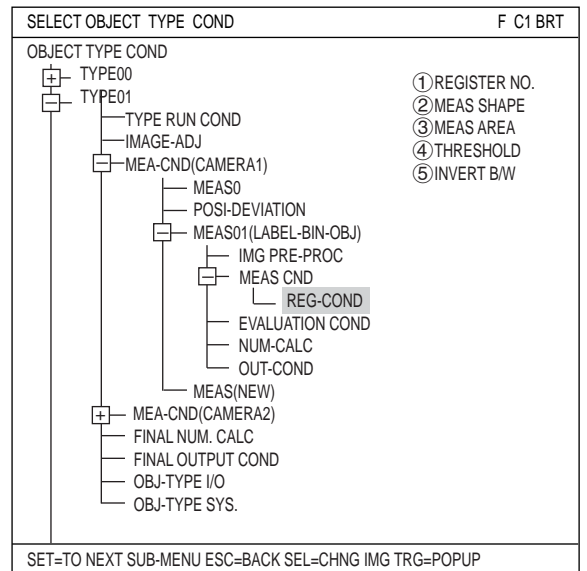

① REGISTER NO.

The currently selected register number is displayed.

If you want to set the measurement conditions for a different register number, press the SET key to highlight the register number currently selected. Then press the up and down arrow keys to select the register number whose measurement conditions you want to set. Press the SET key to confirm your selection.

Note: When the "BINARY-IMG-MASK" or the "POLYGON" is selected at

"① WINDOW" on the "MEA-CND" screen, the "① REGISTER NO." line will not be displayed and the other item numbers are decremented by one since the register number for "BINARY-IMG-MASK" and "POLYGON" is fixed.

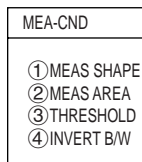
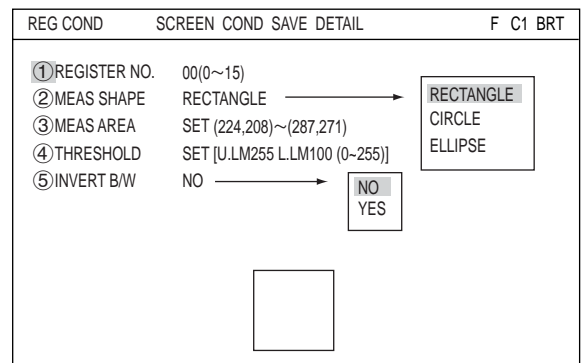

② **MEAS SHAPE**

Specify shape of measuring range.

RECTANGLE	Specify the coordinates for the upper left and lower right corners. The measurement area will be the area enclosed by this rectangle.
CIRCLE	Specify the center and the radius. The measurement area will be the area enclosed by this circle.
ELLIPSE	Specify the center and the radius. The measurement area will be the area enclosed by this ellipse.

③ **MEAS AREA**

Specify a search area.

● **When "RECTANGLE" is selected**

Specify the upper left and lower right corners of the rectangular search area.

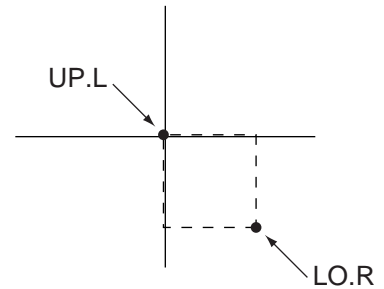

● **When "CIRCLE" is selected**

Specify the center and the radius.

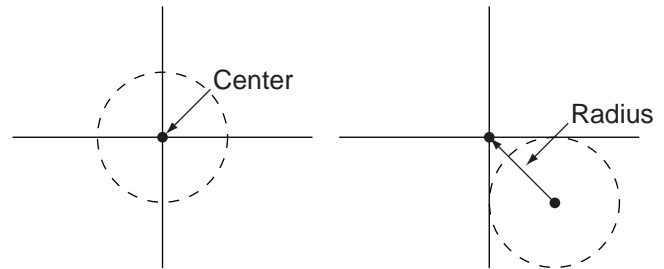

● **When "ELLIPSE" is selected**

Specify the center and the radius.

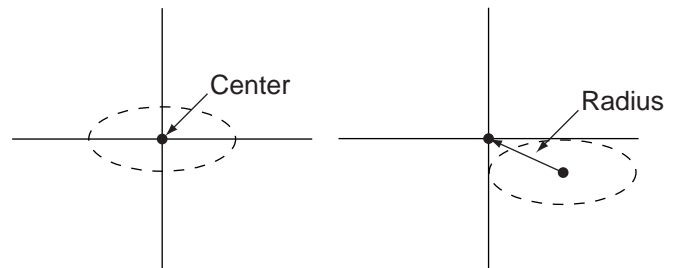

④ **THRESHOLD**

Specify a threshold value.

Move the cursor to "①U.LM" and press the SET key. Then move the cursor to "②L.LM" and press the SET key again. The current value will be highlighted for each item. You can increase or decrease the value by pressing the up and down arrow keys. Press the ESC key to confirm the value you want.

The values above can be reset to an appropriate level automatically. Move the cursor to the upper function menu by pressing the TRG/BRT key and select "AUTO-REG". Then press the SET key to set the levels automatically.

⇒ For details, see page 3-11.

⑤ **INVERT B/W**

Select whether to invert the display of black and white inside the measurement area.

Setting the mask details

On the "REG COND" screen, move the cursor to the upper function menu by pressing the TRG/BRT key. Select "DETAIL" by pressing the left and right arrow keys and then press the SET key. On the popup menu, you can select "MASK REGIST.," "BINARY PROCESS," "BINRY NOISE FILT," "BOUNDARY PROCESS," and "AREA FILTER." The items selected here will be displayed on the "REG COND" menu.

⇒ See page 8-6.

- ⑥ **MASK NO.**
 Select a mask number.
 Note: This is available when "NORMAL" is selected on the "①WINDOW" line.

- ⑦ **MASK SHAPE**
 Select mask shape.
 - Select "NO," "RECTANGLE," "CIRCLE," or "ELLIPSE."
 - When "BINARY-IMG-MASK" is selected on the "①WINDOW" line, this line will not appear, since this is already selected on the "MASK BINARY IMG" screen.
 - When "POLYGON" is selected on the "①WINDOW" line, specify the polygonal shape of the mask.

- ⑧ **BINARY PROCESS**
 Select a binary processing method. Move the cursor to "FIXED," "THRES-ADJ (VAR-DIFF)" {adjustable threshold value (variation difference)}, or "THRES-ADJ (VAR-RATE)" {adjustable threshold (variation rate)}, and press the SET key to continue.
 ⇨ For details, see page 3-13.

- ⑨ **BINARY NOISE FILTER**
 Select a binary noise filter type. Move the cursor to "NO," "EXPD. → CONTR." (expansion → contraction), or "CONTR. → EXPD" (contraction → expansion), and press the SET key to continue.
 ⇨ For details, see page 3-14.

- ⑩ **BOUNDARY PROCESS**
 Select whether objects crossing the boundary of the window will be "VALID" or "INVALID."
 ⇨ For details, see page 3-12.

- ⑪ **AREA FILTER**
 This function is used to exclude an object from measurement if its area is outside of the upper or lower limits. Specify a number from 0 to 245760.

■ Example of register measurement area and area mask

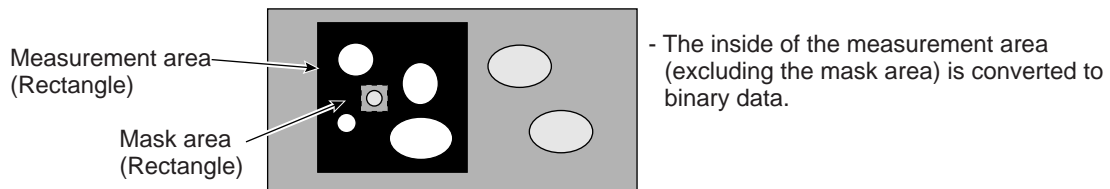

■ Set the evaluation conditions

● How to move to the evaluation condition setting screen

There are two methods for getting to the evaluation condition setting screen.

- 1) Select "COND" in the upper function menu on the MEA-CND (or REG COND) screen and press the SET key. Select "EVALUATION" on the pop up menu to go to the EVALUAT COND screen.

MEA-CND		SCREEN	COND	SAVE	F C1 BRT	
① MEAS GRAV CENTER	NO					
② WINDOW	NORMAL					
③ REGISTER NO.	0(0~3)					
④ REGISTER EXIST	NO					
⑤ LABEL ORDER	SCAN-ORDER					
⑥ AX.ANGL	NO					
⑦ FILT	NO					
⑧ CIRC-L	NO					
⑨ MID-PNT	NO					
REGISTER NO.		00010203040506070809101112131415				
⑩ BIN AREA COND		○ × × ×				

SET=SELECT A MENU ESC=BACK SEL=CHNG IMG TRG=FUNC

- 2) Move the cursor to the "EVALUATION COND" item on the menu tree screen and press the SET key.

SELECT OBJECT TYPE COND		F C1 BRT	
OBJECT TYPE COND		① REGISTER NO.	
TYPE00		② CONDITION SET	
TYPE01		③ NUMBER OF OBJ	
TYPE RUN COND		④ TOTAL AREA	
IMAGE-ADJ		⑤ TEST	
MEAS(CAMERA1)			
MEAS0			
POSI-DEVIATION			
MEAS01(CNT-BIN-OBJ)			
IMG PRE-PROC			
MEAS CND			
REG-COND			
EVALUATION COND			
NUM-CALC			
OUT-COND			
MEAS(NEW)			
MEAS(CAMERA2)			
FINAL NUM. CALC			
FINAL OUTPUT COND			
OBJ-TYPE I/O			
OBJ-TYPE SYS.			

SET=TO NEXT SUB-MENU ESC=BACK SEL=CHNG IMG TRG=POPUP

The "EVALUAT COND"(evaluation conditions) screen will appear.

- ⇒ For details about the evaluation conditions, see page 3-18.

EVALUAT COND SCREEN COND SAVE EDIT SEL				F C1 BRT	
① REGISTER NO.	0(0-3)	[TEST RESULT]	[OUTPUT]		
② CONDITION SET	AUTO(±10%)				
③ NUMBER OF OBJ	000-128	K=	NO		
④ TOTAL AREA	000000-245760	A=	NO		
⑤ LABEL NO.	000(0-000)				
⑥ OBJECT AREA	000000-245760	R=	NO		
MAIN AXIS ANGL		B=			
FILLET WIDTH		FX=			
		FY=			
PERIPHERAL		CR=			
MID POINT		CX=			
		CY=			
⑦ TEST	EXEC(WITH-POSI.ADJ WITHOUT-POSI.ADJ)				

SET=VALUE INPUT ESC=BACK SEL=CHNG IMG TRG=FUNC

■ Numeric calculation setting

- Press the TRG/BRT key to move the cursor to the upper function menu, and highlight "COND" using the left and right arrow keys. Press the SET key to show the popup menu. Select "NUM-CALC" from the popup menu.
- Select "NUM-CALC" on the menu tree.
- ⇒ See "Chapter 15: Numeric calculation."

■ Output condition setting

- Press the TRG/BRT key to move the cursor to the upper function menu, and highlight "COND" using the left and right arrow keys. Press the SET key to display the popup menu. Select "OUT" from the popup menu.
- Select "OUT-COND" on the menu tree.
- ⇒ See "Chapter 17: Set the Input/Output Conditions."

■ Display the measurement results

Return to the operation screen and press the TRG/BRT key. The measurement results will be displayed on the screen.

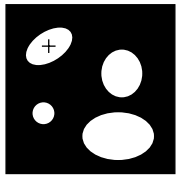
	(TYPE00)	F C1 BRT V*. **
Final evaluation result	→ OK	
Measuring time	→ MEAS XXXXms 2001-10-14 10:38	
Measurement program	→ MEASUREMENT 1 LABEL-BIN-OBJ	
Registration number in the measurement condition	→ REGISTER NO.0(0~3)	
NUMBER OF OBJECTS	→ K=004 OK	
TOTAL AREA	→ A=006168 OK	
LABEL NUMBER	→ LABEL NUMBER 000(000~003)	
OBJECT AREA	→ R=001542 OK	
CENTER OF GRAVITY	→ [GX=206.0 OK	
	→ [GY=303.0	
CORDINATE	→ B=+028.0°	
MAIN AXIS ANGLE	→ [FX=042	
	→ [FY=037	
FILLET DIA	→ CR=00138.8	
PERIPHERAL	→ [CX=	
	→ [CY=	
		
	X0~7 [] Y0~7 []	READY []
	MNU-CHG MAIN-COND CHG-MEA COND-CHG CHNG-REG SCREEN-CHG CHG-TYPE	

- CENT OF GRAV, MAIN AXIS ANGL, FILLET WIDTH, PERIPHERAL, or MID POINT are displayed when measurement of these parameters has been specified ("YES" has been selected) on the "MEAS COND" menu (page 10-2).

Chapter 11: Existence Inspection by Point Measurement

11-1 Outline

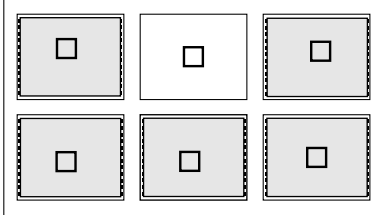
<p>Purpose</p>	<p>The presence or absence of target objects is examined.</p> <ul style="list-style-type: none"> · A simple black and white evaluation is made in the specified pixel area of binary images. · The light level in the specified pixel area is averaged, and a decision is made whether or not it is within the specified range of brightness for gray scale images.
<p>Applications</p>	<p>Checking the presence or absence of packed parts, inspecting the working condition of LEDs or fluorescent character display tubes, and sorting household electric appliances</p>
<p>Examples</p>	<p>● Inspection of 6 points</p> <div style="display: flex; align-items: center;">  <div style="margin-left: 20px;"> <p>Number of points (max.): 128 points looking at average light levels 256 points in binary images</p> <p>Point size: 2 m x 2n pixels (m, n = 1 to 16)</p> </div> </div> <p>· Inspection sequence</p> <pre> graph LR A[Image capture] --> B[Binary image conversion] A --> C[Average light level] B --> D[Black/white evaluation of points] C --> E[Light level evaluation of points] </pre>

11-2 Setting operation

■ Setting the measurement conditions

● How to enter the measurement conditions setting screen

Select "MAIN-COND" -> "OBJECT TYPE COND" (menu tree)-> "TYPE00" ->"MEA-CND (CAMERA1)" -> "MEAS(NEW)," in that order. Then press the SET key to bring up the "MEAS1" screen.

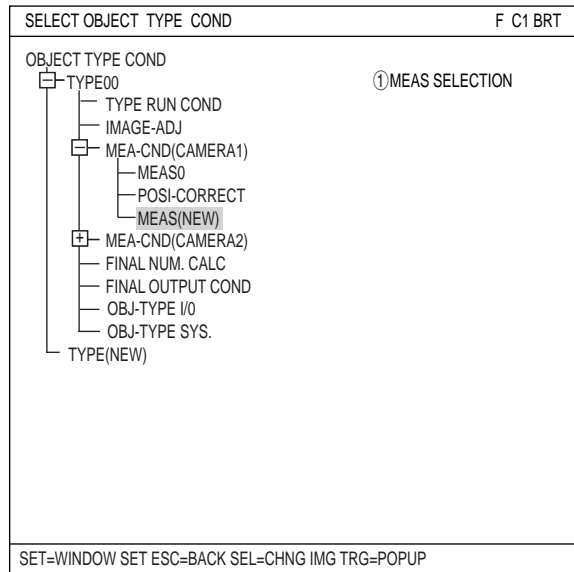

Move to the "①MEAS SELECTION" line on the "MEASUREMENT1" screen and select "POINT-MEAS" from the popup menu.

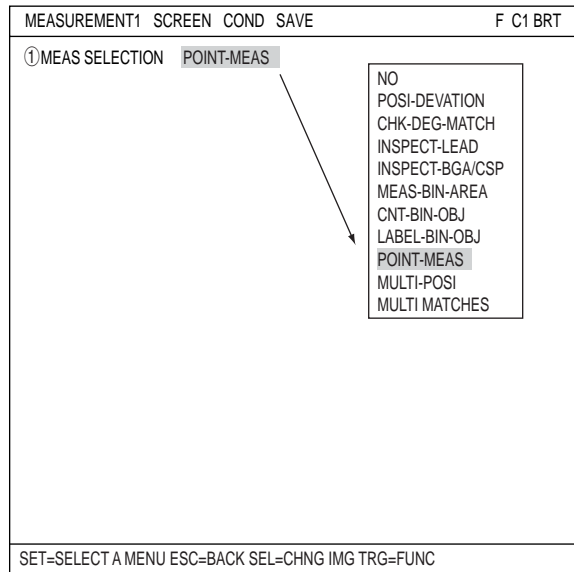

Press the ESC key to return to the "OBJECT TYPE COND" (menu tree) screen, and select the "MEAS CND" item shown under "MEAS01 (POINT-MEAS)" to go to the "MEA-CND" screen.

⇒ For details, see "Chapter 8: Setting Examples Using the Menu Tree" in the Introduction and Hardware.

● Setting conditions (mode selection)

Select a mode on the "①MODE" line. By selecting either "BINARY" or "AVG-GRAYS," the details of the settings will vary.

When the "BINARY" mode is selected

② BINARY PROCESS

Select a binary processing procedure. Select "FIXED," "THRES-ADJ(VAR-DIFF)," or "THRES-ADJ(VAR-RATE)."

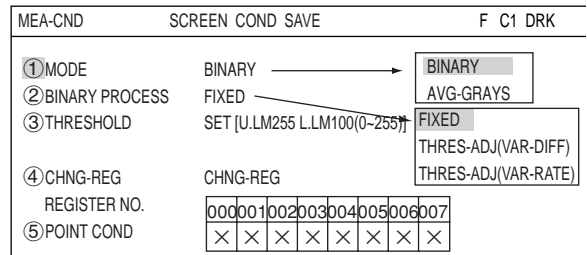

FIXED	Does not correct the threshold value.
THRES-ADJ(VAR-DIFF)	Effective in preventing binary processing failures since it applies adjustments according to changes in the lighting conditions for individual workpieces.
THRES-ADJ(VAR-RATE)	

⇒ For details, see page 3-13.

③ THRESHOLD

Specify a threshold value. Select this line and press the SET key to enter the "THRESHOLD" screen. Move the cursor to "①U.LM" and "②L.LM" each, then press the SET key. The current value will be highlighted for each item. You can increase or decrease the value by pressing the up and down arrow keys. Press the ESC key to confirm the value you want.

⇒ For details, see page 3-11.

AUTO SETTING

The values above can be reset to an appropriate level automatically. Move the cursor to the upper function menu by pressing the TRG/BRT key and select "AUTO-REG". Then press the SET key to set the levels automatically.

When the "AVG-GRAYS" mode is selected

② AVG. GRAY PROC

Select an average gray processing method. Select "FIXED," "GRAY-ADJ (VAR-DIFF)," or "GRAY-ADJ(VAR-RATE)."

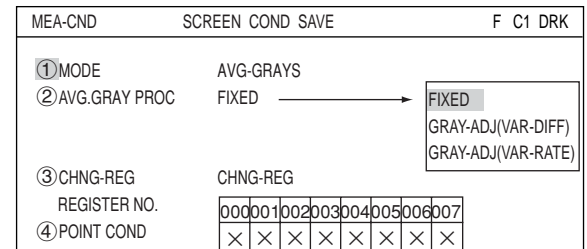

FIXED	Does not correct the gray level.
GRAY-ADJ(VAR-DIFF)	Corrects the gray level by adding a specified threshold value to the reference for variation in the light level. (Measured light level) - (reference light level) + (specified threshold value)
GRAY-ADJ(VAR-RATE)	Corrects the gray level by multiplying a specified threshold value times the reference for variation in the light level. (Measured light level) / (reference light level) x (specified threshold value)

③ CHNG-REG

Changes the display of the registration numbers for the "④POINT COND." Move the cursor to this line and press the SET key. "CHNG-REG" will be highlighted. Then, press the up and down arrow keys to change the register number series shown in the table as follows "000 to 007," "008 to 015," "016 to 023," ... up to "248 to 255".

- If the "BINARY" mode was selected, a maximum of 256 points (0 to 255) can be registered.

- If the "AVG-GRAYS" mode was selected, a maximum of 128 points (0 to 127) can be registered.

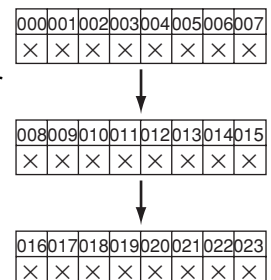

④ POINT COND

Points which have been registered are marked with an "O."

- After being registered on the point condition setting screen, an "O" will be displayed in the corresponding cells.

⇒ For details, see next page.

■ Setting the conditions (by selecting the point conditions)

● How to enter the REG COND setting screen

This paragraph describes the setting for each point condition.

There are three ways to bring up the "REG COND" screen.

- 1) On the "MEA-CND" setting screen, move the cursor to the "⑤POINT COND" and press the SET key. The cursor will move into the table. Move the cursor to the "X" column and press the SET key.

Note: After being registered, the "X" mark in a corresponding cell is changed to "O."

- 2) On the "MEA-CND" setting screen, press the TRG/BRT key to move the cursor to the upper function menu. Select the "COND" item and then select the "REG COND" item and press the SET key.

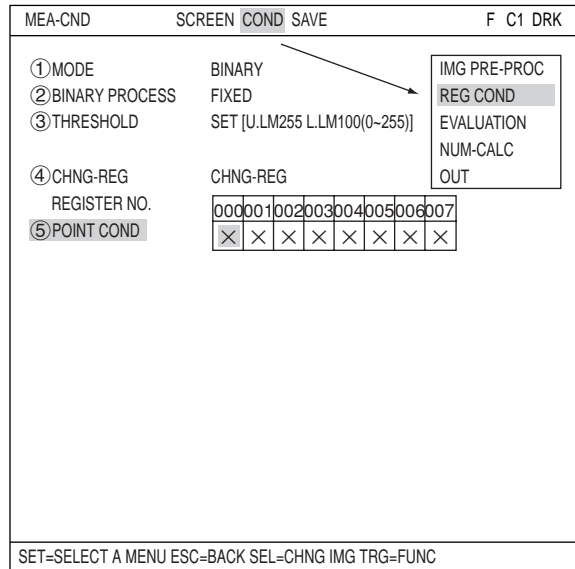

- 3) On the menu tree, move the cursor to the "MEAS CND" item, and press the right arrow key. The sub menu which contains the "REG COND" item will appear. Move the cursor to this item and press the SET key.

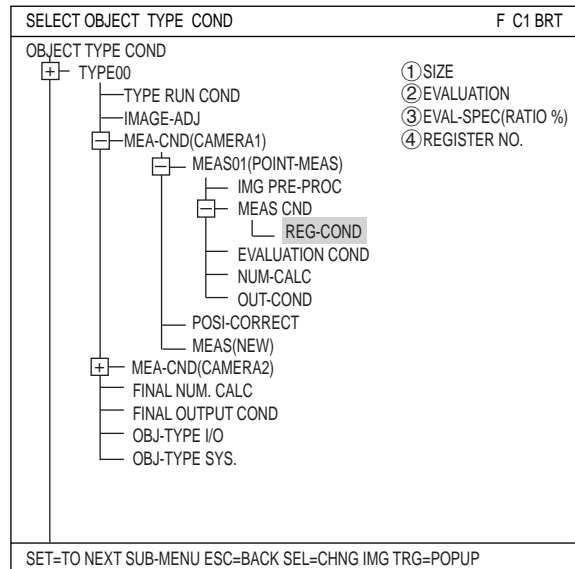

● Setting the point measurement conditions

① **SIZE**

Specify the point size. Highlight the numbers next to "X" and "Y" and increase or decrease the value using the up and down arrow keys. To confirm the new value, press the SET key twice. When the settings are complete, press the ESC key. The point size can be set between 2 and 32, in units of one pixel.

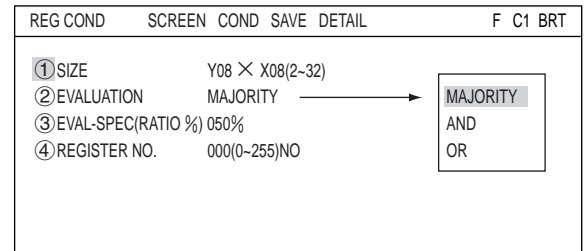

② **EVALUATION**

Set the evaluation condition. Select "MAJORITY," "AND," or "OR." The details for the evaluation settings are as follows.

② EVALUATION	Description
MAJORITY	When white occupies more than the specified percentage of pixels in a point, it is treated as white. Under any other conditions than the above it is treated as black. The value can be set between 0 and 100%, in units of 1%.
AND	When all the pixels are white, this point will be treated as white.
OR	When even one pixel is white, this point will be treated as white.

③ **EVAL-SPEC**

Select the number and highlight it. Then increase or decrease the number using the up and down arrow keys. To confirm the new value, press the SET key twice. When the changes are complete, press the ESC key.

④ **REGISTER NO.**

When you want to change the number already registered, highlight the number and increase or decrease the number by pressing the up and down arrow keys. Next, move the cursor to the "NO" position and press the SET key. A popup menu will appear. Select "YES" on this popup menu to store this register number.

Specify the position of the point

After storing the register number using "④REGISTER NO.," a point will appear on the screen. Move the cursor on the "⑤UPPER LEFT" line and press the SET key. Then highlight the "MOVE" item and press the SET key. Now you can move the point anywhere on the screen using the up/down, left/right arrow keys.

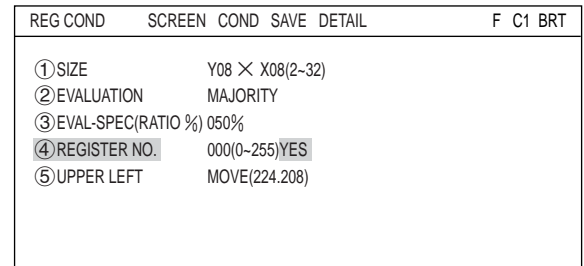

● **STORE BLOCK COND**

Press the TRG/BRT key to move the cursor to the upper function menu. Select "DETAIL" and press the SET key. Select "STORE BLCK OF PNTS" from the popup menu and press the SET key. Now, items ⑥ to ⑩ will be displayed on the "REG COND" menu.

This function is used to set a group of points at the same time, after specifying the number of points horizontally and vertically and their spacing.

④ **REGISTER NO.**

When "AND" or "OR" is selected on the "② EVALUATION" line, select "YES" at the "④ REGISTER NO." item. Then, "⑤ UPPER LEFT" will be displayed.

⑤ **UPPER LEFT**

Specify the coordinates of the upper left corner of the block you want to register.

⑥ **BLOCK ARRANGEMENT**

Enter the number of points along the X (horizontal) and Y (vertical) axes.

⑦ **BLOCK SPACING**

Specify the distance between the points in the horizontal and vertical rows.

⑧ **STORE BLCK OF PTS**

Select "EXEC" and press the SET key to register the block.

⑨ **DEL BLOCK OF PTS**

Delete all the points that were registered at the same time.

⑩ **MOVE BLOCK OF PTS**

Move the group of points that were registered at the same time.

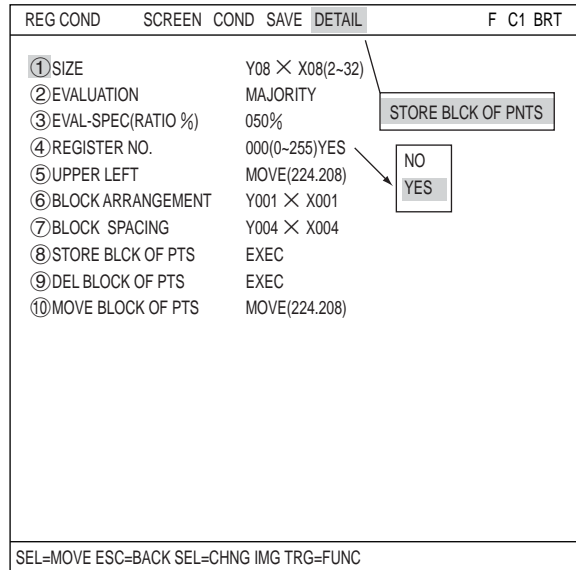

■ **Example of a block registration**

Set the starting point in item ⑤ above.

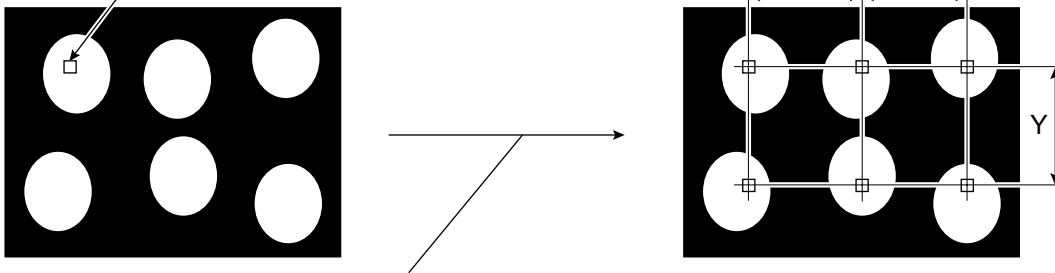

Enter 002 (vertical) · 003 (horizontal) in item "⑥ BLOCK ARRANGEMENT," and enter the vertical (Y) and horizontal (X) intervals in item "⑦ BLOCK SPACING." Then select item "⑧ STORE BLOCK OF PTS" to store the settings for the block.

■ Set the evaluation conditions

● How to move to the evaluation condition setting screen

There are two methods for getting to the evaluation condition setting screen.

- 1) Select "COND" in the upper function menu on the MEA-CND (or REG COND) screen and press the SET key. Select "EVALUATION" on the pop up menu to go to the EVALUAT COND screen.

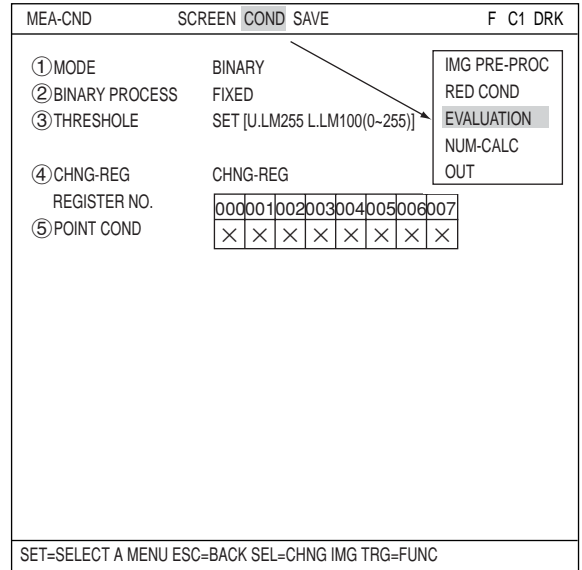

- 2) Move the cursor to the "EVALUATION COND" item on the menu tree screen and press the SET key.

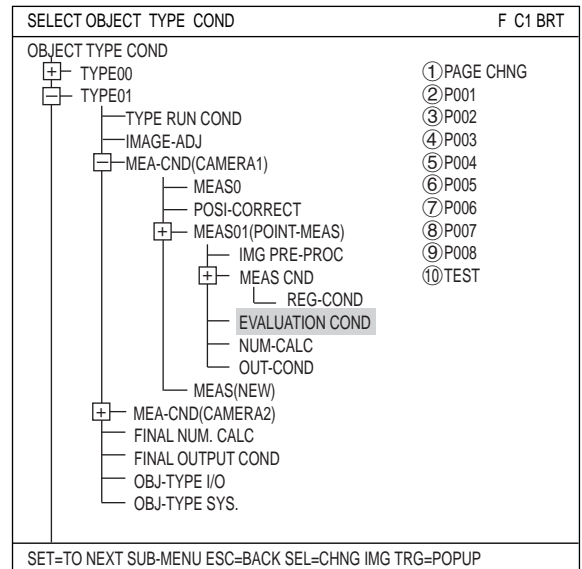

The "EVALUAT COND"(evaluation conditions) screen will appear.

⇒ For details about the evaluation conditions, see page 3-18.

• When MODE has been set to "BINARY"

EVALUAT COND	SCREEN COND	SAVE	EDIT	SEL	F	C1	DRK
①PAGE CHNG							
②P000	WHITE		OK				NO
③P001	WHITE		OK				NO
④P002	WHITE		OK				NO
⑤P003	WHITE		OK				NO
⑥P004	WHITE		OK				NO
⑦P005							
⑧P006							
⑨P007							
⑩TEST							

Acceptance (OK/NG) criteria

WHITE: Acceptable when a majority of the inspected pixels are white.

BLACK: Acceptable when a majority of the inspected pixels are black.

Ex.: When the point to be inspected is 8 X 8 (64 pixels) and WHITE is specified, if 33 white pixels are detected, the point is accepted.

← You can set the output destinations using the up and down keys. (NO, Y0 to Y7, C000 to C127)

← Not displayed for unregistered point numbers.

• When MODE has been set to AVG-GRAYS

EVALUAT COND	SCREEN COND	SAVE	EDIT	SEL	F	C1	DRK
①PAGE CHNG							
②CONDITION SET	REST(+10%)						
③P000	200-210		200	OK			NO
④P001	200-210		200	OK			NO
⑤P002	200-210		200	OK			NO
⑥P003	200-210		200	OK			NO
⑦P004	200-210		200	OK			NO
⑧P005							
⑨P006							
⑩P007							
⑪TEST							

Average light level for each point

← You can set the output destinations using the up and down keys. (NO, Y0 to Y7, C000 to C127)

← Average light level for each point

■ Numeric calculation setting

- Press the TRG/BRT key to move the cursor to the upper function menu, and highlight "COND" using the left and right arrow keys. Press the SET key to show the popup menu. Select "NUM-CALC" from the popup menu.
- Select "NUM-CALC" on the menu tree.
- ⇒ See "Chapter 15: Numeric calculation."

■ Output condition setting

- Press the TRG/BRT key to move the cursor to the upper function menu, and highlight "COND" using the left and right arrow keys. Press the SET key to display the popup menu. Select "OUT" from the popup menu.
- Select "OUT-COND" on the menu tree.
- ⇒ See "Chapter 17: Set the Input/Output Conditions."

■ Display the measurement results

Return to the operation screen and press the TRG/BRT key. The measurement results will be displayed on the screen.

● When MODE has been set to BINARY

Final evaluation result → OK

Measuring time → MEAS XXXXms

Measurement program number → MEASUREMENT 1 POINT-MEAS

Evaluation of the correct black or white color detected at registration No.000 → P000=WHITE OK

001 → P001=WHITE OK

002 → P002=WHITE OK

003 → P003=WHITE OK

004 → P004=WHITE OK

005 → P005=

006 → P006=

007 → P007=

- Areas will not be displayed for unspecified registration numbers.

(TYPE00)
F C1 DRK
V*.**

OK

MEAS XXXXms

MEASUREMENT 1 POINT-MEAS

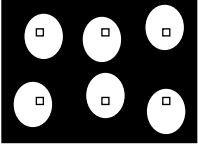

X0~7 00000000 Y0~7 00000000 READY □

MNU-CHG MAIN-COND CHG-MEA COND-CHG CHNG-REG SCREEN-CHG CHG-TYPE

● When MODE has been set to AVG-GRAYS

(TYPE00)
F C1 DRK
V*.**

OK

MEAS XXXXms

MEASUREMENT 1 POINT-MEAS

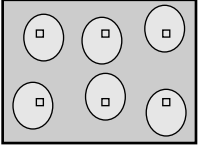

P000=115 OK

P001=120 OK

P002=114 OK

P003=118 OK

P004=116 OK

P005=115 OK

P006=

P007=

X0~7 00000000 Y0~7 00000000 READY □

MNU-CHG MAIN-COND CHG-MEA COND-CHG CHNG-REG SCREEN-CHG CHG-TYPE

Chapter 12: Multiple Positional Measurements

12-1 Outline

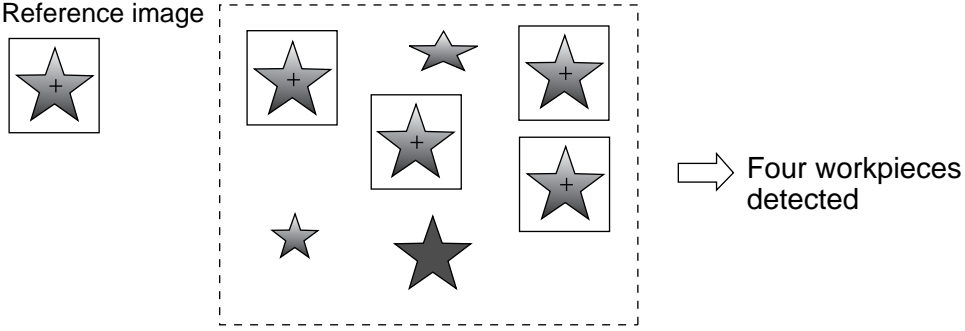
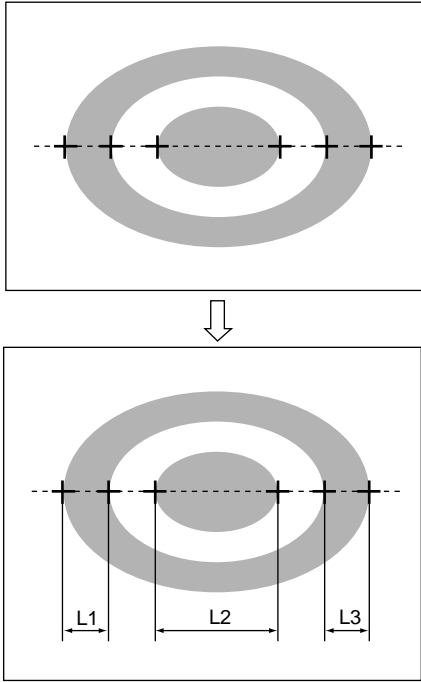
Purpose	<p>The IV-S30 can detect up to 128 workpieces whose images exceed the specified matching level (gray search) or threshold value (edge detection) from the reference image.</p> <ul style="list-style-type: none"> - The positional deviation measurement needs to have a number of positions registered for measurement. However, this measurement only requires you to register one position and reduces the set up time.
Applica-tion	<p>Measure the position of workpieces with a complicated light level that cannot be converted into binary images.</p>
Example	<p>● Gray search</p>  <p>[Measurement results]</p> <ul style="list-style-type: none"> - Number of images detected - Coordinates and degree of match detected for each image <p>● Edge detection</p>  <p>[Measurement results]</p> <ul style="list-style-type: none"> - Number of images detected - Coordinates detected <p>This is useful for obtaining the distance between the coordinates of a position.</p> <ul style="list-style-type: none"> - L1 to L3 can be calculated by measuring distances and angles.

12-2 Setting operation

■ Setting the measurement conditions

● How to enter the measurement conditions setting screen

Select "MAIN-COND" -> "OBJECT TYPE COND" (menu tree)-> "TYPE00" ->"MEA-CND (CAMERA1)" -> "MEAS(NEW)," in that order. Then press the SET key to bring up the "MEAS1" screen.

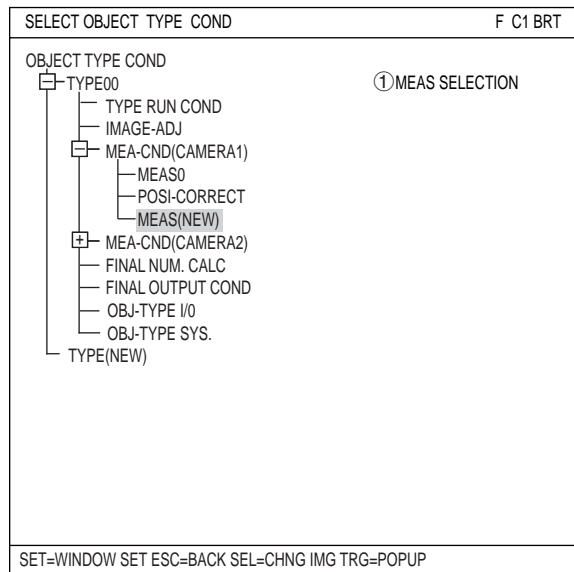

Move to the "①MEAS SELECTION" line on the "MEASUREMENT1" screen and select "MULTI-POSI" from the popup menu.

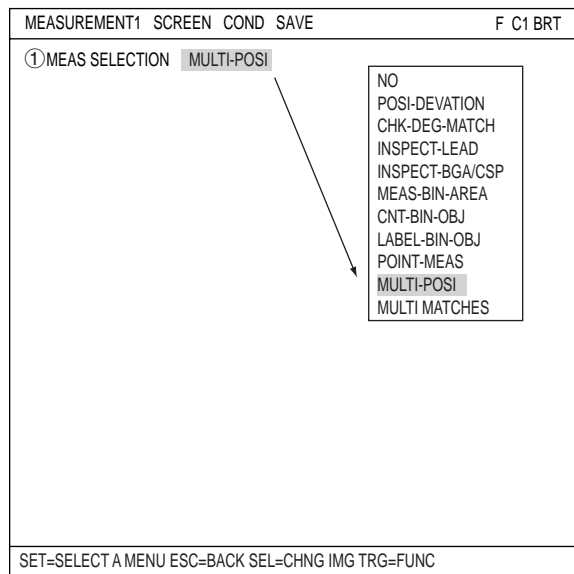

Press the ESC key to return to the "OBJECT TYPE COND" (menu tree) screen, and select the "MEAS CND" item shown under "MEAS01 (MULTI-POSI)" to go to the "MEAS CND" screen.
 ⇨ For details, see "Chapter 8: Setting Examples Using the Menu Tree" in the Introduction and Hardware.

① **DTECT PRECISION**

Select detection precision. You can select one of two levels (standard/high), according to your conditions, the desired precision level for detection results, and the detection speed.
 ⇨ For details, see page 3-10.

② **REGISTER NO.**

4 registers are available for the multiple position measurement (Registers 0 to 3). If you want to set the measurement conditions for a different register number, press the SET key to highlight the register number currently selected. Then press the up and down arrow keys to select the register number whose measurement conditions you want to set. Press the SET key to confirm your selection.

③ **MODE**

Select a mode. The details of each mode are as follows.

NO	No measurement is made.
GRAY-SRC	Uses the gray search function to detect a shape in the captured images that matches the reference image.
EDGE DTECT	Uses the edge detection function to look for shapes in the captured images that have a value larger than the specified threshold value.

④ **DETECT ORDER (when GRAY-SRC is selected)**

When "GRAY-SRC" is selected on line "③MODE," select "SCAN-ORDER" or "MATCH LVL" on the "④DETECT ORDER" line.

SCAN-ORDER (in the order scanned): Searches in the order scanned.

MATCH LVL (degree of match): Searches by comparing levels with the reference image.

REGISTER NO. (⑤DTECT OBJECT)

Shows the specified mode(s) for each register.
 S: gray search E: edge detection X: means no setting

00	01	02	03
S	E	S	X

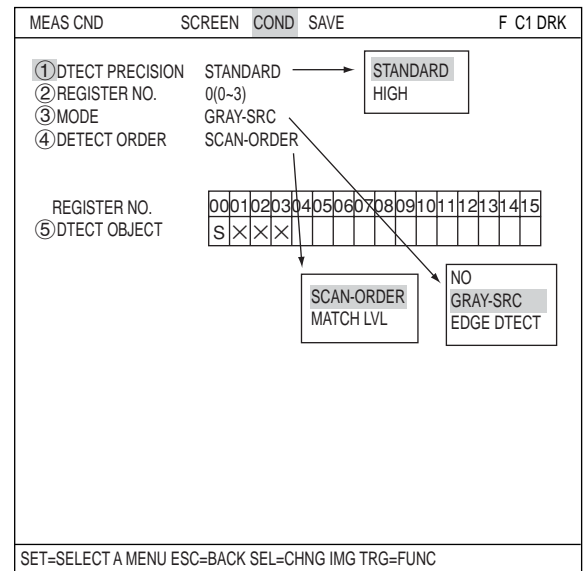

■ How to set the register conditions

● How to enter the REG-COND setting screen

There are three methods for getting to the REG-COND setting screen.

- 1) On the "MEAS CND" setting screen, move the cursor to "⑤DTECT OBJECT" and press the SET key. The cursor will move into the table. Move the cursor to the "S" or "E" column and press the SET key.

Note: If you press the SET key in the "X" column, the setting will be invalid.

About "S" ⇨ See pages 12-5 to 7.

About "E" ⇨ See pages 12-7 to 9.

- 2) On the "MEAS CND" setting screen, press the TRG/BRT key to move the cursor to the upper function menu. Select the "COND" item and then select the "REG-COND(S)" or "REG-COND(E)" item and press the SET key.

About "REG-COND(S)"
⇨ See pages 12-5 to 7.

About "REG-COND(E)"
⇨ See pages 12-7 to 9.

- 3) On the menu tree, move the cursor to the "MEAS CND" item, and press the right arrow key. The sub menu which contains the "REG-COND(S)" and "REG-COND(E)" items will appear. Move the cursor to either of these items and press the SET key.

About "REG-COND(S)"
⇨ See pages 12-5 to 7.

About "REG-COND(E)"
⇨ See pages 12-7 to 9.

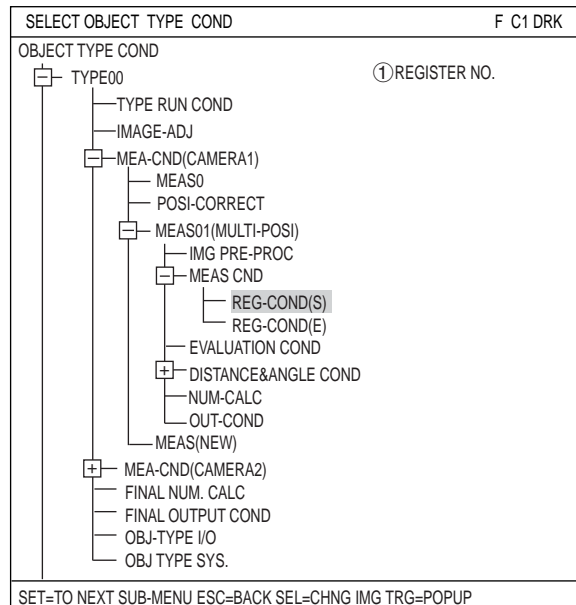
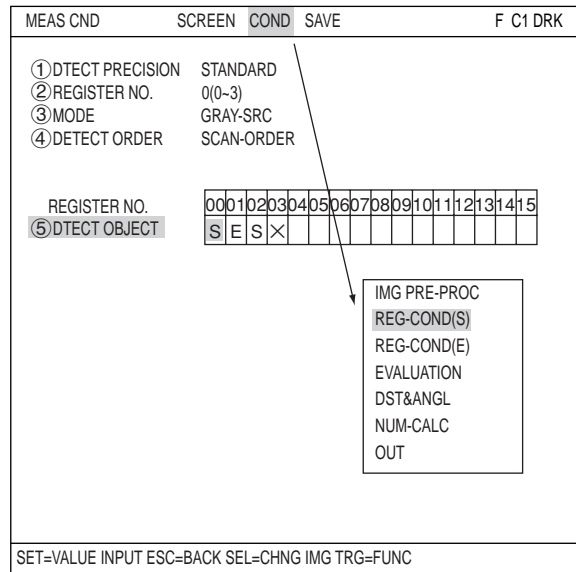

[1] Set the register conditions for a gray search

Set a reference image

Move the cursor to "②REF-IMG AREA" and press the SET key. When the SET item is highlighted, press the SET key again to bring up the setting screen.

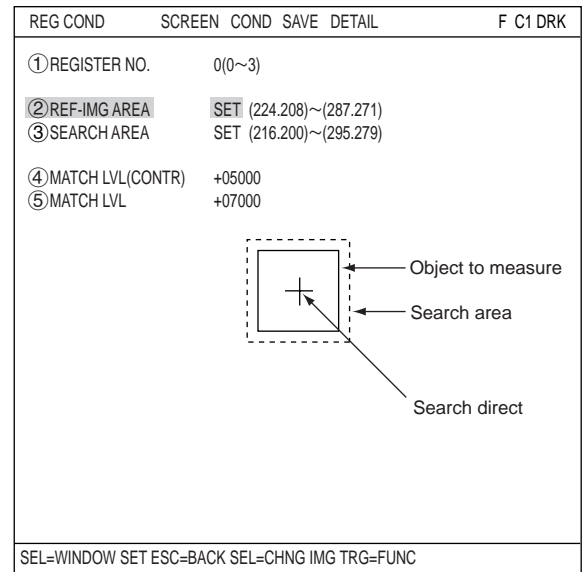

Set the coordinates for "①UP.L" and "② LO.R."
The rectangle inside the solid lines is the reference image.

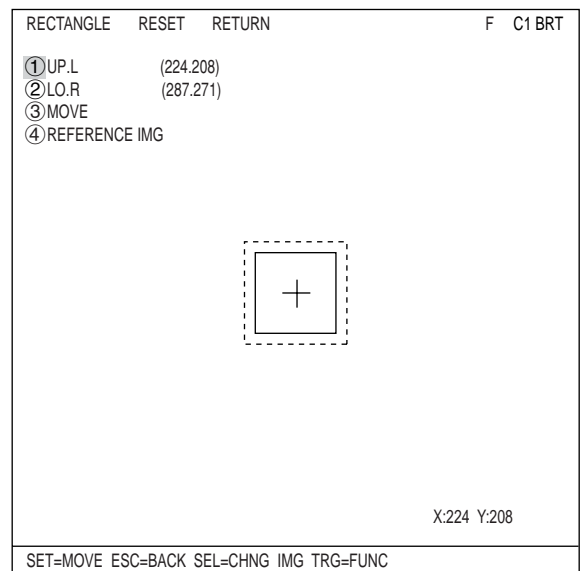

Register a reference image

After setting the reference image area, store an image in the controller as a reference image. Select "④REFERENCE IMG" using the up/down arrow keys and select "REG" from the popup menu.

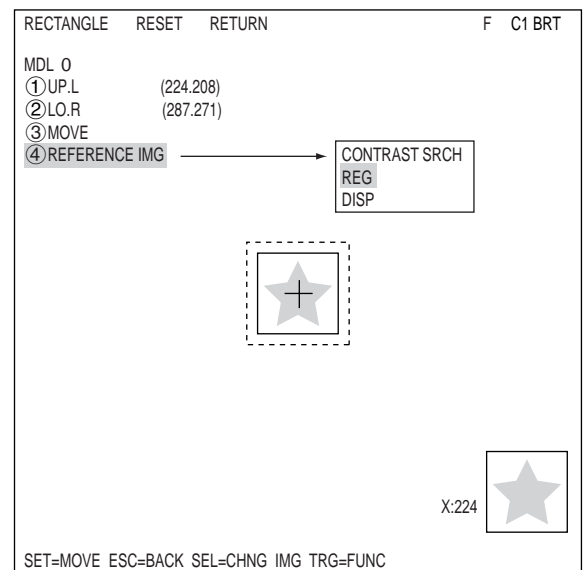

Select a reference image

Move the cursor to the function menu on the "REG COND" screen by pressing the TRG/BRT key. Move the cursor to "DETAIL." Press the SET key on the "REFERENCE IMG" line in the popup menu. The white square on the left will change to a black square. Then, the "②REFERENCE IMG" item will appear on the screen.

You can use the same procedures to show "DETECT CRD" (detection coordinates) and "CONTR.PIXL" (contraction pixels) on the screen.

On the "②REFERENCE IMG" line, select a reference image from the reference images already registered.

Ex : 015 (000 to 026)

Select reference image No. 15 from the 26 registered reference images (000 to 026).

REG COND	SCREEN	COND	SAVE	DETAIL	F C1 BRT
① REGISTER NO.		0(0~3)			
② REFERENCE IMG		015(000-026)			
③ REF-IMG AREA		SET (224.208)~(287.271)			
④ SEARCH AREA		SET (216.200)~(295.279)			
⑤ DIRECT COORD		CENTER (234.219)			
⑥ CONTR.PIXEL		3			
⑦ MATCH LVL(CONTR)		+05000			
⑧ MATCH LVL		+07000			

※ Make to on the popup menu, the respective item will be added to the "REG COND" menu.

SEL=VALUE INPUT ESC=BACK SEL=CHNG IMG TRG=FUNC

④ SEARCH ARE

Specify the search area (inside the dotted lines) on the "④SEARCH AREA (MDL0)" line, using the same procedures used for setting the reference image area.

■ An example

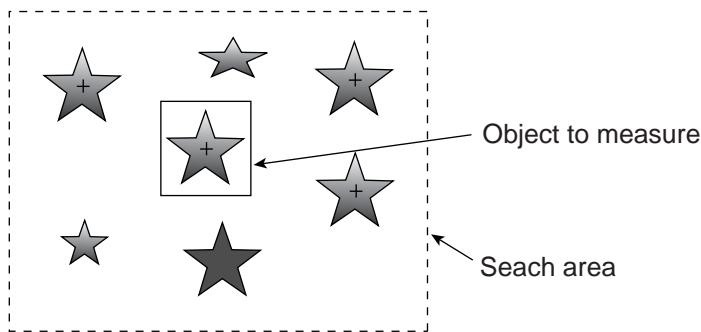

⑤ DTECT COORD (detection coordinates)

Select whether to use the detection coordinates as the center of the reference area or to allow the point to be set freely.

⑥ CONTR.PIXEL (contraction pixels)

- 1: Search the image in units of 2 pixels.
- 2: Search the image in units of 4 pixels.
- 3: Search the image in units of 8 pixels.

REG COND	SCREEN	COND	SAVE	DETAIL	F C1 BRT
① REGISTER NO.		0(0~3)			
② REFERENCE IMG		015(000-026)			
③ REF-IMG AREA		SET (224.208)~(287.271)			
④ SEARCH AREA		SET (216.200)~(295.279)			
⑤ DTECT COORD		CENTER (234.219)		CENTER SET	
⑥ CONTR.PIXEL		3			
⑦ MATCH LVL(CONTR)		+05000			
⑧ MATCH LVL		+07000			

SEL=WINDOW SET ESC=BACK SEL=CHNG IMG TRG=FUNC

Set degree of match

- ⑦ **MATCH LVL (CONTR)**
Specify the degree of match used for detection in the contracted images (detects contracted shapes in images whose value is larger than the specified reference value).
- ⑧ **MATCH LVL**
Specify a degree of match used for detection in the original images of the contracted images that were detected in the search at line "⑦MATCH LVL" (detects original images which are larger than the specified value).

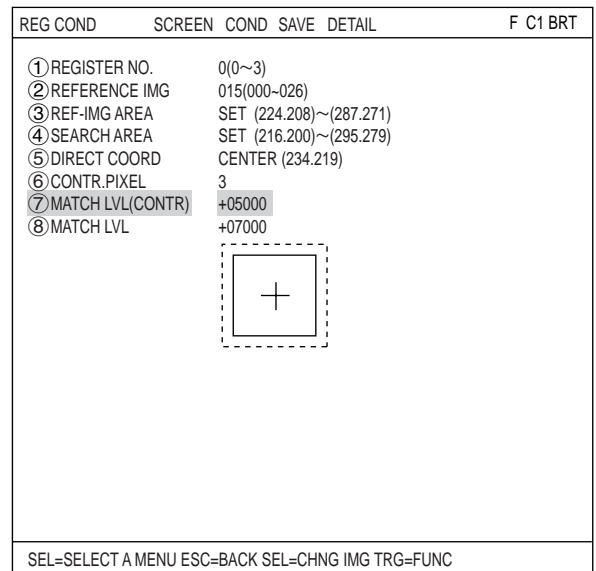

[2] Setting the register conditions for edge detection

- ② **MEAS SHAPE**
Select a measurement shape.
 - RECTANGLE (NO ARTF)
 - RECTANGLE (ARTIF)
 - LINE (straight line)
 - CIRC-L (circle)
 - ELIP-L (ellipse)

Select a pattern to be used for image processing.
⇒ See pages 3-5 to 3-9.
- NO ARTF/ARTIF: Select whether to detect edge or not with average density.
⇒ See page 3-16.

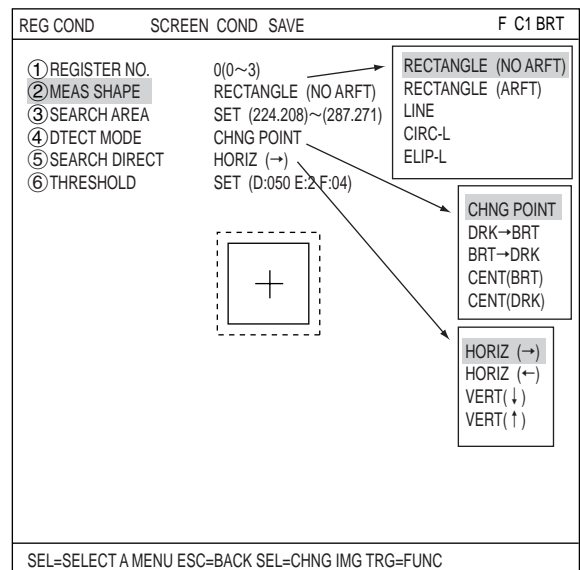

③ SEARCH AREA

Select "③SEARCH AREA" and press the SET key to go to the setting screen.

- When "RECTANGLE" is selected
 Highlight "①UP.L" and press the SET key. The X and Y axes will appear in the search area. Move the X/Y axes using the up/down/left/right arrow keys to identify the upper left corner. When correct, press the SET key.
 - To return to the previous coordinates, press the ESC key.
 Next, highlight "②LO.R" and press the SET key. Identify the lower right corner the same way.

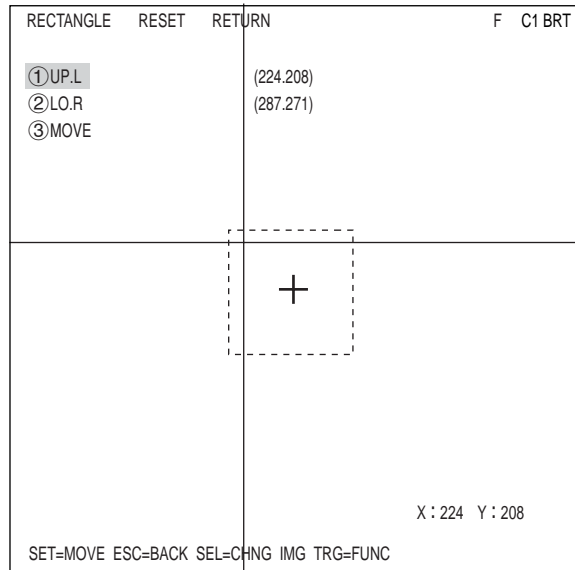

④ DTECT MODE

Select an image processing method for the edges.

- CHNG POINT
- DRK → BRT
- BRT → DRK
- CENT (BRT)
- CENT (DRK)

⇒ See page 3-15.

⑤ SEARCH DIRECT

Specify a search direction. The direction for searching varies with each detection shape.

● When "RECTANGLE" is selected

Horizontal (→)	Scan the reference line from left to right (→)
Horizontal (←)	Scan the reference line from left to right (←)
Vertical (↓)	Scan the reference line from top to bottom (↓)
Vertical (↑)	Scan the reference line from bottom to top (↑)

● When "LINE" is selected

Start point → End point	Scan along a straight line from the starting point to the end point
End point → Start point	Scan along a straight line from the end point to the starting point

● When "CIRC-L" or "ELIP-L" is selected

Clockwise direction	Scan around the circumference clockwise
Counter-clockwise direction	Scan around the circumference counter-clockwise

⇒ For details, see page 3-15.

⑥ THRESHOLD

Enter the threshold value for binary conversion. Move the cursor to "⑥THRESHOLD" and press the SET key. Then highlight the "SET" position on this line and press the SET key and the "REG COND" setting screen will appear.

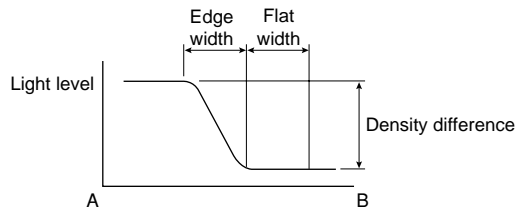

Automatic setting

Select "AUTO-REG" from the upper function menu on the THRESHOLD setting screen. The controller will set the optimum value automatically.

● Example of register

Shown below is an example detected with "②MEAS SHAPE" set to "LINE," and "④DETECT MODE" set to "CHNG POINT."

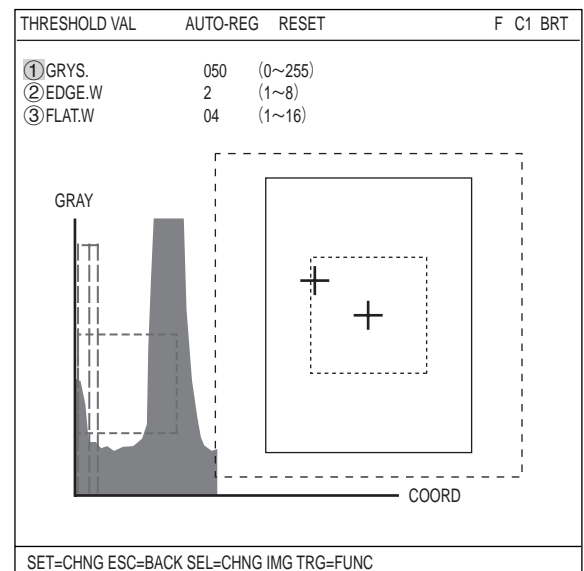
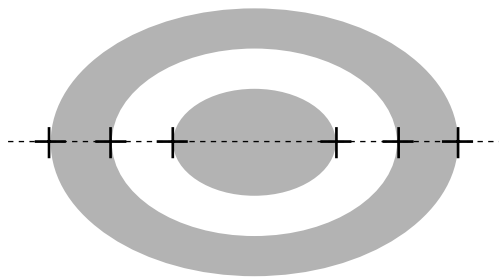

■ Set the evaluation conditions

● How to move to the evaluation condition setting screen

There are two methods for getting to the evaluation condition setting screen.

- 1) Select "COND" in the upper function menu on the "MEAS COND (or REG COND)" screen and press the SET key. Select "EVALUATION" on the pop up menu to go to the "EVALUAT COND" screen.

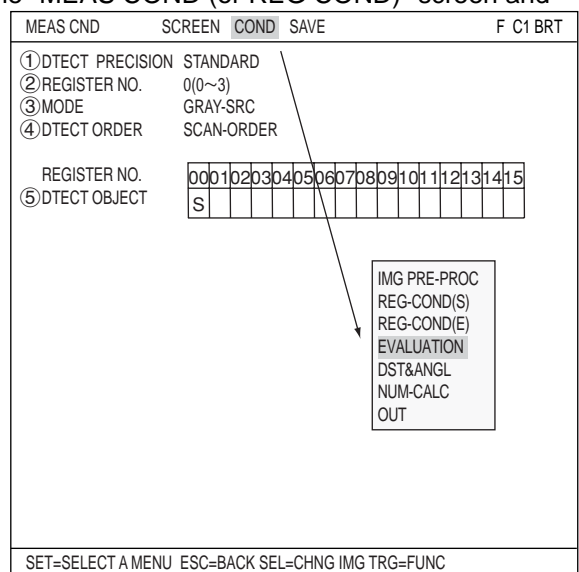

- 2) Move the cursor to the "EVALUATION COND" item on the Menu tree screen and press the SET key.

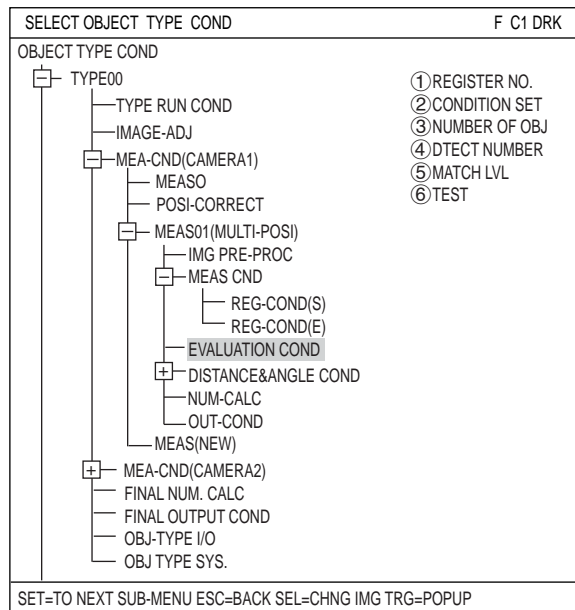

The "EVALUAT COND"(evaluation conditions) screen will appear.

⇒ For details about the evaluation conditions, see page 3-18.

- When "GRAY-SRC" is selected on line "③ MODE."

EVALUAT COND	SCREEN COND	SAVE	EDIT	SEL	F C1 BRT
① REGISTER NO.	0(0-3)			[TEST RESULT]	[OUTPUT]
② CONDITION SET	AUTO(-10%)				
③ NUMBER OF OBJ	000-128	K=			NO
④ DTECT NUMBER	000-(0-000)				
⑤ MATCH LVL	-10000~+10000	M0=			NO
X COORD.	X0=				
Y COORD.	Y0=				
⑥ TEST	EXEC(WITH-POSI.ADJ WITHOUT-POSI.ADJ)				

- When "EDGE DTECT" is selected on line "③ MODE."

EVALUAT COND	SCREEN COND	SAVE	EDIT	SEL	F C1 BRT
① REGISTER NO.	0(0-3)			[TEST RESULT]	[OUTPUT]
② CONDITION SET	AUTO(-10%)				
③ NUMBER OF OBJ	000-128	K=			NO
④ DTECT NUMBER	000-(0-000)				
X COORD.	X0=				
Y COORD.	Y0=				
⑤ TEST	EXEC(WITH-POSI.ADJ WITHOUT-POSI.ADJ)				

■ Numeric calculation setting

- Press the TRG/BRT key to move the cursor to the upper function menu, and highlight "COND" using the left and right arrow keys. Press the SET key to show the popup menu. Select "NUM-CALC" from the popup menu.
- Select "NUM-CALC" on the menu tree.
- ⇒ See "Chapter 15: Numerical calculations."

■ Output condition setting

- Press the TRG/BRT key to move the cursor to the upper function menu, and highlight "COND" using the left and right arrow keys. Press the SET key to display the popup menu. Select "OUT" from the popup menu.
- Select "OUT-COND" on the menu tree.
- ⇒ See "Chapter 17: Setting the Input/Output Conditions."

■ Display the measurement results

Return to the operation screen and press the TRG/BRT key. The measurement results will be displayed on the screen.

● An example of the display when "gray search" is selected.

Final evaluation result → OK

Measuring time → MEAS XXXXms 2001-10-14 10:38

Measuring program number → MEASUREMENT 1 MULTI-POSI

Register number → REGISTER NO.0(0~3)

Number of detected images → K=004 OK

Numbered in the order detected (range) → DETECT NO.000(000~003)

*1 [Degree of match → M=+09870 OK

[Detected point coordinates → X=236.0
Y=163.0

- Move the cursor to CHG-REG (change register)" and press the up key. The measurement result display will change in the following order: Register No. 0 (detection No. 000 fi 001 fi (ooo) fi (ooo) fi Register No. 3 (ooo) fi Register No. 0 (ooo) fi (ooo), and so will the measurement screen. Press the down key to change the display, moving through the items in reverse order.

(TYPE00) F C1 BRT
V*.**

OK

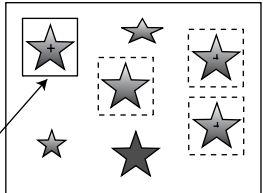

*2

X0~7 [] [] [] [] [] [] [] [] Y0~7 [] [] [] [] [] [] [] [] READY []

MNU-CHG MAIN-COND CHG-MEA COND-CHG CHNG-REG SCREEN-CHG CHG-TYPE

* 1 The detection order can be set to either "SCAN-ORDER " or "MATCH LVL" on item "④ DETECT ORDER" on the "MEAS CND" screen. ⇨ See page 12-3.

* 2 The inspection number corresponds to the image of the solid line.

● An example of the display when "gray search" is selected.

Register number → REGISTER NO

Number of points detected → K=006 OK

Numbered in the order detected (range)*3 → DTECT NO.000(000~005)

[Detected point coordinate.] → X=102.0
Y=257.0

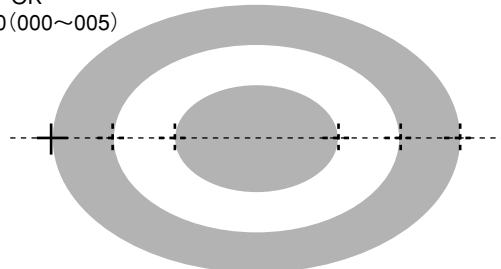

*3 Coordinates of the detected point.

Chapter 13: Multiple Degree of Match Inspection

13-1 Outline

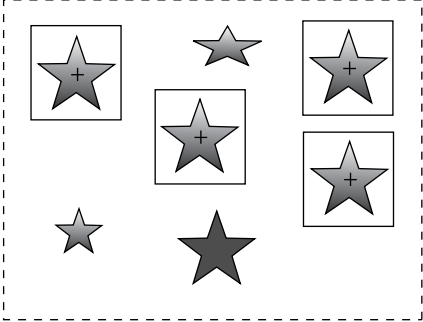
Purpose	Using the gray search function, the IV-S30 can detect up to 128 workpieces whose captured image exceeds the required degree of match with the reference image.
Applica-tion	Inspect (or count) workpieces that have complicated light level and cannot be converted into binary. images
Exam-ple	<div style="display: flex; align-items: center; justify-content: space-around;"> <div style="text-align: center;"> <p>Reference image</p>  </div> <div style="border: 1px dashed gray; padding: 10px; display: flex; flex-wrap: wrap; justify-content: space-around;">  </div> <div style="text-align: center;"> <p>⇒ Four workpieces detected</p> </div> </div> <p>[Measurement results]</p> <ul style="list-style-type: none"> - Number of images detected - Degree of match, density (average/absolute difference), and detected coordinates

13-2 Setting operation

■ Setting the measurement conditions

● How to enter the measurement conditions setting screen

Select "MAIN-COND" -> "OBJECT TYPE COND" (menu tree)-> "TYPE00" -> "MEA-CND (CAMERA1)" -> "MEAS(NEW)," in that order. Then press the SET key to bring up the "MEAS1" screen.

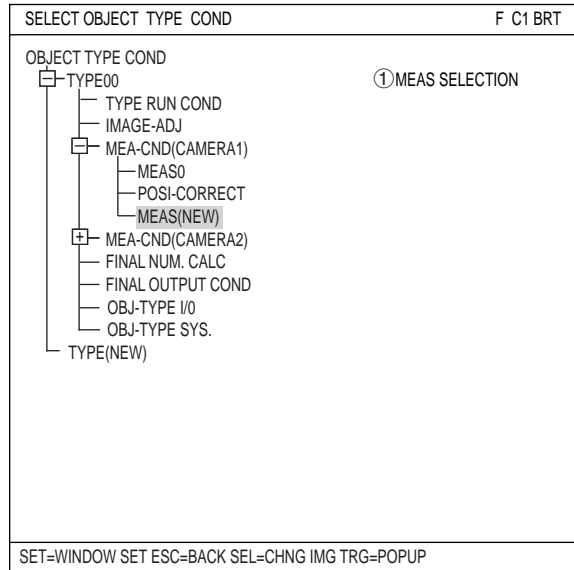

Move to the "①MEAS SELECTION" line on the "MEASUREMENT1" screen and select "MULTI MATCHES" from the popup menu.

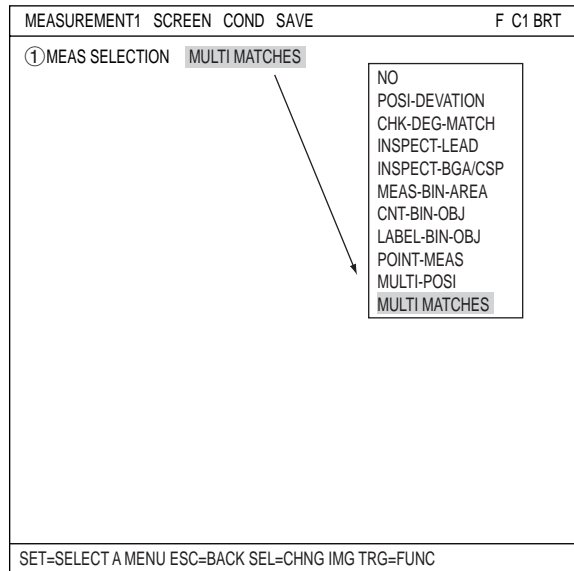

Press the ESC key to return to the "OBJECT TYPE COND" (menu tree) screen, and select the "MEAS CND" item shown under "MEAS01 (MULTI MATCHES)" to go to the "MEAS CND" screen.

⇒ For details, see "Chapter 8: Setting Examples Using the Menu Tree" in the Introduction and Hardware.

① **DTECT PRECISION**

Select detection precision. You can select one of two levels (standard/high), according to your conditions, the desired precision level for detection results, and the detection speed.
 ⇨ For details, see page 3-10.

② **REGISTER NO.**

4 registers are available for the multiple degree of match inspection (Registers 0 to 3). If you want to set the measurement conditions for a different register number, press the SET key to highlight the register number currently selected. Then press the up and down arrow keys to select the register number whose measurement conditions you want to set. Press the SET key to confirm your selection.

③ **MODE**

Select detection precision.

④ **MATCHING**

Select a density for comparison when inspecting the image. The details are as follows.

	Description
Average light level	Obtain average light level of the image in the area detected using the gray search.
Difference absolute value	Calculate the difference of the absolute values from the image detected using the gray search and the reference image. The result is light level difference. By obtaining this value, you can get an idea of the total change in light level. Total light level difference = S (Ni — Nt) Ni : Light level of the captured image (contraction 3) Nt : Light level of the reference image (contraction 3)

⑤ **DETECT ORDER**

Select "SCAN-ORDER" or "MATCH LVL" on the "⑤DETECT ORDER" line.

SCAN-ORDER (in the order scanned): Searches in the order scanned.

MATCH LVL (degree of match): Searches by comparing levels with the reference image.

⑥ **DTECT OBJECT**

"S" will be displayed for the objects to be detected.

00	01	02	03
S	×	×	×

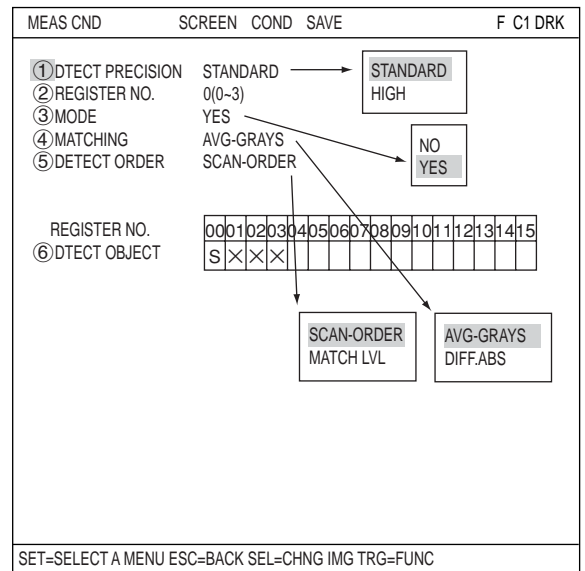

How to set the register conditions

How to enter the REG-COND setting screen

There are three methods for getting to the REG-COND setting screen.

- 1) On the "MEAS CND" setting screen, move the cursor to the "⑥DETECT OBJECT" and press the SET key. The cursor will move into the table. Move the cursor to the "S" column and press the SET key.

Note: If you press the SET key in the "X" column, the setting will be invalid.

- 2) On the "MEAS CND" setting screen, press the TRG/BRT key to move the cursor to the upper function menu. Select the "COND" item and then select the "REG COND" item and press the SET key.

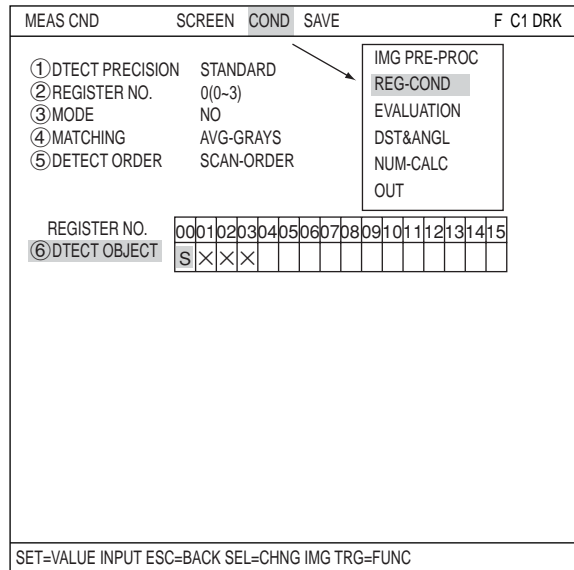

- 3) On the menu tree, move the cursor to the "MEAS CND" item, and press the right arrow key. The sub menu which contains the "REG COND" item will appear. Move the cursor to this item and press the SET key.

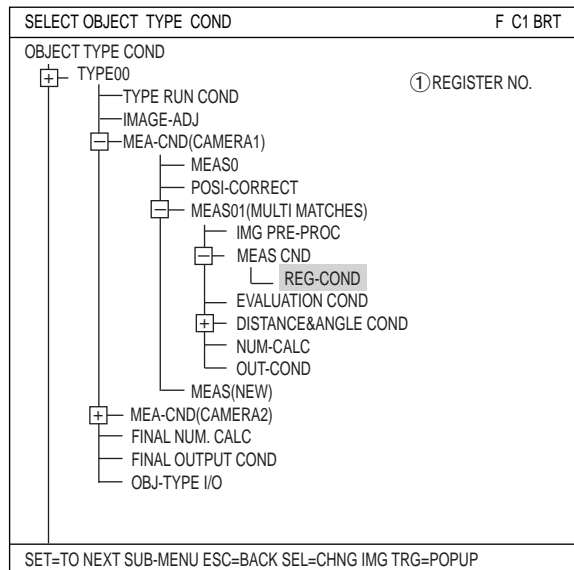

Register a reference image

After setting the reference image area, store an image in the controller as a reference image.

Select "②REF-IMG AREA" using the up/down arrow keys and select "REG" from the popup menu.

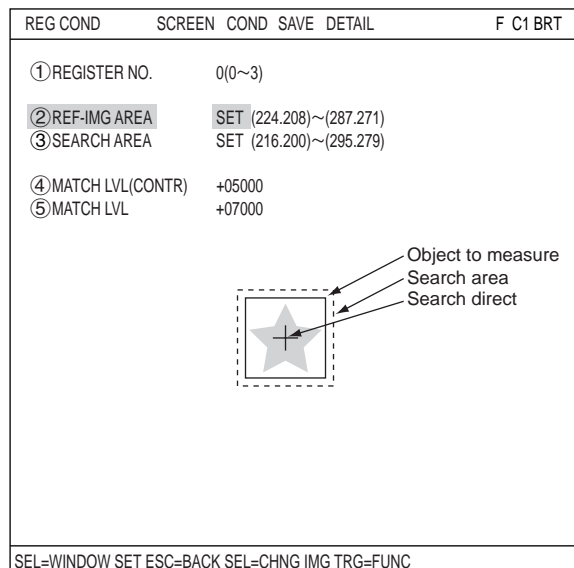

Set the coordinates for "①UP.L" and "②LO.R." The rectangle inside the solid lines is the reference image.

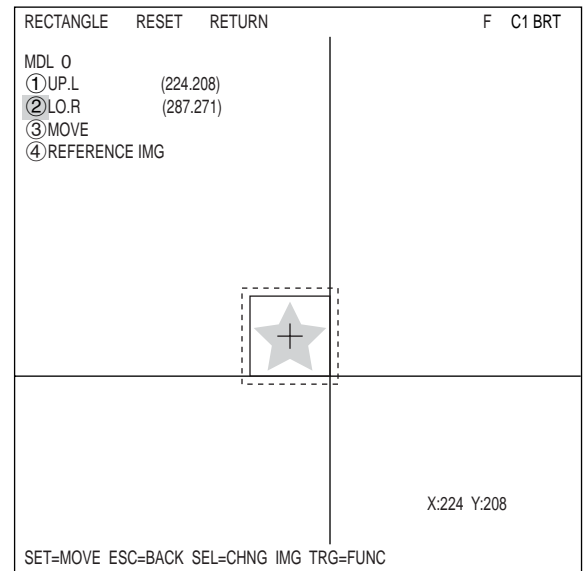

Register a reference image

After setting the reference image area, store an image in the controller as a reference image. Select "④REFERENCE IMG" using the up/down arrow keys and select "REG" from the popup menu.

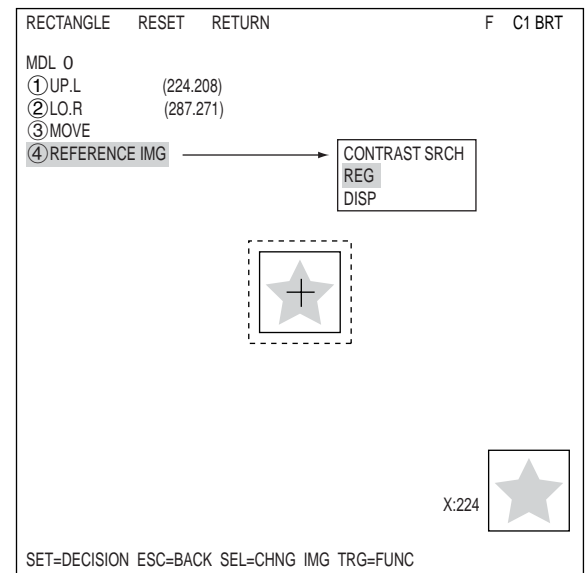

Select a reference image

Move the cursor to the function menu on the "REG COND" screen by pressing the TRG/BRT key. Move the cursor to "DETAIL." Press the SET key on the "REFERENCE IMG" line in the popup menu. The white square on the left will change to a black square. Then, the "②REFERENCE IMG" item will appear on the screen.

On the "②REFERENCE IMG" line, select a reference image from the reference images already registered.

Ex : 015 (000 to 026)

Select reference image No. 15 from the 26 registered reference images (000 to 026).

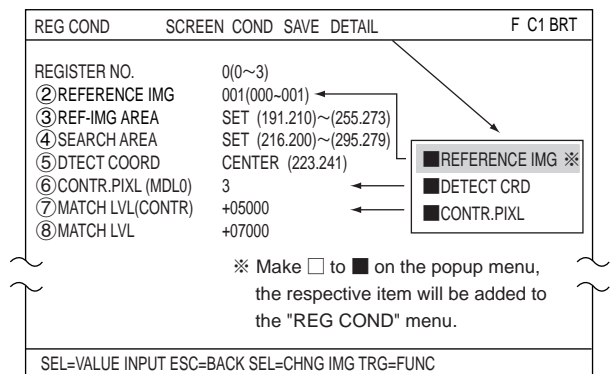

④ SEARCH AREA

Specify the search area (inside the dotted lines) on the "④SEARCH AREA" line, using the same procedures used for setting the reference image area.

■An example

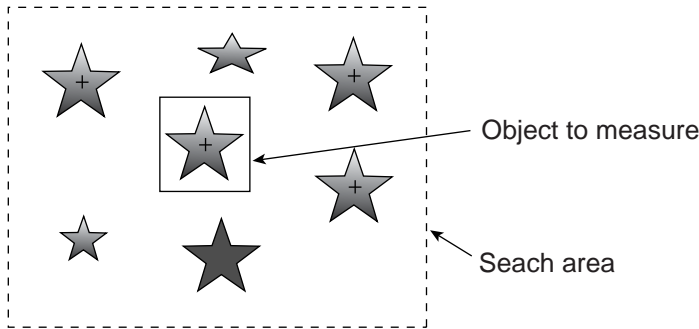

⑤ DTECT COORD (detection coordinates)

Select whether to use the detection coordinates as the center of the reference area or to allow the point to be set freely.

CENTER: The center of the rectangular area will automatically be used for the detection coordinates.

SET: You can specify any position in the rectangular area to be used for the detection coordinates.

REG COND	SCREEN COND	SAVE	DETAIL	F C1 BRT
① REGISTER NO.	0(0~3)			
② REFERENCE IMG	015(000-026)			
③ REF-IMG AREA	SET (224.208)~(287.271)			
④ SEARCH AREA	SET (216.200)~(295.279)			
⑤ DTECT COORD	CENTER (223.241)		→ CENTER SET	
⑥ CONTR.PIXEL	3			
⑦ MATCH LVL(CONTR)	+05000			
⑧ MATCH LVL	+07000			

SEL=WINDOW SET ESC=BACK SEL=CHNG IMG TRG=FUNC

Set degree of match

⑦ MATCH LVL (CONTR)

Specify the degree of match used for detection in the contracted images (detects contracted shapes in images whose value is larger than the specified reference value).

⑧ MATCH LVL

Specify a degree of match used for detection in the original images of the contracted images that were detected in the search at line "⑦MATCH LVL" (detects original images which are larger than the specified value).

■ Set the evaluation conditions

● How to move to the evaluation condition setting screen

There are two methods for getting to the evaluation condition setting screen.

- 1) Select "COND" in the upper function menu on the "MEAS COND (or REG COND)" screen and press the SET key. Select "EVALUATION" on the pop up menu to go to the "EVALUAT COND" screen.

MEAS COND	SCREEN	COND	SAVE	F C1 BRT
① DTECT PRECISION	STANDARD			
② REGISTER NO.	0(0-3)			
③ MODE	YES			
④ MATCHING	AVG-GRAYS			
⑤ DETECT ORDER	SCAN-ORDER			
REGISTER NO.	00010203040506070809101112131415			
⑥ DTECT OBJECT	S X X X			
SET=VALUE INPUT ESC=BACK SEL=CHNG IMG TRG=FUNC				

- 2) Move the cursor to the "EVALUATION COND" item on the menu tree screen and press the SET key.

SELECT OBJECT TYPE COND	F C1 BRT
	① REGISTER NO. ② CONDITION SET ③ NUMBER OF OBJ ④ DTECT NUMBER ⑤ MATCH LVL ⑥ GRAY LVL ⑦ TEST
SET=TO NEXT SUB-MENU ESC=BACK SEL=CHNG IMG TRG=POPUP	

The "EVALUAT COND"(evaluation conditions) screen will appear.

- ⇒ For details about the evaluation conditions, see page 3-18.

EVALUAT COND	SCREEN	COND	SAVE	EDIT	SEL	F C1 BRT
① REGISTER NO.	0COND.1	[TEST RESULT]	[OUTPUT]			
② CONDITION SET	AUTO(-10%)					
③ NUMBER OF OBJ	000-128	K=	NO			
④ DTECT NUMBER	000-(0-000)					
⑤ MATCH LVL	-10000--+1000	M0=	NO			
⑥ GRAY LVL	000.0-255.0	G0=	NO			
X COORD.		X0=				
Y COORD.		Y0=				
⑦ TEST	EXEC(WITH-POSI.ADJ WITHOUT-POSI.ADJ)					
SET=VALUE INPUT ESC=BACK SEL=CHNG IMG TRG=FUNC						

■ **Numeric calculation setting**

- Press the TRG/BRT key to move the cursor to the upper function menu, and highlight "COND" using the left and right arrow keys. Press the SET key to show the popup menu. Select "NUM-CALC" from the popup menu.
- Select "NUM-CALC" on the menu tree.
- ⇒ See "Chapter 15: Numerical calculations."

■ **Output condition setting**

- Press the TRG/BRT key to move the cursor to the upper function menu, and highlight "COND" using the left and right arrow keys. Press the SET key to display the popup menu. Select "OUT" from the popup menu.
- Select "OUT-COND" on the menu tree.
- ⇒ See "Chapter 17: Setting the Input/Output Conditions."

■ **Display the measurement results**

Return to the operation screen and press the TRG/BRT key. The measurement results will be displayed on the screen.

■ **Display example**

Final evaluation result → OK

Measuring time → MEAS XXXXms 2001-10-14 10:38

Measuring program number → MEASUREMENT 1 MULTI-MATCHES

Register number → REG.NO (0~3)

Number of detected images → K=004 OK

Numbered in the order detected (range) → DTECT NO.000(000~003)

 Degree of match → M=+09870 OK

 Light level (average/absolute value) → G=228.3

 Detected coordinate → X=236.0
Y=163.0

X0~7 Y0~7 READY

MNU-CHG MAIN-COND CHG-MEA COND-CHG CHNG-REG SCREEN-CHG CHG-TYPE

Chapter 14: Distance and Angle Measurement

14-1 Outline

You can specify the settings for distance and angle measurement on the "MEAS COND" menu in the positional deviation measurement, degree of match inspection, object identification by binary conversion (select "YES" for center of gravity measurement), multiple position measurement, and multiple degree of match inspection.

⇒ page 4-3, 5-4, 10-5, 12-4, and 13-4

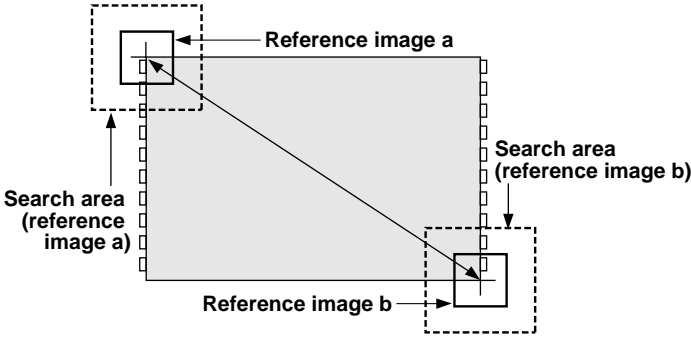
Purpose	<p>The distance and angle of the centers of the detected points can be measured using the center detection function and the edge detection function in a gray scale search and the center of gravity detection function, which is a part of the labeling process.</p> <ul style="list-style-type: none"> - This function can measure the following distances and angles: distance between two points, X coordinate distance, Y coordinate distance, the angle between three points, the horizontal angle of two points, and the vertical angle of two points. - The following points and lines can be set: center point, circle center point, gravity center, point where two straight lines cross, line passing through two points.
Applications	Measurement for installed electronic components
Examples	<p>[Measuring an IC package]</p>  <p>Reference images a and b are recorded when the crosshair cursor is placed on the edge of the IC package.</p> <p>- Measuring sequence</p> <ol style="list-style-type: none"> ① Obtain the center points of images a and b by running a 2 point gray scale search. ② Determine the distance between the two center points.

- For details about measuring the distance between two points, X coordinate distance, and Y coordinate distance manually, see the MANL-MEAS (manual measurement) section (page 2-13) for the crosshair cursor display.

14-2 Setting operation

■ Setting distance and angle conditions

Select "MAIN-COND" -> "OBJECT TYPE COND" (menu tree) -> "TYPE00" -> "MEA-CND (CAMERA1)" -> "MEAS (NEW)," in that order. Then press the SET key to bring up the "MEAS1" screen.

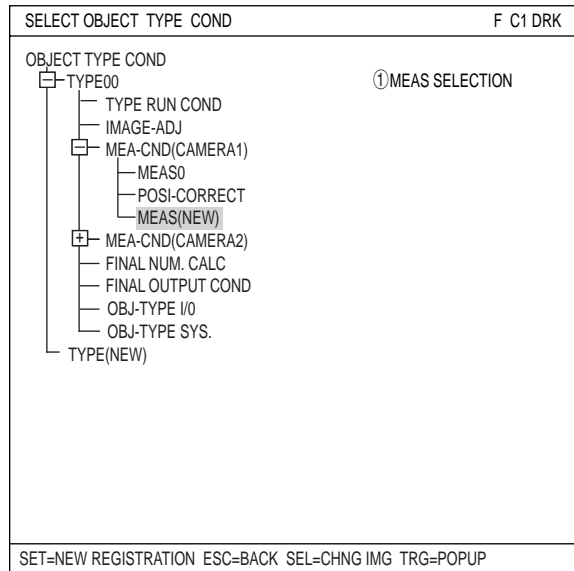

Move to the "① MEAS SELECTION" line on the "MEASUREMENT1" screen and select any of "POSI-DEVIATION," "CHK-DEG-MATCH," "LABEL-BIN-OBJ," "MULTI-POSI," or "MULTI MATCHES" from the popup menu.

⇒ For details, see "Chapter 8: Setting Examples Using the Menu Tree" in the Introduction and Hardware.

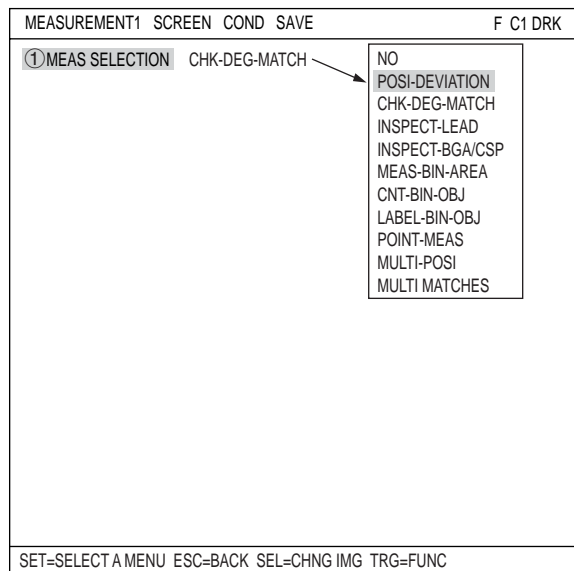

● **How to display the distance and angle conditions setting screen**

There are two methods for displaying the distance and angle conditions setting screen.

- 1) On the "MEASUREMENT 1", "MEAS CND", or "REG COND" screen, press the TRG/BRG key to move the cursor to the upper function menu. Select "COND" using the left and right keys and press the SET key. Select "DST&ANGL" from the popup menu.

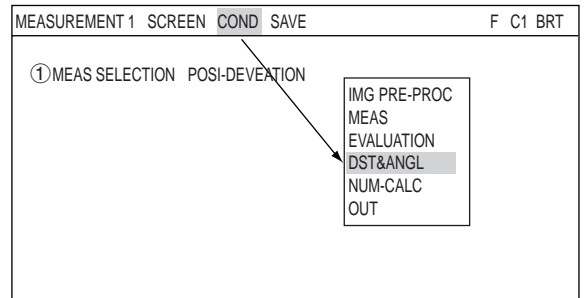

- 2) On the SELECT OBJECT TYPE COND screen, select "TYPE00" -> "MEA-CND(CAMERA1)" -> "MEAS01(POSI-DEVIATION)" -> "DISTANCE&ANGLE COND," in that order.

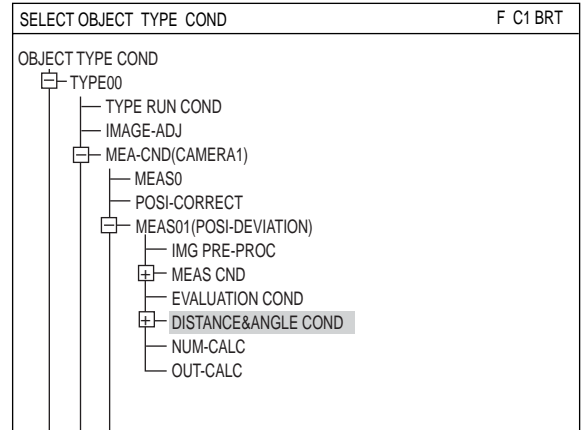

● **Setting the distance and angle conditions**

- ① **OBJ**
Select object type you want to measure. The object types available are: "AUX" (auxiliary), "DST" (distance), and "ANGL" (angle). The setting details are different for each type.
⇒ "AUX": See page 14-4.
"DST": See page 14-6.
"ANGL": See page 14-7.

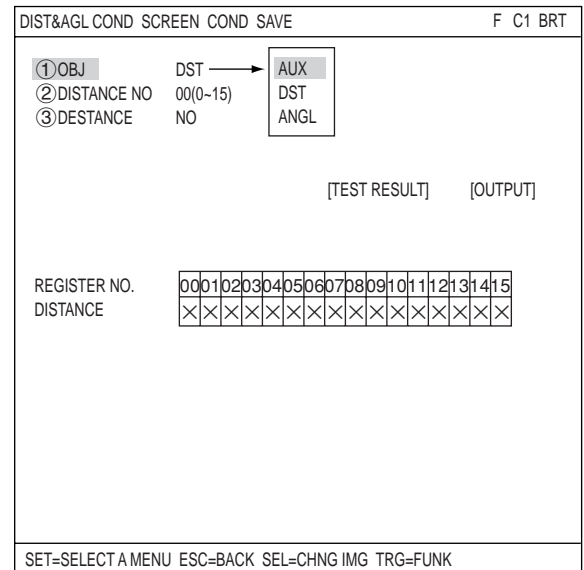

[1] When "AUX" is selected.

② AUXILIARY NO.

Enter a register number. The register numbers available are 0 to 15.

③ AUXILIARY

Select an auxiliary point.

DIST&AGL COND SCREEN COND SAVE		F C1 BRT	
① OBJ	AUX	NO	
② AUXILIARY NO.	01(0-15)	MID-PNT	
③ AUXILIARY	CIRC-C →	CIRC-C	
④ COND.1	REG NO MDL 0	GRAV	
⑤ COND.2	REG NO MDL 0	LINE-2P	
⑥ COND.3	REG NO MDL 0	INTERSECTN	
		[TEST RESULT]	[OUTPUT]
⑦ AUX JUDGEMENT1	000.0-511.0	X=	NO
⑧ AUX JUDGEMENT2	000.0-479.0	Y=	
⑨ RUN A TEST	EXEC		
REGISTER NO.	00010203040506070809101112131415		
AUX.	○ × × × × × × × × × × × × × × × ×		

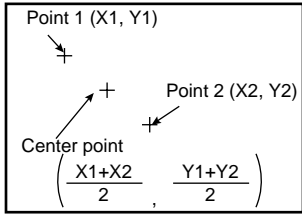
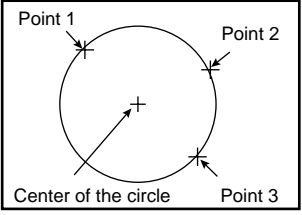
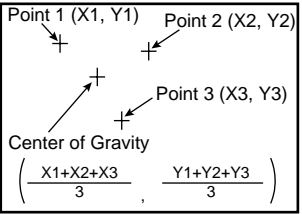
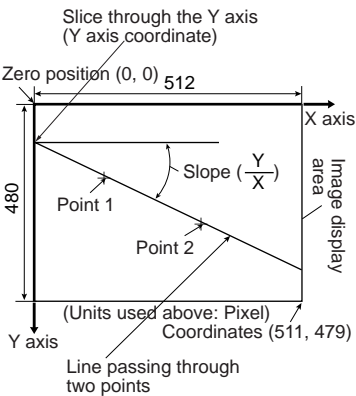
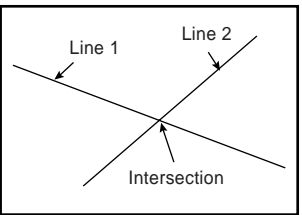
Selection	Description	Measurement position	Display on the screen
NO	Do not select auxiliary point.	_____	_____
MID-PNT	The center point is the coordinate half way between points 1 and 2 that are specified on ④ and ⑤ (COND. 1 and 2).		③AUXILIARY MID-PNT ④COND.1 REG NO MDL 0 ⑤COND.2 REG NO MDL 0 [TEST RESULT] [OUTPUT] ⑥AUX JUDGEMENT1 000.0-511.0 X= NO ⑦AUX JUDGEMENT2 000.0-479.0 Y= ⑧RUN A TEST EXEC
CIRC-C	The center of the circle is the central coordinate of three points positioned on the circumference of the circle that are specified between ④ and ⑥ (conditions 1 to 3).		③AUXILIARY CIRC-C ④COND.1 REG NO MDL 0 ⑤COND.2 REG NO MDL 0 ⑥COND.3 REG NO MDL 0 [TEST RESULT] [OUTPUT] ⑦AUX JUDGEMENT1 000.0-511.0 X= NO ⑧AUX JUDGEMENT2 000.0-479.0 Y= ⑨RUN A TEST EXEC
GRAV	the center of gravity between points 1 to 3 that are specified between ④ and ⑥ is calculated as the mean of the three coordinates (conditions 1 to 3).		③AUXILIARY GRAV ④COND.1 REG NO MDL 0 ⑤COND.2 REG NO MDL 0 ⑥COND.3 REG NO MDL 0 [TEST RESULT] [OUTPUT] ⑦AUX JUDGEMENT1 000.0-511.0 X= NO ⑧AUX JUDGEMENT2 000.0-479.0 Y= ⑨RUN A TEST EXEC
LINE-2P	The line passing through two points is the line that passes through points 1 and 2 specified in items ④ and ⑤ (COND.1/2). In this system, the angle of the slope is referred to as a negative angle if it is W from the horizontal (X axis), and as a positive angle if it is CCW from the horizontal (X axis).		③AUXILIARY LINE-2P ④COND.1 REG NO MDL 0 ⑤COND.2 REG NO MDL 0 [TEST RESULT] [OUTPUT] AUX.1:SLOPE ANGL 000.0-511.0 d1= AUX.2:Y INDENT 000.0-479.0 Y= ⑥RUN A TEST EXEC
INTERS-ECTN	The intersection of two lines is the point where lines 1 and 2, specified in items ④ and ⑤ (COND.1/2), cross.		③AUXILIARY INTERSECTN ④COND.1 AUX NO ⑤COND.2 AUX NO [TEST RESULT] [OUTPUT] ⑥AUX JUDGEMENT1 000.0-511.0 X= NO ⑦AUX JUDGEMENT2 000.0-479.0 Y= ⑧RUN A TEST EXEC

④ COND. 1, ⑤ COND. 2, (⑥ COND.3)

Specify conditions for the auxiliary points that were selected in the "③AUXILIARY" item.

■ How to enter COND.1 and COND.2.

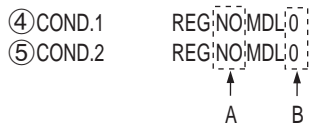

A: Enter a register number from one of the measurement programs already registered.

B: Select a model: 0 or 1.

⑦ AUX JUDGEMENT1, ⑧ AUX JUDGEMENT2

Specify judgment conditions for X and Y.

[TEST RESULT]: When executing a test from the "⑨RUN A TEST" line the result will be displayed here.

[OUTPUT]: Specify a destination for the output of test results: "NO," "Y," or "C."

⑨ RUN A TEST

Press the SET key to execute a test.

[2] When "DST" is selected.

- ② **DISTANCE NO.**
Enter a register number. The register numbers available are 0 to 15.

DIST&AGL COND		SCREEN	COND	SAVE	F	C1	BRT
① OBJ	DST						
② DISTANCE NO.	01(0-15)						
③ DISTANCE	DIST-BETW-2PT						NO DIST-BETW-2PT DIST-BETW-X DIST-BETW-Y
④ COND.1	REG NO MDL 0						
⑤ COND.2	REG NO MDL 0						
			[TEST RESULT]				[OUTPUT]
⑥ DISTANCE EVALUAT	000.0-702.0						NO
⑦ RUN A TEST	EXEC						
REGISTER NO.	00010203040506070809101112131415						
DISTANCE	○××××××××××××××××						
SET=SELECT A MENU ESC=BACK SEL=CHNG IMG TRG=FUNC							

- ③ **DISTANCE**
Select an distance.

NO	Do not select distance.
The distance between 2 points	
The distance between X coordinates	
The distance between Y coordinates	

- ④ **COND. 1** ⑤ **COND. 2**
Specify conditions for the distance that were selected in the "③DISTANCE" item.
- ⑥ **DISTANCE EVALUAT**
Specify judgment conditions for distance.
[TEST RESULT]: When executing a test from the "⑦RUN A TEST" line the result will be displayed here.
[OUTPUT]: Specify a destination for the output of test results: "NO," "Y," or "C."
- ⑦ **RUN A TEST**
Press the SET key to execute a test.

14

[3] When "ANGL" is selected.

② ANGL NO.

Enter a register number. The register numbers available are 0 to 15.

③ ANGL

Select the angle specifying method.

DIST&AGL COND SCREEN COND SAVE		F C1 BRT
① OBJ	ANGL	
② ANGL NO.	00(0-15)	
③ ANGL	3PT-ANGL →	NO 3PT-ANGL 2PT-H-ANGL 2PT-V-ANGL
④ COND.1	REG NO MDL 0	
⑤ COND.2	REG NO MDL 0	
⑥ COND.3	REG NO MDL 0	
⑦ ANGL EVALUATION	-180.0~+180.0j	[TEST RESULT] B= i [OUTPUT] NO
⑧ RUN A TEST	EXEC	
REGISTER NO.	00010203040506070809101112131415	
DISTANCE	○××××××××××××××××××	

NO	Do not select angle.	_____
3PT-A- NGL	Point 1 is the point of inter section of the two lines. Relative to the line between points 1 and 2, the line between points 1 and 3 will be said to be at a positive angle if the angle is measured in a counter clckwise direction, and it will be at a negative angle if it is measured in a clockwise direction.	
2PT-H-- ANGL	When a 2-point horizonntal angle is specified,relative to the horizontal line, the line from point 2 that intersects point 1 will be said to at a positive angle if the angle is measured in a counterclockwise direction and at a negative angle if it is measured in a clockwise direction.	
2PT-V-- ANGL	When a 2-point vertical angle is scified, relative to the vertical line, the line from point 2 that intersects point 1 will be said to at a positive angle if the angle is measured in a couterclockwise direction and at a negative angle if it is measured in a clockwise direction.	

④ COND. 1, ⑤COND. 2, ⑥COND.3

Specify conditions for the angle that were selected in the "③ANGL" item.

⑦ ANGL EVALUATION

Specify judgment conditions for angle.

[TEST RESULT]: When executing a test from the "⑦RUN A TEST" line the result will be displayed here.

[OUTPUT]: Secify a destination for the output of test results: "NO," "Y," or "C."

⑧ RUN A TEST

Press the SET key to execute a test.

■ Numeric calculation setting

- Press the TRG/BRT key to move the cursor to the upper function menu, and highlight "COND" using the left and right arrow keys. Press the SET key to show the popup menu. Select "NUM-CALC" from the popup menu.
- Select "NUM-CALC" on the menu tree.
- ⇒ See "Chapter 15: Numeric calculation."

■ Output condition setting

- Press the TRG/BRT key to move the cursor to the upper function menu, and highlight "COND" using the left and right arrow keys. Press the SET key to display the popup menu. Select "OUT" from the popup menu.
- Select "OUT-COND" on the menu tree.
- ⇒ See "Chapter 17: Set the Input/Output Conditions."

■ Display the measurement results

Return to the operation screen and press the TRG/BRT key. The measurement results will be displayed on the screen.
 To display the measurement results, select "COND-CHG" or "DIST&ANG COND..." on the lower menu bar and press the right arrow key. On the popup menu, select which item you want to display: "AUX," "DST," or "ANGL." Then press the SET key. On the "CHNG-REG" item, press the up and down arrow keys and the display will change.

● Example of the results displayed for a distance measurement

Final evaluation result → OK

Measuring time → MEAS XXXXms 1999-08-01 10:30

Measurement program number → MEASURE 0 CAM1 POSI-DEVIATION

Measurement object → MXR

Distance of distance number 00	00:100.0	OK
" 01	01:100.0	OK
" 02	02:050.0	OK
" 03	03:360.0	OK
" 04	04:250.0	OK
" 05	05:	
" 06	06:	
" 07	07:	

(Number of pixels)

*Areas will not be displayed for unspecified registration numbers.

MEA-CND
DST&ANG COND...
NUMERIC CALC

AUX
DST
ANGL

X0~7 Y0~7

MNU-CHG MAIN-COND CHG-MEA COND-CHG CHNG-REG SCREEN-CHG CHG-TYPE

● Example of the displayed of angle results

Measurement object	→	ANGL
Angle of angle number 00	→	00:+080.0° OK
" 01	→	01:+070.0° OK
" 02	→	02:+050.0° OK
" 03	→	03:+088.2° OK
" 04	→	04:+00 6.5° OK
" 05	→	05:
" 06	→	06:
" 07	→	07:

● Example of the displayed of auxiliary results

Measurement object	→	AUX
Angle of auxiliary number 00	→	00: (259.0, 178.0) OK
" 01	→	01: (466.0, 178.0) OK
" 02	→	02: (361.0, 228.0) OK
" 03	→	03: (132.0, 298.0) OK
" 04	→	04: (362.5, 178.0) OK
" 05	→	05:
" 06	→	06:
" 07	→	07:

Chapter 15 Numerical Calculations

15-1 Outline

Numeric calculation function of the IV-S30 consists of "numeric calculations," which is set individually for each measurement program, and "final numeric calculations," which are set according to object type. The N00 to N15 results of the calculations which are set individually for each measuring program may be used according to the "TYPE" and "FORMULA" settings of the final numerical calculation.

15-2 The individual numerical calculations for each measuring program

● How to display the numerical calculation conditions setting screen

There are two methods for displaying the numerical calculation conditions setting screen.

- 1) Select "MAIN COND" -> "OBJECT TYPE COND" (menu tree) -> "TYPE00" -> "MEA-CND (CAMERA1)" -> "MEAS(NEW)," in that order. On the "① MEAS SELECTION" line, select any of the measurement programs.

Note: When "① MEAS SELECTION" is left set to "NO," you cannot specify a numerical calculation function.

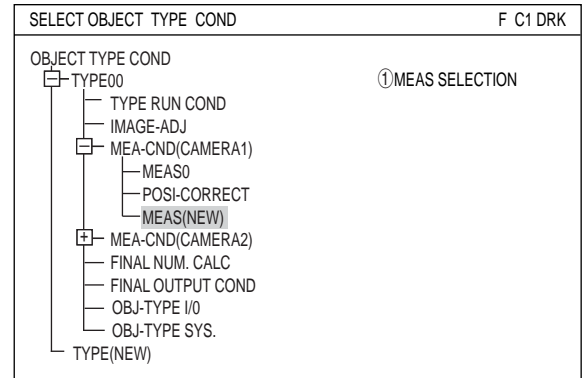

On either the MEAS CND, or REG-COND screen, press the TRG/BRT key to move the cursor to the upper function menu. Select "COND" and then from the popup menu, select the "NUM-CALC" item.

Note: The items shown in the popup menu will vary with the measurement program selected.

- When the position deviation measurement is selected

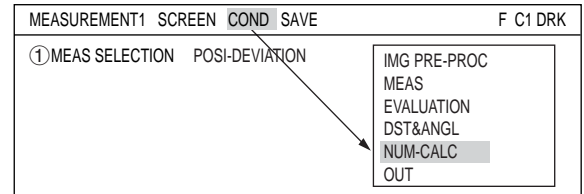

- 2) Open the sub menu for "MEAS0" or "MEAS1" on the menu tree, and select "NUM-CALC." Then press the SET key.

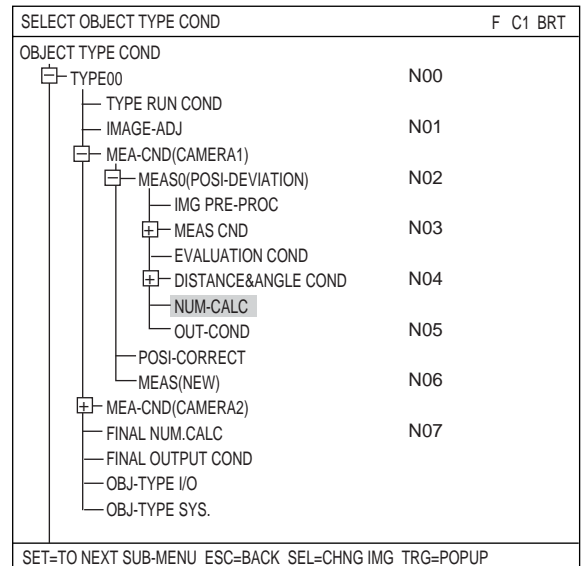

Note

- **Numeric calculation errors (deviation from the exact value) after digitizing the image**
 Since the IV-S30 uses 64-bit, floating-point arithmetic operations in its calculations, small quantization errors may occur when converting the images into numbers.

● **Setting details**

The setting details and procedures for numerical calculations are the same for all measurement programs with the exception of the point measurement program. In this section we explain the use of the numerical calculations menu [NUMERIC CALC] for positional measurements.

"CHG-CALC"

Move the cursor to the "CHG-CALC" item.

Each time you press the SET key the display in the leftmost column will alternate between "N00 to N07" and "N08 to N15."

① **RUN A TEST**

Pressing the SET key will store the setting details as well as run a test

The numerical results of the tests will be displayed at position [F] and the OK or NG judgment will be displayed at position [E].

A: TYPE

Select the type of data being calculated. The details displayed for each measuring program.

⇒ See page 15-5 to 15-8.

B: FORMULA

Select the formula to apply. Select formula using the left and right arrow keys and enter numerical values using the up and down arrow keys.

The details displayed for "FORMULA" will depend on the "TYPE" selected.

Item selections	Selection on line
CRD-X, CRD-Y, DEV-x, DEV-y, MATCH M, ANGL B	OBJECT TYPE, CALC RESULT, CNST, SUM, AVG, CBP, CBM, DEL
NUM-CAL [NC]	ABS, SQRT, TAN, ATAN, MAX, MIN, DEL
CNST [C]	+0000000.00 (second line is not displayed)

⇒ For details about the items that can be selected with other measurement programs, see pages 15-5 to 15-8.

C: UPR&LOW LIMIT

Enter the upper and lower limits for making a judgment.

D: OUTPUT

Setting the output of the calculation results. Select an output target: "NO," "Y," or "C."

The output can be set to Y0 to Y7 or C000 to C107.

- The number of styles may be set as follows, depending on the selections made in items A and B.

OBJECT TYPE	Model 0	Model 1
CRD [X Y]	0X0 to 7X0 / 0Y0 to 7Y0	0X1 to 7X1 / 0Y1 to 7Y1
DEV [x y]	0x0 to 7x0 / 0y0 to 7y0	0x1 to 7x1 / 0y1 to 7y1
MATCH [M]	0M0 to 7M0	0M1 to 7M1
ANGL [B]	0B to 7B	
NUM-CAL [NC]	ABS / SQRT / TAN / ATAN (00 to 14) MAX/MIN (00 to 14)	
CNST [C]	-9999999.99 to +9999999.99	

Corresponds to page 15-4.

These are the same as for the other measurement programs.

The numbers from 0 to 7 in front of the characters are registration numbers.

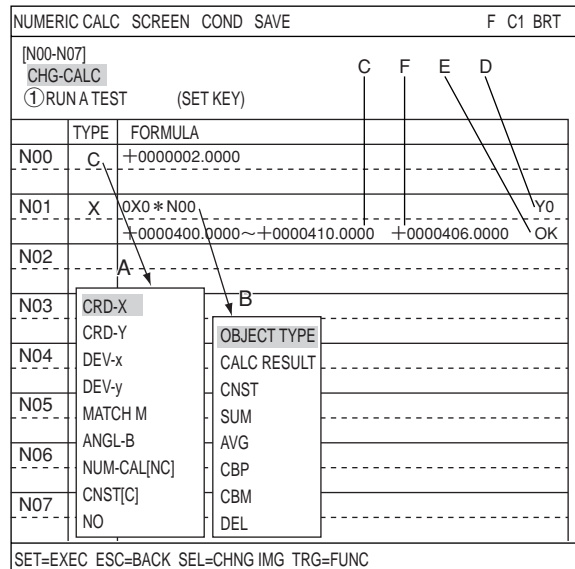

● **Setting procedure**

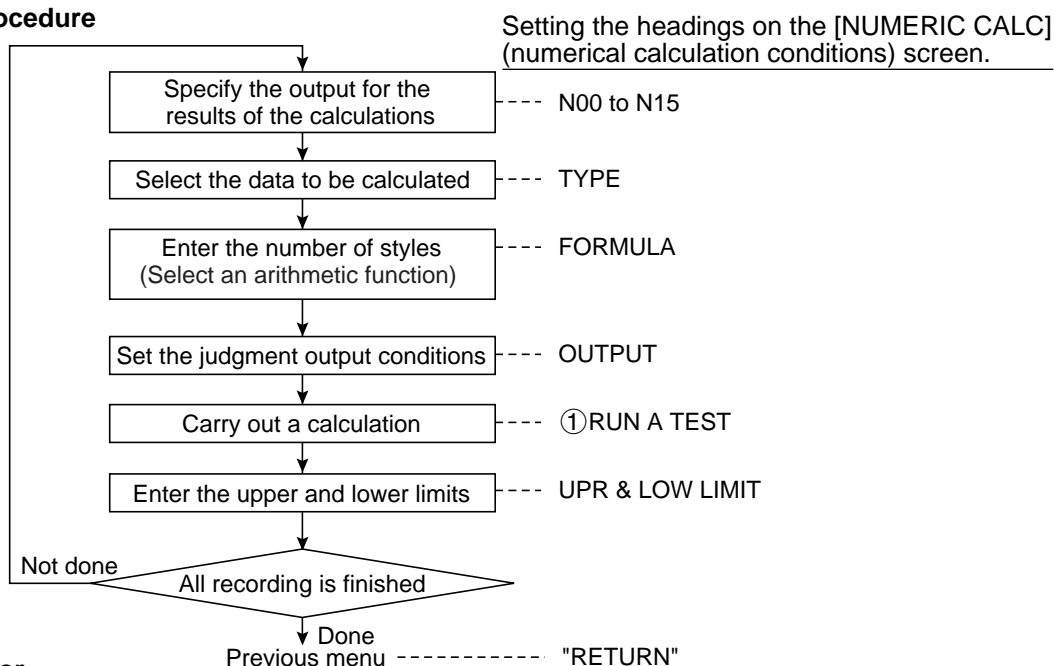

● **Output error**

An error will be output if there are too many digits as well as if there is an attempt to divide by zero.

● **Order of calculation**

The calculation results are produced in order, from N00 to N15.

● **Parallel output based on the output conditions**

It is possible to use the parallel output for the evaluation results from the calculations by selecting the PC function in the output conditions (the final output conditions are taken from the output conditions set for each measurement program)

● **Types and number of styles of entered for each measurement program**

The table shown below contains the numeric formulas that can be assigned in "TYPE" and "FORMULA" on the "NUMERIC CALC" screen, for each measurement program.

Input types	Symbol	Measurement program		
		Positional deviation measurement	Degree of match inspection	Lead inspection
Degree of match	M	Model 0: 0M0 to 7M0 Model 1: 0M1 to 7M1	Model 0: 00M0 to 15M0 Model 1: 00M1 to 15M1	
Coordinate	X	Model 0: 0X0 to 7X0 Model 1: 0X1 to 7X1	Model 0: 00X0 to 15X0 Model 1: 00X1 to 15X1	
Coordinate	Y	Model 0: 0Y0 to 7Y0 Model 1: 0Y1 to 7Y1	Model 0: 00Y0 to 15Y0 Model 1: 00Y1 to 15Y1	
Deviation	x	Model 0: 0x0 to 7x0 Model 1: 0x1 to 7x1		
Deviation	y	Model 0: 0y0 to 7y0 Model 1: 0y1 to 7y1		
Angle	B	Model 0: 0B0 to 7B0 Model 1: 0B1 to 7B1		
Light level	G		Model 0: 00G0 to 15G0 Model 1: 00G1 to 15G1	
Number of objects	K			00K to 31K
Distance	MAX: MXD			00MXD to 15MXD
	MIN: MND			00MND to 15MND
Lead width	MAX: MXW			00MXW to 15MXW
	MIN: MNW			00MNW to 15MNW
Lead length /Lead width 2	MAX: MXL			00MXL to 15MXL
	MIN: MNL			00MNL to 15MNL
Numeric calculation results	N	N0 to N15	N0 to N15	N0 to N15

Input types	Symbol	Measurement program		
		BGA/CSP inspection	Area measurement by binary conversion	Counting quantities by binary conversion
Total area	A	0A to 3A	Number of masks= 1: 00A to 15A Number of masks= 2: 0A to 7A Number of masks= 4: 0A to 3A	0A to 3A
Number of objects	K	0K to 3K		0K to 3K
Area of each label	MAX: MXR	0MXR to 3MXR		
	MIN: MNR	0MNR to 3MNR		
Distance between gravity centers X	MAX: XDX	0XDX to 3XDX		
	MIN: NDX	0NDX to 3NDX		
Distance between gravity centers Y	MAX: XDY	0XDY to 3XDY		
	MIN: NDY	0NDY to 3NDY		
Fellet diameter X	MAX: XFX	0XFX to 3XFX		
	MIN: NFX	0NFX to 3NFX		
Fellet diameter Y	MAX: XFY	0XFY to 3XFY		
	MIN: NFY	0NFY to 3NFY		
Numerical calculation result	N	N0 to N15	N0 to N15	N0 to N15

Input types	Symbol	Measurement program	
		Label measurement by binary conversion	Point measurement
Total area	A	0A to 3A	
Number of objects	K	0K to 3K	
Area of each label	R	0R000 to 0R127...3R000 to 3R127	
X coordinate of gravity center	GX	0GX000 to 0GX127...3GX000 to 3GX127	
Y coordinate of gravity center	GY	0GY000 to 0GY127...3GY000 to 3GY127	
Main axis angle	B	0B000 to 0B127...3B000 to 3B127	
Fellet diameter X	FX	0FX000 to 0FX127...3FX000 to 3FX127	
Fellet diameter Y	FY	0FY000 to 0FY127...3FY000 to 3FY127	
Perimeter of each object	CR	0CR000 to 0CR127...3CR000 to 3CR127	
Center point X	CX	0CX000 to 0CX127...3CX000 to 3CX127	
Center point Y	CY	0CY000 to 0CY127...3CY000 to 3CY127	
Average light level	G		000G to 127G
Counting white objects	WC		(Count all the objects registered)
Number of registers	RC		(Corresponds to the whole number of registers)
Numerical calculation results	N	N0 to N15	N0 to N15

Input types	Symbol	Measurement program		Distance and angle measurements
		Multiple positions measurement	Multiple degree of match inspection	
Number of objects	K	0K to 3K	0K to 3K	
Degree of match	M	0M000 to 3M127	0M000 to 3M127	
Coordinate	X	0X000 to 3X127	0X000 to 3X127	
Coordinate	Y	0Y000 to 3Y127	0Y000 to 3Y127	
Density	G		0G000 to 3G127	
Auxiliary 1	H1			00H1 to 15H1
Auxiliary 2	H2			00H2 to 15H2
Distance	D			00D to 15D
Angle	B			00B to 15B
Numerical calculation result	N	N0 to N15	N0 to N15	N0 to N15

15

[1] Display lists on the "NUMERIC CALC" screen

This section displays the "NUMERIC CALC" screen for each measuring program. The details displayed for "FORMULA" will depend on the "TYPE" selected.

(1) Positional deviation measurement

See page 15-2.

(2) Degree of match inspection

NUMERIC CALC SCREEN COND SAVE		F C1 BRT
[N00-N07] CHG-CALC ① RUN A TEST (SET KEY)		
TYPE	FORMULA	
N00	MATCH M	
N01	CRD-X	
N02	CRD-Y	
N03	LVL G	
N04	NUM-CAL[NC]	
N05	CNST[C]	
N06	NO	

The details displayed for "FORMULA" will depend on the "TYPE" selected.

Selection of type	Selection of formula
MATCH M CRD-X CRD-Y LVL G	OBJECT TYPE, CALC RESULT, CNST, SUM, AVG, CBP, CBM, DEL
NUM-CAL[NC]	ABS, SQRT, TAN, ATAN, MAX, MIN, DEL
CNST[C]	+0000000,000

(3) Lead inspection

NUMERIC CALC SCREEN COND SAVE		F C1 BRT
[N00-N07] CHG-CALC ① RUN A TEST (SET KEY)		
TYPE	FORMULA	
N00	OBJ-K	
N01	DISTANCE MAX MXD	
N02	DISTANCE MIN MND	
N03	LEAD WIDTH MAX MXW	
N04	LEAD-WIDTH MIN MNW	
N05	LEAD-LENGTH MAX MXL	
N06	LEAD-LENGTH MIN MNL	
N07	NUM-CAL[NC]	
N08	CNST[C]	
N09	NO	

The details displayed for "FORMULA" will depend on the "TYPE" selected.

Selection of type	Selection of formula
OBJ-K DISTANCE MAX MXD/MIN MND LEAD WIDTH MAX MXW/MIN MNW LEAD-LENGTH MAX MXL/MIN MNL	OBJECT TYPE, CALC RESULT, CNST, SUM, AVG, CBP, CBM, DEL
NUM-CAL[NC]	ABS, SQRT, TAN, ATAN, MAX, MIN, DEL
CNST[C]	+0000000,000

(4) BGA/CSP inspection

NUMERIC CALC SCREEN COND SAVE		F C1 BRT
[N00-N07] CHG-CALC ① RUN A TEST (SET KEY)		
TYPE	FORMULA	
N00	TOTAL-AREA-A	
N01	OBJ-K	
N02	OBJECT-AREA MAX MXR	
N03	OBJECT-AREA MIN MNR	
N04	X FILLET-W MAX XFX	
N05	X FILLET-W MIN NFX	
N06	Y FILLET-W MAX XFY	
N07	Y FILLET-W MIN NFY	
N08	X-PITCH MAX XDX	
N09	X-PITCH MIN NDX	
N10	Y-PITCH MAX XDY	
N11	Y-PITCH MIN NDY	
N12	NUM-CAL[NC]	
N13	CNST[C]	
N14	NO	

The details displayed for "FORMULA" will depend on the "TYPE" selected.

Selection of type	Selection of formula
TOTAL-AREA-A OBJ-K OBJECT-AREA MAX MXR OBJECT-AREA MIN MNR X FILLET-W MAX XFX X FILLET-W MIN NFX Y FILLET-W MAX XFY Y FILLET-W MIN NFY X-PITCH MAX XDX X-PITCH MIN NDX Y-PITCH MAX XDY Y-PITCH MIN NDY	OBJECT TYPE, CALC RESULT, CNST, SUM, AVG, CBP, CBM, DEL
NUM-CAL[NC]	ABS, SQRT, TAN, ATAN, MAX, MIN, DEL
CNST[C]	+0000000,000

(5) Area measurement by binary conversion

NUMERIC CALC SCREEN COND SAVE		F C1 BRT
[N00-N07] CHG-CALC ① RUN A TEST (SET KEY)		
TYPE	FORMULA	
N00	←	TOTAL-AREA-A
N01		NUM-CAL[NC] CNST[C]
N02		NO
N03		

The details displayed for "FORMULA" will depend on the "TYPE" selected.

Selection of type	Selection of formula
TOTAL-AREA-A	OBJECT TYPE, CALC RESULT, CNST, SUM, AVG, CBP, CBM, DEL
NUM-CAL[NC]	ABS, SQRT, TAN, ATAN, MAX, MIN, DEL
CNST[C]	+0000000,000

(6) Object counting by binary conversion

NUMERIC CALC SCREEN COND SAVE		F C1 BRT
[N00-N07] CHG-CALC ① RUN A TEST (SET KEY)		
TYPE	FORMULA	
N00	←	TOTAL-AREA-A
N01		OBJ-K NUM-CAL[NC] CNST[C]
N02		
N03		
N04		
N05		
N06		
N07		
SET=EXEC ESC=BACK SEL=CHNG IMG TRG=FUNC		

The details displayed for "FORMULA" will depend on the "TYPE" selected.

Selection of type	Selection of formula
TOTAL-AREA-A OBJ-K	OBJECT TYPE, CALC RESULT, CNST, SUM, AVG, CBP, CBM, DEL
NUM-CAL[NC]	ABS, SQRT, TAN, ATAN, MAX, MIN, DEL
CNST[C]	+0000000,000

(7) Object identification of binary conversion

NUMERIC CALC SCREEN COND SAVE		F C1 BRT
[N00-N07] CHG-CALC ① RUN A TEST (SET KEY)		
TYPE	FORMULA	
N00	←	TOTAL-AREA-A
N01		OBJ-K OBJECT-AREA-R
N02		C-GRAVS X GX C-GRAVS Y GY
N03		X FILLET-W FX Y FILLET-W FY
N04		AX.ANGL[B] LB-CIRCUM[CR]
N05		MID-PNT X CX MID-PNT Y CY
N06		NUM-CAL[NC] CNST[C]
N07		NO

The details displayed for "FORMULA" will depend on the "TYPE" selected.

Selection of type	Selection of formula
TOTAL-AREA-A OBJ-K OBJECT-AREA-R C-GRAVS GX/GY X FILLET-W FX/FY AX.ANGL[B] LB-CIRCUM[CR] MID-PNT CX/CY	OBJECT TYPE, CALC RESULT, CNST, SUM, AVG, CBP, CBM, DEL
NUM-CAL[NC]	ABS, SQRT, TAN, ATAN, MAX, MIN, DEL
CNST[C]	+0000000,000

15

(8) Point measurement

- When "BINARY" is selected on the "①MODE"

NUMERIC CALC SCREEN COND SAVE			F C1 BRT
[N00-N07] CHG-CALC ① RUN A TEST (SET KEY)			
	TYPE	FORMULA	
N00	←	WHT.CNT/REG.NO[WRC]	
		NUM-CAL[NC]	
N01		CNST[C]	
N02		NO	

- When "AVG-GRAYS" is selected on the "①MODE"

NUMERIC CALC SCREEN COND SAVE			F C1 BRT
[N00-N07] CHG-CALC ① RUN A TEST (SET KEY)			
	TYPE	FORMULA	
N00	←	AVG-GRAYS[G]	
		OBJ TYPES REG.LIST	
N01		NUM-CAL[NC]	
N02		CNST[C]	
N03		NO	

The details displayed for "FORMULA" will depend on the "TYPE" selected.

Selection of type	Selection of fomura
WHT.CNT/REG.NO[WRC]	WHT.CNT[WC], REG.NO[WRC], NUM-CAL, CNST,DEL
NUM-CAL[NC]	ABS, SQRT, TAN, ATAN, MAX, MIN, DEL
CNST[C]	+0000000,000

Selection of type	Selection of fomula
AVG-GRAYS[G]	OBJECT TYPE, CALC RESULT, CNST, SUM, AVG, CBP, CBM, DEL
WHT.CNT/REG.NO[WRC]	WHT.CNT[WC], REG.NO[WRC], NUM-CAL, CNST,DEL
NUM-CAL[NC]	ABS, SQRT, TAN, ATAN, MAX, MIN, DEL
CNST[C]	+0000000,000

(9) Multiple positional measurement

NUMERIC CALC SCREEN COND SAVE			F C1 BRT
[N00-N07] CHG-CALC ① RUN A TEST (SET KEY)			
	TYPE	FORMULA	
N00	←	OBJ-K	
		MATCH M	
N01		CRD-X	
N02		CRD-Y	
N03		NUM-CAL[NC]	
N04		CNST[C]	
N05		NO	

The details displayed for "FORMULA" will depend on the "TYPE" selected.

Selection of type	Selection of formula
OBJ-K MATCH M CRD X/Y	OBJECT TYPE, CALC RESULT, CNST, SUM, AVG, CBP, CBM, DEL
NUM-CAL[NC]	ABS, SQRT, TAN, ATAN, MAX, MIN, DEL
CNST[C]	+0000000,000

(10) Multiple degree of match inspection

NUMERIC CALC SCREEN COND SAVE			F C1 BRT
[N00-N07] CHG-CALC ① RUN A TEST (SET KEY)			
	TYPE	FORMULA	
N00	←	OBJ-K	
		MATCH M	
N01		LVL G	
N02		CRD-X	
N03		CRD-Y	
N04		NUM-CAL[NC]	
N05		CNST[C]	
N06		NO	

The details displayed for "FORMULA" will depend on the "TYPE" selected.

Selection of type	Selection of formula
OBJ-K MATCH M LVL G CRD X/Y	OBJECT TYPE, CALC RESULT, CNST, SUM, AVG, CBP, CBM, DEL
NUM-CAL[NC]	ABS, SQRT, TAN, ATAN, MAX, MIN, DEL
CNST[C]	+0000000,000

(11) Distance and angle measurement

NUMERIC CALC SCREEN COND SAVE		F C1 BRT
[N00-N07]		
CHG-CALC		
① RUN A TEST (SET KEY)		
	TYPE	FORMULA
N00	←	DST[D]
		ANGL[B]
N01		AUX H1
		AUX H2
N02		NUM-CAL[NC]
		CNST[C]
N03		NO
N04		
N05		
N06		
N07		
SET=EXEC ESC=BACK SEL=CHNG IMG TRG=FUNC		

The details displayed for "FORMULA" will depend on the "TYPE" selected.

Selection of type	Selection of formula
DST[D] ANGL[B] AUX[H1/H2]	OBJECT TYPE, CALC RESULT, CNST, SUM, AVG, CBP, CBM, DEL
NUM-CAL[NC]	ABS, SQRT, TAN, ATAN, MAX, MIN, DEL
CNST[C]	+0000000,000

15-3 Final numerical calculations

Final numerical calculations can be set at item "FINAL NUM-CALC" on the menu tree. The setting procedure, error output settings, calculation sequence and parallel output based on the output conditions are exactly the same as those used for item "15-1 The individual numerical calculations for each measuring program."

● **How to display the final numerical calculation screen.**

Open the sub menu for "TYPExx" on the menu tree and select "FINAL NUM. CALC." Then press the SET key.

SELECT OBJECT TYPE COND		F C2 BRT
OBJECT TYPE COND		AN00
└─ TYPE00		
├─ TYPE RUN COND		AN01
├─ IMAGE-ADJ		
├─ MEA-CND(CAMERA1)		AN02
├─ MEA-CND(CAMERA2)		
├─ FINAL NUM.CALC		AN03
├─ FINAL OUTPUT COND		
├─ OBJ-TYPE I/O		AN04
├─ OBJ-TYPE SYS.		
└─ TYPE(NEW)		AN05
		AN06
		AN07

SET=TO NEXT SUB-MENU ESC=BACK SEL=CHNG IMG TRG=POPOP

● **Settings on the final numerical calculation screen.**

The display positions of each item selected are the same as in section "15-1 Numeric calculations for each measurement program"

⇒ See the next page for the display details.

NUMERIC CALC SCREEN COND SAVE			F C1 BRT
[N00-N07]			
CHG-CALC			C D F E
① RUN A TEST (SET KEY)			
	TYPE	FORMULA	
AN00	N	+0000002.0000	
AN01	AN	OX0 * N00 +0000400.0000 ~ +0000410.0000	Y0 OK
AN02			
AN03	MEAS-CAL-RESULT[N]		
AN04	A-CAL-RESULT[AN]		
AN05	NUM-CAL[NC]		
AN06	CNST[C]		
AN07	NO		

OBJECT TYPE

CNST

SUM

AVG

CBP

CBM

DEL

SET=EXEC ESC=BACK SEL=CHNG IMG TRG=FUNC

"CHG-CALC"

Move the cursor to the "CHG-CALC" item. Each time you press the SET key the display in the leftmost column will alternate between "N00 to N07" and "N08 to N15."

① Run A TEST

Pressing the SET key will store the setting details as well as run a test

The numerical results of the tests will be displayed at position [F] and the OK or NG judgment will be displayed at position [E].

A: TYPE

Select the type of data being calculated.

B: FORMULA

A number of style settings are used. The style type is selected using the left and right keys and the numerical values are entered using the up and down keys.

The details displayed for "FORMULA" will depend on the "TYPE" selected.

Selected of type	
MEAS-CAL-RESULT[N] A-CAL-RESULT[AN]	OBJECT TYPE, CNST, SUM, AVG, CBP, CBM, DEL
NUM-CAL[NC]	ABS, SQRT, TAN, ATAN, MAX, MIN, DEL
CNST[C]	+0000000,000 (second line is not displayed)

Note: When "SUM" (total) or "AVG" (average) is selected for calculating the results, specify the range from 0 to 15.

C: UPR&LOW LIMIT

Enter the upper and lower limits for making a judgment

D: OUTPUT

Setting the output of the calculation results.

Based on the settings at items "TYPE" and "FORMULA," the number of styles may be entered as follows.

OBJECT TYPE	Number of styles
MEAS-CAL-RESULT [N] (Results of the calculations for measurements)	01N00 to 01N15 (Calculation result for measurement 0, camera 1: N00 to 15) 02N00 to 02N15 (Calculation result for measurement 0, camera 2: N00 to 15) 10N00 to 10N15 (Calculation result for measurement 1: N00 to 15) 20N00 to 20N15 (Calculation result for measurement 2: N00 to 15) 30N00 to 30N15 (Calculation result for measurement 3: N00 to 15) 40N00 to 40N15 (Calculation result for measurement 4: N00 to 15)
A-CAL-RESULT [AN] (Results of final calculations)	AN00 to AN15
NUM-CAL [NC] (Numerical calculations)	ABS / SQRT / TAN / ATAN (00 to 15) MAX/MIN (00 to 15)
CNST [C] (Constant)	-9999999.99 to +9999999.99

15-4 Setting examples

The example below shows the settings used to evaluate and output the X-Y coordinates (differences) of the detection points in images 0 and 1, using the evaluation calculation. (Degree of match inspection ⇨ See Chapter 5; Output ⇨ See Chapter 16: PC Function.)

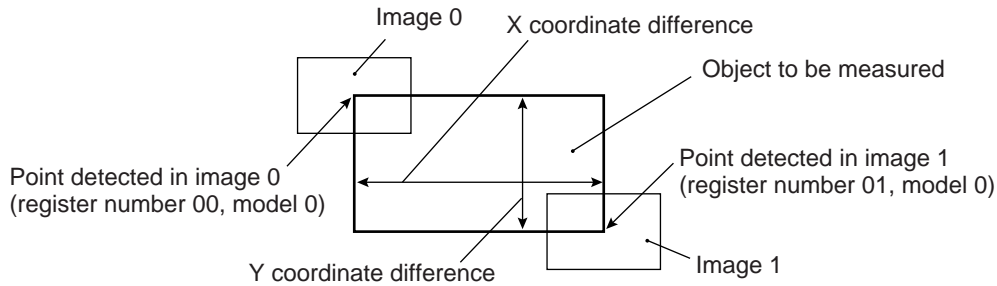

(1) Image setting

After specifying the images, return to the "MEA CND" screen for the degree of match inspection.

(2) Operations on the "MEA CND" screen

Press the TRG/BRT key to move the cursor to the upper function menu. Select "COND" and press the SET key. Select "NUM-CALC" from the popup menu and then press the SET key.

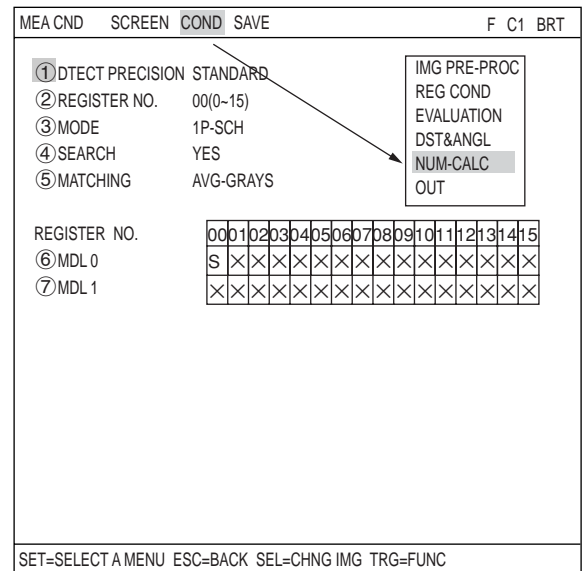

(3) Operations on the "NUMERIC CALC" screen

- Select position "A" (2nd cell in the "TYPE" column) on the "N00" line using the up and down arrow keys. Select "CRD-X" from the popup menu and then press the SET key.
- Move the cursor to position "B" (2nd cell in the "FORMULA" column) and press the SET key. "00X0" will be displayed in the "FORMULA" column. Select a digit using the left and right arrow keys. Press the SET key. Then change the selected digit "01X0" by using the up and down keys.

N00	X	01X0
		+0000000.00~+0000000.00

"01X0" is referring to the X coordinate of register number 01 (image 1) and model 0.

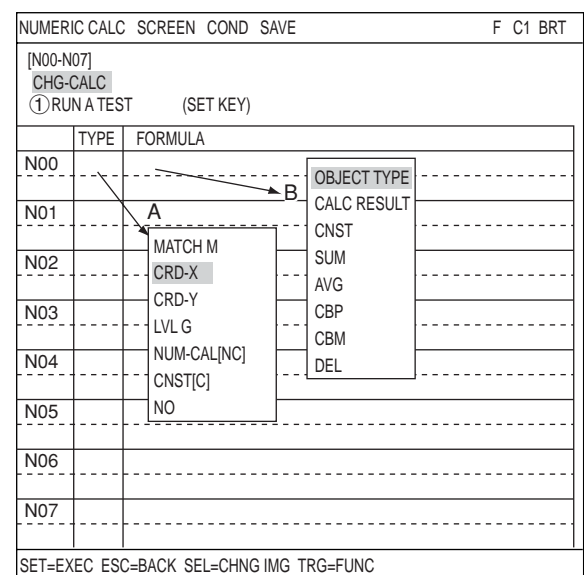

Press the SET key, the cursor will move to the right. Press the SET key again and a popup menu will appear. Select the "-" and press the SET key.
 - The cursor will appear to the right of the "-." Press the SET key and a popup menu will appear.
 Select a "TYPE" and press the SET key.
 ⇨ 00X0 will be displayed in the formulafield

N00	X	01X0-00X0
		+0000000.00~+0000000.00

00x0 refers to the X coordinate of the detection point in model 0, stored in register NO.00(image 0).

- Move the cursor to the 2nd line using the up and down arrow keys and set the upper limit value using the left and right arrow keys. Then press the SET key. Then select a digit to change using the left and right arrow keys. Repeat this procedure to set the value to +160.0000 and then press the SET key.

+0000000.0000~+0000160.0000
 ↙ Upper limit

Move the cursor to the lower limit using the left and right keys, and press the SET key. Select a digit using the left and right keys Enter the number +140.00 using the up and down keys, and press the SET key.

+0000140.0000~+0000160.0000
 ↙ Lower limit

⇨ +0000140.0000 to+0000160.0000 will be displayed in the lower and upper limit fields.

- Move the cursor to the "N01" line and the "TYPE" column using the up/down keys.
 - Asdescribed in steps 2 to 3, enter 01Y0 to 00Y0 in the formula field, and inter +0000090.0000 to +0000095.0000 in the upper and lower limit fields.

N00	X	01X0-00X0
		+0000140.00~+0000160.00
N01	Y	01Y0-00Y0
		+0000090.00~+0000095.00

- Move the cursor to the "①RUN A TEST" item using the up and down keys, and press the SET key.

Press the SET key once more. Then the settings will be stored, and the test will be executed.

⇨ The evaluation result (OK/NG) of the calculations will be displayed.

N00	X	01X0-00X0
		+0000140.00~+0000160.00 +0000147.00 OK
N01	Y	01Y0-00Y0
		+0000090.00~+0000095.00 +0000091.00 OK

[OK: When the test result based on the calculations is within the specified range
 NG: When the test result based on the calculations is outside of the specified range]

- Press the ESC key to return to the "MEA-CND" setting screen.

(4) Operation on the "OUTPUT COND" screen

1. On the "MEA CND" setting screen, press the TRG/BRT key to move the cursor to the upper function menu. Select the "COND" item and then select the "OUT" item and press the SET key.

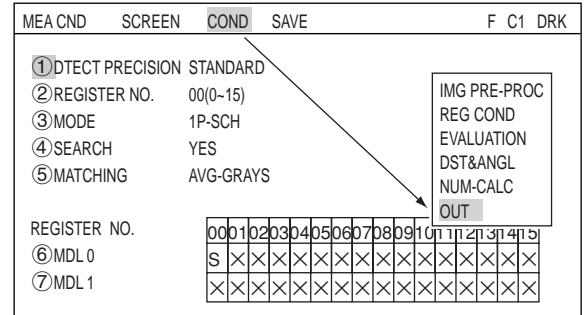

2. Select the "INPUT00" line and row 0. Then press the SET key. Select "NUM-CAL[NC]" from the popup menu and press the SET key.

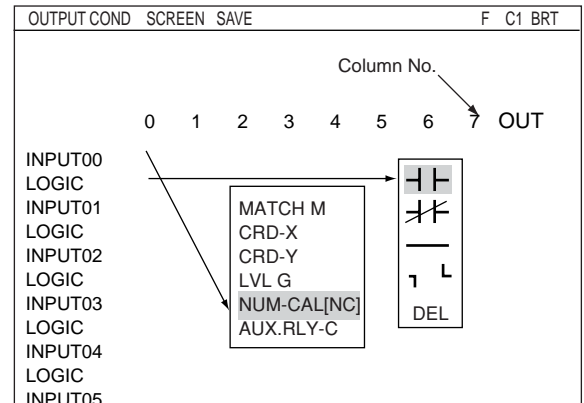

3. Move the cursor to the "LOGIC" line on the same row and press the SET key. Select "|||" from the popup menu and press the SET key.

The logical condition will be displayed in the leftmost column of the LOGIC row under INPUT 0.

[PAGE0]	0	1	2	3	4	5	6	7	OUTPUT
INPUT0	N00								
LOGIC		—	—	—	—	—	—	—	

- N00 refers to the N00 calculation result, that was entered on the "NUMERIC CALC" screen.

4. Select the "INPUT00" line and row 1. Then press the SET key. Set "NUM-CAL[NC]" using the same procedures as in Steps 2 and 3 above. Since "N00" will appear first, press the SET key and change "N00" to "N01," using the up/down/left/right arrow keys.

[PAGE0]	0	1	2	3	4	5	6	7	OUTPUT
INPUT0	N00	N01							
LOGIC			—	—	—	—	—	—	

5. Move the cursor to the "OUT" row using the left and right arrow keys, and press the SET key. Select "AUX-RLY" from the popup menu and press the SET key.

6. A list of auxiliary relays will be displayed. Select "C000" using the up and down arrow keys and press the SET key.

⇒ The output coil for INPUT 0 will be displayed.

[PAGE0]	0	1	2	3	4	5	6	7	OUTPUT
INPUT0	N00	N01							C000
LOGIC			—	—	—	—	—	—	◻

AUX-RLY	Use place
C000	MEAS1/OUTPUT COND
C001	NO
C002	NO
C003	NO
C004	NO
C005	NO
C006	NO
C007	NO

7. Press the ESC key to move to the "MEA-CND" setting screen.

(5) Operations on the "FINAL OUTPUT COND" screen

1. Select "FINAL OUTPUT COND" on the "SELECT OBJECT TYPE COND" screen, to display the final output conditions screen.

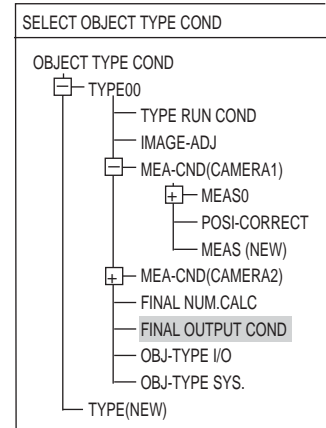

2. Move the cursor to "INPUT00" and row 0, and press the SET key. Select "AUX. RLY-C." from the popup menu and press the SET key.

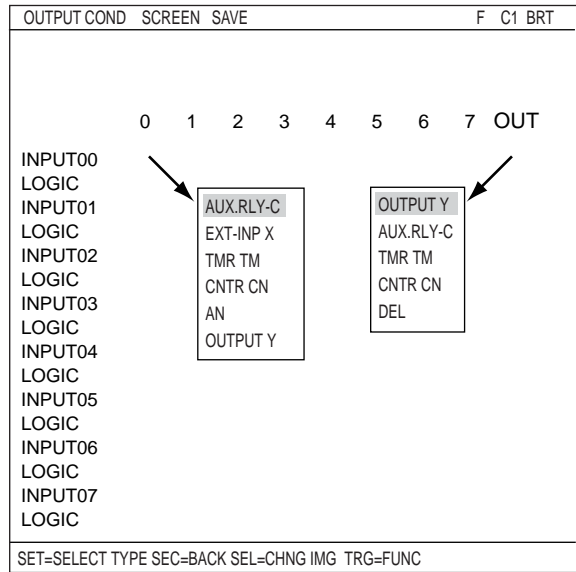

⇒ The following logical symbol will be displayed in the left most column of INPUT 0.

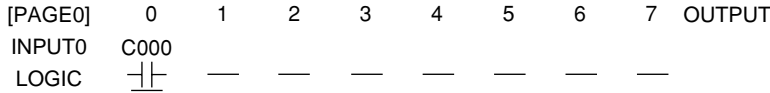

3. Move the cursor to the "OUT" row using the left and right arrow keys, and press the SET key. Select "OUTPUT Y" from the popup menu and press the SET key.

4. Now, a list of the Y outputs will be displayed. Select "Y0" using the up and down arrow keys, and press the SET key.

⇒ The output coil for INPUT 0 will be displayed.

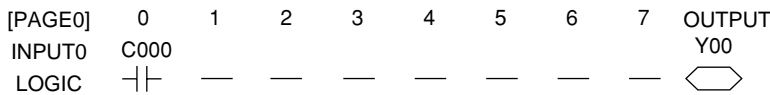

Y OUTPUT	Use place
Y0	FINAL OUTPUT COND
Y1	NO
Y2	NO
Y3	NO
Y4	NO
Y5	NO
Y6	NO
Y7	NO

5. Press the TRG/BRT key to move the cursor to the upper function menu. Then select "SCREEN" and press the SET key. Select "OPS-MENU" from the popup menu and press the SET key.

⇒ Select the operation screen.

(6) Degree of match inspection

Press the TRG/BRT key, and the will calculate the X-Y coordinates of the detection points in images 0 and 1, and then evaluate and output the results.

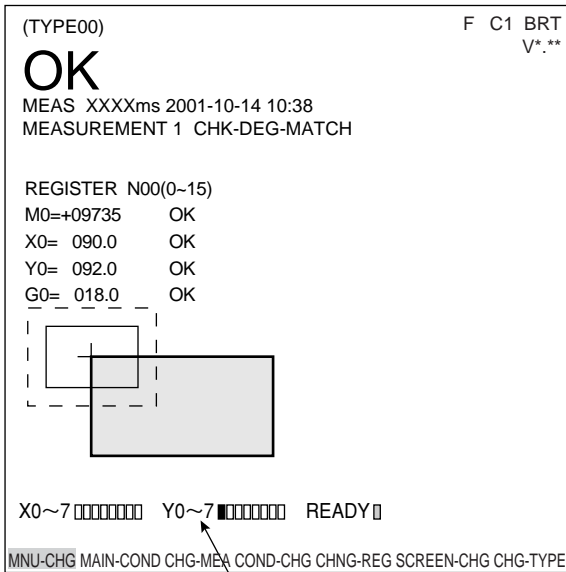

If the difference in the X and Y coordinates is within the range set on the numeric calculation menu, Y0 will be turned ON, and a filled box ■ will be displayed. If the difference is not within the range, Y0 will be turned OFF, and an empty box □ will be displayed.

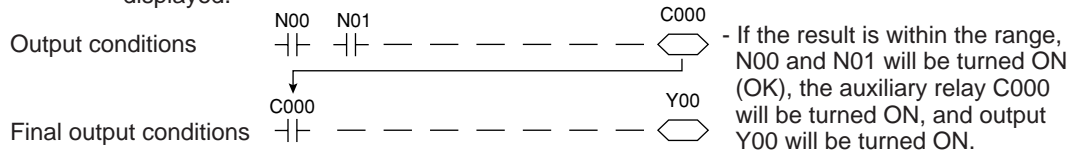

Chapter 16: PC Function

16-1 Outline

The PC function is designed to create a ladder circuit program based on the data (coordinates, distance, degree of match, and results of numerical calculations) obtained from the measurements and calculations made by the IV-S30. Then it outputs the results of the calculations performed by the circuit.

Use of the PC function enables the IV-S30 to output measurement results to an external equipment such as a lamp by itself, without the need for an external PC.

16-2 Operation cycle

The operation cycle of the IV-S30 is outlined below. This flowchart contains only the operations related to the PC function, and does not show communications with external devices.

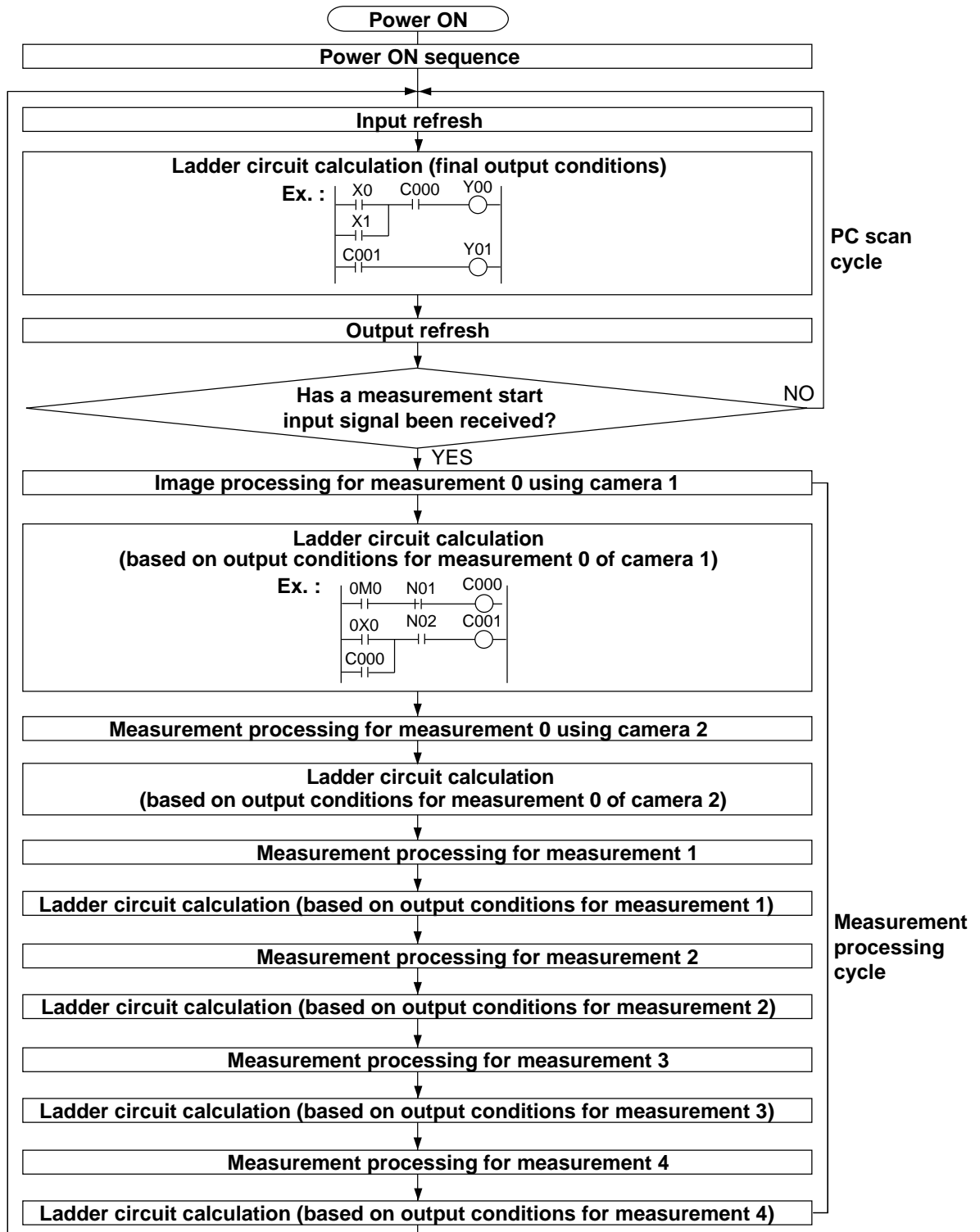

[1] Power ON sequence

The parallel output terminals (Y0 to Y7) are reset, and the data memories (input relays, output relays, auxiliary relays, timer and counter) are cleared.

[2] PC scan cycle

In the PC scan cycle, the following three operations (1) to (3) are repeated cyclically.

(1) Input refresh

The ON/OFF data from the parallel input terminals (X0 to X7) is written into the data memory (input relays).

(2) Ladder circuit calculation (final output conditions)

The calculations are executed by the ladder circuit program which contains the data from input relays, output relays, auxiliary relays (incl. output which are obtained by the ladder circuit program calculation in the measurement processing cycle), timer and counter.

(3) Output refresh

The ON/OFF data of the output relays, obtained in calculation (2), is output to the parallel output terminals (Y0 to Y7).

- The processing time for the three steps described above is called "1PC scan time," and ranges from 0.3 to 3.0 ms, depending on the settings.

[3] Measurement processing cycle

When the measurement start input signal is given, the measurement processing is carried out, and the calculations of the ladder circuit program for measurements 0 to 3 are executed.

(1) Measurement processing (measurement 0 to 4)

- The coordinates, distance, and degree of match are determined by the measurement programs. If the numerical calculation conditions have been set, calculations will be executed.
- Each measurement obtained is judged to be OK or NG, based on the criteria entered by the user. If it is OK, 1 (ON) will be used as the input condition for the following calculation on the ladder circuit, and if it is NG, 0 (OFF) will be used.

(2) Ladder circuit calculation (based on output conditions for measurements 0 to 4)

- The values obtained from the measurement processing are used as the input conditions for the ladder circuit. Calculations will be executed by a ladder circuit. The output relays are the auxiliary relays that will be used for calculation by the ladder circuit in the PC scan cycle.

■ The relationship between the ladder circuit in the measurement processing cycle and the ladder circuit in the PC scan cycle

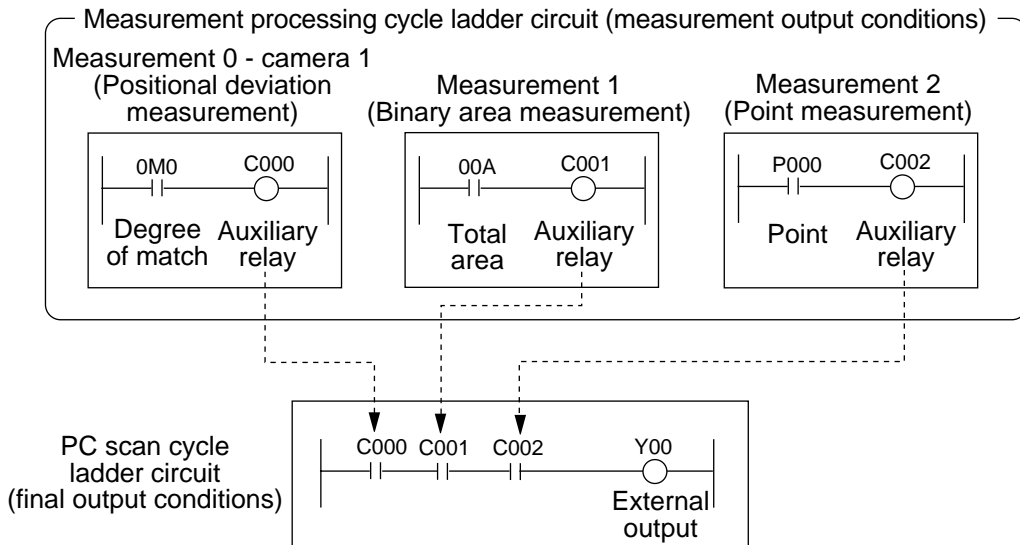

Notes

- 128 auxiliary relays, C000 to C127, can be set. However, identical auxiliary relay numbers cannot be used for measurement 0 using camera 1, and measurement 0 using camera 2, or for measurement 1, measurement 2, measurement 3 and measurement 4.
- The auxiliary relays C110 to C127 are special relays. The special relays are used on the PC scan cycle ladder circuit. Do not use them for the measurement processing cycle ladder circuit.

16-3 Ladder circuit program creation

[1] Procedure for creating measurement output condition and a ladder circuit

A separate ladder circuit can be created for positional deviation measurement, degree of match inspection, lead inspection, BGA/CSP inspection, area measurement by binary conversion, object counting by binary conversion, object identification by binary conversion, point measurement, multiple position measurement, and multiple degree of match inspection.

The procedure for creating a ladder circuit for positional deviation measurement is given below. A ladder circuit can be created the same way for other measurement just change the input contact point setting.

(1) How to display the output conditions setting screen.

There are two methods for displaying the output conditions setting screen, as follows.

1. On the menu tree, open the sub menu at "MEAS01(POSI-DEVIATION)." Press the SET key on the "OUT-COND" line.

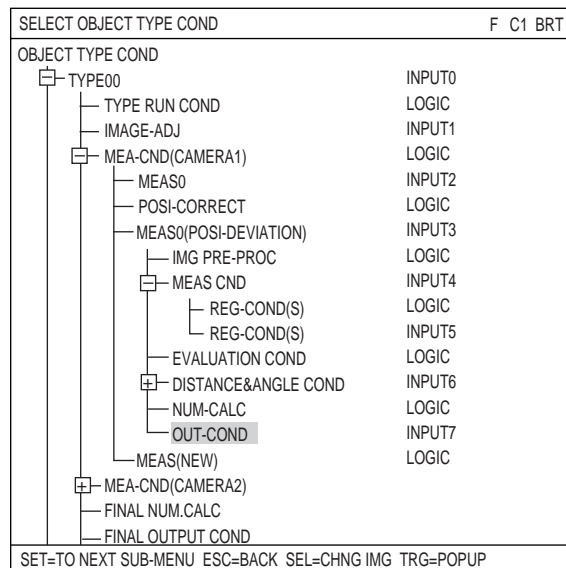

2. On the screen used for selecting the measurement program, or on the screens used for setting the measurement conditions or the register conditions, press the TRG/BRT key to move the cursor to the upper function menu. Then, move the cursor to the "COND" and press the SET key. Select "OUT" from the popup menu.

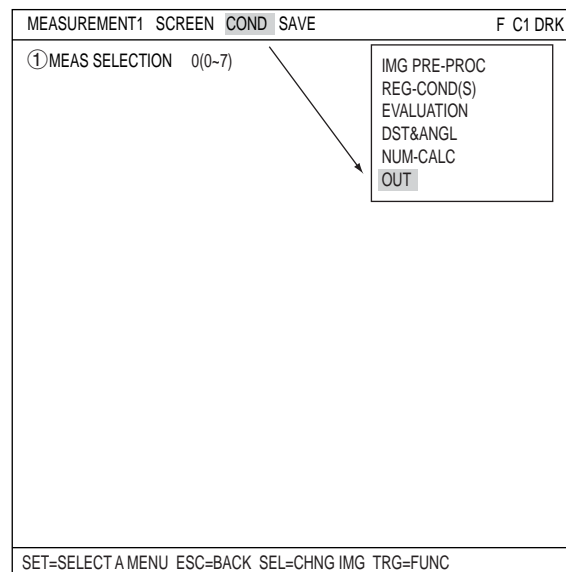

(2) How to specify the input conditions for ladder circuit diagrams

1. While "CHANGE INPUT" is selected, each press of the SET key will change the display in the leftmost row. The display will cycle through the following choices: "INPUT00 to INPUT07," "INPUT08 to INPUT15," and "INPUT16 to INPUT19." When the input group you want is displayed, press the down arrow key to move the cursor to the ladder circuit display section.

2. Move the cursor to a line number (INPUTxx) and a row using the up/down/left/right arrow keys, and press the SET key. Select a type to input from the popup menu.
 ⇨ The input types for each measurement program are shown on pages 16-6 to 16-7.

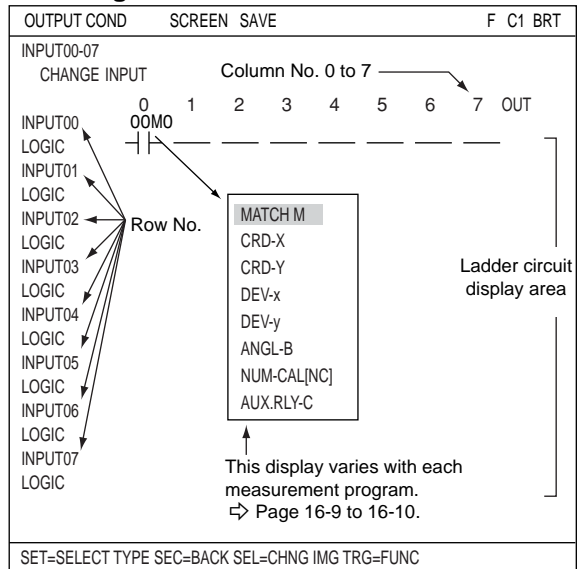

Note: "00M0" means the following:

- | | | |
|----------------|------------------------------------------------------------------------------------------------------------------------------------------------------------------|--------|
| 00M0 | MATCH M0 | (0~1) |
| | - CRD-X | (0~1) |
| | - CRD-Y | (0~1) |
| | - DEV-x0 | (0~1) |
| | - DEV-y0 | (0~1) |
| | - ANGL-B0 | (0~1) |
| | - NUM-CAL[NC]00 | (0~15) |
| - AUX.RLY-C000 | (0~127) | |
| - 0 to 3: | BGA/CSP inspection, object counting by binary conversion, object identification by binary conversion, multiple position measurement, degree of match inspection. | |
| - 0 to 7: | Positional deviation measurement | |
| - 0 to 15: | Degree of match inspection, lead inspection, area measurement by binary conversion, distance and angle measurement | |
| - 0 to 127: | Point measurement (average) | |
| - 0 to 255: | Point measurement (binary conversion) | |

3. After selecting an input type, press the SET key and move the cursor to a logic line.

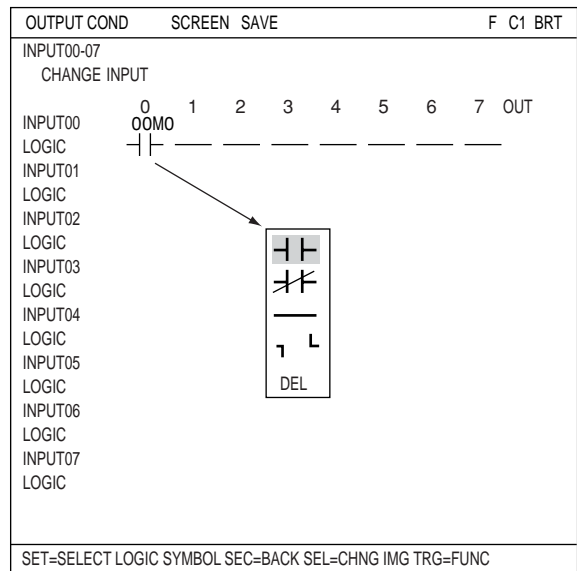

4. Press the SET key and select a logic symbol from the popup menu.

Logic symbol	Function
	a contact on a series circuit (ON, when the evaluation result is OK)
	b contact on a series circuit (OFF, when the evaluation result is OK)
	Deletes a contact on the cursor. (Contacts after the deleted contact will not be brought forward.) Note: This symbol cannot be used on the first row.
	Used to create an OR circuit.
	Used to create an OR circuit
DEL	Deletes the contact on the cursor. (Contacts after the deleted contact will be brought forward.) When a contact exists only on the first row, if the contact is deleted, also the output relay will be deleted.

(3) How to specify the output conditions for ladder circuit diagrams

Move the cursor to the "OUT" row for the desired line number and press the SET key. Press the SET key while the cursor is on "AUX-RLY" and select the auxiliary relays you want to use from the table that is displayed.

Note: Only the lines which have a specified input signal can be selected for output.

OUTPUT COND	SCREEN	SAVE	F	C1	BRT				
INPUT00-07	CHANGE INPUT								
	0	1	2	3	4	5	6	7	OUT
INPUT00	O0M0								
LOGIC									
INPUT01	-----								
LOGIC	AUX-RLY		Use place						
INPUT02	-----								
LOGIC	C000 NO								
INPUT03	C001 NO								
LOGIC	C002 NO								
INPUT04	C003 NO								
LOGIC	C004 NO								
INPUT05	C005 NO								
LOGIC	C006 NO								
INPUT06	C007 NO								
LOGIC	C007 NO								
INPUT07	-----								

Creation example:

	0	1	2	3	4	5	6	7	OUT
INPUT00	O0M0								C000
LOGIC									

(4) Creating a ladder circuit is complete

Create a ladder circuit for the page numbers registered in step (1), repeating the operations in steps (2) and (3).

Creation example:

	0	1	2	3	4	5	6	7	OUT
INPUT0	O0M0	C001							C000
LOGIC									
INPUT1	O0X0								
LOGIC									
INPUT2	N01	N02							C001
LOGIC									
INPUT3	N03	N04							
LOGIC									

Note: Output relays cannot be used in series on a ladder circuit. Change circuit a to circuit b.

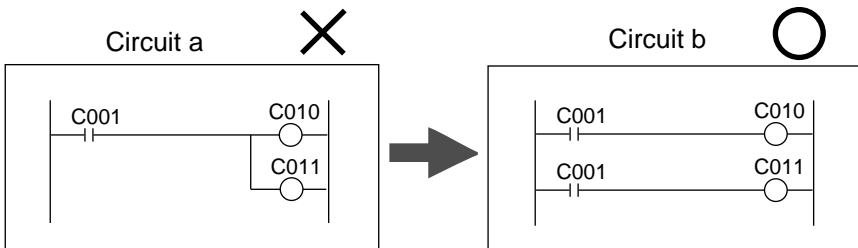

■ Kinds of input signals in each measurement program

Kind of input	Symbol	Measurement program			
		Positional deviation measurement	Degree of match inspection	Lead inspection	Point measurement
Degree of match	M	Model 0: 00M0 to 07M0 Model 1: 00M1 to 07M1	Model 0 : 00M0 to 15M0 Model 1 : 00M1 to 15M1		
Coordinate	X	Model 0: 00X0 to 07X0 Model 1: 00X1 to 07X1	Model 0 : 00X0 to 15X0 Model 1 : 00X1 to 15X1		
Coordinate	Y	Model 0: 00Y0 to 07Y0 Model 1: 00Y1 to 07Y1	Model 0 : 00Y0 to 15Y0 Model 1 : 00Y1 to 15Y1		
Deviation	x	Model 0: 0x0 to 7x0 Model 1: 0x1 to 7x1			
Deviation	y	Model 0: 0y0 to 7y0 Model 1: 0y1 to 7y1			
Angle	B	0B to 7B			
Light level	G		Model 0 : 00G0 to 15G0 Model 1 : 00G1 to 15G1		
Number of objects	K			00K to 15K	
Distance	D			00D to 15D	
Lead width	W			00W to 15W	
Lead length / lead width 2	L			00L to 15L	
Binary point					P000 to P255
Average light level point					P000 to P127
Numerical calculation results	N	N0 to N15	N0 to N15	N0 to N15	N0 to N15
Auxiliary relay	N	C000 to C127			

Kind of input	Symbol	Measurement program			
		BGA/CSP inspection	Area measurement by binary conversion	Object counting by binary conversion	Object identification by binary conversion
Total area	A	0A to 3A	Number of masks=1: 00A to 15A Number of masks=2: 0A to 7A Number of masks=4: 0A to 3A	0A to 3A	0A to 3A
Number of objects	K	0K to 3K		0K to 3K	0K to 3K
Area of each label	R	0MXR to 3MXR			0R000 to 0R127 ...3R000 to 3R127
Fillet diameter X	FX	0FX to 3FX			
Fillet diameter Y	FY	0FY to 3FY			
Distance between gravity centers X	DX	0DX to 3DX			
Distance between gravity centers Y	DY	0DY to 3DY			
Numerical calculation results	N	N0 to N15	N0 to N15	N0 to N15	N0 to N15
Auxiliary relay	C	C000 to C127			



Kind of input	Symbol	Measurement program	
		Multiple positions measurement	Multiple degree of match inspections
Number of objects	K	0K to 3K	0K to 3K
Numerical calculation results	N	N0 to N15	N0 to N15
Auxiliary relay	C	C000 to C127	

Kind of input	Symbol	Distance and angle measurement *
Auxiliary	H	00H to 15H
Distance	D	00D to 15D
Angle	B	00B to 15B
Numerical calculation results	N	N0 to N15
Auxiliary relay	C	C000 to C127

* The measurement programs that can use these inputs are the positional deviation measurement, degree of match measurement, object identification by binary conversion (center of gravity: YES) multiple positions measurement, and multiple degree of match inspections.

■ Auxiliary relay C000 to C127

The functions of the auxiliary relays (C000 to C127), which can be used for input and output signals, are explained below.

Relay No. (relay name)	Function	
	Use for input signals	Use for output signals
C000 to C109 (internal calculation)	- Relays for internal calculation - For the final output conditions, relays also used for output in the measurement processing cycle can be used.	
C110	Normally OFF	
C111	_____	- When C111 is ON, C000 to C109 are cleared.
C112 (Final evaluation result)	- Turned ON when all of the evaluation items have been judged OK, and turned OFF if any single item has been judged NG. - If C116 is not used, OK/NG will be displayed on the operation screen which corresponds to ON/OFF of C112. * - If an error occurs (C118 is turned ON), C112 will be turned OFF (NG).	_____
C113 (Continuous measurement start input)	_____	- When C113 is ON, continuous measurements will be executed. (Ex) When X0 is ON, continuous measurements will be executed. 
C114 (CCD trigger status output)	Output the CCD trigger status to C114, regardless of the Yes/No setting for the start of the measurement. - When "binary conversion" is specified, if the white area is 50% or more of the image, C114 will be turned ON, and if it is less than 50 %, C114 will be turned OFF. - When the "average light level" is specified, C114 will be turned ON when the image is within the specified level range, and turned OFF when it is out of the range.	_____
C115	- The same signal as the READY signal is output internally.	_____
C116 (programmable output)	_____	- If an output signal is passed to C116, the display of the OK/NG result on the operation screen will depend on the ON/OFF state of C116. (Ex.) "OK" is displayed on the operation screen when C000 is ON, and "NG" when the C000 is OFF.  - If C116 relay is not used, the display of the OK/NG result will depend on of the final evaluation result (C112). *
C117 (Illuminance monitor error)	- Turned OFF when the illumination exceeds the upper or lower warning level of the illuminance monitor set on the "MONITOR LIGHT LVL" menu. Warning light levels can be set for each of the cameras 1 and 2 separately. This relay is turned OFF when either one of them exceeds the upper or lower level.	_____
C118 (measurement operation error)	- Turned ON when a measurement processing error occurs. (However, except the end code 34/35/36/3E. ⇨ See page 20-4.)	
C119 (measurement termination)	- Turned ON upon termination of measurement processing, and turned OFF when a measurement start input signal is given.	
C120 to C127 (counter reset)	- Do not use these relays for input signals.	- They are turned ON to reset counters CN0 to CN7. C120 to C127 correspond to CN0 to CN7. Create a circuit for sending an output signal to one of these relays on the row following a row that contains a counter instruction. (Counter instruction ⇨ See page 16-14.)

* OK/NG displayed on the operation screen ⇨ See page 1-10.

[2] A list of the "OUTPUT COND" screen displays

Shown below are the "OUTPUT COND" screen displays for each program.

(1) Positional deviation measurement

⇒ See page 16-4.

(2) Degree of match inspection

OUTPUT COND	SCREEN	SAVE	F	C1	BRT
INPUT00-07 CHANGE INPUT					
	0	1	2	3	4
INPUT00	←	MATCH M			
LOGIC		CRD-X			
INPUT01		CRD-Y			
LOGIC		LVL G			
INPUT02		NUM-CAL[NC]			
LOGIC		AUX.RLY-C			
INPUT03					
LOGIC					
INPUT04					
LOGIC					
INPUT05					
LOGIC					
INPUT06					
LOGIC					
INPUT07					
LOGIC					
SET=SELECT TYPE SEC=BACK SEL=CHNG IMG TRG=FUNC					

(3) Lead inspection

OUTPUT COND	SCREEN	SAVE	F	C1	BRT
INPUT00-07 CHANGE INPUT					
	0	1	2	3	4
INPUT00	←	OBJ-K			
LOGIC		DST-D			
INPUT01		LEAD WIDTH W			
LOGIC		LEAD LENGTH L			
INPUT02		NUM-CAL[NC]			
LOGIC		AUX.RLY-C			
INPUT03					
LOGIC					
INPUT04					
LOGIC					
INPUT05					
LOGIC					
INPUT06					
LOGIC					
INPUT07					
LOGIC					
SET=SELECT TYPE SEC=BACK SEL=CHNG IMG TRG=FUNC					

(4) BGA/CSP inspection

OUTPUT COND	SCREEN	SAVE	F	C1	BRT
INPUT00-07 CHANGE INPUT					
	0	1	2	3	4
INPUT00	←	TOTAL-AREA-A			
LOGIC		OBJ-K			
INPUT01		OBJECT-AREA-R			
LOGIC		FILT-X FX			
INPUT02		FILT-Y FY			
LOGIC		GRAV C DIST DX			
INPUT03		GRAV C DIST DY			
LOGIC		NUM-CAL[NC]			
INPUT04		AUX.RLY-C			
LOGIC					
INPUT05					
LOGIC					
INPUT06					
LOGIC					
INPUT07					
LOGIC					
SET=SELECT TYPE SEC=BACK SEL=CHNG IMG TRG=FUNC					

(5) Area measurement by binary conversion

OUTPUT COND	SCREEN	SAVE	F	C1	BRT
INPUT00-07 CHANGE INPUT					
	0	1	2	3	4
INPUT00	←	TOTAL-AREA-A			
LOGIC		NUM-CAL[NC]			
INPUT01		AUX.RLY-C			
LOGIC					
INPUT02					
LOGIC					
INPUT03					
LOGIC					
INPUT04					
LOGIC					
INPUT05					
LOGIC					
INPUT06					
LOGIC					
INPUT07					
LOGIC					
SET=SELECT TYPE SEC=BACK SEL=CHNG IMG TRG=FUNC					

(6) Object counting by binary conversion

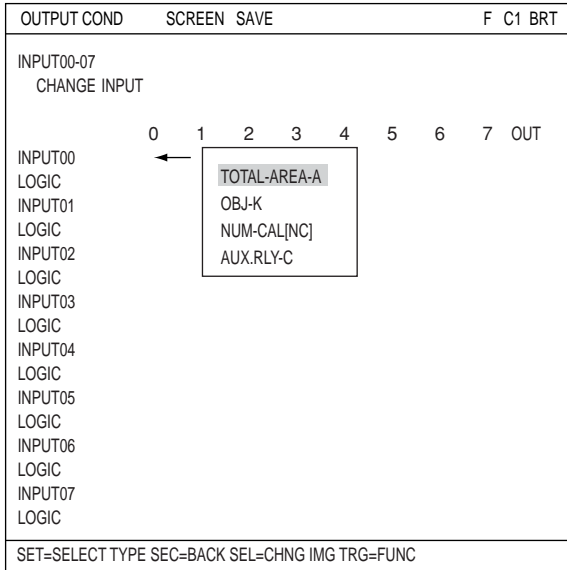

(7) Object identification by binary conversion

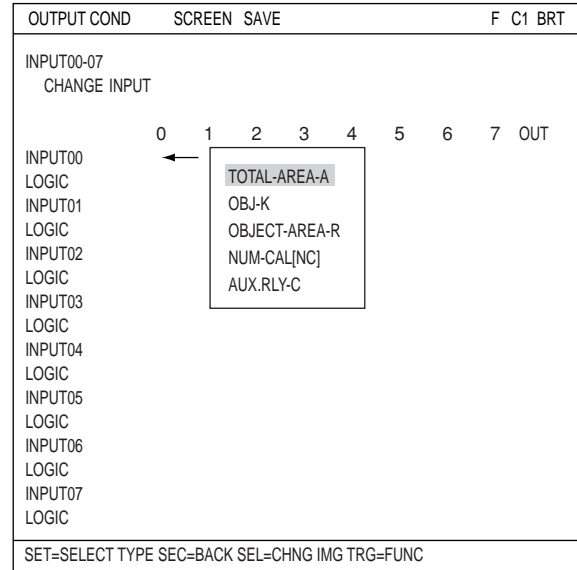

(8) Point measurement

- When "BINARY" is selected in "MODE" line.

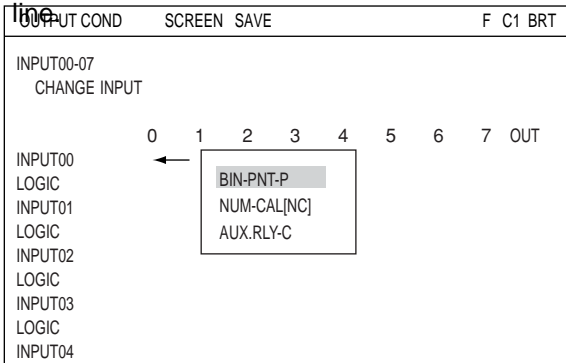

- When "AVG-GRAY" is selected in "MODE" line.

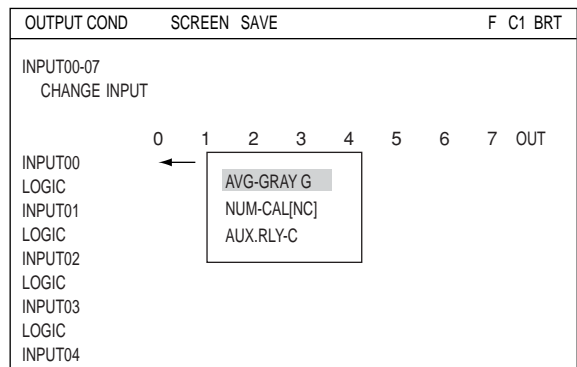

(9) Multiple positions measurementII

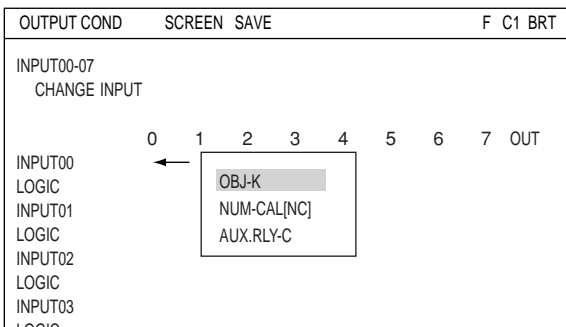

(10) Multiple degree of match inspections

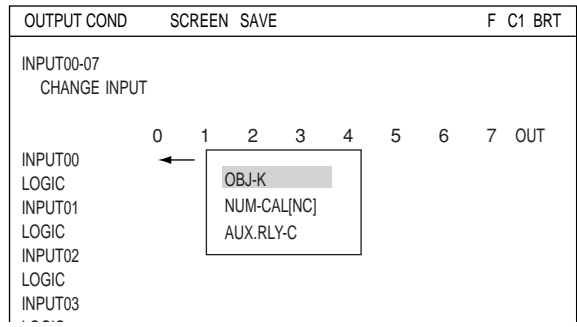

(11) Distance and angle measurement

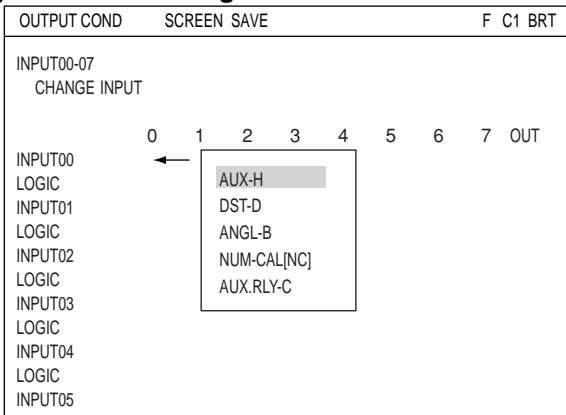

[3] Procedure for creating the final output conditions in a ladder circuit

This section describes the ladder circuit creation procedures for each object type number.

(1) How to display the final output conditions setting screen

1. Select an object type from 00 to 15 on the menu tree and then move the cursor to "FINAL OUTPUT COND." Press the SET key.

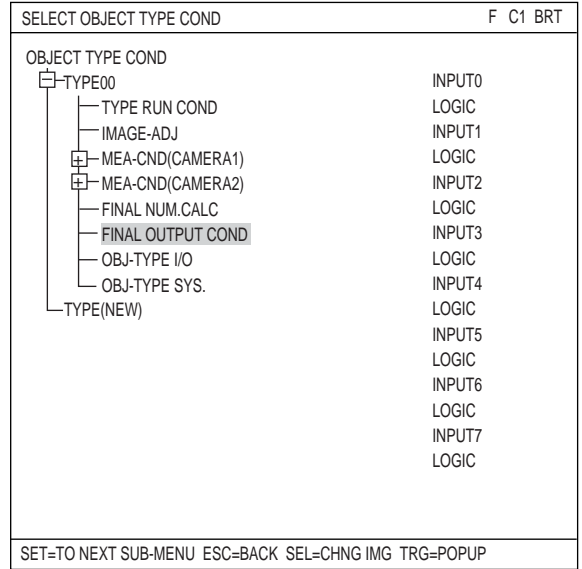

2. The "OUTPUT COND" screen will appear.

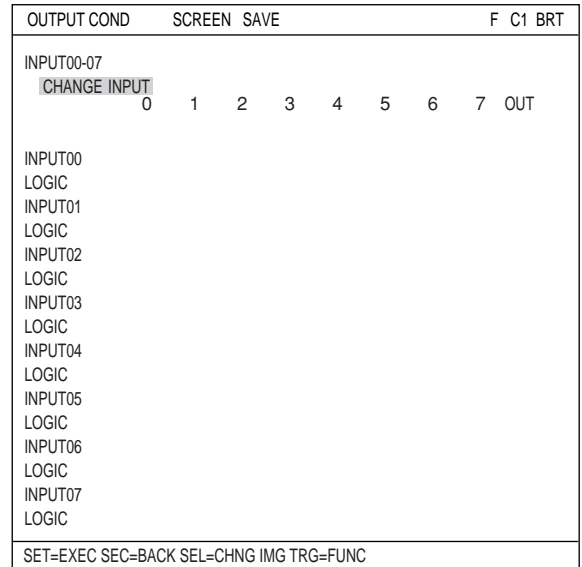

(2) How to specify the input conditions for ladder circuit diagrams

1. While "CHANGE INPUT" is selected, each press of the SET key will change the display in the leftmost row. The display will cycle through the following choices: "INPUT00 to INPUT07," "INPUT08 to INPUT15," "INPUT16 to INPUT23," and "INPUT24 to INPUT31." When the input group you want is displayed, press the down arrow key to move the cursor to the ladder circuit display section.
2. Move the cursor to a line number (INPUTxx) and a row using the up/down/left/right arrow keys, and press the SET key. Select a type to input from the popup menu.

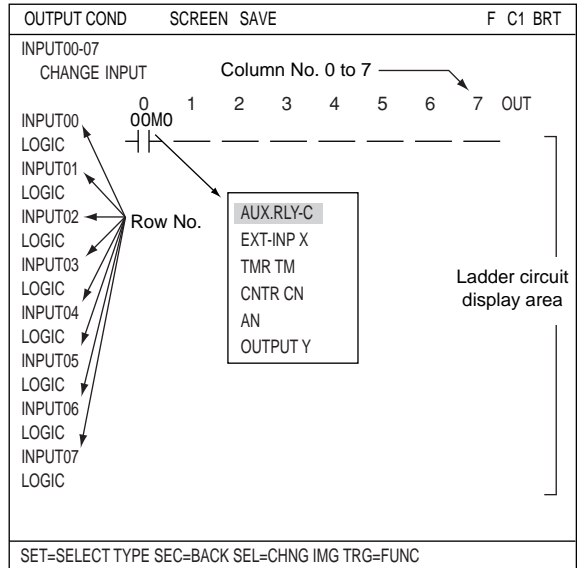

3. After selecting an input type, press the SET key and move the cursor to a logic line.
4. Press the SET key and select a logic symbol from the popup menu.

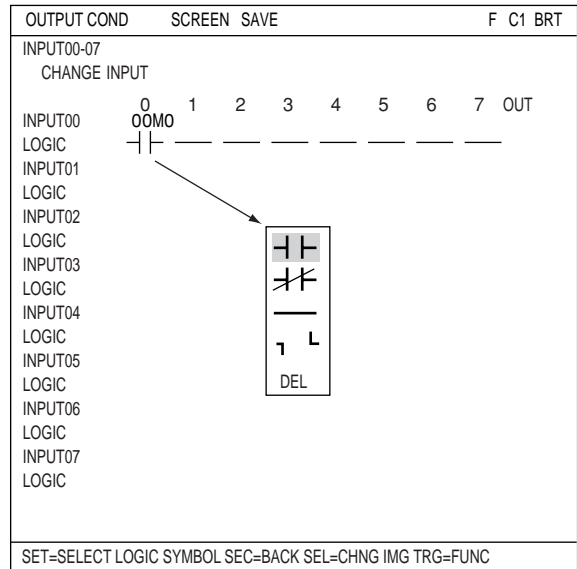

Logic symbol	Function
	a contact on a series circuit (ON, when the evaluation result is OK)
	b contact on a series circuit (OFF, when the evaluation result is OK)
	Deletes a contact on the cursor. (Contacts after the deleted contact will not be brought forward.) Note: This symbol cannot be used on the first row.
	Used to create an OR circuit.
	Used to create an OR circuit
DEL	Deletes the contact on the cursor. (Contacts after the deleted contact will be brought forward.) When a contact exists only on the first row, if the contact is deleted, also the output relay will be deleted.

(3) How to specify the output conditions for ladder circuit diagrams

Move the cursor to "OUT" and press the SET key. Select a target for the output signals from the popup menu. Detail of the registration table that will appear varies, depending on the target selected for output.

When "OUTPUT Y" is selected

OUTPUT COND	SCREEN	SAVE	F	C1	BRT				
INPUT00-07 CHANGE INPUT									
	0	1	2	3	4	5	6	7	OUT
INPUT00	O0M0								
LOGIC									
INPUT01	-----								
LOGIC	AUX-RLY			Use place					
INPUT02	-----								
LOGIC	Y0			NO					
INPUT03	Y1			NO					
LOGIC	Y2			NO					
INPUT04	Y3			NO					
LOGIC	Y4			NO					
INPUT05	Y5			NO					
LOGIC	Y6			NO					
INPUT06	Y7			NO					
LOGIC	Y7			NO					
INPUT07	-----								
LOGIC	-----								
<div style="border: 1px solid black; padding: 2px; display: inline-block;"> OUTPUT Y AUX-RLY-C TMR TM CNTR CN DEL </div>									
SET=SELECT OUTPUT RELAY SEC=BACK SEL=CHNG IMG TRG=FUNC									

When "AUX.RLY-C" is selected

OUTPUT COND	SCREEN	SAVE	F	C1	BRT				
INPUT00-07 CHANGE INPUT									
	0	1	2	3	4	5	6	7	OUT
INPUT00	O0M0								
LOGIC									
INPUT01	-----								
LOGIC	Y OUTPUT			Use place					
INPUT02	-----								
LOGIC	C000			NO					
INPUT03	C001			NO					
LOGIC	C002			NO					
INPUT04	C003			NO					
LOGIC	C004			NO					
INPUT05	C005			NO					
LOGIC	C006			NO					
INPUT06	C007			NO					
LOGIC	C007			NO					
INPUT07	-----								
LOGIC	-----								
<div style="border: 1px solid black; padding: 2px; display: inline-block;"> OUTPUT Y AUX-RLY-C TMR TM CNTR CN DEL </div>									
SET=SELECT OUTPUT RELAY SEC=BACK SEL=CHNG IMG TRG=FUNC									

When "TMR TM" is selected

OUTPUT COND	SCREEN	SAVE	F	C1	BRT				
INPUT00-07 CHANGE INPUT									
	0	1	2	3	4	5	6	7	OUT
INPUT00	O0M0								
LOGIC									
INPUT01	-----								
LOGIC	TM TIME REG			Use place					
INPUT02	-----								
LOGIC	TMO			NO					
INPUT03	TM1			NO					
LOGIC	TM2			NO					
INPUT04	TM3			NO					
LOGIC	TM4			NO					
INPUT05	TM5			NO					
LOGIC	TM6			NO					
INPUT06	TM7			NO					
LOGIC	TM7			NO					
INPUT07	-----								
LOGIC	-----								
<div style="border: 1px solid black; padding: 2px; display: inline-block;"> OUTPUT Y AUX-RLY-C TMR TM CNTR CN DEL </div>									
SET=SELECT OUTPUT RELAY SEC=BACK SEL=CHNG IMG TRG=FUNC									

When "CNTR CN" is selected

OUTPUT COND	SCREEN	SAVE	F	C1	BRT				
INPUT00-07 CHANGE INPUT									
	0	1	2	3	4	5	6	7	OUT
INPUT00	O0M0								
LOGIC									
INPUT01	-----								
LOGIC	TM TIME REG			Use place					
INPUT02	-----								
LOGIC	CNO			NO					
INPUT03	CN1			NO					
LOGIC	CN2			NO					
INPUT04	CN3			NO					
LOGIC	CN4			NO					
INPUT05	CN5			NO					
LOGIC	CN6			NO					
INPUT06	CN7			NO					
LOGIC	CN7			NO					
INPUT07	-----								
LOGIC	-----								
<div style="border: 1px solid black; padding: 2px; display: inline-block;"> OUTPUT Y AUX-RLY-C TMR TM CNTR CN DEL </div>									
SET=SELECT OUTPUT RELAY SEC=BACK SEL=CHNG IMG TRG=FUNC									

Creation example:

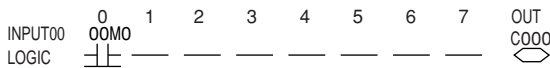

Kind of output signal	Data memory No.	Function
External output instructions	Y0 to Y7	Output to the parallel I/F, general purpose serial I/F and computer link.
	Y8 to Y15	Output to the general purpose serial I/F or computer link
Timer instructions	TM0 to TM7	<p>A timer terminal will be turned ON for a set amount of time (set value 000 to 999, unit 10 ms) after the timer instruction is input. (Decrementing type) When the timer instruction input is turned OFF, the timer terminal will be turned OFF.</p> <p>[Ex.]</p> <p>Legend: C001 ← Timer instruction TM0 ← Timer set value (2.5 sec.) Y00 ← Output instruction (external output)</p>
Counter instructions	CN0 to CN7	<p>While the counter reset relay is OFF, if a counter instruction input is cycled from OFF to ON, the number of times you set (set value 000 to 999), the counter terminal will be turned ON. (Decrementing type) When the counter reset relay is turned ON, the counter terminal is turned OFF.</p> <p>Create a circuit to turn the counter reset relay ON and OFF on the row following a row that containing a counter instruction.</p> <p>[Ex.]</p> <p>Legend: C002 ← Counter instruction 0003 ← Counter set value C120 ← Resetting the CN0 Y01 ← Output instruction (external output)</p>
Deletion		The output relay on the row where the cursor is located will be deleted.

- See page 16-8 for details about the auxiliary relays C000 to C127.

(4) Creating a ladder circuit is complete

Create a ladder circuit for the page numbers registered in step (1), repeating the operations in steps (2) and (3).

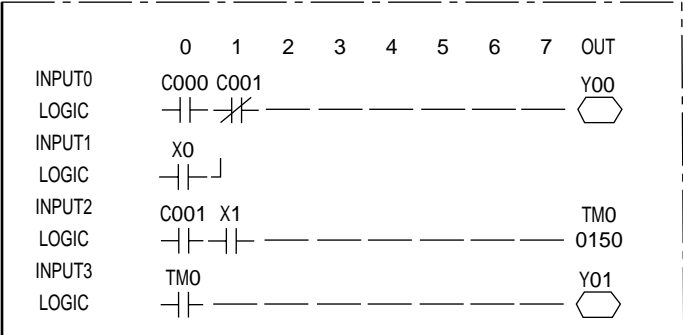

Note: Output relays cannot be used in series on a ladder circuit. Change circuit a to circuit b.

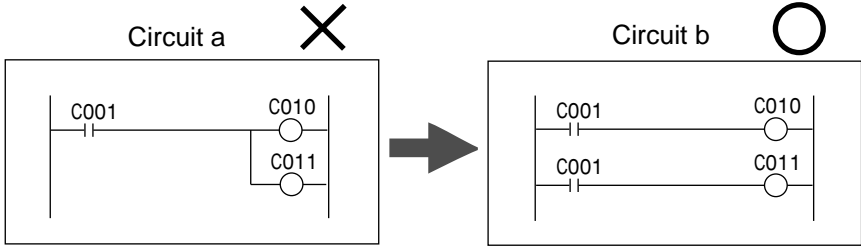

16-4 Program examples (shape and positional deviation inspection)

(1) Outline

The positional deviation measurement (one point search) in measurement 0 allows the degree of match and coordinates to be measured, and the result, OK or NG, is output.

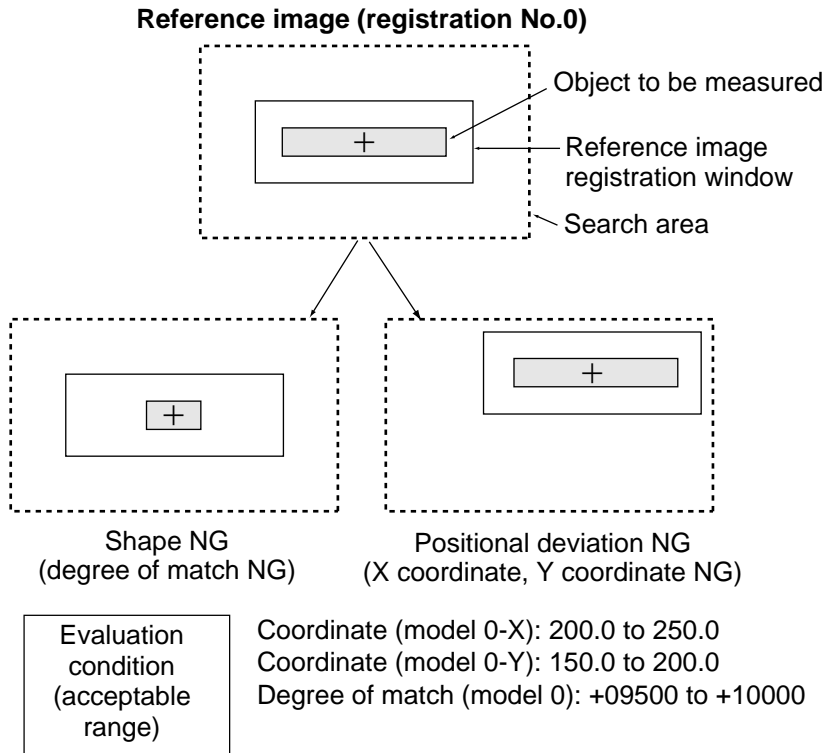

(2) Output conditions and ladder circuit for measurement 0 using camera 1

When the X coordinate, Y coordinate and degree of match are within acceptable ranges, the auxiliary relay C000 is turned ON.

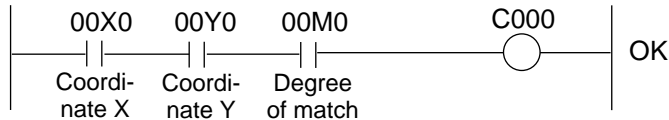

(3) Final output conditions and ladder circuit

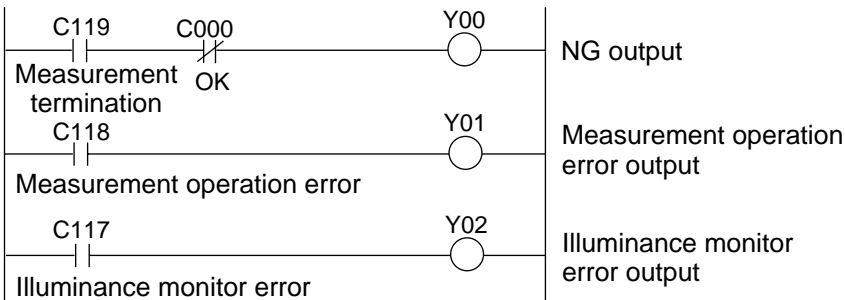

16-5 Examples of a final output conditions ladder circuit

(1) Circuit for keeping the external output ON until the next external trigger is received

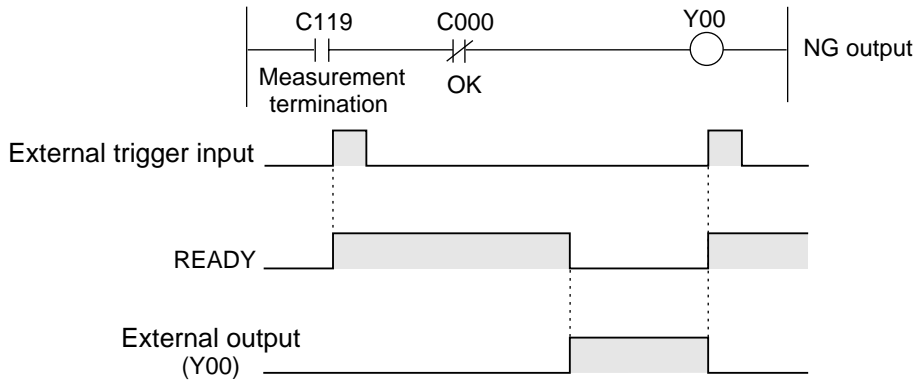

(2) Circuit for controlling the ON time of the external output using the timer

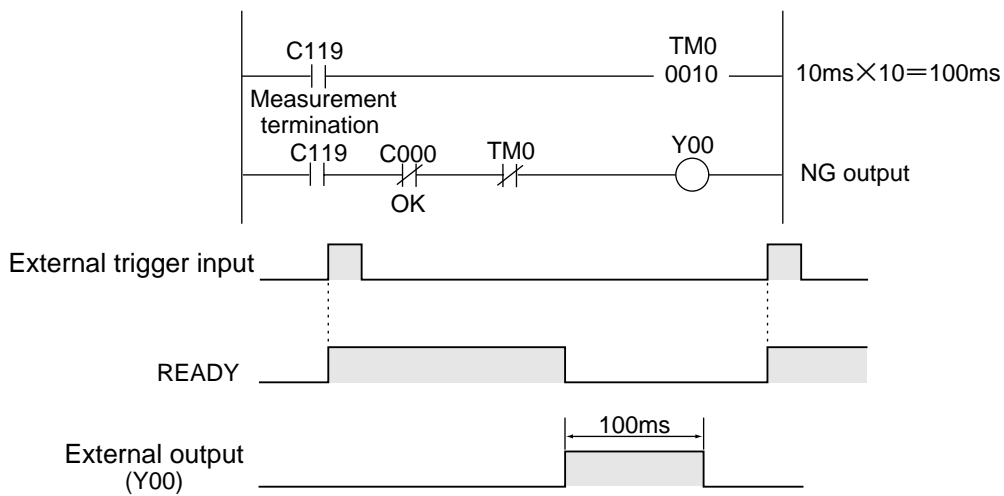

(3) An example of a circuit that can output a signal when the IV-S30 is operating normally.

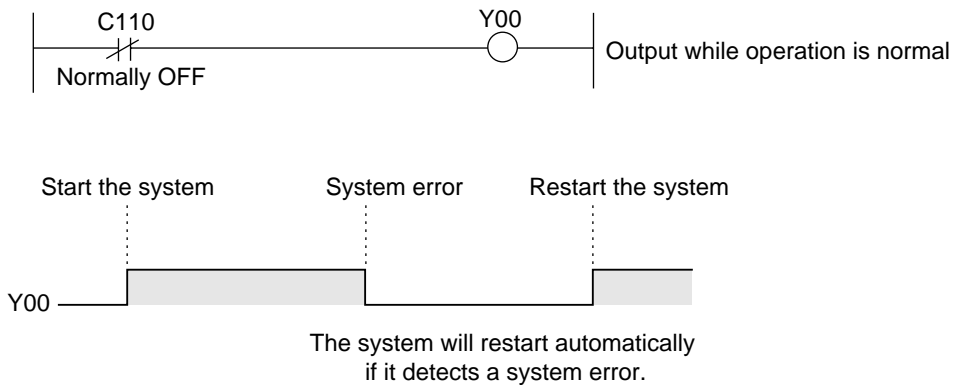

Chapter 17: Setting the Input/Output Conditions

17-1 Outline

This section describes the input and output settings on the IV-S30 when connecting it for communication with other equipment (a personal computer or a programmable controller).

How to display the "I/O CONDITIONS" setting screen

To display the "I/O CONDITIONS" screen, select "MAIN COND" -> "SYS-CND" -> "I/O CONDITIONS," in that order.

SELECT SYSTEM COND		F C1 BRT
SYS-CND		
- I/O CONDITIONS		① MEAS INP I/F
- COMM.SET		② OUT I/F(PARAL.)
- COMPUTER LINK		③ MANL TYPE CHNG
- GAIN-OFFSET		④ PARALLEL INP X6
- TIME		⑤ PARALLEL INP X7
- CAMERA TYPE		⑥ STROBE OUT
		⑦ READY'ON

How to set the input and output conditions

The items you will need to set depend on whether you selected "PARALLEL+SERIAL+USB" or "TRIG CCD START" on the "① MEAS INP I/F" line.

I/O CONDITION		SCREEN COND SAVE	F C1 BRT
① MEAS INP I/F	PARALLEL+SERIAL+USB		
② OUT I/F(PARAL.)	NO		
③ MANL TYPE CHNG	NO		
④ PARALLEL INP X6	EXT-INP		
⑤ PARALLEL INP X7	EXT-INP		
⑥ STROBE OUT	NO		
⑦ READY'ON	CAPTURE COMPLETE		

When you want to select the " PARALLEL +SERIAL+USB" on the "MEAS INP I/F" line.

① MEAS INP I/F

Select "PARALLEL+SERIAL+USB" for the interface, in order to allow an external device to provide trigger signals for the IV-S30.

I/O CONDITION		SCREEN COND SAVE	F C1 BRT
① MEAS INP I/F	PARALLEL+SERIAL+USB		
② OUT I/F(PARAL.)	NO		
③ MANL TYPE CHNG	NO		
④ PARALLEL INP X6	EXT-INP		
⑤ PARALLEL INP X7	EXT-INP		
⑥ STROBE OUT	NO		
⑦ READY'ON	CAPTURE COMPLETE		
	NO		
	Y0		
	Y1		
	Y2		
	Y3		
	Y4		
	Y5		
	Y6		
	Y7		

SET=SELECT A MENU ESC=BACK SEL=CHNG IMG TRG=FUNC

② **OUT I/F(PARAL.)**

Select a signal output interface, in order to output the measured results externally. The choices are: "NO," "PC-LINK" or "SERIAL."

NO	No connection. (No output.)
PC-LINK	Connect to the parallel input on a programmable controller.
SERIAL	Connect to a standard serial port.

③ **MANL TYPE CHNG**

The object type can be changed manually using the remote keypad on the operation screen.

NO	Means that you cannot change the object type manually on the operation screen.
YES	Means that you will be allowed to change the object type manually on the operation screen. Move the cursor to the "CHG-TYPE" item on the operation screen, and select the object type No., displayed on the upper part of the screen, using the up and down keys. ⇒ See page 1-10.

④ **PARALLEL INP X6**

Select the type of input terminal (INPUT) X6.

EXT-INP	External input: The PC function uses the terminal as an external input signal. ⇒ See Chapter 16.
REG REF	When X6 is turned from OFF to ON, and gray search is selected, the reference image will be registered in the SDRAM. When edge detection is selected, the reference coordinates will also be registered. - To store the reference image in flash memory Select the SAVE key on any sub menu or use a general purpose serial command. - Available measurement programs (gray scale search) Positional deviation measurement, the degree of match inspections for register No. 0, model 0 - Applicable measurement program (edge detection) Positional deviation measurement - If a reference image has not been specified, an "UNABLE REGISTER REF.IMG" (X6 reference image register error (code3E)) will occur.
COMPARE-IMGS	On the operation screen, when parallel input X6 is turned ON, the controller will transfer a previously registered reference image into its flash memory for use in performing calculations that compare images.
AREA EVAL CORECT	Total area evaluation correction - When X6 is ON, the upper and lower limits for the total area evaluation conditions will be corrected automatically. - Measurement programs: Area measurement, object counting, and object identification by binary conversion

⑤ **PARALLEL INP X7**

Select the type of input terminal (INPUT) X7.

Input/output condition	Setting details		
EXT-INP	The PC function uses the terminal as an external input signal. ⇒ See Chapter 16.		
CHNG-IMG-OUT-CAM	<ul style="list-style-type: none"> - Every time X7 is switched from OFF to ON, the selected camera will change. ⇒ page 2-4. - When the object type measurement condition is "CAMERA 1" only, "CAMERA 2" only, or "NG IMAGE" only, you are not allowed to change the camera used for output. 		
CAM-MEAS	<ul style="list-style-type: none"> - On starting a measurement, if X7 is OFF "CAMERA 1" will execute the measurement, and if X7 is ON Camera 2 will execute the measurement. 		
2 IMAGES	<ul style="list-style-type: none"> - Before starting a measurement, you must set the following parameters. <table border="1" style="margin-left: 20px;"> <tr> <td>Measurement execution:</td> <td> <ul style="list-style-type: none"> - MEASURE 0 CAMERA 1 conditions = Gray scale search conditions - MEASURE 1 CAMERA 2 conditions = Area conditions (dummy) </td> </tr> </table> Image selection: Camera 1 and 2 are through modes. - When "2 IMAGES (overlap)" is selected, overlap processing will be executed according to the following timing. Note: Even if "2 IMAGES (overlap)" has not been selected, and regardless of which mode Camera 1 and Camera 2 are in, when a trigger (X0: Manual trigger) is received, the measurement will be executed. 	Measurement execution:	<ul style="list-style-type: none"> - MEASURE 0 CAMERA 1 conditions = Gray scale search conditions - MEASURE 1 CAMERA 2 conditions = Area conditions (dummy)
Measurement execution:	<ul style="list-style-type: none"> - MEASURE 0 CAMERA 1 conditions = Gray scale search conditions - MEASURE 1 CAMERA 2 conditions = Area conditions (dummy) 		

⑥ **STROBE OUT**

When the strobe output setting is specified as "Y*" and the shutter is opened, the output (Y*) will be turned ON. When the shutter is closed, the output will be turned OFF.

Y*= Y0 to Y7

Note: When you want to use the strobe output, specify a shutter speed between 1/30 and 1/250 seconds.

■ **Strobe output timing**

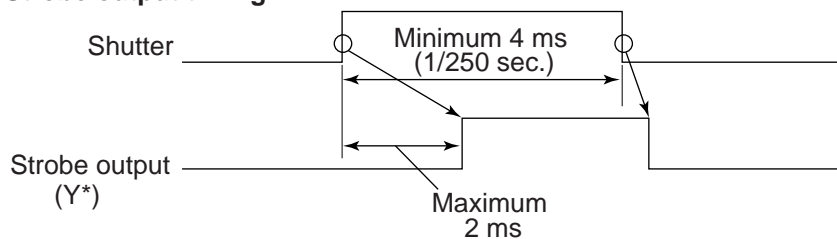

⑦ **'READY'ON**

Set the time to turn ON the READY output signal.

(When the measurement start input source is set to parallel, the object type change signal will also be parallel, and results will be output as parallel signals.)

At the end of an image capture	When the controller stops capturing the image, the READY signal turns ON.
At the end of a measurement	When the controller stops measuring, the READY signal turns ON.

● When you want to select the "TRIG CCD START" on the "MEAS INP I/F" line.

The display details and items offered for selection on line ③ will depend on the selections made on the "②START CCD SAMPL" line.

● When "AUTO(EDGE or LEVEL)" is selected

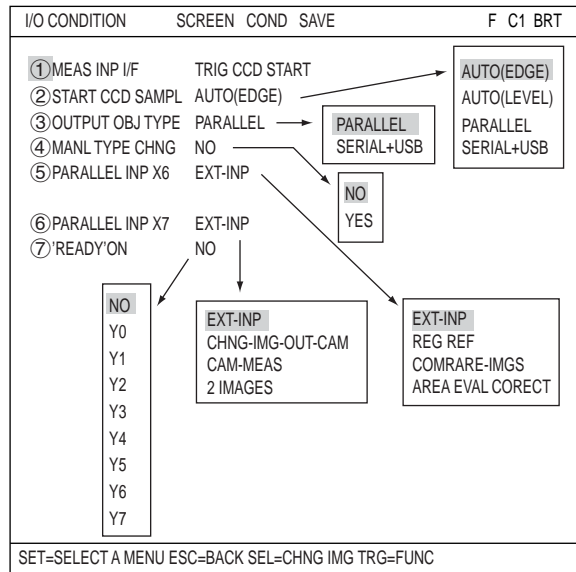

● When "PARALLEL" is selected

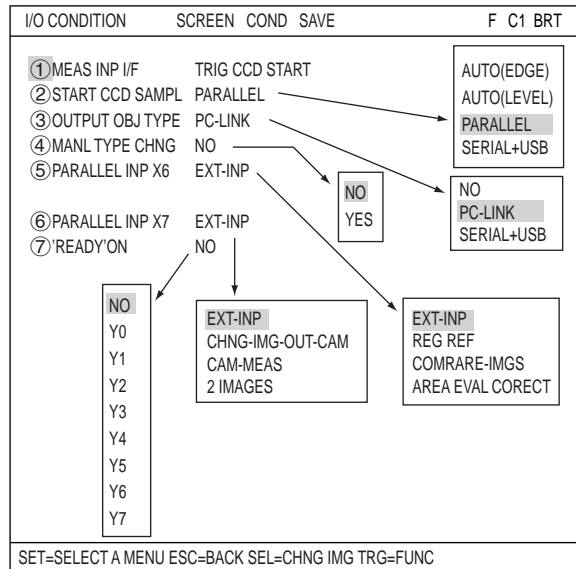

● When "SERIAL+USB" is selected

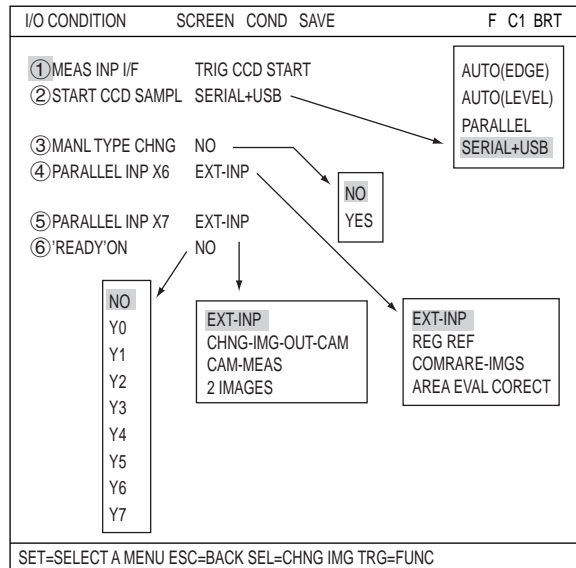

The details of the individual items on the "I/O CONDITIONS" menu are the same as described on pages 17-1 to 17-3.

17-2 Measurement start input and result output settings

The combinations of various settings for item "①MEAS INP I/F," item "②START CCD SAMPL," and item "②(③)OUT I/F (PARAL.);" on the "I/O CONDITIONS" screen (page 17-1 to 4) are explained below.

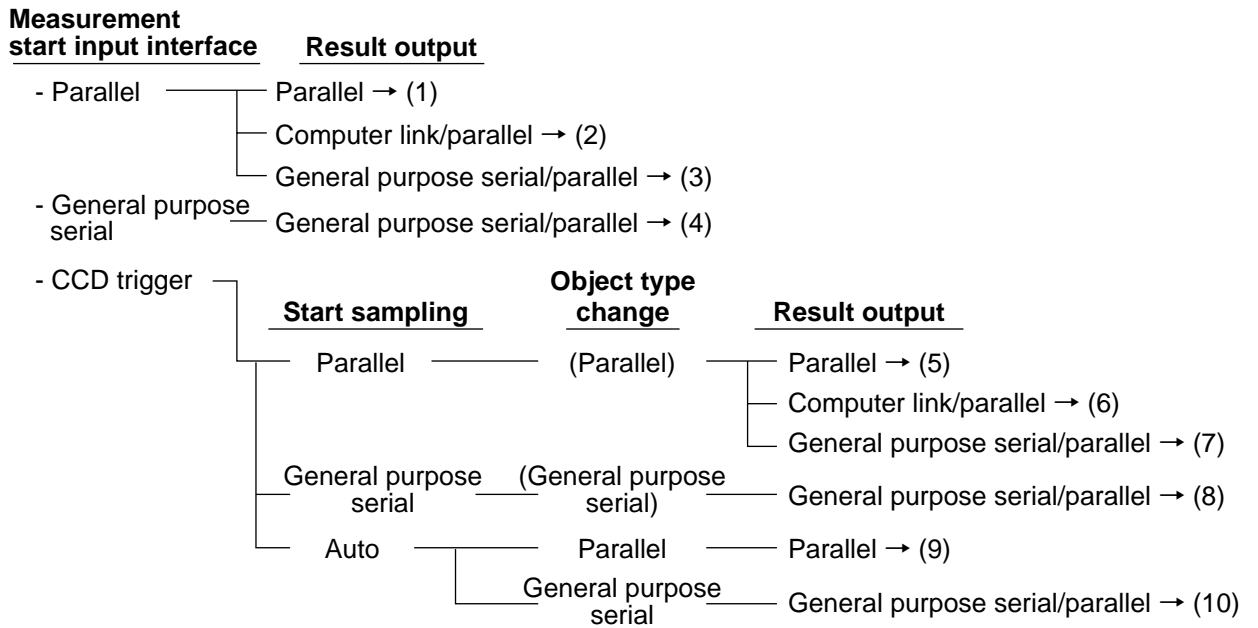

The time required to change object types is calculated differently according to the type of measurement start input I/O, as follows:

Measurement start input I/F	Time to change object type
Parallel	Included in the measurement execution time
General-purpose serial	Not included in the measurement execution time
CCD trigger	Not included in the measurement execution time

■ Object type select switch (object type input)

Controller	Input terminal (model number)
IV-S31MX	X1 to X4 (0 to 15: 16 object types)
IV-S32MX	X1 to X5 (0 to 31: 32 object types)
IV-S33MX	

(1) Measurement start input = parallel, object type change = parallel, result output = parallel

■ Setting order ① (→ ②)

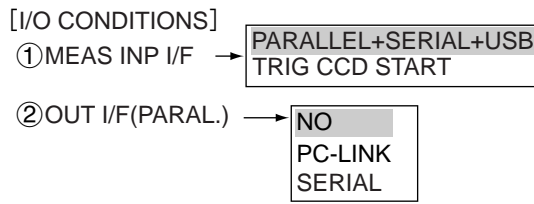

■ Configuration example

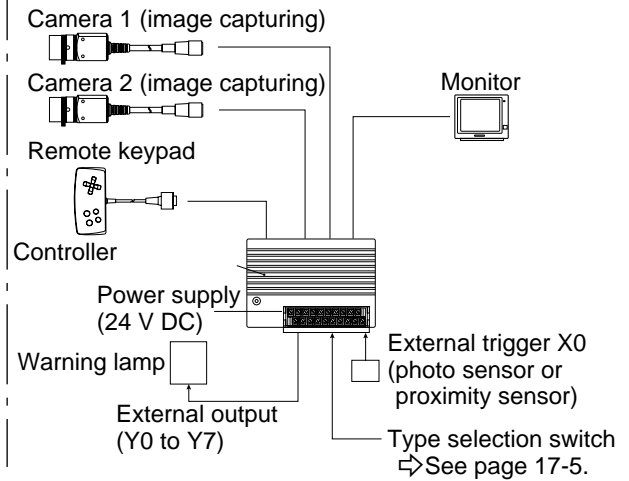

- The conditions for outputting the results to the output signals Y0 to Y7 are set by the PC function. (See "Chapter 16 PC Function.")

■ Time chart

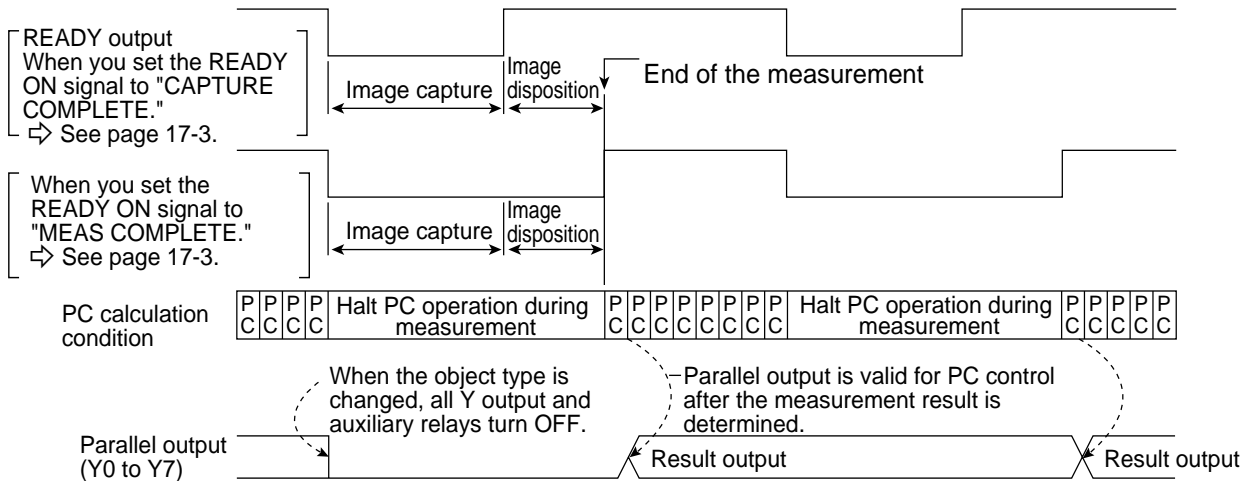
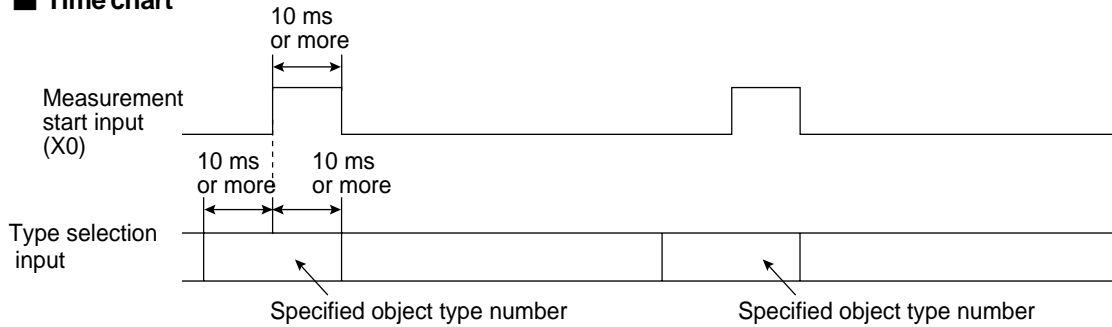

Note: When the READY signal is turned ON, the measurement start input will be enabled. To detect the end of the measurement, you have to create a ladder circuit pointing at the Y output for auxiliary relay C119 (end of the measurement).

Custom : Final output condition

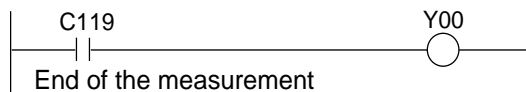

(2) Measurement start input = parallel, object type change = parallel, result output = computer link/parallel

■ Setting order ① (→ ②)

[I/O CONDITIONS]

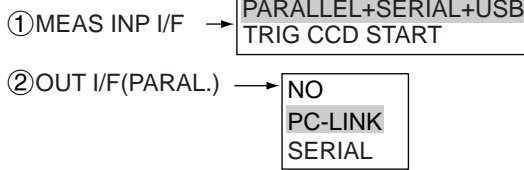

■ Configuration example

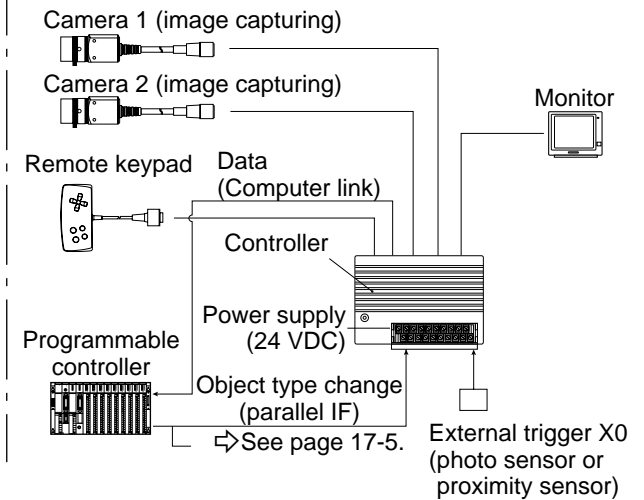

- The data in a specified block No., set in item "⑤SET SERIAL BLOCK" on the "OBJ-TYPE I/O" screen, will be output through the computer link. ⇨ See page 17-23.

■ Time chart

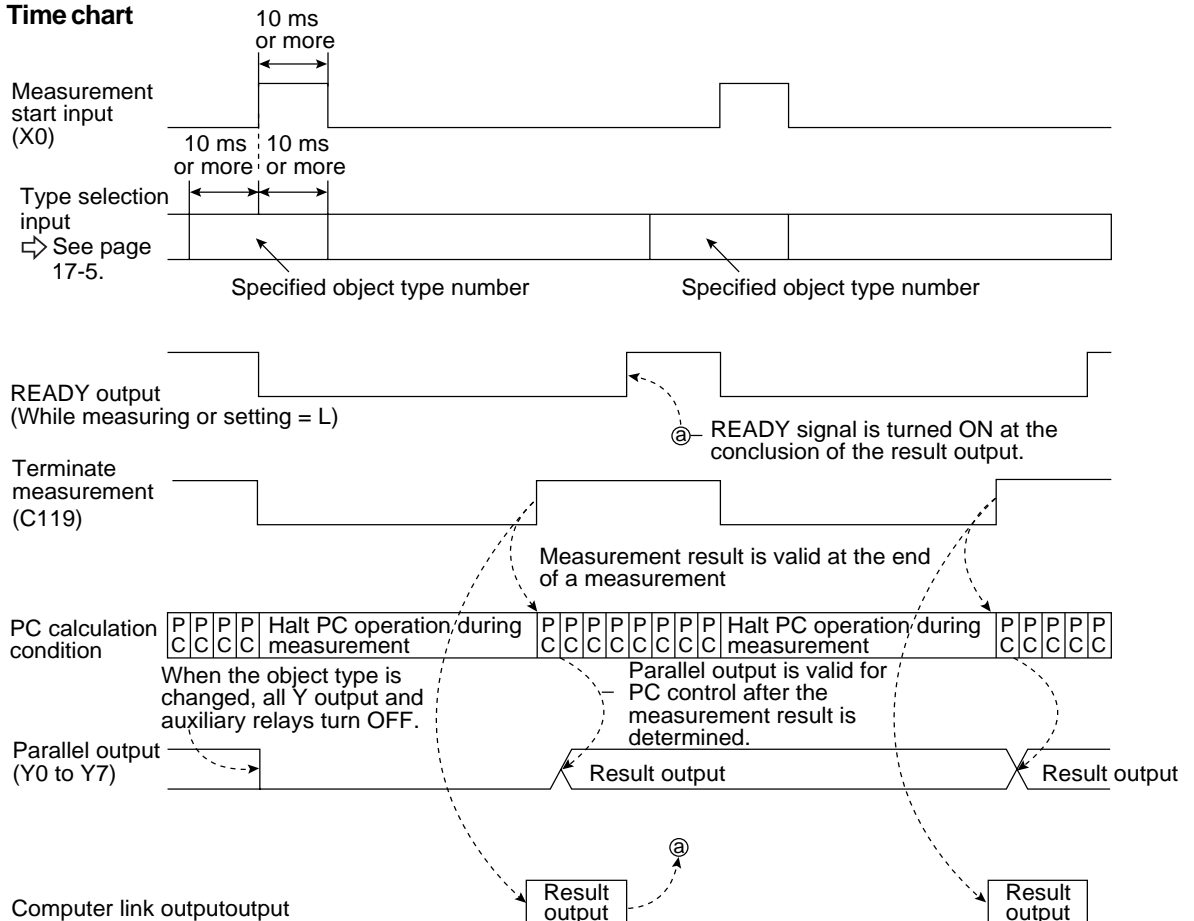

When a Sharp PC is used, a write enable command (EWR) is transmitted from the IV-S30 to the PC in the following cases.

- When the power is applied to the IV-S30.
- When a write mode nonconformity error (code 10_(H)) occurs after a result write command (WRG) is transmitted (when the power is disconnected from the PC).
- When the output method is changed from the "OUT I/F (PARAL.)" to the "COMPUTER LINK."

(3) Measurement start input = parallel, object type change = parallel, result output = general purpose serial/parallel

Setting order ① (→ ②)

[I/O CONDITIONS]

① MEAS INP I/F → PARALLEL+SERIAL+USB
TRIG CCD START

② OUT I/F(PARAL.) → NO
PC-LINK
SERIAL

Configuration example

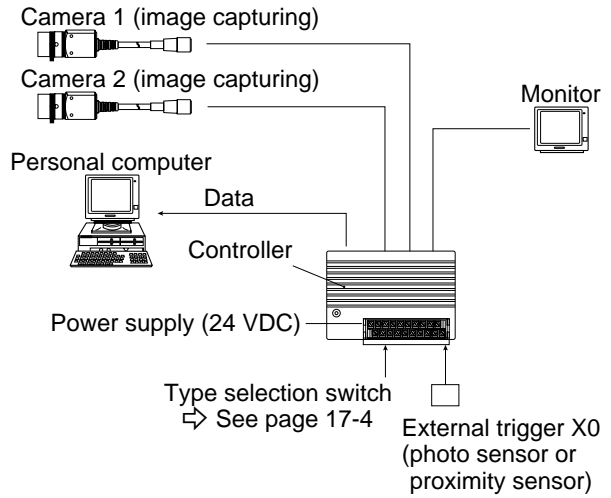

- The data in a block No., set in item "⑤SET SERIAL BLOCK" on the "OBJ-TYPE I/O" screen, will be output from the IV-S30 to the personal computer. ⇒ See page 17-23.

Time chart

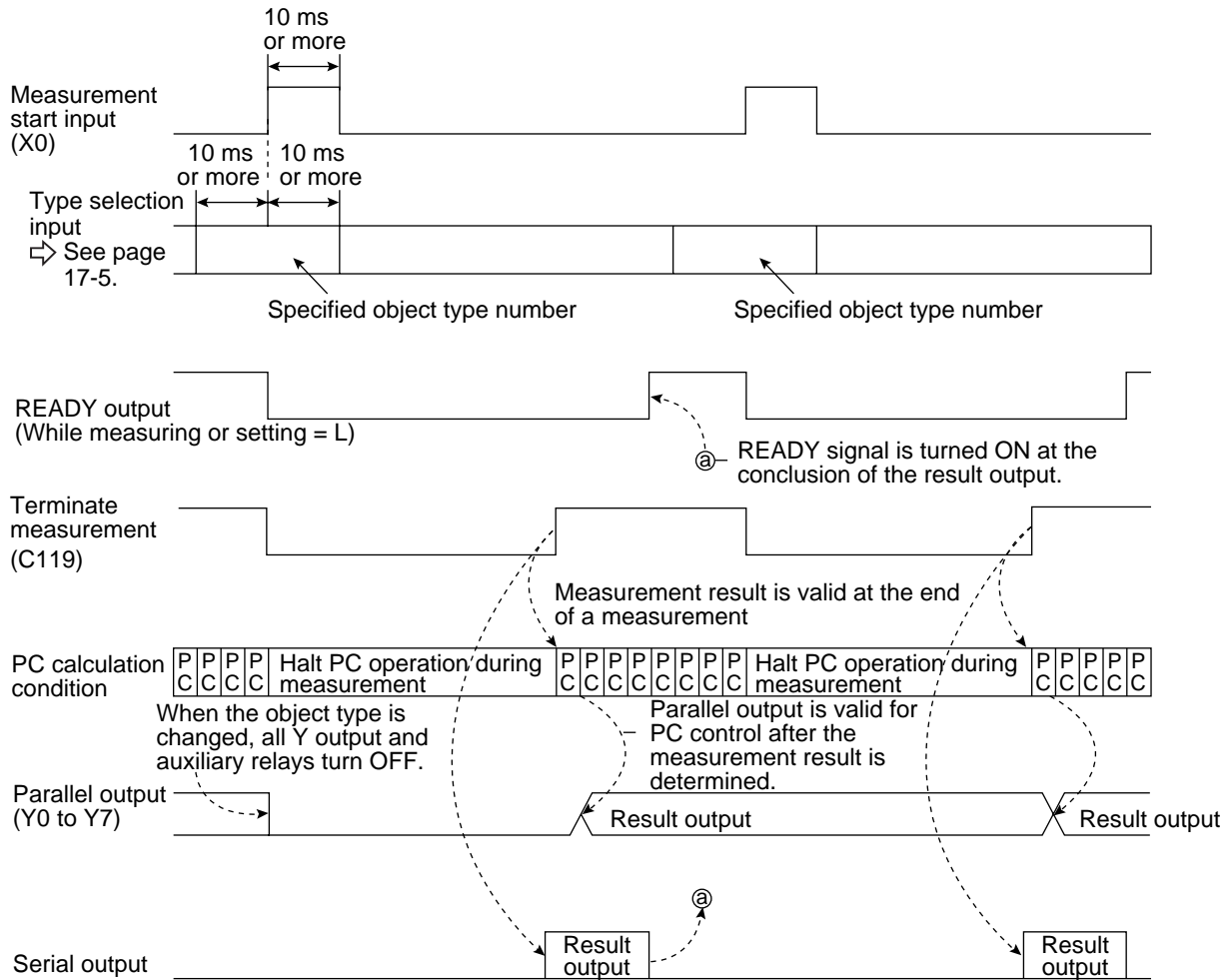

Note - Result output: The data to be sent to the personal computer will be response of general-purpose serial command (code 11_(H)).

(4) Measurement start input = general-purpose serial, object type change = general-purpose serial, result output = general-purpose serial/parallel

Setting order

[I/O CONDITIONS]



Configuration example

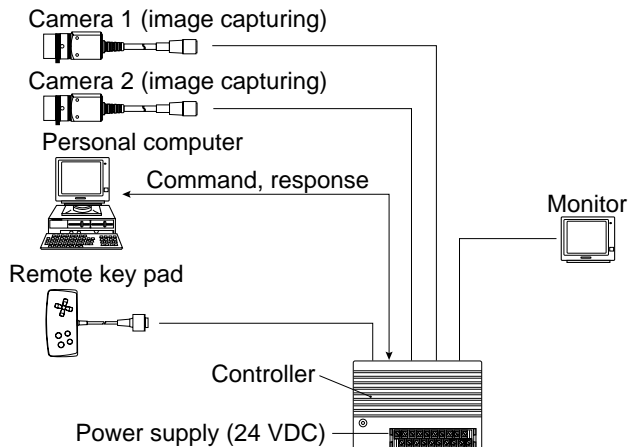

- See Chapter 18: Communications (General Purpose Serial Interface for details about the measurement execution commands (codes 10,11,12 and 14^(H)).

Time chart

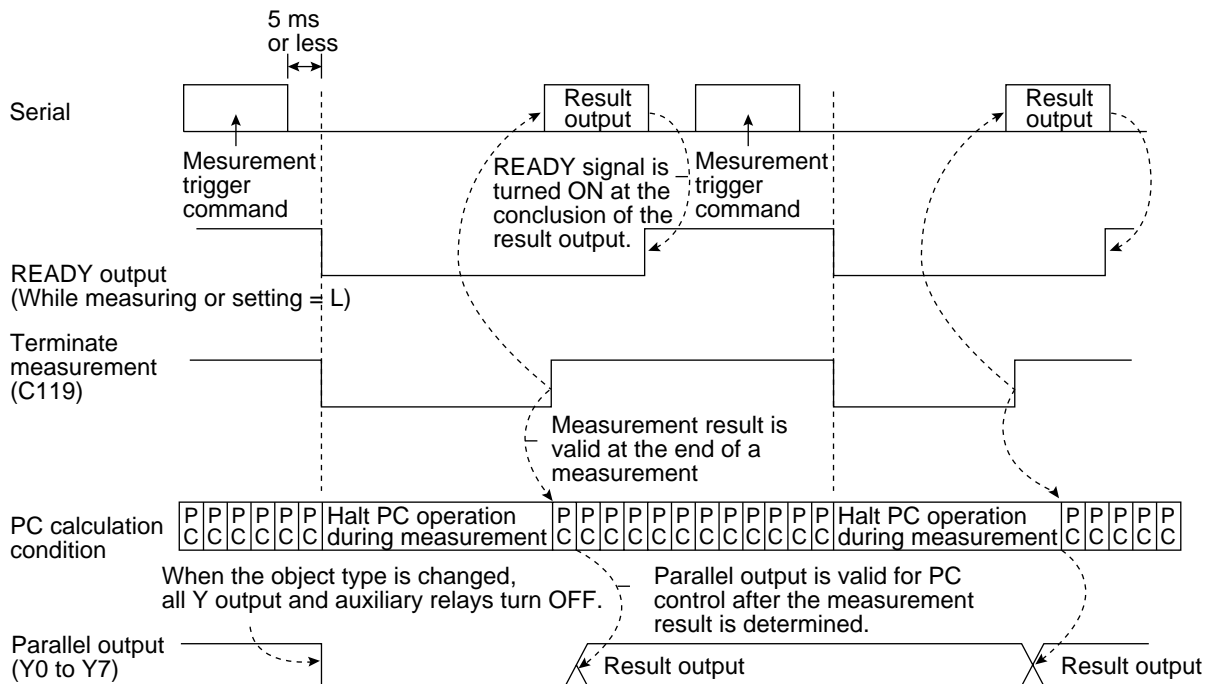

(6) Measurement start input = CCD trigger, start sampling = parallel, object type change = parallel, result output = computer link/parallel

When the start sampling input (X0) is turned ON, the CCD trigger is enabled. (Sampling starts)

Setting order ① → ② (→ ③)

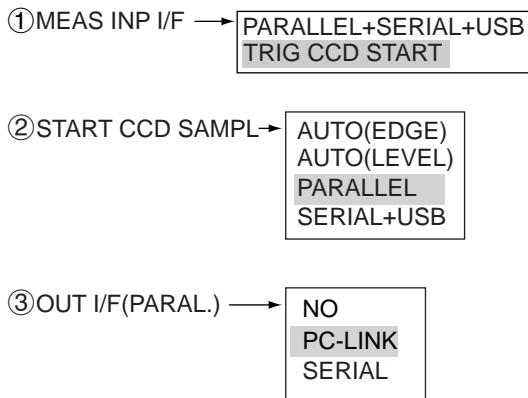

Configuration example

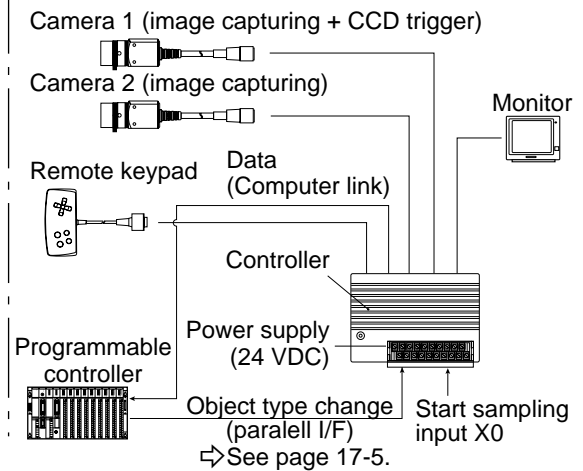

Note 1: When the settings listed in section "17-3 CCD trigger" have not been made, a "CCD TRIG NOT SET. (error 34)" will occur.

Note 2: Start sampling input (X0)

1. Sampling will be performed while this input terminal is ON. When it is turned OFF, the sampling will stop. During sampling, O will flash in the upper right corner of the operation screen.
2. After the measurement is terminated, the sampling will be restarted when the X0 terminal is changed from OFF to ON.

Time chart

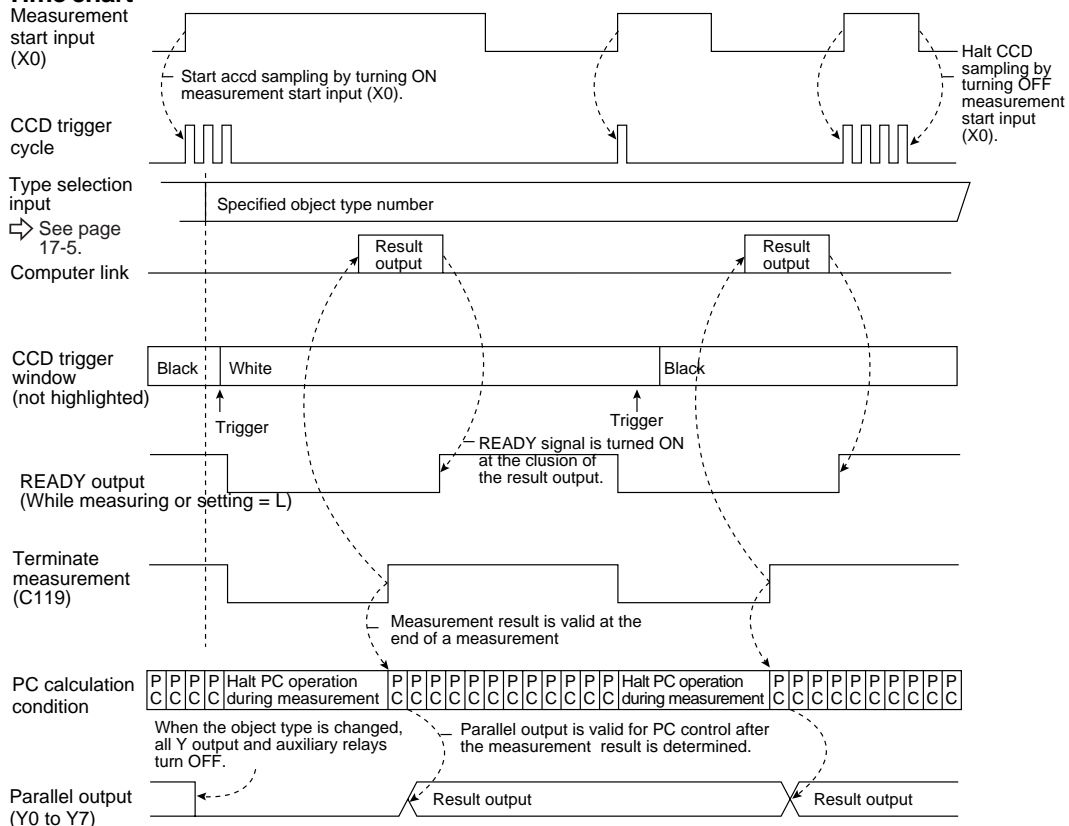

When a Sharp PC is used, a write enable command (EWR) is transmitted from the IV-S30 to the PC in the following cases.

- When the power is applied to the IV-S30.
- When a write mode nonconformity error (code 10_(H)) occurs after a result write command (WRG) is transmitted (when the power is disconnected from the PC).
- When the output method is changed from the "OUT I/F (PARAL.)" to the "COMPUTER LINK."

(7) Measurement start input = CCD trigger, start sampling = parallel, object type change = parallel, result output = general purpose serial/parallel

When the start sampling input (X0) is turned ON, the CCD trigger is enabled. (Sampling starts)

■ **Setting order** ① → ② (→ ③)

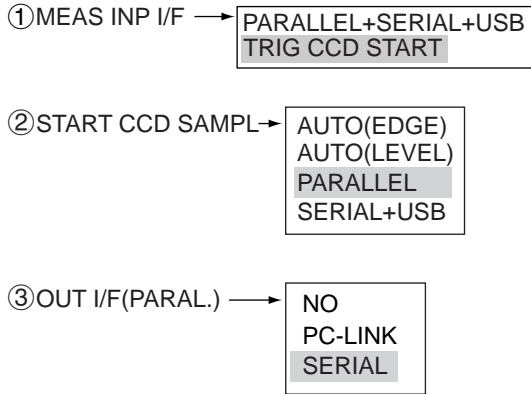

■ **Configuration example**

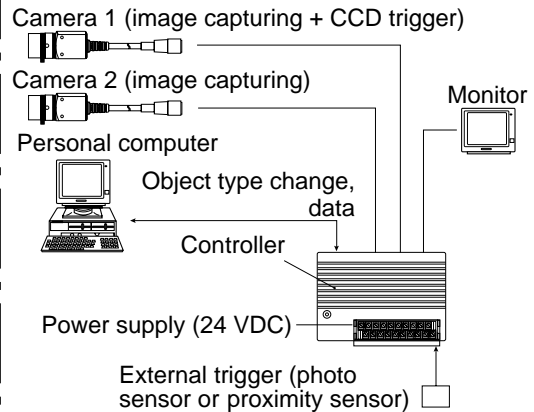

Note 1: When the settings listed in section "17-3 CCD trigger" have not been made, a "CCD TRIG NOT SET. (error 34)" will occur.

Note 2: Start sampling input (X0)

1. Sampling will be performed while this input terminal is ON. When it is turned OFF, the sampling will stop.
During sampling, O will flash in the upper right corner of the operation screen.
2. After the measurement is terminated, sampling will be restarted when the X0 terminal is changed from OFF to ON.

■ **Time chart**

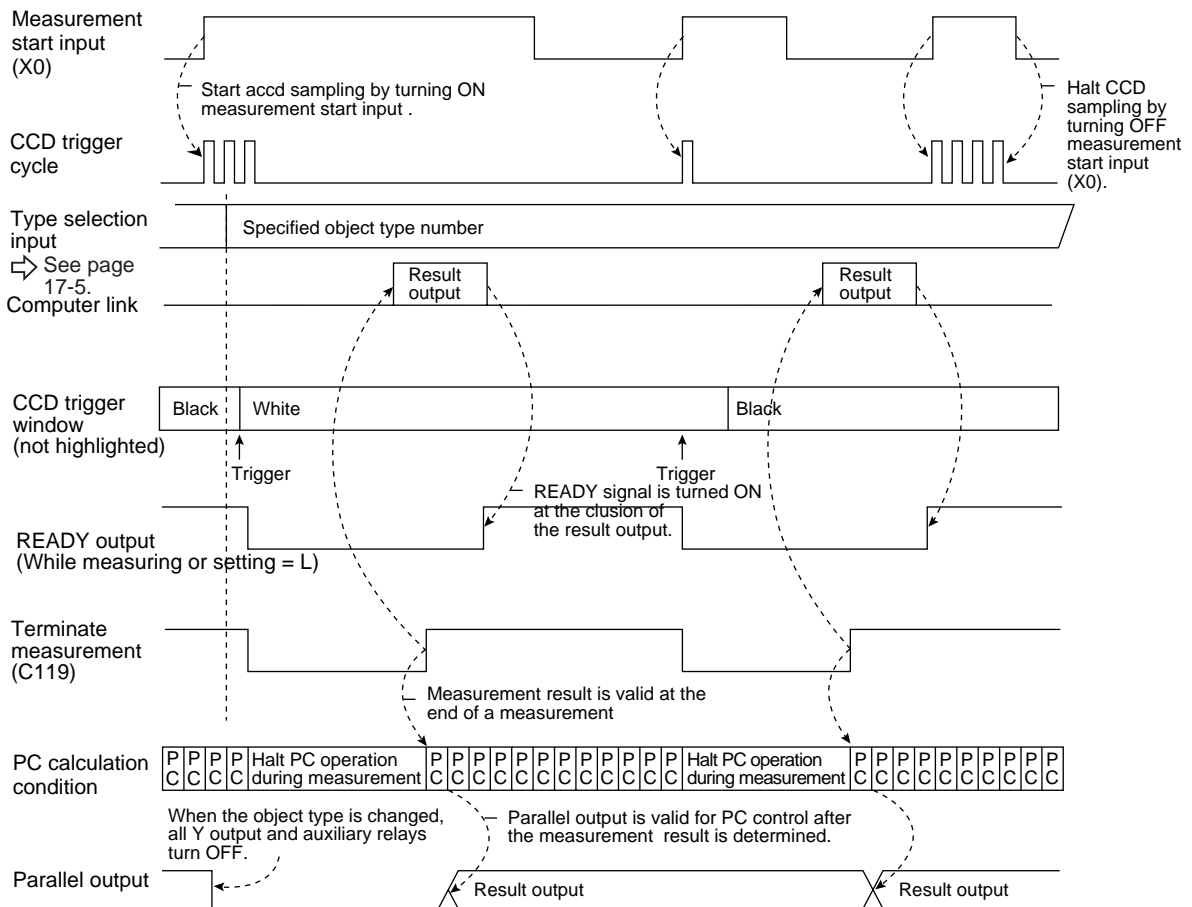

Note: Result output: The data in the block No., set in item "⑤SET SERIAL BLOCK" on the "OBJ-TYPE I/O" screen, will be transmitted to the personal computer. ⇨ See page 17-23.

(8) Measurement start input = CCD trigger, start sampling, object type change = general purpose serial, result output = general purpose serial/parallel

The CCD trigger is enabled after a measurement execution command is entered.

Setting order ① → ②

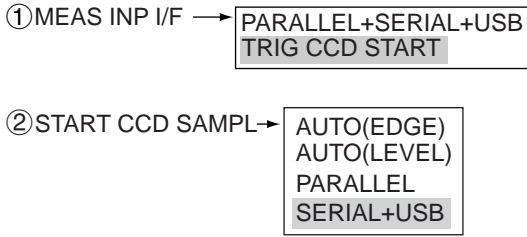

Configuration example

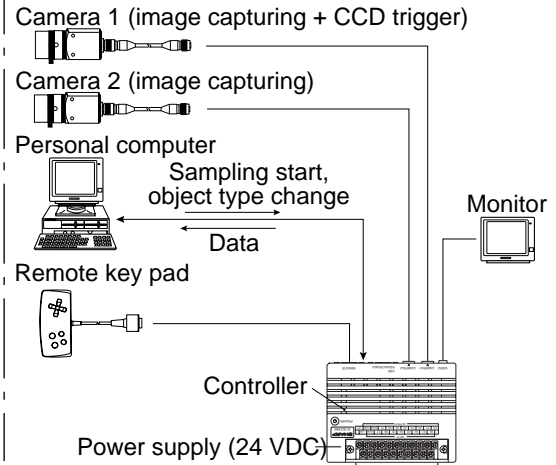

- See Chapter 18 for details about the measurement execution commands (codes 10, 11, 12 and 14_(H)).
- When one of the measurement execution commands (codes 10, 11, 12 and 14_(H)) is normally received during sampling, the sampling will stop.

Note: When the settings listed in section "17-3 CCD trigger" have not been made, a "CCD TRIG NOT SET. (error 34)" will occur.

Time chart

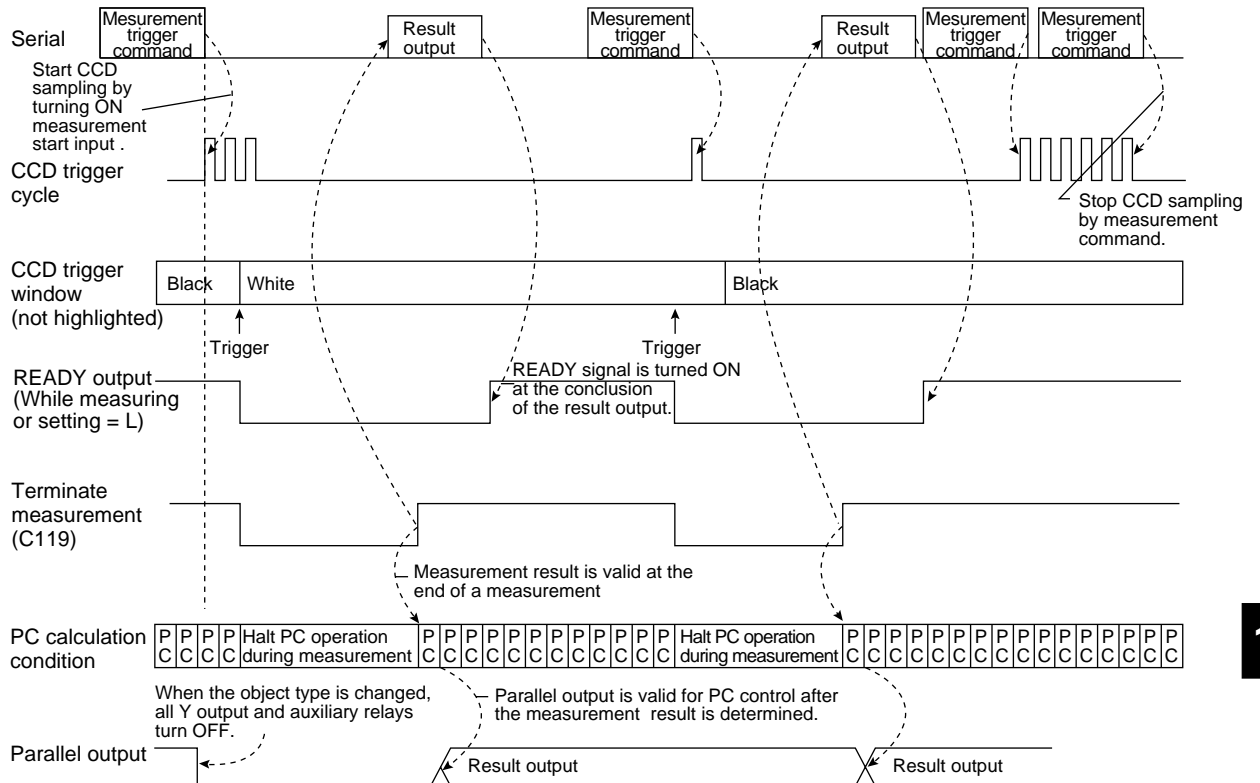

Note: Result output: The data in the block No., set in item "⑤SET SERIAL BLOCK" on the "OBJ-TYPE I/O" screen, will be transmitted to the personal computer. ⇨ See page 17-23.

(9) Measurement start input = CCD trigger, start sampling = auto, object type change, result output = parallel

Setting order ① → ② (→ ③)

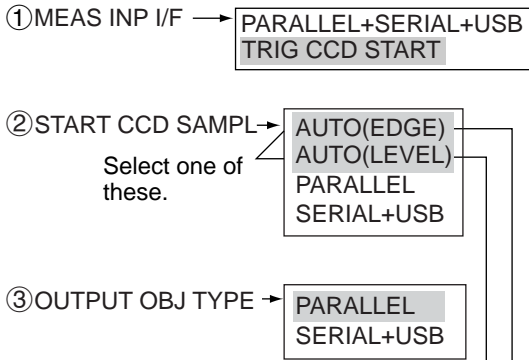

Configuration example

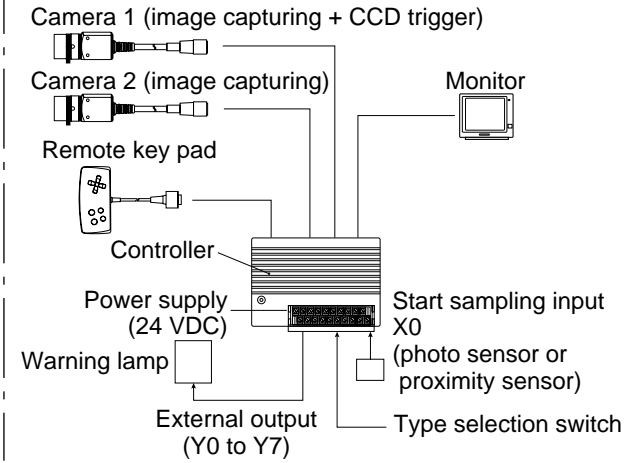

Measurement is started when the CCD trigger level is ON.
 Measurement is started when a CCD trigger signal is received.

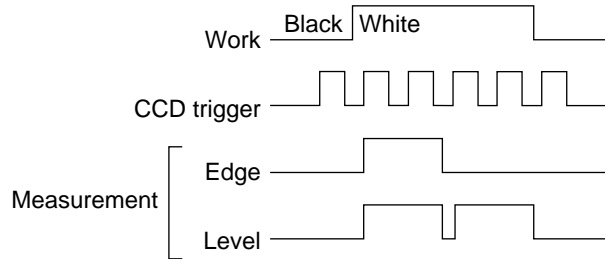

Time chart (when auto mode (edge) is selected for as the CCD sampling start)

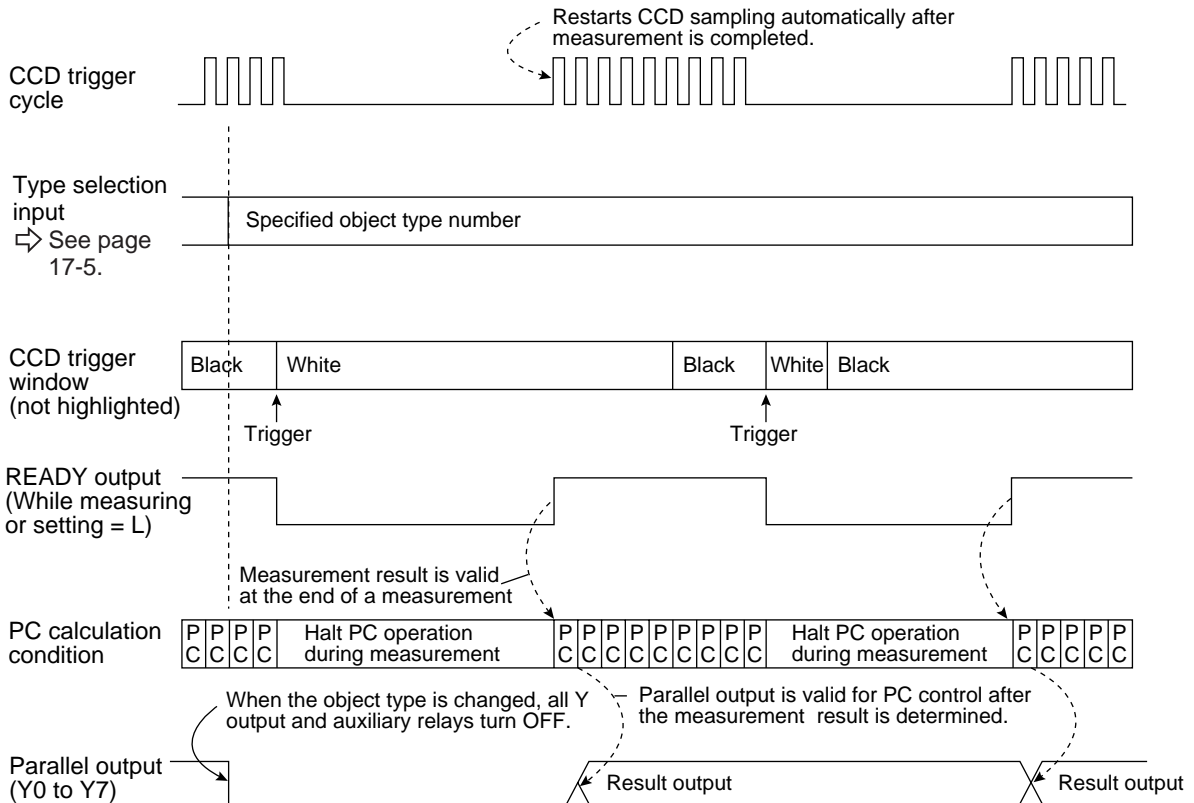

■ Time chart (when auto mode (level) is selected for as the CCD sampling start)

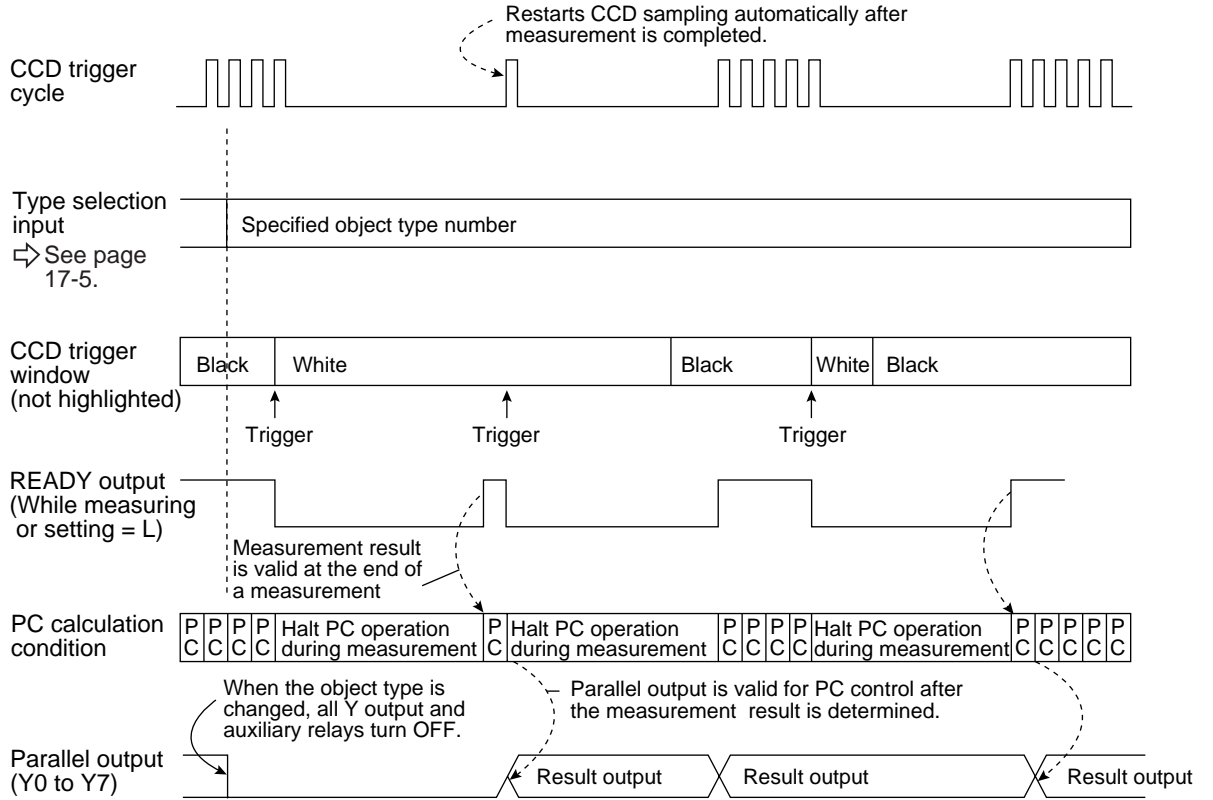

(10) Measurement start input = CCD trigger, start sampling = auto, object type change = general purpose serial, result output = general purpose serial/parallel

The general purpose serial command (code 55_(H)) is used to change the object type.

■ **Setting order** ① → ② (→ ③)

① MEAS INP I/F → PARALLEL+SERIAL+USB
TRIG CCD START

② START CCD SAMPL → AUTO(EDGE)
AUTO(LEVEL)
Select one of these.
PARALLEL
SERIAL+USB

③ OUTPUT OBJ TYPE → PARALLEL
SERIAL+USB

■ **Configuration example**

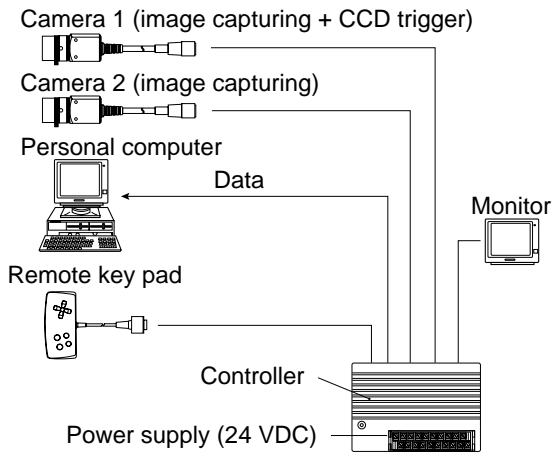

Measurement is started when the CCD trigger level is ON.
Measurement is started when a CCD trigger signal is received.

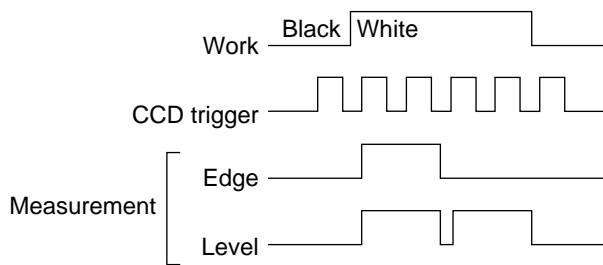

■ Time chart (when auto mode (edge) is selected for as the CCD sampling start)

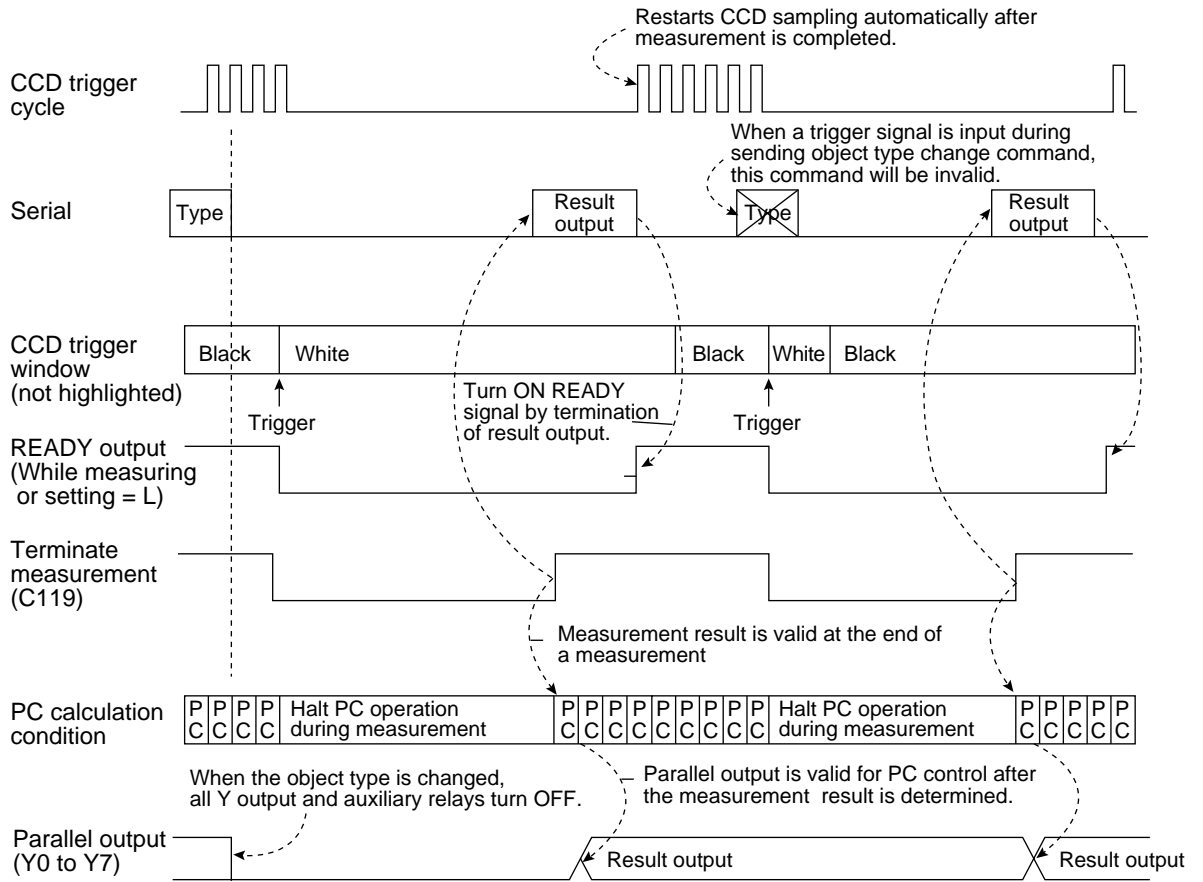

Note: Result output; The data in the block No., set in item "⑤SET SERIAL BLOCK" on the "OBJ-TYPE I/O" screen, will be transmitted to the personal computer. ⇨ See page 17-23.

■ Time chart (when auto mode (level) is selected for as the CCD sampling start)

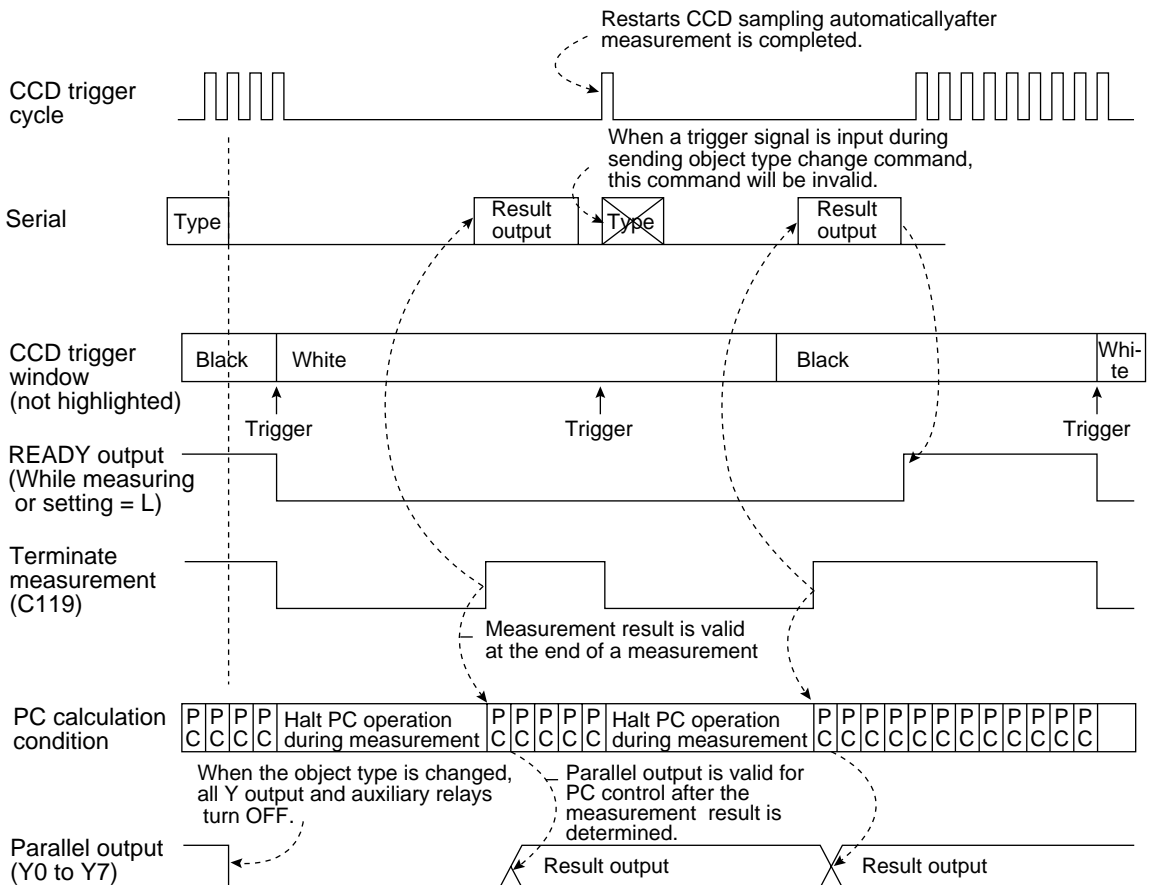

17-3 CCD trigger

[1] Outline

This function samples a specified part (trigger window) of an image captured by the CCD camera at a high rate, and starts the measurement when the sampled image changes. Therefore, moving objects can be measured without requiring an external trigger, such as a photo sensor.

To use this function, set the input/output the CCD trigger on the "I/O CONDITIONS" menu (pages 17-1 to 17-17), and set item "①TRIG CCD START" and item "②CCD TRIG COND" on the "OBJ-TYPE I/O" screen.

- There are four methods for starting the measurement when there is a change in a sampled image, i.e. a "BIN" (binary method), an "AVG-GRAYS" (average light level method), "GRAY-SRC" (gray search) and "EDGE DTECT" (edge detection).

Binary method	When a sampled binary image changes (the white area exceeds 50%), the measurement is started. - A change in a binary image means a change in a binary image from black (background) to white (workpiece) or from white (background) to black (workpiece).
Average light level method	When the average light level of a sampled image enters a specified range, the measurement is started.
Gray search	When the degree of match exceeds the specified value (threshold value), the measurement will start after the trigger event is detected. - This is useful when workpieces have complicated shading and cannot be converted to binary or use a fixed brightness range.
Edge detection	Detects edge with gray search function, and the measurement is started.

- The trigger window can be set in any position for each object type.

In the past, the position of an external sensor had to be adjusted every time the object type was changed. However, since this function eliminates the necessity of physical position adjustments, the changeover time can be reduced.

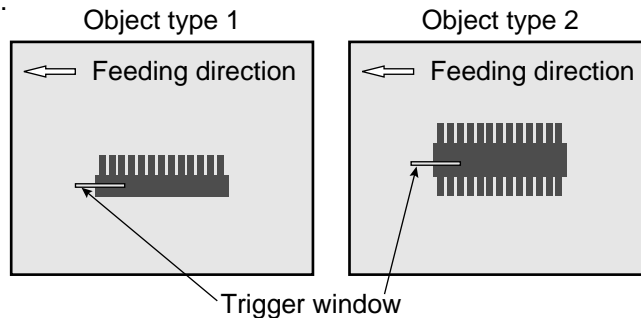

- The internal CCD trigger can be used with camera 1. (It cannot be used with camera 2.)
- An image that can be used to set the sample window conditions is obtained when the display mode is switched from the through mode to the freeze mode.

[2] Setting procedure

- **How to display the setting screen**

On the menu tree, select "TYPE00" and then "OBJ-TYPE I/O," to display the OBJ-TYPE I/O screen.

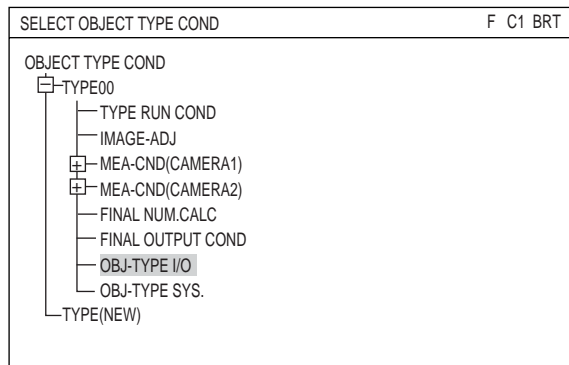

● **Setting methods**

① **TRIG CCD START**

Select a triggering method for the CCD camera used to capture images. The choices are: "BIN," "AVG-GRAYS," "GRAY-SRC," and "EDGE DTECT."

⇒ For details, see page 17-18.

Then the "②CCD TRIG COND" line will appear.

② **CCD TRIG COND**

Select the trigger conditions from the sub menu on this line.

The items in the sub menu will depend on the selection made on the "①TRIG CCD START" line.

Note: When "NO" was selected on the "①TRIG CCD START" line, the "②CCD TRIG COND" line will not appear and the following line numbers will each be one less.

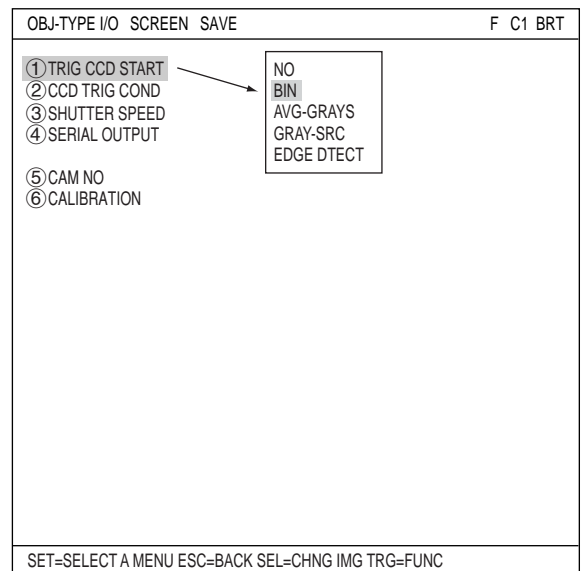

(1) **When "BIN" or "AVG-GRAYS" is selected on the "①TRIG CCD START" line**

Capture an image

Press the SEL key to move the cursor to the "F" position on the upper function menu. Then press the up or down arrow key to change the image mode from "T" to "F", to capture an image.

① **SIZE**

Specify the size of the window used for the CCD trigger.

While "①SIZE" is selected, press the SET key.

The three digits for the X-axis will be highlighted. Change the X-axis value using the up and down arrow keys.

To change value for an individual digit, press the SET key again. The cursor will move to the leftmost digit. Adjust each digit using the up/down/left/right arrow keys.

When the value is correct, press the SET key.

Now all three digits will be highlighted again.

Next, press the left or right arrow key to move the cursor to the next three digits for the Y-axis.

Adjust this value the same way you adjusted the X-axis value.

When "BIN" is selected

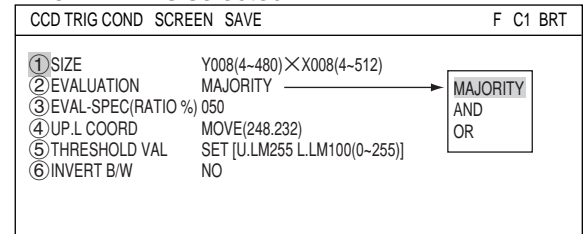

When "AVG-GRAYS" is selected

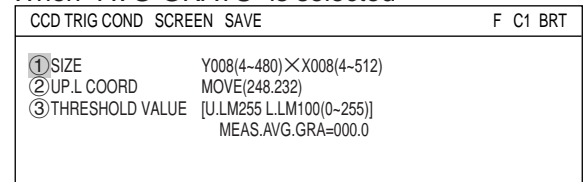

② **EVALUATION**

Select an evaluation condition, "MAJORITY", "AND," or "OR," from the popup menu.

② EVALUATION	Description
MAJORITY	Based on the number of pixels in an area, the controller will decide that the whole area is white if the specified percentage of pixels in that area is white. If the percentage of white pixels is less than this amount, the area will be treated as black. Specify the percentage (%), from 0 to 100% (in units of one percent) in the "③EVAL-SPEC (RATIO%)" item.
AND	Treat as white only when all of the pixels in an area are white.
OR	Treat as white if one or more of the pixels in an area is white.

③ **EVAL-SPEC(RATIO %)**

when "MAJORITY" is selected on the "②EVALUATION" line, enter the ratio % used to determine the color of an area.

④ **UP.L COORD**

Specify the upper left corner coordinates of the CCD trigger window. By changing these values, the position of the CCD trigger window will be moved.

⑤ THRESHOLD VAL

Specify the threshold value for binary conversion.

Select this line and press the SET key. The "THRESHOLD VAL" setting screen will appear.

⇒ For details, see pages 3-11 and 3-28.

⑥ INVERT B/W

NO	Do not reverse black and white areas.
YES	The area detected by binary conversion will be displayed as white.

THRESHOLD VAL	AUTO-REG	RESET	F C1 BRT
① CRD-Y	050	(0~255)	
② EDGE.W	2	(1~8)	
③ FLAT.W	04	(1~16)	

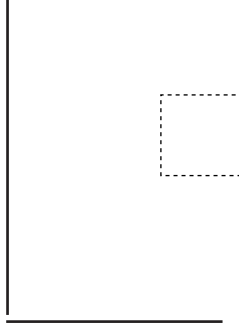

SET=CHNG ESC=BACK SEL=CHNG IMG TRG=FUNC

(2) When "GRAY-SRC" is selected on the "① TRIG CCD START" line.

- ① REF-IMG AREA
- ② SEARCH AREA
- ③ DETECT CRD
- ④ CONTR. PIXEL

⇒ For details, see pages 5-5 to 5-7.

⑤ MATCH LEVEL

Specify the range for the degree of match. While "⑤ MATCH LEVEL" is selected, press the SET key. The five digits for the lower limit will be highlighted. Change the number using the up and down arrow keys.

To change the value of individual digits, press the SET key again. The cursor will move to the leftmost digit. Adjust the value of each digit using the up/down/left/right arrow keys.

When the value is correct, press the SET key. All five digits will be highlighted again.

Then, press the left or right arrow key to move the cursor to the next five digits, which are the upper limit. Adjust this number the same way.

CCD TRIG COND	SCREEN	SAVE	F C1 BRT
① REF-IMG AREA	SET	(224.208)~(287.271)	
② SEARCH AREA	SET	(216.200)~(295.279)	
③ DIRECT CRD	CENTER	(255.239)	
④ CONTR.PIXEL	3		
⑤ MATCH LEVEL	+07000~+10000		

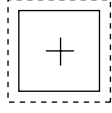

SEL=WINDOW SET ESC=BACK SEL=CHNG IMG TRG=FUNC

(3) When "EDGE DTECT" is selected on the "① TRIG CCD START" line.

- ① SEARCH AREA
- ② DTECT MODE
- ③ SEARCH DIRECT
- ④ THRESHOLD VAL

⇒ For details, see pages 12-7 to 12-9.

CCD TRIG COND	SCREEN	SAVE	F C1 BRT
① SEARCH AREA	SET	(224.208)~(287.271)	
② DTECT MODE	CHNG POINT		
③ SEARCH DIRECT	HORIZ	(→)	
④ THRESHOLD VAL	SET	(D:050 E:2 F:04)	



SEL=WINDOW SET ESC=BACK SEL=CHNG IMG TRG=FUNC

17-4 Setting for serial communications

When "PARALLEL+SERIAL+USB" (general purpose serial) has been specified in item "①MEAS INP I/F" on the "I/O CONDITIONS" menu (page 17-1), and when "SERIAL" or "PC-LINK" has been specified in item "②OUT I/F (PARAL.)" the serial communication conditions must be set on the "COMM.SET" screen.

- Set the items to match the communication conditions of the other device.

Select "MAIN COND" -> "SYS-CND" -> "COMM.SET," in that order.

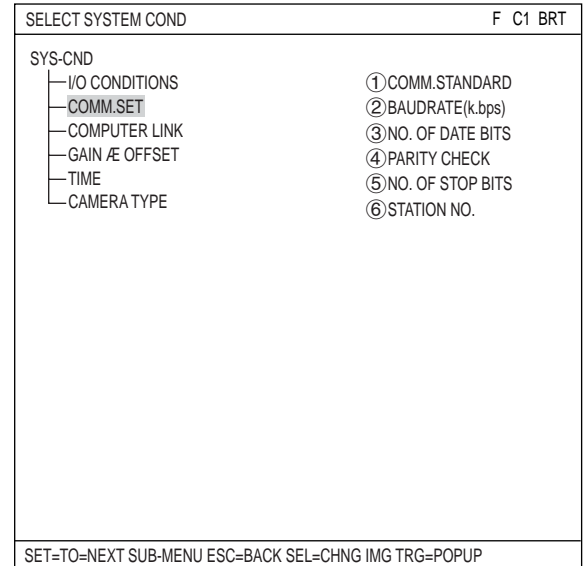

- How to set the communication settings

Adjust each item to match the equipment used to communicate.

① COMM. STANDARD

Select "RS232C," "RS422:4LINE," or "RS422:2LINE."

② BAUDRATE (kbps)

Set the communication speed: 2.4Kbps, 4.8Kbps, 9.6Kbps, 19.2Kbps, 38.4Kbps, 57.6Kbps, or 115.2Kbps.

③ NO.OF DATA BITS

Select either 7-bit or 8-bit.

④ PARITY CHECK

Select "EVEN," "ODD," or "NO."

⑤ NO.OF STOP BITS

Set it to 1-bit or 2-bits.

⑥ STATION NO.

Select the station number for communication using the up and down arrow keys.

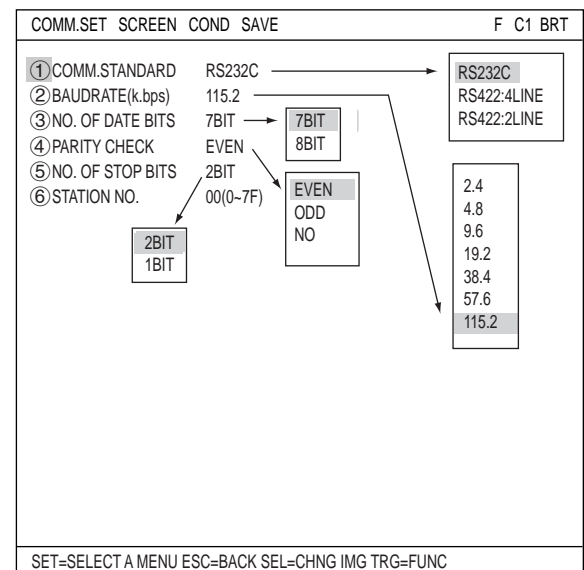

17-5 Computer link

When "PC-LINK" has been specified in item "②OUT I/F (PARAL.)" on the "I/O CONDITIONS" screen (page 17-1), the computer link conditions must be set on the "COMPUTER LINK" screen.

How to display the computer link setting screen

How to display the computer link setting screen

Select "MAIN COND" -> "SYS-CND" ->

"COMPUTER LINK," in that order.

The COMPUTER LINK screen will appear.

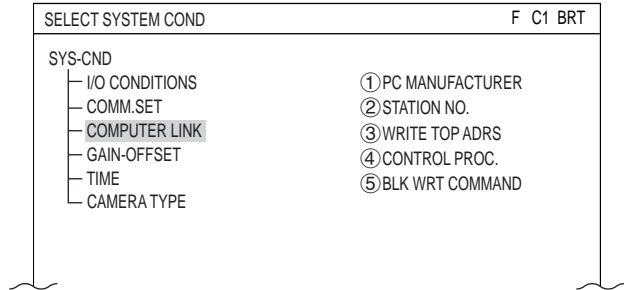

How to set up a computer link

- ① PC MANUFACTURER, ② STATION NO., ③ WRITE TOP ADRS

The details for "①PC MANUFACTURER," "②STATION NO.," and "③WRITE TOP ADRS" are as follows.

Item	Setting range
Station No.	- Sharp: 00 to 37 ⁽⁸⁾ * - Mitsubishi: 00 to 31 - OMRON: 00 to 31 - Yokogawa: 01 to 32
Write address (max. 512 bytes)	- Sharp: 09000 to 99776 - Mitsubishi: D0000 to D9999 - OMRON: DM0000 to DM9999 - Yokogawa: D00001 to D16384

* In this book, octal notation is indicated by adding⁽⁸⁾

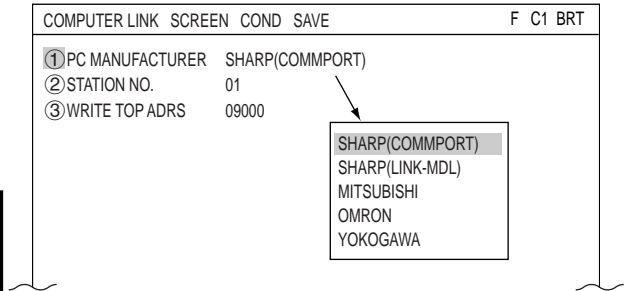

- ④ CONTROL PROC., ⑤ BLK WRT COMMAND

When "MITSUBISHI" is selected on the "①PC MANUFACTURER" line, specify "④CONTROL PROC." and "⑤BLK WRT COMMAND."

Menu	Setting details
④ CONTROL PROC.	FORM 1: No line terminator FORM 4: With line terminators · "CR" + "LF"
⑤ BLK WRT COMMAND	WW: Data writing address range · D0000 to D1023 QW: Data writing address range · D000000 to D008191

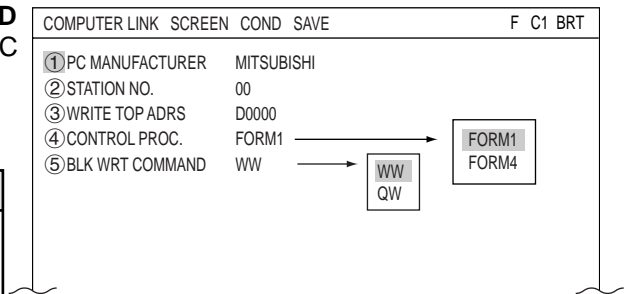

See "Chapter 19: Computer Link" for applicable models made by these manufacturers.

Note 1: Use an even address as the write start address.

Note 2: When 512 bytes are used for a write register on a Sharp model, select a write start address from the following addresses.

09000, 19000, 29000, 39000, 49000, 59000, 69000, 79000, 89000, 99000

17-6 Output block assignment (Computer link output and general purpose serial output)

When measurement is controlled by a computer link or a communication interface (general purpose serial IF: * 1), in addition to other block 0, blocks can be specified whose measurement data will be output from the IV-S30 to a programmable controller or a personal computer.

* 1 In the case of a communication interface (general purpose serial IF), output blocks can be specified only when the measurement is started by a CCD trigger or a parallel IF signal and the results are set by a general purpose serial IF signal. - See page 18-3.

Specify the settings above on the "OBJ-TYPE I/O" screen ⇨ See the next page.

[1] Data in specified blocks

(1) In the case of a computer link

Data in the specified blocks will be output after the data (block 0) from measurement numbers 0 to 4 is output by the write register of the PC. (See page 19-3.)

■ Write register map

	Sharp	Mitsubishi	OMRON	Description		
Result top write address (* 2)	09000	D0000	L	DM0000	L	Termination code
	09001		H		H	Appended information
	⋮	⋮	⋮	⋮	⋮	
	⋮	⋮	⋮	⋮	⋮	
	⋮	⋮	L	⋮	L	Output data from measurement No. 3 (block 0)
	⋮	⋮	H	⋮	H	
	⋮	⋮	⋮	⋮	⋮	
	⋮	⋮	⋮	⋮	⋮	
Result top write address + 512 bytes (* 3)	⋮	⋮	L	⋮	L	Data in a specified block
	⋮	⋮	H	⋮	H	
	⋮	⋮	⋮	⋮	⋮	
	⋮	⋮	⋮	⋮	⋮	

* 2 Set the result top write address in item "③WRITE TOP ADRS" on the "COMPUTER LINK" screen. ⇨ See the preceding page.

* 3 The top address to which the data in the specified blocks will be written is obtained by adding 512 bytes to the result top write address.

- Setting examples for various manufacturers

	Sharp		Mitsubishi	OMRON
Result top write address	09000	09300	D0000	DM0000
Top address of data in specified blocks	19000	19300	D0256	DM0256

(2) When the measurement is started by a CCD trigger or a parallel I/F signal and the results are output by a general purpose serial I/F signal

When the IV-S30 responds, data in a specified block is output after the output data (block 0) from the measurement No. 0 to 4, in response to the measurement run command 2 (processing code 11_(H)).

Response

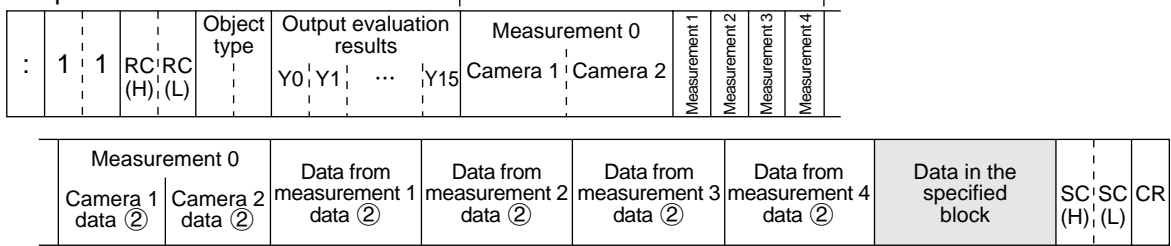

See page 18-7 for details about ① and ②.

Note: The response returned by the measurement run command 2 (processing code 11_(H)) will not contain the specified block.

[2] Setting (operating) procedure

Setting (operating) procedure

1. Select "MAIN COND" -> "OBJECT TYPE COND" -> "TYPE00" -> "OBJ-TYPE I/O" in that order.

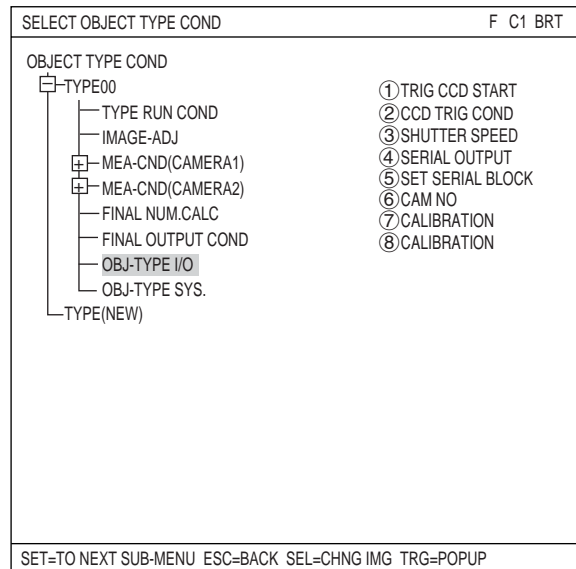

2. The "OBJ-TYPE I/O" screen will appear. Move the cursor to "③ SERIAL OUTPUT" and press the SET key. A popup menu will appear. Select "BLOCK-ASSIGN" and press the SET key.

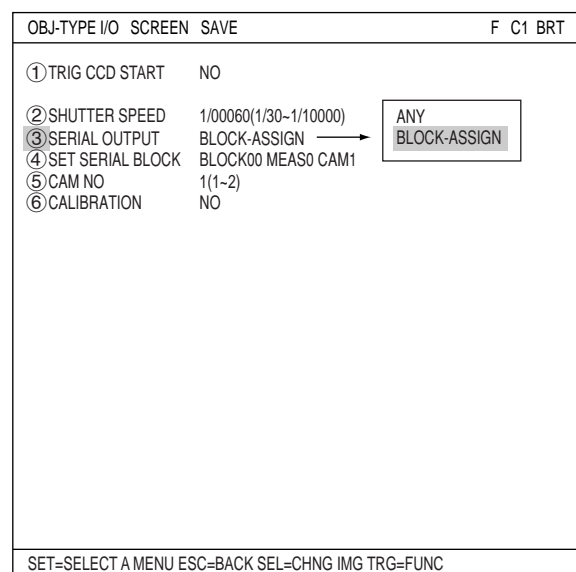

3. The "④SET SERIAL BLOCK" line will appear. Select this line and press the SET key. Enter the block No., measurement No. and camera No. of the measurement data to be output, using the left, right, up and down keys.
 - Specify a block number to be returned in addition to block 0 (00). If block 00 is specified, data from block 00 will not be returned a second time. After the settings are complete, press the SET key.

OBJ-TYPE I/O	SCREEN SAVE	F C1 BRT
① TRIG CCD START	NO	
② SHUTTER SPEED	1/00060(1/30~1/10000)	
③ SERIAL OUTPUT	BLOCK-ASSIGN	
④ SET SERIAL BLOCK	BLOCK00 MEAS0 CAM1	
⑤ CAM NO	1(1-2)	
⑥ CALIBRATION	NO	

SET=SELECT A MENU ESC=BACK SEL=CHNG IMG TRG=FUNC

17-7 Setting the data output

When you communicate with the IV-S30 using a computer link or a serial communication interface (general purpose serial IF) in the following conditions, perform steps (1) and (2) below to enable serial output.

- Computer link: When outputting any data ⇨ Pages 19-3 and 19-4.
- Communication interface (general purpose serial IF): When executing a measurement run command 4 (processing code 14_(H)) - Pages 18-8 and 18-10.

[1] Select "ANY" for the serial output

Select "ANY" in the "④ SERIAL OUTPUT" item on the "OBJECT TYPE I/O" menu.

■ Setting (operating) procedure

1. Select "MAIN COND" -> "OBJECT TYPE COND" -> "TYPE00" -> "OBJ-TYPE I/O" in that order.

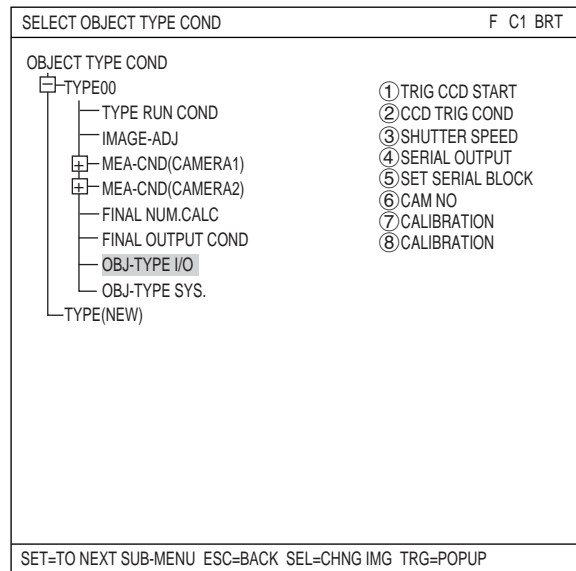

2. The "OBJ-TYPE I/O" screen will appear. Move the cursor to "③ SERIAL OUTPUT" and press the SET key. A popup menu will appear. Select "ANY" and press the SET key.

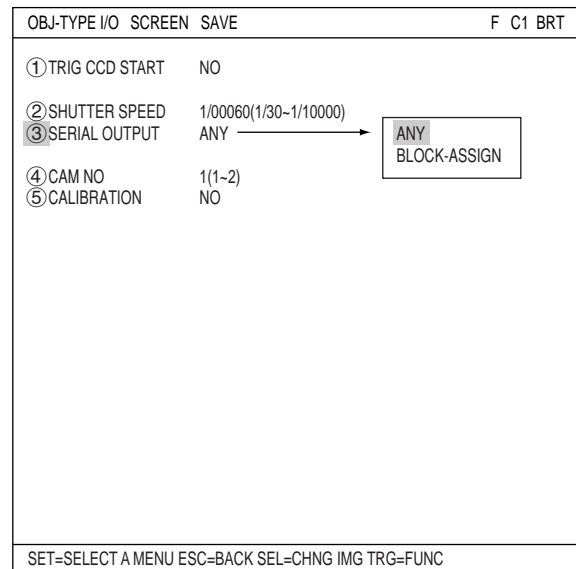

[2] Select "YES" or "NO" for output data

Select "YES" or "NO" on the following menu screens that are displayed as "locked" screens to output serial data. See the next page for instructions about how to lock the screen. On any condition setting screen, press the TRG/BRT key and the cursor will move to the upper function menu. Select "SCREEN" and press the SET key. A popup menu will appear. Select "SERIAL OUTPUT" and press the SET key.

- The "EVALUATION COND" screen for individual measurement program

EVALUAT COND SCREEN SAVE		F C1 BRT
	[SERIAL OUTPUT]	
① X COORD(MDL0)	NO	<input type="checkbox"/> NO <input type="checkbox"/> YES
② Y COORD(MDL0)	NO	
③ x DEVIATE(MDL0)	NO	
④ y DEVIATE(MDL0)	NO	
⑤ MATCH LVL(MDL0)	NO	
⑥ ANGULAR DEVIATE	NO	
⑦ X COORD(MDL1)	NO	
⑧ Y COORD(MDL1)	NO	
⑨ x DEVIATE(MDL1)	NO	
⑩ y DEVIATE(MDL1)	NO	
⑪ MATCH LVL(MDL1)	NO	
SEL=VALUE INPUT ESC=BACK SEL=CHNG IMG TRG=FUNC		

(When measuring positional deviation)

- The "NUMERIC CALC" or "FINAL NUM. CALC" screen for individual measurement program

NUMERIC CALC SCRREN SAVE		F C1 BRT
	[SERIAL OUTPUT]	
① OUTPUT	NO	

(When the numerical calculation condition menu is displayed)

- The "DIST&AGL COND" screen

DIST&AGL COND SCREEN SAVE		F C1 BRT
	[SERIAL OUTPUT]	
① DISTANCE EVALUATION	NO	

- When the serial output setting is "NO," no data (block 0) will be output (the space will be filled by the next item).

(To measure an object's "distance" on the distance and angle condition menu)

17-8 Calibrating the IV-S30

The IV-S30 calibration can be adjusted, e.g. "1 pixel = 1 mm", and the data can be displayed as actual dimensions.

● How to display the CALIBRATION setting screen

- 1) Select "MAIN COND" and then "OBJECT TYPE COND."

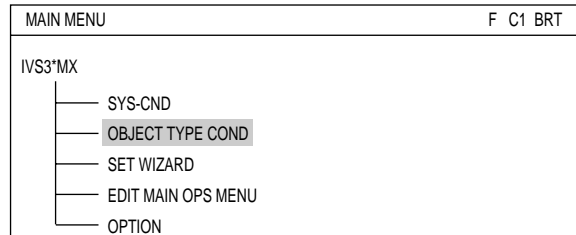

- 2) On the "OBJECT TYPE COND" screen, move the cursor to any "TYPExx" that you want to calibrate, and press the SET key.

- 3) Move the cursor to the "OBJ-TYPE I/O" line and press the SET key.

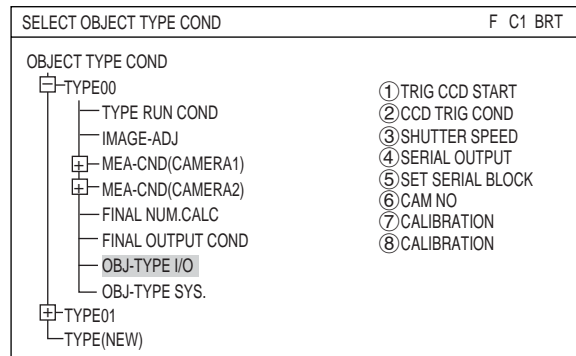

- 4) On the "OBJ-TYPE I/O" setting screen, move the cursor to the "⑦ CALIBRATION" line and press the SET key twice, to bring up the sub-menu.

Note: Depending on settings for the "① TRIG CCD START" and "④ SERIAL OUTPUT" items, the number of the "CALIBRATION" line will vary between ⑥ and ⑧.

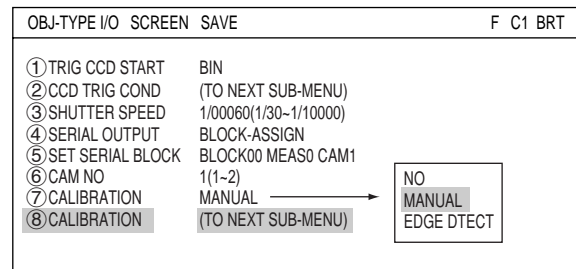

- 5) Set the calibration details on the "CALIBRATION" setting screen.
Put a ruler in the camera's field of view .

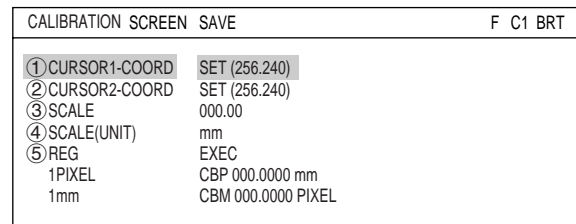

● When "MANUAL" is selected on the "CALIBRATION" line

1. Move the cursor to "① CURSOR1-COORD" and press the SET key.

2. While the cursor is on the "①CROSS CURSOR" line on the CROSS CURSOR screen, press the SET key. Move the crosshair cursor to the tick marks on the ruler using the up/down/left/right arrow keys and set coordinate 1.

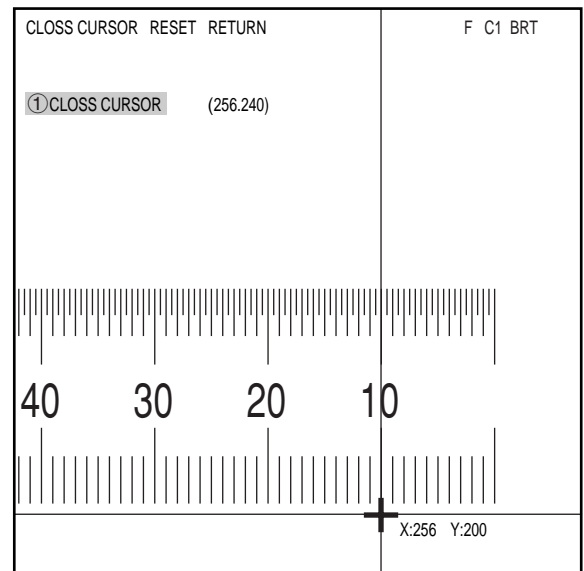

3. Then move the cursor on the CROSS CURSOR screen to the "②CUSOR2-COORD" line and set coordinate 2 using the same procedure.

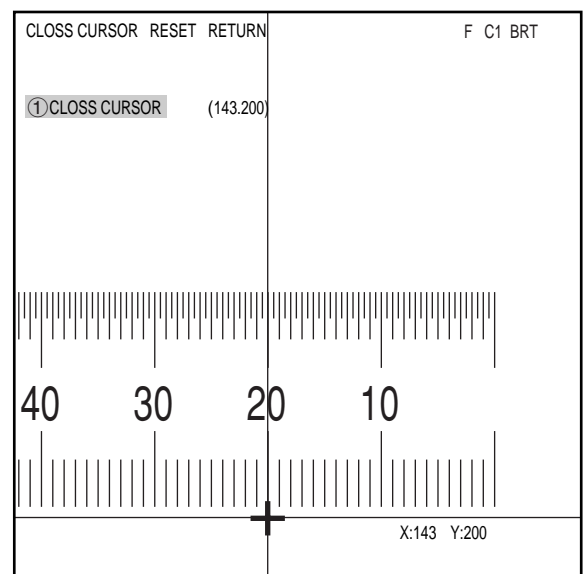

4. Select the "③SCALE" line and enter the actual value of the distance between coordinates 1 and 2. In this example, the distance is 10 mm. Therefore, enter "10."
5. Select the "④SCALE(UNIT)" line and select the unit of distance between coordinates 1 and 2. In this example, select "mm."
6. Select the "⑤REG" (register) line and while the cursor is on "EXEC" (execute) press the SET key again. The controller will be calibrated to read "1 pixel = 1 mm."

● Setting the register conditions for edge detection

① SEARCH AREA

Select "①SEARCH AREA (MDL0)" and press the SET key to go to the setting screen.

② DTECT MODE

Select an image processing method for the edges.

③ SEARCH DIR

Specify a search direction.
⇒ For details, see page 3-15.

④ THRESHOLD

Specify a threshold value for binary conversion.
⇒ For details, see page 3-15.

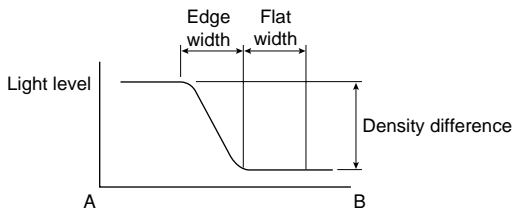

Automatic setting

Select "AUTO-REG" from the upper function menu on the THRESHOLD setting screen. The controller will set the optimum value automatically.

⑤ REF COORD (reference coordinates)

You can change the reference coordinates to any desired position.

⑪ SCALE

Enter the actual value of the distance between coordinates 1 and 2. In this example, the distance is 10 mm. Therefore, enter "10."

⑫ SCALE (UNIT)

Select unit of distance between coordinates 1 and 2. In this example, select "mm."

⑬ REG (register)

While the cursor is on "EXEC" (execute) press the SET key again. The controller will be calibrated to treat 1 pixel = 1 mm.

REG COND	SCREEN COND	SAVE DATAL	F C1 BRT
① SEARCH AREA(MDL0)	SET(224,208)~(287,271)		
② DTECT MODE(MDL0)	CHNG POINT		CHNG POINT
③ SEARCH DIR(MDL0)	HORIZ(→)		DRK→BRT
④ THRESHOLD(MDL0)	SET(D:050 E:2 F:04)		BRT→DRK
⑤ REF COORD(MDL0)	SET KEY(256,240)		CENT(BRT)
			CENT(DRK)
⑥ SEARCH AREA(MDL1)	SET(224,208)~(287,271)		
⑦ DTECT MODE(MDL1)	CHNG POINT		
⑧ SEARCH DIR(MDL1)	HORIZ(→)		HORIZ(→)
⑨ THRESHOLD(MDL1)	SET(D:050 E:2 F:04)		HORIZ(←)
⑩ REF COORD(MDL1)	SET KEY(256,240)		VERT(↓)
			VERT(↑)
⑪ SCALE	000.00		
⑫ SCALE(UNIT)	mm		
⑬ REG	EXEC		
1PIXEL	CBP 000.0000 mm		
1mm	CBM 000.0000 PIXEL		
SET=WINDOW SET ESC=BACK SEL=CHNG IMG TRG=POPUP			

6) Using the CBP value that was set in the calibration function, you can execute numeric calculations.

1. Press the ESC key twice to show the menu tree. Select the "NUM-CALC" line for the same object type and measurement number, and press the SET key.

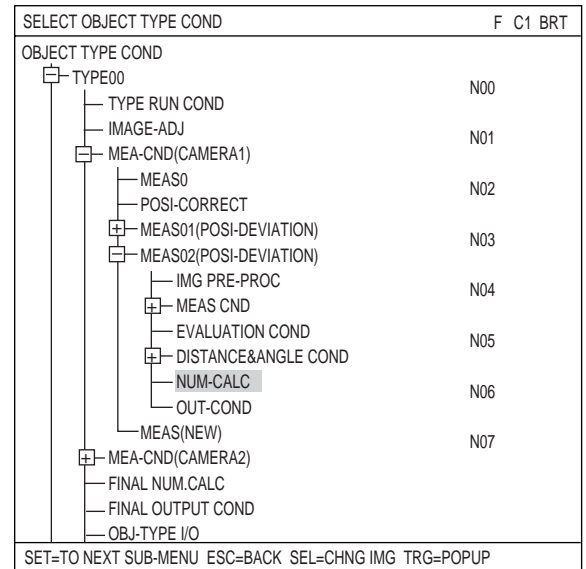

2. Relay numbers N00 to N07 are displayed on the first screen. To display relay numbers N08 to N15, press the SET key while the cursor is on the "CHG-CALC" item.

NUMERIC CALC SCREEN COND SAVE F C1 BRT

[N08-N15]

CHG-CALC

① RUN A TEST (SET KEY)

	TYPE	FORMULA
N00		
N01		
N12		
N03		
N04		
N05		
N06		
N07		

SET=EXEC ESC=BACK SEL=CHNG IMG TRG=FUNC

3. On the "NUMERIC CALC" screen, use the up and down arrow keys to move the cursor to a cell in the "TYPE" column on the desired relay number line. Press the SET key. A popup menu will appear and you can select the calculation result you want to output. In this example, select "DEV -x" (deviation on the X-axis)

NUMERIC CALC SCREEN COND SAVE F C1 BRT

[N00-N07]

CHG-CALC

① RUN A TEST (SET KEY)

	TYPE	FORMULA
N00		
N01		
N12		
N03		
N04		
N05		
N06		
N07		

CRD-X

CRD-Y

DEV-x

DEV-y

MATCH M

ANGL-B

NUM-CAL [NC]

CNST [C]

NO

SET=SELECT TYPE ESC=BACK SEL=CHNG IMG TRG=FUNC

Setting the Input/Output Conditions

4. Next, move the cursor to the "FORMULA" column and press the SET key. Another popup menu will appear allowing you to select the type of formula you want to use for calculations. In this case, select "CBP."

NUMERIC CALC		SCREEN	COND	SAVE	F	C1	BRT
【N00-N07】							
CHG-CALC							
① RUN A TEST (SET KEY)							
	TYPE	FORMULA					
N00			OBJECT TYPE				
N01			CALC RESULT				
N12			CNST				
N03			SUM				
N04			AVG				
N05			CBP				
N06			CBM				
N07			DEL				
SET=SELECT TYPE ESC=BACK SEL=CHNG IMG TRG=FUNC							

5. After completing these settings, deviation on X-axis will be output as a CBP value (in unit of mm).

Chapter 18: Communication (General Purpose Serial Interface)

The IV-S30 can communicate with a personal computer that transmits commands and receives responses to measurement execution commands.

18-1 List of processing functions

The following functions can be used for communication between the IV-S30 and a personal computer (using the general-purpose serial interface).

Category	Processing description	Code	Functions
Executing measurement	Measurement execution function 1	10	- Executes all measurement programs for a specified object type. (You can make measurements by specifying a camera.) - Outputs the ladder results (Y0 to 15).
	Measurement execution function 2	11	- Executes all measurement programs for a specified object type. (You can make measurements by specifying a camera.) - Outputs the ladder results (Y0 to 15) and the measurement data in block 0 for each measurement program.
	Measurement execution function 3	12	- Executes all measurement programs for a specified object type. (You can make measurements by specifying a camera.) - Outputs the ladder results (Y0 to 15) and the measurement result from a specified block for a specified measurement number.
	Measurement execution function 4	14	- Executes all measurement programs for a specified object type. (You can make measurements by specifying a camera.) - Outputs any numerical data selected by the IV-S30.
Reading result	Measurement data reading 1	20	Reads the result of the last measurement - Outputs the ladder results (Y0 to 15).
	Measurement data reading 2	21	Reads the result of the last measurement - Outputs the ladder results (Y0 to 15) and the measurement data in block 0 for each measurement program.
	Measurement data reading 3	22	Reads the result of the last measurement - Outputs the ladder results (Y0 to 15) and the measurement result from a specified block for a specified measurement number.
	Measurement data reading 4	24	- Reads the results of the last measurement from a specified measurement code. - Outputs any numerical data selected by the IV-S30.
	Illumination reading	28	- Reads the amount of illumination measured by the lighting monitor function, and the evaluation result.
	Corrected light level reading	29	- Reads the corrected light level measured by the lighting monitor function, evaluation result and preset reference density.

Shown below is the relationship of each selection when code 10 to 14 are specified is shown below. The conditions below are what is shown when the "PARALLEL+SERIAL+USB" is selected on the "①MEAS INP I/F" on the "I/O CONDITIONS" selection screen.

Measurement start	Output selection	Serial output	Object type change
General purpose serial port	---	Command codes 10 to 12	Command codes 10 to 12
Parallel port	None	---	Parallel
	Computer link	SHARP/MITSUBISHI/OMRON/YOKOGAWA	Parallel
	General-purpose serial + USB	Response output from command codes 11	Parallel

Communication (General Purpose Serial Interface)

The conditions below are what is shown when the "TRIG CCD START" is selected on the "①MEAS INP I/F" on the "I/O CONDITIONS" selection screen.

Measurement start	Output selection	Serial output	Object type change
Auto	Parallel port	---	Parallel
	General purpose serial port + USB	Response output from command codes 11	Command codes 55
Parallel port	None	---	Parallel
	Computer link	SHARP/MITSUBISHI/OMRON/YOKOGAWA	Parallel
	General-purpose serial port	Response output from command codes 11	Parallel
General-purpose serial port + USB	---	Command codes 10 to 12	Command codes 10 to 12

Category	Processing function	Code	Function
Individual conditions	Operation lock status	Read	50 - Read lock/unlock condition of the operation screen.
		Set	51 - Set lock/unlock for the operation screen.
	English or Japanese display	Read	52 - Read the status from the English or Japanese display.
		Set	53 - Enter a change on the English or Japanese display.
	Object type number	Read	54 - Read an object type number to measure when the measurement start input is turned ON.
		Set	55 - Assign an object type number to be executed when the measurement start input is turned ON.
	Image status	Read	56 - Read the image status being monitored (Output: Through/freeze, Brightness: Full/half).
		Set	57 - Change the status of the image being monitored (Output: Through/freeze, Brightness: Full/half).
	Output image camera	Read	58 - Read the status of the camera outputting an image for the specified object type.
		Set	59 - Set the status of the camera that is outputting an image for the specified object type.
	Shutter speed	Read	5A - Read the shutter speed setting for the specified object type.
		Set	5B - Set shutter speed for the specified object type.
	Time	Read	5C - Read the IV-S32MX/S33MX's system time.
		Set	5D - Adjust the IV-S32MX/S33MX's system time to the time set by the host device.
	Register a reference image	Assign	5E - Measurement program: Registers reference images for the specified object type and measurement number (register No. 0 only). - Image calculation: Registers reference images used for image calculations of the specified object type.
Initialize all		60 - Set all settable conditions to their initial values (global conditions, all object type conditions, and reference images).	
Self-diagnostic		68 - Check the controller for a hardware error. Items to check: VRAM (read after write), SDRAM (read afterwrite), etc.	
Reset		69 - Reset the controller (the same as a power reset operation).	
Manual measurement coordinates	Read	70 - Read the coordinates detected by manual measurement.	
	Set	71 - Set the coordinates for manual measurement.	

18-2 Data flow

The data flow between the IV-S30 and a personal computer is shown below.

[1] Measurement execution 1: Command codes 10, 11, or 12

- Select the measurement start input source = general purpose serial and parallel port

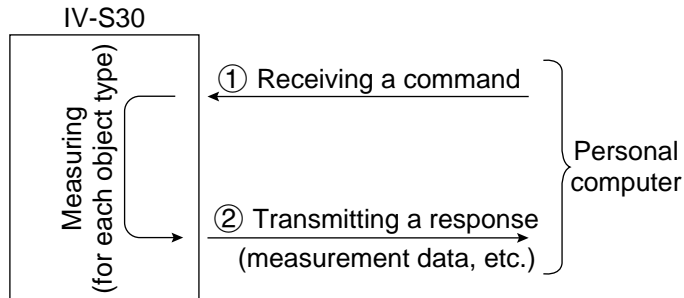

[2] Measurement execution 2: Response processing for command 11

- Select the measurement start method = CCD trigger, parallel or serial output = general purpose serial

Note: When a CCD trigger is chosen as the measurement start input, the sample start must be set to parallel or auto.

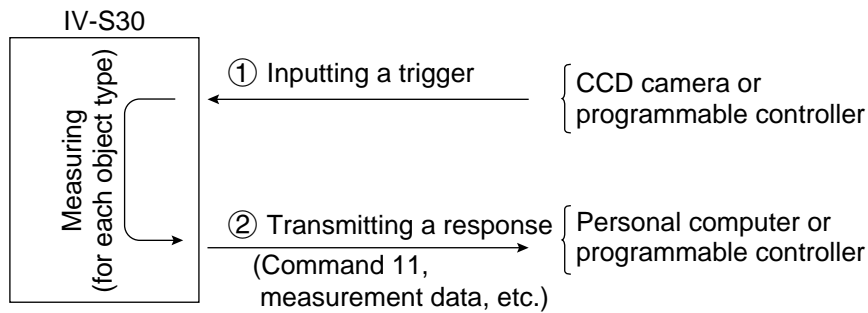

- You can specify the response block on the "OBJECT TYPE I/O" screen ⇨ see page 17-23.

- Select the measurement start method = CCD trigger, start sampling & output results = general purpose serial

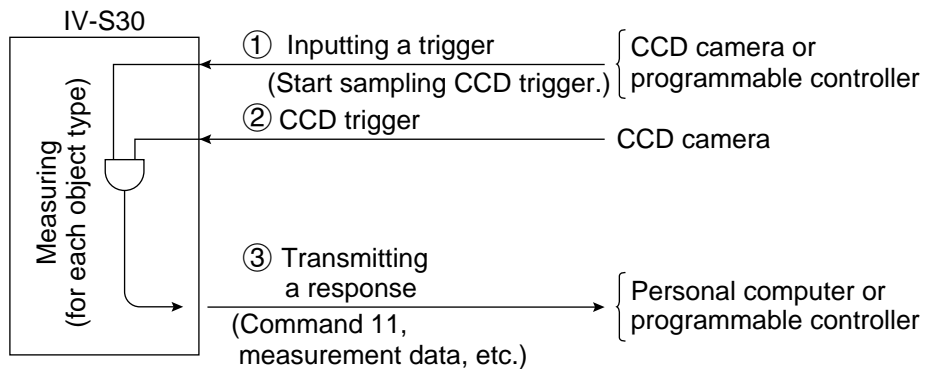

[3] Measurement execution 3: Command 14

- Select measurement start input source = general purpose serial and parallel port

- [Procedure] (1) Send packet number 0 → After measuring, send back the measurement code for the first register and any specified data.
 (2) Send the other packets, starting from number 1→
 - Send back the measurement code for the next register and any specified data.
 - When there are no more measurement registers, send back the end code "F."

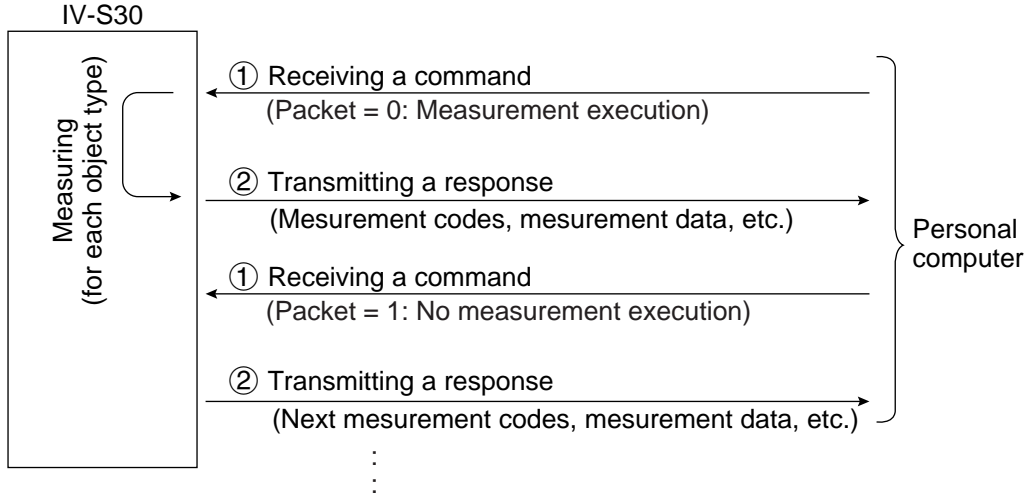

[(Response) measurement code]

Measurement code	Setting	Measurement code	Setting
0	MEASURE 0 CAMERA 1	5	MEASUREMENT 4
1	MEASURE 0 CAMERA 2	6	Distance and angle measurement
2	MEASUREMENT 1	7	Numerical calculation
3	MEASUREMENT 2	F	Quit
4	MEASUREMENT 3		

[4] Processing other than measurement execution processing

- Operaton screen: Any command can be processed, regardless of the measurement I/O settings (measurement start, result output).
- Setting screens: Reading/writing a display image (commands 30, 31) and reading a binary image (command 34) are available.

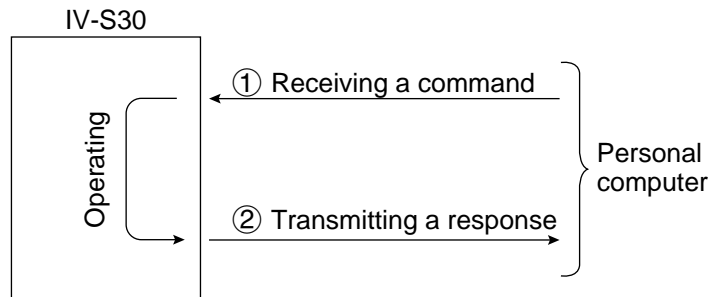

18-3 Communication format

The communication formats of the commands and responses between the IV-S30 and a personal computer are outlined below.

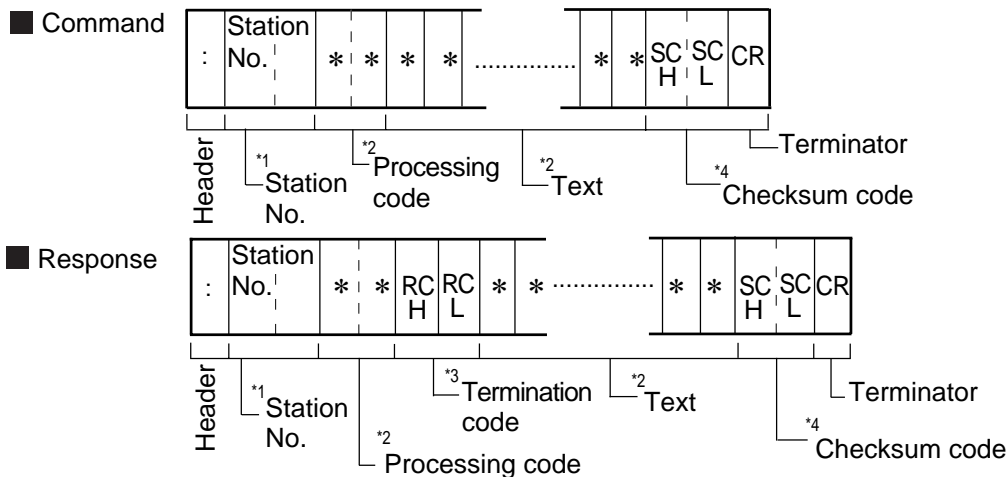

*1 Station No.: 00 to 7F_(H)

*2 Processing code and text

- They depend on the contents of communication. ⇨ See pages 18-1 and 18-7 and after.
- On abnormal termination, no text is provided.

*3 Termination code_(H)

The termination code is a 2-digit hexadecimal number.

- When an output is sent through the general purpose serial I/F, 00_(H) is sent on normal termination.
- On abnormal termination, a code other than 00_(H) is sent. ⇨ See page 20-3.

*4 Checksum code (SC_H and SC_L)

To improve the reliability of the transmitted data, in addition to a parity check, error detection by a checksum is used for error detection.

When the IV-S30 does not need to complete a checksum for error detection, use an @ (at sign: ASCII code 40_(H)) in each of the checksum codes SC_H and SC_L included in the command.

[Error detection using a checksum]

The ASCII code for each data byte, from the processing code to the end of text (prior to the checksum code), is added. The final value is compared to the checksum code which is treated the same way. If the two values are identical, the command is considered to be valid. I/F they are not identical, an error has occurred during transmission.

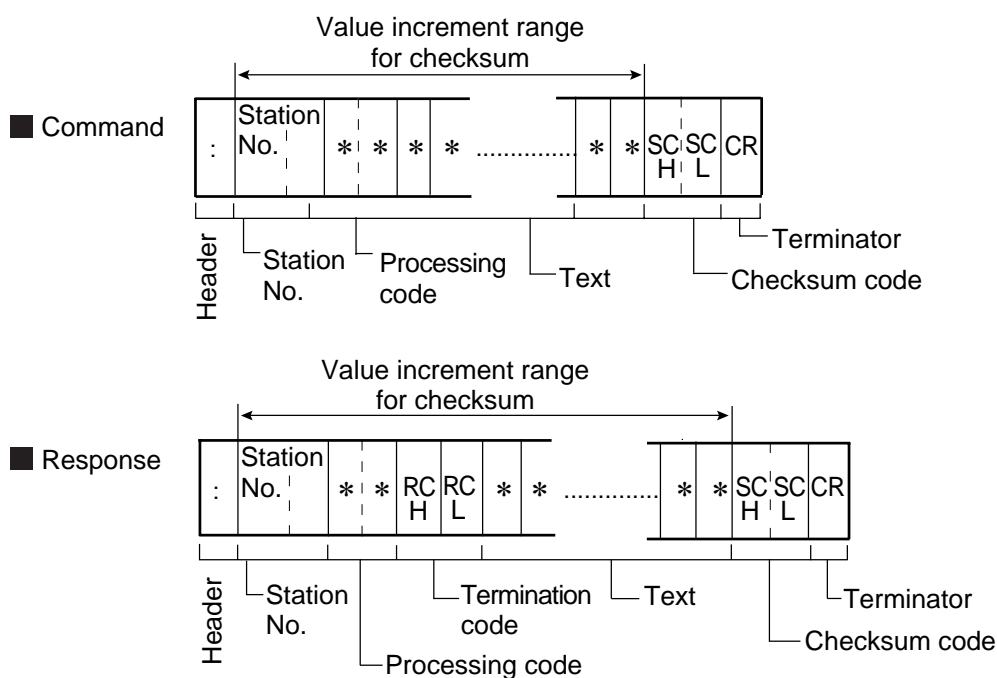

[Method for creating a checksum code]

The ASCII code for each byte of data, from the processing code to the end of text (prior to the checksum code) is added together. The lower 1 byte of this sum is divided into the upper 4 bits and the lower 4 bits. The hex character (0 to F) is converted to the ASCII code for that character and sent as one byte. Thus the checksum code consists of two bytes.

Ex. 1 Command for the measurement execution function 1 (code 10_(H))

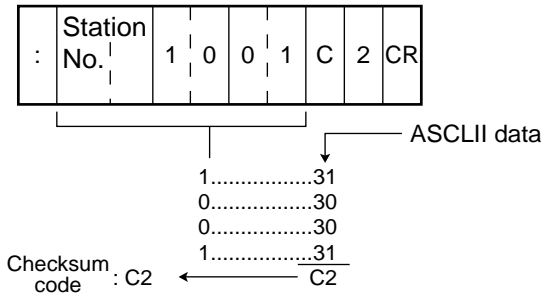

Ex. 2 Command for the measurement execution function 7 (code 1A_(H))

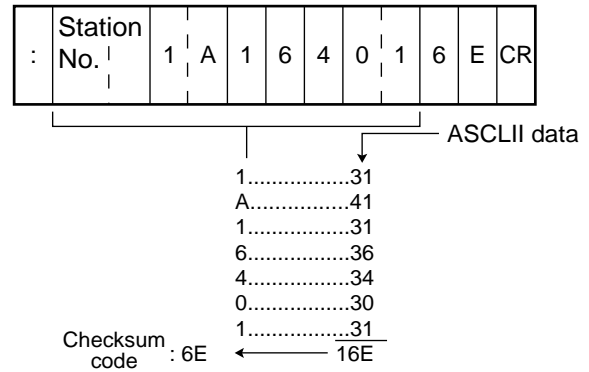

Note

- This manual uses the following notation to represent addresses and set values.

Octal numberl	(8)	Ex. 377 ₍₈₎
Decimal number	None	Ex. 255
Hexadecimal number	(H)	Ex. FF _(H)

18-4 Processing functions

[1] Measurement execution functions

(1) Measurement execution function 1: code 10_(H)

This command will cause the IV-S30 to execute all of the measurement programs for a specified object type. (You can specify the camera to use for measurements.)

The results in the ladder outputs (Y00 to 15) will be sent back as the response.

On page 18-1 you can see how each command affects the various inputs and outputs.

■ Command

:	Station No.	1	0	Object type	Execution camera	SC(H)	SC(L)	CR
---	-------------	---	---	-------------	------------------	-------	-------	----

■ Response

:	Station No.	1	0	RC(H)	RC(L)	Object type	Execution camera	Final output evaluation result				SC(H)	SC(L)	CR
								Y0	Y1	...	Y15			

- Object type → Object type to measure: 00 to 3F
- Execution camera number → 0: Both cameras 1 and 2; 1: Camera 1 only; 2: Camera 2 only
- Final output evaluation result (Y0 to Y15) → 0: NG or unspecified, 1: OK
- Data flow ⇨ See page 18-3.

(2) Measurement execution function 2: code 11_(H)

This command will cause the IV-S30 to execute all of the measurement programs for a specified object type. (You can specify the camera to use for measurements.)

The results in the ladder outputs (Y00 to 15) and the measurement data in block 0 of each measurement will be sent back as the response.

On page 18-1 you can see how each command affects the various inputs and outputs.

■ Command

:	Station No.	1	1	Object type	Execution camera	SC(H)	SC(L)	CR
---	-------------	---	---	-------------	------------------	-------	-------	----

■ Response

:	Station No.	1	1	RC(H)	RC(L)	Object type	Execution camera	Final output evaluation result				①					
								Y0	Y1	...	Y15	Camera 1	Camera 2	Measurement 1	Measurement 2	Measurement 3	Measurement 4

Measurement 0		Data on measurement 1 ②	Data on measurement 2 ②	Data on measurement 3 ②	Data on measurement 4 ②	SC(H)	SC(L)	CR
Camera 1 data ②	Camera 2 data ②							

- Object type → Object type to measure: 00 to 3F
- Execution camera number → 0: Both camera 1 and 2; 1: Camera 1 only; 2: Camera 2 only
- Final Output evaluation result (Y0 to Y15) → 0: NG or unspecified, 1: OK
- ① → Measurement programs 0 to 4

0 = none, 1 = positional deviation measurement, 2 = degree of match inspection, 3 = lead inspection, 4 = BGA/CSP inspection, 5 = area measurement by binary conversion, 6 = object counting by binary conversion, 7 = object identification by binary conversion, 8 = point measurement, 9 = multiple positions measurement, A = multiple degree of inspections

- ② → Measurement data

Only the data in block 0 of a measurement program is output. (For details about the data arrangement in a block, see the section "Measurement data blocks" in Chapter 19, "Computer link.")

- Data flow ⇨ See page 18-3.

(3) Measurement execution function 3 : code 12(H)

This command will cause the IV-S30 to execute all of the measurement programs for a specified object type. (You can specify the camera to use for measurements.)
 The results in the ladder outputs (Y00 to 15) and the results from a specified block in a specified measurement will be sent back as the response.

On page 18-1 you can see how each command affects the various inputs and outputs.

■ Command

:	Station No.	1	2	Object type	Execution camera	Measurement	Block No.	SC (H)	SC (L)	CR
---	-------------	---	---	-------------	------------------	-------------	-----------	--------	--------	----

- Measurement Number → A measurement number that outputs numerical data (MEASURE 0 CAMERA 1: 0, MEASURE 0 CAMERA 2: 1, and MEASUREMENT 1 to 4: 2 to 5)

- Block → Specified block from which the data of a specified measurement function will be output.

■ Response

:	Station No.	1	2	RC (H)	RC (L)	Object type	Execution camera	Final Output evaluation result	Specified block data	SC (H)	SC (L)	CR
								Y0, Y1, ..., Y15	①			

- Object type → Object type to measure: 00 to 3F
- Execution camera number → 0: Both camera 1 and 2; 1: Camera 1 only; 2: Camera 2 only
- Final output evaluation result (Y0 to Y15) → 0: NG or unspecified, 1: OK
- ① → Specified block data (For details about the data arrangement in a block, see the section "Measurement data blocks" in Chapter 19, "Computer link.")
- Data flow ⇨ See page 18-3.

(4) Measurement execution function 4: code 14(H)

This command will cause the IV-S30 to execute all of the measurement programs for a specified object type. (You can specify the camera to use for measurements.)
 Any numerical data selected by the IV-S30 can be output as the response.

⇨ See page 17-26.

On page 17-1 you can see how each command affects the various inputs and outputs.

■ Command

:	Station No.	1	4	Object type	Execution camera	①	SC (H)	SC (L)	CR
---	-------------	---	---	-------------	------------------	---	--------	--------	----

■ Response

:	Station No.	1	4	RC (H)	RC (L)	Object type	Execution camera	Measurement code	Any numerical data	SC (H)	SC (L)	CR
---	-------------	---	---	--------	--------	-------------	------------------	------------------	--------------------	--------	--------	----

- ① → 0: Execute/read, 1: Read
- Object type → Object type to measure: 00 to 3F
- Execution camera number → 0: Both camera 1 and 2; 1: Camera 1 only; 2: Camera 2 only
- Measurement code (response)

Measurement code	Setting	Measurement code	Setting
0	MEASURE 0 CAMERA 1	5	MEASUREMENT 4
1	MEASURE 0 CAMERA 2	6	Distance and angle measurement
2	MEASUREMENT 1	7	Numerical calculation
3	MEASUREMENT 2	F	Quit
4	MEASUREMENT 3		

- Specifications for any output data ⇨ See page 18-16.
- Data flow ⇨ See page 18-3.

[2] Result reading

Data from the last measurement is read. (No instruction is sent to execute an operation.)
 For details about the measurement data blocks, see the section "Measurement data blocks" in "Chapter 19: Computer link."

(1) Measurement data reading function 1: code 20_(H)

This command will cause the IV-S30 to read the results of the last measurement.
 The results in the ladder outputs (Y00 to 15) will be sent back as the response.
 This command is effective regardless of the measurement input specified.

■ Command

:	Station No.	2	0	SC (H)	SC (L)	CR
---	-------------	---	---	--------	--------	----

■ Response

:	Station No.	2	0	RC (H)	RC (L)	Object type	Execution camera	Final output evaluation result				SC (H)	SC (L)	CR
								Y0	Y1	...	Y15			

- Object type → Object type for which the measurement was executed: 00 to 3F
- Executed camera number → 0: Both camera 1 and 2; 1: Camera 1 only; 2: Camera 2 only
- Final output evaluation result (Y0 to Y15) → 0: NG or unspecified, 1: OK

(2) Measurement data reading function 2: code 21_(H)

This command will cause the IV-S30 to read the results of the last measurement.
 The results in the ladder outputs (Y00 to 15) and the measurement data in block 0 of each measurement will be sent back as the response.
 This command is effective regardless of the measurement input specified.

■ Command

:	Station No.	2	1	SC (H)	SC (L)	CR
---	-------------	---	---	--------	--------	----

■ Response

:	2	1	RC (H)	RC (L)	Object type	Execution camera	Final output evaluation result				① Measurement 0					
							Y0	Y1	...	Y15	Camera 1	Camera 2	Measurement 1	Measurement 2	Measurement 3	Measurement 4

Measurement 0		Data on measurement 1 ②	Data on measurement 2 ②	Data on measurement 3 ②	Data on measurement 4 ②	SC (H)	SC (L)	CR
Camera 1 data ②	Camera 2 data ②							

- Object type → Object type for which the measurement was executed: 00 to 3F
- Executed camera number → 0: Both camera 1 and 2; 1: Camera 1 only; 2: Camera 2 only
- Final Output evaluation result (Y0 to Y15) → 0: NG or unspecified, 1: OK
- ① → Measurement programs 0 to 4
 - 0 = none, 1 = positional deviation measurement, 2 = degree of match inspection, 3 = lead inspection, 4 = BGA/CSP inspection, 5 = area measurement by binary conversion, 6 = object counting by binary conversion, 7 = object identification by binary conversion, 8 = point measurement, 9 = multiple positions measurement, A = multiple degree of inspections

- ② → Measurement data
 Only the data in block 0 of a measurement program is output.

(3) Measurement data reading function 3: code 22^(H)

This command will cause the IV-S30 to read the results of the last measurement. The results in the ladder outputs (Y00 to 15) and the measurement data in block 0 of each measurement will be sent back as the response. This command is effective regardless of the measurement input specified.

■ Command

:	Station No.	2	2	Object type	Measurement	Block	SC(H)	SC(L)	CR
---	-------------	---	---	-------------	-------------	-------	-------	-------	----

■ Response

:	Station No.	2	2	RC(H)	RC(L)	Object type	Execution camera	Final output evaluation result Y0, Y1, ..., Y15	Specified block data ①	SC(H)	SC(L)	CR
---	-------------	---	---	-------	-------	-------------	------------------	-------------------------------------------------	------------------------	-------	-------	----

- Object type → Object type for which the measurement was executed: 00 to 3F
- Executed camera number → 0: Both camera 1 and 2; 1: Camera 1 only; 2: Camera 2 only
- Final Output evaluation result (Y0 to Y15) → 0: NG or unspecified, 1: OK
- ① → Specified block data

(4) Measurement data reading function 4: code 24^(H)

This command will cause the IV-S30 to read the results of the last measurement. Any numeric value data will be output as a response. ⇨ See page 17-26. This command is effective regardless of the measurement input specified.

■ Command

:	Station No.	2	4	Measurement code	SC(H)	SC(L)	CR
---	-------------	---	---	------------------	-------	-------	----

- Measurement Number → A measurement number that outputs numerical data (MEASURE 0 CAMERA 1: 0, MEASURE 0 CAMERA 2: 1, and MEASUREMENT 1 to 4: 2 to 5)
- Block → Specified block from which the data of a specified measurement function will be output.

■ Response

:	Station No.	2	4	RC(H)	RC(L)	Object type	Execution camera	Measurement code	Any numerical data	SC(H)	SC(L)	CR
---	-------------	---	---	-------	-------	-------------	------------------	------------------	--------------------	-------	-------	----

- Object type → Object type for which the measurement was executed: 00 to 3F
- Executed camera number → 0: Both camera 1 and 2; 1: Camera 1 only; 2: Camera 2 only

[(Response) measurement code]

Measurement code	Setting	Measurement code	Setting
0	MEASURE 0 CAMERA 1	5	MEASUREMENT 4
1	MEASURE 0 CAMERA 2	6	Distance and angle measurement
2	MEASUREMENT 1	7	Numerical calculation
3	MEASUREMENT 2		
4	MEASUREMENT 3		

- Specification for any output data ⇨ See page 18-16.

(5) Illuminance level reading: code 28^(H)

The illuminance level measured by the illuminance monitor function and the evaluation result are read.

■ Command

:	Station No.	2	8	Execution camera	SC(H)	SC(L)	CR
---	-------------	---	---	------------------	-------	-------	----

■ Response

:	Station No.	2	8	RC(H)	RC(L)	Object type	Result	Illuminance			SC(H)	SC(L)	CR	
								10 ²	10 ¹	10 ⁰	10 ⁻¹			

- Camera No. → 0: camera 1, 1: camera 2
- Object type → Object type for which the measurement was executed: 00 to 3F
- Result → 0: NG, 1: OK
- Illuminance → 000.0 to 255.0

(6) Corrected light level reading: code 29^(H)

The corrected light level measured by the illuminance monitor function, the evaluation result and preset reference light level are read.

■ Command

:	Station No.	2	9	Execution camera	SC(H)	SC(L)	CR
---	-------------	---	---	------------------	-------	-------	----

- Camera No. → 0: camera 1, 1: camera 2

■ Response

:	Station No.	2	9	RC(H)	RC(L)	Object type	Result	Corrected light level			Reference light level			SC(H)	SC(L)	CR			
								±	10 ²	10 ¹	10 ⁰	10 ⁻¹	10 ²	10 ¹	10 ⁰	10 ⁻¹			

- Object type → Object type for which the measurement was executed: 00 to 3F
- Result → 0: NG, 1: OK
- Corrected light level → Corrected light level (-0 to 255.0)
- Reference light level → Light level used as the criterion (0 to 255.0)

[3] Setting, initialization, and diagnosis of the operation screen

Shown below are only the commands and responses of these processing functions.

Process function	Process code	Communication format																														
Individual conditions	Read operation screen lock status	<p>50</p> <p>■ Command</p> <table border="1"> <tr> <td>Station No.</td> <td>5</td> <td>0</td> <td>SC</td> <td>SC</td> <td>CR</td> </tr> <tr> <td></td> <td>(H)</td> <td>(L)</td> <td></td> <td></td> <td></td> </tr> </table> <p>■ Response</p> <table border="1"> <tr> <td>Station No.</td> <td>5</td> <td>0</td> <td>RC</td> <td>RC</td> <td>①</td> <td>SC</td> <td>SC</td> <td>CR</td> </tr> <tr> <td></td> <td>(H)</td> <td>(L)</td> <td>(H)</td> <td>(L)</td> <td></td> <td>(H)</td> <td>(L)</td> <td></td> </tr> </table> <p>① → Operation screen lock [0 : lock OFF] [1 : lock ON]</p>	Station No.	5	0	SC	SC	CR		(H)	(L)				Station No.	5	0	RC	RC	①	SC	SC	CR		(H)	(L)	(H)	(L)		(H)	(L)	
	Station No.	5	0	SC	SC	CR																										
		(H)	(L)																													
	Station No.	5	0	RC	RC	①	SC	SC	CR																							
		(H)	(L)	(H)	(L)		(H)	(L)																								
	Set operation screen lock status	51	<p>■ Command</p> <table border="1"> <tr> <td>Station No.</td> <td>5</td> <td>1</td> <td>①</td> <td>SC</td> <td>SC</td> <td>CR</td> </tr> <tr> <td></td> <td>(H)</td> <td>(L)</td> <td></td> <td>(H)</td> <td>(L)</td> <td></td> </tr> </table> <p>① → Operation screen lock [0 : lock OFF] [1 : lock ON]</p> <p>■ Response</p> <table border="1"> <tr> <td>Station No.</td> <td>5</td> <td>1</td> <td>RC</td> <td>RC</td> <td>SC</td> <td>SC</td> <td>CR</td> </tr> <tr> <td></td> <td>(H)</td> <td>(L)</td> <td>(H)</td> <td>(L)</td> <td>(H)</td> <td>(L)</td> <td></td> </tr> </table>	Station No.	5	1	①	SC	SC	CR		(H)	(L)		(H)	(L)		Station No.	5	1	RC	RC	SC	SC	CR		(H)	(L)	(H)	(L)	(H)	(L)
Station No.	5	1	①	SC	SC	CR																										
	(H)	(L)		(H)	(L)																											
Station No.	5	1	RC	RC	SC	SC	CR																									
	(H)	(L)	(H)	(L)	(H)	(L)																										
Read from the English or Japanese display	52	<p>■ Command</p> <table border="1"> <tr> <td>Station No.</td> <td>5</td> <td>2</td> <td>SC</td> <td>SC</td> <td>CR</td> </tr> <tr> <td></td> <td>(H)</td> <td>(L)</td> <td></td> <td></td> <td></td> </tr> </table> <p>■ Response</p> <table border="1"> <tr> <td>Station No.</td> <td>5</td> <td>2</td> <td>RC</td> <td>RC</td> <td>①</td> <td>SC</td> <td>SC</td> <td>CR</td> </tr> <tr> <td></td> <td>(H)</td> <td>(L)</td> <td>(H)</td> <td>(L)</td> <td></td> <td>(H)</td> <td>(L)</td> <td></td> </tr> </table> <p>① → English or Japanese display [0 : Japanese] [1 : English]</p>	Station No.	5	2	SC	SC	CR		(H)	(L)				Station No.	5	2	RC	RC	①	SC	SC	CR		(H)	(L)	(H)	(L)		(H)	(L)	
Station No.	5	2	SC	SC	CR																											
	(H)	(L)																														
Station No.	5	2	RC	RC	①	SC	SC	CR																								
	(H)	(L)	(H)	(L)		(H)	(L)																									
Set items on the English or Japanese display	53	<p>■ Command</p> <table border="1"> <tr> <td>Station No.</td> <td>5</td> <td>3</td> <td>①</td> <td>SC</td> <td>SC</td> <td>CR</td> </tr> <tr> <td></td> <td>(H)</td> <td>(L)</td> <td></td> <td>(H)</td> <td>(L)</td> <td></td> </tr> </table> <p>① → English or Japanese display [0 : Japanese] [1 : English]</p> <p>■ Response</p> <table border="1"> <tr> <td>Station No.</td> <td>5</td> <td>3</td> <td>RC</td> <td>RC</td> <td>SC</td> <td>SC</td> <td>CR</td> </tr> <tr> <td></td> <td>(H)</td> <td>(L)</td> <td>(H)</td> <td>(L)</td> <td>(H)</td> <td>(L)</td> <td></td> </tr> </table>	Station No.	5	3	①	SC	SC	CR		(H)	(L)		(H)	(L)		Station No.	5	3	RC	RC	SC	SC	CR		(H)	(L)	(H)	(L)	(H)	(L)	
Station No.	5	3	①	SC	SC	CR																										
	(H)	(L)		(H)	(L)																											
Station No.	5	3	RC	RC	SC	SC	CR																									
	(H)	(L)	(H)	(L)	(H)	(L)																										
Read object type number	54	<p>■ Command</p> <table border="1"> <tr> <td>Station No.</td> <td>5</td> <td>4</td> <td>SC</td> <td>SC</td> <td>CR</td> </tr> <tr> <td></td> <td>(H)</td> <td>(L)</td> <td></td> <td></td> <td></td> </tr> </table> <p>■ Response</p> <table border="1"> <tr> <td>Station No.</td> <td>5</td> <td>4</td> <td>RC</td> <td>RC</td> <td>Object type</td> <td>SC</td> <td>SC</td> <td>CR</td> </tr> <tr> <td></td> <td>(H)</td> <td>(L)</td> <td>(H)</td> <td>(L)</td> <td></td> <td>(H)</td> <td>(L)</td> <td></td> </tr> </table> <p>① → Type number(00 to 3F)</p>	Station No.	5	4	SC	SC	CR		(H)	(L)				Station No.	5	4	RC	RC	Object type	SC	SC	CR		(H)	(L)	(H)	(L)		(H)	(L)	
Station No.	5	4	SC	SC	CR																											
	(H)	(L)																														
Station No.	5	4	RC	RC	Object type	SC	SC	CR																								
	(H)	(L)	(H)	(L)		(H)	(L)																									
Assign object type number	55	<p>■ Command</p> <table border="1"> <tr> <td>Station No.</td> <td>5</td> <td>5</td> <td>Object type</td> <td>SC</td> <td>SC</td> <td>CR</td> </tr> <tr> <td></td> <td>(H)</td> <td>(L)</td> <td>(H)</td> <td>(L)</td> <td></td> <td></td> </tr> </table> <p>① → Type number(00 to 3F)</p> <p>■ Response</p> <table border="1"> <tr> <td>Station No.</td> <td>5</td> <td>5</td> <td>RC</td> <td>RC</td> <td>SC</td> <td>SC</td> <td>CR</td> </tr> <tr> <td></td> <td>(H)</td> <td>(L)</td> <td>(H)</td> <td>(L)</td> <td>(H)</td> <td>(L)</td> <td></td> </tr> </table>	Station No.	5	5	Object type	SC	SC	CR		(H)	(L)	(H)	(L)			Station No.	5	5	RC	RC	SC	SC	CR		(H)	(L)	(H)	(L)	(H)	(L)	
Station No.	5	5	Object type	SC	SC	CR																										
	(H)	(L)	(H)	(L)																												
Station No.	5	5	RC	RC	SC	SC	CR																									
	(H)	(L)	(H)	(L)	(H)	(L)																										

Process function	Process code	Communication format																			
Individual conditions	Read the image status	<p>56</p> <p>■ Command</p> <table border="1"> <tr> <td>:</td> <td>Station No.</td> <td>5</td> <td>6</td> <td>SC (H)</td> <td>SC (L)</td> <td>CR</td> </tr> </table> <p>①→Output [0 : Freeze 1 : Through]</p> <p>■ Response</p> <table border="1"> <tr> <td>:</td> <td>Station No.</td> <td>5</td> <td>6</td> <td>RC (H)</td> <td>RC (L)</td> <td>Output Brightness</td> <td>SC (H)</td> <td>SC (L)</td> <td>CR</td> </tr> </table> <p>②→Light [0 : Full 1 : Half]</p>	:	Station No.	5	6	SC (H)	SC (L)	CR	:	Station No.	5	6	RC (H)	RC (L)	Output Brightness	SC (H)	SC (L)	CR		
	:	Station No.	5	6	SC (H)	SC (L)	CR														
	:	Station No.	5	6	RC (H)	RC (L)	Output Brightness	SC (H)	SC (L)	CR											
	Set the image status	57	<p>■ Command</p> <table border="1"> <tr> <td>:</td> <td>Station No.</td> <td>5</td> <td>7</td> <td>Output Brightness</td> <td>SC (H)</td> <td>SC (L)</td> <td>CR</td> </tr> </table> <p>①→Output [0 : Freeze 1 : Through]</p> <p>■ Response</p> <table border="1"> <tr> <td>:</td> <td>Station No.</td> <td>5</td> <td>7</td> <td>RC (H)</td> <td>RC (L)</td> <td>SC (H)</td> <td>SC (L)</td> <td>CR</td> </tr> </table> <p>②→Light [0 : Full 1 : Half]</p>	:	Station No.	5	7	Output Brightness	SC (H)	SC (L)	CR	:	Station No.	5	7	RC (H)	RC (L)	SC (H)	SC (L)	CR	
	:	Station No.	5	7	Output Brightness	SC (H)	SC (L)	CR													
:	Station No.	5	7	RC (H)	RC (L)	SC (H)	SC (L)	CR													
Read out image camera condition	58	<p>■ Command</p> <table border="1"> <tr> <td>:</td> <td>Station No.</td> <td>5</td> <td>8</td> <td>SC (H)</td> <td>SC (L)</td> <td>CR</td> </tr> </table> <p>① Camera 1 ② Camera 2</p> <p>Camera1 display ① ② 8 0 4 0 </p> <p>Camera2 display ① ② 4 0 8 0 </p> <p>Horizontal division display ① ② 0 X1 0 X2 </p> <p>■ Response</p> <table border="1"> <tr> <td>:</td> <td>Station No.</td> <td>5</td> <td>8</td> <td>RC (H)</td> <td>RC (L)</td> <td>①</td> <td>②</td> <td>SC (H)</td> <td>SC (L)</td> <td>CR</td> </tr> </table>	:	Station No.	5	8	SC (H)	SC (L)	CR	:	Station No.	5	8	RC (H)	RC (L)	①	②	SC (H)	SC (L)	CR	
:	Station No.	5	8	SC (H)	SC (L)	CR															
:	Station No.	5	8	RC (H)	RC (L)	①	②	SC (H)	SC (L)	CR											
Set output image camera condition	59	<p>■ Command</p> <table border="1"> <tr> <td>:</td> <td>Station No.</td> <td>5</td> <td>9</td> <td>①</td> <td>②</td> <td>SC (H)</td> <td>SC (L)</td> <td>CR</td> </tr> </table> <p>Camera1 display ① ② 8 0 4 0 </p> <p>Camera2 display ① ② 4 0 8 0 </p> <p>Horizontal division display ① ② 0 X1 0 X2 </p> <p>■ Response</p> <table border="1"> <tr> <td>:</td> <td>Station No.</td> <td>5</td> <td>9</td> <td>RC (H)</td> <td>RC (L)</td> <td>SC (H)</td> <td>SC (L)</td> <td>CR</td> <td>① Camera 1 ② Camera 2</td> </tr> </table>	:	Station No.	5	9	①	②	SC (H)	SC (L)	CR	:	Station No.	5	9	RC (H)	RC (L)	SC (H)	SC (L)	CR	① Camera 1 ② Camera 2
:	Station No.	5	9	①	②	SC (H)	SC (L)	CR													
:	Station No.	5	9	RC (H)	RC (L)	SC (H)	SC (L)	CR	① Camera 1 ② Camera 2												
Read the shutter speed for each object type	5A	<p>■ Command</p> <table border="1"> <tr> <td>:</td> <td>Station No.</td> <td>5</td> <td>A</td> <td>SC (H)</td> <td>SC (L)</td> <td>CR</td> </tr> </table> <p>①→Shutter speed (001E to 2710_(H)) : 1/30 to 1/10000)</p> <p>■ Response</p> <table border="1"> <tr> <td>:</td> <td>Station No.</td> <td>5</td> <td>A</td> <td>RC (H)</td> <td>RC (L)</td> <td>Shutter speed</td> <td>SC (H)</td> <td>SC (L)</td> <td>CR</td> </tr> </table>	:	Station No.	5	A	SC (H)	SC (L)	CR	:	Station No.	5	A	RC (H)	RC (L)	Shutter speed	SC (H)	SC (L)	CR		
:	Station No.	5	A	SC (H)	SC (L)	CR															
:	Station No.	5	A	RC (H)	RC (L)	Shutter speed	SC (H)	SC (L)	CR												
Set the shutter speed for each object type	5B	<p>■ Command</p> <table border="1"> <tr> <td>:</td> <td>Station No.</td> <td>5</td> <td>B</td> <td>Shutter speed</td> <td>SC (H)</td> <td>SC (L)</td> <td>CR</td> </tr> </table> <p>■ Response</p> <table border="1"> <tr> <td>:</td> <td>Station No.</td> <td>5</td> <td>B</td> <td>RC (H)</td> <td>RC (L)</td> <td>SC (H)</td> <td>SC (L)</td> <td>CR</td> <td>①→Shutter speed (001E to 2710_(H)) : 1/30 to 1/10000)</td> </tr> </table>	:	Station No.	5	B	Shutter speed	SC (H)	SC (L)	CR	:	Station No.	5	B	RC (H)	RC (L)	SC (H)	SC (L)	CR	①→Shutter speed (001E to 2710 _(H)) : 1/30 to 1/10000)	
:	Station No.	5	B	Shutter speed	SC (H)	SC (L)	CR														
:	Station No.	5	B	RC (H)	RC (L)	SC (H)	SC (L)	CR	①→Shutter speed (001E to 2710 _(H)) : 1/30 to 1/10000)												

Process function	Process code	Communication format																													
Individual conditions	Read the time 5C	<p>■ Command</p> <table border="1"> <tr> <td>:</td> <td>Station No.</td> <td>5</td> <td>C</td> <td>SC (H)</td> <td>SC (L)</td> <td>CR</td> </tr> </table> <p>■ Response</p> <table border="1"> <tr> <td>:</td> <td>Station No.</td> <td>5</td> <td>C</td> <td>RC (H)</td> <td>RC (L)</td> <td>Year (H)</td> <td>Year (L)</td> <td>Month (H)</td> <td>Month (L)</td> <td>Day (H)</td> <td>Day (L)</td> <td>Hour (H)</td> <td>Hour (L)</td> <td>Min (H)</td> <td>Min (L)</td> <td>Sec (H)</td> <td>Sec (L)</td> <td>SC (H)</td> <td>SC (L)</td> <td>CR</td> </tr> </table>	:	Station No.	5	C	SC (H)	SC (L)	CR	:	Station No.	5	C	RC (H)	RC (L)	Year (H)	Year (L)	Month (H)	Month (L)	Day (H)	Day (L)	Hour (H)	Hour (L)	Min (H)	Min (L)	Sec (H)	Sec (L)	SC (H)	SC (L)	CR	
	:	Station No.	5	C	SC (H)	SC (L)	CR																								
	:	Station No.	5	C	RC (H)	RC (L)	Year (H)	Year (L)	Month (H)	Month (L)	Day (H)	Day (L)	Hour (H)	Hour (L)	Min (H)	Min (L)	Sec (H)	Sec (L)	SC (H)	SC (L)	CR										
	Set the time 5D	<p>■ Command</p> <table border="1"> <tr> <td>:</td> <td>Station No.</td> <td>5</td> <td>D</td> <td>RC (H)</td> <td>RC (L)</td> <td>Year (H)</td> <td>Year (L)</td> <td>Month (H)</td> <td>Month (L)</td> <td>Day (H)</td> <td>Day (L)</td> <td>Hour (H)</td> <td>Hour (L)</td> <td>Min (H)</td> <td>Min (L)</td> <td>Sec (H)</td> <td>Sec (L)</td> <td>SC (H)</td> <td>SC (L)</td> <td>CR</td> </tr> </table> <p>■ Response</p> <table border="1"> <tr> <td>:</td> <td>Station No.</td> <td>5</td> <td>D</td> <td>RC (H)</td> <td>RC (L)</td> <td>SC (H)</td> <td>SC (L)</td> <td>CR</td> </tr> </table>	:	Station No.	5	D	RC (H)	RC (L)	Year (H)	Year (L)	Month (H)	Month (L)	Day (H)	Day (L)	Hour (H)	Hour (L)	Min (H)	Min (L)	Sec (H)	Sec (L)	SC (H)	SC (L)	CR	:	Station No.	5	D	RC (H)	RC (L)	SC (H)	SC (L)
:	Station No.	5	D	RC (H)	RC (L)	Year (H)	Year (L)	Month (H)	Month (L)	Day (H)	Day (L)	Hour (H)	Hour (L)	Min (H)	Min (L)	Sec (H)	Sec (L)	SC (H)	SC (L)	CR											
:	Station No.	5	D	RC (H)	RC (L)	SC (H)	SC (L)	CR																							
Register a reference image 5E	<p>■ Command</p> <table border="1"> <tr> <td>:</td> <td>Station No.</td> <td>5</td> <td>E</td> <td>① Object</td> <td>Measurement No.</td> <td>SC (H)</td> <td>SC (L)</td> <td>CR</td> </tr> </table> <p>① → [0: Measurement program 1: Comparative calculations between images]</p> <p>■ Response</p> <table border="1"> <tr> <td>:</td> <td>Station No.</td> <td>5</td> <td>E</td> <td>RC (H)</td> <td>RC (L)</td> <td>SC (H)</td> <td>SC (L)</td> <td>CR</td> </tr> </table>	:	Station No.	5	E	① Object	Measurement No.	SC (H)	SC (L)	CR	:	Station No.	5	E	RC (H)	RC (L)	SC (H)	SC (L)	CR												
:	Station No.	5	E	① Object	Measurement No.	SC (H)	SC (L)	CR																							
:	Station No.	5	E	RC (H)	RC (L)	SC (H)	SC (L)	CR																							
Initialize all parameters 60	<p>■ Command</p> <table border="1"> <tr> <td>:</td> <td>Station No.</td> <td>6</td> <td>0</td> <td>①</td> <td>SC (H)</td> <td>SC (L)</td> <td>CR</td> </tr> </table> <p>① → Initialize memory [0: Flash memory and RAM 1: RAM]</p> <p>■ Response</p> <table border="1"> <tr> <td>:</td> <td>Station No.</td> <td>6</td> <td>0</td> <td>RC (H)</td> <td>RC (L)</td> <td>SC (H)</td> <td>SC (L)</td> <td>CR</td> </tr> </table>	:	Station No.	6	0	①	SC (H)	SC (L)	CR	:	Station No.	6	0	RC (H)	RC (L)	SC (H)	SC (L)	CR													
:	Station No.	6	0	①	SC (H)	SC (L)	CR																								
:	Station No.	6	0	RC (H)	RC (L)	SC (H)	SC (L)	CR																							
Self diagnostic 68	<p>■ Command</p> <table border="1"> <tr> <td>:</td> <td>Station No.</td> <td>6</td> <td>8</td> <td>SC (H)</td> <td>SC (L)</td> <td>CR</td> </tr> </table> <p>■ Response</p> <table border="1"> <tr> <td>:</td> <td>Station No.</td> <td>6</td> <td>8</td> <td>RC (H)</td> <td>RC (L)</td> <td>SC (H)</td> <td>SC (L)</td> <td>CR</td> </tr> </table>	:	Station No.	6	8	SC (H)	SC (L)	CR	:	Station No.	6	8	RC (H)	RC (L)	SC (H)	SC (L)	CR														
:	Station No.	6	8	SC (H)	SC (L)	CR																									
:	Station No.	6	8	RC (H)	RC (L)	SC (H)	SC (L)	CR																							
Reset 69	<p>■ Command</p> <table border="1"> <tr> <td>:</td> <td>Station No.</td> <td>6</td> <td>9</td> <td>SC (H)</td> <td>SC (L)</td> <td>CR</td> </tr> </table> <p>■ Response</p> <table border="1"> <tr> <td>:</td> <td>Station No.</td> <td>6</td> <td>9</td> <td>RC (H)</td> <td>RC (L)</td> <td>SC (H)</td> <td>SC (L)</td> <td>CR</td> </tr> </table>	:	Station No.	6	9	SC (H)	SC (L)	CR	:	Station No.	6	9	RC (H)	RC (L)	SC (H)	SC (L)	CR														
:	Station No.	6	9	SC (H)	SC (L)	CR																									
:	Station No.	6	9	RC (H)	RC (L)	SC (H)	SC (L)	CR																							

Process function	Process code	Communication format																				
Read the manual measurement coordinates	70	<p>■ Command</p> <table border="1"> <tr> <td>:</td> <td>Station No.</td> <td>7</td> <td>0</td> <td>SC(H)</td> <td>SC(L)</td> <td>CR</td> </tr> </table> <p>① → X coordinate 0X of the 0th detection (000 to IFF(H)) : 0 to 0511 ② → Y coordinate 0Y of the 0th detection (000 to IDF(H)) : 0 to 479 ③ → X coordinate 1X of the 1st detection (000 to IFE(H)) : 0 to 511 ④ → Y coordinate 1Y of the 1st detection (000 to IDF(H)) : 0 to 479</p> <p>■ Response</p> <table border="1"> <tr> <td>:</td> <td>Station No.</td> <td>7</td> <td>0</td> <td>RC(H)</td> <td>RC(L)</td> <td>①</td> <td>②</td> <td>③</td> <td>④</td> <td>SC(H)</td> <td>SC(L)</td> <td>CR</td> </tr> </table>	:	Station No.	7	0	SC(H)	SC(L)	CR	:	Station No.	7	0	RC(H)	RC(L)	①	②	③	④	SC(H)	SC(L)	CR
:	Station No.	7	0	SC(H)	SC(L)	CR																
:	Station No.	7	0	RC(H)	RC(L)	①	②	③	④	SC(H)	SC(L)	CR										
Set the manual measurement coordinates	71	<p>■ Command</p> <table border="1"> <tr> <td>:</td> <td>Station No.</td> <td>7</td> <td>1</td> <td>①</td> <td>②</td> <td>③</td> <td>④</td> <td>SC(H)</td> <td>SC(L)</td> <td>CR</td> </tr> </table> <p>■ Response</p> <table border="1"> <tr> <td>:</td> <td>Station No.</td> <td>7</td> <td>1</td> <td>RC(H)</td> <td>RC(L)</td> <td>SC(H)</td> <td>SC(L)</td> <td>CR</td> </tr> </table> <p>① → X coordinate 0X of the 0th detection (000 to IFF(H)) : 0 to 0511 ② → Y coordinate 0Y of the 0th detection (000 to IDF(H)) : 0 to 479 ③ → X coordinate 1X of the 1st detection (000 to IFE(H)) : 0 to 511 ④ → Y coordinate 1Y of the 1st detection (000 to IDF(H)) : 0 to 479</p>	:	Station No.	7	1	①	②	③	④	SC(H)	SC(L)	CR	:	Station No.	7	1	RC(H)	RC(L)	SC(H)	SC(L)	CR
:	Station No.	7	1	①	②	③	④	SC(H)	SC(L)	CR												
:	Station No.	7	1	RC(H)	RC(L)	SC(H)	SC(L)	CR														

[4] Setting numerical data of the any output measuring

Numerical data of the any setting of the response at measuring (code 14(H): page 18-8) and reading measurement data 4 (code 24(H): page 18-10) is as follows.

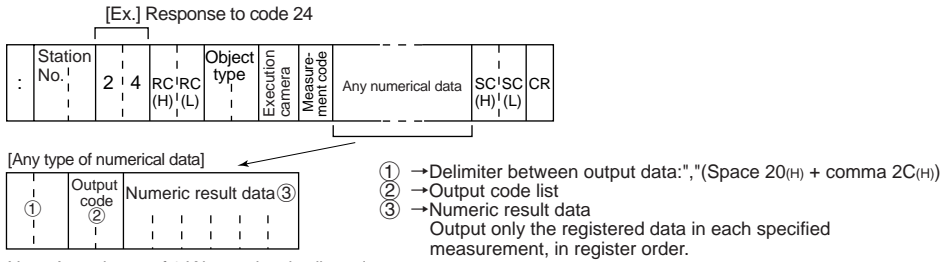

Note: A maximum of 1 K bytes data is allowed.

[Ex.] A numerical data of the any setting when outputting coordinate X and coordinate Y with the positional deviation measurements.

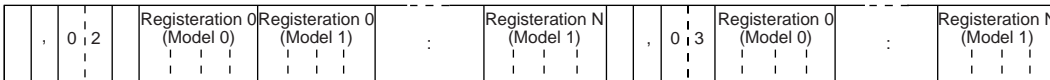

● Codes and number of bytes of output data

1. Result of each measurement program

Output data			Measurement program									
Kind of output	Output code	No. of bytes	Positional deviation measurement	Degree of match inspection	Lead inspection	BGA/SP inspection	Area measurement by binary conversion	Object counting by binary conversion	Object identification by binary conversion	Point measurement	Multiple positions measurement	Multiple degree of match inspections
Degree of match	01	2	○	○								
Coordinate X	02	2	○	○								
Coordinate Y	03	2	○	○								
Coordinate deviation X	04	2	○									
Coordinate deviation Y	05	2	○									
Angle	06	2	○									
Average light level 1	07	2		○								
Number of objects	08	2			○	○		○	○		○	○
Distance	MAX.	09			○							
	MIN.	0A			○							
Lead width	MAX.	0B			○							
	MIN.	0C			○							
Lead length/lead width 2	MAX.	0D			○							
	MIN.	0E										
Total area	10	4				○	○	○	○			
Area of each label	CUR.	11							○			
	MAX.	12				○						
	MIN.	13				○						
X coordinate of gravity center/Distance between gravity centers X	CTR. OF GRAVITY	14							○			
	MAX. DIST.	15				○						
	MIN. DIST.	16				○						
Y coordinate of gravity center/Distance between gravity centers Y	CTR. OF GRAVITY	17							○			
	MAX. DIST.	18				○						
	MIN. DIST.	19				○						

Output data			Measurement program									
Kind of output	Output code	No. of bytes	Positional deviation measurement	Degree of match inspection	Lead inspection	BGA/SP inspection	Area measurement by binary conversion	Object counting by binary conversion	Object identification by binary conversion	Point measurement	Multiple positions measurement	Multiple degree of match inspections
Fillet diameter X	CUR.	1A	2						○			
	MAX.	1B					○					
	MIN.	1C					○					
Fillet diameter Y	CUR.	1D	2						○			
	MAX.	1E					○					
	MIN.	1F					○					
Main axis angle	20	2						○				
Perimeter	21	4						○				
Degree of match	22	2									○	○
Coordinate X	23	2									○	○
Coordinate Y	24	2									○	○
Average light level 1 (total of light level differences)	25	2										○
Average light level 2	28	1								○		
Black and white	29	1								○		
Counting white objects	2A	2								○		
Number of registers	2B	2								○		
Center point X	2C	2							○			
Center point Y	2D	2							○			

2. Results of the distance and angle measurement

Kind of output		Output code	No. of bytes
Distance		30	2
Angle		31	2
Auxiliary 1	Coordinate X	32	4
	Angle	33	
Auxiliary 2	Coordinate Y	34	4
	Y slice length	35	

3. Numeric calculation results

Kind of output	Output code	No. of bytes
MEASURE 0 CAMERA 1	40	4
MEASURE 0 CAMERA 2		
MEASUREMENT 1		
MEASUREMENT 2		
MEASUREMENT 3		
MEASUREMENT 4		
Final calculation		

Chapter 19: Computer Link

A programmable controller (hereafter referred to as a PC) can be connected to the IV-S30, so that the computer link can be used to have the IV-S30 execute measurements.

19-1 Compatible models

The IV-S30 is applicable with the computer links for the following models of Sharp, Mitsubishi, OMRON, and Yokogawa.

Sharp	J-board	[- Host communication port in models Z-311J/312J]
	JW10	[- Communication port in models JW-1324K/1342K/1424K/1442K/1624K/1642K, MMI port]
	JW20H	[- Communication port in the JW-22CU] [- JW-21CM (link module)]
	JW30H	[- Communication port of JW-32CUH/33CUH] [- Communication port in models JW-32CUH1/33CUH1/33CUH2/33CUH3] [- JW-21CM (link module)]
	JW50H/70H/100H	[- Communication port in models JW-70CUH/100CUH] [- JW-10CM (link module)]
Mitsubishi	AnA, AnN (AJ71C24-Sx)	
	A1S (A1SJ71C24)	
	A0J2 (A0J72C24-S1)	
OMRON	C1000H (C500-LK203)	
	C200H RS-232C (C200H-LK201)	
	C200H RS-422 (C200H-LK202)	
	CV1000	[- CV CPU link port] [- CV500-LK201]
	CVM1	[- CV CPU link port] [- CV500-LK201]
Yokogawa	F3SP21-0N	
	F3SP05-0P	CPU for F3SC21-1N
	F3SP08-0P	CPU for F3SC22-1F/2F/1A
	F3SP25-2N	
	F3SP28-3N	
	F3SP35-5N	
	F3SP38-6N	
	F3SP53-4H	
	F3SP58-6H	
	F3SP28-3S	
	F3SP38-6S	
	F3SP53-4S	
	F3SP58-6S	
	F3SP59-6S	

19-2 Data flow

Specify the CCD-TRIG (camera 1) or the PARALLEL (parallel interface) as the source of the MEAS INP I/F (measurement start input) signal.

⇒ See Chapter 17 "Setting the Input/Output Conditions."

The data flow for a measurement start input (CCD trigger/parallel) signal and an object type change command (parallel) is shown below.

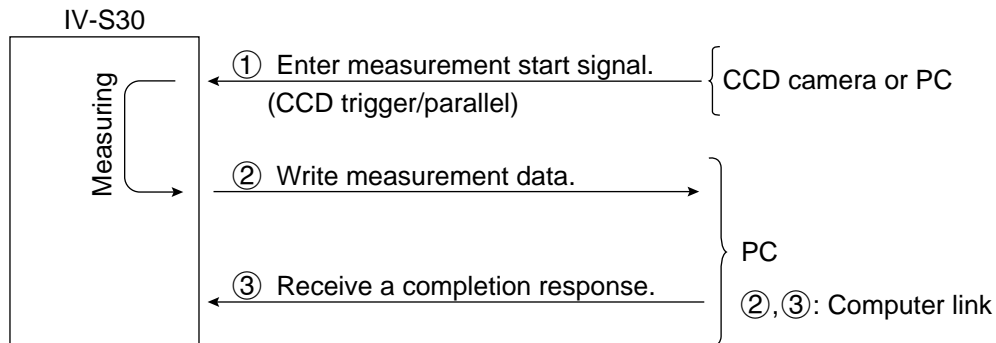

The block of measurement data to be written from the IV-S30 to the PC, in step ②, can be specified on the "OBJ-TYPE I/O" screen.

⇒ See page 17-23.

● When a Sharp PC is connected

The IV-S30 sends write enable command (EWR) to the PC in the following cases.

- When the power is applied to the IV-S30.
- When a Sharp PC is selected.
- When a write mode nonconformity error (code 10_(H)) occurs after a result write command (WRG) is transmitted (when the power is disconnected from the PC).

● When a Mitsubishi, OMRON, or Yokogawa PC is connected

The data in items ② and ③ are divided into packets for transmission.

19-3 Register setting

Use PC register (writing: up to 512 bytes) to provide the IV-S30 with a computer link.

Setting item	Applicable range of address
Write register (up to 512 bytes)	- Sharp: 09000 to 99776
	- Mitsubishi
	- OMRON: DM0000 to DM9999
	- Yokofawa: D00001 to D16384

See page 17-22.

Enter the write start address in item "③WRITE TOP ADRS," on the "COMPUTER LINK" screen, under the "SELECT SYSTEM COND" screen.

Note 1: When a Sharp PC is used, specify an even address for the write start address.

Note 2: When 512 bytes are used for the write register in a Sharp PC, use one of the following write start addresses.

09000, 19000, 29000, 39000, 49000, 59000, 69000, 79000, 89000, 99000

● Write register map

The write register contains the following data.

Sharp	Mitsubishi	OMRON	Yokogawa	Contents
09000	D0000	L DM0000	L D00001	L Termination code (00(H): normal termination, codes other than 00(H) abnormal termination ⇔ See page 20-3.)
09001				H Appended information (error code in an error response) *1
09002	D0001	L DM0001	L D00002	L Object type number (0 to 63: 00 to 3F(H))
09003				H Measurement number when outputting results (0 to 5) *2
09004	D0002	L DM0002	L D00003	L Result output (Y0 to Y15) *3
09005				H
09006	D0003	L DM0003	L D00004	L Measurement function 0 using camera 1
09007				H Measurement function 0 using camera 2 *4
09010	D0004	L DM0004	L D00005	L Measurement function 1
09011				H Measurement function 2 *5
09012	D0005	L DM0005	L D00006	L Measurement function 3
09013				H Measurement function 4
09014	D0006	L DM0006	L D00007	L Output data from measurement 0 camera 1 (block 0)
09015				H :
:	:	L	L	L Output data from measurement 0 camera 2 (block 0)
:	:	H	H	:
:	:	L	L	L Output data from measurement 1 (block 0)
:	:	H	H	:
:	:	L	L	L Output data from measurement 2 (block 0) *6
:	:	H	H	:
:	:	L	L	L Output data from measurement 3 (block 0)
:	:	H	H	:
:	:	L	L	L Output data from measurement 4 (block 0)
:	:	H	H	:
19000	D0256	L DM0256	L D00257	L Assigned block data
19001				H :
.
.
.

*1 to *7 ⇔ See the next page.

The register map shown above is established when the write start addresses have been set as shown below.

Manufacturer	Sharp	Mitsubishi	OMRON	Yokogawa
Write start address	09000	D0000	DM0000	D00001

- *1 When the termination code is 08_(H) (received an error response), the error code is contained in the appended information. (Example: 0A_(H) on a Sharp PC = parity error)
- *2 Measurement number when outputting the results
 00_(H) = Measurement 0, Camera 1, 01_(H) = Measurement 0, Camera 2, 02_(H) = Measurement 1, 03_(H) = Measurement 2, 04_(H) = Measurement 3, 05_(H) = Measurement 4
- *3 Result output (Y0 to Y15)

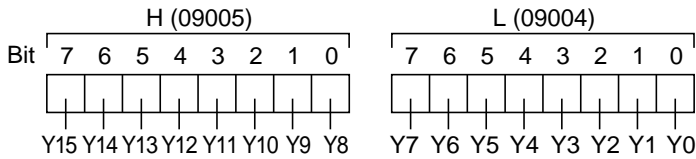

- *4 Measurement program for measurement 0
 00_(H) = none, 01_(H) = positional deviation measurement
- *5 Measurement programs for measurements 1 to 4
 00_(H) = none, 01_(H) = positional deviation measurement, 02_(H) = degree of match inspection, 03_(H) = lead inspection, 04_(H) = BGA/CSP inspection, 05_(H) = area measurement by binary conversion, 06_(H) = object counting by binary conversion, 07_(H) = object identification by binary conversion, 08_(H) = point measurement, 09_(H) = multiple position measurement, 0A_(H) = multiple degree of match inspections
- *6 Output data from measurements 0 to 4 (block 0)
 The data output will vary according to whether "ANY" or "BLOCK-ASSIGN" was selected on the SERIAL OUTPUT item. ⇨ Pages 17-23 to 17-27.

● **When a block is specified**

- The measurement data from measurement numbers 0 to 4 in block 0 is output. (Max. 496 bytes).
- Measurement numbers that have not been specified will not output any data. (The space will be filled by the next item. Max. 500 bytes.)
- See pages 19-6 to 19-16, for details about the measurement data in block 0.

● **When "ANY" is selected for the output**

⇨ See page 19-16.

*7 Assigned block data

When the SERIAL OUTPUT item is set to "BLOCK-ASSIGN," the IV-S30 will output the measurement result data in the specified block number. When the SERIAL OUTPUT item is set to "ANY," the nature of the output will depend on the output settings.

⇨ For details about how to specify measurement output, see pages 17-23 and 17-25.

- No data is output if block 0 (00) is specified.

⇨ For details about the measurement data block, see pages 19-5 to 19-16.

- The top address where the specified block of data is written will be an address made by adding 512 bytes to the top address for writing results.

	Sharp	Mitsubishi	OMRON	Yokogawa	Contents	
Top address for writing results	09000	D0000	L	DM0000	L	Termination code
	09001		H		H	H
	
	
	
	
	
	
	
	
Top address for writing results + 512 bytes	19000	D0256	L	DM0256	L	Assigned block data
	19001		H		H	H
	
	
	
	
	
	

19-4 Measurement data blocks

[1] Number of blocks

The measurement functions vary in the number of measurement data blocks they use.

Measurement function		Blocks	Page
Measurement program	Positional deviation measurement	0, 1	19-6
	Degree of match inspection	0, 1	19-7
	Lead inspection	0, 1	
	BGA/CSP inspection	0, 1	19-8
	Area measurement by binary conversion	0	
	Object counting by binary conversion	0	
	Object identification (labeling) by binary conversion	0	
	Point measurement	0, 1 (when binary processing is selected) 0 to 4 (when average density is selected)0 to 4	19-12
	Multiple positions measurement	0 to 4	19-14
	Mutiple degree of match inspections	0 to 4	
	Distance/angle measurement		58
Numerical calculation		51	19-16

(2) Degree of match inspection

Block	Item		Sign (+/-)	No. of bytes	Decimal point (digit)	
0	Registration No. 0	Degree of match (positioning)	1st point	Provided	2	None
			2nd point	Provided	2	None
	Registration No. 1 to 15	Registration No. 1 to 15 contain the same data as the registration No. 0.				

Block	Item		Sign (+/-)	No. of bytes	Decimal point (digit)		
1	Registration No. 0	Coordinate	1st point	X	None	2	1
				Y	None	2	1
			2nd point	X	None	2	1
				Y	None	2	1
		Average light level	1st point	None	2	1	
			2nd point	None	2	1	
	Registration No. 1 to 15	Registration No. 1 to 15 contain the same data as the registration No. 0.					

(3) Lead inspection

Block	Item		Sign (+/-)	No. of bytes	Decimal point (digit)
0	Registration No. 0	Number of objects	None	2	None
	Registration No. 1 to 15	Registration No. 1 to 15 contain the same data as the registration No. 0.			

Block	Item		Sign (+/-)	No. of bytes	Decimal point (digit)	
1	Registration No. 0	Distance	Maximum	None	2	1
			Minimum	None	2	1
			NG No.	None	2	None
			No. of NG	None	2	None
		Lead width	Maximum	None	2	1
			Minimum	None	2	1
			NG No.	None	2	None
			No. of NG	None	2	None
		Lead length	Maximum	None	2	1
			Minimum	None	2	1
			NG No.	None	2	None
			No. of NG	None	2	None
	Registration No. 1 to 15	Registration No. 1 to 15 contain the same data as the registration No. 0.				

(4) BGA/CSP inspection

Block	Item		Sign (+/-)	No. of bytes	Decimal point (digit)
0	Registration No. 0	No. of labels	None	2	None
		Total area	None	4	None
	Registration No. 1 to 3	Registration No. 1 to 3 contain the same data as the registration No. 0.			

Block	Item		Sign (+/-)	No. of bytes	Decimal point (digit)	
1	Registration No. 0	Area of each label	Maximum	None	4	None
			Minimum	None	4	None
		Distance between gravity centers X	Maximum	None	2	1
			Minimum	None	2	1
		Distance between gravity centers Y	Maximum	None	2	1
			Minimum	None	2	1
		Fillet dia. X	Maximum	None	2	None
			Minimum	None	2	None
		Fillet dia. Y	Maximum	None	2	None
			Minimum	None	2	None
	Registration No. 1 to 3	Registration No. 1 to 3 contain the same data as the registration No. 0.				

(5) Area measurement by binary conversion

Block	Item		Sign (+/-)	No. of bytes	Decimal point (digit)
0	Registration No. 0	Area	None	4	None
	Registration No. 1 to 15	Registration No. 1 to 15 contain the same data as the registration No. 0.			

(6) Counting quantities by binary conversion

Block	Item		Sign (+/-)	No. of bytes	Decimal point (digit)
0	Registration No. 0	No. of labels	None	2	None
		Total area	None	4	None
	Registration No. 1 to 3	Registration No. 1 to 3 contain the same data as the registration No. 0.			

(7) Object identification by binary conversion

Block	Item		Sign (+/0)	No. of bytes	Decimal point (digit)	
0	Registration No. 0	No. of labels	None	2	None	
		Total area	None	4	None	
	Registration No. 1 to 3	Registration No. 1 to 3 contain the same data as the registration No. 0.				
10	Registration No. 0	Label 0	Area of each label	None	4	None
			X coordinate of gravity center	None	2	1
			Y coordinate of gravity center	None	2	1
			Spindle axis angle	Provided	2	1
			Fillet diameter X	None	2	None
			Fillet diameter Y	None	2	None
			Peripheral	None	4	1
			Label 1 to 31		Label No. 0 to 127 contain the same data as the label No. 0.	
11	Label 32 to 63					
12	Label 64 to 95					
13	Label 96 to 127					
20	Registration No. 1	Label 0 to 31		Label No. 0 to 127 contain the same data as the label No. 0 of block 10.		
21		Label 32 to 63				
22		Label 64 to 95				
23		Label 96 to 127				
30	Registration No. 2	Label 0 to 31		Label No. 0 to 127 contain the same data as the label No. 0 of block 10.		
31		Label 32 to 63				
32		Label 64 to 95				
33		Label 96 to 127				
40	Registration No. 3	Label 0 to 31		Label No. 0 to 127 contain the same data as the label No. 0 of block 10.		
41		Label 32 to 63				
42		Label 64 to 95				
43		Label 96 to 127				



To the next page

Block	Item		Sign (+/0)	No. of bytes	Decimal point (digit)		
60	Registration No. 0 label unit area	Label 0	None	4	None		
		to		to			
		Label 127		4			
61	Registration No. 1 label unit area	Label 0 to 127		Each label contains the same data as block 60.			
62	Registration No. 2 label unit area	Label 0 to 127					
63	Registration No. 3 label unit area	Label 0 to 127					
64	Registration No. 0 gravity center	Label 0	X	None	2	1	
			Y	None	2	1	
		to		to			
		Label 127	X	None	2	1	
			Y	None	2	1	
65	Registration No. 1 gravity center	Label 0 to 127		Each label contains the same data as block 64.			
66	Registration No. 2 gravity center	Label 0 to 127					
66	Registration No. 3 gravity center	Label 0 to 127					
68	Registration No. 0 spindle angle	Label 0 to 127	1B	Provided	2	1	
	Registration No. 1 spindle angle	Label 0 to 127	1B	Provided	2	1	
69	Registration No. 2 spindle angle	Label 0 to 127	1B	Provided	2	1	
	Registration No. 3 spindle angle	Label 0 to 127	1B	Provided	2	1	
70	Registration No.0 fillet dia.	Label 0	X	None	2	None	
			Y	None	2	None	
		to		to			
		Label 127	X	None	2	None	
			Y	None	2	None	
71	Registration No.1 fillet dia.	Label 0 to 127		Each label contains the same data as block 70.			
72	Registration No.2 fillet dia.	Label 0 to 127					
73	Registration No.3 fillet dia.	Label 0 to 127					
74	Registration No.0 peripheral length	Label 0 to 127		None	4	1	
75	Registration No.1 peripheral length	Label 0 to 127		Each label contains the same data as block 74.			
76	Registration No.2 peripheral length	Label 0 to 127					
77	Registration No.3 peripheral length	Label 0 to 127					
78	Registration No.0 center point	Label 0	X	None	2	None	
			Y	None	2	None	
		to		to			
		Label 127	X	None	2	None	
			Y	None	2	None	
79	Registration No.1 center point	Label 0 to 127		Each label contains the same data as block 78.			
80	Registration No.2 center point	Label 0 to 127					
81	Registration No.3 center point	Label 0 to 127					

Block	Item		Sign (+/0)	No. of bytes	Decimal point (digit)	
82	Registration No. 0	Label 0	Area of each label	None	4	None
			X coordinate of gravity center	None	2	1
			Y coordinate of gravity center	None	2	1
			Spindle axis angle	Provided	2	1
			Fillet diameter X	None	2	None
			Fillet diameter Y	None	2	None
			Peripheral	None	4	1
			Center point X	None	2	None
			Center point Y	None	2	None
83	Label 1 to 31		Label No. 0 to 127 contains the same data as label No. 0.			
84	Label 32 to 63					
85	Label 64 to 95					
86	Label 96 to 127					
86	Registration No. 1	Label 0 to 31		Label No. 0 to 127 contains the same data as label No. 0 in block 82.		
87		Label 32 to 63				
88		Label 64 to 95				
89		Label 96 to 127				
90	Registration No. 2	Label 0 to 31		Label No. 0 to 127 contains the same data as label No. 0 in block 82.		
91		Label 32 to 63				
92		Label 64 to 95				
93		Label 96 to 127				
94	Registration No. 3	Label 0 to 31		Label No. 0 to 127 contains the same data as label No. 0 in block 82.		
95		Label 32 to 63				
96		Label 64 to 95				
97		Label 96 to 127				

(8) Point measurement
1. In the binary mode

Block	Item			Sign (+/0)	No. of bytes	Decimal point (digit)
0	Registration No. 0 to 15	Black and white information	0 = black 1 = white	None	2	None
	Registration No. 16 to 31	Black and white information	0 = black 1 = white	None	2	None
	:	:			:	
	Registration No. 240 to 255	Black and white information	0 = black 1 = white	None	2	None
1	Registration No. 0 to 7	Evaluation information	0 = NG 1 = OK	None	1	None
		Black and white information	0 = black 1 = white	None	1	None
	Registration No. 8 to 15	Evaluation information	0 = NG 1 = OK	None	1	None
		Black and white information	0 = black 1 = white	None	1	None
	:	:			:	
	Registration No. 248 to 255	Evaluation information	0 = NG 1 = OK	None	1	None
Black and white information		0 = black 1 = white	None	1	None	

Note: If a point number has not been used yet, the data for the next registered number will be brought forward.

- When an item does not have data in 2 byte units, the data will be incremented (scrolled up) in units of two bytes.

[Ex.] When "NO" data is registered at memory locations 16 to 31, the data at memory locations 32 and on are moved down to locations 16 and on.

● **Data example: Only point No. 0 to 7 in block 0**

	Data	Contents
F A ┌───┐ White/ black information	F A ^(H)	Point No. — P8 P7 P6 P5 P4 P3 P2 P1 White/black — White White White White White Black White Black 0: black, 1: white
		F A 1 1 1 1 1 0 1 0

2. In the average light level mode

Block	Item		Data code	Sign (+/0)	No. of bytes	Decimal point (digit)
0	Registration No. 0	Average density	20	None	2	None
	Registration No. 1 to 31	Registration No. 1 to 31 contain the same data as registration No. 0.				
1	Registration No. 32	Average density	20	None	2	None
	Registration No. 33 to 63	Registration No. 33 to 63 contain the same data as registration No. 0.				
2	Registration No. 64	Average density	20	None	2	None
	Registration No. 65 to 95	Registration No. 65 to 95 contain the same data as registration No. 0.				
3	Registration No. 96	Average density	20	None	2	None
	Registration No. 97 to 127	Registration No. 97 to 127 contain the same data as registration No. 0.				
4	Registration No. 0 to 15	Evaluation information	0=NG 1=OK	None	2	None
	Registration No. 16 to 31	Evaluation information	0=NG 1=OK	None	2	None
	:	:	:			
	Registration No. 112 to 127	Evaluation information	0=NG 1=OK	None	2	None

Note: If a point number has not been used yet, the data for the next registered number will be brought forward.

(9) Multiple position measurement

Block	Item		Sign (+/0)	No. of bytes	Decimal point (digit)
0	Registration No. 0	Number of objects detected	None	2	None
	Registration No.1 to 3	Registration No. 1 to 3 contain the same data as registration No. 0.			

Block	Item		Sign (+/0)	No. of bytes	Decimal point (digit)	
1	Registration No. 0	Detection 0	Degree of match	None	2	None
			Coordinate X	None	2	None
			Coordinate Y	None	2	None
		Average light level 1 (total of light level difference)*		None	2	None
		Detection 1 to 127	Details about detected objects 1 to 127 are the same as for object 0.			
2	Registration No. 1	Details about detected objects 2 to 4 are the same as for object 1(register No. 0).				
3	Registration No. 2					
4	Registration No. 3					

(10) Multiple degree of mach inspections

Block	Item		Sign (+/0)	No. of bytes	Decimal point (digit)
0	Registration No. 0	Number of objects detected	None	2	None
	Registration No.1 to 3	Registration No. 1 to 3 contain the same data as registration No. 0.			

Block	Item		Sign (+/0)	No. of bytes	Decimal point (digit)	
1	Registration No. 0	Detection 0	Degree of match	None	2	None
			Coordinate X	None	2	None
			Coordinate Y	None	2	None
		Average light level 1 (total of light level difference)*		None	2	None
		Detection 1 to 127	Details about detected objects 1 to 127 are the same as for object 0.			
2	Registration No. 1	Details about detected objects 2 to 4 are the same as for object 1(register No. 0).				
3	Registration No. 2					
4	Registration No. 3					

* When light level matching is executed, the total difference in light level is output.

(11) Distance and angle measurement

Block	Item		Data code	Sign (+/0)	No. of bytes	Decimal point (digit)	
58	Measurement 0 Camera1	Registration No. 0	Distance	30	Provided	2	1
			Angle	31	Provided	2	1
			Auxiliary 1 (coordinate X /angle)	32/33	Provided	4	Float
			Auxiliary 2 (coordinate Y /Y slice length)	34/35	Provided	4	Float
		Registration No. 1 to 15	Registration No. 1 to 15 contain the same data as registration No. 0.				
	Measurement 0 Camera 2	Registration No. 0 to 15	Registration No. 0 to 15 contain the same data as measurement 0, camera 1.				
	Measurement 1	Registration No. 0 to 15	Registration No. 0 to 15 contain the same data as measurement 0, camera 1.				
	Measurement 2	Registration No. 0 to 15	Registration No. 0 to 15 contain the same data as measurement 0, camera 1.				
Measurement 3	Registration No. 0 to 15	Registration No. 0 to 15 contain the same data as measurement 0, camera 1.					
Measurement 4	Registration No. 0 to 15	Registration No. 0 to 15 contain the same data as measurement 0, camera 1.					

Note: Blank items are omitted and the remaining lines are moved up.

(12) Numerical calculation

Block	Item		Data code	Sign (+/0)	No. of bytes	Decimal point (digit)	
51	Measurement 0 Camera 1	Registration No. 0	Calculation result	40	Provided	4	2
		Registration No. 1 to 15	Registration No. 1 to 15 contain the same data as registration No. 0.				
	Measurement 0 Camera 2	Registration No. 0	Calculation result	41	Provided	4	2
		Registration No. 1 to 15	Registration No. 1 to 15 contain the same data as registration No. 0.				
	Measurement 1	Registration No. 0	Calculation result	42	Provided	4	2
		Registration No. 1 to 15	Registration No. 1 to 15 contain the same data as registration No. 0.				
	Measurement 2	Registration No. 0	Calculation result	43	Provided	4	2
		Registration No. 1 to 15	Registration No. 1 to 15 contain the same data as registration No. 0.				
	Measurement 3	Registration No. 0	Calculation result	44	Provided	4	2
		Registration No. 1 to 15	Registration No. 1 to 15 contain the same data as registration No. 0.				
	Measurement 4	Registration No. 0	Calculation result	45	Provided	4	2
		Registration No. 1 to 15	Registration No. 1 to 15 contain the same data as registration No. 0.				
	Final measurement	Registration No. 0	Calculation result	48	Provided	4	2
		Registration No. 1 to 15	Registration No. 1 to 15 contain the same data as registration No. 0.				

Note: Blank items are omitted and the remaining lines are moved up.

19-5 Specifications for any output data

When the serial output is set to "ANY" (page 17-26), the measurement results for the output data that is set to "YES" (page 17-26) will be written into the write register map "output data from measurements 0 to 4 (block 0): *6 on page 19-3," in output-code order.

Measurement	Output	Registration
Measurement 0 Camera1	Output code 01 (degree of match)	Degree of match for register number 0
		Degree of match for register number 1
		to
	Output code 02 (coordinate X)	Degree of match for register number 7
		Coordinate X for register number 0
		Coordinate X for register number 1
	to	to
	Output code 40 (numeric calculation)	Coordinate X for register number 7
		Numeric calculation result for register number 0
		Numeric calculation result for register number 1
to	to	
		Numeric calculation result for register number 15
Measurement 0 Camera2	The details of the output codes and register numbers are the same as for "MEASUREMENT 0, CAMERA1"	
Measurement 1	The details of the output codes and register numbers are the same as for "MEASUREMENT 0, CAMERA1"	
Measurement 2	The details of the output codes and register numbers are the same as for "MEASUREMENT 0, CAMERA1"	
Measurement 3	The details of the output codes and register numbers are the same as for "MEASUREMENT 0, CAMERA1"	
Measurement 4	The details of the output codes and register numbers are the same as for "MEASUREMENT 0, CAMERA1"	

- Data that are set to "NO" output do not output any signal (scrolled up).
- Set the next page for details about the output codes (type, number of bytes, related measurement programs)

Ex.: Output data examples when the "SERIAL OUTPUT" column is set to "YES."

SHARP	Mitsubishi	OMRON	Output data	Details	Measurement item when SERIAL OUTPUT is set to "YES"									
09014	D0006	L	DM0006	L 00	0100 _(H) : 00 = fixed value 01 = output code (degree of match)	Register 0 (degree of match, coordinate X, coordinate Y deviation) for measurement 1 (position deviation measurement)								
09015							H 01							
09016	D0007	L	DM0007	L 78										
09017							H 26	2678 _(H) : 9848 _(D) = 98.48%						
09020	D0008	L	DM0008	L 00			0200 _(H) : 00 = fixed value 02 = output code (X coordinate)	Register 0 (degree of match, coordinate X, coordinate Y deviation) for measurement 1 (position deviation measurement)						
09021									H 02					
09022	D0009	L	DM0009	L 92					0992 _(H) : 2450 _(D) = 245.0 (coordinate value)	Register 0 (degree of match, coordinate X, coordinate Y deviation) for measurement 1 (position deviation measurement)				
09023											H 09			
09024	D0010	L	DM0010	L 00							0500 _(H) : 00 = fixed value, 05 = output code (coordinate Y deviation)	Register 0 (degree of match, coordinate X, coordinate Y deviation) for measurement 1 (position deviation measurement)		
09025													H 05	
09026	D00011	L	DM00011	L FA	00FA _(H) : 250 _(D) = 25.0 (deviation value)	Register 0 (degree of match, coordinate X, coordinate Y deviation) for measurement 1 (position deviation measurement)								
09027													H 00	
09030	D00012	L	DM00012	L 01									0100 _(H) : 00 = fixed value 01 = output code (degree of match)	Register 0 (degree of match) for measurement 3 (degree of match inspection)
09031														
09032	D00013	L	DM00013	L 28			2628 _(H) : 9752 _(D) = 97.52%	Register 0 (degree of match) for measurement 3 (degree of match inspection)						
09033														

● Codes and number of bytes of output data
1. Result of each measurement program

Output data			Measurement program									
Kind of output	Output code	No. of bytes	Positional deviation measurement	Degree of match inspection	Lead inspection	BGA/SP inspection	Area measurement by binary conversion	Object counting by binary conversion	Object identification by binary conversion	Point measurement	Multiple positions measurement	Multiple degree of match inspections
Degree of match	01	2	○	○								
Coordinate X	02	2	○	○								
Coordinate Y	03	2	○	○								
Coordinate deviation X	04	2	○									
Coordinate deviation Y	05	2	○									
Angle	06	2	○									
Average light level 1	07	2		○								
Number of object	08	2			○	○		○	○		○	○
Distance	MAX.	09			○							
	MIN.	0A			○							
Lead width	MAX.	0B			○							
	MIN.	0C			○							
Lead length/lead width 2	MAX.	0D			○							
	MIN.	0E										
Total area		10				○	○	○	○			
Area of each label	CUR.	11							○			
	MAX.	12				○						
	MIN.	13				○						
X coordinate of gravity center/Distance between gravity centers X	CTR. OF GRAVITY	14							○			
	MAX. DIST.	15				○						
	MIN. DIST.	16				○						
Y coordinate of gravity center/Distance between gravity centers Y	CTR. OF GRAVITY	17							○			
	MAX. DIST.	18				○						
	MIN. DIST.	19				○						
Fillet diameter X	CUR.	1A							○			
	MAX.	1B				○						
	MIN.	1C				○						
Fillet diameter Y	CUR.	1D							○			
	MAX.	1E				○						
	MIN.	1F				○						

Output data			Measurement program									
Kind of output	Output code	No. of bytes	Positional deviation measurement	Degree of match inspection	Lead inspection	BGA/SP inspection	Area measurement by binary conversion	Object counting by binary conversion	Object identification by binary conversion	Point measurement	Multiple positions measurement	Multiple degree of match inspections
Main axis angle	20	2							○			
Perimeter	21	4							○			
Degree of match	22	2									○	○
Coordinate X	23	2									○	○
Coordinate Y	24	2									○	○
Average light level 1 (total of light level differences)	25	2										○
Average light level 2	28	1								○		
Black and white	29	1								○		
Counting white objects	2A	2								○		
Number of registers	2B	2								○		
Center point X	2C	2							○			
Center point Y	2D	2							○			

2. Results of distance and angle measurement

Kind of output		Output code	No. of bytes
Distance		30	2
Angle		31	2
Auxiliary 1	Coordinate X	32	4
	Angle	33	
Auxiliary 2	Coordinate X	34	4
	Y slice length	35	

3. Results of numerical calculations

Kind of output	Output code	No. of bytes
MEASURE 0 CAMERA 1	40	4
MEASURE 0 CAMERA 2		
MEASUREMENT 1		
MEASUREMENT 2		
MEASUREMENT 3		
MEASUREMENT 4		
Final calculation		

19-6 Interface

The interface between the IV-S30 and a programmable controller from each manufacturer is described below.

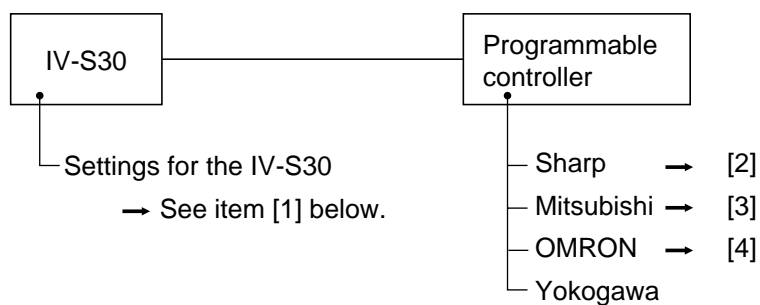

[1] Setting items for the IV-S30

Item	Setting details
Communication speed(k bit/sec)	115.2, 57.6, 38.4, 19.2, 9.6, 4.8, 2.4
Data length (bit)	7, 8
Parity	None, odd, even
Stop bit	1, 2
Error check	Checksum
Station No.	Sharp: 00 to 37 ⁽⁸⁾ Mitsubishi: 00 to 31 OMRON: 00 to 31 Yokogawa: 01 to 32
Write address (up to 512 bytes)	Sharp: 09000 to 99776 Mitsubishi: D000 to D9999 OMRON: DM0000 to DM9999 Yokogawa: D00001 to D16384

[2] Connection with a Sharp PC

● Applicable models

1. Control module: JW-22CU (can be used with ROM version 2.2 or later)
JW-70CUH/100CUH, JW-32CUH/33CUH
JW-32CUH1/33CUH1/33CUH2/33CUH3
2. Basic module: JW-1324K/1342K/1424K/1442K/1624K/1642K
3. CPU board: Z-311J/312J
4. Link module: JW-21CM, JW-10CM
5. Communication board: Z-331J/332J

(1) Module setting

① When a JW-22CU or a JW-70CUH/100CUH and Z-311J/312J are used

Store the communication port conditions in system memory addresses #236 and #237. Bits D₀ to D₅ are stored in memory address #236.

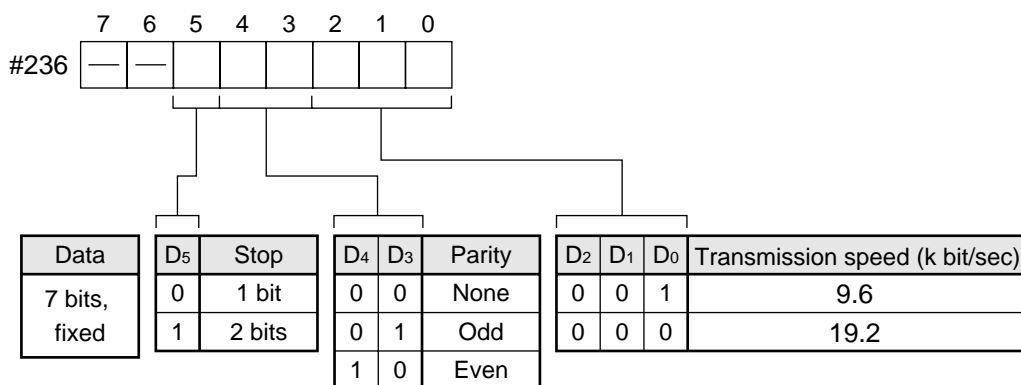

#237 (001 to 037₍₈₎)

Enter the station No. for the current station.

In the initial state, addresses #236 and #237 are set to 000.

② When a JW-32CUH/33CUH or a JW-32CUH/33CUH1/33CUH2/33CUH3 is used

1. When communication port 1 (PG/COMM1 port) is used

Store the communication conditions in system memory addresses #234 and #235. Set bits D₀ to D₅ in memory address #234. Only an RS-422 cable can be connected to the PG/COMM1 port.

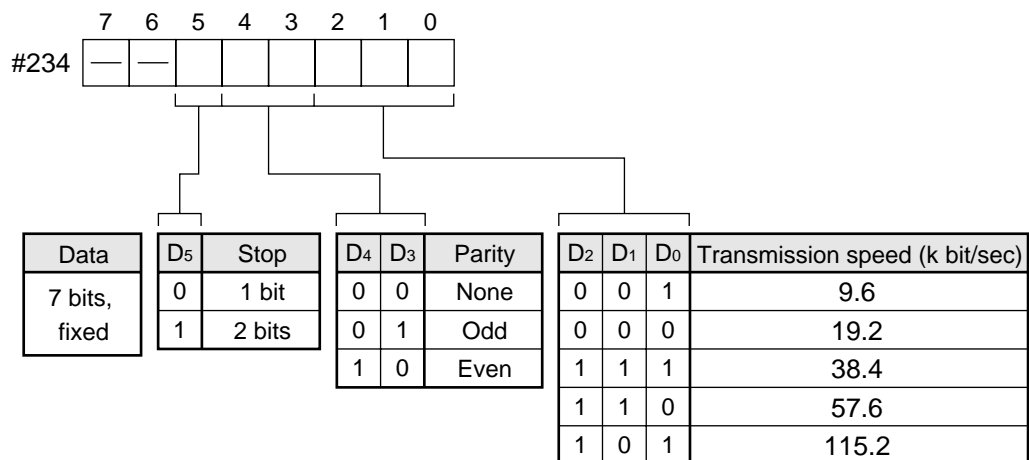

* Applicable only to the JW-32CUH1/33CUH1/33CUH2/33CUH3

#235 (001 to 037₍₈₎)

Enter the station No. for the current station.

In the initial state, addresses #234 and #235 are set to 000.

2. When communication port 2 (PG/COMM2 port) is used.

Store the communication conditions in system memory addresses #222, #236 and #237. Either RS-232 or RS-422 cable can be connected to the PG/COMM2 port.

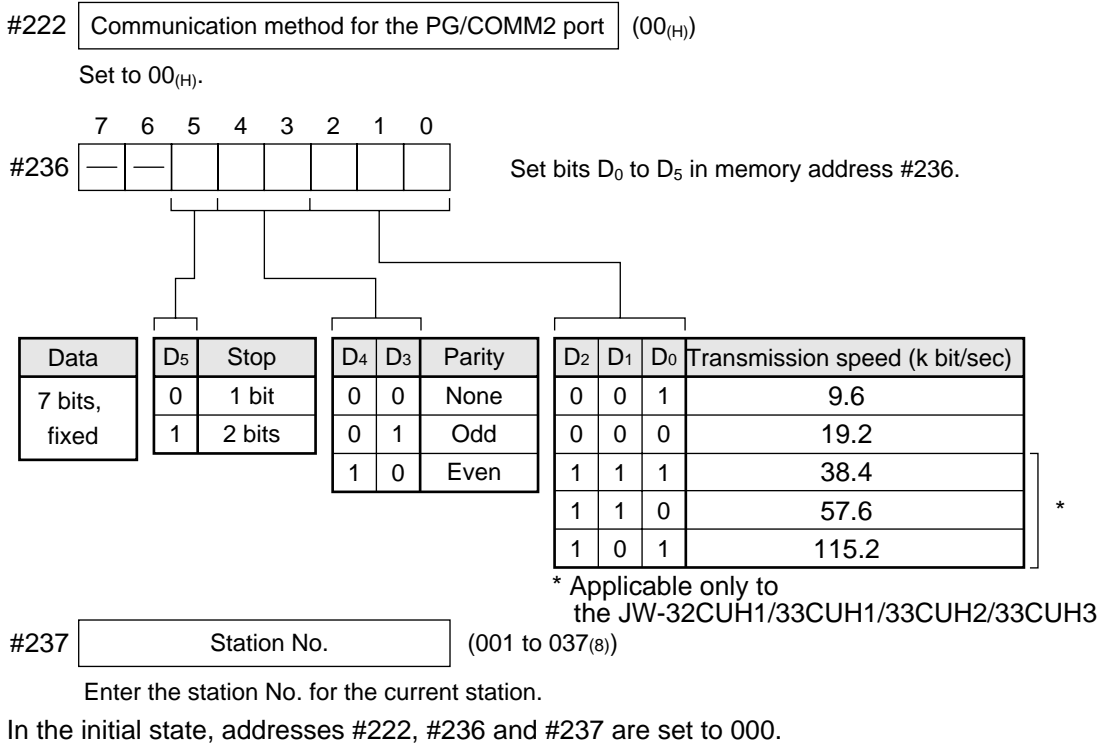

③ **When a JW-1324K/1342K/1424K/1442K/1624K/1642K is used**

1. When the communication port is used

Store the communication conditions in system memory addresses #234, #236 and #237.

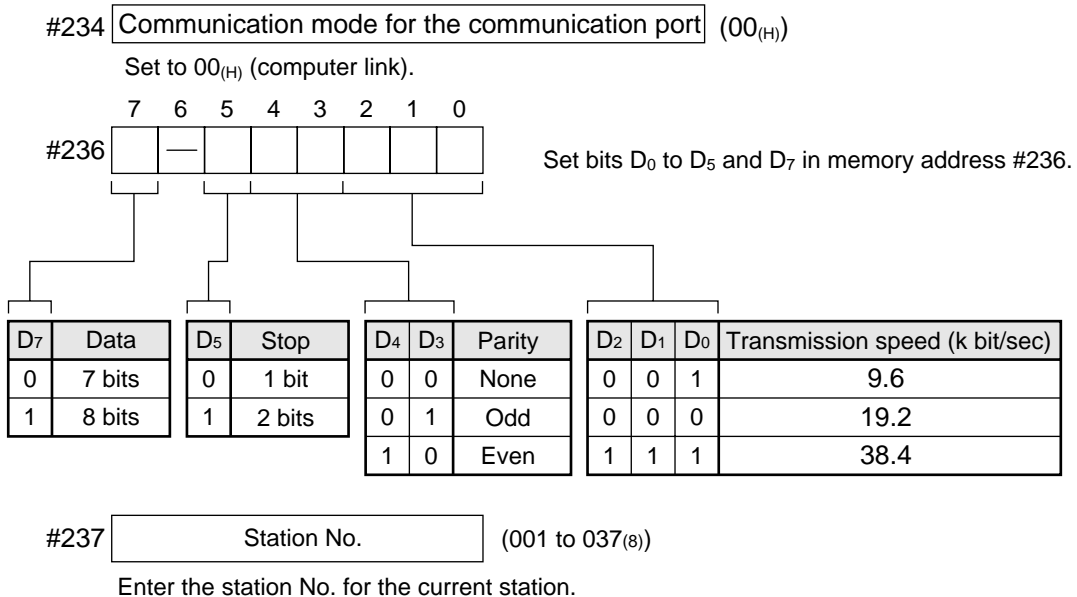

2. When the MMI port is used

Store the communication conditions in system memory addresses #226 and #227. Set bits D₀ to D₅ in memory address #226.

Use of the MMI port ensures a one-to-one connection between the IV-S30 and the JW10.

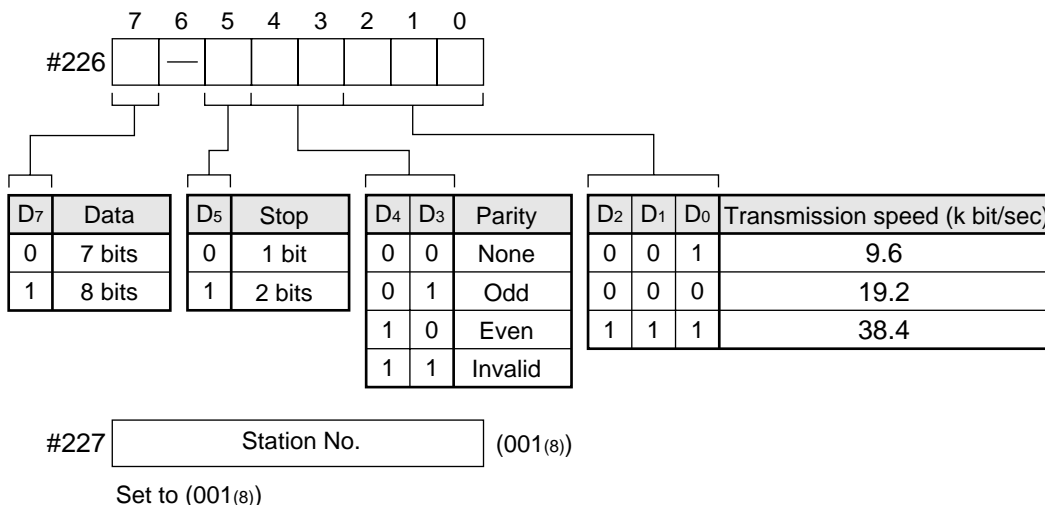

In the initial state, addresses #226 and #227 are set to 000.

④ When a JW-21CM or JW-10CM is used

Set the switches (SW0 to SW4 and SW7) on the module as shown below.

Switch	Setting	Set value
SW0	Command mode	4
SW1	Station No. (upper bit)	01 to 37 ₍₈₎
SW2	Station No. (lower bit)	
SW3-1	Invalid	OFF
SW3-2	4-wire system	ON
SW3-3	Invalid	OFF
SW3-4	Odd parity (OFF), even parity (ON)	OFF or ON
SW4	Transmission speed (k bit/sec)	19.2 (0) or 9.6 (1) 0 or 1
SW7	With a termination resistance	ON

⑤ When a Z-331J/332J is used

Set the switches (SW0 to SW4 and SW7) on the board as shown below.

Switch	Setting	Set value
SW0	Computer link	4
SW1	Station No. (upper bit)	01 to 37 ₍₈₎
SW2	Station No. (lower bit)	
SW3-1	Invalid	OFF
SW3-2	Only the 2-wire system can be used.	OFF
SW3-3	Invalid	OFF
SW3-4	Odd parity (OFF), even parity (ON)	OFF or ON
SW4	Transmission speed (k bit/sec)	19.2 (0), 9.6 (1) 0 or 1
SW7	With a termination resistance	ON

(2) Using memory

To allow the memory to be used by the IV-S30, enter a result write start address in the following range.

Memory	Range (address)
Register	09000 to 99776

(3) Connections

① When a JW-22CU or JW-70CUH/100CUH is used

1. Communication through the RS-232C port

Communication connector on the IV-S30 (RS232C/RS422)

Pin No.	Signal name
Connector shield	FG
3	SD
2	RD
5	SG

JW-22CU
JW-70CUH/100CUH
(Communication port)

Pin No.	Signal name
1	FG
3	RD
2	SD
7	SG
12	Short-circuit terminal
14	

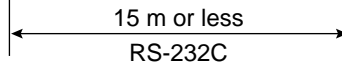

2. Communication through the RS-422 port (4-wire system)

Communication connector on the IV-S30 (RS232C/RS422)

Pin No.	Signal name
4	TA
7	TB
8	RA
9	RB
Connector shield	FG

JW-22CU
JW-70CUH/100CUH
(Communication port)

Pin No.	Signal name
12	RD (+)
13	RD (-)
10	SD (+)
11	SD (-)
1	FG

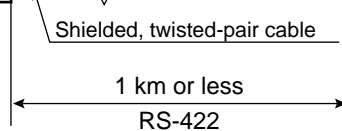

② When a JW-32CUH/33CUH or JW-32CUH1/33CUH1/33CUH2/33CUH3 is used

1. Communication through the RS-232C port

Communication connector on the IV-S30 (RS232C/RS422)

Pin No.	Signal name
Connector shield	FG
3	SD
2	RD
5	SG

JW-32CUH/33CUH
JW-32CUH1/33CUH1
/33CUH2/33CUH3
(PG/COMM2 port)

Pin No.	Signal name
1	FG
4	RD
2	SD
7	SG

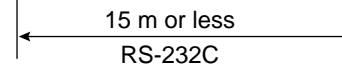

2. Communication through the RS-422 port (4-wire system)

Communication connector on the IV-S30 (RS232C/RS422)

Pin No.	Signal name
4	TA
7	TB
8	RA
9	RB
Connector shield	FG

JW-32CUH/33CUH
JW-32CUH1/33CUH1
/33CUH2/33CUH3

Pin No.	Signal name
9	RD (+)
10	RD (-)
3	SD (+)
11	SD (-)
1	FG

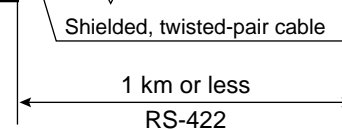

③ When a JW-1324K/1342K/1424K/1442K/1624K/1642K is used

The IV-S30 can only be connected to the RS-422 port. When the communication port is used, provide a 2-wire RS-422 system. When the MMI port is used, provide a 4-wire RS-422 system.

1. When the communication port is used

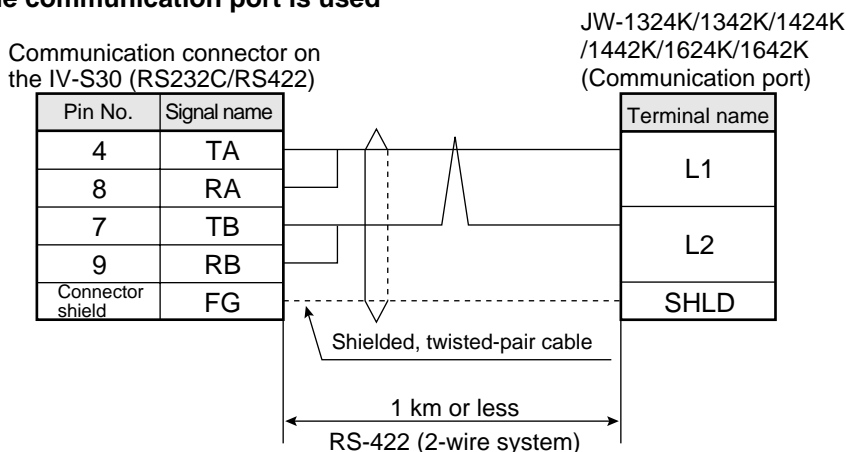

2. When the MMI port is used

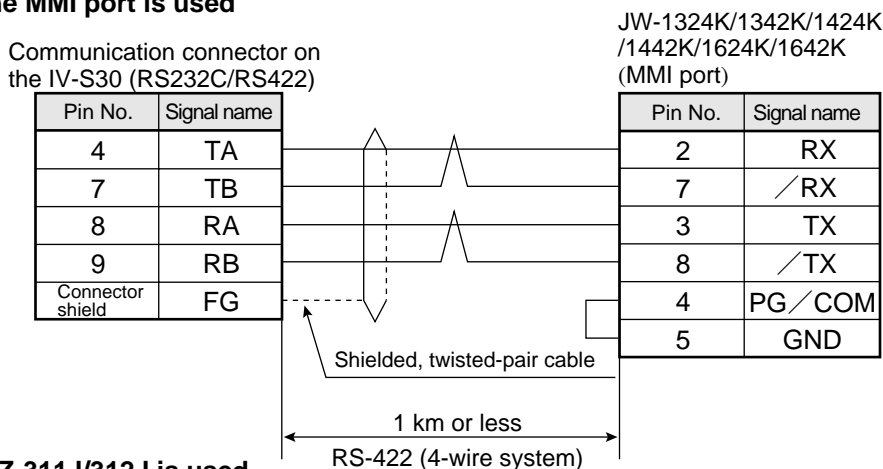

④ When a Z-311J/312J is used

1. Communication through the RS-232C port

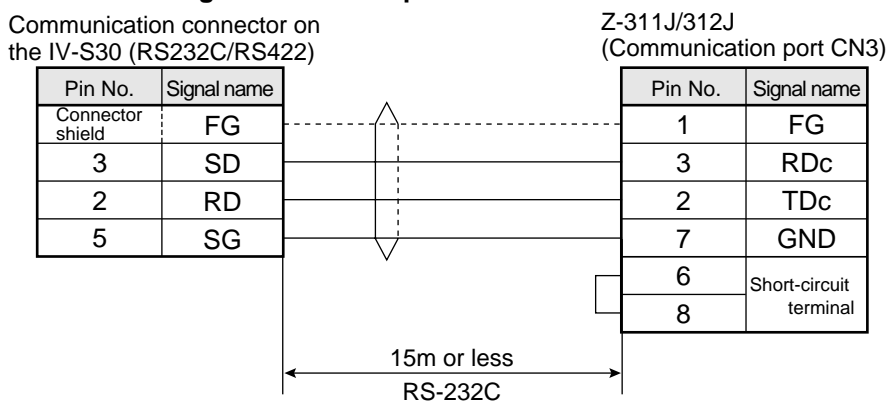

2. Communication through the RS-422 port (4-wire system)

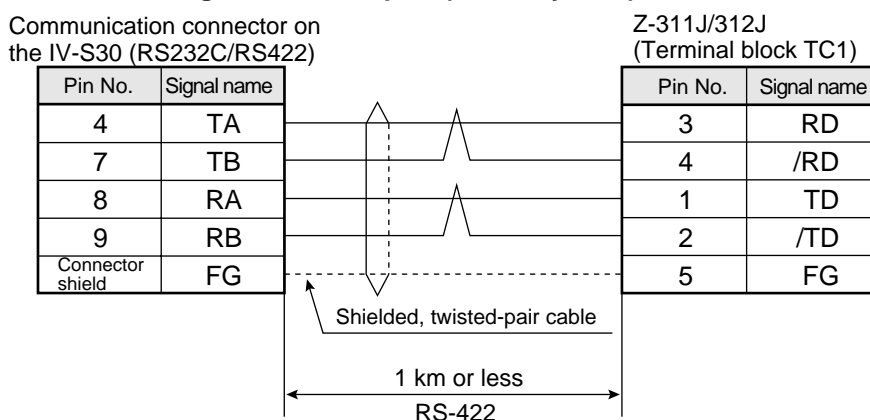

⑤ When a JW-21CM or JW-10CM is used
 - Communication through the RS-422 port (4-wire system)

Communication connector on the IV-S30 (RS232C/RS422)

JW-21CM
 JW-10CM

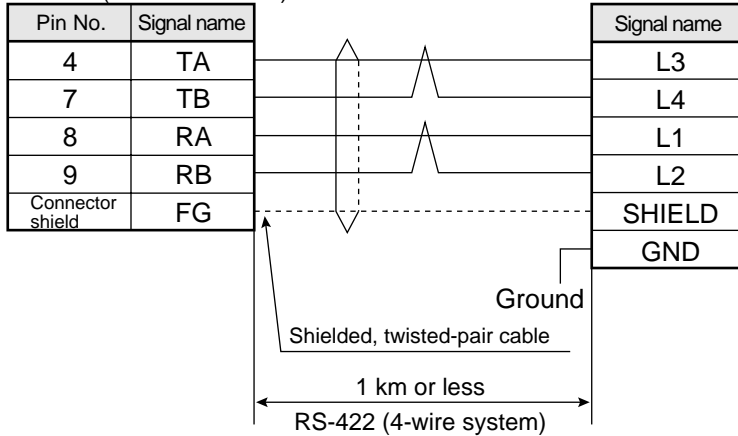

⑥ When a Z-331J/332J is used
 - Communication through the RS-422 port (2-wire system)

Communication connector on the IV-S30 (RS232C/RS422)

Z-331J/332J
 (Host communication port T1)

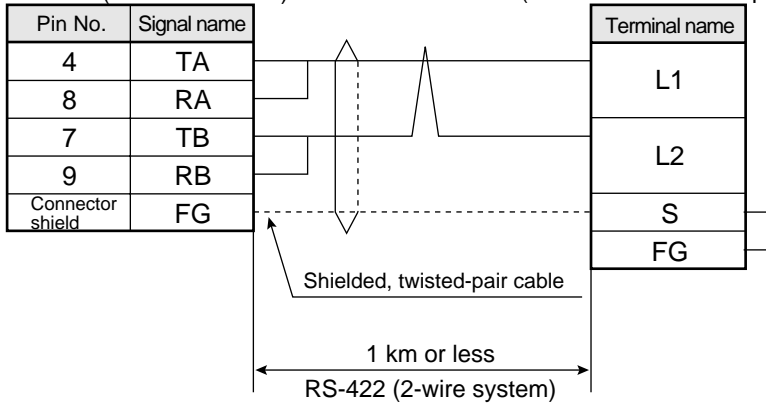

[3] Connection with a Mitsubishi PC

- **Applicable models**

A series computer link modules

1. AJ71C24-Sx (AnA or AnN)

In the case of the AnA, a computer link can be created if a CPU from the AnA series is used and the link module version is S6 or later.

2. A1SJ71C24(A1S)

When the A1SJ71C24-R2 is used, the station number is fixed at 00 because it does not have a station number switch.

3. A0J72C24S1(A0J2)

(1) Module setting

① Example using an AJ71C24-Sx module

Item		Description
Transmission control procedure mode (RS-232C)		Format 1 fi 1
Station No.		00 to 31
Transmission speed (kbit/sec)		19.2, 9.6
Parity		None, odd, even
Transmission code	Data bit	7/8 bits (ASCII)
	Stop bit	1, 2 bits
Checksum		Executed
Writing while running		Possible

- **Switch setting**

Ex.: To set as shown below:

Mode: RS-232C, Station No.: 00, Transmission speed: 19.2 K bytes/sec.

Parity: Even, Data bit: 7 bits, Stop bit: 2 bits

- 3 rotary DIP switches

STATION No.
× 10

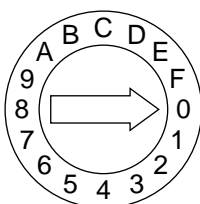

STATION No.
× 1

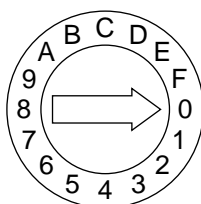

MODE

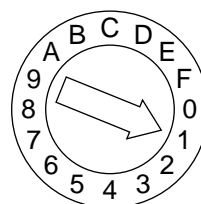

- DIP switches

SW11 to 13	SW14 to 24
OFF	ON

② Example using an A1SJ71UC24-R4 module

● Switch setting

Ex.: To set as below:

Mode: RS-422, Transmission speed: 19.2 K bytes/sec.

Parity: Even, Stop bit: 2 bits

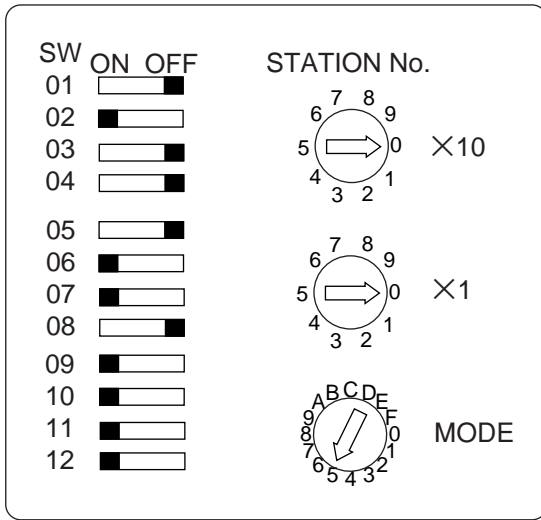

(2) Using memory

To allow the memory to be used by the IV-S30, use a result write start address within the following range.

Memory	Range (address)
D (data register)	0 to 9999/0 to 999900

Note: To write data from the IV-S30 to a Mitsubishi PC, use the WW/QW write command. The range that can be written using the write command WW/QW is D0000 to D1023/D000000 to D008191, due to the limitation of Mitsubishi PCs. The write all address can be set within the range of limitation for Mitsubishi PCs. (See page 17-22.)

(3) Connections

Shown below are the connections with a calculator link module.

① Example of RS-232C connection

Communication connector on the IV-S30 (RS232C/RS422)

Pin No.	Signal name
Connector shield	FG
2	RD
3	SD
5	SG

Calculator link module
In case of 25 pins connector In case of 9 pins connector

Pin No.	Pin No.	Signal name
1	—	FG
2	3	SD
3	2	RD
4	7	RS
5	8	CS
20	4	DTR
6	6	DSR
7	5	SG

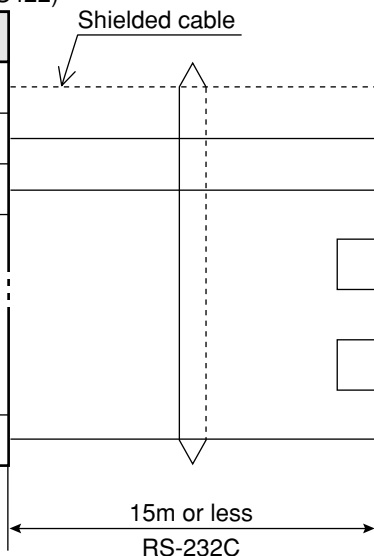

Note: Jumper the RS, CS, DR and CD lines.
Do not jumper the SG.

Remarks

- For RS-232C communications, create the sequence program shown below in order to set "**no CD terminal check**" for the CD terminal check setting. For details, see the instruction manual for Mitsubishi's calculator link module.

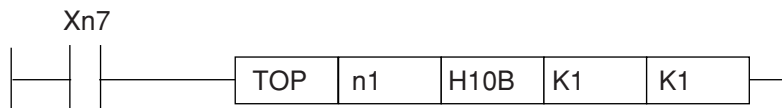

② Example of RS-422 communication

Communication connector on the IV-S30 (RS232C/RS422)

Pin No.	Signal name
Connector shield	FG
4	TA
7	TB
8	RA
9	RB
5	SG

Calculator link module

Signal name
FG
RDA
RDB
SDA
SDB
SG

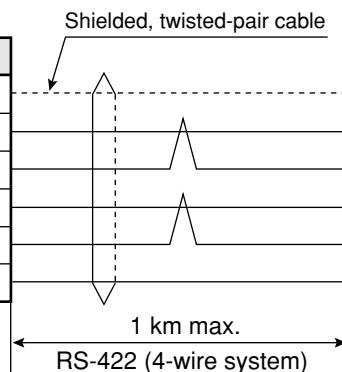

[4] Connection with an OMRON PC

● Applicable models

Host link modules

- 1. C500-LK203 (C1000H)
- 2. C200-LK201 (C200H RS-232C)
- 3. C200-LK202 (C200H RS-422)
- 4. CV CPU link port (CV1000, CVM1)
- 5. CV500-LK201 (CV1000, CVM1)
- 6. CSIW-SCU21

Remarks

- Start the OMRON PC in the monitor mode when turning ON the power. If the OMRON PC is started in any other mode, a computer link error will occur.
 The operation mode is specified using the following items for each support tool: The initial mode setting switch on the memory module, or the monitor mode rising bits of the system setting (FUN49) instruction.

Installed support tool	Memory module initial setting switch		ON
	OFF		
	The bit used to set the monitor mode in the system setting (FUN49) instruction		
	0	1 *1	
Support tools other than the programming console	Program mode	Monitor mode	Operation mode
No support tool	Operation mode	Monitor mode	Operation mode
Programming console	Programming console setting mode *2		

*1 Insert the ladder program step shown below at address 000000.

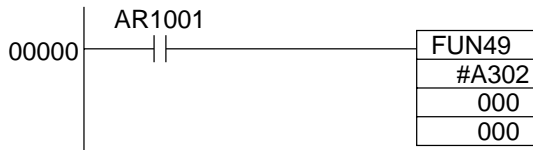

*2 When the programming console is used, set the PC to the "monitor mode" using the switch.

For details, see the user's manual for the OMRON PLC module.

(1) Module setting

Item		Description
Module No.		00 to 31*
Transmission speed (k bit/sec)		19.2, 9.6
Command level		1
Parity		Odd or even
Transmission code Databit	Databit	7 (ASCII)
	Stop bit	2
1:1/1:N procedure		1:N procedure
Synchronous change-over switch		Internal synchronization
CTS change-over switch		0 V (normally ON)
5 V supply switch		OFF

* Enter the unit number of the IV-S30, as a component of CV500-LK201 system. When communication port 1 is used, the unit number is fixed at 00, and when communication port 2 is used, any number (00 to 31) can be used.

(2) Using memory

To allow the memory to be used by the IV-S30, enter a result write start address within the following setting range.

Memory	Range (address)
D (data register)	0 to 9999

Note: The IV-S30 uses [DM area write] command of C mode command. Concerning the limitation of address settings, see OMRON's PC manual.

(3) Connections

① Example of RS-232C communication

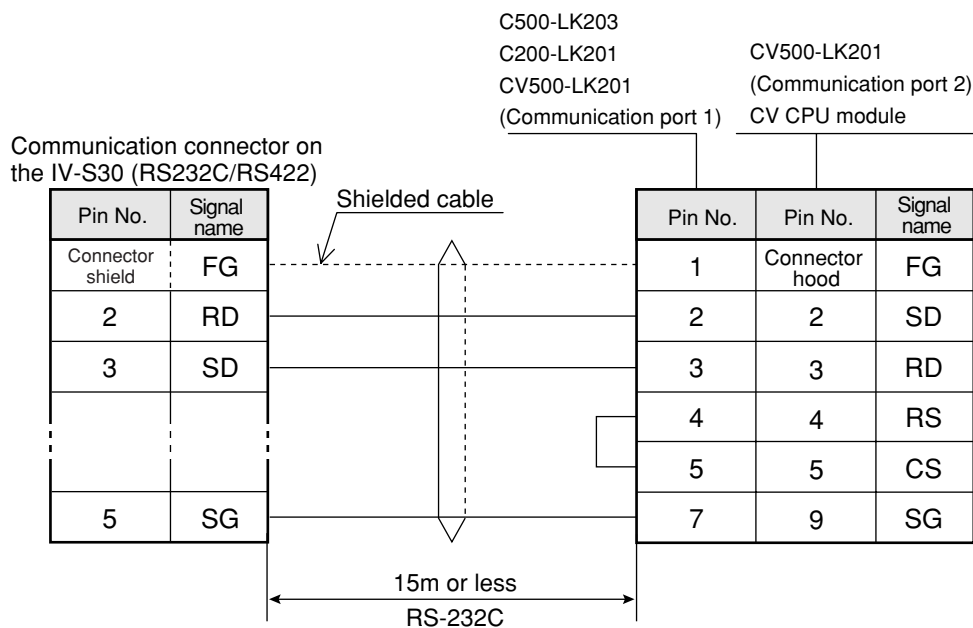

② Example of RS-422 communication

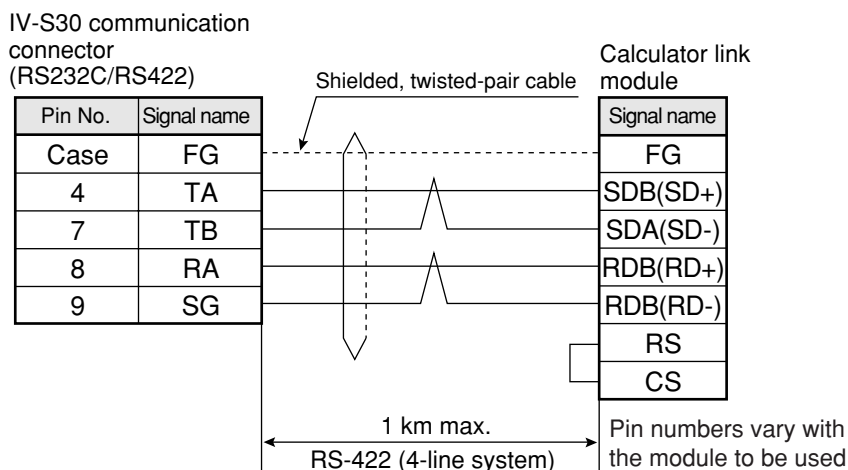

19-7 Program examples

An example of measurements using the IV-S30 and a Sharp PC (JW70H) (2-point search for positional deviation measurement) is explained below, using data flow, a flowchart and a timing chart.

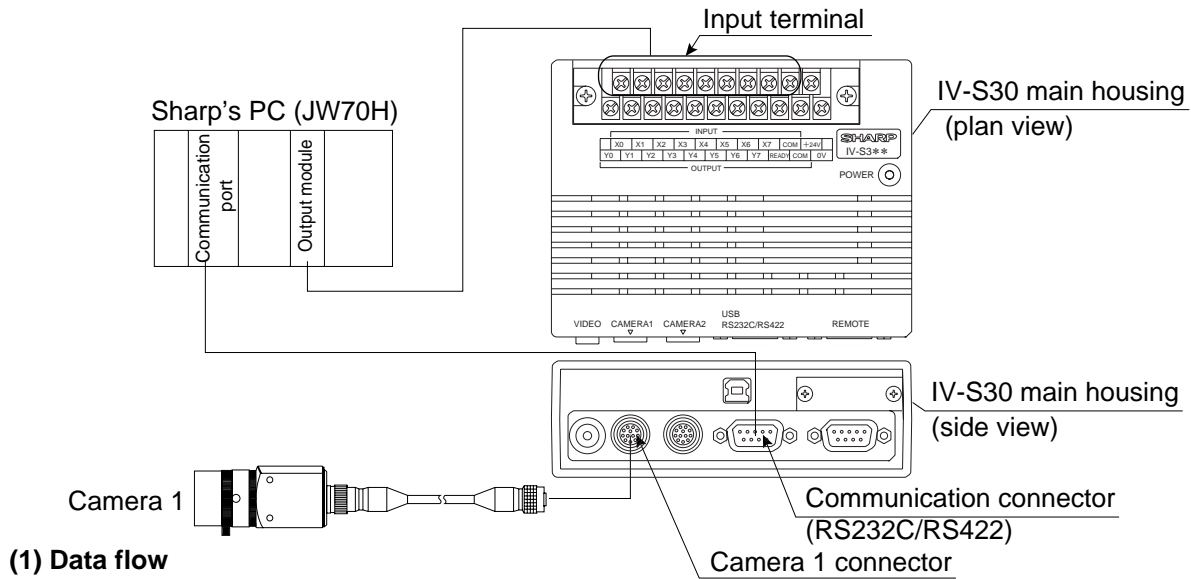

(1) Data flow

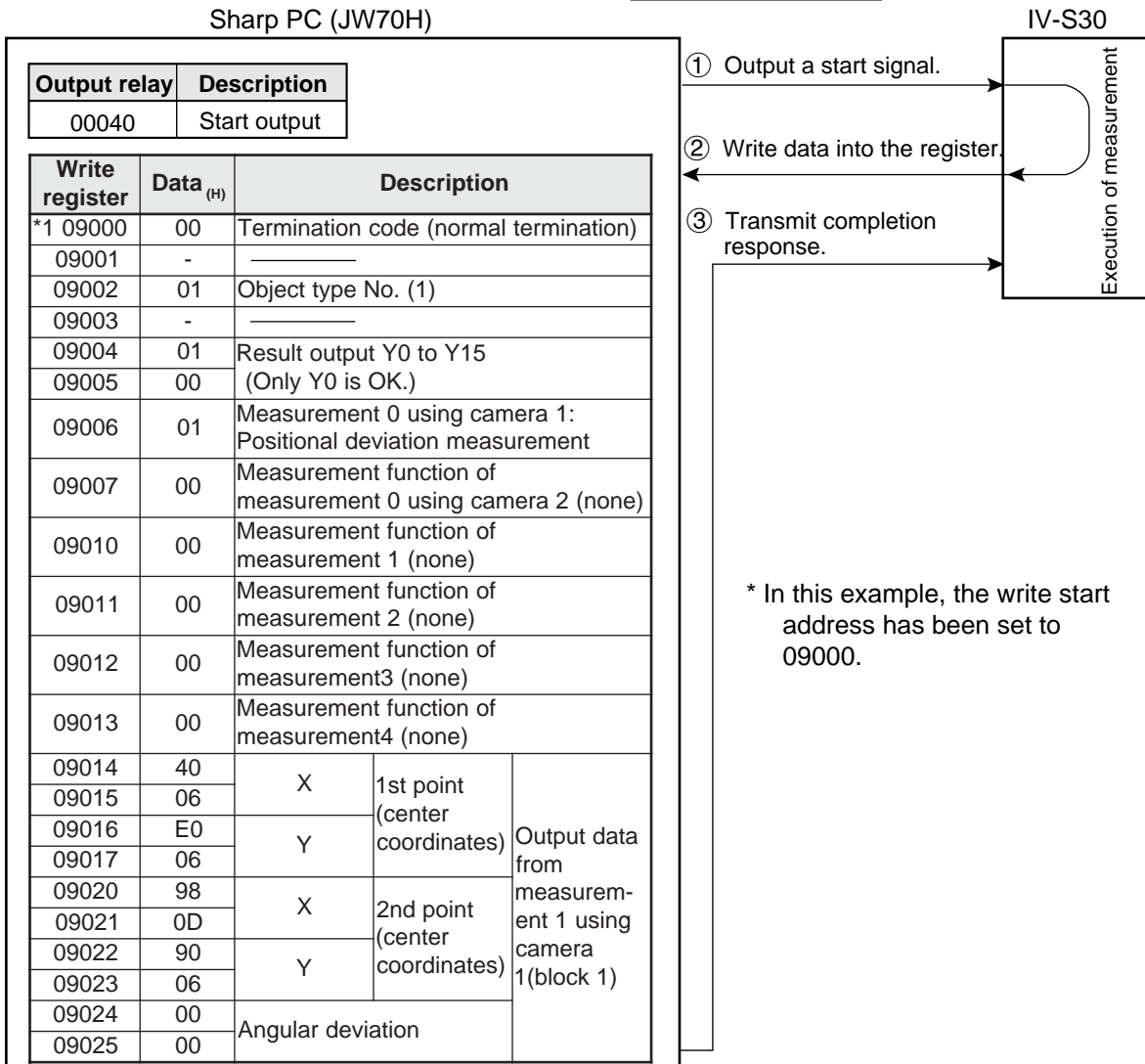

Note 1: The PC must be write enabled. A Mitsubishi, OMRON, or Yokogawa PC will operate in the same manner, but use different PC register and relay addresses.

Note 2: If the PC has not been connected to the object type input (parallel) on the IV-S30, the object type No. is set to 0. To set different types, first enter the object type numbers (parallel) using the type input terminals on the IV-S30.

(2) Flow chart

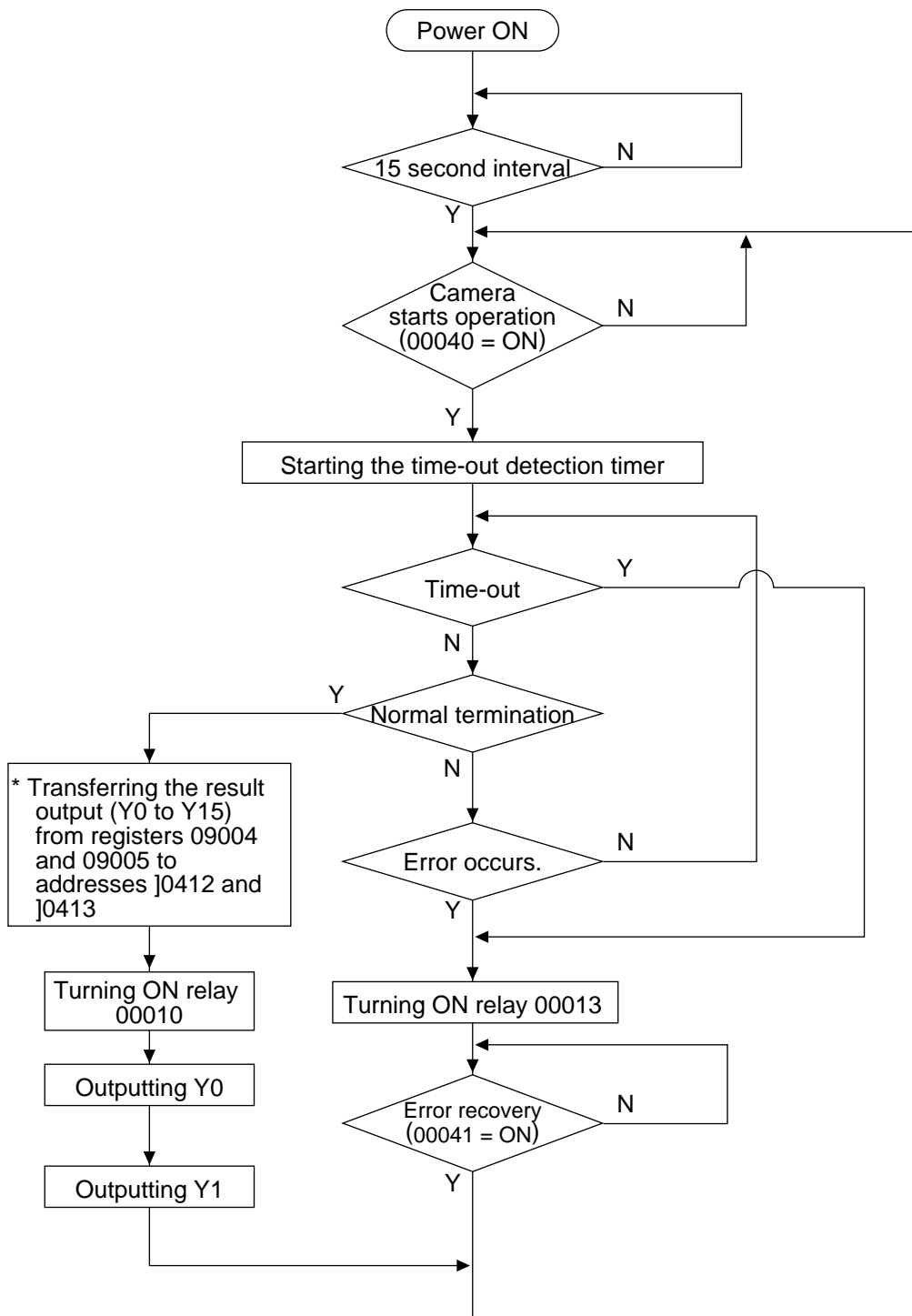

(3) Program

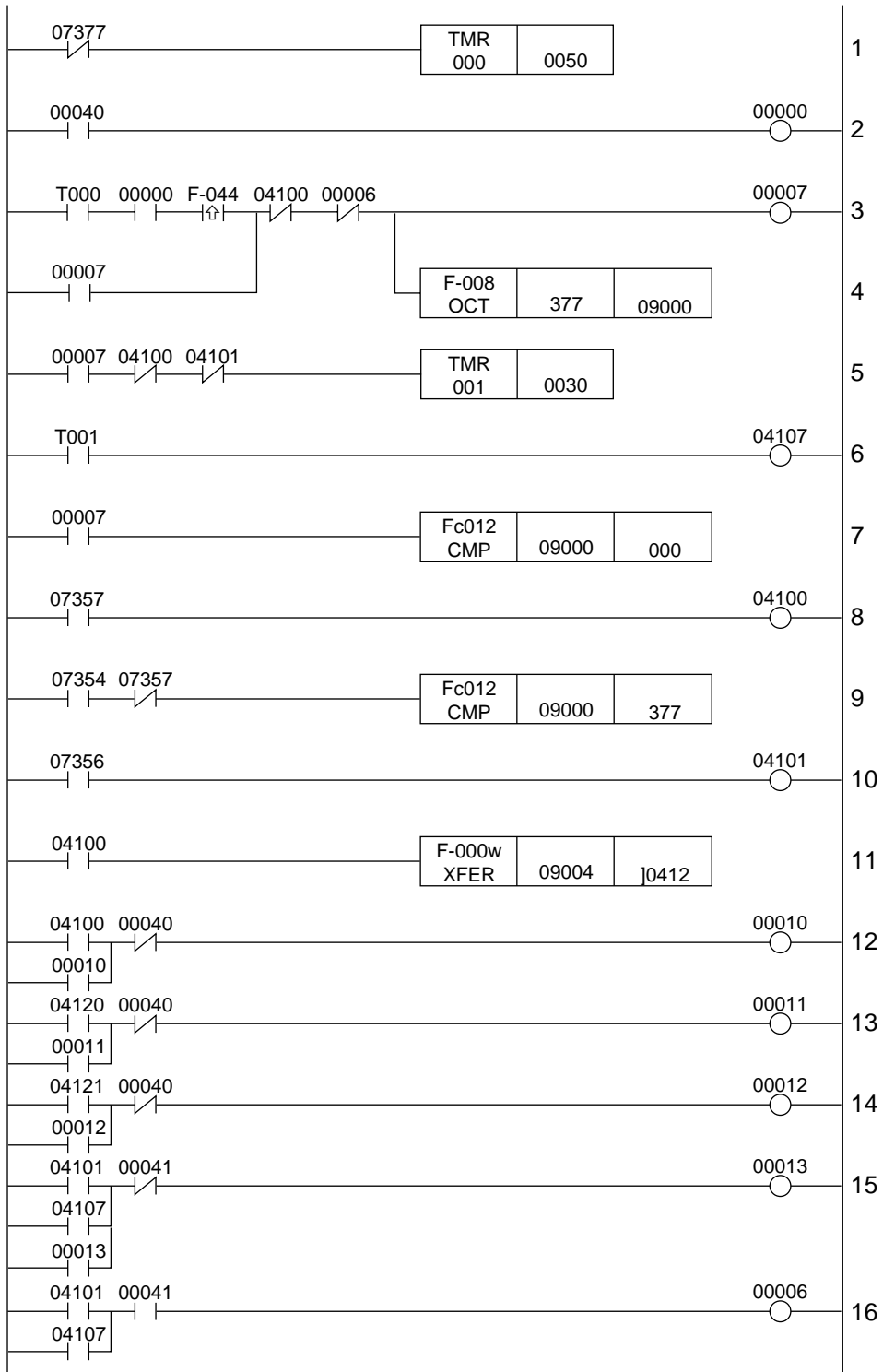

● **Explanation of the program**

The numbers 1 to 16 below correspond to the same numbers on the preceding page.

1. Turn on the power, and wait for 5 sec. (07377 is kept ON for only 1 scan after the power is turned ON.)
2. The camera is started. (00040 enters a measurement trigger.)
3. The trigger input (00007) is self-latched when the operation start has begun (00000 = ON).
4. The termination code of the write register is cleared.
5. The time-out detection timer monitoring the computer link is started.
6. Time-out error
7. A check is made for normal termination.
8. Normal termination (09000 = 000₍₈₎)
9. A check is made for errors.
10. Occurrence of an error (09000 = 001 to 376₍₈₎)
11. The data in the result output relays Y0 to Y15 (16 points) on the IV-S30 is transferred from registers 09004 to 09005 to addresses J0412 and J0413.
12. A normal termination signal is output.
13. The judgment (OK/NG) of the result output relay Y0 is output.
14. The judgment (OK/NG) of the result output relay Y1 is output.
15. When a time-out or an error occurs, it is output.
16. When a time-out or an error occurs, it is reset.

(4) Timing chart

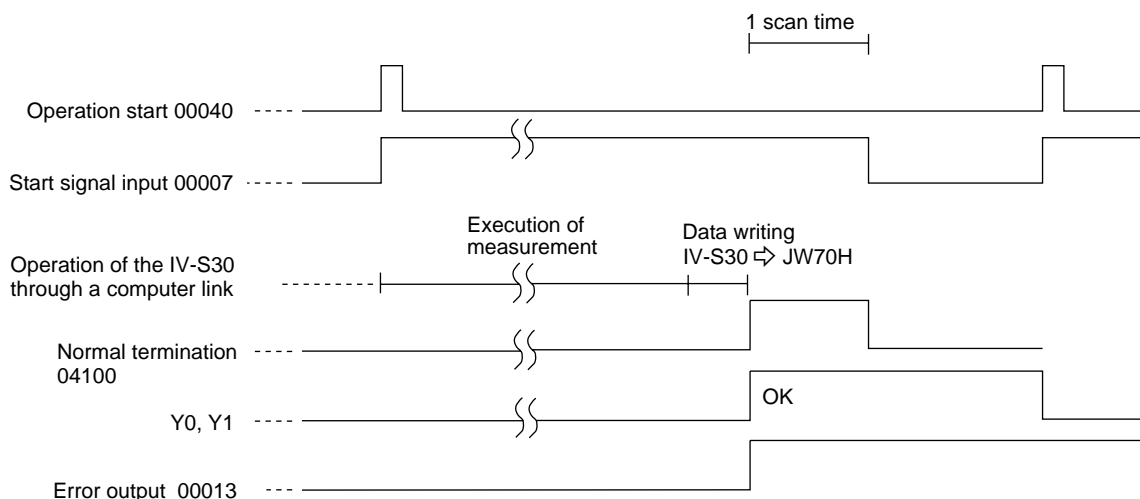

Chapter 20: Troubleshooting

Item [1] shows problems which may occur when the IV-S30 measurement system is started. If any error (the termination code is not 00_(H)) occurs during image processing on the IV-S30, take the steps described in item [2].

Perform the recommended daily inspection following the maintenance procedures listed in item [3].

[1] Symptoms and checks

The following symptoms may not be malfunctions. Before asking us to repair your equipment, check the recommended parts.

Phenomenon	Checks
The power is not turned ON. (The power lamp on the IV-S30 does not light.)	1. Make sure that the power cord has been connected properly to the DC power terminal block on the IV-S30.
	2. Make sure that the proper supply voltage is available and has not dropped.
After the power is first turned ON, no images or characters are displayed on the monitor.	1. Make sure that the monitor cable has been connected correctly.
	2. Make sure that the offset and gain are adjusted properly.
After the power is first turned ON, no characters are displayed on the monitor.	1. Make sure that the message display and pattern display modes are not set to the non-display mode. Make sure that the title field is not filled with spaces.
After the power is first turned ON, no image is displayed on the monitor, or the image on the display is abnormal.	1. The operation screen is always displayed in the freeze mode. Change the mode to the through mode on the lower menu section.*
	2. Make sure that the lens iris is not closed.
	3. Make sure that the shutter speed has not been increased.
	4. Check the lens for contamination.
	5. Check the CCD light receiving surface for contamination.
	6. Make sure that the lens focus has been adjusted properly.
	7. Make sure that the lighting equipment is providing adequate illumination.
The background is completely white (or black) even after the shutter speed is changed.	1. Make sure that the monitor screen is not too bright or dark. (Changes in brightness cannot be sensed.) ⇒ Adjust the lens aperture or the illumination of the light source.
Operations cannot be carried out using the remote key pad.	1. Make sure that the remote key pad cable has been correctly connected to the IV-S30.
General purpose serial communications cannot be performed.	1. Make sure that the communication cable has been correctly connected.
	2. Make sure that each terminal of the communication cable is properly connected.
	3. Make sure that the communication conditions (standard, speed, and parity check) in the personal computer conform to those of the IV-S30.
	4. Check the cable for disconnection and the connectors for contact failure.
	5. Make sure that you waited about 15 seconds after you turned ON the power.
	6. Make sure that the operation screen is displayed on the screen.



- Continued on the following page -

* You can change to the through mode screen using the "TYPE RUN COND" screen.

Phenomenon	Checks
Communications through a computer link cannot be established.	1. Make sure that the communication cable has been correctly connected.
	2. Make sure that the communication cable route does not run near electrically noisy devices.
	3. Make sure that each terminal of the camera cables is properly connected.
	4. Make sure that the communication conditions (standard, speed, and parity check) in the personal computer conform to those of the IV-S30.
	5. Make sure that a compatible model, the station No. and result write start address have been set correctly.
	6. Make sure that you waited about 15 seconds after you turned ON the power.
	7. Make sure that the operation screen is displayed on the screen.
Measurement does not start even when a start trigger is given.	1. Make sure that measurement can be started by using the key pad to send a trigger signal.
	2. Make sure that the camera cables have been correctly connected.
	3. Make sure that the device to send a trigger signal have been properly connected to the input terminals on the IV-S30 main housing.
	4. Make sure that you waited about 15 seconds after you turned ON the power.
	5. Make sure that the operation screen is displayed on the screen.
Measurement results are not output.	1. Make sure that the camera cables have been correctly connected.
	2. Make sure that the devices have been properly connected to the input terminals on the IV-S30 main housing.
	3. Make sure that you waited about 15 seconds after you turned ON the power.
	4. Make sure that the operation screen is displayed on the screen.
Measurement results are unstable, or NG results occur frequently.	1. Make sure that the lighting equipment does not flicker.
	2. Make sure that the lens has not fogged up.
	3. Check the lens for contamination.
	4. Make sure that the focus ring has not turned. (Make sure that the camera lock screw has been secured.)
	5. Check whether the camera position has changed.
	6. Make sure that the illuminance monitor window has been set to the intermediate illumination.
	7. Make sure that the criteria have been set properly.

[2] Causes of termination codes (when an error occurs) and remedies

When an abnormal termination code (other than 00_(H)) is received, take the following measures.

Termination code (H)	Cause	Remedy	
Communication errors	01	The specified processing code does not exist.	Check the processing code.
	02	The wrong number of data items was specified in the text.	Check the number of data items in the text.
	03	The text data is outside the acceptable range.	Check the text setting range.
	04	The results of the check sums are not identical.	- Check the checksums. - Check the communication environment for problems such as electric noise, which may come in on the communication line.
	05	The header code (:) was not attached to the head of the communication command.	Check whether the header code was attached to the head of the communication command.
	06	An asynchronous error has occurred.	- Check the communication environment for problems such as electric noise, which may come in on the communication line.
	07	The communication command contains an improper number of data items.	Check the number of data items in the communication command.
Computer link errors	08	An error response has been returned from the programmable controller. (Communications are performed normally.)	The error code is contained in the evaluation result area, and the error code is displayed on the monitor. Take the proper measures according to the error code (different models use different codes).
	09	A time-out has occurred during communication through the computer link.	- Make sure the power supply of the programmable controller and check the connections of the cables. - Check the communication conditions and computer link settings.
	0A	Start address error (larger than the end address)	Check the address.
Hardware errors	10	SDRAM error	Replace the IV-S30 itself.
	11	Flash memory error	
	12	No camera connected to the camera 1 connector.	Connect a camera.
	13	No camera connected to the camera 2 connector.	
	14	VRAM error has occurred.	Replace the IV-S30 itself.
	18	Flash ROM delete error	
	19	Flash ROM write error	
1A	Flash ROM verify error		
Processing errors	20	The measurement conditions for the specified object type have not been set.	Check the abnormal setting.
	21	The setting area is larger than the screen, due to positional correction.	
	22	Correction after binary conversion: The illuminance monitor function (system) has not been set.	
	23	Correction after binary conversion: The threshold range has exceeded the specified range.	
	24	No edge detection	
	25	A reference image has not been registered.	
	26	Number of labels exceed the specified amount	
	27	No setting for number of image lines	
28	"0" subtraction error (numeric calculation)		

Termination code (H)	Cause	Remedy	
Processing errors	29	Overflow (numerical calculation)	Check the abnormal setting.
	2A	No numerical calculation setting	
	2B	No label (camera adjustment)	
	2C	The search area is smaller than the reference image.	
	2D	Equivalent label exceeded	
	2E	Edge center point exceeded (lead inspection)	
	2F	Unable to make a numerical calculation (point measurement)	
	30	Coordinates range exceeded (distance/angle measurement)	
	31	The lines are parallel (at the same angle) (cross point of two straight lines)	
	32	Divide by "0" (center of circle, vertically bisector, distance between point and line)	
	33	The two points are the same (two points on a straight line)	
	34	The CCD trigger has not been registered.	
	35	The CCD trigger is not being sampled by a serial interface signal.	
	36	The SIO trigger has not been set.	
	37	A start point has not been set. (Distance/angle measurement)	
	38	The auxiliary point conditions are not thoroughly specified. (Distance/angle measurement)	
	39	Wrong conditions specified for a line or a point (distance / angle measurement)	
	3A	The distance conditions are not thoroughly specified. (Distance/angle measurement)	
	3B	The angle conditions are not thoroughly specified. (Distance/angle measurement)	
	3C	Image reading/writing is impossible.	
	3D	The range of calculations using two images has exceeded the specified range.	
	3E	The reference image cannot be registered from parallel input X6.	
	3F	Exceeded the number of reference images registered	
	40	Image not captured (CCD trigger)	
	41	The reference image rotation condition does not match.	
	42	The reference image edge is not registered yet.	
	43	CCD trigger disabled (through image).	
	44	Not a manual measurement	
45	Binary mask conditions not set yet		
46	No position correction conditions - You assigned a non-existing register number or model number to the position correction conditions. - An angle has not been assigned for rotation correction (only X and Y correction values have been assigned.) - The rotation angle detection is set to "NO" for a 1-point search, or this register number is used for the angular correction in the rotation correction.		
47	Number of objects to measure has not been set. (BGA/CSP)		
48	In a multiple detection, the number of the edges exceeded the limit.		
49	Unable to make a positional correction since there is no edge.		

Termination code	Cause	Remedy
(H)		
Processing errors	4A	No output data
	4B	Object type conditions not set yet (numerical calculation)
	4C	Number of objects detected or number of labels is too small (numerical calculation)
	4D	Image capture mode does not match.
	4E	Cannot make two corrections in one step (same register number)
	4F	Serial trigger disabled
Communication errors	50	The object type cannot be changed.
	51	No corresponding block
	52	The output camera cannot be changed.
	54	Image area is not appropriate
	55	NG image not registered
	56	Font not registered
	57	Character strings not registered
	58	Menu tables not registered
	59	Area not registered (user menu)
	5A	Title not registered (user menu)
	5B	Initialization error (user menu)
	5C	Number of data exceed the limit (any setting)

Check the abnormal setting

[3] Maintenance

Check the equipment for the following items.

(1) Operation check

- Change the measurement number on the MAIN OPS MENU, and change the monitor screen to the freeze or through mode. Then, make sure that the image is normally displayed.

(2) Checks

- Check the illumination from the lighting equipment.
- Make sure that the monitor screen is in focus and that the aperture setting is proper.
- Check the cable insulation for breaks, and make sure that the cable connectors are not loose.
- Carefully wipe dust off the lens with a soft, dry cloth.
- If dust has landed on the CCD surfaces of this camera, wipe them with a clean cotton swab soaked in isopropyl alcohol. Move the cotton swab lightly and slowly in one direction. Change cotton swabs frequently. Do not clean more than one CCD surface with one cotton swab.

● Procedure for checking after cleaning

- ① Mount the lens (mirror tube) on this camera.
- ② Close the lens iris all the way.
- ③ Point the lens toward the light source, and check the monitor screen to make sure that there are no spots on the screen. (If the iris is open even a little, then even if spots exist, they will not be visible on the monitor screen. Fine adjustments to the iris are required.)

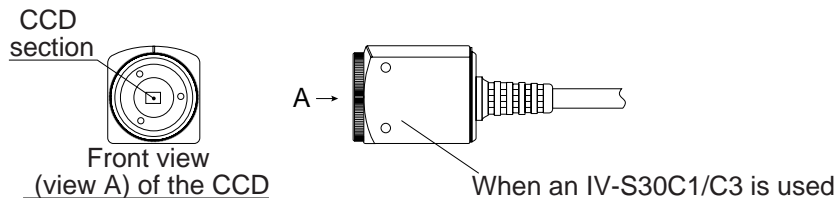

(3) When measurement errors and/or evaluation errors occur frequently, check:

- The illumination of the lighting equipment and lamps.
 - The inspection object is within the window.
 - The cables for looseness or disconnection.
 - The lens for dirt and dust.
 - The lens focus and aperture have not changed.
 - The power is being supplied normally, and
 - The parameters you set have been stored.
- (If the parameters have changed, reset the parameters from the beginning.)

Alphabetical Index

[A]

Absolute value of the differences	3-21
ALL-INIT (total initialization)	2-22
AND (evaluation)	11-5
Angle detection (DTECT ANGL)	4-12
Angular correction (standard/high precision)	3-31
Area Measurement by Binary Conversion	8-1
Artifact processing	3-16
Automatic setting (threshold value)	3-12
AUTO-REG (condition setting)	3-16
Average light level method	17-18

[B]

BGA/CSP Inspection (IV-S32MX/S33MX)	7-1
Binary area conditions	3-28
Binary image display	2-7
Binary image mask	3-26
Binary method	17-18
Binary processing (fixed/threshold value correction)	3-13
BLK WRT COMMAND (block write command)	17-22

[C]

Calibrating the IV-S30	17-28
Camera selection (IV-S32MX/S33MX)	2-17
Camera selection	3-4
Camera settings	2-17
Camera synchronization (IV-S33MX)	2-19
CAMERA TYPE	2-17
Causes of termination codes (when an error occurs) and remedies	20-3
CCD trigger	17-18
Change camera display mode	2-3
Change the Japanese or English display mode	1-15
CHG-C1 (change camera 1)	1-12
CHG-C2 (change camera 2)	1-12
CHG-MEA (change measurement)	1-12
CHG-TYPE (change object type)	1-12
CHNG-REG (change registration)	1-12
Circle window	3-6
Common operations for each menu	1-14
Communication (General Purpose Serial Interface)	18-1
Communication format	18-5
Comparative calculations between images	3-21
Compatible models	19-1
Computer link output	17-23
Computer link setting	17-22
Computer Link	19-1

Configuration of Set Wizard	1-6
Configuration of the setting conditions	1-5
Connection with a Mitsubishi PC	19-27
Connection with a Sharp PC	19-21
Connection with an OMRON PC	19-30
Contents of the measurement result block (for each measurement function)	19-6
CONTR. PIXL (pixel contraction)	4-7
Contrast magnification rate	3-23
Contrast search (reference image)	3-17
Copying	3-38
Crosshair cursor display	2-12, 2-13

[D]

Data flow	18-3, 19-2
Data in specified blocks	17-23
Data length	19-20
Degree of Match Inspection	5-1
Description of the Operation screen	1-10
Detection precision	3-10
DISPLAY MODE	1-15
Distance and Angle Measurement	14-1

[E]

Edge detection condition	4-7
Edge detection	3-15
Edge emphasis	3-24
Edge extraction	3-24
Editing Operation screen	2-21
Eliminating binary noise	3-14, 7-6, 8-6, 9-6, 10-7
Elliptical window	3-8
Evaluation change display	2-10
Evaluation conditions	3-18
Evaluation condition measurement	
Area measurement by binary conversion	8-6
BGA/CSP inspection	7-7
Degree of match inspection	5-8
Lead inspection	6-4
Multiple degree of match inspection	13-7
Multiple positional measurement	12-9
Object counting by binary conversion	9-7
Object identification (labeling) by binary conversion	10-8
Point measurements	11-7
Positional deviation measurement	4-9
Examples of a final output conditions ladder circuit	16-17
Existence Inspection by Point Measurement	11-1
Expansion/contraction method of elimination noise in binary images	3-14
Extension functions	2-12
External synchronization	2-19

[F]	
Final numerical calculations	15-9
Final output conditions	16-11
Flow chart	19-33
Full	2-18
Full+half	2-18
[G]	
Gain/offset adjustment	2-15
General purpose serial output	17-21
Gray level change	3-23
Gray scale processing	3-10
Gray scale search	
└ Degree of match inspection	5-3
└ Multiple positional measurements	12-3
└ Positional deviation measurements	4-4
[H]	
Half	2-18
Halt on NG measurement	3-40
Histogram widening	3-23
Horizontal edge	3-24
Horizontal line	3-7
How to display NG images	1-19
How to enter the setting screen	3-1
How to register NG images (IV-S32MX/S33MX)	1-17
[I]	
Illuminance (light level) monitor	3-35
Image adjustment	3-25
Image capture mode (IV-S33MX)	2-18
Image capture	2-4
Image pre-processing	3-20
Image settings	3-10
Individual numerical calculations for each measuring program	15-1
Initialization	2-22, 18-2, 18-4
Initializing the NG images (IV-S32MX/S33MX)	1-23
Input & Output / System settings	3-35
Interface	19-20
Internal synchronization	2-19
[L]	
Ladder circuit program creation	16-3
Lead Inspection	6-1
List of processing functions	18-1
LOCK (menu display)	1-15
Lock the menu display	1-15

[M]

MAIN OPS MENU	1-15
Maintenance	20-6
MANL-MEAS (manual measurement)	1-12, 2-13
Manually setting the object type	2-14
Mask setting	3-26, 7-6, 8-6, 9-6, 10-7
Measurement conditions	
Area measurement by binary conversion	8-2
BGA/CSP inspection	7-2
Degree of match inspection	5-2
Distance and angle measurement	12-2
Lead inspection	6-2
Multiple degree of match inspection	13-2
Multiple position measurement	12-2
Object counting by binary conversion	9-2
Object identification (labeling) by binary conversion	10-2
Point measurements	11-2
Positional deviation measurement	4-2
MEA-CND (measurement conditions)	1-5
Measurement data blocks	19-5
Measurement processing cycle	16-2
Measurement start input and result output settings	17-5
Measurement start input interface	17-1, 17-4
Measurement start input	17-4
Menu bar	1-11, 1-12
Menu configuration	1-4
Message display	2-5
Method for selecting the menu configuration	1-2
Mid emphasis	3-23
Monitor output	2-2
Multiple degree of match inspection	13-1
Multiple positional measurements	12-1

[N]

NEXT-NG (display next NG image)	1-22
NG image display screen	1-19
NG image display	1-19 to 23
NG image registration (IV-S32MX/S33MX)	1-17 to 18, 3-39
Number of blocks	19-5
Numeric calculation	
Area measurement by binary conversion	8-8, 15-6
BGA/CSP inspection	7-8, 15-5
Degree of match inspection	5-9, 15-5
Distance and angle measurement	14-8, 15-8
Lead inspection	6-8, 15-5
Multiple degree of match inspection	13-8, 15-7
Multiple position measurement	12-10, 15-7
Object counting by binary conversion	9-8, 15-6
Object identification (labeling) by binary conversion	10-9, 15-6

Point measurements	11-8, 15-7
Positional deviation measurement	4-10, 15-2
Numerical calculation conditions	15-1
Numerical calculations (setting examples)	15-2
Numerical Calculations	15-1
[O]	
Object Counting by Binary Conversion	9-1
Object identification and numbering function (labeling)	3-12
Object Identification by Binary Conversion	10-1
Operation cycle	16-1
Operation flow after the measurement start input is turned ON.	1-26
Operation flow	1-24
Operation main display	2-9
Operation screen	1-10
Operation set menu	2-1
Operations menu lock	1-15
Operations to return to the operation screen	1-14
Operation settings	
Area measurement by binary conversion	8-2
BGA/CSP inspection	7-2
Degree of match inspection	5-2
Distance and angle measurement	14-2
Lead inspection	6-2
Multiple degree of match inspection	13-2
Multiple positional measurements	12-2
Object counting by binary conversion	9-2
Object identification (labeling) by binary conversion	10-2
Point measurements	11-2
Positional deviation measurement	4-2
Option	2-22
OR (evaluation)	11-5
Output conditions	
Area measurement by binary conversion	8-8, 16-9
BGA/CSP inspection	7-8, 16-9
Degree of match inspection	5-9, 16-9
Distance and angle measurement	14-8, 16-10
Lead inspection	6-8, 16-9
Multiple degree of match inspection	13-8, 16-10
Multiple positional measurements	12-10, 16-10
Object counting by binary conversion	9-8, 16-10
Object identification (labeling) by binary conversion	10-9, 16-10
Point measurements	11-8, 16-10
Positional deviation measurement	4-10, 16-4
Output block assignment	17-23
Output code	18-16, 19-18
Output conditions	16-3
Output monitor	2-1



[P]

Parallel input X6	17-2
Parallel input X7	17-3
Parity check	17-21
Pattern display	2-6
Pattern settings	3-5
PC Function	16-1
PC monitor screen	2-11, 16-18
PC scan cycle	16-2
Pixel contraction	3-10
Point condition	11-4
Point measurement	11-1
Polygonal window	3-9
Position correction	3-31
Positional Deviation Measurement	4-1
Power ON and main loop processing	1-24
Power ON setting menu	1-15
Pre-processing	3-20
Processing functions	18-7
Program examples (shape and positional deviation inspection)	16-16
Program examples	19-32

[R]

RAM initialization	2-22
Reading result	18-1, 18-9
READY'ON (I/O conditions)	17-3
Rectangular window	3-5
RE-EXAM-NG (re-examine NG)	1-22
Reference image	4-5
Register and display NG images	1-17
Register coordinate position (window group move)	3-41
Register a reference image	4-6
Register setting	19-3
Remote keypad (IV-S30RK1)	1-16
Remote keypad specifications	1-16
Reset	18-2
RESET (condition settings)	3-16
Result output	17-5
Reference image (masking)	3-17

[S]

SAVE	1-12
Saving data	1-14
Select "ANY" for the serial output	17-26
Select "YES" or "NO" for output data	17-27
SELECT CAMERA	2-17, 3-4
Select output	15-3
Self-diagnosis	2-22
Serial output	17-23, 17-26

Set serial block	17-25
Set wizard	1-2
Setting (operating) procedure	17-24
Setting and Operating Outline	1-1
Setting and operating procedures	1-1
Setting any data output	17-26
Setting distance and angle condition	14-2
Setting examples	15-11
Setting for serial communications	17-21
Setting items for the IV-S30	19-20
Setting Measurement Conditions	3-1
Setting numerical data of any output measuring	18-16
Setting reference image area	4-4 to 5
Setting the conditions for each object type	3-1
Setting the data output	17-26
Setting the Input/Output Conditions	17-1
Setting the measurement programs	1-13
Setting the Operating and System Conditions	2-1
Setting the operating conditions	2-1
Setting the shutter speed	3-37
Setting the system conditions	2-14
Setting the system time (IV-S32MX/S33MX)	2-16
Setting window boundaries	3-12
Shading correction	3-25
Shared settings	3-4
Shutter speed	3-37
Smoothing (median, average)	3-24
Space filter	3-24
Specifications for any output data	19-17
Station No.	17-22
STROBE OUT (strobe output)	17-3
Subtraction	3-25
Symptoms and checks	20-1
SYS-CND (system conditions)	1-5

[T]

Table of controller functions	1-29
Termination code	20-3
Threshold value automatic setting (edge detection)	3-16
Threshold value automatic setting (gray scale search)	3-11
Threshold value correction	3-13
Threshold value setting	3-11
Through display	2-11
Title registration	3-34
Troubleshooting	20-1

[V]	
Variation difference	3-13
Variation rate	3-13
Vertical edge	3-24
Vertical line	3-7
[W]	
Window group move	3-41
Window shape selection and settings	3-5
Write address	17-22
[X]	
XY correction	3-31
[γ]	
γ (positive/negative)	3-23
[θ]	
θ angle correction image display	2-8