

User's Manual

Click to go to chapter index



BEFORE USING THE MACHINE

Functions of the machine and procedures for placing originals and loading paper



OPERATION OF THE MACHINE

Operation of the touch screen and customisation of the user interface



COPIER

Using the copy function



PRINTER

Using the printer function



FACSIMILE

Using the fax function



SCANNER/INTERNET FAX

Using the scan / Internet fax function



DOCUMENT FILING

Storing jobs as files on the local drive



MANUAL FINISHING

Using the manual finishing function



CONVENIENT USE OF THE MACHINE

Useful features of this machine



SETTING MODE

Configuring settings to make the machine easier to use



TROUBLESHOOTING

Questions and answers and care instructions



APPENDIX

About the specifications

HOW TO USE THIS MANUAL

Click a button below to move to the page that you wish to view.

The following explanation assumes that Adobe Reader is being used (Some buttons do not appear in the default state.).

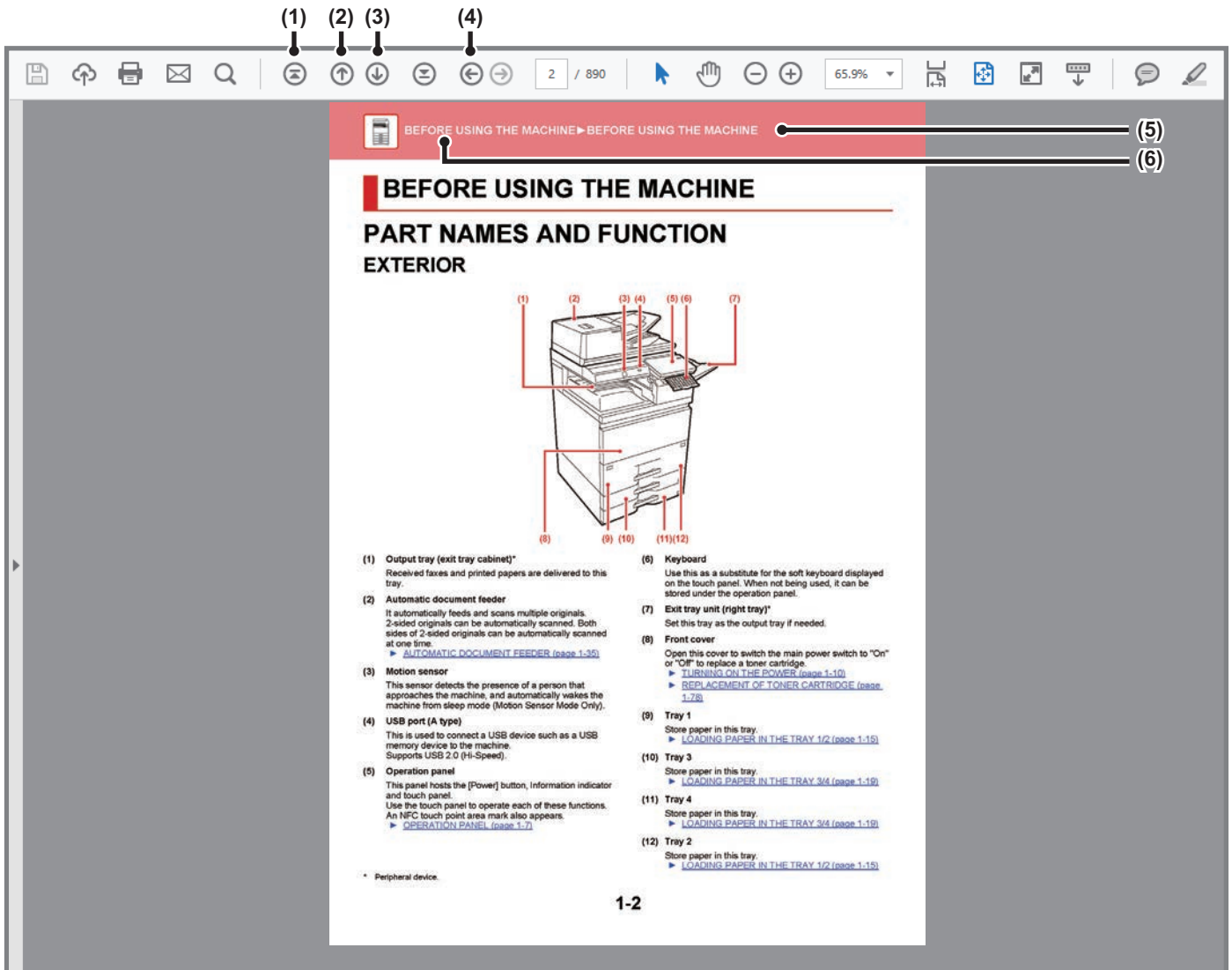

(1) Return to top page button

If an operation does not proceed as expected, click this button to start over again.

(2) Back one page button

Displays the previous page.

(3) Forward one page button

Displays the next page.

(4) Return to previously displayed page button

Displays the page that was displayed before the current page.

(5) Title button

Displays the page of the title indicated by the button.

(6) Contents button

Displays the contents of each chapter.

For example, if the current page is part of the printer chapter, the table of contents of the printer chapter appears.



If a button does not appear, refer to Adobe Reader Help to display the button.

ABOUT OPERATION MANUAL

This manual explains how to use the BP-70M75/BP-70M90 digital multifunctional system.

Please note

- For information on installing the drivers and software cited in this manual, please refer to the Software Setup Guide.
- For information on your operating system, please refer to your operating system manual or the online Help function.
- The explanations of screens and procedures in a Windows environment are primarily for Windows® 10. The screens may be different depending on the version of the operating system or the software application.
- The explanations of screens and procedures for use in a macOS environment generally assume that macOS 11 is being used and a PPD driver is installed. The screens may be different depending on the version of the operating system or the software application.
- Wherever "BP-xxxx" appears in this manual, please substitute your model name for "xxxx".
- This manual contains references to the fax function. However, please note that the fax function is not available in some countries and regions.
- Considerable care has been taken in preparing this manual. If you have any comments or concerns about the manual, please contact your dealer or nearest SHARP Service Department.
- This product has undergone strict quality control and inspection procedures. In the unlikely event that a defect or other problem is discovered, please contact your dealer or nearest SHARP Service Department.
- Aside from instances provided for by law, SHARP is not responsible for failures occurring during the use of the product or its options, or failures due to incorrect operation of the product and its options, or other failures, or for any damage that occurs due to use of the product.

Warning

- Reproduction, adaptation or translation of the contents of the manual without prior written permission is prohibited, except as allowed under copyright laws.
- All information in this manual is subject to change without notice.

Illustrations and the operation panel and touch panel shown in this manual





The peripheral devices are generally optional, however, some models include certain peripheral devices as standard equipment. The explanations in this manual assume the BP-70M90.

For some functions and procedures, the explanations assume that devices other than the above are installed.

The display screens, messages, and key names shown in the manual may differ from those on the actual machine due to product improvements and modifications.

Icons used in the manuals

The icons in the manuals indicate the following types of information:

	This alerts you to a situation that could result in death or serious personal injury. This alerts you to a situation that could result in personal injury or damage to properties.		This explains how to stop or correct an operation.
	This alerts you to a situation where there is a risk of machine damage or failure.		This describes a routine work relevant to setting mode.
	This supplements function or operation procedure.		



BEFORE USING THE MACHINE

BEFORE USING THE MACHINE

PART NAMES AND FUNCTION	1-2
EXTERIOR	1-2
INTERIOR	1-4
AUTOMATIC DOCUMENT FEEDER AND DOCUMENT GLASS	1-5
SIDE AND BACK	1-6
OPERATION PANEL	1-7
INFORMATION INDICATOR	1-8
TURNING ON THE POWER	1-10
TURNING ON THE POWER	1-10
TURNING OFF THE POWER	1-10
RESTART THE MACHINE	1-10

LOADING PAPER

IMPORTANT POINTS ABOUT PAPER	1-11
NAMES AND LOCATIONS OF TRAYS	1-11
THE DEFINITION OF "R" IN PAPER SIZE	1-11
APPLICABLE PAPER TYPES	1-12
LOADING PAPER IN THE TRAY 1/2	1-15
CHANGING THE PAPER SIZE	1-17
LOADING PAPER IN THE TRAY 3/4	1-19
LOADING TAB PAPER INTO TRAY 4	1-21
LOADING PAPER IN THE LARGE CAPACITY TRAY ..	1-23
LARGE CAPACITY TRAY (BP-LC11)	1-23
LARGE CAPACITY TRAY (MX-LC19)	1-24
LOADING PAPER INTO THE BYPASS TRAY	1-28
HOW TO LOAD THE PAPER	1-28
LOADING TAB PAPER	1-28
INSERTING TRANSPARENCY FILM	1-29
HOW TO PLACE THE LONG PAPER GUIDE	1-31

HOW TO PLACE THE ORIGINAL

SELECTING A PROCEDURE FOR PLACING THE ORIGINAL DEPENDING ON THE TYPE AND STATUS OF THE ORIGINAL	1-32
DETECTABLE ORIGINAL SIZES	1-32
AUTOMATIC DOCUMENT FEEDER	1-34
PREVENTIVE LIGHT TO INDICATE ORIGINAL LEFT BEHIND	1-36
ORIGINAL SETTING INDICATOR	1-37
SKEW FEED PREVENTION	1-37
DOUBLE FEED DETECTION	1-37
DOCUMENT GLASS	1-38

PERIPHERAL DEVICES

PERIPHERAL DEVICES	1-40
FINISHER	1-42
PART NAMES	1-42
HOW TO STAPLE MANUALLY	1-43
SUPPLIES	1-44
FINISHER MAINTENANCE	1-44
FINISHER (LARGE STACKER)	1-46
PART NAMES	1-46
SUPPLIES	1-47
FINISHER (LARGE STACKER) MAINTENANCE	1-47
DISCARDING STAPLE WASTE	1-49
SADDLE STITCH FINISHER	1-51
PART NAMES	1-51
HOW TO STAPLE MANUALLY	1-52
SUPPLIES	1-53
SADDLE STITCH FINISHER MAINTENANCE	1-54
SADDLE STITCH FINISHER (LARGE STACKER)	1-58
PART NAMES	1-58
SUPPLIES	1-59
SADDLE STITCH FINISHER (LARGE STACKER) MAINTENANCE	1-59
DISCARDING STAPLE WASTE	1-64
DISCARDING PAPER WASTE	1-65
FOLDING UNIT	1-67
PART NAMES	1-67
INSERTER	1-68
PART NAMES	1-68
PUNCH MODULE (MX-PN16B)	1-69
DISCARDING PUNCH WASTE	1-69
PUNCH MODULE (MX-PN13B)	1-71
DISCARDING PUNCH WASTE	1-71

MAINTENANCE

REGULAR MAINTENANCE	1-73
CLEANING THE DOCUMENT GLASS AND AUTOMATIC DOCUMENT FEEDER	1-73
CLEANING THE BYPASS FEED ROLLER	1-75
CLEANING THE PAPER FEED ROLLER	1-76
REPLACEMENT OF TONER CARTRIDGE	1-77
REPLACEMENT MESSAGE	1-77
REPLACING THE TONER COLLECTION CONTAINER	1-80



BEFORE USING THE MACHINE

PART NAMES AND FUNCTION

EXTERIOR

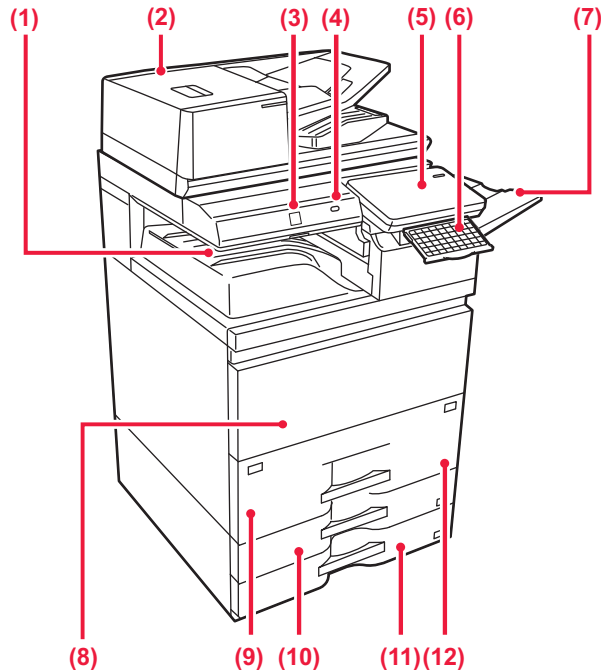

(1) Output tray (exit tray cabinet)*

Received faxes and printed papers are delivered to this tray.

(2) Automatic document feeder

It automatically feeds and scans multiple originals. 2-sided originals can be automatically scanned. Both sides of 2-sided originals can be automatically scanned at one time.

► [AUTOMATIC DOCUMENT FEEDER \(page 1-34\)](#)

(3) Motion sensor

This sensor detects the presence of a person that approaches the machine, and automatically wakes the machine from sleep mode (Motion Sensor Mode Only).

(4) USB port (A type)

This is used to connect a USB device such as a USB memory device to the machine. Supports USB 2.0 (Hi-Speed).

(5) Operation panel

This panel hosts the [Power] button, Information indicator and touch panel.

Use the touch panel to operate each of these functions. There is also an NFC touch point area mark.

► [OPERATION PANEL \(page 1-7\)](#)

(6) Keyboard

Use this as a substitute for the soft keyboard displayed on the touch panel. When not being used, it can be stored under the operation panel.

(7) Exit tray unit (right tray)*

Set this tray as the output tray if needed.

(8) Front cover

Open this cover to switch the main power switch to "On" or "Off" to replace a toner cartridge.

► [TURNING ON THE POWER \(page 1-10\)](#)

► [REPLACEMENT OF TONER CARTRIDGE \(page 1-77\)](#)

(9) Tray 1

Store paper in this tray.

► [LOADING PAPER IN THE TRAY 1/2 \(page 1-15\)](#)

(10) Tray 3

Store paper in this tray.

► [LOADING PAPER IN THE TRAY 3/4 \(page 1-19\)](#)

(11) Tray 4

Store paper in this tray.

► [LOADING PAPER IN THE TRAY 3/4 \(page 1-19\)](#)

(12) Tray 2

Store paper in this tray.

► [LOADING PAPER IN THE TRAY 1/2 \(page 1-15\)](#)

* Peripheral device.

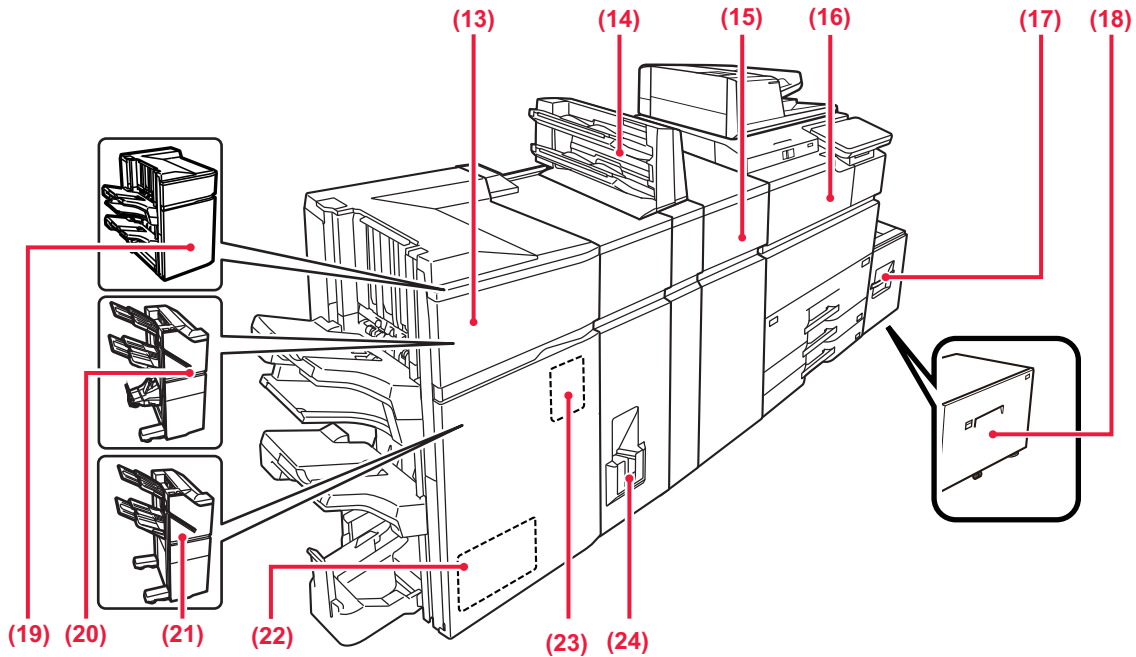

(13) Saddle Stitch Finisher (large stacker)*

This staples and folds paper. A punch module can also be installed to punch holes in output paper.

► [SADDLE STITCH FINISHER \(LARGE STACKER\)](#) (page 1-58)

(14) Inserter*

Covers and insertion sheets to be inserted into printed sheets can be loaded.

Using the manual finishing function, you can directly feed paper into the finisher (large stacker) or saddle stitch finisher (large stacker) to staple, punch or fold the paper.

(15) Curl correction unit*

This unit corrects curls in printed paper.

(16) Paper pass unit*

Relay between the machine and the finisher, finisher (large stacker), saddle stitch finisher or saddle stitch finisher (large stacker).

(17) Tray 5 (BP-LC11)*

Store paper in this tray.

► [LARGE CAPACITY TRAY \(BP-LC11\)](#) (page 1-23)

(18) Tray 5 (MX-LC19)*

Store paper in this tray.

► [LARGE CAPACITY TRAY \(MX-LC19\)](#) (page 1-24)

(19) Finisher (large stacker)*

This staples paper. A punch module can also be installed to punch holes in output paper.

► [FINISHER \(LARGE STACKER\)](#) (page 1-46)

(20) Saddle Stitch Finisher*

This staples and folds paper. A punch module can also be installed to punch holes in output paper. You can also perform stapling manually.

► [SADDLE STITCH FINISHER](#) (page 1-51)

(21) Finisher*

This staples paper. A punch module can also be installed to punch holes in output paper. You can also perform stapling manually.

► [FINISHER](#) (page 1-42)

(22) Trimming module*

This trims the excess of saddle-stitched output.

(23) Punch module*

This is used to punch holes in output. Requires a finisher, finisher (large stacker), saddle stitch finisher or saddle stitch finisher (large stacker).

(24) Folding unit*

This folds and outputs paper.

* Peripheral device.

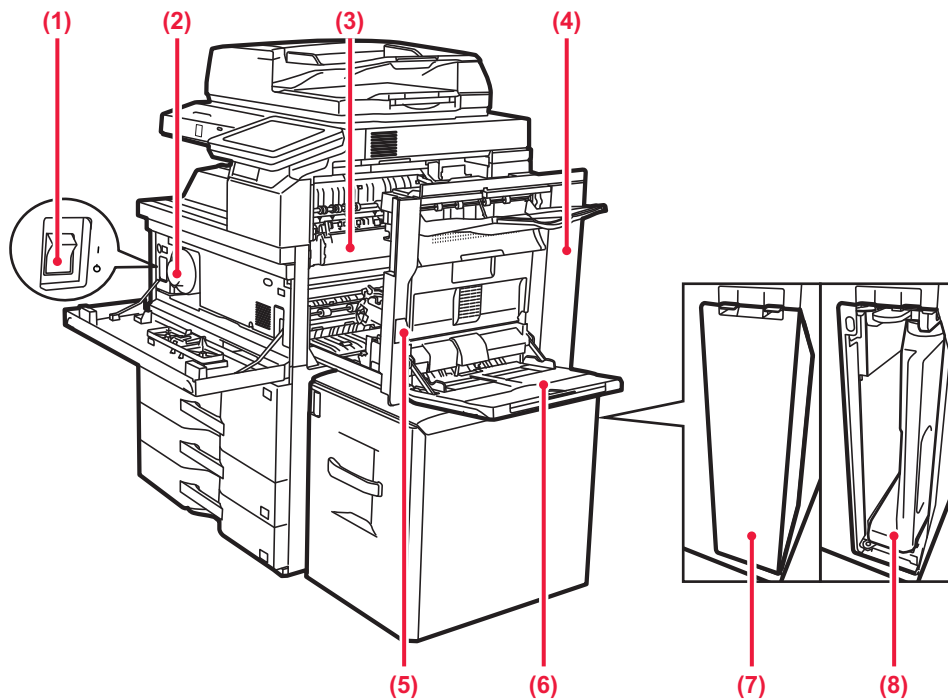

INTERIOR

**(1) Main power switch**

Use this switch to turn on the power for the machine. When using the fax or Internet fax functions, always keep this switch in the "I" position.

► [TURNING ON THE POWER \(page 1-10\)](#)

(2) Toner cartridge

This cartridge contains toner. When the toner in a cartridge runs out, replace with new one.

► [REPLACEMENT OF TONER CARTRIDGE \(page 1-77\)](#)

(3) Fusing unit

Heat is applied here to fuse the transferred image onto the paper

 The fusing unit is hot. Take care not to burn yourself when removing a misfeed.

(4) Right side cover

Open this cover to remove a paper misfeed.

(5) Right side cover release lever

To remove a paper misfeed, pull and hold this lever up to open the right side cover.

(6) Bypass tray

Use this tray to feed paper manually. When loading paper larger than 8-1/2" x 11"R or A4R, pull out the extension guide.

► [LOADING PAPER INTO THE BYPASS TRAY \(page 1-28\)](#)

(7) Cover for toner collection container

Open this cover when you need to replace the toner collection container.

(8) Toner collection container

This container collects excess toner that remains after printing

► [REPLACING THE TONER COLLECTION CONTAINER \(page 1-80\)](#)



A service technician collects replaced Toner collection container.



AUTOMATIC DOCUMENT FEEDER AND DOCUMENT GLASS

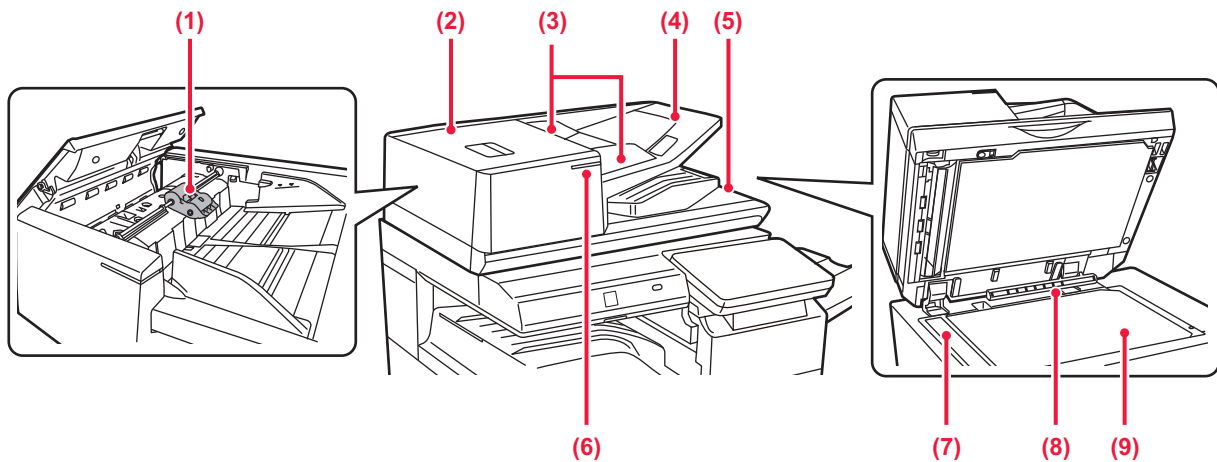

- (1) **Paper feed roller**
This roller rotates to automatically feed the original.
- (2) **Document feeding cover**
Open this cover to remove an original misfeed.
This cover is also opened to clean the paper feed roller.
► [CLEANING THE PAPER FEED ROLLER \(page 1-76\)](#)
- (3) **Original guides**
These guides help ensure that the original is scanned correctly.
Adjust the guides to the width of the original.
- (4) **Document feeder tray**
Place the original.
Place the original with the print side facing up.
► [AUTOMATIC DOCUMENT FEEDER \(page 1-34\)](#)
- (5) **Original exit tray**
The original is discharged to this tray after scanning.
- (6) **Original setting indicator**
This indicator lights when the document is correctly loaded on the document feeder tray.
► [ORIGINAL SETTING INDICATOR \(page 1-37\)](#)
- (7) **Scanning area**
Originals placed in the automatic document feeder are scanned here.
► [CLEANING THE DOCUMENT GLASS AND AUTOMATIC DOCUMENT FEEDER \(page 1-73\)](#)
- (8) **Original size detector**
This unit detects the size of an original placed on the document glass.
► [DOCUMENT GLASS \(page 1-38\)](#)
- (9) **Document glass**
If you want to scan books or other thick originals that cannot be fed through the automatic document feeder, place them on this glass.
► [DOCUMENT GLASS \(page 1-38\)](#)



SIDE AND BACK

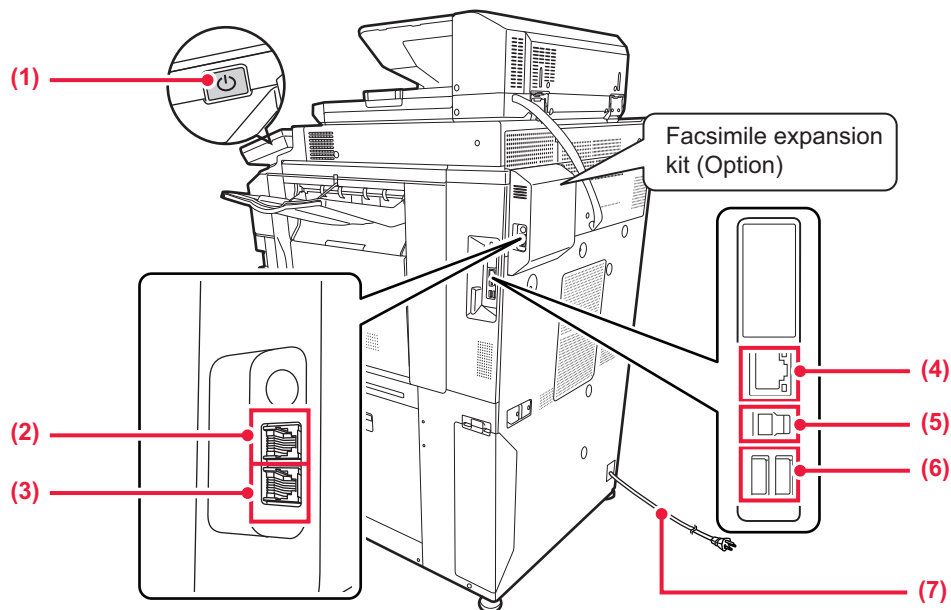

(1) [Power] button

Use this button to turn the machine's power on and off.
► [TURNING ON THE POWER \(page 1-10\)](#)

(2) External phone jack (TEL)*

When the fax function of the machine is used, an external phone can be connected to this jack.

(3) Telephone line jack (LINE)*

When the fax function of the machine is used, the telephone line is connected to this jack.

(4) LAN connector

Connect the LAN cable to this connector when the machine is used on a network.
Use a shielded LAN cable.

(5) USB port (B type)

The machine does not use this connector.

(6) USB port (A type)

This is used to connect a USB device such as a USB memory device to the machine.
Supports USB 2.0 (Hi-Speed) and USB3.0 (SuperSpeed).

(7) Power plug

* Peripheral device



OPERATION PANEL

This section describes the names and functions of the respective parts of the operation panel.

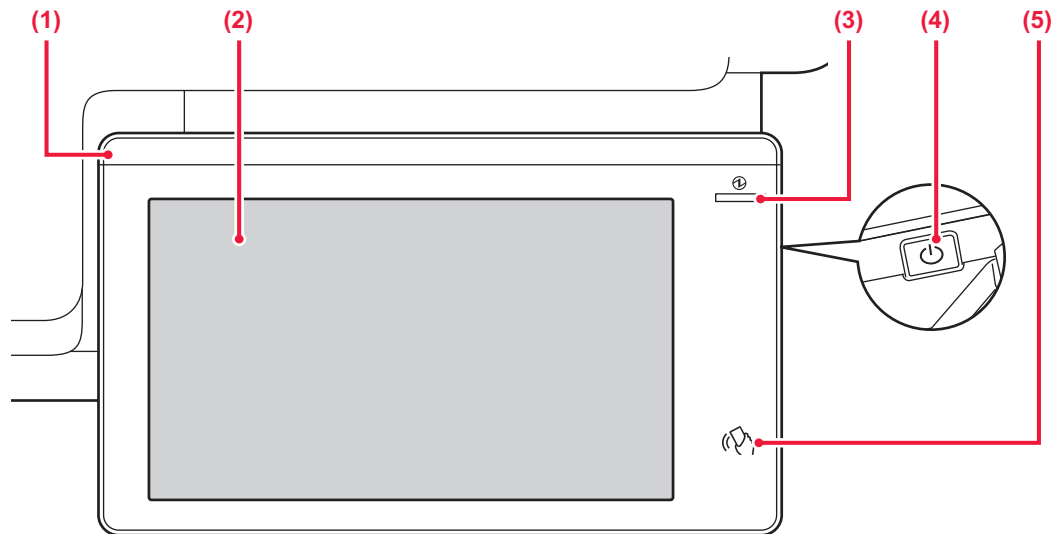

(1) Information indicator

This indicator illuminates when the power to the machine is turned on, and when a user logs in to the machine.

► [INFORMATION INDICATOR \(page 1-8\)](#)

(2) Touch panel

Messages and keys appear on the touch panel display. Operate the machine by directly tapping the displayed keys.

► [TOUCH PANEL \(page 2-2\)](#)

(3) Main power indicator

This indicator lights up when the machine's main power switch is in the "I" position.

Blinks blue during the time that the [Power] button does not operate immediately after the main power switch is switched on.

This indicator will also blink blue when receiving printer data.

This indicator blinks yellow during Auto Power Shut-Off mode.

► [TURNING ON THE POWER \(page 1-10\)](#)

(4) [Power] button

Use this button to turn the machine's power on and off.

► [TURNING ON THE POWER \(page 1-10\)](#)

(5) NFC touch point area

Mobile devices can be easily connected to the machine by touching the mobile device to the machine.

► [CONNECTING BY NFC \(page 9-37\)](#)



You can change the angle of the operation panel.

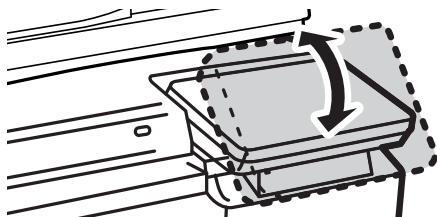

- The touch panel is a capacitance type.
- Use your finger to operate the touch panel. If you operate it with a pen, it may not work properly. Also, be aware that precious metals such as accessories may cause unintended touch movements.
- Do not touch the touch panel while the unit is starting up. If you touch the touch panel, it may not operate normally.
Example:
Turn on the main power switch, press the [Power] button, and wait until the home screen is displayed.
Returning from auto power shutoff.



INFORMATION INDICATOR

When turning the machine power ON/OFF; at user authentication when the user has logged in using IC card or NFC; when connecting USB memory to the machine; when starting a job on the machine control panel; or during image adjustment or when adding toner; a fax is being received or an error has occurred in the machine, the LED lights blue, white and orange in response to the request/operation from the user to communicate to the user the machine status.



This light is used to communicate with users in front of the machine, therefore this is not lit as a result of remote operations.

Lighting patterns

Lighting patterns differ depending on status.

Lighting color	Lighting patterns	Status
Blue	Lighting pattern 1	When the power is turned on by user operation or motion sensor, when the power is turned off by user operation, when the power is restored from sleep mode* ¹ , when the power is shifted to sleep mode* ¹ , and when a job (copy, scan, fax) is started by the operation panel.
	Lighting pattern 2	During user authentication, at user login using an IC card or NFC Insertion of USB memory into the machine
	Lighting pattern 3	When users are made to wait, during image quality adjustment or adding toner
White	Blinks	A fax is being received. when the exit tray unit (right tray) is used for output, this blinks until the output is removed.
Orange	Solidly* ²	Errors that do not stop machine operation, such as replacement timing of the toner collection container.
	Blinks* ²	Errors that stop machine operation, such as misfeeds and out of toner.

*1 The information lamp lights up when the power is turned on or off directly by the user, or when the machine is restored from sleep mode. The information lamp does not light up when the printer is not operated directly by the user, such as when receiving a print job or when the scheduled auto power shut-off is turned on or off.

*2 If the lighted state and the blinking state overlap, the blinking state takes priority.

Lighting pattern 1

After lighting sporadically, all lights come on together, and then turn off.

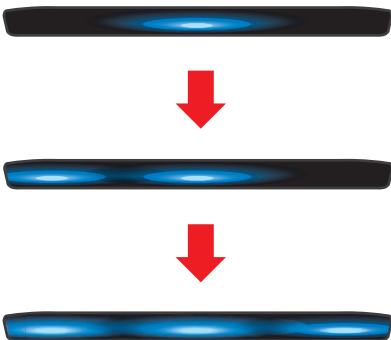

Lighting pattern 2

The center light comes on, the left and right lights come on, then the center light turns off.

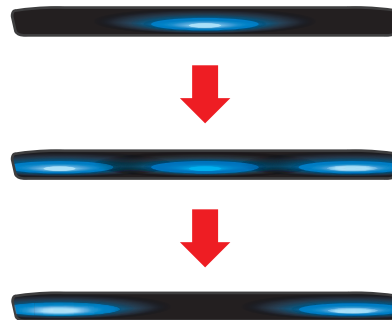



Lighting pattern 3

Lights come on in succession, from the left lamp to the right lamp.



- If there are multiple lighting patterns for the information indicator, then that which is later has priority. The previous information indicator lighting pattern turns off, then the information indicator lights in accordance with the later generated lighting pattern.
- However, if lighting pattern 3 and another lighting pattern overlap, then lighting pattern 3 will have priority, and the other pattern will not be received until lighting pattern 3 is completed.



TURNING ON THE POWER

This section describes how to turn on/off the machine's power and how to restart the machine.

Operate two power switches: the main power switch inside the front cover, located in the lower left corner, and the [Power] button on the operation panel.

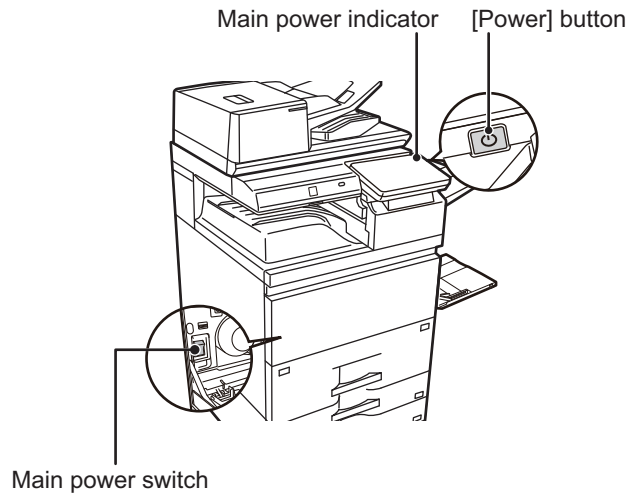

- When turning off the main power switch, be sure to press the [Power] button on the operation panel, tap the [Turn off] key on the touch panel, and then set the main power switch to the "⏻" position.
- In a sudden case of main power outage, turn the power for the machine back on and then turn it off in the correct order. If the machine is left for a long time with the main power having been turned off prior to the [Power] button being turned off, abnormal noises, degraded image quality or other problems may result.
- Turn off both the [Power] button and the main power switch and unplug the power cord if you suspect a machine failure, if there is a bad thunderstorm nearby, or when you are moving the machine.



- When using the fax or Internet fax function, always keep the main power switch in the " | " position.
- If the fax function will be used, and in particular if reception or timer transmission will take place at night, do not turn the main power off.
- In order for some settings to take effect, the machine must be restarted. In some states of the machine, restarting with the [Power] button may not make the settings take effect. In this case, turn off the main power switch and then turn it on again.

TURNING ON THE POWER

- Turn the main power switch to the " | " position.
- When the main power indicator lights in blue, press the [Power] button.

TURNING OFF THE POWER

After pressing the [Power] button, tap the [Turn off] key on the touch.

To turn off the power for a long time, press the [Power] button to turn off the power, and after the screen display on the operation panel disappears, set the main power switch to the "⏻" position.

RESTART THE MACHINE

Press the [Power] button to turn off the power, and then tap the [Turn off] key on the touch panel. After that, press the [Power] button again to turn on the power.



LOADING PAPER

IMPORTANT POINTS ABOUT PAPER

NAMES AND LOCATIONS OF TRAYS

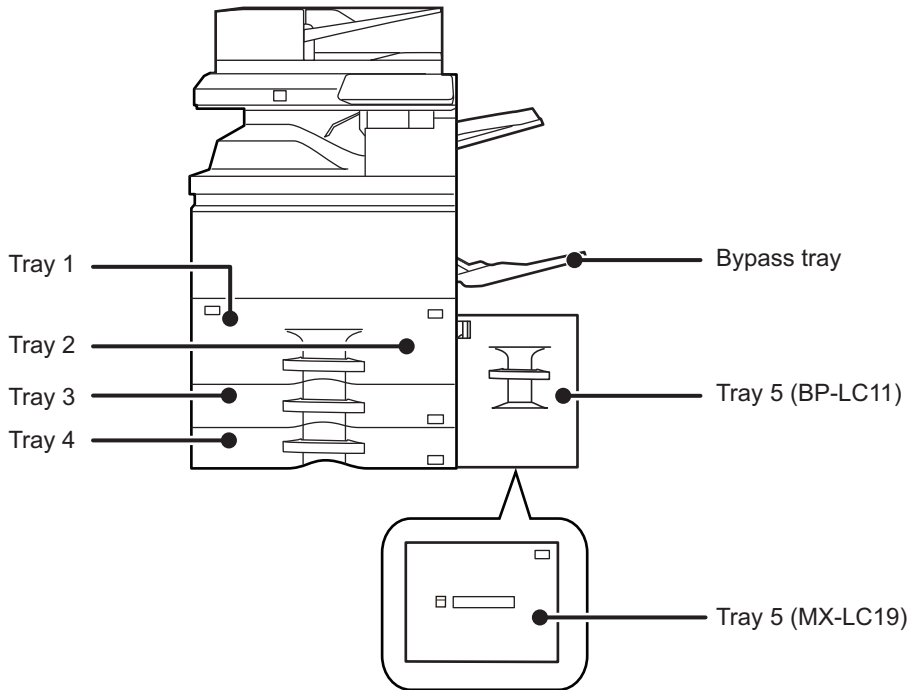

THE DEFINITION OF "R" IN PAPER SIZE

To indicate the landscape setting, "R" is added to the end of the name of a paper size enabled for both landscape and portrait settings.

Paper that can be set either in the portrait or landscape orientation		Paper that can only be set in the landscape orientation
8-1/2" x 11", A4, B5		12" x 18", 11" x 17", 8-1/2" x 14", 8-1/2" x 13", A3W, A3, B4
Paper set in the landscape orientation	Paper set in the portrait orientation	Can be placed only in the landscape orientation
<div style="border: 1px solid black; padding: 5px; width: fit-content; margin: 0 auto;">8-1/2" x 11" (A4R)</div>	<div style="border: 1px solid black; padding: 5px; width: fit-content; margin: 0 auto;">8-1/2" x 11" (A4)</div>	<div style="border: 1px solid black; padding: 5px; width: fit-content; margin: 0 auto;">11" x 17" (A3)</div>



APPLICABLE PAPER TYPES

This section describes paper types that can be used and those that cannot be used. All types of paper other than plain paper are referred to as special media.



- Various types of paper are commercially available, some of which cannot be used on the machine. Before using any paper, consult the dealer or nearest SHARP Service Department.
- The image quality and toner fusibility of paper may change due to ambient conditions, operating conditions, and paper characteristics, resulting in image quality inferior to that of Sharp standard paper. Before using any paper, consult the dealer or nearest SHARP Service Department.
- The use of non-recommended or non-usable paper may result in skewed feeding, misfeeds, poor toner fusing (the toner does not adhere to the paper well and can be rubbed off), or machine failure.
- The use of non-recommended paper may result in misfeeds or poor image quality. Before using non-recommended paper, check whether printing can be performed properly.

Useable paper

Specifications of plain paper, heavy paper and thin paper

Plain Paper*	Plain Paper 1	16 lbs. bond to 24 lbs. bond (60 g/m ² to 89 g/m ²)
	Plain Paper 2	24 lbs. bond to 28 lbs. bond (90 g/m ² to 105 g/m ²)
Heavy paper	Heavy paper 1	28 lbs. bond to 65 lbs. cover (106 g/m ² to 176 g/m ²)
	Heavy paper 2	65 lbs. cover to 80 lbs. cover (177 g/m ² to 220 g/m ²)
	Heavy paper 3	80 lbs. cover to 140 lbs. index (221 g/m ² to 256 g/m ²)
	Heavy paper 4	140 lbs. index to 110 lbs. cover (257 g/m ² to 300 g/m ²)
Thin paper		13 lbs to 16 lbs (55 g/m ² to 59 g/m ²)

* If the paper that you normally use is Recycled, Pre-Punched, Pre-Printed, Letter Head, Color, or User Type 1 to 8, set an appropriate paper weight in "Settings" – [System Settings] → [Common Settings] → [Paper Settings] → [Paper Tray Settings] → [Paper Weight].



- The category of "Useable paper" is based on Sharp standard paper.
- If non-recommended paper is used, print quality may be affected even if a paper type setting that accords with the above paper divisions is selected. In that case, try setting the paper type to a type that is slightly heavier or slightly lighter than normal. For more information, consult the dealer or nearest SHARP Service Department.
- For paper specifications, see the specifications in the "Start Guide".
- Recycled paper, colored paper and pre-punched paper must meet the same specifications as plain paper. Before using any paper, consult the dealer or nearest SHARP Service Department.
- If the paper that was output is significantly curled, remove the paper from the cassette, turn the paper over so it is face down, and resume use.

Paper that can be used for the fax function

5-1/2" x 8-1/2"R, 8-1/2" x 11", 8-1/2" x 11"R, 8-1/2" x 13", 8-1/2" x 13-2/5", 8-1/2" x 14", 11" x 17", A4, A4R



Specifications of paper that can be used for two-sided printing

Paper Type	Plain, Recycled, Color, Letter Head, Pre-Printed, Punched, Heavy Paper (28 lbs. bond (106 g/m ²) to 140 lbs. index (220 g/m ²))
Paper Size	12" x 18", 11" x 17", 8-1/2" x 14", 8-1/2" x 13-1/2", 8-1/2" x 13-2/5", 8-1/2" x 13", 8-1/2" x 11", 8-1/2" x 11"R, 7-1/4" x 10-1/2"R, 5-1/2" x 8-1/2"R, A3W, A3, B4, A4, A4R, B5, B5R, A5R

Types of paper that can be set in each tray



- For detailed information on the sizes and types of paper that can be loaded into each tray of the machine, see "SPECIFICATIONS" in the "Start Guide" and "[Paper Tray Settings \(page 10-135\)](#)".
- Recycled paper, colored paper and pre-punched paper must meet the same specifications as plain paper. Before using any paper, consult the dealer or nearest SHARP Service Department.

	Tray 1/2	Tray 3	Tray 4	Tray 5* ¹	Bypass tray
Plain Paper 1* ²	Permitted	Permitted	Permitted	Permitted	Permitted
Plain Paper 2* ²	Permitted	Permitted	Permitted	Permitted	Permitted
Heavy Paper 1* ³	-	Permitted	Permitted	Permitted	Permitted
Heavy Paper 2* ³	-	Permitted	Permitted	Permitted	Permitted
Heavy Paper 3* ³	-	-	-	-	Permitted
Heavy Paper 4* ³	-	-	-	-	Permitted
Thin Paper	-	-	-	-	Permitted
Pre-Printed	Permitted	Permitted	Permitted	Permitted	Permitted
Recycle Paper	Permitted	Permitted	Permitted	Permitted	Permitted
Letter Head	Permitted	Permitted	Permitted	Permitted	Permitted
Pre-Punched	Permitted	Permitted	Permitted	Permitted	Permitted
Color	Permitted	Permitted	Permitted	Permitted	Permitted
Labels	-	-	Permitted	-	Permitted
Glossy Paper	-	-	-	-	Permitted
Transparency	-	-	Permitted	-	Permitted
Tab Paper	-	-	Permitted	-	Permitted

*1 when a large capacity tray (BP-LC11/MX-LC19) is installed

*2 "Plain Paper 1" is plain paper 16 to 24 lbs. bond (60 to 89 g/m²), "Plain Paper 2" is plain paper 24 to 28 lbs. bond (90 to 105 g/m²).

*3 "Heavy Paper 1" is heavy paper up to 65 lbs. cover (176 g/m²), "Heavy Paper 2" is heavy paper up to 80 lbs. cover (220 g/m²), "Heavy Paper 3" is heavy paper up to 140 lbs. index (256 g/m²), and "Heavy Paper 4" is heavy paper up to 110 lbs. cover (300 g/m²).

**Setting orientation of the print side**

The setting orientation varies for the print side of paper, depending on the tray used. For "Letter Head" and "Pre-Printed", set the paper in the reverse orientation.

Place with the print side facing the direction indicated below.

Tray	In normal status	With letter head or pre-printed paper set
Trays 1 - 4	Facing up	Facing down
Bypass, Tray 5	Facing down	Facing up



When [Disabling of Duplex] is set for "Letter Head" or "Pre-Printed", set the print side in the same orientation as for the ordinary operation.

Paper that cannot be used

- Embossed
- Envelope
- Special media for an ink jet printer (fine paper, glossy paper, glossy film, etc.)
- Carbon paper or thermal paper
- Pasted paper
- Paper with clips
- Paper with fold marks
- Torn paper
- Oil-feed transparency film
- Thin paper less than 15 lbs (55 g/m²)
- Heavy paper as thick as 110 lbs. cover (300 g/m²) over
- Irregularly shaped paper
- Stapled paper
- Damp paper
- Curled paper
- Paper whose print side or reverse side has been already printed on by printer or multifunction device.
- Paper with a wave-like pattern due to moisture absorption
- Paper with creases
- Paper with dust

Non-recommended paper

- Iron-on transfer paper
- Perforated paper



LOADING PAPER IN THE TRAY 1/2

A maximum of 1250 sheets of 8-1/2" × 11" (A4) paper can be loaded into tray 1.

A maximum of 850 sheets of 8-1/2" × 11" (A4) paper can be loaded into tray 2.



If you loaded paper of a different type or size from the paper previously loaded, be sure to check the settings in "Settings (administrator)". An incorrect setting may cause print failure, printing on paper of an incorrect size, or type or paper misfeeds.



Do not place heavy objects on the tray or press down on the tray.



To check the type and size of paper:

[Tray Settings] in the home screen or in "Settings", select [Status] → [Machine Identification] → [Paper Input Tray Status].

To set the type and size of paper:

Set this in [Tray Settings] in the home screen or in "Settings", select [System Settings] → [Common Settings] → [Paper Settings] → [Paper Tray Settings].

1

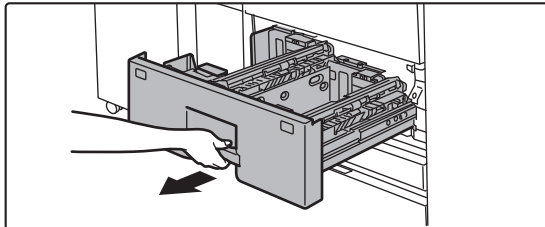

Pull out the paper tray.

Gently pull the tray out until it stops.



Keep holding the handle until the lock is released.

2

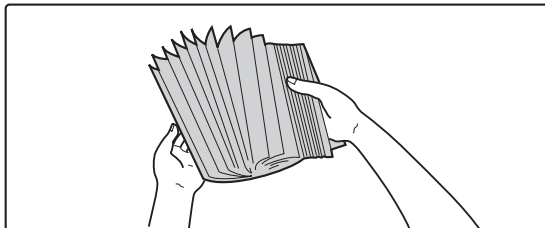

Fan the paper.

Fan the paper well before loading it. If the paper is not fanned, multiple sheets may feed at once and cause a misfeed.



3

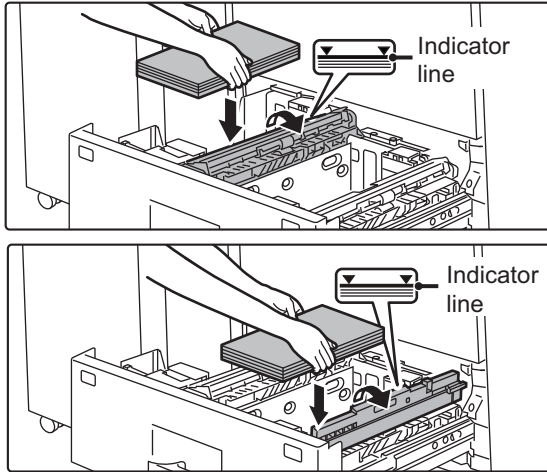

Lift the feed roller, and place paper into the tray.

Load the paper with the print side facing up. The stack must not be higher than the indicator line (maximum of 1250 sheets for tray 1, or maximum of 850 sheets for tray 2). Do not load the paper as shown below.



4

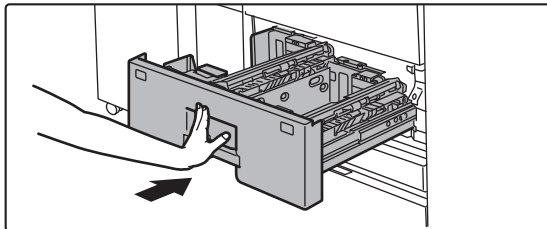

Lower the feed roller, and gently push the paper tray into the machine.

Push the tray firmly all the way into the machine slowly. Forcefully inserting the paper may cause skewed feeding and paper misfeeds.



CHANGING THE PAPER SIZE

1

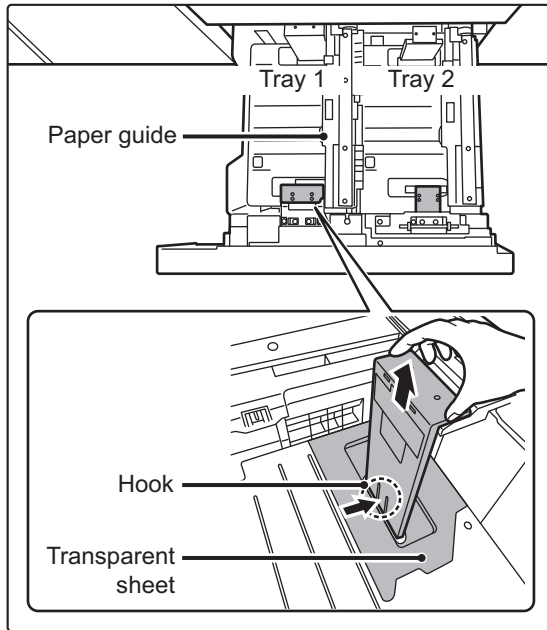

Remove the paper size guide.

With the base of the tray pressed all the way down, hold down the hook at the bottom on the paper size guide and pull the paper size guide up slightly.



Before changing the paper size of tray 2, raise the paper guide.

2

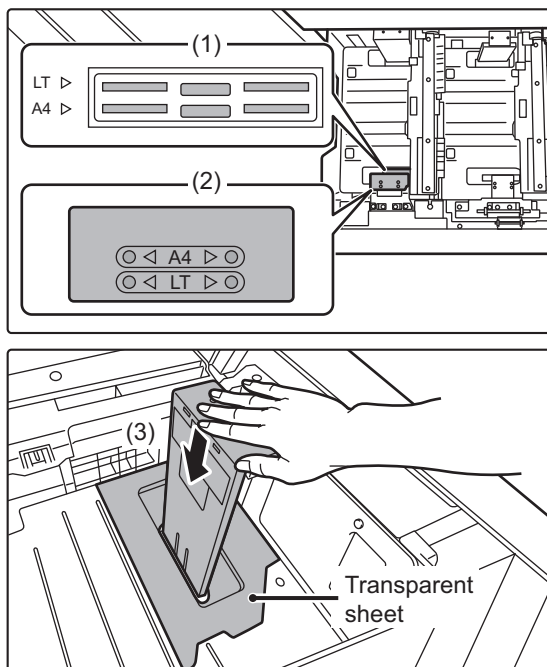

Attach the paper size guide and transparent sheet appropriately for the size of paper to be used.

- (1) **Align the bottom of the paper size guide with the appropriate slot on the base of the tray.**

Align the paper size guide with the slot for the paper size to be used (indicated by the paper size mark).

- (2) **Align the holes at the top of the paper size guide with the protrusions that secure the paper size guide.**

Align with the holes for the paper size to be used (indicated by the paper size mark).

- (3) **Push in the paper guide so that it locks into place.**

Push the paper size guide in until the hook at the bottom locks into place. (You will hear a "click" when the hook locks.) Move the paper size guide slightly to verify that it has locked into place.



- When attaching the paper size guide, place the transparent sheet in direct contact with the base of the tray in the correct orientation as shown.
- The slot or hole with the "LT" mark is for 8-1/2" x 11" size.



When attaching the paper size guide, make sure that the top and bottom of the guide are aligned to the same paper size. If the top and bottom of the paper size guide are not aligned to the same paper size, skewed feeding and misfeeds will result.

3

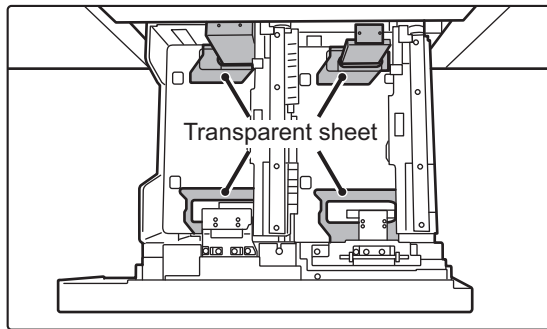

Repeat steps 1 and 2 to adjust the far paper guide to the paper size to be used.

Be sure to adjust the far paper guide to the same size as the near paper guide.

When removing and attaching the far paper size guide, take care not to hit the front cover of the machine.



Adjusting only one paper guide may result in skewed feeding or misfeeds.

4

Set the paper size and paper type.

Be sure to set the paper size and paper type by selecting [Tray Settings] in the home screen or in "Settings", select [System Settings] → [Common Settings] → [Paper Settings] → [Paper Tray Settings].

If the paper size setting is not configured correctly, automatic paper selection will not operate correctly and printing may take place on the wrong size or type of paper or a misfeed may occur.



LOADING PAPER IN THE TRAY 3/4

A maximum of 500 sheets of paper from 11" x 17" to 7-1/4" x 10-1/2"R (A3 to B5R) can be loaded into tray 3.
A maximum of 500 sheets of paper from 11" x 17" to 5-1/2" x 8-1/2"R (A3 to A5R) can be loaded into tray 4.



- Other than plain paper, special media such as transparency film and tab paper can be loaded into tray 4. To load tab paper, the dedicated guide must be installed.
- If you loaded paper of a different type or size from the paper previously loaded, be sure to check the settings in "Settings (administrator)". An incorrect setting may cause print failure, printing on paper of an incorrect size, or type or paper misfeeds.



Do not place heavy objects on the tray or press down on the tray.



To check the type and size of paper:

[Tray Settings] in the home screen or in "Settings", select [Status] → [Machine Identification] → [Paper Input Tray Status].

To set the type and size of paper:

Set this in [Tray Settings] in the home screen or in "Settings", select [System Settings] → [Common Settings] → [Paper Settings] → [Paper Tray Settings].

1

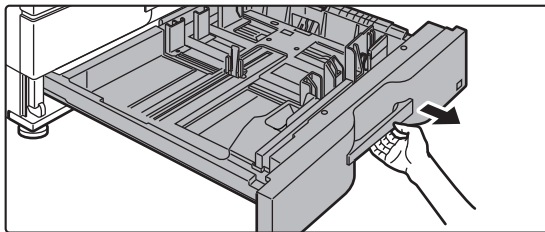

Pull out the paper tray.

Gently pull the tray out until it stops.

To load paper, go to step 3.

To load a different size of paper, go to the next step.



Keep holding the handle until the lock is released.

2

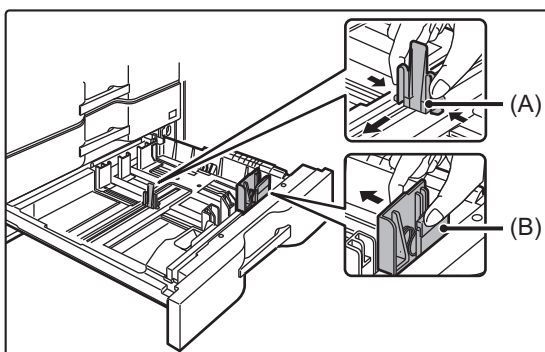

Adjust guide plates A and B by squeezing their lock levers and sliding them to match the longitudinal and transversal dimensions of the paper to be loaded.

The guide plates A and B are slidable. Slide each guide plate while squeezing its lock lever to adjust to the paper size.



A non-standard size of paper can only be loaded in tray 4. A non-standard size of paper cannot be loaded in tray 3.

3

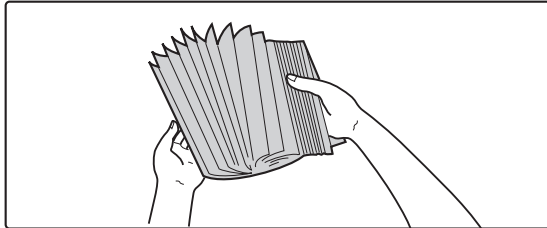

Fan the paper.

Fan the paper well before loading it. If the paper is not fanned, multiple sheets may feed at once and cause a misfeed.

4

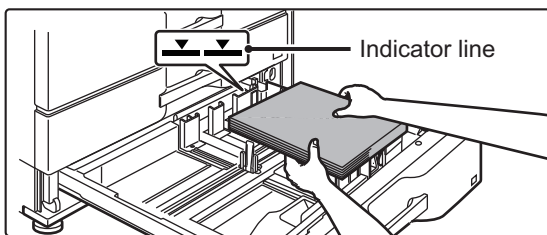

Insert the paper into the tray.

Load the paper with the print side facing up. The stack must not be higher than the indicator line (maximum of 500 sheets).

Do not load the paper as shown below.



5

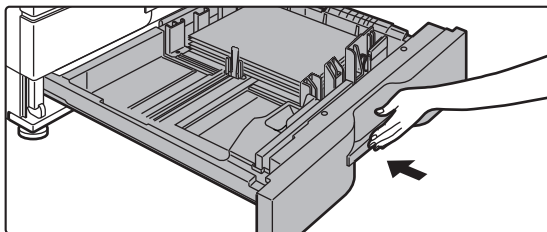

Gently push the paper tray into the machine.

Push the tray firmly all the way into the machine slowly. Forcefully inserting the paper may cause skewed feeding and paper misfeeds.



LOADING TAB PAPER INTO TRAY 4

1

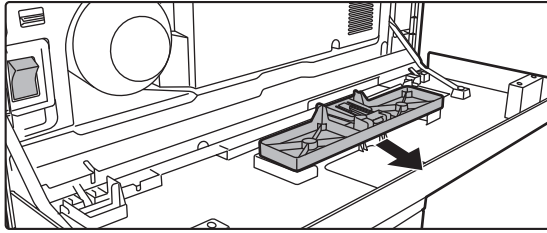

Remove the tab paper guide.

The guide is stored inside the front cover.

2

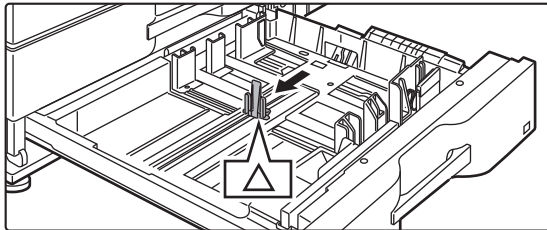

Pull out the tray and install the guide.

Adjust the guide plates to the triangle mark position.

Install the guide so that it may cover the guide plates.

Adjust the guide plates in the tray to match the longitudinal and transversal dimensions of the paper to be loaded.

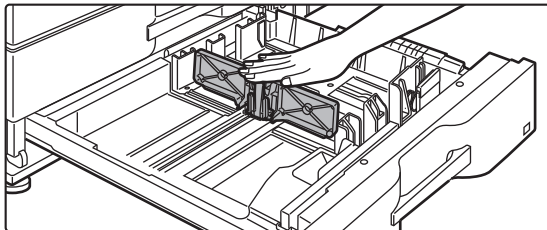
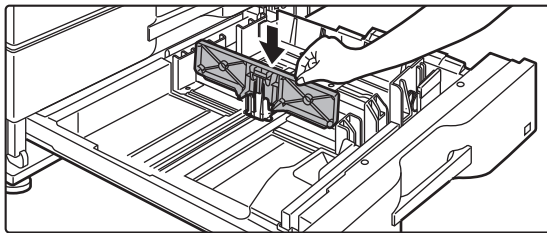

3

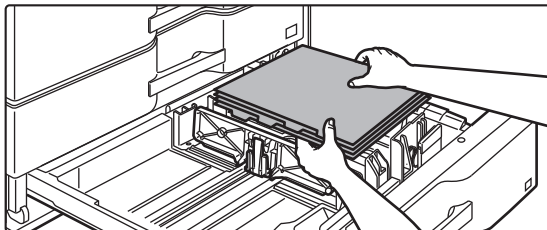

Insert the tab paper into the tray.

Place the tab paper with the print side facing up so that the tab is to the left.



See the following figure and adjust the tab position of the tab paper.

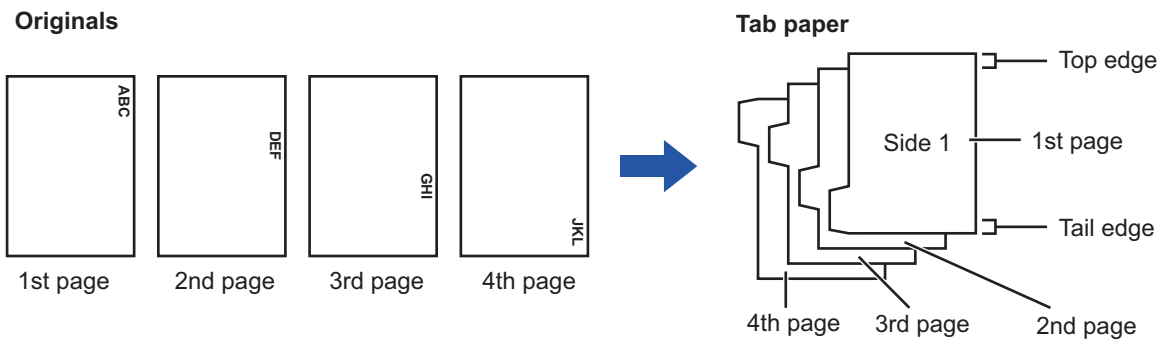

4

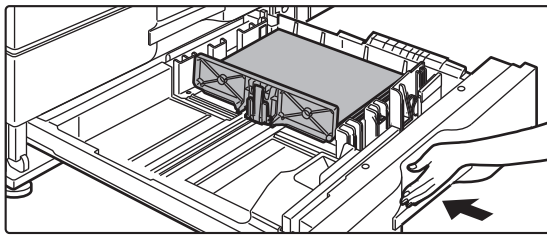

Gently push the tray into the machine, and set the paper type to tab paper.

Using "Paper Tray Settings" in the system settings, set the paper type to tab paper.



To set the paper type to tab paper:

Set this in [Tray Settings] in the home screen or in "Settings", select [System Settings] → [Common Settings] → [Paper Settings] → [Paper Tray Settings].



LOADING PAPER IN THE LARGE CAPACITY TRAY

Use the large capacity tray for outputting massive prints that cannot be processed using the regular tray.

- Large capacity tray (BP-LC11) stores a maximum of 3500 sheets of 8-1/2" × 11" and A4 paper.
- Large capacity tray (MX-LC19) stores a maximum of 3000 sheets of paper from 12" × 18" (A3W) to 8-1/2" × 11"R (B5).

When changing the paper size, consult the dealer or nearest SHARP Service Department.



Do not place heavy objects on the tray or press down on the tray.



To check the type and size of paper:

[Tray Settings] in the home screen or in "Settings", select [Status] → [Machine Identification] → [Paper Input Tray Status].

To set the type and size of paper:

Set this in [Tray Settings] in the home screen or in "Settings", select [System Settings] → [Common Settings] → [Paper Settings] → [Paper Tray Settings].

LARGE CAPACITY TRAY (BP-LC11)

1

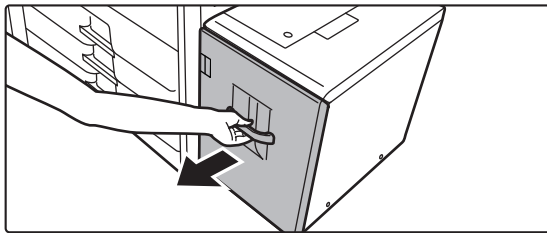

Pull out the paper tray.

Gently pull the tray out until it stops.

2

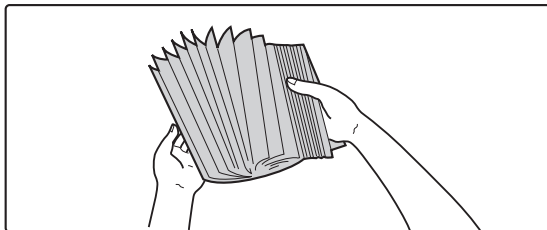

Fan the paper.

Fan the paper well before loading it. If the paper is not fanned, multiple sheets may feed at once and cause a misfeed.

3

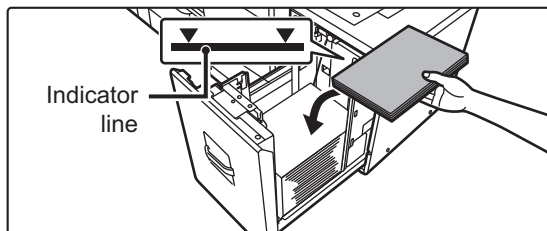

Place the paper in the center of the paper table.

Load the paper with the print side facing up. The stack must not be higher than the indicator line (maximum of 3500 sheets).



4

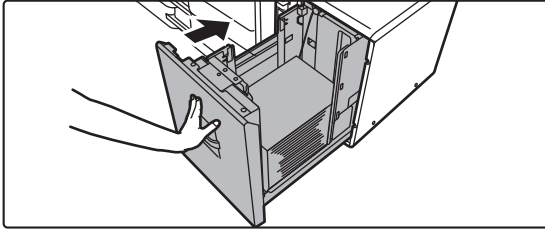

Gently push the paper tray into the machine.

Push the tray firmly all the way into the machine slowly. Forcefully inserting the paper may cause skewed feeding and paper misfeeds.

LARGE CAPACITY TRAY (MX-LC19)

1

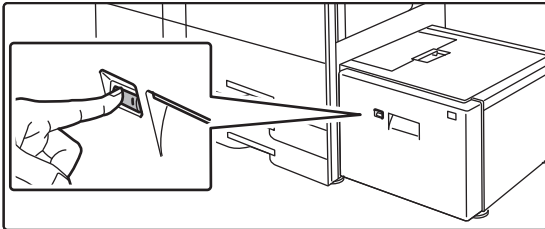

Press the operation button.

The operation button blinks, and the tray paper table goes down to the paper loading position. Wait until the operation button light goes off.



Do not pull out the tray until the light goes off. If you pull out the tray forcibly while the button lights up or blinks, a machine failure may be resulted.

2

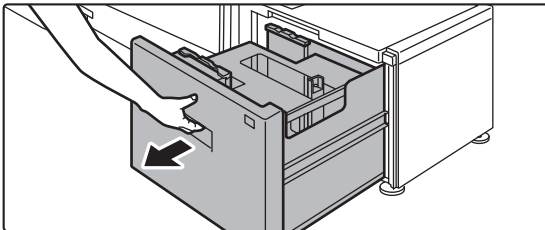

Pull out the paper tray.

Gently pull the tray out until it stops.

3

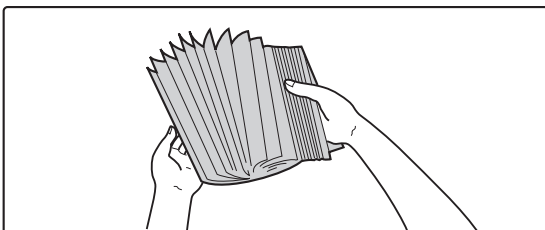

Fan the paper.

Fan the paper well before loading it. If the paper is not fanned, multiple sheets may feed at once and cause a misfeed.



4

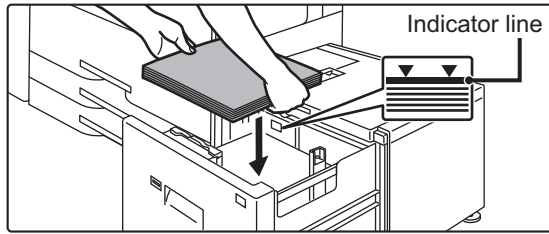

Place the paper in the center of the paper table.

Load the paper with the print side facing up. The stack must not be higher than the indicator line (maximum of 3000 sheets).

When a certain volume of paper is loaded, the paper table automatically goes down slightly and stops. Repeat this operation in the same way to load paper.



- Do not insert your hand into the space inside the paper table when you load paper.

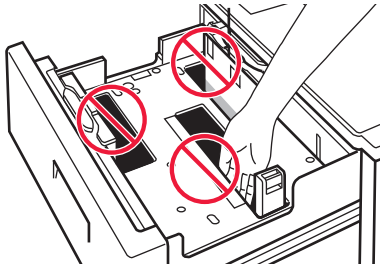

- Do not insert spare paper or objects into the space inside the tray.

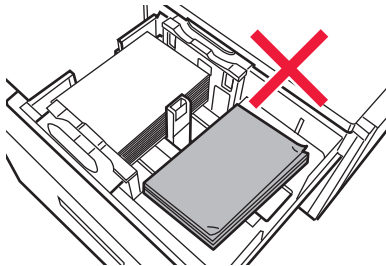

5

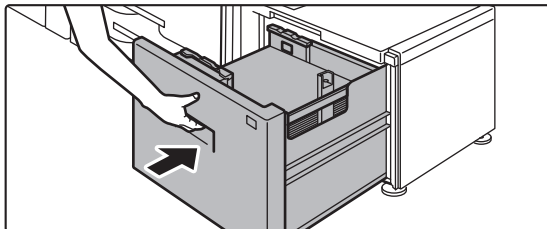

Gently push the paper tray into the machine.

Push the tray firmly all the way into the machine slowly. Forcefully inserting the paper may cause skewed feeding and paper misfeeds.

The paper table goes up after the tray is pushed in. The operation button blinks while the paper table goes up. The button lights up when the paper table has gone up.



Changing the paper size for the large capacity tray (MX-LC19)

1

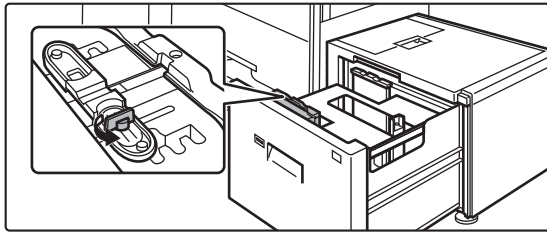

Loosen the paper guide screw.

2

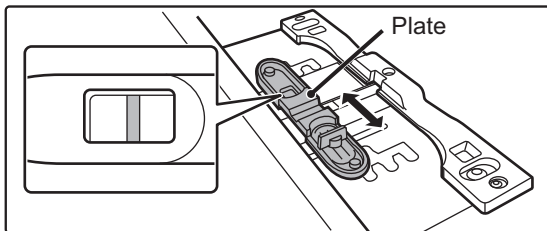

Slide the plate of the paper guide.

Slide the plate until the red line appears at the center of the size window of the plate.

3

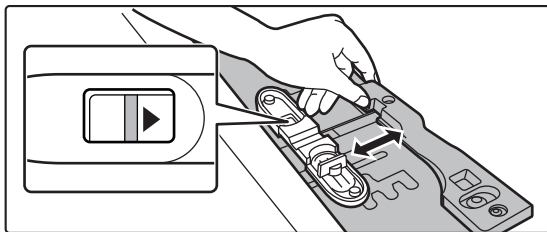

Adjust the paper guide to the paper size that will be used.

Slide the paper guide forward or backward until the size mark of the paper to be used (◀ or ▶) appears in the size window of the plate.

4

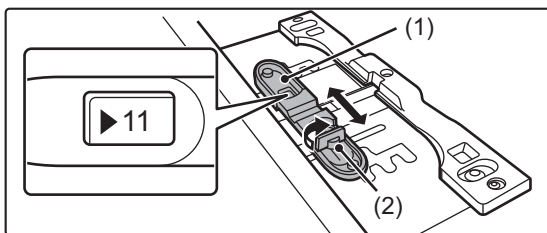

Secure the paper guide.

(1) Slide the plate of the paper guide.

Slide the plate until the paper size to be used appears in the size window of the plate.

(2) Tighten the paper guide screw.

5

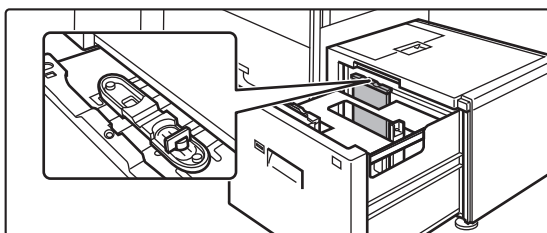

Repeat steps 1 through 4 to adjust the far paper guide to the paper size to be used.

Be sure to adjust the far paper guide to the same paper size as the near paper guide.



Adjusting only one paper guide may result in skewed feeding or misfeeds.



6

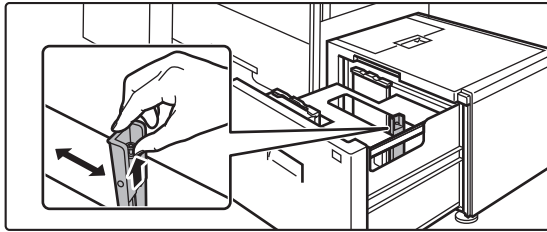

Change the right paper guide to the paper size to be used.

- (1) **While holding up the paper guide lock, slide the paper guide to the paper size to be used.**
- (2) **Release the paper guide lock.**
- (3) **Move the paper guide slightly to the right and left so that it locks into place.**

You will hear a "click" when the paper guide locks.

7

Set the paper size and paper type.

Be sure to set the paper size and paper type by selecting [Tray Settings] in the home screen or in "Settings", select [System Settings] → [Common Settings] → [Paper Settings] → [Paper Tray Settings].

If the paper size setting is not configured correctly, automatic paper selection will not operate correctly and printing may take place on the wrong size or type of paper or a misfeed may occur.



LOADING PAPER INTO THE BYPASS TRAY

Use the bypass tray for printing on plain paper, label sheets, tab paper, and other special media.

Up to 100 sheets of paper can be loaded (Heavy paper weighing between 28 lbs. bond and 140 lbs. index (106 g/m² and 256 g/m²): 40 sheets, heavy paper weighing between 140 lbs. index and 110 lbs. cover (257 g/m² and 300 g/m²), transparency film, and tab paper: 20 sheets) for continuous printing, just like operation using other trays.



- When using plain paper other than Sharp standard paper or special media other than SHARP-recommended transparency film, glossy paper, or when printing on the reverse side of paper that has been printed on one side, load paper one sheet at a time. Loading more than one sheet at a time will cause misfeeds.
- Before loading paper, straighten any curling in the paper.
- When adding paper, remove any paper remaining in the bypass tray, combine it with the paper to be added, and reload as a single stack. If paper is added without removing the remaining paper, a misfeed may result. Loading more sheets than the specified number of sheets or the limit may cause paper misfeeds.

HOW TO LOAD THE PAPER

Load paper up to 7-1/4" x 10-1/2" (A5) size in landscape orientation.

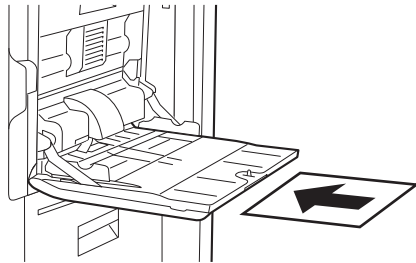

LOADING TAB PAPER

To print on tab paper, load tab paper into the bypass tray with the print side facing down.

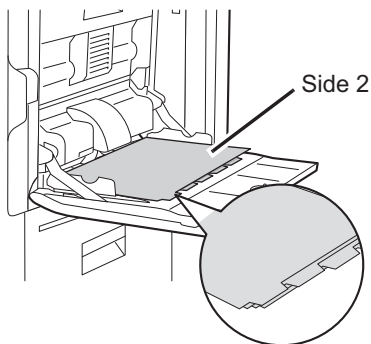

- Use only tab paper that is made of paper. Tab paper made of a material other than paper (film, etc.) cannot be used.
- To print on the tabs of tab paper:
In copy mode, use [Tab Copy] in "Others". In print mode, use the tab print function.



INSERTING TRANSPARENCY FILM



- Use SHARP-recommended transparency film.
- When loading multiple sheets of transparency film into the bypass tray, fan the sheets several times before loading.
- When printing on transparency film, remove each sheet as it is printed and output from the machine. If multiple sheets of film are allowed to stack on the output tray, the sheets may stick together or become curled.

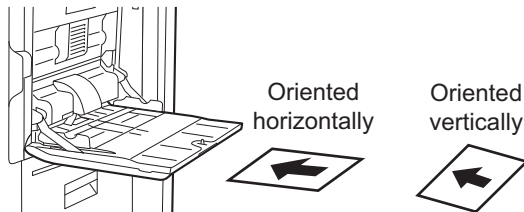

Important points when using label sheets

- Some labels may have to be loaded into the bypass tray in the specified orientation. Follow such instructions. If a form is already printed on the labels, and the print images and the preprinted form do not line up, adjust the application or printer driver settings to rotate the print images.
- Do not use the following types of label sheets.
 - Label sheets without an adhesive copy or label copy
 - Label sheets with adhesive exposed
 - Label sheets with a specified feeding direction that is not supported by the machine
 - A label sheet that has already been fed or has some labels removed
 - Label sheets consisting of multiple sheets
 - Label sheets that do not support laser printing
 - Label sheets that cannot withstand heat
 - Label sheets that have perforations in the backing paper
 - Label sheets with slits in the backing paper
 - Non-standard label sheets
 - Label sheets with adhesive that has deteriorated due to prolonged storage or otherwise
 - Label sheets with cutouts that expose the backing paper
 - Curled or otherwise deformed label sheets
 - Torn or creased label sheets
 - Label sheets consisting of three sheets or more.



1

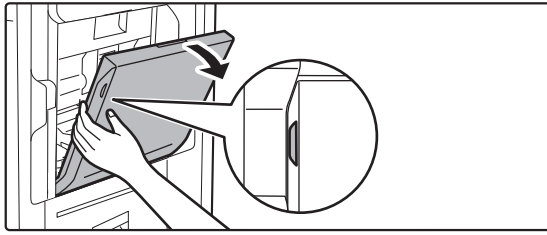

Open the bypass tray.

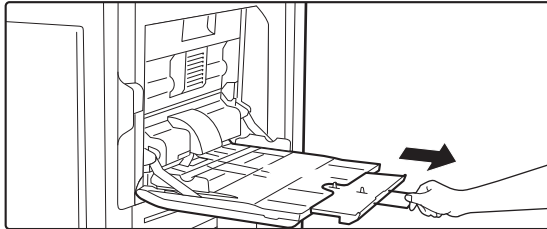

When loading paper larger than 8-1/2" x 11"R or A4R, pull out the extension guide.
Pull the extension guide all the way out.



Do not place heavy objects on the bypass tray or press down on the tray.

2

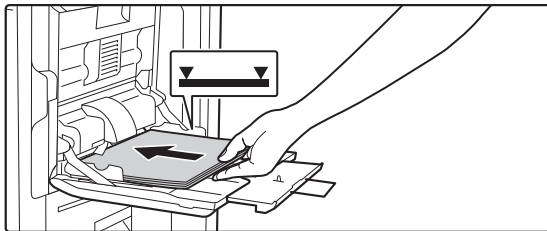

Load the paper with the print side facing down.

Insert the paper along the bypass tray guides all the way into the bypass tray until it stops slowly. Inserting the paper with excessive force may cause the leading edge to fold back. Inserting the paper too loosely may cause skewed feeding or misfeeds. The paper must not exceed the maximum number of sheets and must not be higher than the indicator line.

3

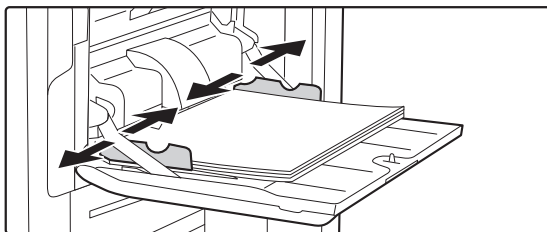

Set the bypass tray guides correctly to the width of the paper.

Adjust the bypass tray guides so that they slightly contact the loaded paper.



For "Letter Head" and "Pre-Printed", set the paper with the print side up. However, when [Disabling of Duplex] is enabled, set the print side in the same orientation as in the regular mode (facing down).



- Do not forcefully push in paper that you are loading. This may cause misfeeds.
- If the bypass tray guides are set wider than the paper, move the bypass tray guides in until they correctly fit the width of the paper. If the bypass guides are set too wide, the paper may skew or be creased.
- **How to close the bypass tray**
Remove any paper remaining in the bypass tray. When the extension guide is pulled, push the extension guide into the bypass tray and then close the bypass tray.



HOW TO PLACE THE LONG PAPER GUIDE

The steps for attaching the optional long paper feeding tray to the bypass tray are explained below.

1

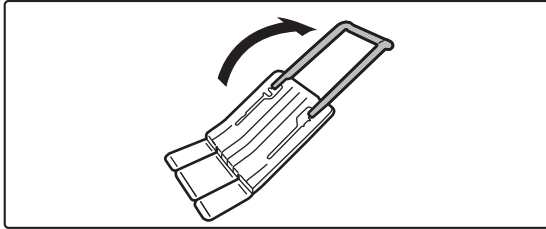

Extend the auxiliary guide of the long paper feeding tray.

2

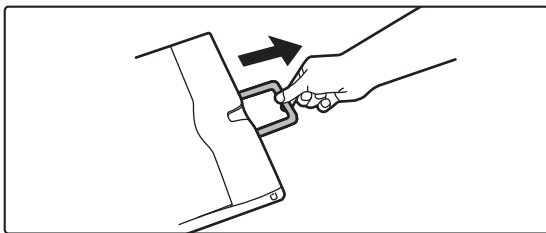

Pull out the extension guide of the bypass tray.

3

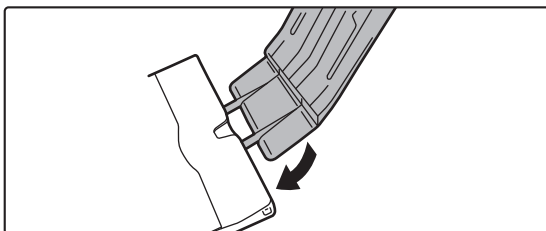

Attach the long paper feeding tray onto the extension guide of the bypass tray.

4

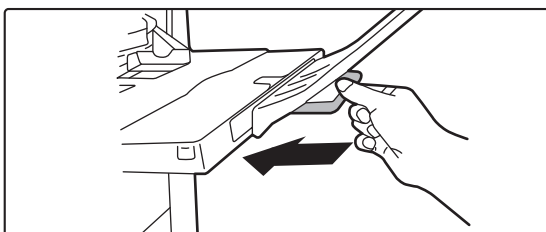

Replace the extension guide of the bypass tray.



HOW TO PLACE THE ORIGINAL

SELECTING A PROCEDURE FOR PLACING THE ORIGINAL DEPENDING ON THE TYPE AND STATUS OF THE ORIGINAL

Place the original in the automatic document feeder. Depending on the type and status of the original, use the document glass. Follow the instructions to select the method for placing the original.

[AUTOMATIC DOCUMENT FEEDER \(page 1-34\)](#)

DETECTABLE ORIGINAL SIZES

In "Settings (administrator)", select [System Settings] → [Common Settings] → [Device Control] → [Condition Settings] → [Original Size Detector Setting].

One of the 8 groups of standard original sizes shown below can be selected for detection by the original size detection function.

Selections	Detectable original sizes	
	Document glass	Document feeder tray (automatic document feeder)
AB-1	A3, A4, A4R, A5, B4, B5, B5R	A3, A4, A4R, A5, A5R, A6R, B4, B5, B5R, 11" x 17", 8-1/2" x 14", 8-1/2" x 11"
AB-2	A3, A4, A4R, A5, B5, B5R, 216 mm x 330 mm (8-1/2" x 13")	A3, A4, A4R, A5, A5R, A6R, B4, B5, B5R, 11" x 17", 8-1/2" x 11", 216 mm x 330 mm (8-1/2" x 13")
AB-3	A4, A4R, A5, B4, 8K, 16K, 16KR	A3, A4, A4R, A5, A5R, A6R, B4, 11" x 17", 8-1/2" x 11", 216 mm x 330 mm (8-1/2" x 13"), 8K, 16K, 16KR
AB-4	216 mm x 340 mm (8-1/2" x 13-2/5"), A3, A4, A4R, A5, B5, B5R	A3, A4, A4R, A5, A5R, A6R, B4, B5, B5R, 11" x 17", 8-1/2" x 11", 216 mm x 340 mm (8-1/2" x 13-2/5")
AB-5	216 mm x 343 mm (8-1/2" x 13-1/2"), A3, A4, A4R, A5, B5, B5R	A3, A4, A4R, A5, A5R, A6R, B4, B5, B5R, 11" x 17", 8-1/2" x 11", 216 mm x 343 mm (8-1/2" x 13-1/2")
Inch-1	11" x 17", 8-1/2" x 14", 8-1/2" x 11", 8-1/2" x 11"R, 5-1/2" x 8-1/2"	11" x 17", 8-1/2" x 14", 8-1/2" x 11", 8-1/2" x 11"R, 5-1/2" x 8-1/2", 5-1/2" x 8-1/2"R, A3, A4
Inch-2	11" x 17", 216 mm x 330 mm (8-1/2" x 13"), 8-1/2" x 11", 8-1/2" x 11"R, 5-1/2" x 8-1/2"	11"x17", 216 mm x 330 mm (8-1/2"x13"), 8-1/2"x11", 8-1/2"x11"R, 5-1/2"x8-1/2", 5-1/2"x8-1/2"R, A3, A4
Inch-3	11" x 17", 8-1/2" x 13-2/5" (216 mm x 340 mm), 8-1/2" x 11", 8-1/2" x 11"R, 5-1/2" x 8-1/2"	11"x17", 8-1/2"x13-2/5 (216 mm x 340 mm), 8-1/2"x11", 8-1/2"x11"R, 5-1/2"x8-1/2", A3, A4



Original Feeding Mode

The following original feeding modes can be set to operate by default in copy, image send, and scan to local drive. When a mode is frequently used, this saves you from having to select the mode in another mode each time you need to use it.

In "Settings (administrator)", select [System Settings] → [Common Settings] → [Device Control] → [Condition Settings] → [Original Feeding Mode].

- Mixed Size Doc. Different Width
- Slow Scan Mode
- Blank Page Skip*

* Excluding fax mode and Internet fax mode.



AUTOMATIC DOCUMENT FEEDER

This section explains how to place originals in the automatic document feeder.

- Place originals of different sizes together, if needed, in the automatic document feeder. In that case, use the "Others" function in each mode to set [Mixed Size Original].
- See the following pages for the combinations of document sizes that can be loaded.

Copy: [SCANNING ORIGINALS OF DIFFERENT SIZES \(MIXED SIZE ORIGINAL\) \(page 3-99\)](#)

Fax/Scanner: [SCANNING ORIGINALS OF DIFFERENT SIZES \(MIXED SIZE ORIGINAL\) \(page 6-99\)](#)

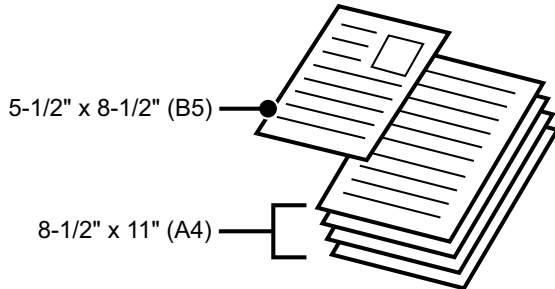

- Before inserting originals into the document feeder tray, be sure to remove any staples or paper clips.
- If originals have damp spots due to correction fluid, ink or paste up glue, wait until the originals are dry before making copies. Otherwise the interior of the machine or the document glass may be soiled.
- Do not use the following originals. Incorrect original size detection, original misfeeds, and smudges may result. Transparency film or other transparent material for backup copy, tracing paper, carbon paper, thermal paper or originals printed with thermal transfer ink ribbon should not be fed through the document feeder. Originals to be fed through the feeder should not be damaged, crumpled, folded, loosely pasted together, or have cut-out holes. Originals with multiple punched holes other than two-hole or three-hole punched paper may not feed correctly.
- Business cards may not be scanned correctly depending on the condition, material, shape and processing method used.
- When using originals with two or three holes, place them so that the punched edge is at a position away from the feed slot of the document feeder tray. Specify the orientation of the original using [Original].

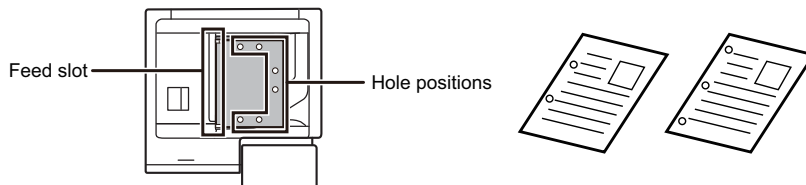

- Depending on the condition of the original, the type of paper, and the temperature and humidity of the environment in which the machine is used, multiple sheets of paper may be fed at the same time and may not be scanned correctly, or the ejected originals may not be neatly aligned.

It may be improved by the following settings.

- For copying: Set the resolution to 600x600dpi
- For scan transmission: use "Preview"
- When the document rolls in the original exit tray on the automatic document feeder, fix the paper fixing arm at the center to the top.

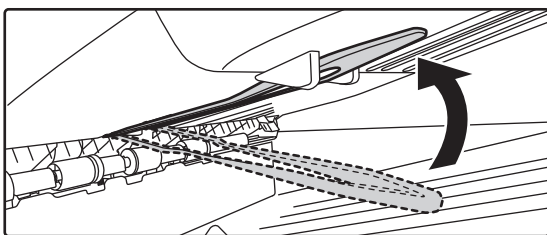



Allowed original sizes

Minimum original size	Maximum original size
<p>Standard size (Minimum size that can be automatically detected) 5-1/2" (longitudinal) × 8-1/2" (transversal) A6R: 105 mm (longitudinal) × 148 mm (transversal)</p> <p>Non-standard size (Minimum size that can be specified manually) 2-1/64" (longitudinal) × 5-3/64" (transversal) 51 mm (longitudinal) × 128 mm (transversal) Business card: 51 mm (longitudinal) × 89 mm (transversal)</p>	<p>Standard size (Maximum size that can be automatically detected) 11" (longitudinal) × 17" (transversal) A3: 297 mm (longitudinal) × 420 mm (transversal) 12" × 18" (A3W) cannot be used.</p> <p>Non-standard size (Maximum size that can be specified manually) Copy mode: 11-5/8" (longitudinal) × 17" (transversal) 297 mm (longitudinal) × 432 mm (transversal) Fax/image send mode: 11" (longitudinal) × 39-3/8" (transversal) 297 mm (longitudinal) × 1000 mm (transversal)</p>



- When the original is a non-standard size, see the appropriate explanation below for the mode you are using.
- COPIER: "[STORING FREQUENTLY USED ORIGINAL SIZES \(page 3-28\)](#)"
- FAX: "[SPECIFYING THE ORIGINAL SCAN SIZE USING NUMERIC VALUES \(page 5-46\)](#)"
- IMAGE SEND: "[SPECIFYING THE ORIGINAL SCAN SIZE USING NUMERIC VALUES \(page 6-72\)](#)"
- In fax or Imaging send mode, to load a 39-3/8" (1000 mm) long original, you need to set the scan size to [Long Size]. In fax mode, see "[SPECIFYING THE ORIGINAL SCAN SIZE IN PAPER SIZE \(page 5-44\)](#)" and "[SPECIFYING THE ORIGINAL SCAN SIZE USING NUMERIC VALUES \(page 5-46\)](#)", and in image sending mode, see "[SPECIFYING THE ORIGINAL SCAN SIZE IN PAPER SIZE \(page 6-70\)](#)" and "[SPECIFYING THE ORIGINAL SCAN SIZE USING NUMERIC VALUES \(page 6-72\)](#)".

Allowed original weights

BP-70M75/BP-70M90	1-sided scanning: 9 to 80 lbs Cover (35 to 220 g/m ²) 2-sided scanning: 13 to 80 lbs Cover (50 to 220 g/m ²) Business card: Thickness, 0.1mm to 0.2mm
-------------------	---

To scan originals from 9 to 13- lbs Bond (35 to 49 g/m²), use "Slow Scan Mode" in the "Others" function. Scanning without using "Slow Scan Mode" may result in original misfeeds.

To scan originals 32 lbs Bond to 80 lbs Cover (158 to 220 g/m²), use "Heavy Paper Scan" in the "Others" function. Scanning without using "Heavy Paper Scan" may result in original misfeeds.



1

Make sure that there is no original on the document glass.

2

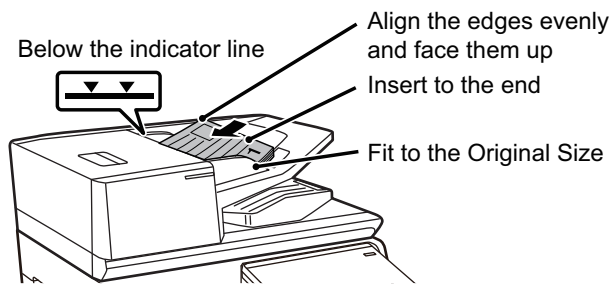

Place the original.

Up to 300 sheets can be inserted.
After scanning is finished on the automatic document feeder, remove originals from the original exit tray.

PREVENTIVE LIGHT TO INDICATE ORIGINAL LEFT BEHIND

In order to prevent originals being left behind, the automatic document feeder incorporates a lamp on the top of the original exit tray.

This lamp detects a document on the automatic document feeder, and starts blinking after the last original is output from the original exit tray.

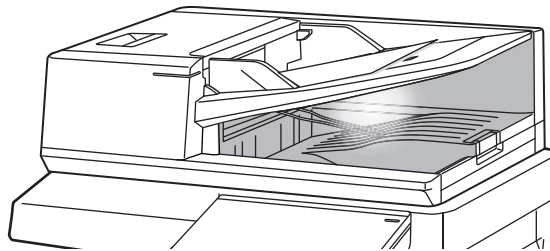

Light turning off

The preventive light to indicate original left behind will turn off in the event of the following.

- When the scanned original is removed
- After the preventive light to indicate original left behind blinks three times, repeated three times
- When a new original is placed in the automatic document feeder, and a job started
- When the machine enters sleep mode
- When use of the automatic document feeder is prohibited



- When the preventive light to indicate original left behind is blinking, placing the original on the document glass will not turn off the preventive light to indicate original left behind.
- The preventive light to indicate original left behind will not turn off by only placing an original on the automatic document feeder.
- The preventive light to indicate original left behind will not turn off even if the operation panel is off.
- If the preventive light to indicate original left behind turns off, this will not flash even if an original is left on the automatic document feeder.



ORIGINAL SETTING INDICATOR

The original setting indicator lights when the document is correctly loaded on the document feeder tray. If the original setting indicator is lit, it is possible for a user who has difficulty in confirming that a document is loaded on the document feeder tray to confirm that the document is loaded.

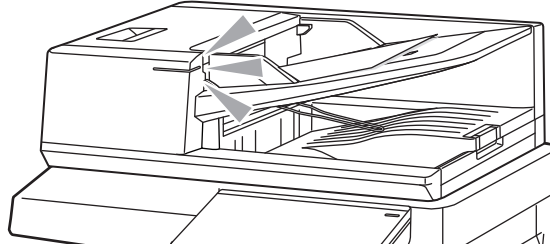

SKEW FEED PREVENTION

The automatic document feeder is equipped with a skewed feed prevention function. When a document is loaded at an angle, the function stops loading the document as misfeed.

DOUBLE FEED DETECTION

When you attach the double feed detection kit of the peripheral device to the automatic document feeder, you can use the double feed detection function.

This automatic document feeder is equipped with a double feed detection function. If you attempt to scan multiple originals at the same time, scanning stops as misfeed.



DOCUMENT GLASS

This section describes the steps for setting the original on the document glass.



- Close the automatic document feeder slowly. Abruptly closing the automatic document feeder may damage it.
- Take care that your fingers are not pinched when closing the automatic document feeder.

Allowed original sizes

Minimum original size	Maximum original size
<p>Standard size (Minimum size that can be automatically detected) 8-1/2" (longitudinal) × 5-1/2" (transversal) A5: 210 mm (longitudinal) × 148 mm, (transversal)</p> <p>Non-standard size (Minimum size that can be specified manually) 1" (longitudinal) × 1" (transversal) 25 mm (longitudinal) × 25 mm (transversal)</p>	<p>Standard size (Maximum size that can be automatically detected) 11" (longitudinal) × 17" (transversal) A3: 297 mm (longitudinal) × 420 mm (transversal)</p> <p>Non-standard size (Maximum size that can be specified manually) 11-5/8" (longitudinal) × 17" (transversal) 297 mm (longitudinal) × 432 mm (transversal)</p>



When the original is a non-standard size, see the appropriate explanation below for the mode you are using.

- COPIER: "[STORING FREQUENTLY USED ORIGINAL SIZES \(page 3-28\)](#)"
- FAX: "[SPECIFYING THE ORIGINAL SCAN SIZE USING NUMERIC VALUES \(page 5-46\)](#)"
- IMAGE SEND: "[SPECIFYING THE ORIGINAL SCAN SIZE USING NUMERIC VALUES \(page 6-72\)](#)"

1

Open the automatic document feeder.

2

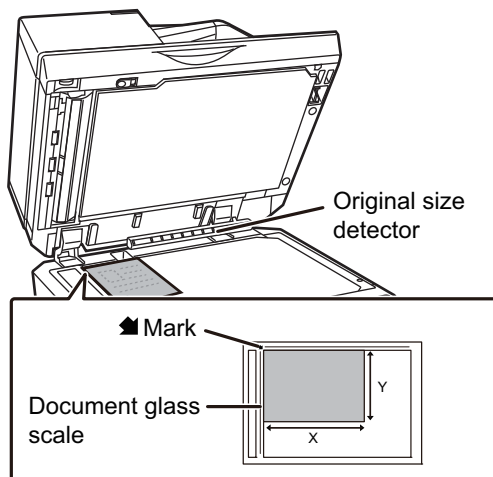

Load the paper with the print side facing down.

Place the original face down and align the top left corner of the original with back left (at the tip of the mark ) of the document glass.



- Do not place any objects under the original size detector.
- Closing the automatic document feeder with an object underneath may damage the original size detector or disable correct detection of the original size.



3

Close the automatic document feeder.

After placing the original, close the automatic document feeder. If the unit is left open, parts outside of the original will be copied in black, causing excessive use of toner.



- When closing, open the automatic document feeder all the way and then close it.
- If originals have damp spots due to correction fluid, ink or paste up glue, wait until the originals are dry before making copies. Otherwise the interior of the machine or the document glass may be soiled.



PERIPHERAL DEVICES

PERIPHERAL DEVICES

Peripheral devices can be installed on the machine to increase its range of functionality.

The peripheral devices are generally optional. However, some models include certain peripheral devices as standard equipment.

(As of June, 2022)

Product name	Product number	Description
Large capacity tray	BP-LC11	LOADING PAPER IN THE LARGE CAPACITY TRAY (page 1-23)
	MX-LC19	
Long paper feeding tray	MX-LT10	HOW TO PLACE THE LONG PAPER GUIDE (page 1-31)
Exit tray unit	MX-TR21	When a finisher is installed, this can be added to the right side of the machine.
Exit tray cabinet	MX-TU15	This enables separation of output locations by mode (copy, printer, etc.).
Finisher	MX-FN34	FINISHER (page 1-42)
Finisher (large stacker)	MX-FN21	FINISHER (LARGE STACKER) (page 1-46)
Saddle stitch finisher	MX-FN35	SADDLE STITCH FINISHER (page 1-51)
Saddle stitch finisher (large stacker)	MX-FN22	SADDLE STITCH FINISHER (LARGE STACKER) (page 1-58)
Trimming module	MX-TM10	This unit trims the excess portions of saddle-stitched sheets. A saddle stitch finisher (large stacker) is required.
Folding unit	MX-FD10	FOLDING UNIT (page 1-67)
Insertter	MX-CF11	INSERTER (page 1-68)
Curl correction unit	MX-RB27	This unit corrects curls in printed paper. This unit is required for installing a finisher (large stacker), saddle stitch finisher (large stacker), folding unit or inserter.
Paper pass unit	MX-RB26	This unit is required to install a finisher or a saddle stitch finisher.
Relay unit	MX-RB13	This unit is required for directly installing a finisher (large stacker) or saddle stitch finisher (large stacker) and inserter.
Punch module	MX-PN16B	PUNCH MODULE (MX-PN16B) (page 1-69)
	MX-PN13B	PUNCH MODULE (MX-PN13B) (page 1-71)
Barcode font kit	MX-PF10	Adds barcode fonts to the machine.
Facsimile expansion kit	BP-FX11	Enables Fax.
Internet fax expansion kit	MX-FWX1	Enables Internet Fax.
Double feed detection kit	BP-DD10	If you attempt to scan multiple originals at the same time, scanning stops as a document jam.
Application integration module	MX-AMX1	Sharp OSA (page 9-45)
High capacity SSD	BP-SD10	Extends the local drive capacity of the machine.



Product name	Product number	Description
Data security kit	BP-FR12U	The data which is being stored in the local drive and memory of this machine is stored in encrypted form. Furthermore, after copy and print data has been output and after fax and scanner transmissions, the data is automatically deleted in order to securely protect important information.
Virus detection kit	BP-VD10	VIRUS SCAN (page 9-47)



FINISHER

This device outputs sorted paper while staggering each set of paper. As needed, it staples each set. You can also perform stapling manually. To punch holes in printed paper, install an optional hole punch module.

PART NAMES

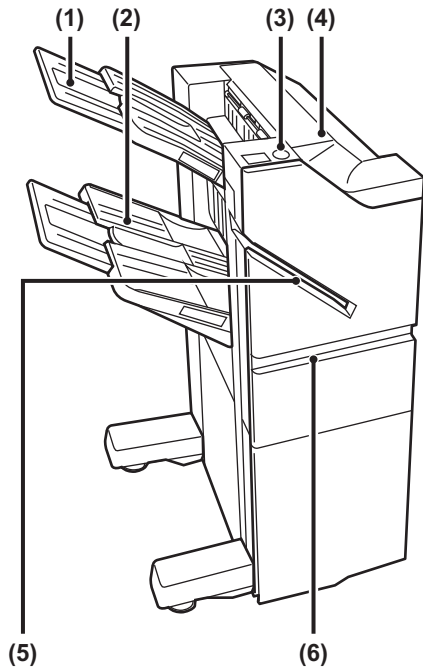

(1) Output tray (upper tray)

The tray is slidable. To print on large paper such as A3 paper, extend the tray.

(2) Output tray (lower tray)

Stapled and offset output is delivered to this tray. The tray is slidable. To print on large paper such as A3 paper, extend the tray.

(3) Manual staple key

Press to execute manual stapling.

(4) Top cover

Open this cover to remove a paper misfeed.

(5) Insertion slot

Place the paper that you want to staple in this slot. Maximum thickness 9 mm.

(6) Front cover

Open this cover to replace the staple cartridge, remove a staple jam or remove a paper misfeed.



- To install a finisher, a paper pass unit is required.
- A finisher cannot be installed simultaneously with a finisher (large stacker), saddle stitch finisher or saddle stitch finisher (large stacker).
- Do not place heavy objects on the finisher or press down on the finisher.
- Exercise caution when you turn on the power and when printing take place, as the tray may move up and down



HOW TO STAPLE MANUALLY

You can perform stapling manually.
Make sure the manual staple key is lit green.

1

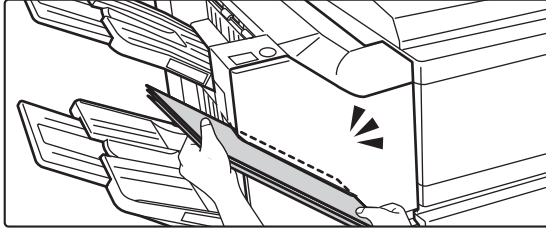

Place the paper that you want to staple in the insertion slot.

When you place the paper, the manual staple key blinks green.

After two seconds elapse, stapling automatically starts.



- To staple earlier than the auto staple start time, press the manual staple key.

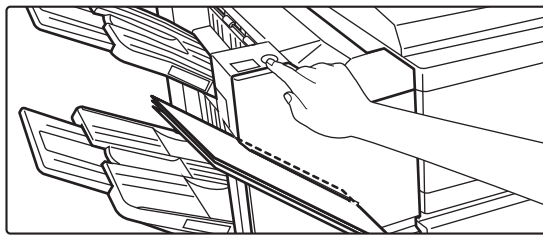

- Manual stapling cannot be executed during execution of a staple job.

Relation between paper orientation and stapling result

Paper	Paper orientation when inserted	After stapling



SUPPLIES

The finisher requires the following staple cartridge:

Staple cartridge (approx. 5000 staples per cartridge x three cartridges)

MX-SC11

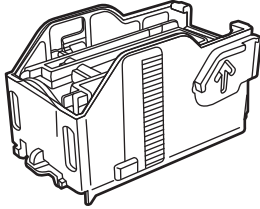

FINISHER MAINTENANCE

When the staple cartridge runs out of staples, a message will appear in the operation panel. Follow the operation procedure to replace the staple cartridge.

Replacement the staple cartridge

1

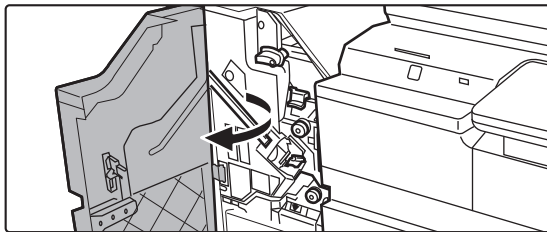

Open the front cover.

2

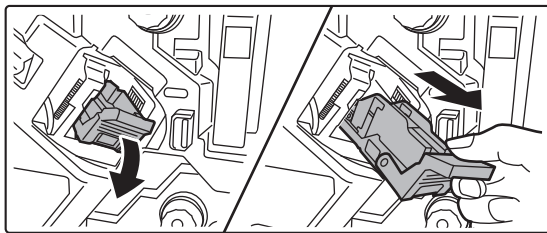

Remove the staple case.

3

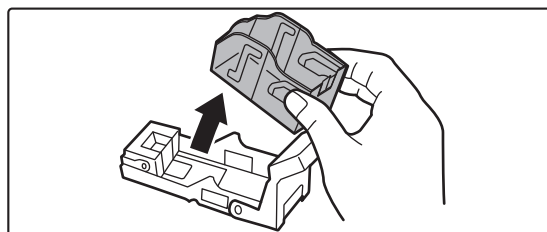

Remove the empty staple cartridge.



4

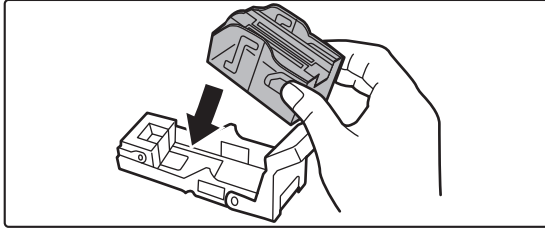

Insert a new staple cartridge into the staple case.

Push the staple cartridge in until it clicks into place.

5

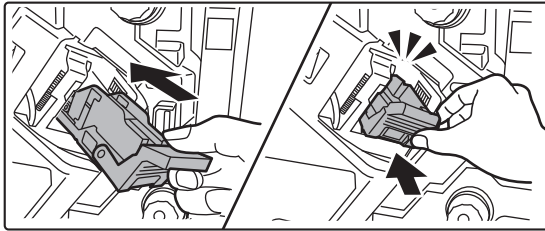

Push the staple case firmly back in.

Push the staple case in until it clicks into place.

6

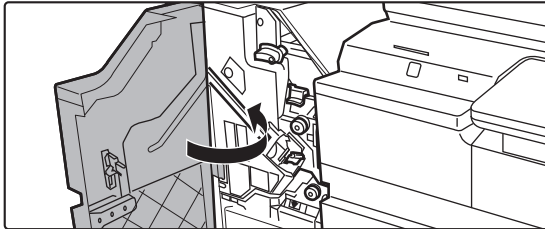

Close the front cover.



Make a proof copy in staple sort function to verify that stapling takes place correctly.



FINISHER (LARGE STACKER)

This device outputs sorted paper while staggering each set of paper. As needed, it staples each set. To punch holes in printed paper, install an optional hole punch module.

PART NAMES

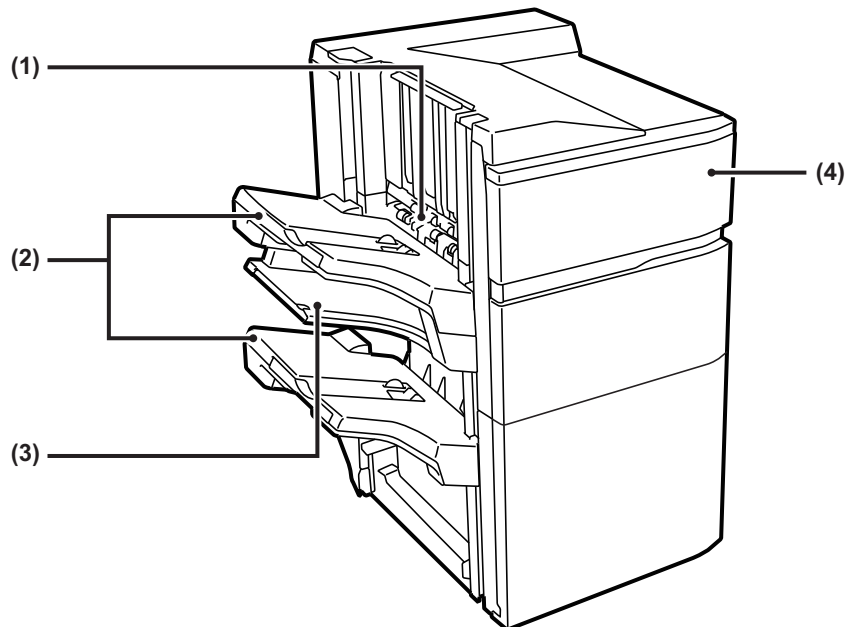

(1) Staple compiler

This temporarily stacks paper to be stapled.

(2) Output tray

Stapled and offset output is delivered to this tray. The tray is slidable. Extend the tray for printing on large-size paper (12" × 18", 11" × 17", 8-1/2" × 14", 8-1/2" × 13", A3W, A3 and B4 sizes).

(3) Middle output tray

Output paper that will not be offset in this tray. The tray is slidable. Extend the tray for printing on large-size paper (12" × 18", 11" × 17", 8-1/2" × 14", 8-1/2" × 13", A3W, A3 and B4 sizes).

(4) Front cover

Open this cover to replace the staple cartridge, remove a staple jam or remove a paper misfeed.



- To install a finisher (large stacker), a paper pass unit is required.
- A finisher (large stacker) cannot be installed simultaneously with a finisher, saddle stitch finisher or saddle stitch finisher (large stacker).
- Do not place heavy objects on the finisher (large stacker) or press down on the finisher (large stacker).
- Exercise caution when you turn on the power and when printing take place, as the tray may move up and down.



SUPPLIES

The finisher (large stacker) requires the following staple cartridge:
Staple cartridge (approx. 5000 staples per cartridge x three cartridges)
MX-SCX2

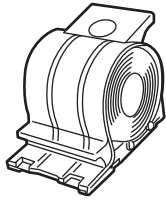

FINISHER (LARGE STACKER) MAINTENANCE

When the staple cartridge runs out of staples, a message will appear in the operation panel. Follow the operation procedure to replace the staple cartridge.

Replacement the staple cartridge

1

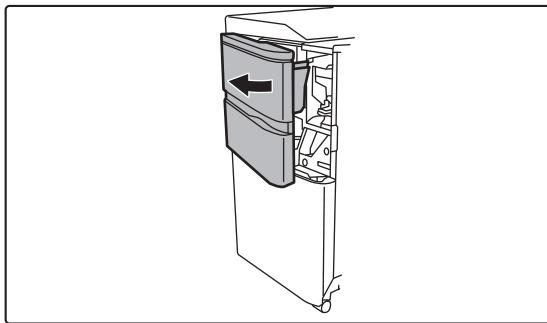

Open the front cover.

2

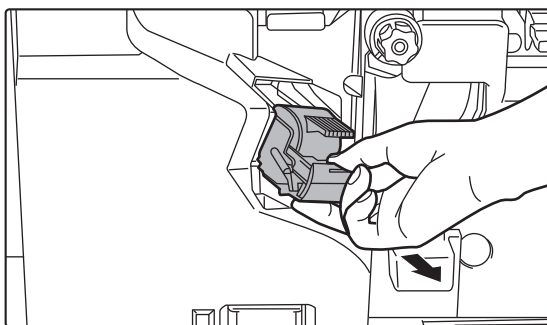

Squeeze the green parts of the staple case and pull the case up and then out.



3

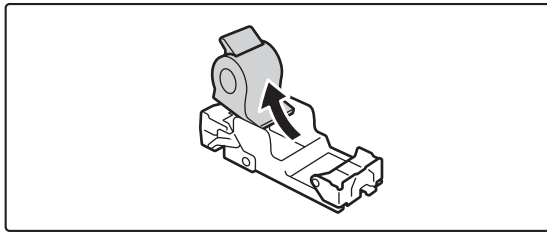

Remove the empty staple cartridge.



When staples remain, the staple cartridge cannot be removed.

4

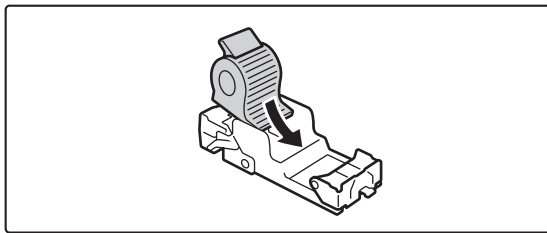

Insert a new staple cartridge into the staple case.

Push the staple case in until it clicks into place.

5

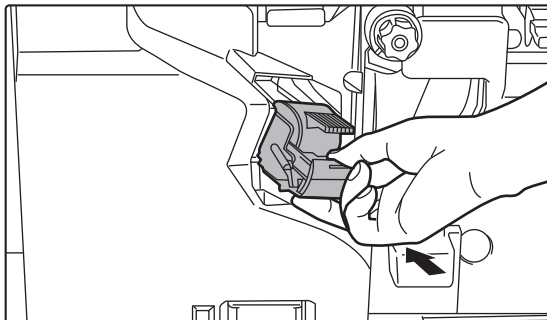

Install a staple case.

Push the staple case in until it clicks into place.

6

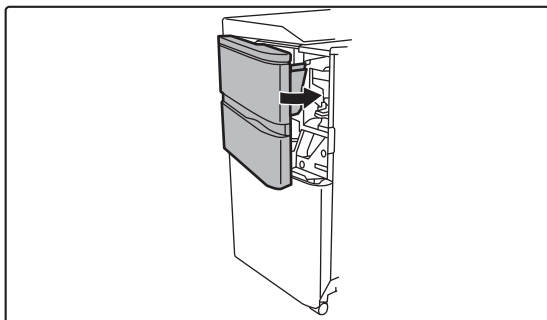

Close the front cover.



Make a proof copy in staple sort function to verify that stapling takes place correctly.



DISCARDING STAPLE WASTE

When a finisher is used for stapling, staple waste is produced. The staple waste is collected in the staple waste box. Follow the steps below to discard staple waste.

1

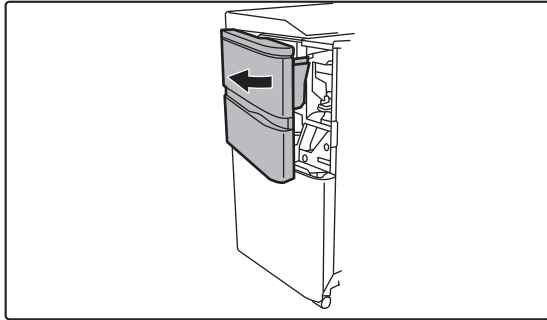

Open the front cover.

2

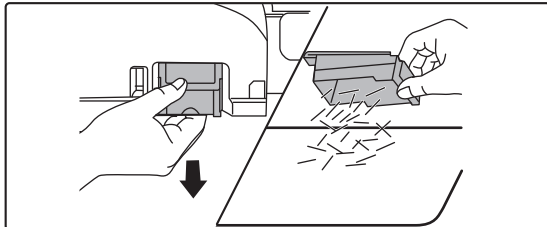

Grasp the tab of the staple waste box, gently pull out the box, and discard the staple waste.



- Do not put your fingers into the staple waste box. The staples may prick and injure your fingers.
- Do not discard the staple waste in a plastic bag. The staples may create holes in the bag.

3

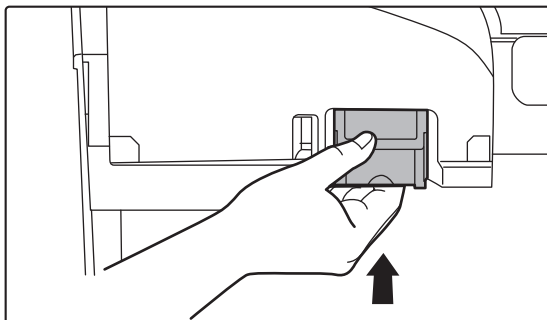

Replace the staple waste box.

Make sure that the staple waste box is replaced correctly.



4

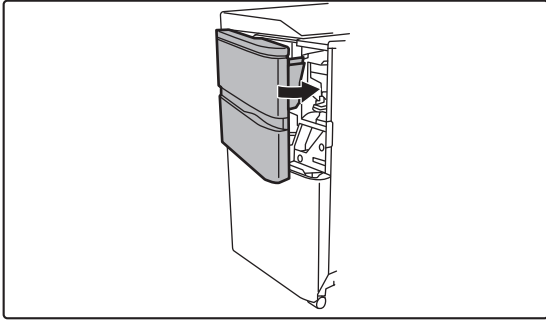

Close the front cover.



SADDLE STITCH FINISHER

This includes the offset function that outputs sorted paper while staggering each set of paper, the staple sort function that staples each set of prints, the saddle stitch function that automatically staples the center of the sheets and folds the sheets in half, and the paper folding function that folds paper in half. You can also perform stapling manually. To punch holes in printed paper, install an optional hole punch module.

PART NAMES

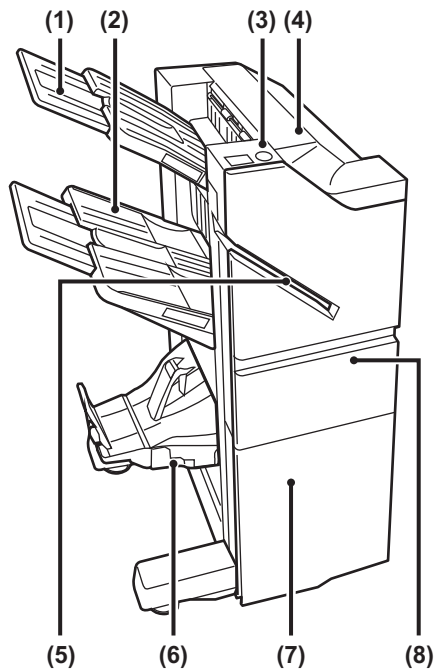

- | | |
|---|--|
| <p>(1) Output tray (upper tray)
The tray is slidable. To print on large paper such as 11" x 17" (A3) paper, extend the tray.</p> <p>(2) Output tray (lower tray)
Stapled and offset output is delivered to this tray. The tray is slidable. To print on large paper such as 11" x 17" (A3) paper, extend the tray.</p> <p>(3) Manual staple key
Press to execute manual stapling.</p> <p>(4) Top cover
Open this cover to remove a paper misfeed.</p> | <p>(5) Insertion slot
Place the paper that you want to staple in this slot. Maximum thickness 23/64" (9 mm).</p> <p>(6) Saddle stitch tray
Saddle-stitched output is delivered to this tray.</p> <p>(7) Front lower cover
Open this cover to replace the staple cartridge, remove a staple jam, or remove a paper misfeed.</p> <p>(8) Front upper cover
Open this cover to replace the staple cartridge, remove a staple jam, or remove a paper misfeed.</p> |
|---|--|



- To install a saddle stitch finisher, a paper pass unit is required.
- Do not place heavy objects on the saddle finisher or press down on the saddle stitch finisher.
- Exercise caution when you turn on the power and when printing takes place, as the tray may move up and down.
- A saddle stitch finisher cannot be installed simultaneously with a finisher, finisher (large stacker) or saddle stitch finisher (large stacker).



HOW TO STAPLE MANUALLY

You can perform stapling manually.
Make sure the manual staple key is lit green.

1

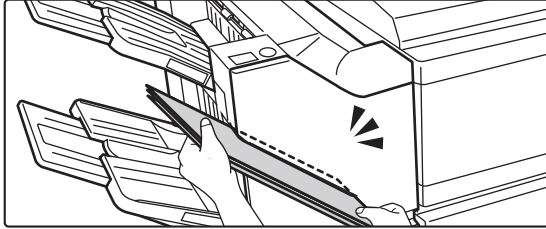

Place the paper that you want to staple in the insertion slot.

When you place the paper, the manual staple key blinks green.

After two seconds elapse, stapling automatically starts.



- To staple earlier than the auto staple start time, press the manual staple key.

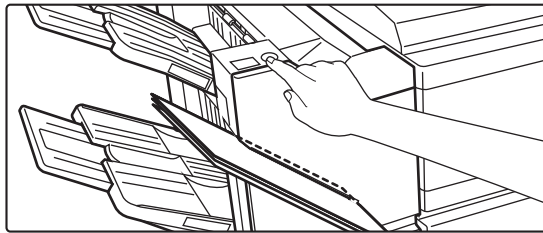

- Manual stapling cannot be executed during execution of a staple job.
- Manual stapling cannot be executed during auto power shut-off mode.

Relation between paper orientation and stapling result

Paper	Paper orientation when inserted	After stapling



SUPPLIES

The saddle stitch finisher (large stacker) requires the following staple cartridge:

Finisher unit

Staple cartridge (approx. 5000 staples per cartridge x three cartridges)

MX-SC11

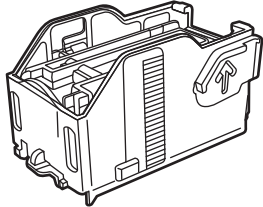

Saddle stitch unit

Staple cartridge (approx. 2000 staples per cartridge x four cartridges)

MX-SC12

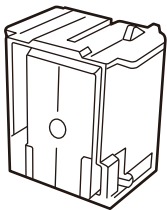



SADDLE STITCH FINISHER MAINTENANCE

When the staple cartridge runs out of staples, a message will appear in the operation panel. Follow the operation procedure to replace the staple cartridge.

Replacement the staple cartridge (finisher unit)

1

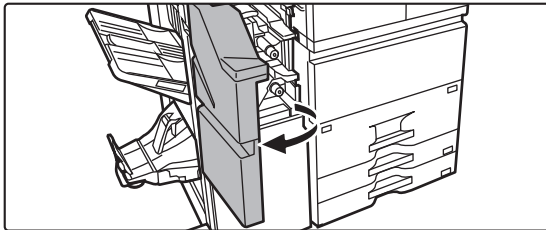

Open the front upper cover.

2

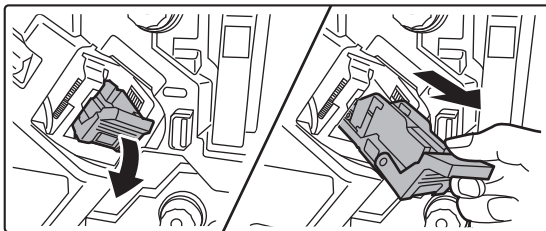

Remove the staple case.

3

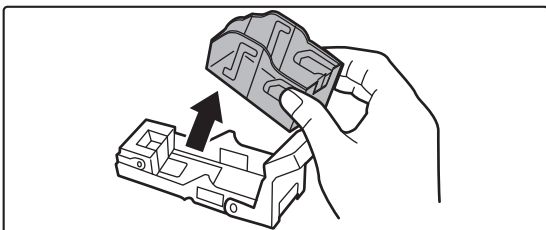

Remove the empty staple cartridge.

4

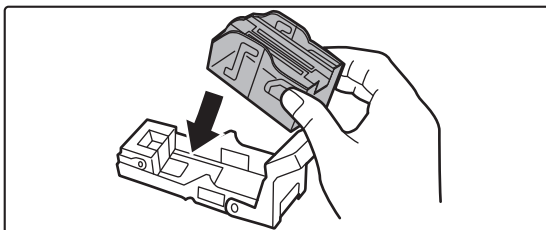

Insert a new staple cartridge into the staple case.

Push the staple cartridge in until it clicks into place.

5

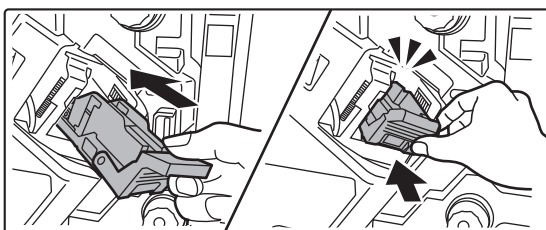

Push the staple case firmly back in.

Push the staple case in until it clicks into place.



6

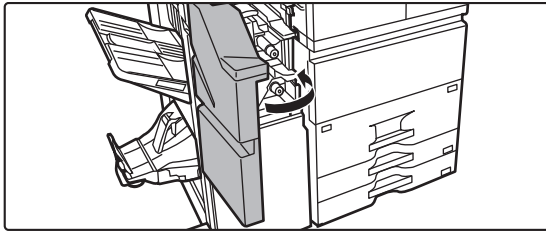

Close the front upper cover.



Make a proof copy in staple sort function to verify that stapling takes place correctly.

Replacement the staple cartridge (saddle stitch unit)

Before starting this procedure, remove all output from the output tray of the saddle finisher (large stacker). Do not replace removed output back in the output tray.

1

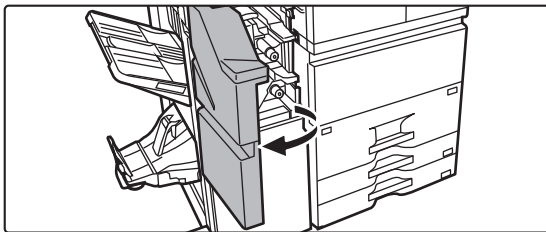

Open the front upper cover.

2

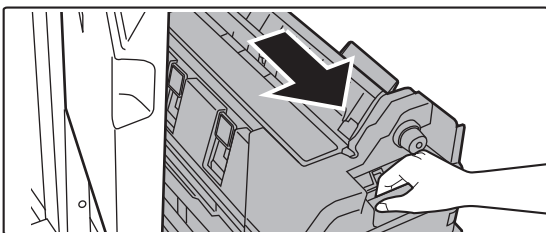

Slowly pull out the front lower cover until it stops.



3

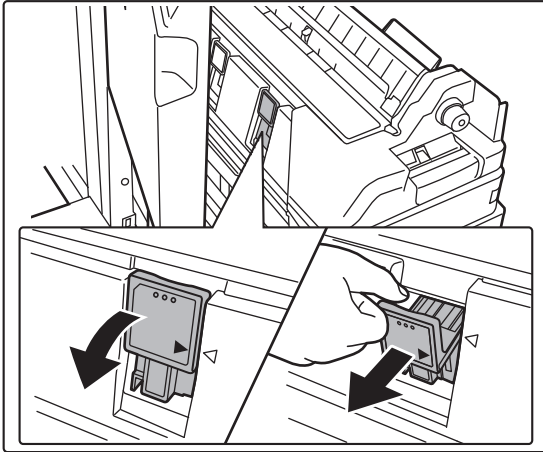

Remove the staple case.

4

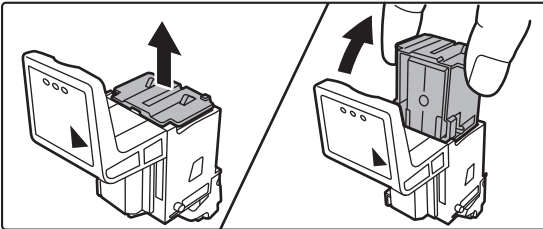

Remove the empty staple cartridge.

5

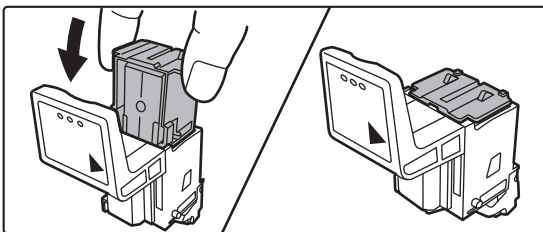

Insert a new staple cartridge into the staple case.

Replace both staple cartridges.

6

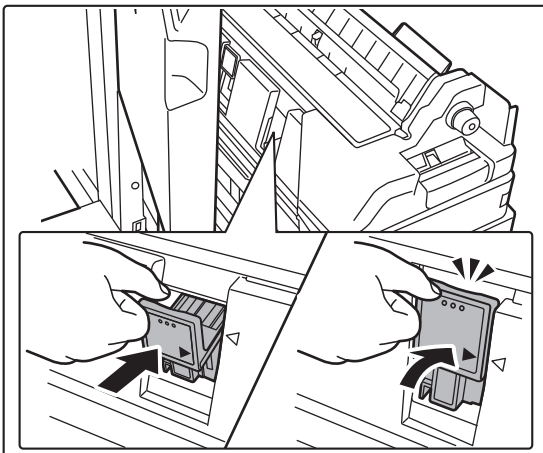

Push the staple case firmly back in.

Push the staple case in until it clicks into place.



7

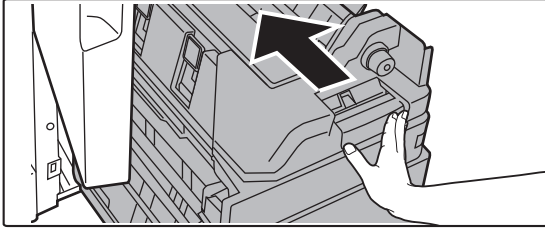

Push the front lower cover back in.

8

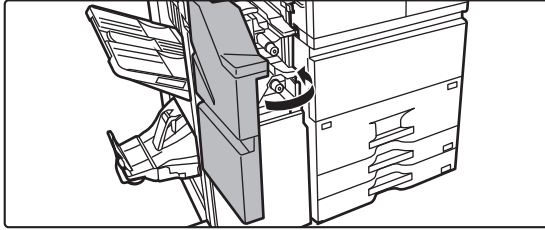

Close the front upper cover.

When the staple cartridge has been replaced, the staple is automatically tested.



Make a test print or copy using the saddle stitch function to verify that stapling takes place correctly.



SADDLE STITCH FINISHER (LARGE STACKER)

This includes the offset function that outputs sorted paper while staggering each set of paper, the staple sort function that staples each set of prints, the saddle stitch function that automatically staples the center of the sheets and folds the sheets in half, and the paper folding function that folds paper in half.
To punch holes in printed paper, install an optional hole punch module.

PART NAMES

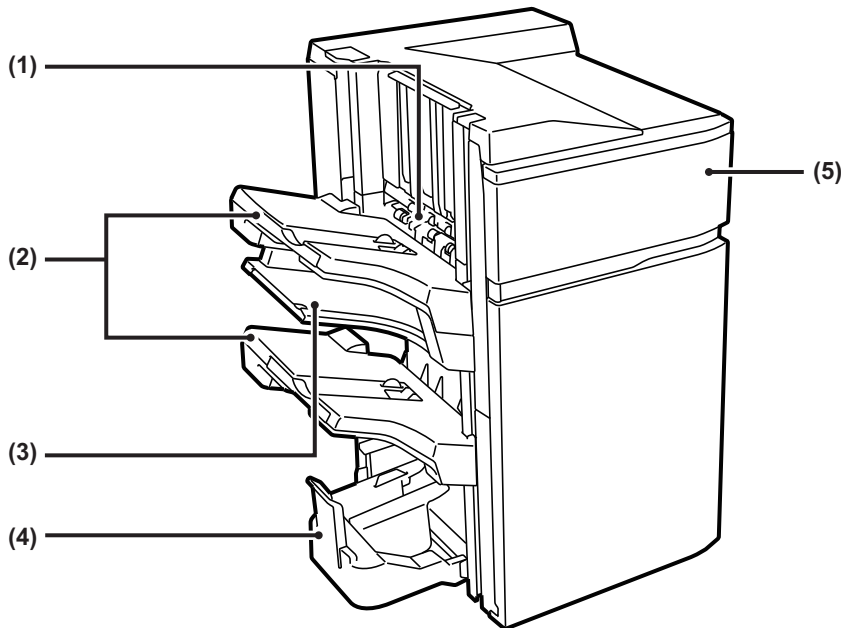

(1) Staple compiler

This temporarily stacks paper to be stapled.

(2) Output tray

Stapled and offset output is delivered to this tray.
The tray is slidable. Extend the tray for printing on large-size paper (12" × 18", 11" × 17", 8-1/2" × 14", 8-1/2" × 13", A3W, A3 and B4 sizes).

(3) Middle output tray

Output paper that will not be offset in this tray.
The tray is slidable. Extend the tray for printing on large-size paper (12" × 18", 11" × 17", 8-1/2" × 14", 8-1/2" × 13", A3W, A3 and B4 sizes).

(4) Saddle stitch tray

Saddle-stitched output is delivered to this tray.

(5) Front cover

Open this cover to replace the staple cartridge, remove a staple jam or remove a paper misfeed.



- To install a saddle stitch finisher (large stacker), a paper pass unit is required.
- Do not place heavy objects on the saddle stitch finisher (large stacker) or press down on the saddle stitch finisher (large stacker).
- Exercise caution when you turn on the power and when printing take place, as the tray may move up and down.
- A saddle stitch finisher (large stacker) cannot be installed simultaneously with a finisher, finisher (large stacker) or saddle stitch finisher.



SUPPLIES

The saddle stitch finisher (large stacker) requires the following staple cartridge:

Finisher unit

Staple cartridge (approx. 5000 staples per cartridge x three cartridges)
MX-SCX2

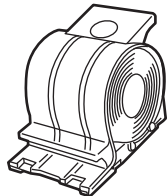

Saddle stitch unit

Staple cartridge (approx. 2000 staples per cartridge x three cartridges)
MX-SCX1

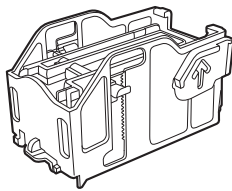

SADDLE STITCH FINISHER (LARGE STACKER) MAINTENANCE

When the staple cartridge runs out of staples, a message will appear in the operation panel. Follow the operation procedure to replace the staple cartridge.

Replacement the staple cartridge (finisher unit)

1

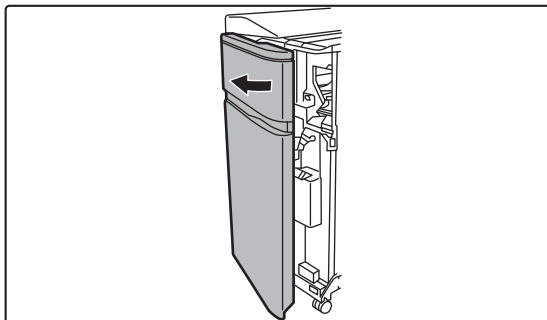

Open the front cover.



2

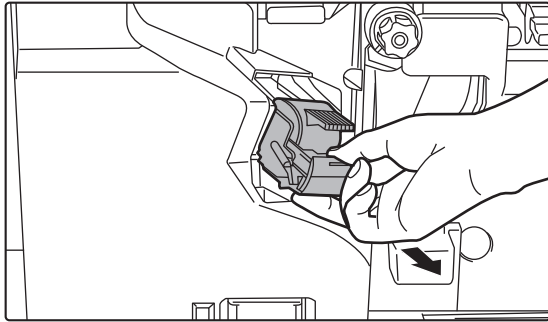

Squeeze the green parts of the staple case and pull the case up and then out.

3

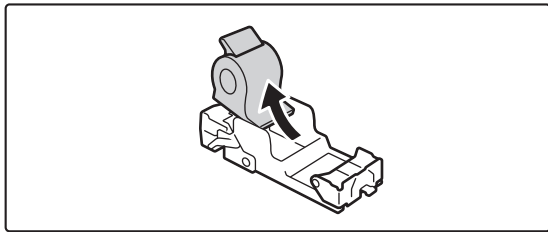

Remove the empty staple cartridge.



When staples remain, the staple cartridge cannot be removed.

4

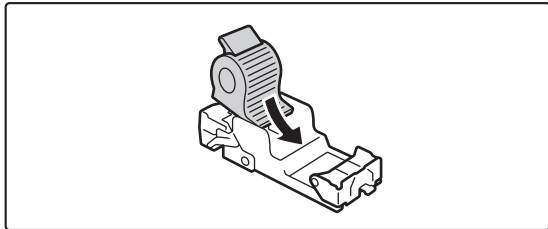

Insert a new staple cartridge into the staple case.

Push the staple case in until it clicks into place.

5

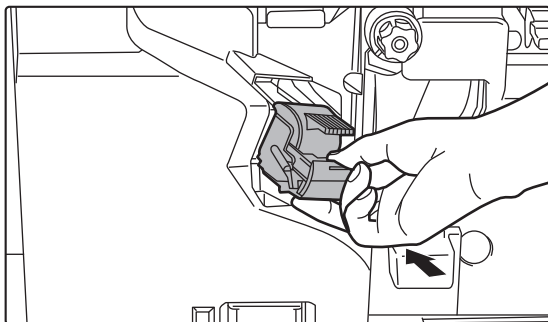

Install a staple case.

Push the staple case in until it clicks into place.



6

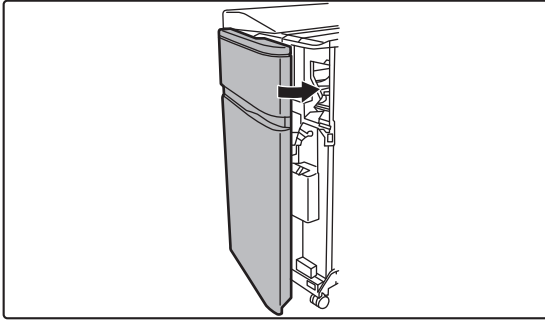

Close the front cover.



Make a proof copy in staple sort function to verify that stapling takes place correctly.

Replacement the staple cartridge (saddle stitch unit)

Before starting this procedure, remove all output from the output tray of the saddle finisher (large stacker). Do not replace removed output back in the output tray

1

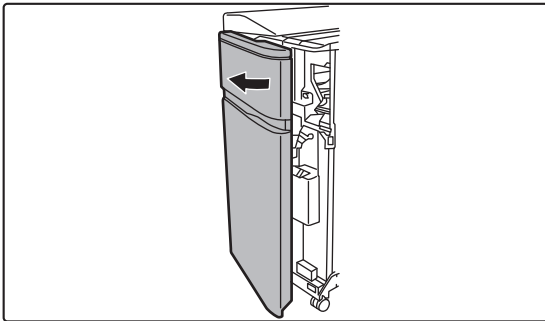

Open the front cover.

2

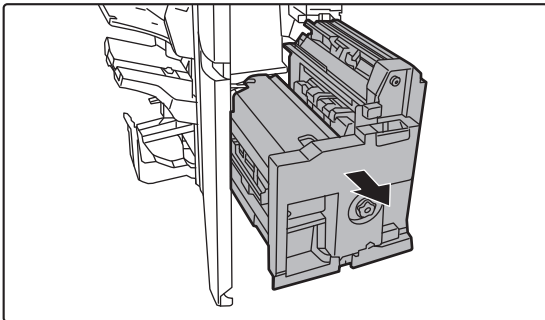

Grasp the handle on the saddle stitch unit and pull it slowly out until it stops.



3

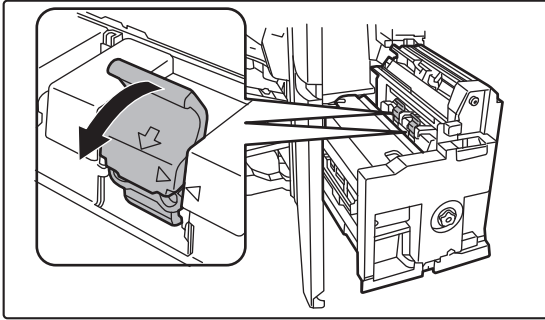

Lower the staple case release lever and remove the staple case.

Pull the staple case out to the left.
Replace both staple cartridges.

4

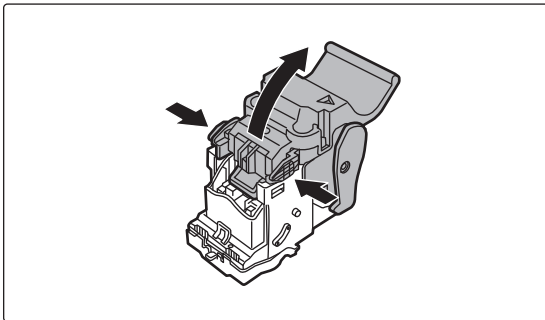

Press the lock button to open the release lever.

5

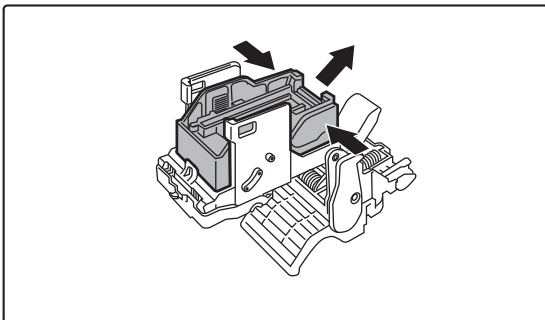

Remove the empty staple cartridge.



Press the lock button to open the release lever.

6

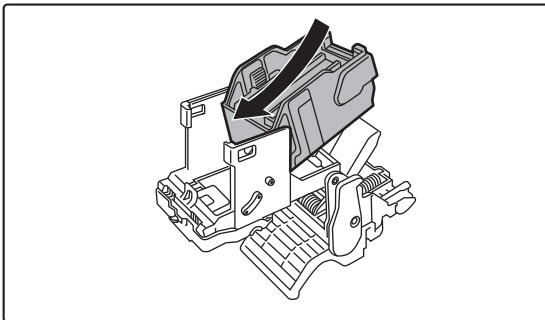

Install a new staple cartridge.

Push the staple case in until it clicks into place.



7

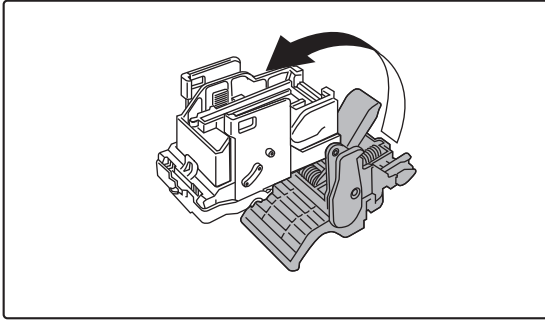

Press the lock button to open the release lever.

8

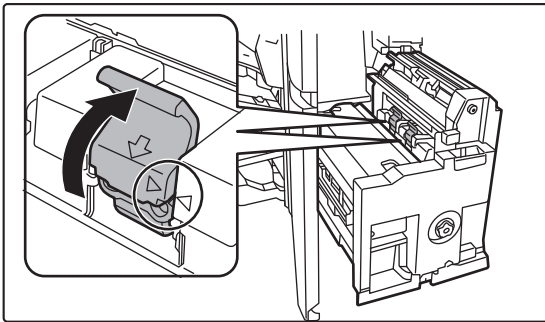

Push the staple case firmly back in.

Align ► of the staple case with ◀ of the unit.
Push the staple case in until it clicks into place.

9

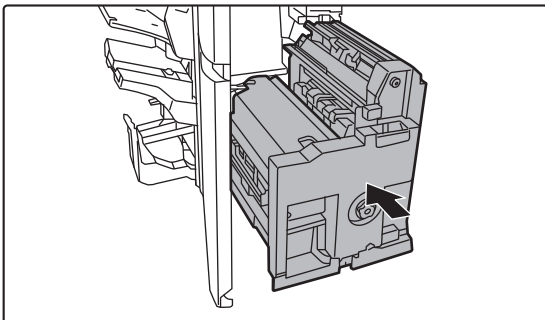

Push the saddle stitch unit in.

10

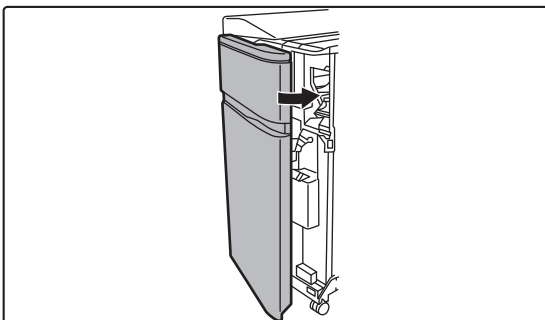

Close the front cover.



Make a test print or copy using the saddle stitch function to verify that stapling takes place correctly.



DISCARDING STAPLE WASTE

When a finisher is used for stapling, staple waste is produced. The staple waste is collected in the staple waste box. Follow the steps below to discard staple waste.

1

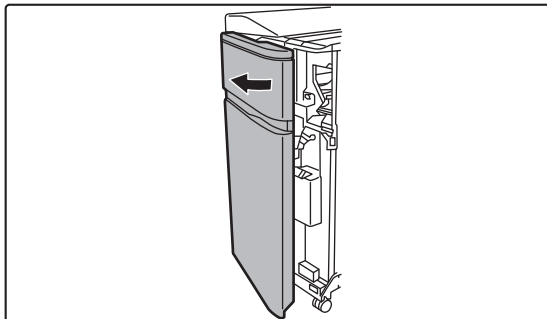

Open the front cover.

2

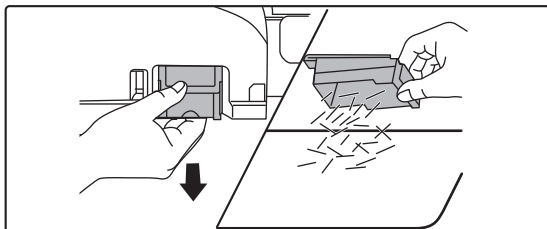

Grasp the tab of the staple waste box, gently pull out the box, and discard the staple waste.



- Do not put your fingers into the staple waste box. The staples may prick and injure your fingers.
- Do not discard the staple waste in a plastic bag. The staples may create holes in the bag.

3

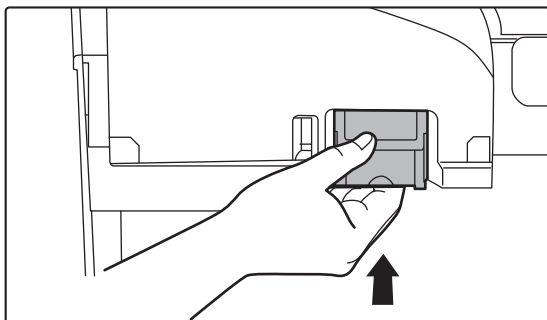

Replace the staple waste box.

Make sure that the staple waste box is replaced correctly.



4

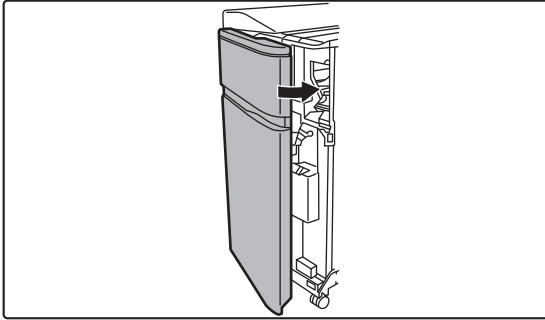

Close the front cover.

DISCARDING PAPER WASTE

When folded paper is trimmed in trimmer settings, paper waste is generated.
Paper waste is collected in the paper waste box.
Follow the operation procedure to remove paper waste.



Using the trimmer function trims a side drop at the time of folding, creating a neat finish.

1

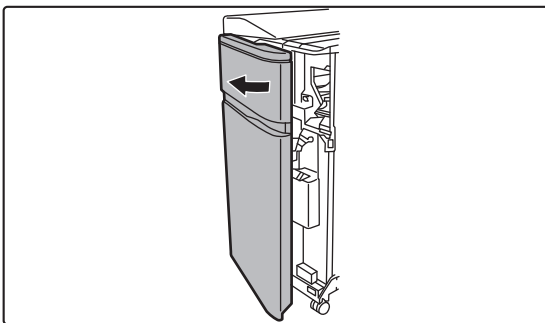

Open the front cover.



2

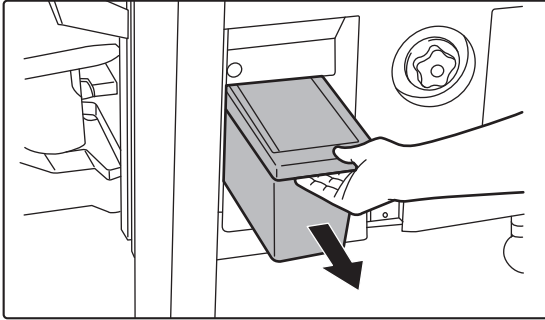

Grasp the paper waste box handle, gently pull out the box, and discard the paper waste.

Discard the paper waste into a plastic bag or other container, being careful not to let any waste scatter.

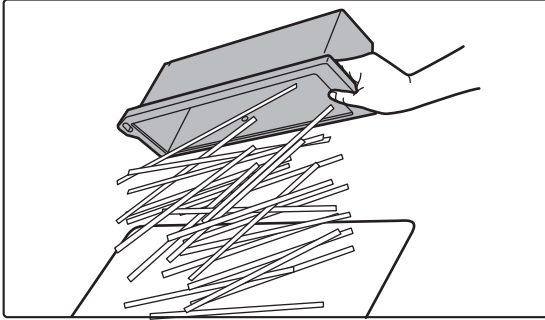

3

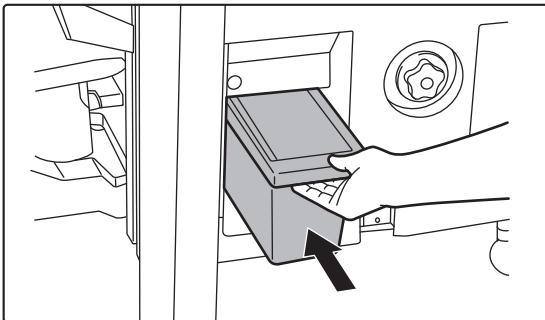

Gently push the box back in.

4

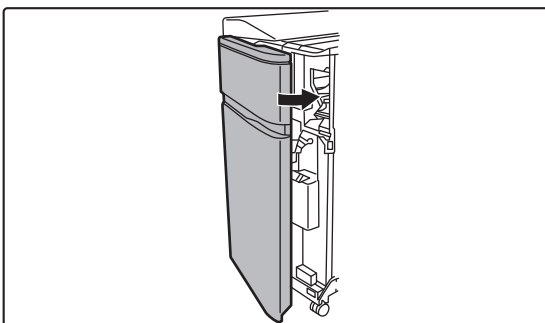

Close the front cover.



FOLDING UNIT

A folding unit can be used for Z-Fold, C-Fold, Accordion Fold, Double Fold, and Half Fold.



A finisher (large stacker) or saddle stitch finisher (large stacker) is required to install the folding unit.

PART NAMES

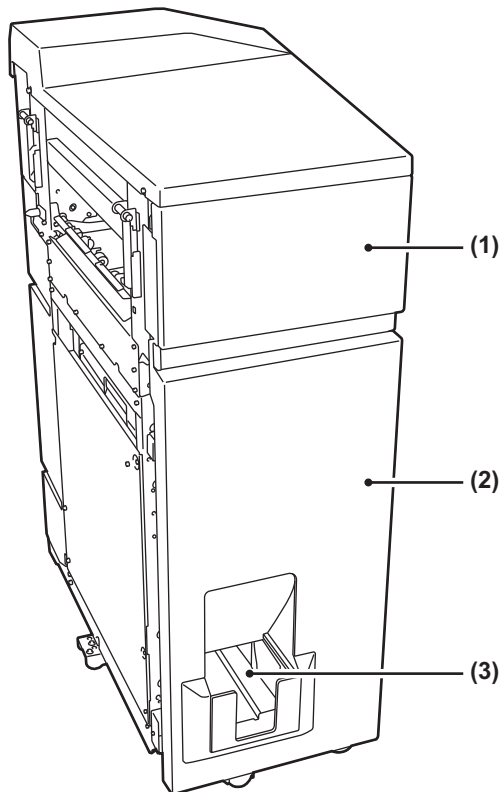

(1) Top cover

Open this cover to remove a paper misfeed.

(2) Bottom cover

Open this cover to remove a paper misfeed.

(3) Output tray of folding unit

Folded output is delivered to this tray.



Do not place heavy objects on the folding unit or press down on the folding unit.



INSERTER

Covers and insertion sheets to be inserted into printed sheets can be loaded.

Using the manual finishing function, you can directly feed paper into the finisher (large stacker) or saddle stitch finisher (large stacker) to staple, punch or fold the paper.



For detailed information on paper that can be loaded into the inserter, see the "SPECIFICATIONS" in the "Start Guide".

PART NAMES

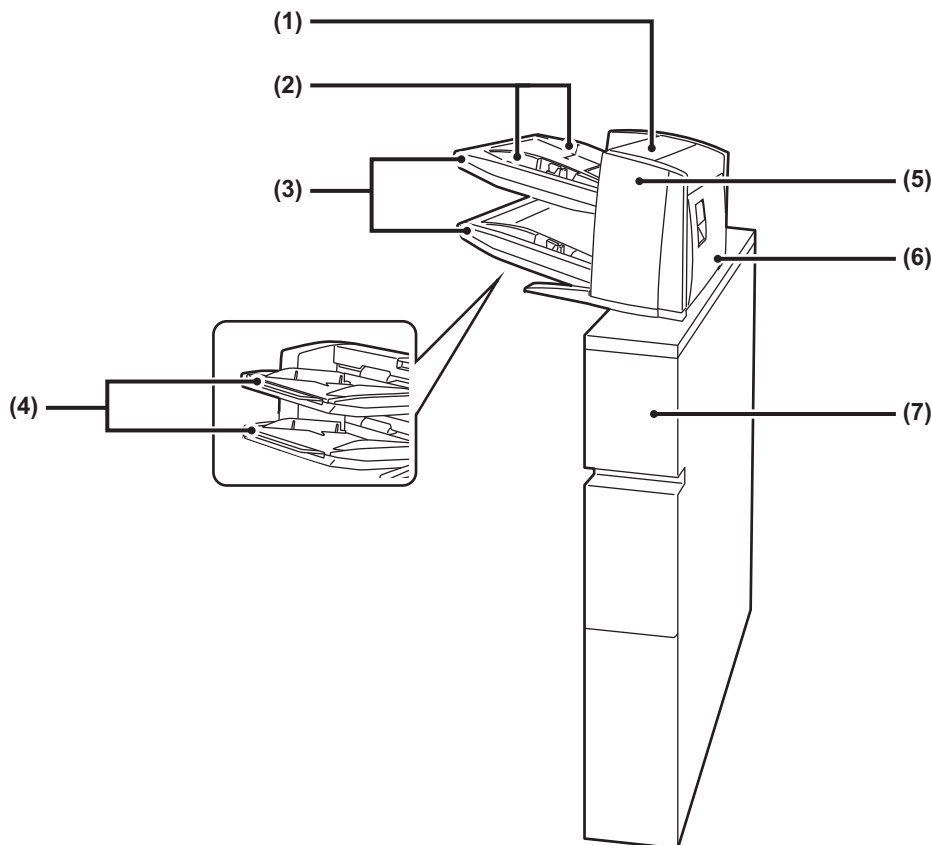

(1) Paper insertion unit cover

Open this cover to remove a paper misfeed.

(2) Paper guide

Push the lock lever to adjust to the paper size.

(3) Paper tray (upper/lower)

Insert paper or printed paper. A maximum of 200 sheets of paper can be loaded into each tray.

(4) Bypass tray extension

Extend this when loading paper larger than 8-1/2" × 11"R or A4R.

(5) Paper transfer unit front cover

Open this cover to remove a paper misfeed.

(6) Paper transfer unit rear cover

Open this cover to remove a paper misfeed.

(7) Cover

Open this cover to remove a paper misfeed.



PUNCH MODULE (MX-PN16B)

The punch module can be installed on a finisher or saddle stitch finisher to punch holes in paper to be output.



A finisher or saddle stitch finisher is required to install the punch module.

DISCARDING PUNCH WASTE

Punch waste from punched holes is collected in the punch waste box. Follow the operation procedure to replace punch waste.

1

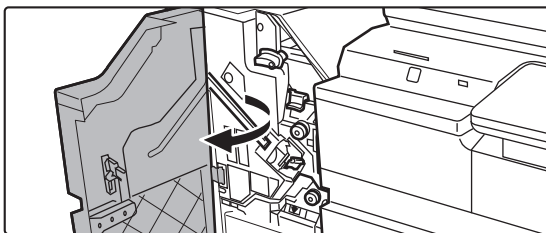

Open the front cover.

2

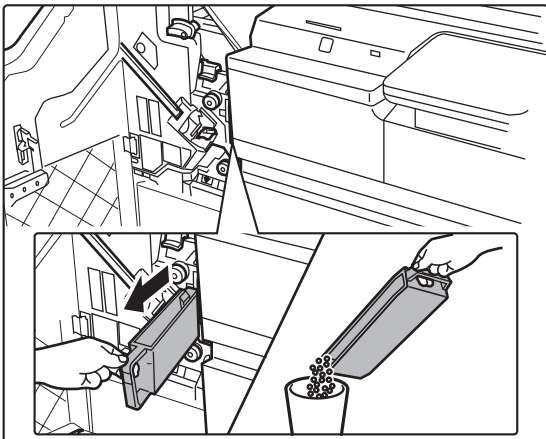

Pull out the punch waste box and discard the punch waste.

3

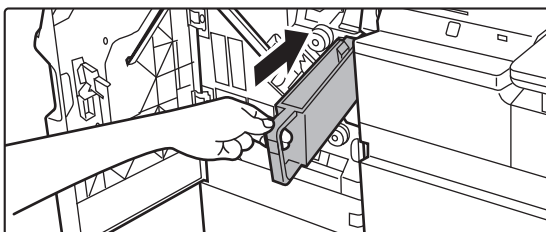

Replace the punch waste box.

If the punch waste box is not replaced properly, printing will not be possible to use the punch function.



4

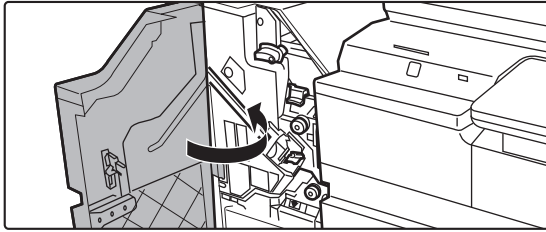

Close the front cover.



PUNCH MODULE (MX-PN13B)

The punch module can be installed on a finisher (large stacker) or saddle stitch finisher (large stacker) to punch holes in paper to be output.



A finisher (large stacker) or saddle stitch finisher (large stacker) is required to install the punch module (large stacker).

DISCARDING PUNCH WASTE

Punch waste from punched holes is collected in the punch waste box. Follow the operation procedure to replace punch waste.

1

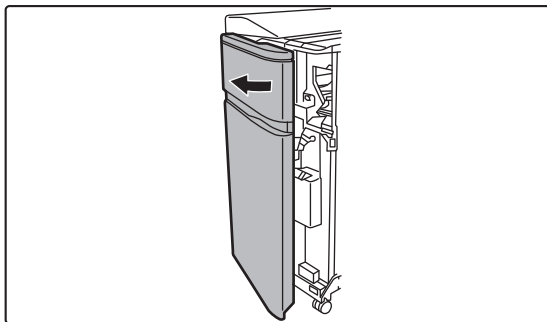

Open the front cover.

2

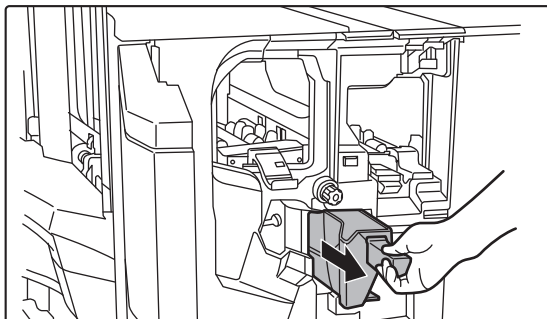

Grasp the punch waste box handle, gently pull out the box, and discard the punch waste.

Discard the punch waste in a plastic bag or other container, taking care not to let the waste scatter.

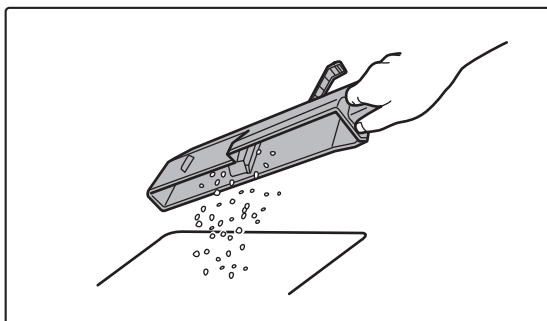



3

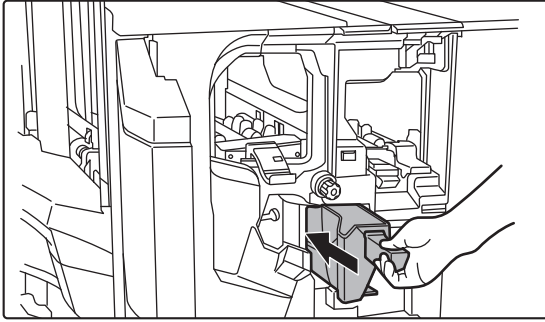

Gently push the box back in.

4

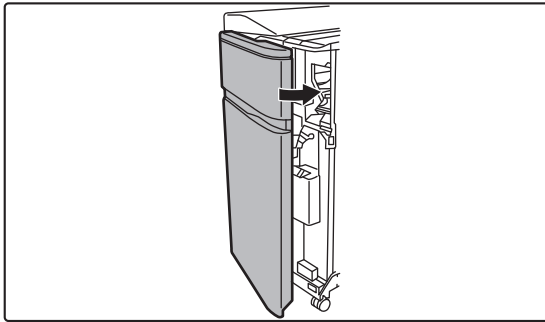

Close the front cover.



MAINTENANCE

REGULAR MAINTENANCE

To ensure that the machine continues to provide top quality performance, periodically clean the machine.



Do not use a flammable spray to clean the machine. If gas from the spray comes in contact with hot electrical components or the fusing unit inside the machine, fire or electrical shock may result.



- Do not use thinner, benzene, or similar volatile cleaning agents to clean the machine. These may degrade or discolor the housing.
- Use a soft cloth to gently wipe off dirt from the area on the operation panel with a mirror-like finish (shown at right). If you use a stiff cloth or rub hard, the surface may be damaged.

CLEANING THE DOCUMENT GLASS AND AUTOMATIC DOCUMENT FEEDER

If the document glass or document backplate sheet becomes dirty, the dirt will appear as dirty spots, black lines, or white lines in the scanned image.

Wipe the parts with a clean, soft cloth.

If necessary, moisten the cloth with water or a small amount of neutral detergent. After that, wipe with a clean dry cloth.

Examples of lines in the image



Document glass

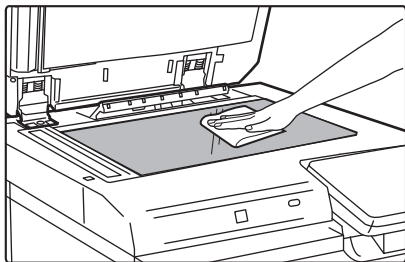

Document backplate sheet

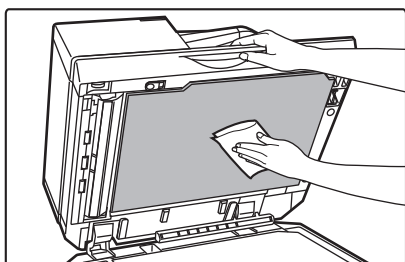



SCANNING AREA

If black lines or white lines appear in images scanned using the automatic document feeder, clean the scanning area (the thin long glass next to the document glass).

To clean this part, use the glass cleaner that is stored in the automatic document feeder. After using the glass cleaner, be sure to return it to its storage position.

1

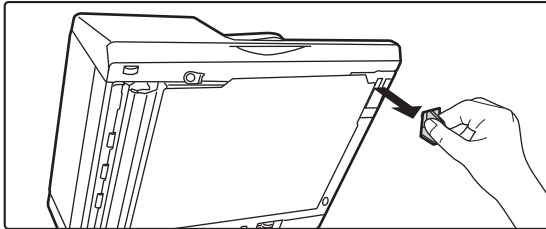

Open the automatic document feeder and remove the glass cleaner.

2

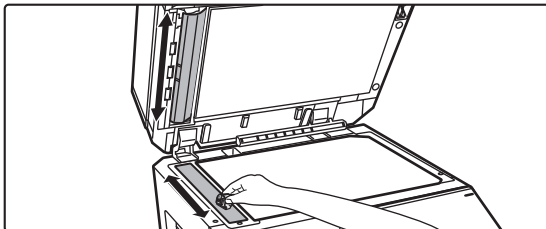

Clean the document scanning area on the document glass with the glass cleaner.

One scanning area is on the document glass and the other is inside the automatic document feeder.

3

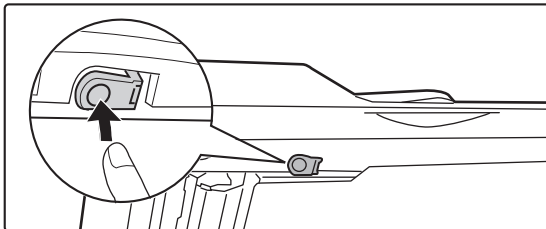

Open the scanning area cover on the automatic document feeder.

Push in the release switch to release the cover.

4

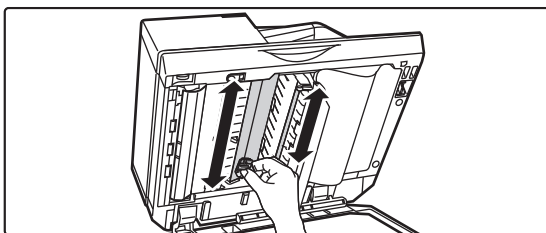

Clean the scanning area in the automatic document feeder.

5

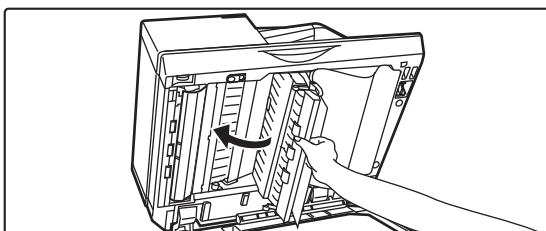

Close the cover.



6

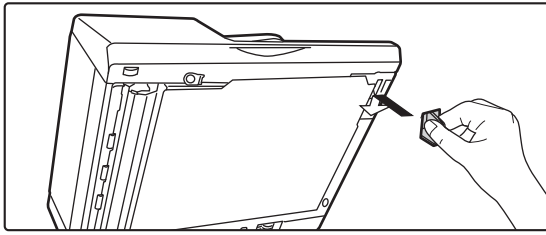

Replace the glass cleaner.

CLEANING THE BYPASS FEED ROLLER

If paper misfeeds frequently occur when feeding heavy paper through the bypass tray, wipe the surface of the feed roller with a clean soft cloth moistened with water or a neutral detergent.

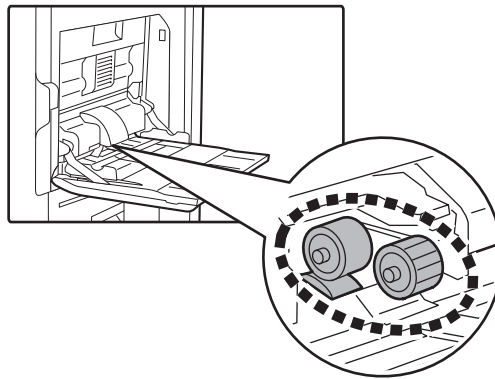



CLEANING THE PAPER FEED ROLLER

When using the automatic document feeder, if the placed original is smudged or jammed, wipe the surface of the paper feed roller in the direction of the arrow with a clean, soft cloth moistened with water or a neutral detergent.

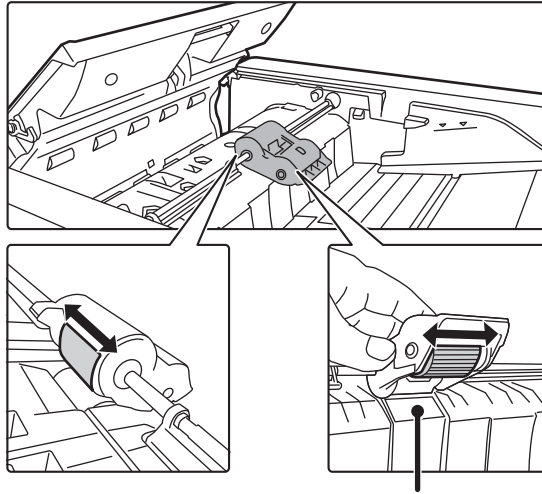

Be careful not to bend or detach the plastic sheet.



REPLACEMENT OF TONER CARTRIDGE

Always replace the toner cartridge after the "Change the toner cartridge." message appears. You should keep one set of replacement toner cartridges on hand so that you can replace a toner cartridge immediately when toner runs out.



Empty toner cartridge can be replaced without interrupting a copy/print job.

REPLACEMENT MESSAGE

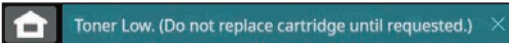

When this message appears, prepare a toner cartridge for replacement.



If you continue printing, the following message appears.

When this message appears, prepare a toner cartridge for replacement and replace it.

In this state, printing is possible.

However, this message does not appear during printing.

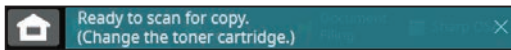
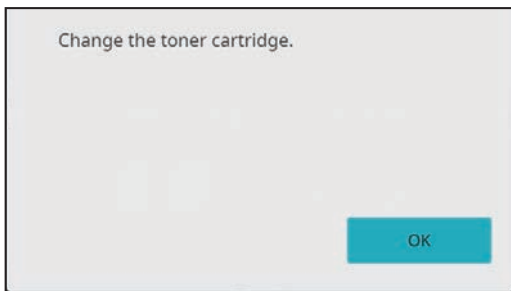

If you continue to use the machine, the following message will appear when the toner runs out.

Once the machine enters this state, printing can not be carried out until the toner cartridge is replaced.

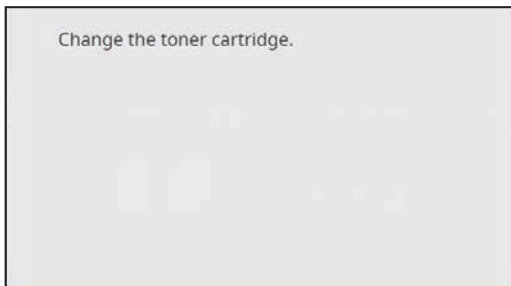



1

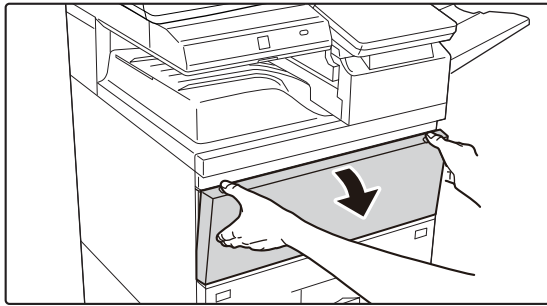

Open the front cover.

Hold both sides and close.

2

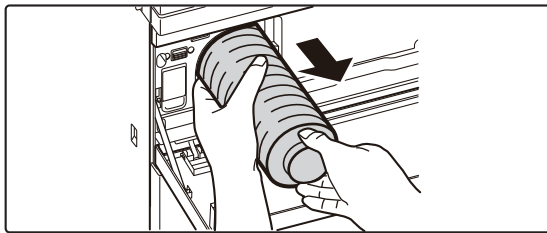

Pull the toner cartridge toward you.

Gently pull out the toner cartridge horizontally.
If the cartridge is pulled out abruptly, toner may spill out.
Hold the toner cartridge with both hands as shown and slowly pull it out of the machine.

3

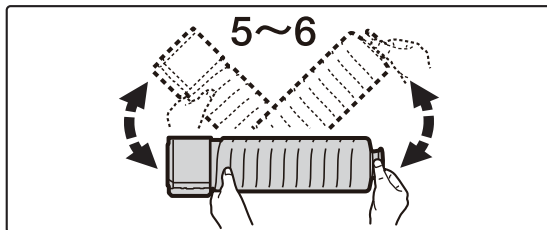

Take out a new toner cartridge from its package and shake it five or six times.

4

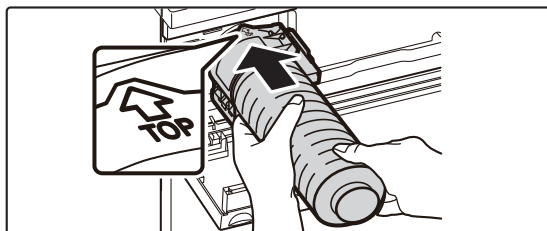

Slowly insert the new toner cartridge on the level.

5

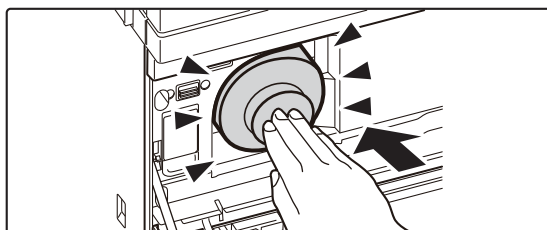

Press in firmly until you hear a "click" sound



6

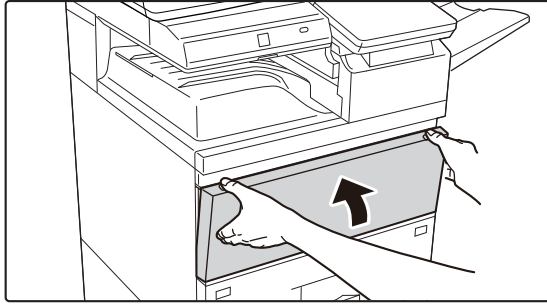

Close the front cover.

After the toner cartridge is replaced, the machine automatically enters image adjustment mode. Do not open the front cover while this is occurring. Hold both sides and close.



- Do not throw a toner cartridge into a fire. Toner may fly and cause burns.
- Store toner cartridges out of reach of small children.
- If a toner cartridge is stored upright, the toner may harden and become unusable. Always store toner cartridges on their side.
- If a toner cartridge other than a SHARP-recommended toner cartridge is used, the machine may not attain full quality and performance and there is a risk of damage to the machine. Be sure to use a SHARP-recommended toner cartridge.



- Depending on your conditions of use, the color may become light or the image blurred.
- Your service technician will collect used toner cartridges. Your service technician will collect them.
- To view the approximate amount of toner remaining (indicated in %), hold down the [Home Screen] key during printing or in standby mode. When the percentage falls to "25-0%", keep a toner cartridge for replacement purposes before toner runs out.
- When toner runs out while the home screen is displayed, the "Toner Empty" message appears in the upper right corner of the screen.



REPLACING THE TONER COLLECTION CONTAINER

The toner collection container collects excess toner that is produced during printing. When the toner collection container becomes full, the message "Replace toner collection container." will appear.

Replace the toner collection container as instructed by the message in the touch panel.

When the key is tapped, instructions for replacing the toner collection container will appear. Follow the instructions.

When the toner collection container is replaced, the message will automatically disappear.



- Do not throw the toner collection container into a fire. Toner may fly and cause burns.
- Store the toner collection container out of the reach of small children.



Do not touch the internal cords or connectors.

1

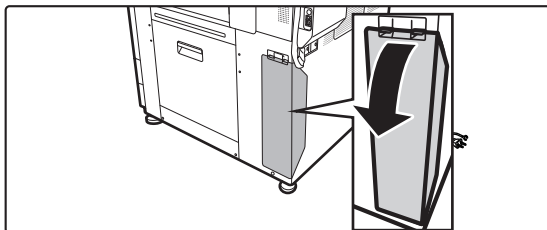

Open the cover for toner collection container.

2

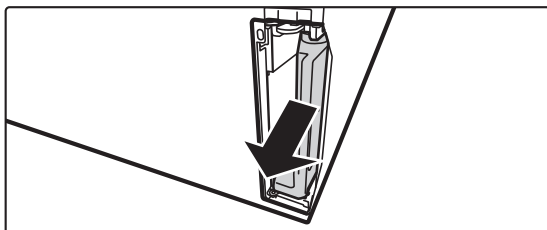

Remove the toner collection container.

Hold the handle of the toner collection container and slowly remove it toward you.



3

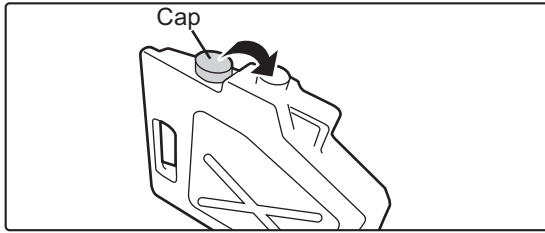

Place the toner collection container on a flat surface and close the cap.

Place a sheet of paper such as newspaper on the surface before placing the toner collection container.



- Keep the toner collection container in an upright position without collapsing it.
- Do not point the holes down as used toner will spill out.
- Do not throw away the removed toner collection container, instead place it in the plastic bag provided and keep it in the box in which it was packed.

4

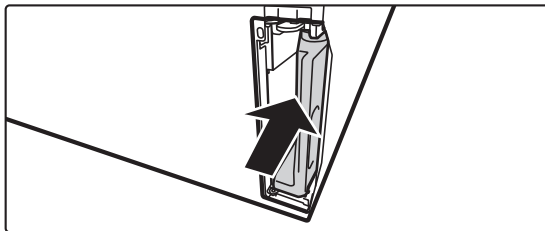

Install a new toner collection container.

Hold the handle of the toner collection container and push it all the way in.

5

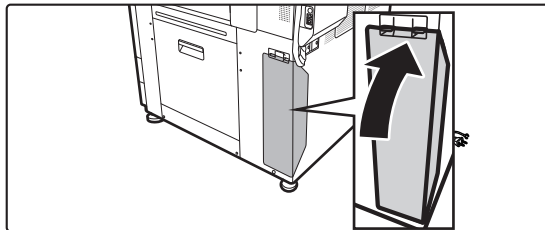

Close the cover for toner collection container.



OPERATION OF THE MACHINE

TOUCH PANEL

TOUCH TYPES	2-2
OPERATION TYPES	2-2
OPERATION OF FREQUENTLY USED KEYS	2-5
ACTION PANEL	2-6
SYSTEM INFORMATION SCREEN	2-6

HOME SCREEN AND PREVIEW SCREEN

HOME SCREEN	2-7
OVERVIEW	2-7
ICON INDICATING THE STATUS OF THE MACHINE	2-9
PREVIEW SCREEN	2-11

CHANGE THE DISPLAY OF THE TOUCH PANEL

EDITING THE HOME SCREEN	2-17
ADDING SHORTCUT KEYS	2-17
EDITING SHORTCUT KEYS	2-20
CHANGING A SHORTCUT KEY	2-23
ADDING A SHORTCUT KEY IMAGE	2-26
MOVING A SHORTCUT KEY	2-28
RETURNING THE SHORTCUT KEYS TO THE FACTORY DEFAULT STATE	2-30
CHANGING THE TRANSPARENCY OF A SHORTCUT KEY	2-33
CHANGING THE LAYOUT PATTERN OF THE HOME SCREEN	2-35
SELECTING A MFP DISPLAY PATTERN FOR THE HOME SCREEN	2-37
CHANGING THE COLOR OF TEXT ON THE HOME SCREEN	2-39
CHANGING THE BACKGROUND IMAGE OF THE HOME SCREEN	2-41
CHANGING THE FIXED KEYS	2-44
INCREASING THE TEXT SIZE	2-46
CHANGING THE LANGUAGE USED ON THE MACHINE	2-47
CHANGING THE POSITION OF THE [Home Screen] KEY	2-50

JOB STATUS

STOPPING/DELETING A JOB, PRIORITY PROCESSING AND CHECKING THE STATUS	2-52
TYPES OF JOB STATUS SCREENS	2-52
STOPPING/DELETING A JOB IN PROGRESS OR RESERVED	2-54
PRIORITY PROCESSING OF A RESERVED JOB	2-55
CHECKING A RESERVED JOB OR THE JOB IN PROGRESS	2-57
CHECKING COMPLETED JOBS	2-58
READING THE JOB LIST	2-59

CHARACTER ENTRY

CHARACTER ENTRY	2-62
NAMES AND FUNCTIONS OF SOFT KEYBOARD KEYS	2-62
SET THE KEYBOARD SETTING	2-63



TOUCH PANEL

TOUCH TYPES

OPERATION TYPES

In addition to tapping, equivalent to conventional touching, the touch panel of the machine can be operated by long touching, flicking and sliding.

	<p>Tapping Touch the panel with your finger and then lift it quickly. Use this method to select a key, tab or check box.</p>		<p>Sliding Slide the scroll bar (with your finger touching the panel) to scroll up and down a list with a large number of items.</p>
	<p>Long touching Touch the panel with your finger and hold it for a while. Keep holding (long touching) it on the action panel or characters in the text box to display characters in a balloon.</p>		<p>Double tapping Touch the screen twice. Use this operation to enlarge the image in the preview.</p>
	<p>Flicking Flick the panel to scroll a preview image quickly.</p>		<p>Pinch Touch the screen with two fingers and move them toward each other. This is used to reduce the browser and preview display.</p>
	<p>Dragging Drag (slide your finger touching the panel in a random direction) to replace a page in the original during preview.</p>		<p>Spread Touch the screen with two fingers and move them away from each other. This is used to enlarge the browser and preview display.</p>



Operation on respective screens

Key (tapping)

- A. Tap to select an item. The selected key turns into a different color.
- B. Tap numeric keys to enter numbers.
- C. Tap to increase or decrease the value. Long touching causes the value to be increased or decreased until you stop touching.
- D. Tap to enter a checkmark and enable the setting.
- E. Tap here to close the screen

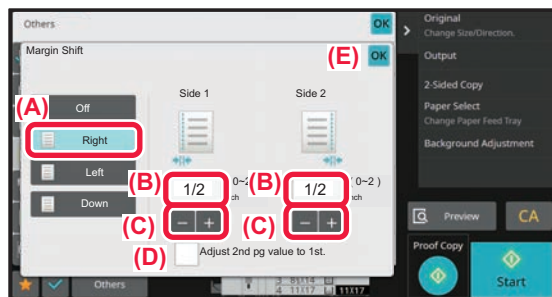

List (tapping, sliding and flicking)

- A. Tap to select an item. The selected item turns into a different color.
- B. Slide the bar up and down. It appears when the item does not fit in the screen.
- C. Flick the key upwards or downwards. The item scrolls up or down.

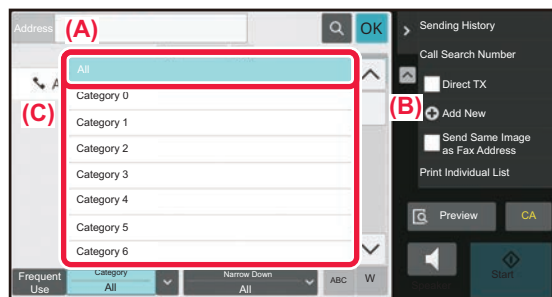

Slider (sliding)

- A. Slide the knob from side to side.

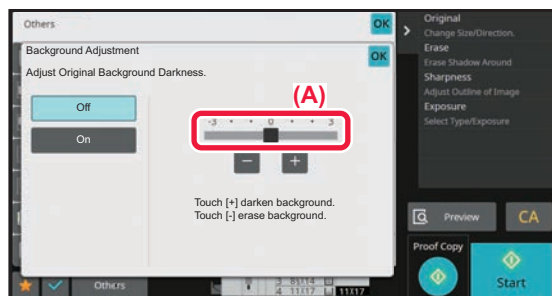



Tab (tapping)

A. Tap a tab to switch what is displayed.

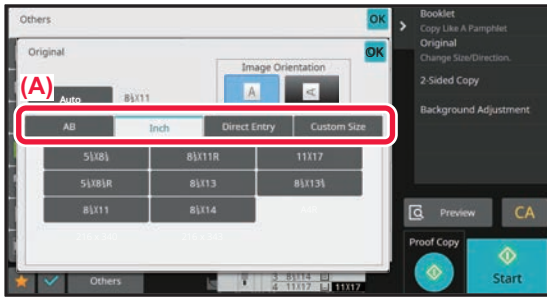

Preview screen (Double tapping/ Pinch/ Spread)

A. When a preview screen is "pinched", the screen image is reduced. When "spread", the image is enlarged. When "Double tapping", the image is also enlarged.

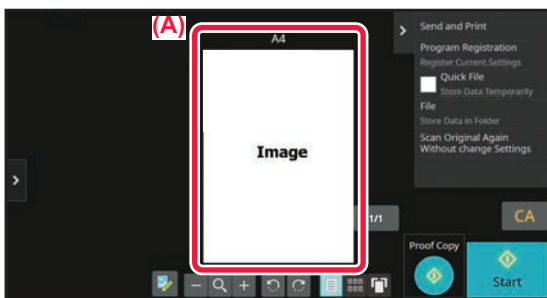



OPERATION OF FREQUENTLY USED KEYS

Numeric keys

Tap a number to enter it.

To clear the entered number, tap the [C] key

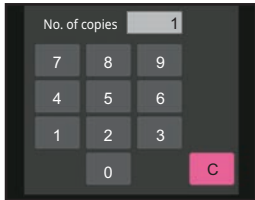

On the address screen, you can enter characters other than numbers, and a different key layout is provided. You can also move the cursor by using the [←] and [→] keys. Tap the [C] key to delete one character to the left of the cursor.

[Start] key

Tap to perform a print or send job.

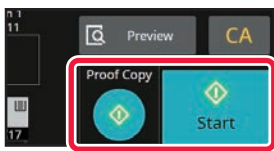

In easy scan mode, [B/W Start] and [Color Start] keys are displayed.

[Cancel Copy] key, [Storing Canceled] key, [Cancel Scan] key, [Sending canceled] key

Tap to stop copying, printing, or transmission.

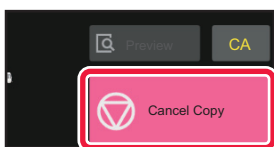

[CA] key

Tap to cancel all settings and restore the initial status in each mode.

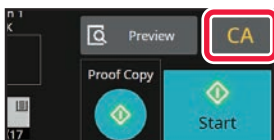



ACTION PANEL

Recommended functions are displayed on the action panel when you configure functions in each mode.

From the action panel, you can configure functions or combine the configured function with a function displayed on the action panel.

If the action panel does not appear, tap the action panel tab.

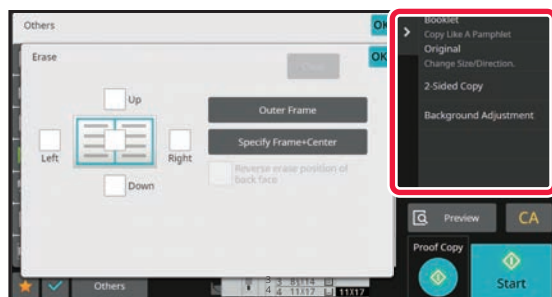

The functions displayed on the action panel vary depending on the mode or the functions that have been configured.

If too many functions have been configured to be displayed on the action panel, you can slide the panel vertically or tap and to view all.

In enlarge display mode, part of the text on the action panel may not be displayed. To display the whole text, long-touch the partially hidden key or slide the tab of the action panel to the left.

SYSTEM INFORMATION SCREEN

Tap the [System Info.] key in the System Information area at the top of the touch screen to display the System Information screen.

In addition, in case that an error has occurred to this machine, this screen is displayed automatically to show the details of an error.

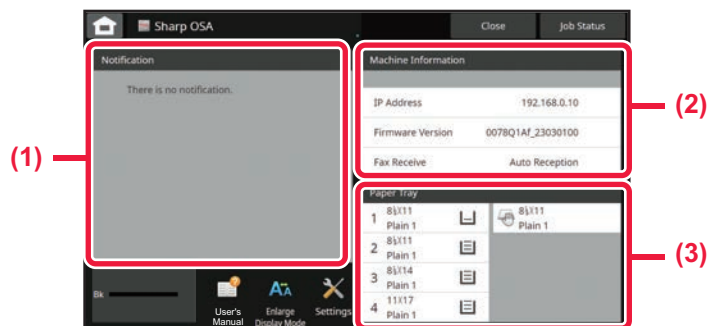

(1) Notification

If there is an error which requires an user operation to recover, such as toner outage or transmission error, an instruction is displayed here.

If → is displayed on the right side of the Notification list, tap → to jump to the setting screen where the error originated in.

Notifications disappear from the list when problems are resolved.

(2) Machine Information

The status of the machine, such as network connection status and firmware version, will be displayed.

(3) Paper Tray

Size, type, and remaining amount of paper inside the machine are displayed. Tap here to jump to the Paper Tray Settings screen.



HOME SCREEN AND PREVIEW SCREEN

HOME SCREEN

Tapping the [Home Screen] key displays the home screen on the touch panel. The home screen displays the keys for selecting modes or functions.

OVERVIEW

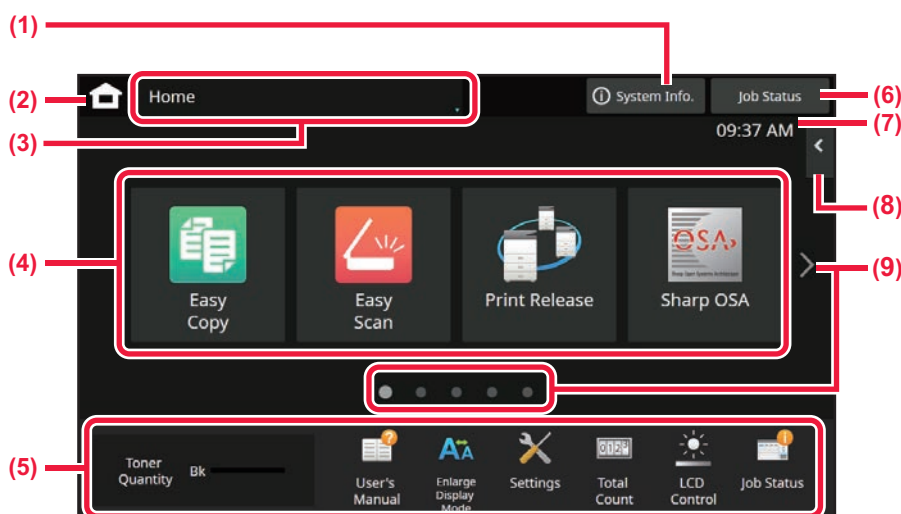

(1) System Information area

Tap this area to display the System Information screen.

► [SYSTEM INFORMATION SCREEN \(page 2-6\)](#)

(2) [Home Screen] key

Switch to the home screen.

(3) Mode selection area

The mode selection screen is displayed.

(4) Shortcut keys

Select shortcut keys for modes or functions.

► [EDITING THE HOME SCREEN \(page 2-17\)](#)

(5) Fixed display key

Use these keys to select functions that make the machine easier to use.

(6) [Job Status] key

Displays the job in progress or waiting with text or icon.

► [JOB STATUS \(page 2-52\)](#)

(7) Clock

Displays the time.

(8) Action panel

Select functions that can be utilized in respective modes. Tap the tab, and the list of function keys is displayed.

► [ACTION PANEL \(page 2-6\)](#)

(9) Home screen page switching key

Switch the pages for displaying shortcut keys.



Recent jobs

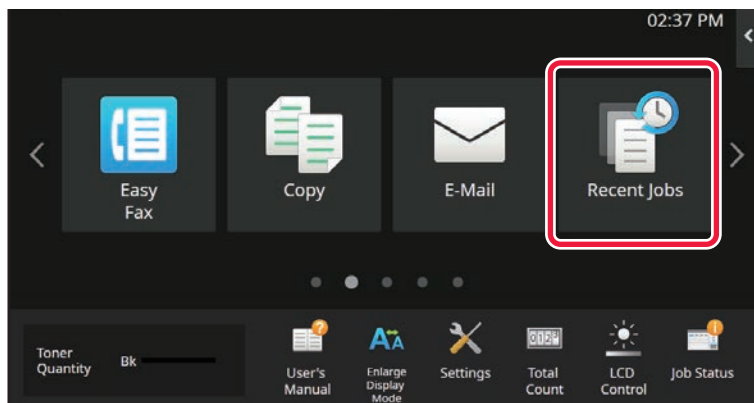

Tap this key to display the contents of the most recently used jobs in a list.
Tap an item in the list to set the contents in the list.

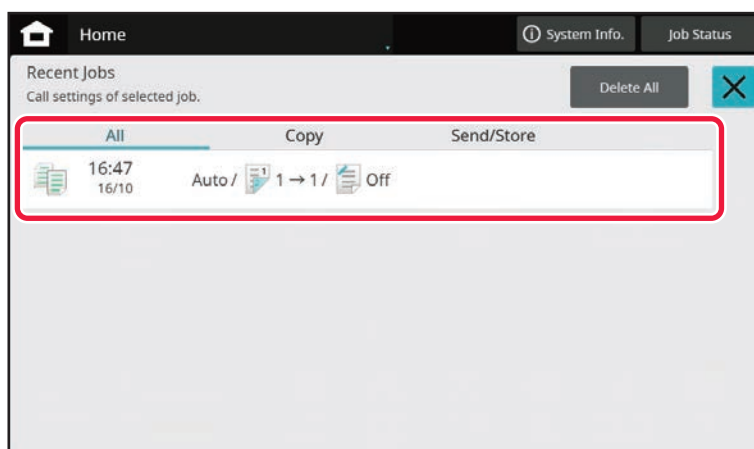



ICON INDICATING THE STATUS OF THE MACHINE

Icon	Machine status	Icon	Machine status
	Printer data is being processed.		A USB device is installed.
	Printer data is being printed.		The field support system is enabled.
	Send data exists.		Single-byte alphanumeric character entry
	Forward error data exists.		A data security kit is installed.
	Received data exists.		Connecting to the access point (Level 4)
	Received confidential fax data exists.		Connecting to the access point (Level 3)
	Received data is held.		Connecting to the access point (Level 2)
	Received preview data exists.		Connecting to the access point (Level 1)
	OSA communication is in progress.		Not connected to the access point
	Enlarge display mode is enabled.		Bad connection of the wireless LAN device in the machine*
	Eco mode is enabled.		Waiting for the access point
	A maintenance notification is issued.		A LAN cable is not connected.
	Remote operation is in progress.		Bluetooth connection in progress
	Extended FSS function is enabled.		

* Contact your dealer or nearest SHARP Service Department.



CHANGING MODES

Changing mode from the Home screen

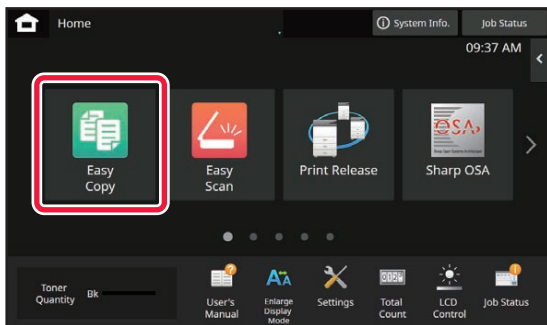
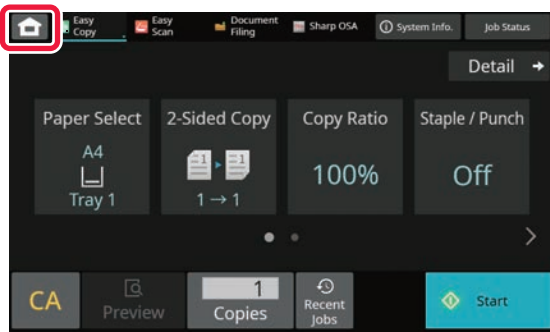

Changing mode from the mode display

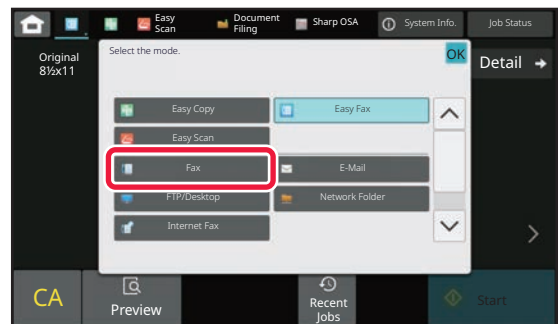
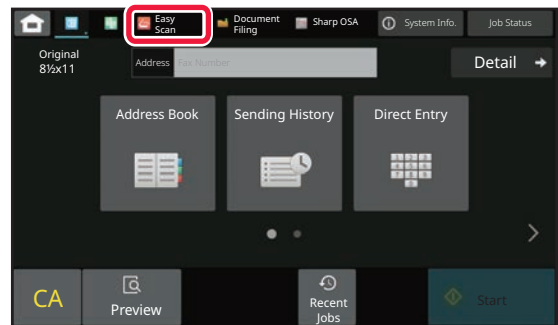
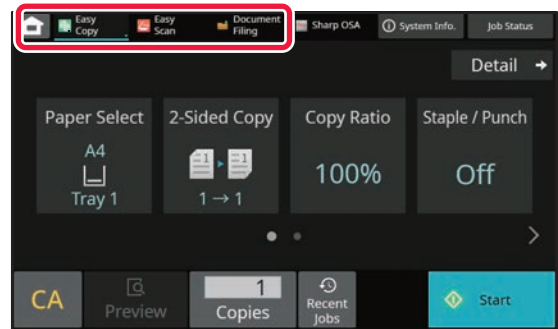

For procedures for editing the home screen, see "[EDITING THE HOME SCREEN \(page 2-17\)](#)".



PREVIEW SCREEN

In the preview screen, you can view output images or images stored in the machine using the touch panel.

[Easy mode]

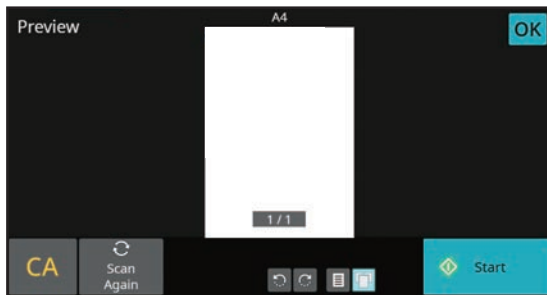

[Normal mode]

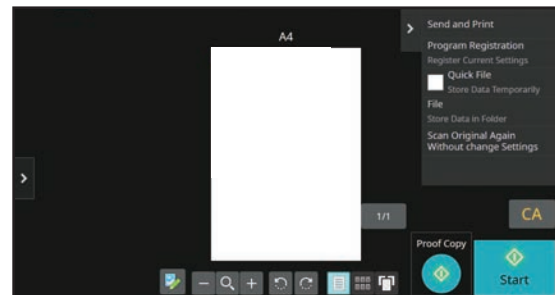

Keys used in the preview screen

	This changes the mode to edit mode. Pages of the original can be changed, rotated, or deleted.		This rotates the preview image of whole page in the arrow's direction. The printing result is not rotated.
	This reduces the image.		This displays preview images of respective pages.
	This displays the scroll bar for enlargement/reduction operations. Moving the slider to the left reduces the image, and moving the slider to the right enlarges the image.		This displays thumbnails of preview images.
	This enlarges the image.		This displays pages in a 3D view.

* Can also be used in Easy mode.



- The display position of an image can be moved by dragging it while it is enlarged.
- To enlarge an image, double-tap it when the preview image is displayed by page.



Deleting a page

1

In the preview screen, tap  to switch to edit mode.

2

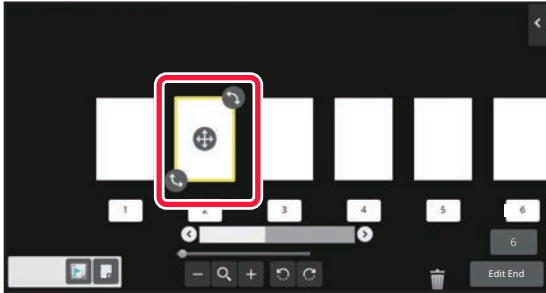



Tap the page you want to delete, and tap .

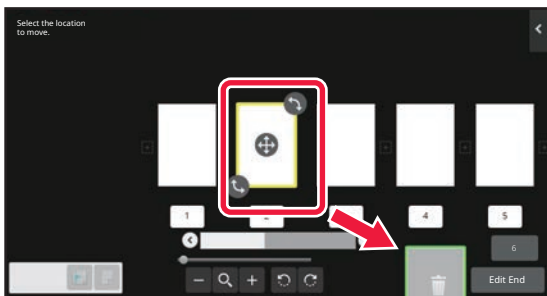

- You can also delete the page by tapping [Delete the Page] on the action panel.
- You can also delete the page by dragging a page to .



- To undo the deletion, tap . To redo the deletion, tap .

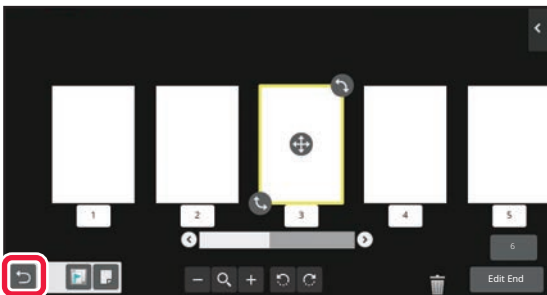

3

Tap the [Edit End] key.



Moving a page

1 In the preview screen, tap  to switch to edit mode.

2 Tap the page you want to move, and drag to move the page. 

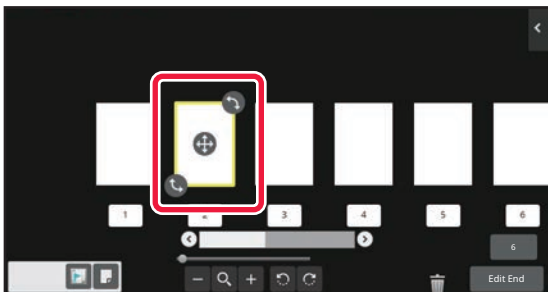

You can also move the page by tapping [Move the Page] on the action panel and then tap  of the destination.

3 Tap the [Edit End] key.

Rotating a page

1 In the preview screen, tap  to switch to edit mode.

2 Tap the page you want to rotate, and drag  or  to rotate the page.

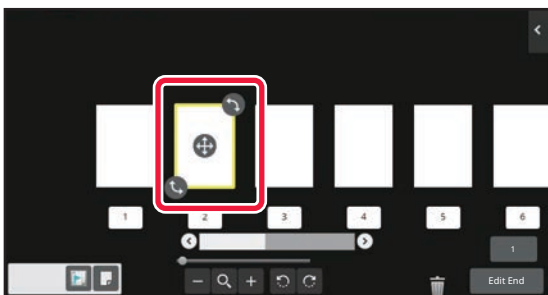

You can also rotate the page by tapping [Rotate 180 Degrees] (Copy mode only) or [Rotate 90 Degrees] (Fax and scanner mode only) on the action panel.

3 Tap the [Edit End] key.



Setting chapter inserts

When N-Up or 2-Sided is specified, you can move a page marked with  to the first page.

1

In the preview screen, tap  to switch to edit mode.

2

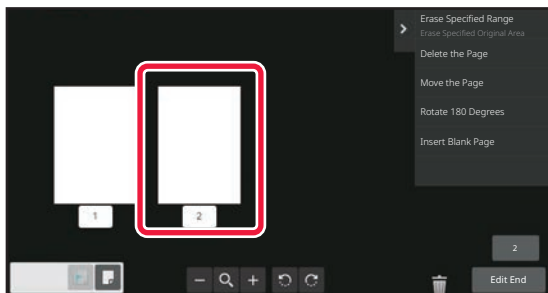

Tap the page you want to set chapter inserts.

3

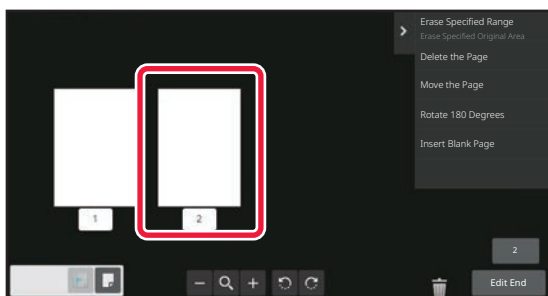

Tap .

 is displayed on the page.



• You can also set chapter inserts by tapping [Specify Chapter Inserts] on the action panel.

• **To cancel the Chapter Inserts setting:**

Tap  displayed on the page, or select the page and tap [Cancel Chapter Inserts of Selected Page.] on the action panel.

4

Tap the [Edit End] key.





Inserting a blank page

1

In the preview screen, tap  to switch to edit mode.

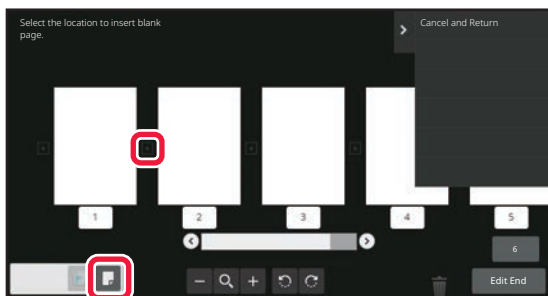
2



Tap , and tap  for the location into which you want to insert a blank page.



You can also insert a blank page by tapping [Insert Blank Page] on the action panel.

3

Tap the [Edit End] key.

Deleting part of the original image

1

In the preview screen, tap  to switch to edit mode.

2

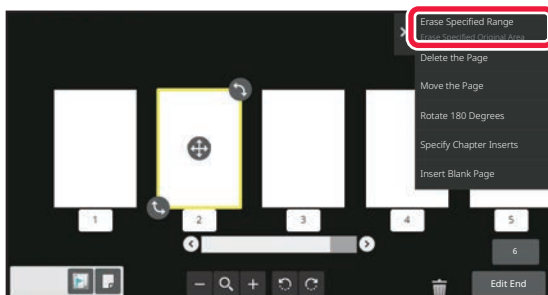

Tap [Erase Specified Range] on the action panel.



3

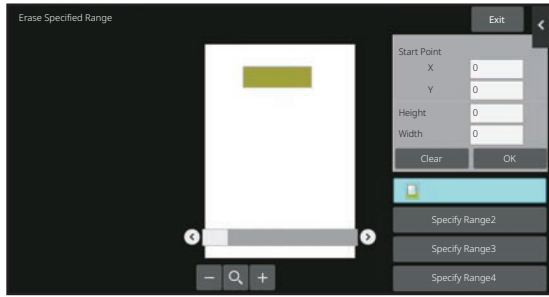

Follow the on-screen instructions to specify the erase range.

Specify the erase range and then tap the [Execute] key.



To delete the image outside the selected range, tap [Reverse Erase Range] on the action panel.

4

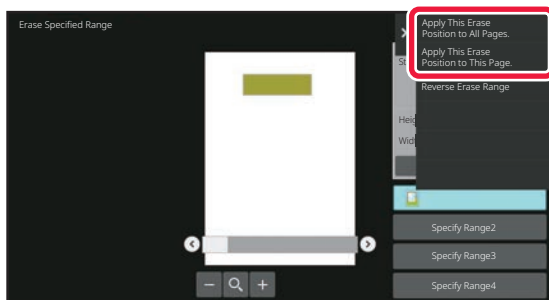

On the action panel, select [Apply This Erase Position to All Pages.] or [Apply This Erase Position to This Page.].

5

As necessary, repeat the steps to specify the erase range and the pages to which it is applied.

6

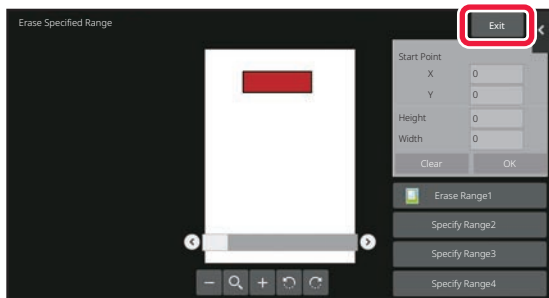

Tap the [Exit] key.

Changing the settings

Tapping the tab on the left of the screen allows you to change the settings. You cannot tap the keys for functions whose settings cannot be changed.

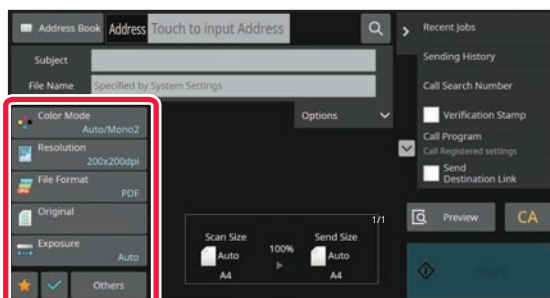



CHANGE THE DISPLAY OF THE TOUCH PANEL

EDITING THE HOME SCREEN

In the home screen, you can change the number of shortcut keys shown and change shortcut keys. This includes changing the background and text color, and changing the background to a custom image.

ADDING SHORTCUT KEYS

This section explains how to add a shortcut key to the home screen.

You can add a shortcut key using the touch panel, or from the Web page. In the Web page, you can change a shortcut key image to any custom image.

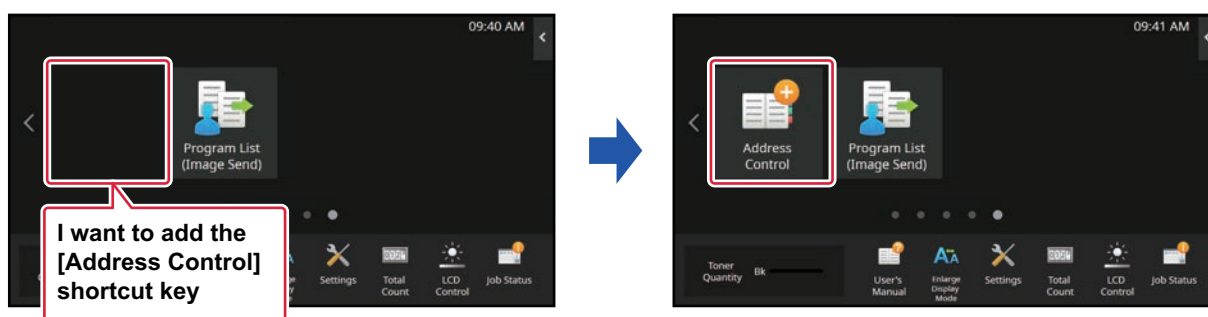

From the touch panel

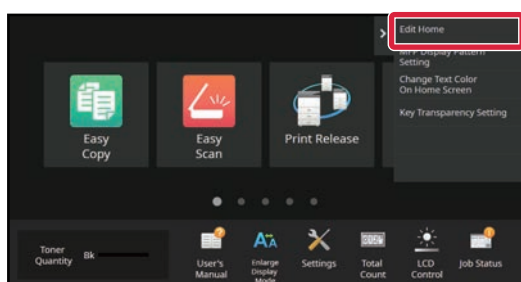
1

Open the action panel on the home screen, and tap [Edit Home].

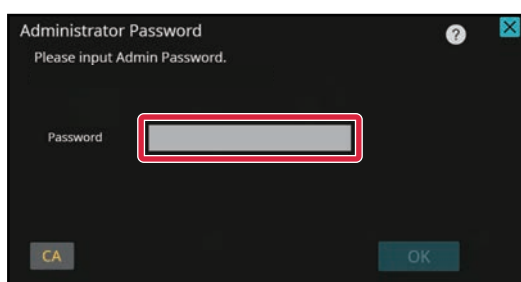
2

The administrator password screen appears. Enter your password.

Enter the administrator password.



3



Tap an empty shortcut key location.

4

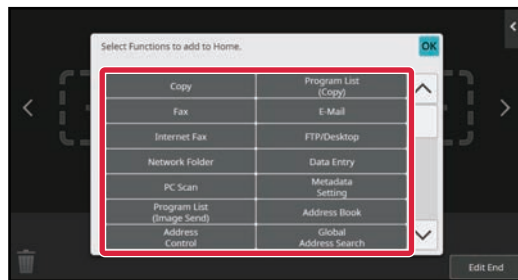

Tap the function you want to add.

The shortcut key will be added to the selected location.

5

After completing the settings, tap the [Logout] key.

From the Web page

1

Enter the IP address set in the machine in the address bar of your web browser.

In the factory default state, you must enter your user password after entering the IP address.

2

On the Web page, click the [System Settings] tab → [Home Screen Settings].

Some settings may require that you enter your user password after clicking [Home Screen Settings]. If you did not perform user authentication, you must enter the administrator password.

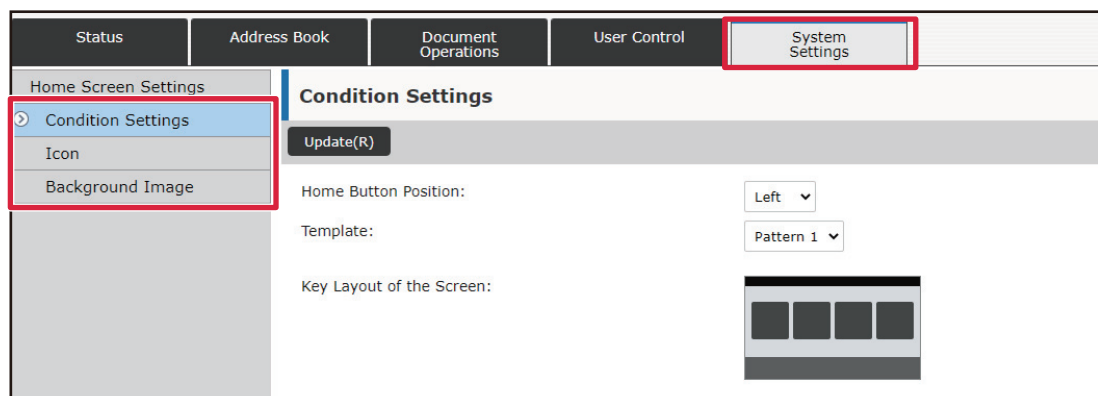



3

Select the function you want to add.

Status	Address Book	Document Operations	User Control	System Settings
Home Screen Settings	Home Screen Registration			
Condition Settings	Submit(U) Cancel(C)			
Icon	Home ButtonNo.31: Not Set			
Background Image	Copy:			
	<input checked="" type="radio"/> None			
	<input type="radio"/> Easy Copy			
	<input type="radio"/> Copier			
	<input type="radio"/> Program List			

To change the name of a shortcut key, select [Custom] in [Key Name] and enter the desired name in the text box.

Key Name: Default Custom (Up to 28 characters)

To change the image of a shortcut key, go to the next step. If you are not changing the image, go to step 5.

4

To change the image of a shortcut key, set the [Use Custom Image] checkbox to , and select a previously added image with [Select File].

To save an image, see "[ADDING A SHORTCUT KEY IMAGE \(page 2-26\)](#)".

5

When you have finished configuring the settings, click the [Submit] button.

The settings are saved in the machine and applied.

When you have finished settings, click the [Logout] button and close your Web browser.



EDITING SHORTCUT KEYS

You can add shortcut keys to the home screen, and delete unneeded shortcut keys.

You can also change the display order of the shortcut keys and change names and images to make the machine easier to use.

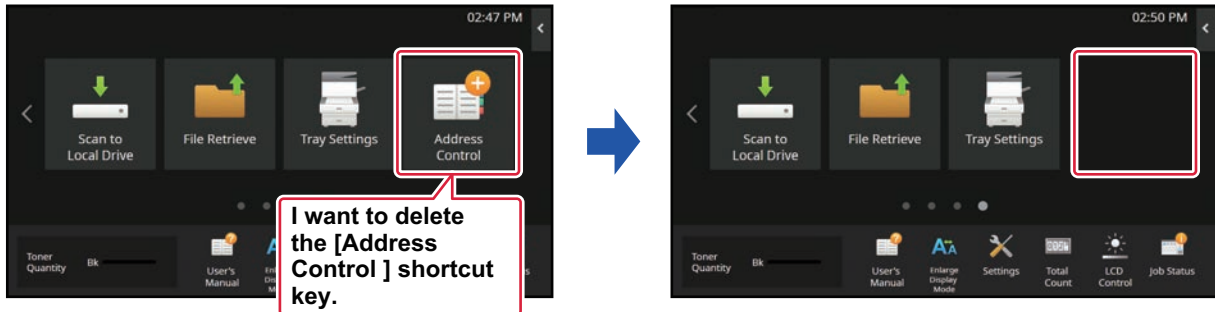

From the touch panel

1

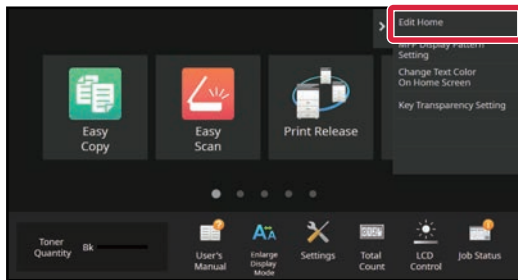

Open the action panel on the home screen, and tap [Edit Home].

2

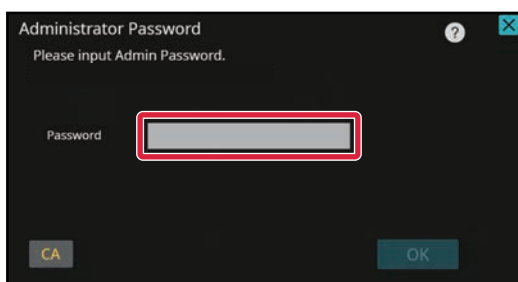

The administrator password screen appears. Enter your password.

Enter the administrator password.

3

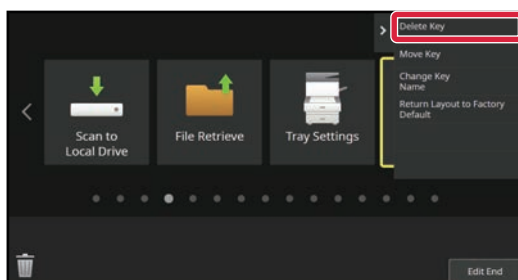

Tap the shortcut key you want to delete, and tap [Delete Key].

A yellow frame appears around the selected shortcut key.

With the shortcut key selected, tap .

You can also delete by dragging the shortcut key to .



4

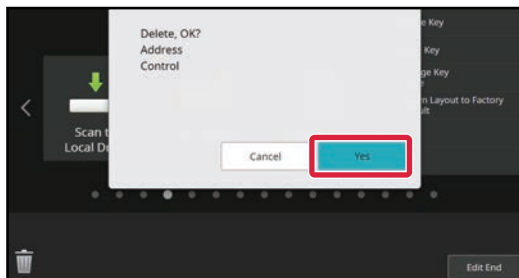

Tap the [Yes] key.

The selected shortcut key will be deleted.

5

After completing the settings, tap the [Logout] key.

From the Web page

1

Enter the IP address set in the machine in the address bar of your web browser.

In the factory default state, you must enter your user password after entering the IP address.

2

On the Web page, click the [System Settings] tab → [Home Screen Settings].

Some settings may require that you enter your user password after clicking [Home Screen Settings]. If you did not perform user authentication, you must enter the administrator password.

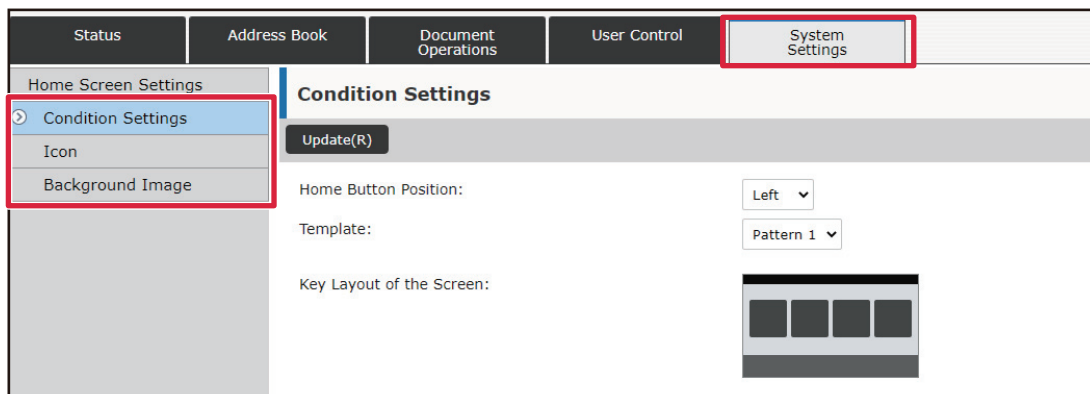



3

Click [Condition Settings] and click the shortcut key you want to delete.

Status	Address Book	Document Operations	User Control	System Settings
Home Screen Settings				
Condition Settings				
Icon				
Background Image				
No.	Home Button			
1	CLOUD PORTAL			
2	Easy Copy			
3	Easy Scan			
4	Easy Fax			
5	Sharp OSA			
6	Copy			
7	E-mail			
8	Fax			
9	FTP/Desktop			
10	Network Folder			

4

Select [None] and click the [Submit] button.

When you click the [Submit] button, the [Home Screen Registration] screen closes.

Status	Address Book	Document Operations	User Control	System Settings
Home Screen Settings				
Condition Settings				
Icon				
Background Image				
Home Screen Registration				
Submit(U) Cancel(C)				
Home ButtonNo.2:Easy Copy				
Copy:				
<input type="radio"/> None				
<input checked="" type="radio"/> Easy Copy				
<input type="radio"/> Copier				
<input type="radio"/> Program List				

5

When you have finished configuring the settings, click the [Submit] button.

The settings are saved in the machine and applied.

When you have finished settings, click the [Logout] button and close your Web browser.



CHANGING A SHORTCUT KEY

This section explains how to change a shortcut key in the home screen.

Only the name can be changed from the touch panel. You can change the icon image from the Web page.

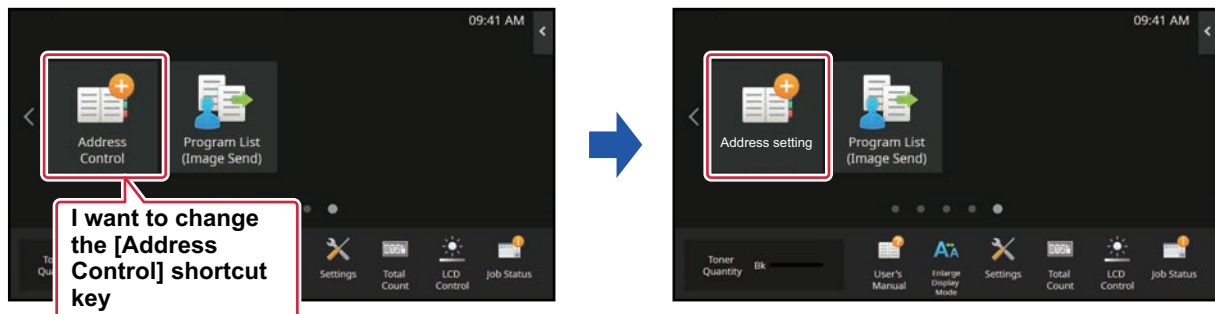

From the touch panel

To change a shortcut key from the touch panel, move the shortcut key in the desired location away from that location, and then register the new shortcut key in the location that has been freed. For information about how to move shortcut keys, see "[MOVING A SHORTCUT KEY \(page 2-28\)](#)". For information about how to add shortcut keys, see "[ADDING SHORTCUT KEYS \(page 2-17\)](#)".

This section explains how to change the name of a shortcut key.

1

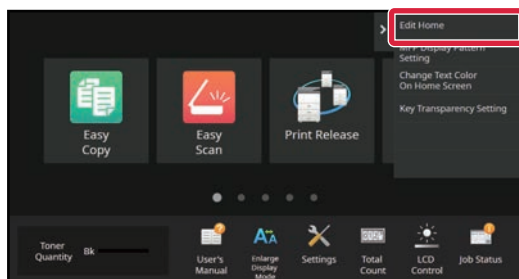

Open the action panel on the home screen, and tap [Edit Home].

2

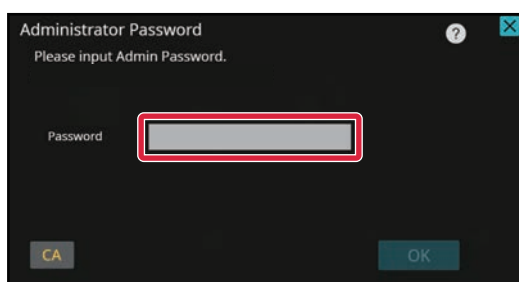

The administrator password screen appears. Enter your password.

Enter the administrator password.



3

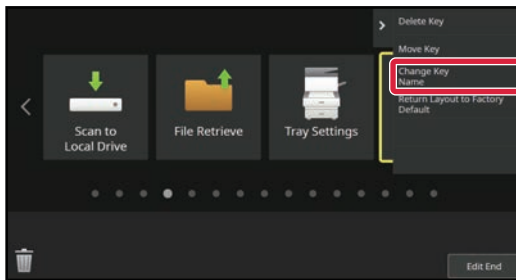

A yellow frame appears around the selected shortcut key.

A yellow frame appears around the selected shortcut key.

4

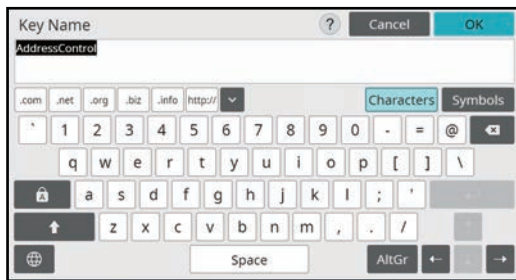

Enter the new name by keyboard.

Enter the name, and tap the [OK] key.

5

After completing the settings, tap the [Logout] key.

From the Web page

1

Enter the IP address set in the machine in the address bar of your web browser.

In the factory default state, you must enter your user password after entering the IP address.

2

On the Web page, click the [System Settings] tab → [Home Screen Settings].

Some settings may require that you enter your user password after clicking [Home Screen Settings]. If you did not perform user authentication, you must enter the administrator password.

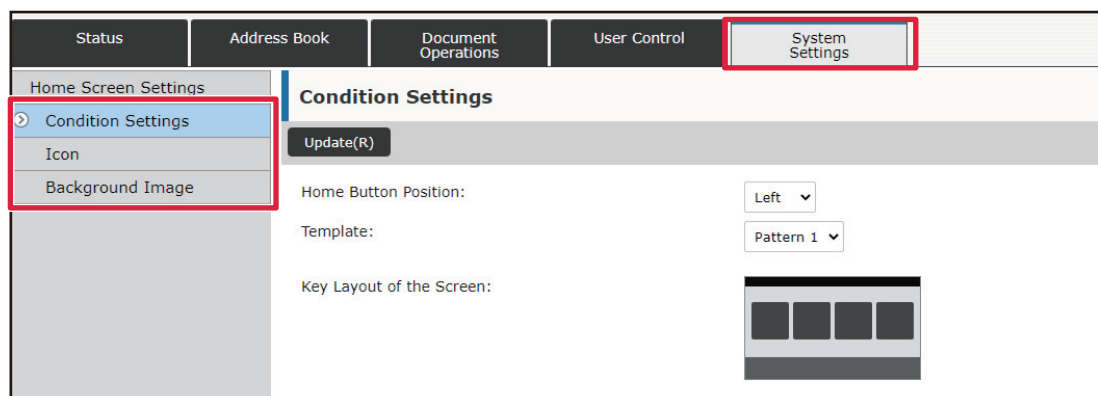



3

Click [Condition Settings], and click the shortcut key you want to change.

Status	Address Book	Document Operations	User Control	System Settings
Home Screen Settings				
Condition Settings				
Icon				
Background Image				

No.	Home Button
1	CLOUD PORTAL
2	Easy Copy
3	Easy Scan
4	Easy Fax
5	Sharp OSA
6	Copy
7	E-mail
8	Fax
9	FTP/Desktop
10	Network Folder

4

Select the desired function.

Status	Address Book	Document Operations	User Control	System Settings
Home Screen Settings				
Condition Settings				
Icon				
Background Image				

Home Screen Registration

Submit(U) Cancel(C)

Home ButtonNo.2:Easy Copy

Copy:

- None
- Easy Copy
- Copier
- Program List

To change the name of a shortcut key, select [Custom] in [Key Name] and enter the desired name in the text box.

Key Name:

Default

Custom (Up to 28 characters)

To change the image of a shortcut key, go to the next step. If you are not changing the image, go to step 5.

5

To change the icon image, set the [Use Custom Image] checkbox to , and select a previously added image with [Select File].

To save an image, see "[ADDING A SHORTCUT KEY IMAGE \(page 2-26\)](#)"

6

When you have finished configuring the settings, click the [Submit] button.

The settings are saved in the machine and applied.

When you have finished settings, click the [Logout] button and close your Web browser.



ADDING A SHORTCUT KEY IMAGE

To change a shortcut key image to a new image, you must first add the new image.

This section explains how to add an image. Images are added by using the Web page.

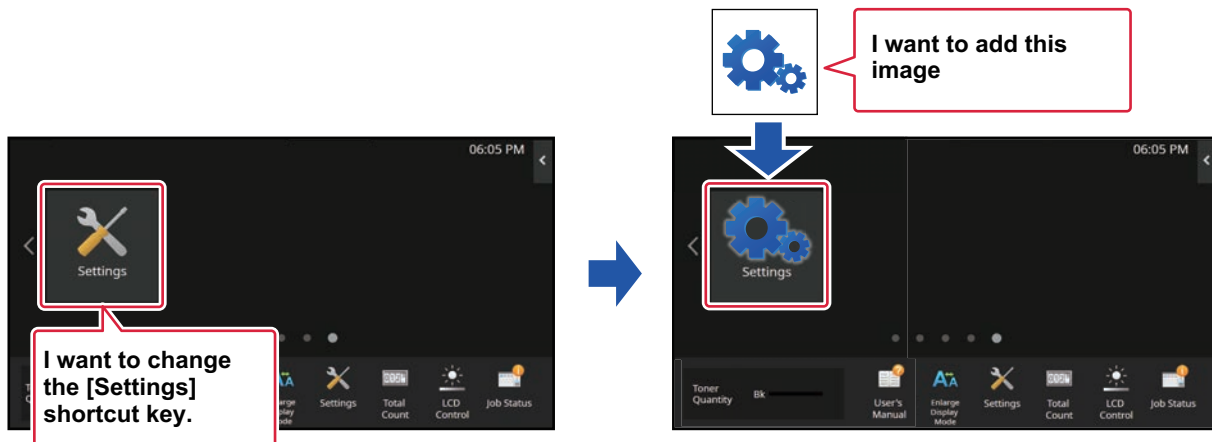

Icon images are automatically enlarged or reduced to match the size of the shortcut keys.

1

Enter the IP address set in the machine in the address bar of your web browser.

In the factory default state, you must enter your user password after entering the IP address.

2

On the Web page, click the [System Settings] tab → [Home Screen Settings].

Some settings may require that you enter your user password after clicking [Home Screen Settings]. If you did not perform user authentication, you must enter the administrator password.

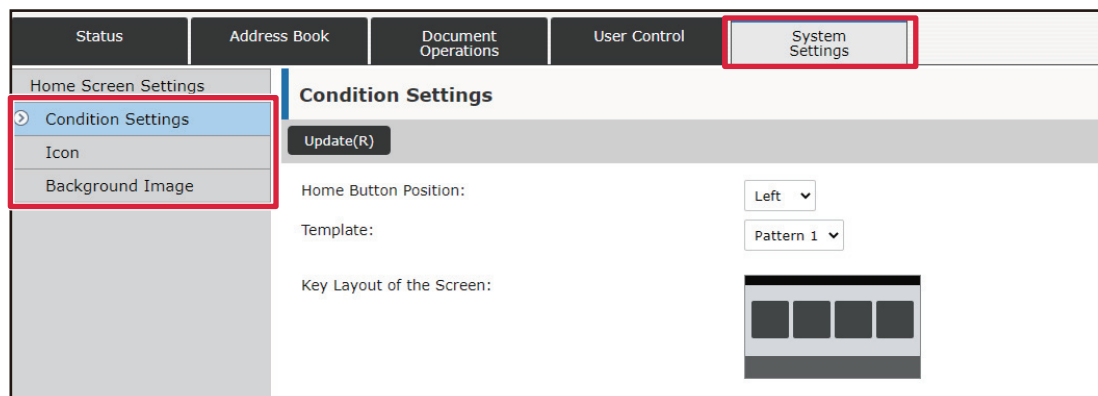

3

Click [Icon].



4

Select any item

If you are adding a new image, click "Not Set". If "Not Set" items are all in use, click an unneeded item in the already added items.

No.	Name
1	Not Set
2	Not Set
3	Not Set
4	Not Set
5	Not Set
6	Not Set
7	Not Set
8	Not Set
9	Not Set
10	Not Set

5

Select the file to be added in "Select File".

Click the [Browse] button, and select the image to be submitted.



- File formats that can be used are JPEG, GIF and PNG (jpeg, jpg, jpe, jfif, gif and png).
- The maximum file size of an image that can be used for a shortcut key is 50 KB.

6

When you have finished configuring the settings, click the [Submit] button.

The settings are saved in the machine and applied.

When you have finished settings, click the [Logout] button and close your Web browser.



MOVING A SHORTCUT KEY

This section explains how to move a shortcut key in the home screen. Shortcut keys are moved by using the touch panel.

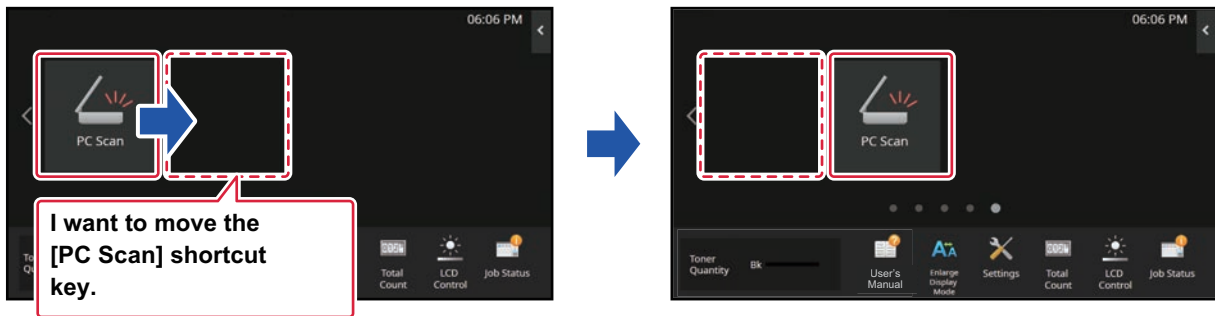

1

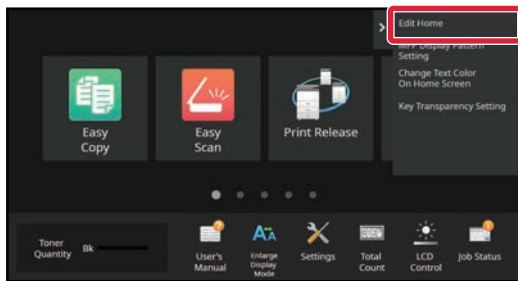

Open the action panel on the home screen, and tap [Edit Home].

2

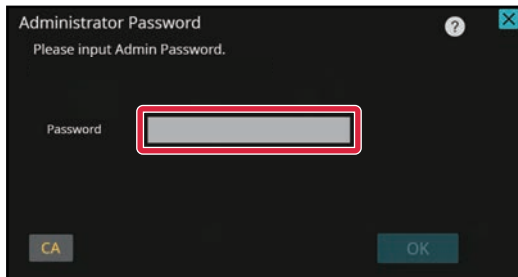

The administrator password screen appears. Enter your password.

Enter the administrator password.

3

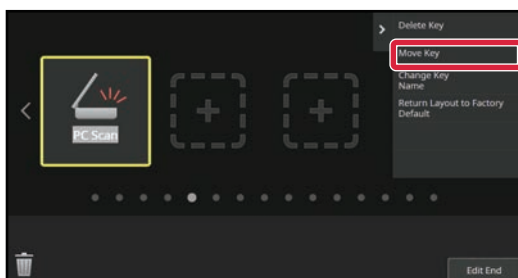

Tap the shortcut key you want to move, and tap [Move Key].

A yellow frame appears around the selected shortcut key.



4

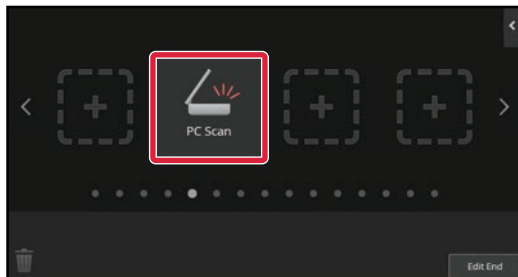
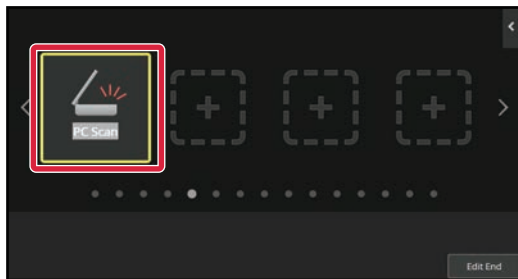

Tap an empty shortcut key location

The shortcut key moves to the tapped location.

The shortcut key will not move if you tap a location that already has a shortcut key.

5

After completing the settings, tap the [Logout] key.



RETURNING THE SHORTCUT KEYS TO THE FACTORY DEFAULT STATE

This section explains how to return the shortcut keys in the home screen to the factory default state. This procedure can be performed from the touch panel or from the Web page.

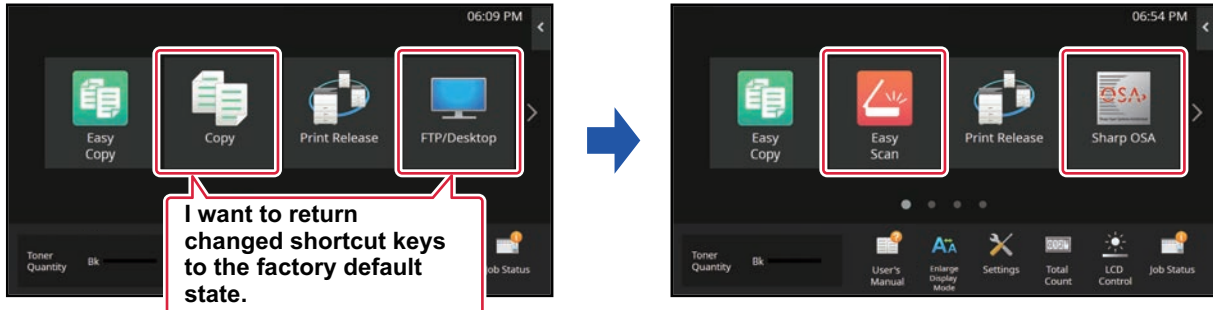

The positions, names, and images of the shortcut keys are returned to the factory default state.

From the touch panel

1

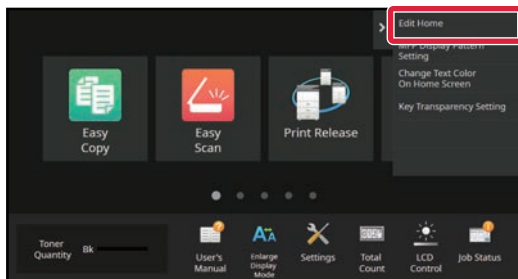

Open the action panel on the home screen, and tap [Edit Home].

2

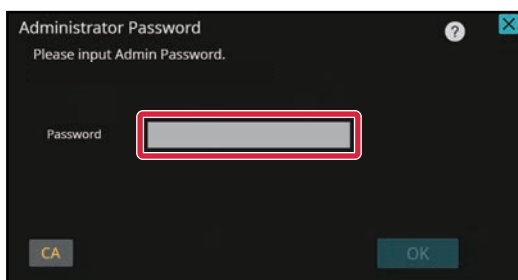

The administrator password screen appears. Enter your password.

Enter the administrator password.



3

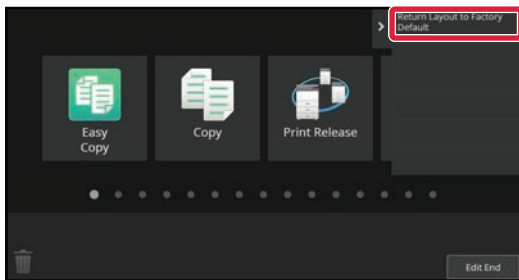

Tap [Return Layout to Factory Default] on the action panel.

4

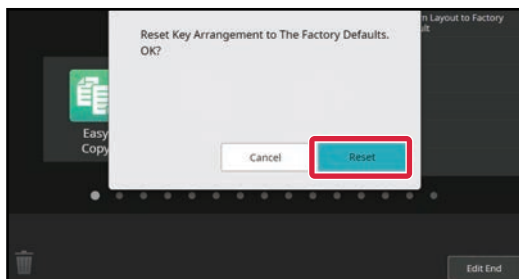

Tap the [Reset] key.

The shortcut keys are returned to the factory default state.

5

After completing the settings, tap the [Logout] key.

From the Web page

1

Enter the IP address set in the machine in the address bar of your web browser.

In the factory default state, you must enter your user password after entering the IP address.

2

On the Web page, click the [System Settings] tab → [Home Screen Settings].

Some settings may require that you enter your user password after clicking [Home Screen Settings]. If you did not perform user authentication, you must enter the administrator password.

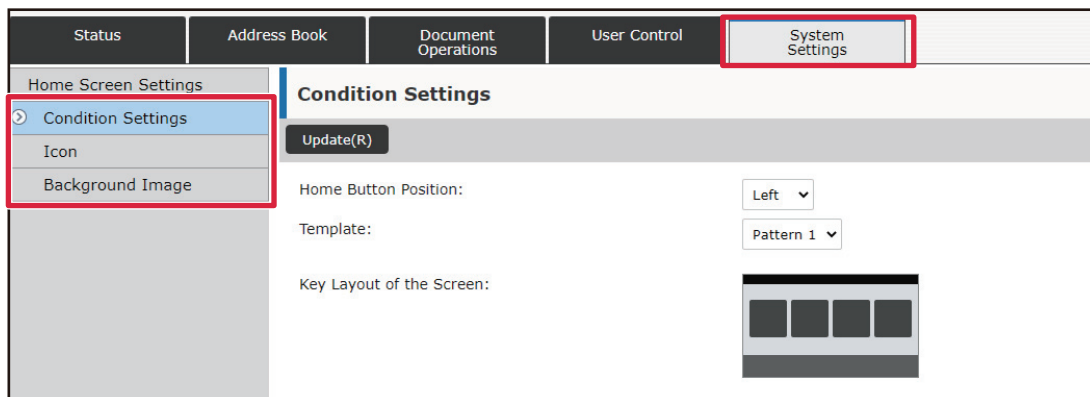



3

Click [Condition Settings], and click the [Return to the Defaults] button.

A confirmation window appears. Click the [OK] button.

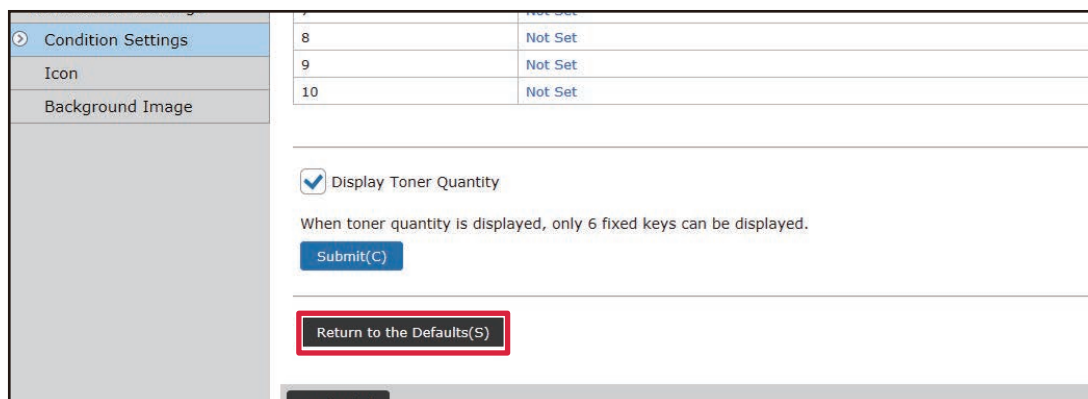

4

When you have finished configuring the settings, click the [Submit] button.

The settings are saved in the machine and applied.

When you have finished settings, click the [Logout] button and close your Web browser.



CHANGING THE TRANSPARENCY OF A SHORTCUT KEY

You can change the transparency of the shortcut keys.

If you want to change the background of your home screen to show what's behind the shortcut keys, increase the transparency to make it easier to see what's behind the shortcut keys.

This procedure can be performed from the touch panel or from the Web page.

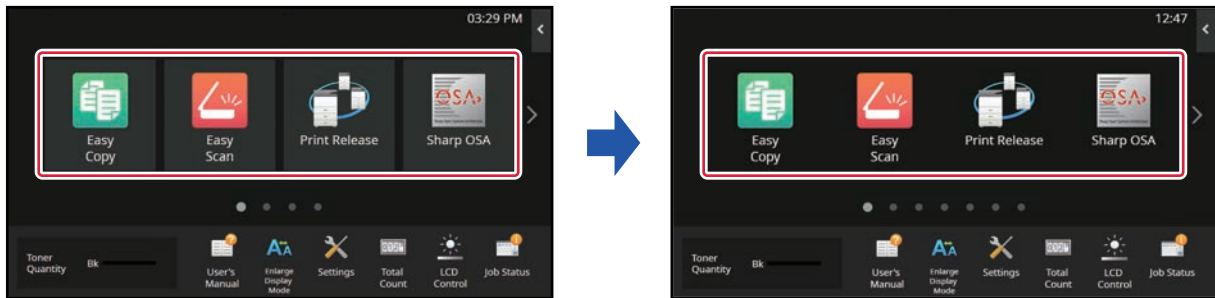

From the touch panel

1

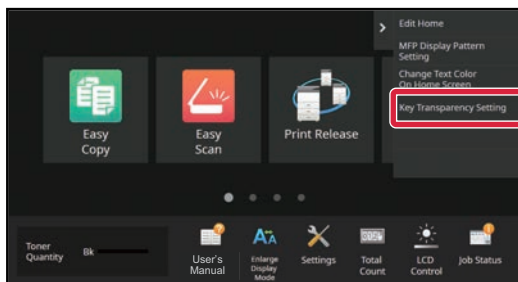

Open the action panel on the home screen, and tap [Key Transparency Setting].

2

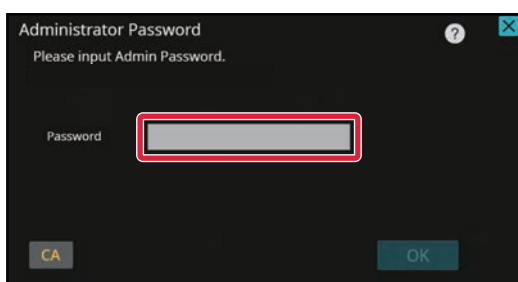

The administrator password screen appears. Enter your password.

Enter the administrator password.

3

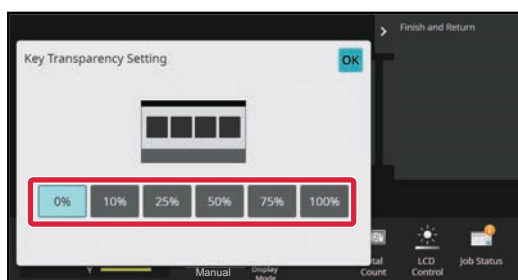

Select the level of transparency you wish to set.



4

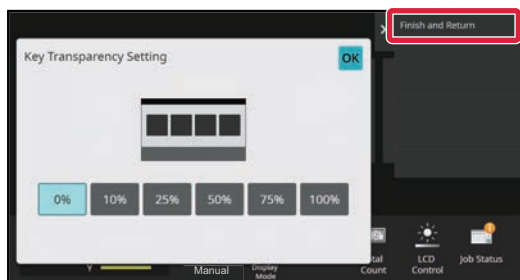

Tap the [Finish and Return] key.

5

After completing the settings, tap the [Logout] key.

From the Web page

1

Enter the IP address set in the machine in the address bar of your web browser.

In the factory default state, you must enter your user password after entering the IP address.

2

On the Web page, click the [System Settings] tab → [Home Screen Settings].

Some settings may require that you enter your user password after clicking [Home Screen Settings]. If you did not perform user authentication, you must enter the administrator password.

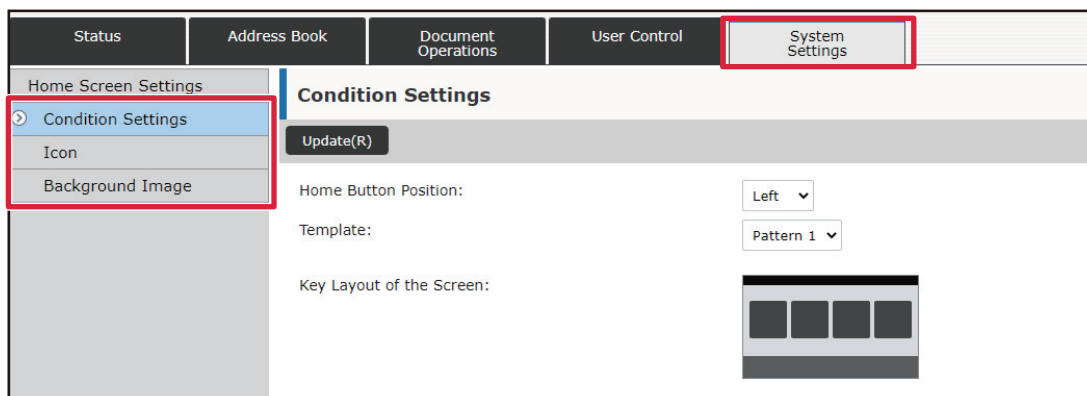

3

Click [Condition Settings], and click the [Key Transparency Setting] button.

4

When you have finished configuring the settings, click the [Submit] button.

The settings are saved in the machine and applied.

When you have finished settings, click the [Logout] button and close your Web browser.



CHANGING THE LAYOUT PATTERN OF THE HOME SCREEN

Multiple home screen layout patterns are preset in the machine. These include a layout pattern that reduces the display size of the shortcut keys to increase the number of keys shown, and a layout pattern that eliminates the fixed key display area to increase the number of shortcut keys shown. The layout pattern can be changed in the Web page.

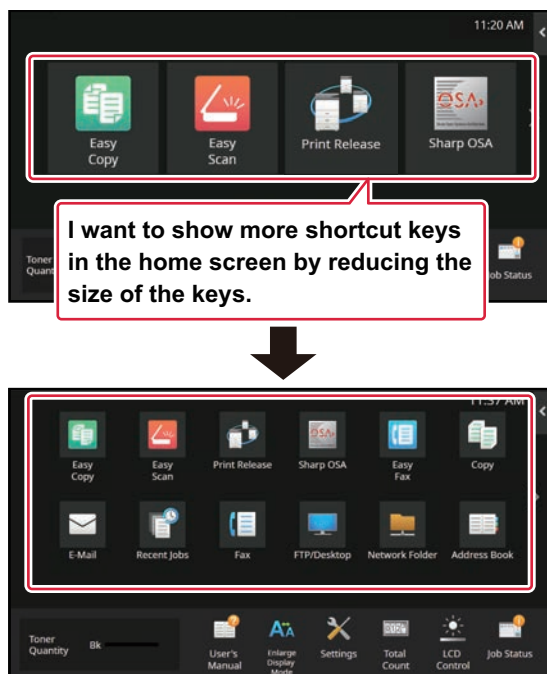

Home screen layout patterns

Six layout patterns are available.

Pattern	Number of shortcut keys displayed per screen	Fixed key area	Maximum number of screens
1	4	Yes	15 screens
2	8	No	8 screens
3	8	Yes	8 screens
4	12	No	5 screens
5	12	Yes	5 screens
6	18	No	4 screens

1

Enter the IP address set in the machine in the address bar of your web browser.

In the factory default state, you must enter your user password after entering the IP address.



2

On the Web page, click the [System Settings] tab → [Home Screen Settings].

Some settings may require that you enter your user password after clicking [Home Screen Settings]. If you did not perform user authentication, you must enter the administrator password.

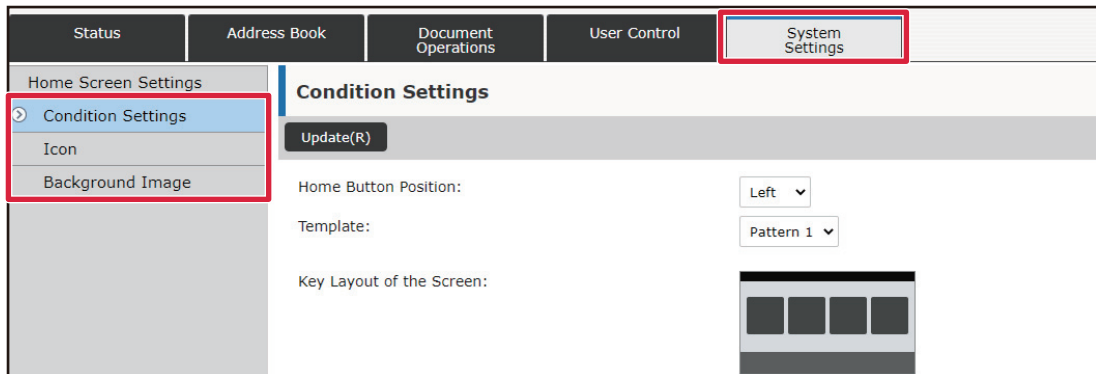

3

Click [Condition Settings] and select the desired layout pattern from the "Template".

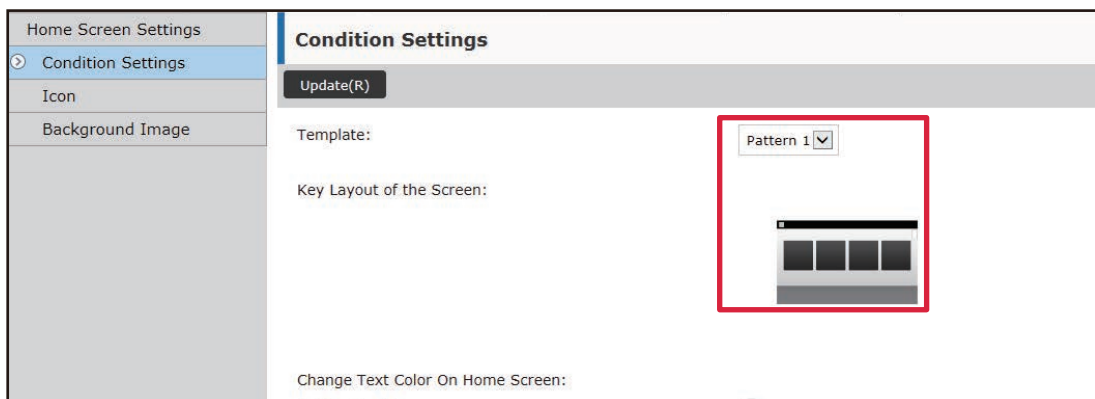

4

When you have finished configuring the settings, click the [Submit] button.

The settings are saved in the machine and applied.

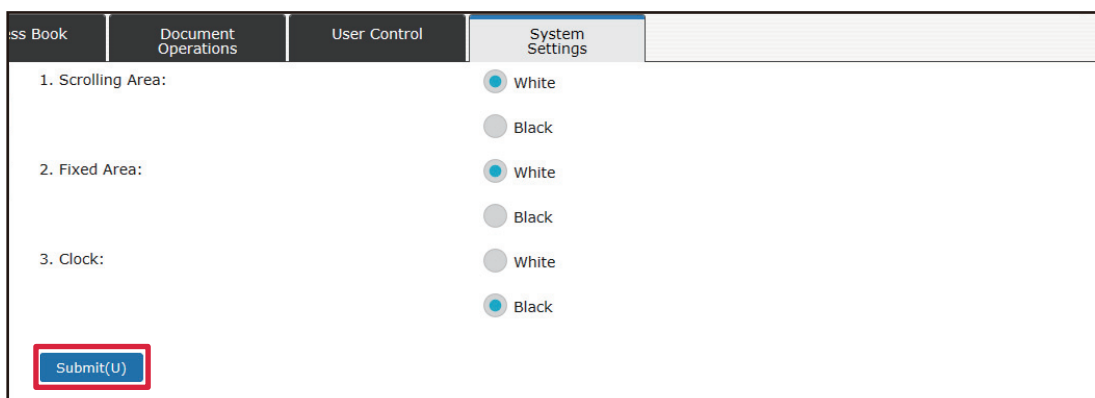



SELECTING A MFP DISPLAY PATTERN FOR THE HOME SCREEN

Multiple color patterns are preset in the machine. You can change the color pattern from the touch panel.

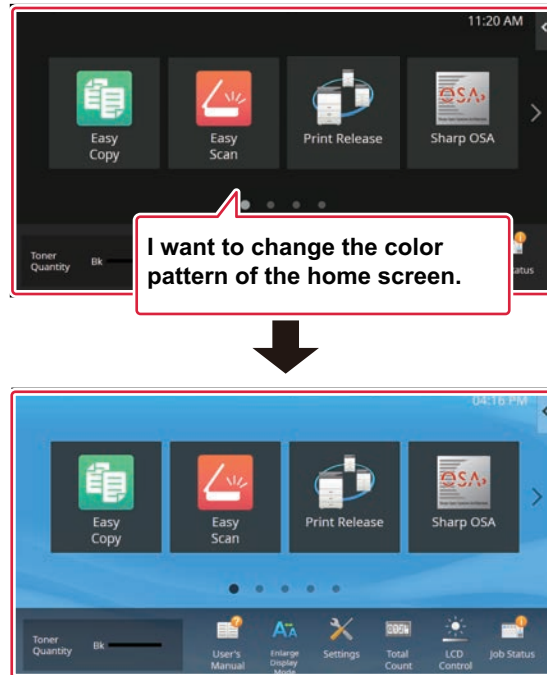

1

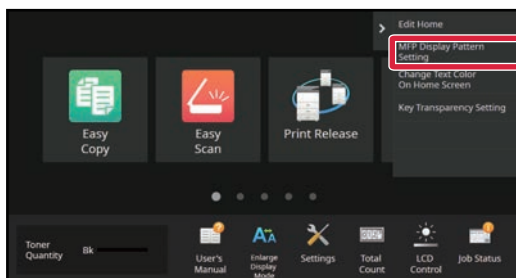

Open the action panel on the home screen, and tap [MFP Display Pattern Setting].

2

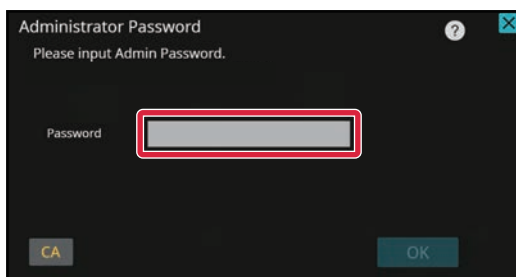

The administrator password screen appears. Enter your password.

Enter the administrator password.



3

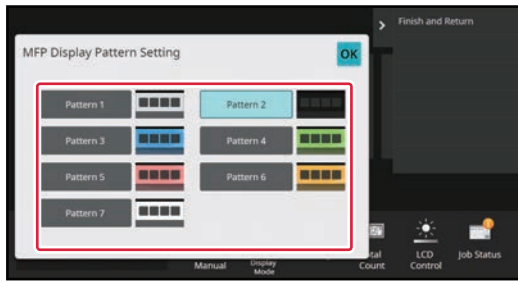

Select the desired pattern.

4

After settings are completed, tap the [Logout] key.



CHANGING THE COLOR OF TEXT ON THE HOME SCREEN

You can change the color of the text in shortcut keys, fixed keys, and the clock on the home screen to white or black. The color is changed using the touch panel.

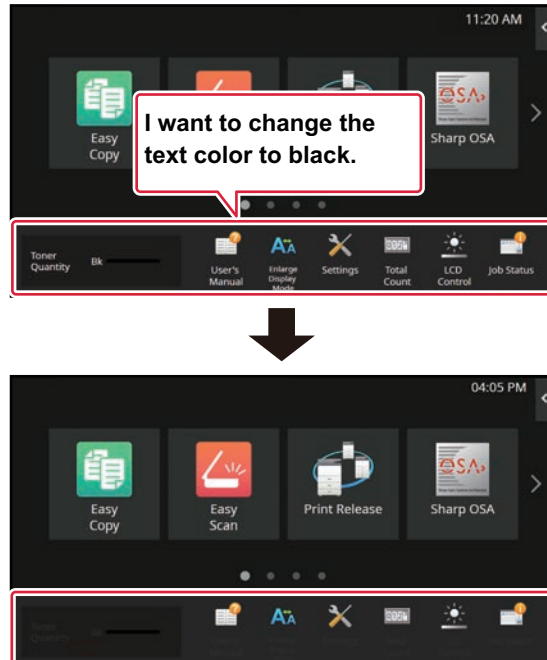

The color of text on the home screen varies depending on the layout pattern.

For information about layout patterns of the home screen, see "[CHANGING THE LAYOUT PATTERN OF THE HOME SCREEN \(page 2-35\)](#)".

Factory default text colors

Home screen layout patterns and text colors

Layout Pattern	Scrolling Area (Text color of shortcut key)	Fixed Area (Text color of fixed keys)	Clock (Text color of clock)
1	White	White	Black
2	White	No	Black
3	Black	White	Black
4	Black	No	Black
5	Black	White	Black
6	Black	No	Black

1

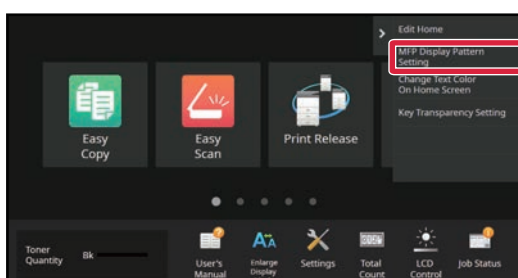

Open the action panel on the home screen, and tap [Change Text Color On Home Screen].



2

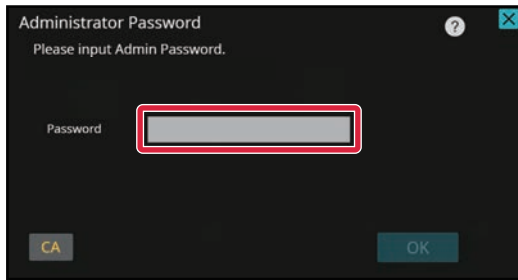

The administrator password screen appears. Enter your password.

Enter the administrator password.

3

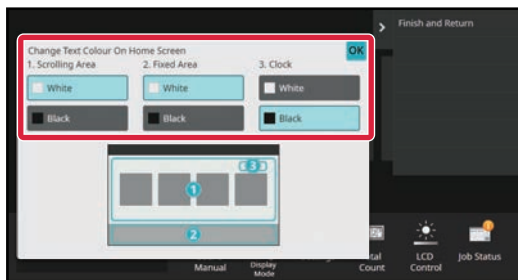

Change the text color.

4

After settings are completed, tap the [Logout] key.



CHANGING THE BACKGROUND IMAGE OF THE HOME SCREEN

You can change the background image of the home screen to a custom image.

This procedure can be performed from the touch panel or from the Web page.

To change the image from the touch panel, first save the desired image in a USB device and connect the device to the machine.



The display size of the background image is 1024 dots x 544 dots.

The height of the image is adjusted to the display height, and the width is adjusted to the display width.

Because the height and width are enlarged/reduced separately, some images may become distorted.

If you want to display the image correctly, adjust the size of the image to the display size of the background image in advance.

From the touch panel

1

Connect the USB device containing the desired image to the machine.

When the USB device is connected to the machine, the popup window will be appeared. Tap the [OK] key.

2

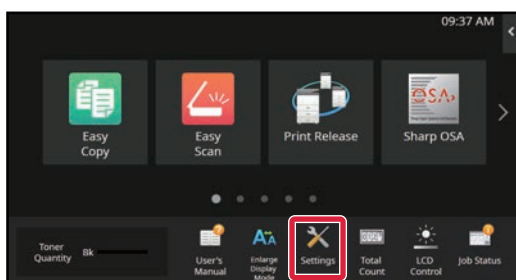

Tap the [Settings] key on the Home screen.

The screen changes to the settings screen.

3

Tap [System Settings] → [Home Screen Settings] → [Background Image], and then tap [Change] key.

The "Register Background Image" screen will be appeared.



The administrator password entry screen will appear while you are selecting settings. Enter the administrator password and log in.

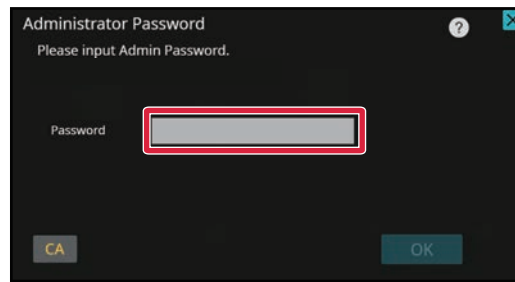

4

Set the [Use Custom Image] checkbox to , and select the desired image with [Folder Name/File Name].



- File formats that can be used are JPEG, GIF and PNG (jpeg, jpg, jpe, jfif, gif and png).
- The maximum file size of an image that can be used for the background image is 640 KB.

5

Click the [Store] button.

After all U/I customize settings are completed, tap the [Logout] key.

From the Web page

1

Enter the IP address set in the machine in the address bar of your web browser.

In the factory default state, you must enter your user password after entering the IP address.

2

On the Web page, click the [System Settings] tab → [Home Screen Settings].

Some settings may require that you enter your user password after clicking [Home Screen Settings]. If you did not perform user authentication, you must enter the administrator password.

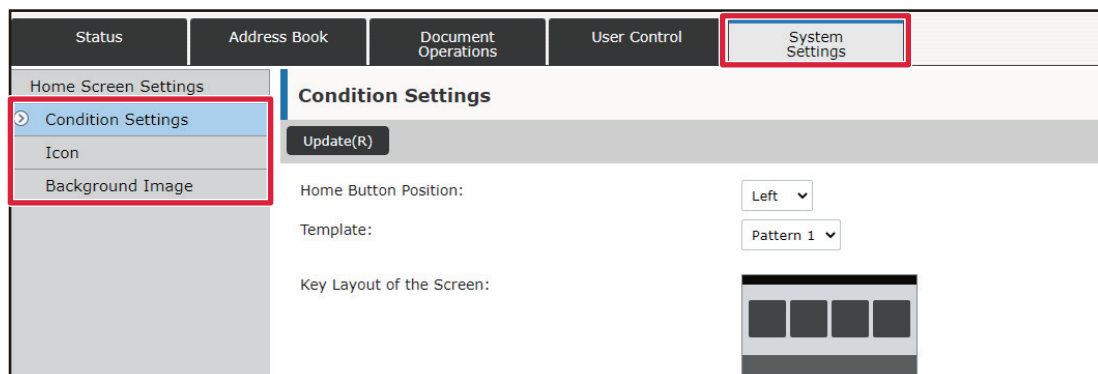



3

Click the [Change] button in [Background Image].

The screenshot shows a web interface with a navigation menu on the left containing 'Home Screen Settings', 'Condition Settings', 'Icon', and 'Background Image'. The 'Background Image' option is selected. The main content area is titled 'Background Image' and contains an 'Update(R)' button at the top. Below it, the text 'Background Image' is followed by 'Default' and a 'Change(C)' button, which is highlighted with a red box. At the bottom of the main area, there is another 'Update(R)' button.

4

Set the [Use Custom Image] checkbox to , and select the image with [Select File].

Click [Browse] to select the image.

The screenshot shows a web interface titled 'Register Background Image'. It has a navigation menu on the left with 'Home Screen Settings', 'Condition Settings', 'Icon', and 'Background Image'. The 'Background Image' option is selected. The main content area is titled 'Background Image' and contains a 'Submit(U)' button and a 'Cancel(C)' button at the top. Below this, there is a section for 'Image:' with a checked 'Use Custom Image' checkbox, highlighted with a red box. Underneath, there is a 'File Name:' label, a 'Select File:' label, and a text input field containing 'Not Set', followed by a 'Browse' button, both highlighted with red boxes. Below the input field, there is a note: '(up to 200 characters)'. At the bottom of the main area, there are 'Submit(U)' and 'Cancel(C)' buttons.



- File formats that can be used are JPEG, GIF and PNG (jpeg, jpg, jpe, jfif, gif and png).
- The maximum file size of an image that can be used for the background image is 640 KB.

5

When you have finished configuring the settings, click the [Submit] button.

The settings are saved in the machine and applied.

When you have finished settings, click the [Logout] button and close your Web browser.



CHANGING THE FIXED KEYS

You can change the fixed keys. The fixed keys are changed using the Web page.

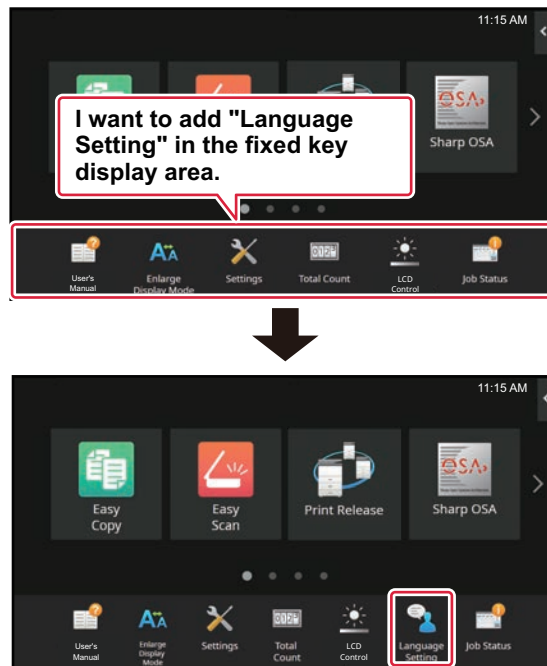

1

Enter the IP address set in the machine in the address bar of your web browser.

In the factory default state, you must enter your user password after entering the IP address.

2

On the Web page, click the [System Settings] tab → [Home Screen Settings].

Some settings may require that you enter your user password after clicking [Home Screen Settings]. If you did not perform user authentication, you must enter the administrator password.

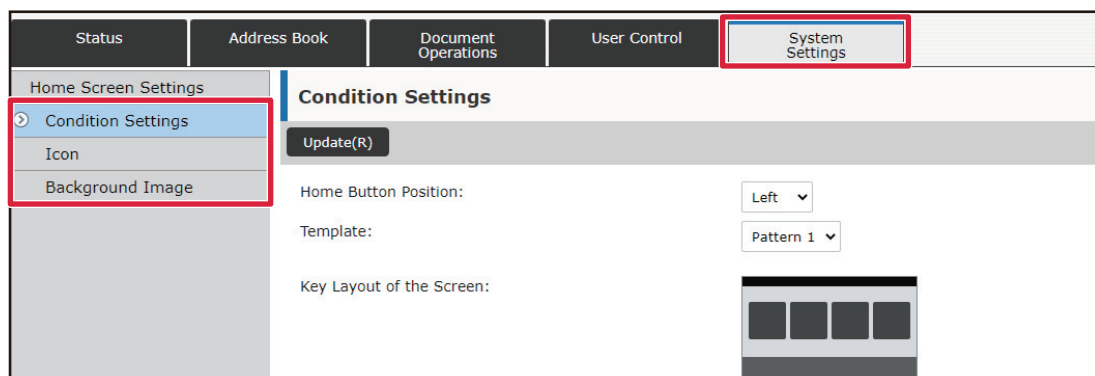

**3****Click [Condition Settings], and click the desired item under "Fix Key".**

You can click [Not Set] to add a new fixed key.

No.	Fix Key
1	User's Manual
2	Enlarge Display Mode
3	System Settings
4	Total Count
5	LCD Control
6	Job Status
7	Not Set
8	Not Set
9	Not Set
10	Not Set

4**Select the function you want to add, and click the [Submit] button.**

When you click the [Submit] button, the [Home Screen Registration] screen closes.

5**When you have finished configuring the settings, click the [Submit] button.**

The settings are saved in the machine and applied.

When you have finished settings, click the [Logout] button and close your Web browser.



INCREASING THE TEXT SIZE

In a Normal mode screen such as copy or image send, you can enlarge the character size and interval. This function is selected on the touch panel.

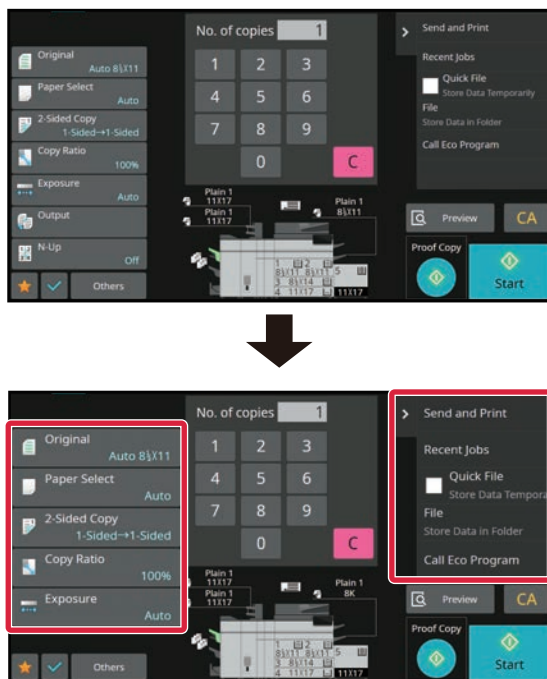

- The setting keys and the action panel will increase the text size. Setting items that no longer appear on the action panel can be displayed by tapping the scroll keys. Setting keys that no longer appear (the [Exposure] key in this example) can be displayed by tapping the [Others] key.
- In screens other than Normal mode of each function such as Easy mode and settings, the size of characters and keys does not change.
- Increasing the text size may decrease the number of keys displayed in the base screen and other screens of each function.

1

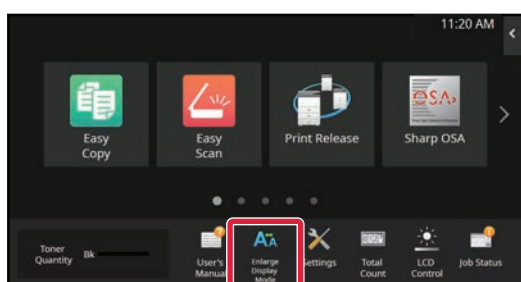

Tap the [Enlarge Display Mode] key in the home screen.

The key image changes to  and enlarge display mode is enabled.

To cancel enlarge display mode, tap the [Enlarge Display Mode] key again. The key image changes to  and enlarge display mode is canceled.



CHANGING THE LANGUAGE USED ON THE MACHINE

You can change the language used in the home screen.

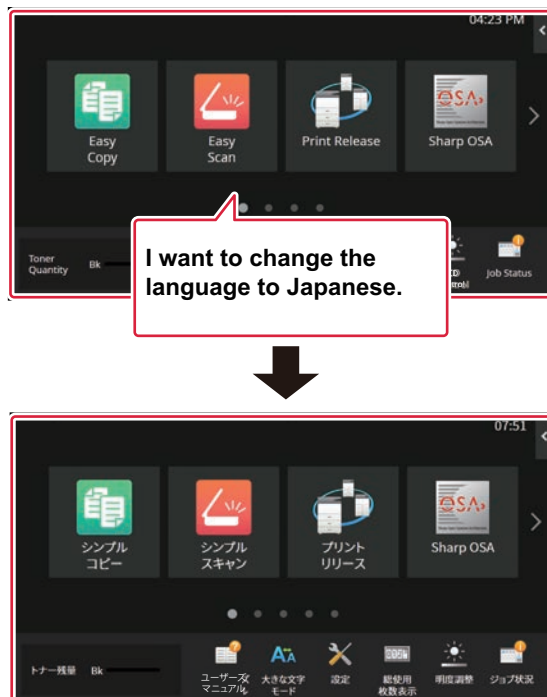

1

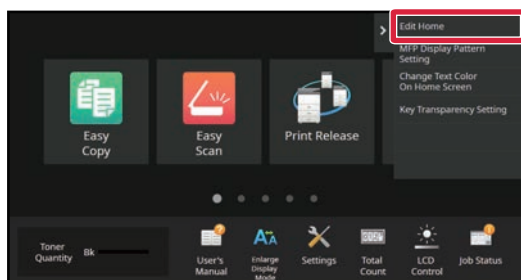

Open the action panel on the home screen, and tap [Edit Home].

2

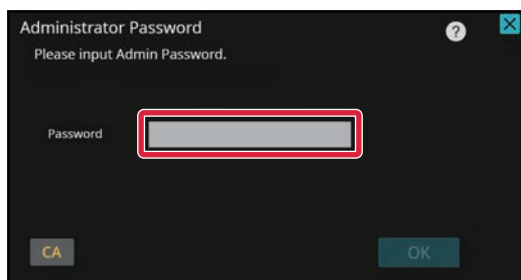

The administrator password screen appears. Enter your password.

Enter the administrator password.



3



Tap an empty shortcut key location.

4

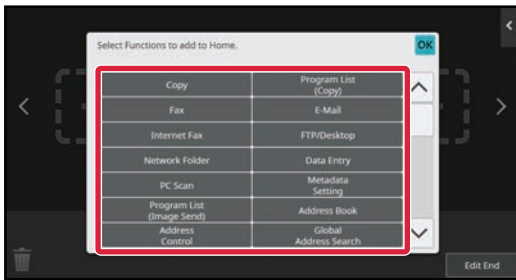

Tap the function you want to add.

The shortcut key will be added to the selected location.

5

After settings are completed, tap the [Logout] key.

6

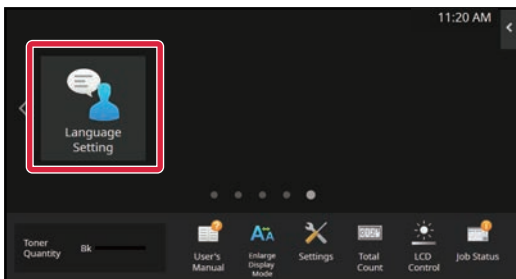

Tap the [Language Setting] key on the home screen.

7

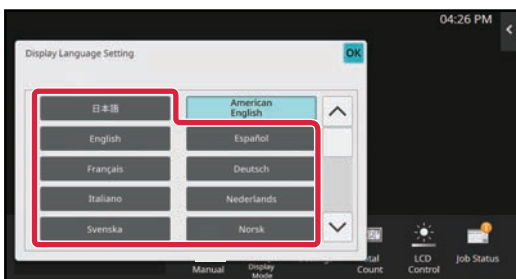

Select the desired language and tap

OK.

The display changes to the selected language.



From the Web page

1

Enter the IP address set in the machine in the address bar of your web browser.

In the factory default state, you must enter your user password after entering the IP address.

2

On the Web page, click the [System Settings] tab → [Common Settings] → [Operation Settings] → [Condition Settings] → [Language Setting].

This settings may require that you enter your user password. If you did not perform user authentication, you must enter the administrator password.

3

Select the language you want to change from the list.

4

When you have finished configuring the settings, click the [Submit] button.

The settings are saved in the machine and applied.

When you have finished settings, click the [Logout] button and close your Web browser.



CHANGING THE POSITION OF THE [Home Screen] KEY

You can change the position of the [Home Screen] key.

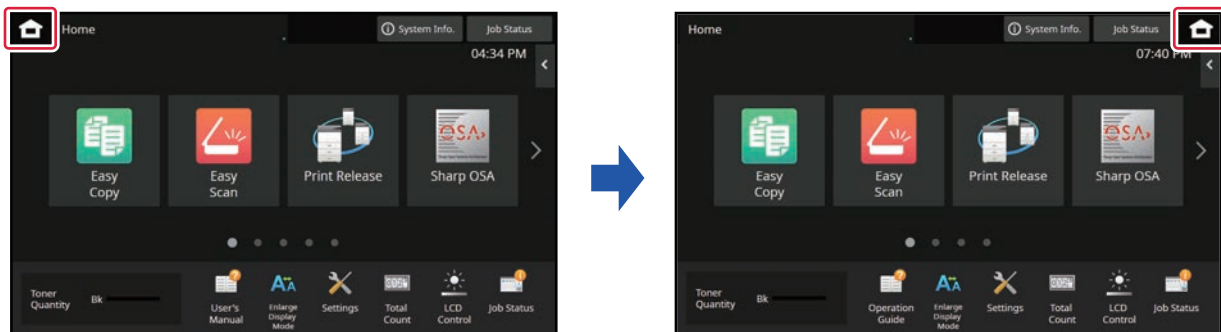

From the touch panel

1

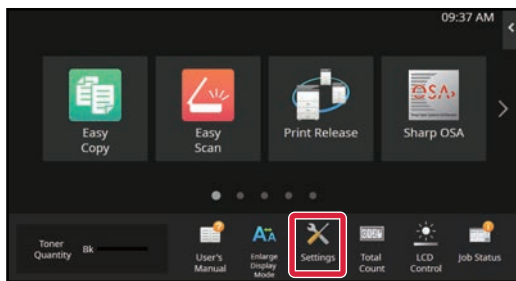

Tap the [Settings] key on the Home screen.

The screen changes to the settings screen.

2

Tap [System Settings] → [Home Screen Settings] and then tap [Home Button Position] key.



The administrator password entry screen will appear while you are selecting settings. Enter the administrator password and log in.

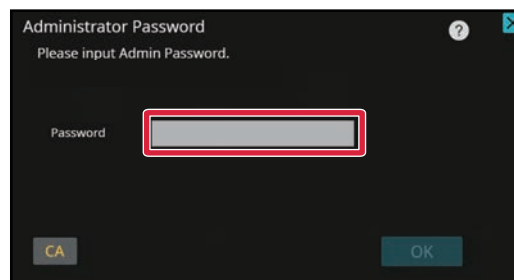

3

Select [Left] or [Right]

4

Click the [Store] button.

After settings are completed, tap the [Logout] key.



From the Web page

1

Enter the IP address set in the machine in the address bar of your web browser.

In the factory default state, you must enter your user password after entering the IP address.

2

On the Web page, click the [System Settings] tab → [Home Screen Settings] → [Home Button Position].

Some settings may require that you enter your user password after clicking [Home Screen Settings]. If you did not perform user authentication, you must enter the administrator password.

3

Select [Left] or [Right]

4

When you have finished configuring the settings, click the [Submit] button.

The settings are saved in the machine and applied.

When you have finished settings, click the [Logout] button and close your Web browser.



JOB STATUS

STOPPING/DELETING A JOB, PRIORITY PROCESSING AND CHECKING THE STATUS

TYPES OF JOB STATUS SCREENS

When you tap the job status display, the job status screen appears. Tap it again to return to the previous mode. The job status screen is divided into the following four tabs, enabling you to select a job list by tapping a desired tab.

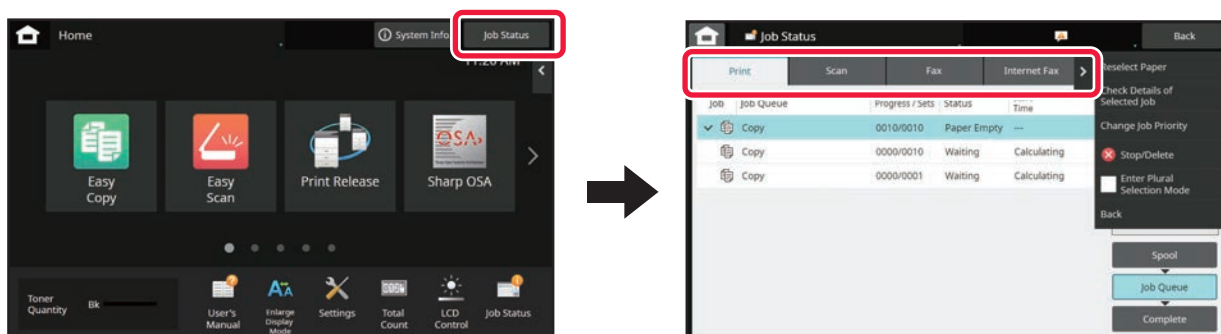

- **Print**
Lists print jobs such as copying, printing from a PC, Scan to FTP job, Scan to Network Folder job, USB direct print, printing of Data List from system settings, reprint jobs and printing for faxed or other received data.
- **Scan**
Lists send jobs of e-mail messages and FTP/Desktop send jobs.
- **Fax**
Lists fax send jobs using a telephone line.
- **Internet Fax**
Lists fax send jobs using Internet Fax.



- The background of the job status display changes as follows:
 - Green: Job in progress
 - Yellow: Warming up/waiting
 - Red: Waiting for error clearing



Jobs move among the lists according to the processing status, from [Spool], [Job Queue] and [Complete], in that order. To switch the job list display to the display by processing status, tap the [Spool], [Job Queue] or [Complete] key as desired.

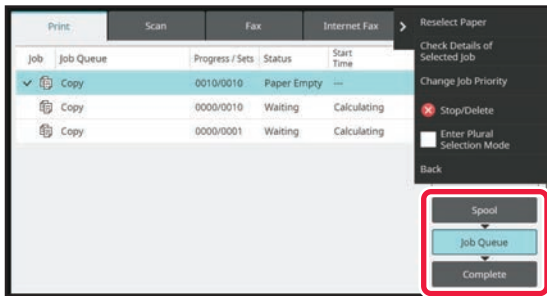

- **Spool list**

Lists print jobs up to the transfer to the machine. The jobs move to the Job Queue list after the transfer is completed. If you printed an encrypted PDF file by direct print, enter the password from here to print the file.

- **Job Queue list**

Lists jobs in progress and in the queue for copying, printing from a computer and printing of received fax. This list also displays jobs in progress and in the queue for sending fax data or sending image data. The jobs move to the Complete list after printing or sending is completed.

- **Complete list**

Lists jobs through with copying, printing or sending.



STOPPING/DELETING A JOB IN PROGRESS OR RESERVED

1

Tap the job status display and tap the tab for the job that you wish to stop or delete.

2

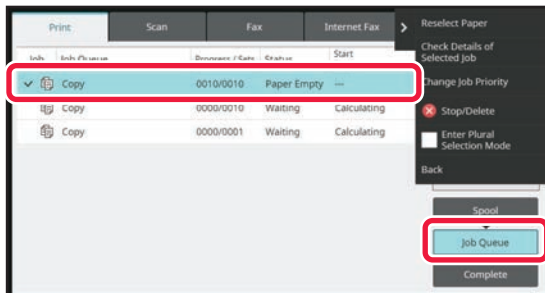

Tap the [Job Queue] key.



When you wish to stop a print job being sent from the computer, tap the [Spool] key.

3

Tap the job that you wish to stop or delete, and then tap [Stop/Delete] on the action panel.

When a screen appears that allows you to confirm that you do want to stop the job, tap the [Cancel] key.



- If the machine runs out of paper during a copy or print job, you can cancel the job from the job status screen.
- To delete more than one job, operate the check box for [Enter Plural Selection Mode] on the action panel so that it looks like .
- Printing of a received fax or Internet fax cannot be stopped.
- A job set for transfer cannot be canceled.



PRIORITY PROCESSING OF A RESERVED JOB

This function gives priority to processing of copied, faxed or image send jobs arising later to jobs already in a queue for printing or sending.



- Priority processing operation varies, as follows, depending on the job type.
- Job on the print tab
The job currently in progress is suspended to let the priority job make interruption.
- Job on the scanner/fax/Internet fax tab
The priority job is moved directly under the job currently in progress.

1

Tap the job status display and tap the job for priority processing.

2

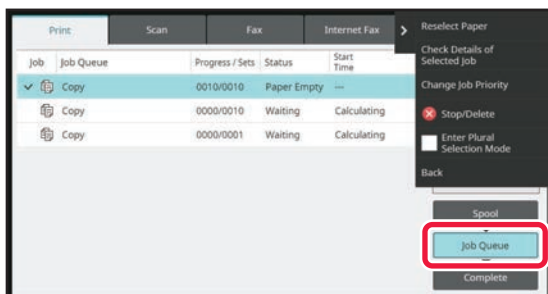

Tap the [Job Queue] key.

3

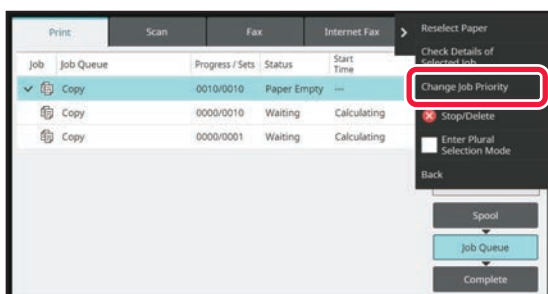

Tap the job for priority processing and then tap [Change Job Priority] on the action panel.



Changing the job order

If there is a job in progress, an interrupt job can be performed, or a job can be moved down in the queue to change the job order. Tap the key of the job you want to move, and tap the "Priority Change" key.

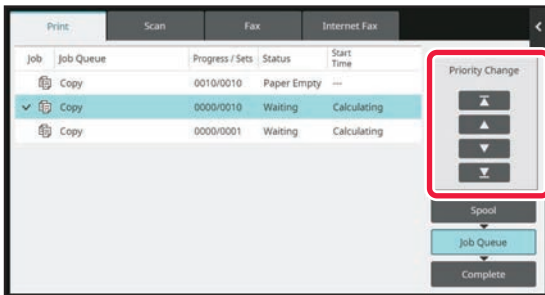

- key
Moves the selected job to the top of the queue. The current job will be interrupted and the selected job starts.
- key
Moves the selected job up one position. When the second job from the top is selected, tapping this key interrupts the current job and starts the selected job.
- key
Moves the selected job down one position.
- key
Moves the selected job to the bottom of the queue.

Scanner job with a timer setting

When a scanner job with a timer setting is selected, tapping the order change keys moves the job as follows.

- key
The timer setting is canceled and the job moves to the position after the job in progress (second from top).
- key
The timer setting is canceled and the job moves to the lowest position in the queue (if there are 3 jobs, the 4th position)
- , key
These keys cannot be used.



- The jobs below cannot be moved.
- Job currently in progress, interrupt copy jobs, list print jobs, and jobs when Passing Prohibited is set in the system settings.

In print tab, you can switch the display in the "Job Queue" screen between the number of printed copies and remaining copies to be printed for each job.

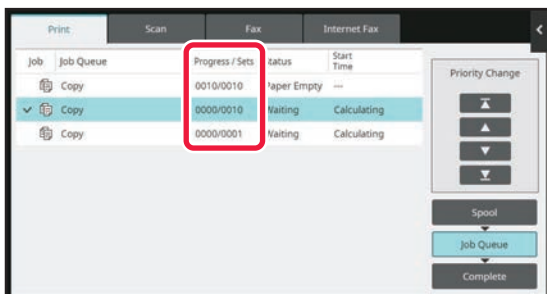



CHECKING A RESERVED JOB OR THE JOB IN PROGRESS

1

Tap the job status display and tap the tab for the job whose contents you wish to check.

2

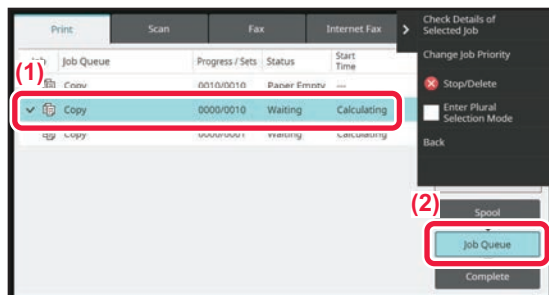

Tap the [Job Queue] key.

3

Tap the job whose contents you wish to check and then tap [Check Details of Selected Job] on the action panel.



- Different job contents appear in different modes.
- For information on the icons displayed on the job keys or the messages displayed in "Status", see "[READING THE JOB LIST \(page 2-59\)](#)".



CHECKING COMPLETED JOBS

1

Tap the job status display and tap the tab for the job whose contents you wish to check.

2

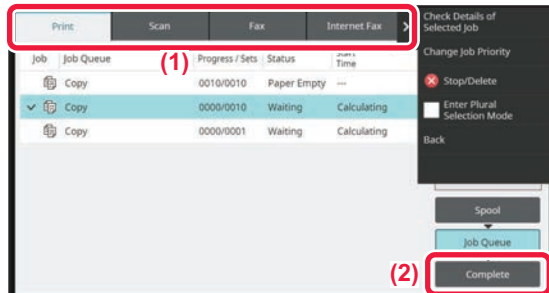

Tap the [Complete] key.

3

Tap the job whose contents you wish to check and then tap [Check Details of Selected Job] on the action panel.

Jobs you can check are displayed as keys so that you can tap them.

















- Different job contents appear in different modes.
- For information on the icons displayed on the job keys or the messages displayed in "Status", see "[READING THE JOB LIST \(page 2-59\)](#)".



READING THE JOB LIST

The meaning of each job icon and message displayed in "Status" is as follows:

Icons indicating the job type

 	Print job (RGB/CMYK)		Copy job
	Scan to E-mail job		Scan to FTP job
	Scan to Network Folder job		Scan to Desktop job
	Fax transmission job		Fax reception job
	PC-Fax transmission job		Internet fax transmission job (Including Direct SMTP)
	PC-I-Fax transmission job		Scan to Local Drive file print job
	Internet fax reception job (Including Direct SMTP)		Broadcast job* Inbound routing job
	Tandem copy/print job		Broadcast job * Inbound routing job(When a destination is group destination address)*
	OSA Scan Job		

* This appears in a broadcast job.



Messages displayed in "Status"

Job in progress

Display	Status
"Printing"	Print job in progress
"Copying"	Copy job in progress
"Connecting"	Connecting
"Sending"	Sending
"Receiving"	Receiving
"Processing"	Processing
"Tel"	Speaking with the other party using an external telephone
"Stopped"	The job has been stopped
"Toner Empty"	Toner Empty
"Paper Empty"	Paper Empty
"Paper Jam"	Paper jam
"Waiting"	Waiting
"Warming up"	Warming up
"Limit"	Having reached the account limit
"Report Wait"	Transmission confirmation reception timeout
"Error"	An error occurred while the job was being executed

Reserved job

Display	Status
"Waiting"	The job is waiting to be executed
"Retry Mode"	The job is being retried due to a communication error or other problem
"Report Wait"	Waiting for confirmation of Internet fax transmission
A day and time is displayed	Timer transmission job (the specified time is displayed)

**Completed job**

Display	Status
"OK"	Normal termination
"Send OK"	Transmission was completed.
"NG Ck Line"	Fax line cable is not connected
"In Memory"	Reception completed but the fax has not been printed.
	The received data (each page) has not been printed or forwarded. (The received data has not been deleted.)
"Received"	Printed received fax data.
	The fax has been received.
	The received data (each file) was stored.
"Forward OK"	The received data/received data (each file) has been forwarded.
"FAST"	FAST transmission completed.
"Stopped"	The job was stopped.
"Delete"	Deleted received data in the image check screen.
"Number of successful transmission destinations/Total destinations OK"	Completion of a broadcast transmission, serial polling, or inbound routing operation.
	If transmission to 3 destinations was successful out of a total of 5, "003/005 OK" will appear.
"No Response"	An error occurred because there was no response from the destination.
"Busy"	An error occurred because the other party was busy.
"Received"	E-mail other than Internet fax received
"Rejected"	A fax was sent from a party that has been blocked by the anti junk fax function.
"NGxxxxx"	Transmission/reception was not successful because a communication error occurred (a 6-digit error code appears in xxxxxx.)
"Error"	An error occurred while the job was being executed.
"Limit"	Jobs exceeding the maximum size of e-mail attachments
"displayed"*	Displayed at the receiving machine when delivery confirmation is set
"dispatched"*	Forwarded elsewhere before being displayed at the receiving machine when delivery confirmation is set
"processed"*	Processed without being displayed at receiving machine when delivery confirmation is set
"deleted"*	Message deleted at receiving machine when delivery confirmation is set
"denied"*	Receiving machine refused to notify sending machine of message processing content when delivery confirmation is set
"failed"*	An abnormal condition occurred when delivery confirmation is set

* If the receiving machine is a SHARP machine, the receiving machine will return "dispatched" if the fax was received normally, or "processed" if reception failed.
When delivery confirmation is set for Internet Fax, the disposition field value indicated on the delivery confirmation return e-mail appears.



CHARACTER ENTRY

CHARACTER ENTRY

NAMES AND FUNCTIONS OF SOFT KEYBOARD KEYS

Display the soft keyboard to register the name of a file, program, folder or user.

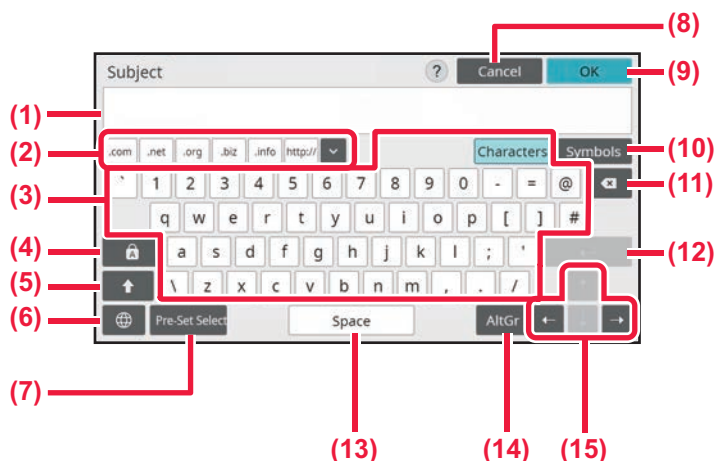

(1) Text input area

Displays the entered text.

(2) Registered word key

Retrieves the stored words. Use "Settings" to store words.

(3) Keyboard

Tap a key to enter text.
The key types vary depending on the selected entry mode.

(4) [Caps] key

Switches the alphabet to upper case. Use this key to enter a series of capital letters.

(5) [Shift] key

Switch the alphabet to uppercase.

(6) Keyboard Select

Switches the key layout.

(7) Pre-Set Select

Use this to retrieve a previously stored subject for e-mail or pre-set text.

(8) [Cancel] key

Exits the soft keyboard.

(9) [OK] key

Finalizes the entered characters and exits the soft keyboard.

(10) [Symbols] key

Switch to other input modes.

(11) Backspace key

Deletes one character to the left.

(12) [Enter] key

Temporarily fixes the converted characters or inserts a line break.

(13) [Space] key

Converts the entered characters. The [Space] key inserts a space between words if there are no characters specified to be converted.

(14) [AltGr] key

Used to enter accented characters and special symbols.

(15) Cursor keys

Used to move the cursor or to change the range of the specified conversion target.



The soft keyboard shown here is an image for your reference. Different keys may be enabled depending on the actual situation and condition under which you enter characters.



SET THE KEYBOARD SETTING

In "Settings (administrator)", select [System Settings] → [Common Settings] → [Operation Settings] → [Keyboard Settings].

Keyboard Settings

Default Keyboard Setting

Configure settings for the keyboard used for entry on the text.

Keyboard Select

Change the key layout and display according to the set language.

Set Keyboard Priority

When an external keyboard is connected, set whether the external keyboard or the keyboard shown on the touch panel (soft keyboard) is given priority.

Soft Keyboard Template Setting

Register a text that you frequently use when entering an address or domain name in advance. Enter a maximum of 16 characters.



COPIER

BEFORE USING THE MACHINE AS A COPIER

COPY MODE	3-3
EASY MODE	3-3
NORMAL MODE	3-5
SELECTING COPY MODE	3-5

BASIC PROCEDURE FOR MAKING COPIES

COPYING	3-6
DEFAULT SETTINGS FOR COPYING	3-10
CHECKING THE ORIGINAL SIZE	3-11
EASY MODE	3-11
NORMAL MODE	3-11
SELECTING THE PAPER TRAY FOR COPYING	3-13
AUTOMATIC 2-SIDED COPYING	3-14
USING THE AUTOMATIC DOCUMENT FEEDER FOR 2-SIDED COPYING	3-14
USING THE DOCUMENT GLASS FOR 2-SIDED COPYING.....	3-15
CHANGING THE EXPOSURE AND ORIGINAL IMAGE TYPE	3-17
AUTOMATIC ADJUSTMENT OF EXPOSURE AND ORIGINAL TYPE	3-17
MANUAL ADJUSTMENT OF EXPOSURE AND ORIGINAL TYPE	3-17
ENLARGE/REDUCE	3-19
AUTO RATIO SELECT.....	3-19
MANUAL RATIO SELECTION	3-20
ENLARGING/REDUCING THE LENGTH AND WIDTH SEPARATELY	3-23
SELECTING THE ORIENTATION AND SIZE OF THE ORIGINAL	3-26
SPECIFYING THE ORIENTATION OF THE ORIGINAL	3-26
SPECIFY THE ORIENTATION AND SIZE OF THE ORIGINAL	3-26
SPECIFYING THE ORIENTATION AND SIZE OF A NON-STANDARD SIZE ORIGINALS	3-27
STORING FREQUENTLY USED ORIGINAL SIZES	3-28
STORING ORIGINAL SIZES (MODIFY/DELETE).....	3-28
MAKING COPIES USING THE BYPASS TRAY	3-31
MAKING COPIES USING THE BYPASS TRAY	3-31
SPECIFYING A TYPE AND SIZE OF PAPER LOADED ON BYPASS TRAY	3-32
OUTPUT	3-33
CHANGING OUTPUT DESTINATION	3-35
SORT/GROUP SETTING.....	3-36
STAPLE SETTINGS.....	3-37
PUNCH SETTINGS	3-43
FOLD SETTING	3-45

INSERTING SEPARATOR PAGES BETWEEN COPIES OR JOBS	3-51
BATCH COPY FUNCTIONS	3-53
COPYING MULTIPLE ORIGINALS AS A SINGLE PAGE (N-Up).....	3-53
COPYING EACH FACING PAGE OF A BOUND DOCUMENT (DUAL PAGE COPY)	3-55
COPYING BOTH SIDES OF A CARD AS A SINGLE PAGE (CARD SHOT)	3-57
REPEATING THE SAME IMAGE ON ONE SHEET (REPEAT LAYOUT)	3-59
COPYING MULTIPLE BUSINESS CARDS (BUSINESS CARD COPY)	3-64

OTHER FUNCTIONS

OUTPUT AND LAYOUT EDITING FUNCTIONS	3-67
MAKING COPIES IN PAMPHLET FORMAT (BOOKLET).....	3-67
COPYING MULTIPLE ORIGINALS ON EACH BOOKLET PAGE (BOOKLET 2-Up/4-Up)	3-70
COPYING A PAMPHLET (BOOK COPY).....	3-73
SPLITTING A PAMPHLET ORIGINAL BY PAGE (BOOK DIVIDE).....	3-76
PAPER, AND TIME SAVING FUNCTIONS	3-77
SKIPPING BLANK PAGES IN AN ORIGINAL (BLANK PAGE SKIP)	3-77
ADJUSTING THE BACKGROUND BY MAKING LIGHT AREAS OF THE ORIGINAL DARKER OR LIGHTER (BACKGROUND ADJUSTMENT).....	3-79
MAKING A PROOF COPY (PROOF COPY)	3-81
CHECKING THE NUMBER OF SCANNED ORIGINAL SHEETS (ORIGINAL COUNT)	3-83
USING TWO MACHINES TO REDUCE THE COPY TIME (TANDEM COPY)	3-84
SECURITY REINFORCEMENT FUNCTIONS	3-86
PADDING UNAUTHORIZED COPY PREVENTION DATA (HIDDEN PATTERN PRINT).....	3-86
OUTPUT POSITION AND MARGIN ADJUSTMENT FUNCTIONS	3-88
ADDING MARGINS (MARGIN SHIFT).....	3-88
ERASING PERIPHERAL SHADOWS FOR COPYING (ERASE)	3-90
COPYING ORIGINALS WITH NO EDGE CUT-OFF (FULL BLEED COPY)	3-92
COPYING IN THE CENTER OF THE PAPER (CENTERING).....	3-93
SPECIFYING A PAPER POSITION (POSITION IMAGE)	3-94
SCANNING FUNCTIONS	3-96
COLLECTIVELY SCANNING A LARGE NUMBER OF ORIGINALS (JOB BUILD).....	3-96
SCANNING ORIGINALS OF DIFFERENT SIZES (MIXED SIZE ORIGINAL).....	3-99





SCANNING THIN ORIGINALS (SLOW SCAN MODE) 3-102

SCANNING HEAVY ORIGINALS (HEAVY PAPER SCAN) 3-103

ADJUSTING RESOLUTION WHEN SCANNING (RESOLUTION) 3-104

TEXT AND IMAGE ADDITION FUNCTIONS 3-105

PRINTING DATES, PAGE NUMBERS, AND WATERMARKS (STAMP) 3-105

ADDING A REGISTERED IMAGE TO AN ORIGINAL (CUSTOM IMAGE) 3-108

INSERTING COVERS IN COPIES (COVERS/INSERTS) 3-111

INSERTING INSERTION SHEETS IN COPIES (COVERS/INSERTS) 3-119

CHECKING, EDITING, AND DELETING THE PAGE LAYOUT OF COVERS AND INSERTION SHEETS (PAGE LAYOUT) 3-123

INSERTING INSERTION SHEETS IN BETWEEN TRANSPARENCY FILMS (TRANSPARENCY INSERTS) 3-124

FUNCTIONS FOR SPECIFIC USES 3-126

COPYING CAPTIONS ONTO TAB PAPER (TAB COPY) 3-126

MAKING A POSTER-SIZED COPY (MULTI-PAGE ENLARGEMENT) 3-130

COPYING WITH MIRROR IMAGE (MIRROR IMAGE) 3-132

OUTPUT AND DENSITY ADJUSTMENT FUNCTIONS . 3-133

REVERSING WHITE AND BLACK IN A COPY (B/W REVERSE) 3-133

EASY ADJUSTMENT OF THE IMAGE QUALITY (QUICK IMAGE QUALITY ADJUSTMENT) 3-134

ADJUSTING THE SHARPNESS OF AN IMAGE (SHARPNESS) 3-135

THE ADJUST DENSITY AREA FOR COPY (GRAY BALANCE) 3-136

CONVENIENT COPY FUNCTIONS

INTERRUPT COPY 3-137

SEND DATA WHILE COPYING 3-138

COPY JOBS 3-139

PROGRAMS 3-140

STORING A PROGRAM 3-140

RETRIEVING A PROGRAM 3-142

DELETING AND RENAMING A PROGRAM 3-143



BEFORE USING THE MACHINE AS A COPIER

COPY MODE

There are two modes for copying: easy mode and normal mode.

Easy mode is limited to frequently used functions that allow you to smoothly perform most copy jobs.

If you need to select detailed settings or special functions, use normal mode. All functions can be used in normal mode.

EASY MODE

Easy mode makes it easy to select basic settings for copying.

1st screen

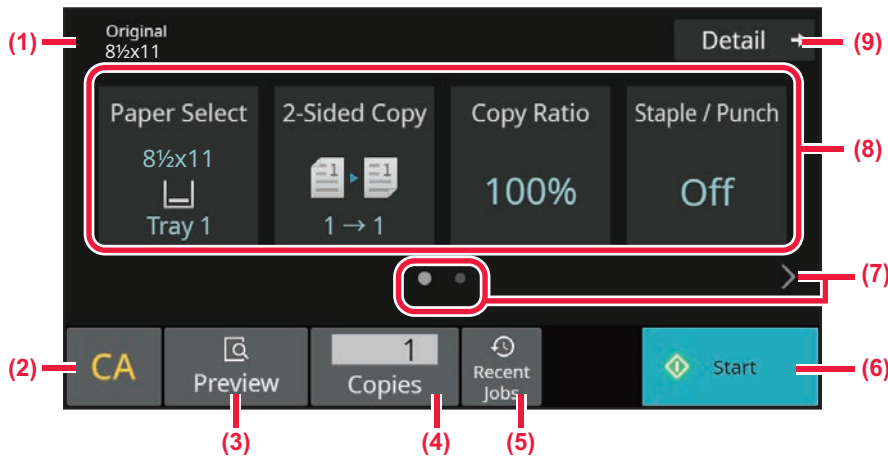

2nd screen

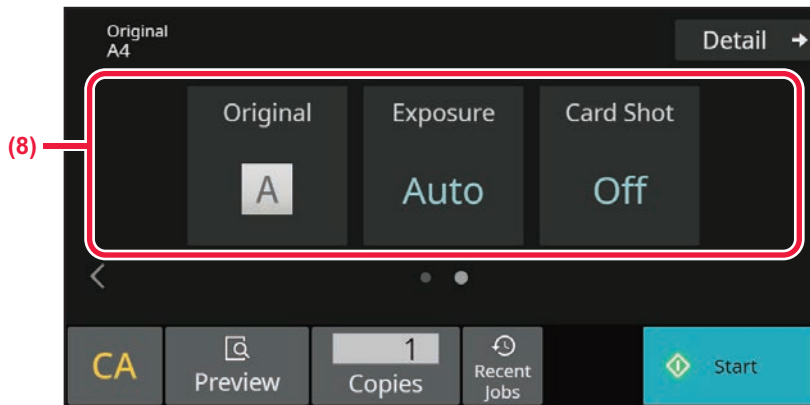

- | | |
|---|---|
| <p>(1) Show the size of the placed original.
 ► SELECTING THE ORIENTATION AND SIZE OF THE ORIGINAL (page 3-26)</p> <p>(2) Reset all settings.</p> <p>(3) Scans the original and shows a preview image.
 ► PREVIEW SCREEN (page 2-11)</p> <p>(4) Enter the number of copies.</p> | <p>(5) Recently used job setting can be loaded.
 ► Recent jobs (page 2-8)</p> <p>(6) Starts copying.</p> <p>(7) Change the function display.</p> <p>(8) Select function to be set up.</p> <p>(9) Change to normal mode.
 ► NORMAL MODE (page 3-5)</p> |
|---|---|



The following features can be set in easy mode.

- Paper Select
[SELECTING THE PAPER TRAY FOR COPYING \(page 3-13\)](#)
- 2-Side Copy
[AUTOMATIC 2-SIDED COPYING \(page 3-14\)](#)
- Copy Ration
[ENLARGE/REDUCE \(page 3-19\)](#)
- Staple/Punch
[OUTPUT \(page 3-33\)](#)
- Original
[SELECTING THE ORIENTATION AND SIZE OF THE ORIGINAL \(page 3-26\)](#)
- Exposure
[CHANGING THE EXPOSURE AND ORIGINAL IMAGE TYPE \(page 3-17\)](#)
- N-Up
[COPYING MULTIPLE ORIGINALS AS A SINGLE PAGE \(N-Up\) \(page 3-53\)](#)
- Card Shot
[COPYING BOTH SIDES OF A CARD AS A SINGLE PAGE \(CARD SHOT\) \(page 3-57\)](#)
- Job Build
[COLLECTIVELY SCANNING A LARGE NUMBER OF ORIGINALS \(JOB BUILD\) \(page 3-96\)](#)
- Blank Page Skip
[SKIPPING BLANK PAGES IN AN ORIGINAL \(BLANK PAGE SKIP\) \(page 3-77\)](#)
- Dual Page Copy
[COPYING EACH FACING PAGE OF A BOUND DOCUMENT \(DUAL PAGE COPY\) \(page 3-55\)](#)



- **To select a function in easy mode**

In "Settings (administrator)", select [System Settings] → [Common Settings] → [Operation Settings] → [Easy Mode Settings] → [Easy Copy].

- **To cancel the warning message displayed when switching from easy mode to normal mode**

In "Settings (administrator)", select [System Settings] → [Common Settings] → [Operation Settings] → [Easy Mode Settings] → [Display a Confirmation Message when Selecting "Detail" in Easy Modes] to disable this setting.



NORMAL MODE

Normal mode lets you select any function setting that can be used for copying.

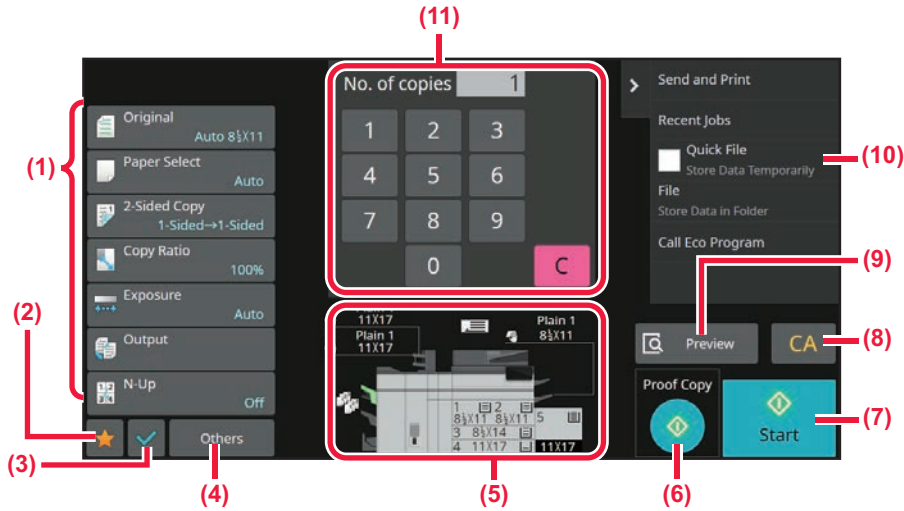

- (1) Setting keys used for copying.
- (2) Your favorite setting items will be displayed. Register frequently used [Other] and programs. Favorites can be registered when you register a program.
- (3) Check the current settings.
- (4) Display keys other than the Setting keys indicated above.
- (5) Indicates the presence or absence of an original and the size of paper loaded in each tray. Tap to open the paper select screen.
- (6) Used to make a proof copy.
- (7) Starts copying.
- (8) Reset all settings.
- (9) Scans the original and shows a preview image.
 - [PREVIEW SCREEN \(page 2-11\)](#)
- (10) Displays the functions that can be utilized in copy mode.
- (11) Enter the number of copies.



The displayed contents of the above screen will vary depending on the devices installed.

SELECTING COPY MODE

Change the copy mode to other mode as explained in [CHANGING MODES \(page 2-10\)](#).



BASIC PROCEDURE FOR MAKING COPIES

COPYING

This section explains the basic procedure for copying. Select settings in the order shown below to ensure that the copy operation takes place smoothly.

For detailed procedures for selecting the settings, see the explanation of each setting in this chapter.

1

Switch to copy mode.

[CHANGING MODES \(page 2-10\)](#)

2

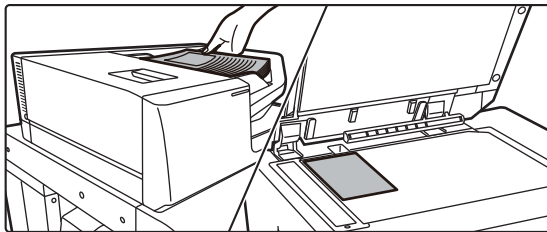

Place the original.

Place the original in the document feeder tray of the automatic document feeder, or on the document glass.

[AUTOMATIC DOCUMENT FEEDER \(page 1-34\)](#)

[DOCUMENT GLASS \(page 1-38\)](#)



3

Select functions.

Specify the original scan size, exposure, resolution, etc.

Tap the [Original] key and specify the orientation of the original to have the orientation be correctly recognized.

[SPECIFYING THE ORIENTATION OF THE ORIGINAL \(page 3-26\)](#)

In Easy mode

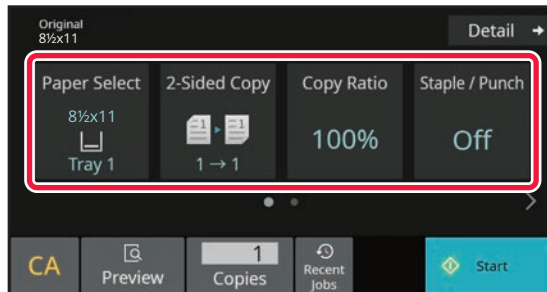

[SELECTING THE PAPER TRAY FOR COPYING \(page 3-13\)](#)

[AUTOMATIC 2-SIDED COPYING \(page 3-14\)](#)

[ENLARGE/REDUCE \(page 3-19\)](#)

[OUTPUT \(page 3-33\)](#)

[SELECTING THE ORIENTATION AND SIZE OF THE ORIGINAL \(page 3-26\)](#)

[CHANGING THE EXPOSURE AND ORIGINAL IMAGE TYPE \(page 3-17\)](#)

[COPYING MULTIPLE ORIGINALS AS A SINGLE PAGE \(N-Up\) \(page 3-53\)](#)

[COPYING BOTH SIDES OF A CARD AS A SINGLE PAGE \(CARD SHOT\) \(page 3-57\)](#)

[COLLECTIVELY SCANNING A LARGE NUMBER OF ORIGINALS \(JOB BUILD\) \(page 3-96\)](#)

[SKIPPING BLANK PAGES IN AN ORIGINAL \(BLANK PAGE SKIP\) \(page 3-77\)](#)

[COPYING EACH FACING PAGE OF A BOUND DOCUMENT \(DUAL PAGE COPY\) \(page 3-55\)](#)

In Normal mode



[SELECTING THE ORIENTATION AND SIZE OF THE ORIGINAL \(page 3-26\)](#)

[SELECTING THE PAPER TRAY FOR COPYING \(page 3-13\)](#)

[AUTOMATIC 2-SIDED COPYING \(page 3-14\)](#)

[ENLARGING/REDUCING THE LENGTH AND WIDTH SEPARATELY \(page 3-23\)](#)

[CHANGING THE EXPOSURE AND ORIGINAL IMAGE TYPE \(page 3-17\)](#)

[OUTPUT \(page 3-33\)](#)

[OTHER FUNCTIONS \(page 3-67\)](#)



4

Scan the original.

Tap the [Preview] key to scan the original.

In Easy mode

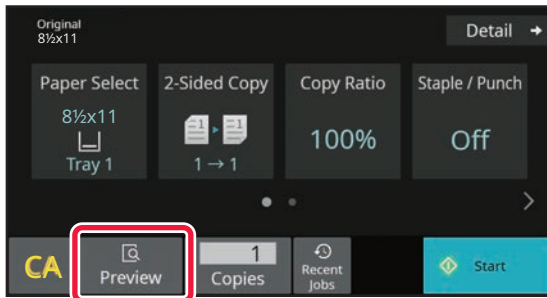

In Normal mode



- To make 2-sided copies, configure the 2-sided copy settings before scanning the original. [AUTOMATIC 2-SIDED COPYING \(page 3-14\)](#)
- When not checking the preview image, tap the [Start] key to start copying.



5

Check the preview image.

Display the preview image of the scanned original.

In the preview screen, check the settings.

[PREVIEW SCREEN \(page 2-11\)](#)

In Easy mode

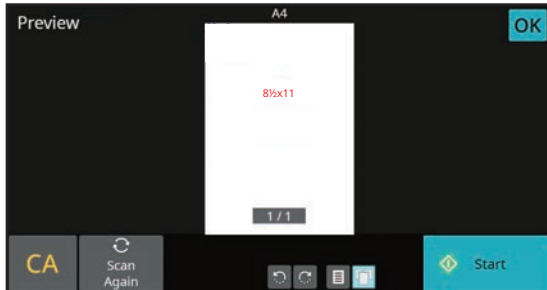

In Normal mode

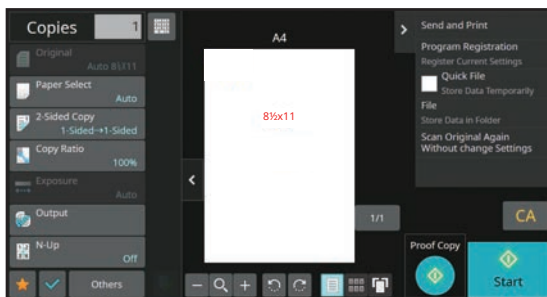

6

Tap the [Start] key to start copying.

When making only one set of copies, you do not need to specify the number of copies.



- To cancel all settings, tap the [CA] key.
When the [CA] key is tapped, all settings selected to that point are cleared and you will return to the base screen.
- To cancel copying, tap the [Cancel Copy] key.



- **To make two or more sets of copies:**
Tap the copies display key to specify the number of copies.
In Easy mode

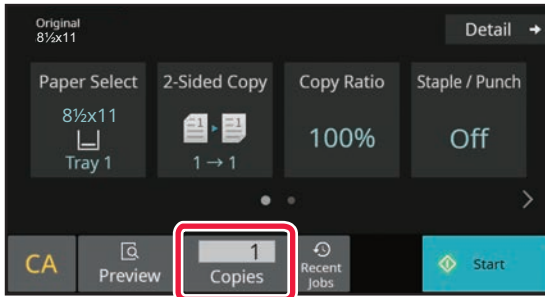

In Normal mode

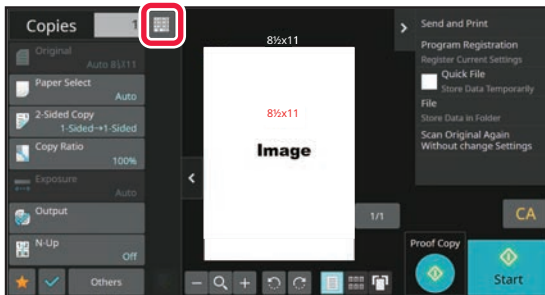

- In normal mode, you can tap [File] or [Quick File] on the action panel before starting the copy job to save the scanned original as a file.

[QUICK FILE \(page 7-9\)](#)

[FILE \(page 7-10\)](#)

DEFAULT SETTINGS FOR COPYING

Set in “Initial Status Settings” of “Copy Settings” in the System Settings.

[Initial Status Settings \(page 10-64\)](#)



CHECKING THE ORIGINAL SIZE

EASY MODE

The size of the placed original is displayed in the upper left corner of the screen.

When you place the original in the automatic document feeder, the original icon appears next to the original size.

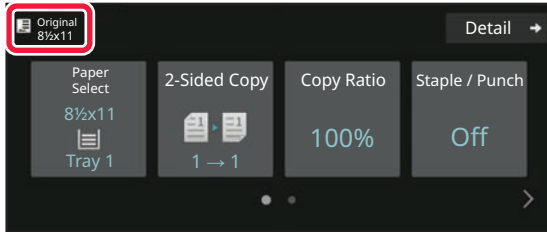

NORMAL MODE

Check the size of the placed original on the display of the [Original] key.

If the original size is set to [Auto], the automatically detected size (standard size) is displayed. If the original size is specified manually, the specified original size is displayed.

When you place the original in the automatic document feeder, the original icon appears above the automatic document feeder.



Standard sizes

Standard sizes are sizes that the machine can automatically detect.

For standard sizes that can be detected, refer to [DETECTABLE ORIGINAL SIZES \(page 1-32\)](#).



- Even when [Original] is set to [Auto], some original sizes may be detected as other one that is near the standard size. In this case, manually set the original size.
[SELECTING THE ORIENTATION AND SIZE OF THE ORIGINAL \(page 3-26\)](#)
- When placing a non-standard size original on the document glass, you can make it easier for the size to be detected by placing a blank sheet of 8-1/2" x 11" (A4), 5-1/2" x 8-1/2" (B5), or other standard size of paper on top of the original.



ORIENTATION OF PLACED ORIGINAL

Place the original as shown below.

If you place the original in an incorrect orientation, it may result in punching at an unexpected position or stapling.

On "Preview Screen", view the image orientation or preview image.

[PREVIEW SCREEN \(page 2-11\)](#)

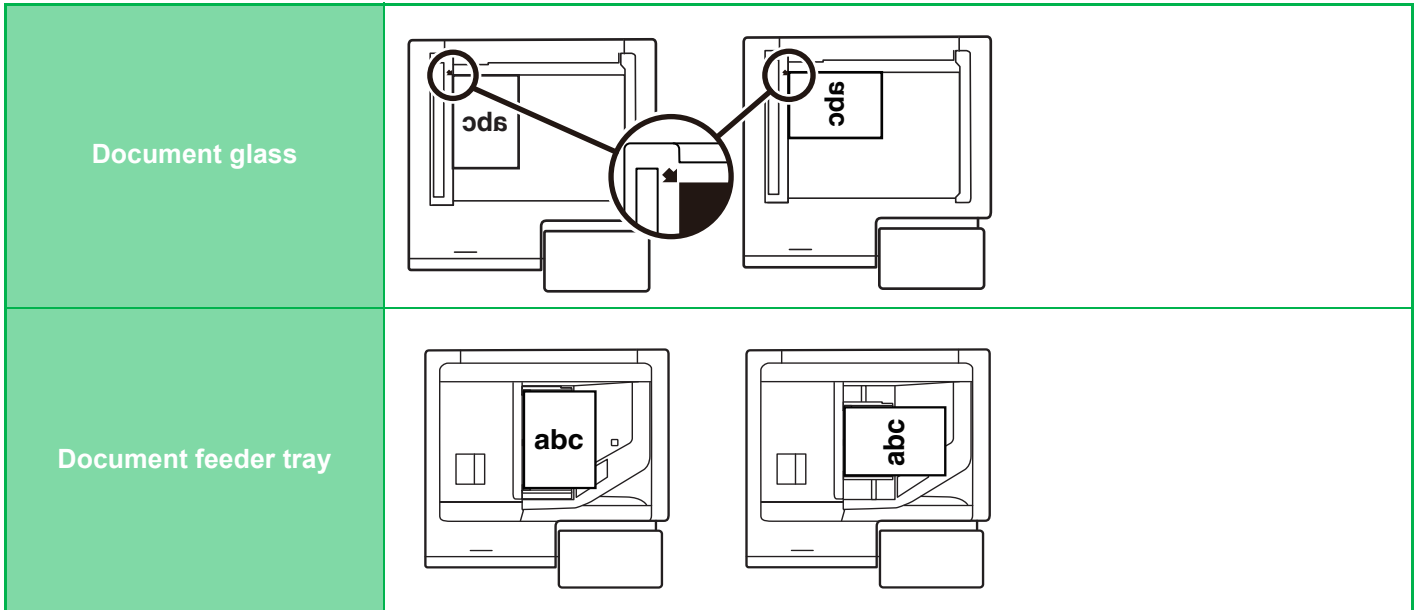

Set the orientation of the image to ensure that the orientation of the placed original is correctly recognized.

For information on the orientation of the original, see "[SPECIFYING THE ORIENTATION OF THE ORIGINAL \(page 3-26\)](#)".

AUTOMATIC COPY IMAGE ROTATION (ROTATION COPY)

If the orientation is different between the original and paper, the original image will be automatically rotated 90 degrees to match the paper.

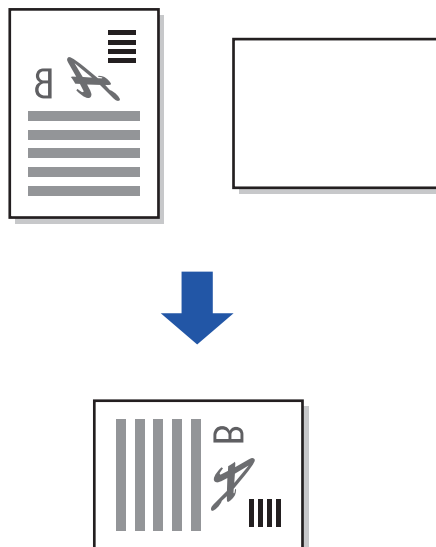



SELECTING THE PAPER TRAY FOR COPYING

The machine is set to automatically select a tray that has the same size of paper as the size of the placed original (Auto Paper Select).

If the original size cannot be detected correctly because it is a non-standard size or when you want to change the paper size for copying, you can select the paper tray manually.



- If the selected tray runs out of paper during a copy job and there is another tray that has the same size and type of paper, that tray will be automatically selected and the copy job will continue.
- If a suitable size of copy paper is not loaded, copying may stop.

1

Tap the [Paper Select] key.

[BASIC PROCEDURE FOR MAKING COPIES \(page 3-6\)](#)

2

Tap the required tray key.

After the settings are completed, tap [OK] key.

In Easy mode

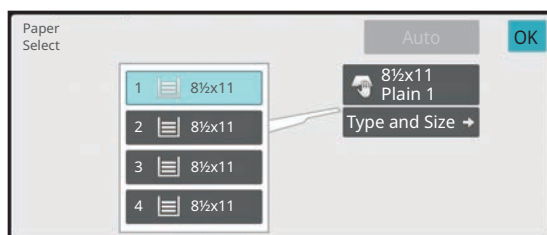

In Normal mode

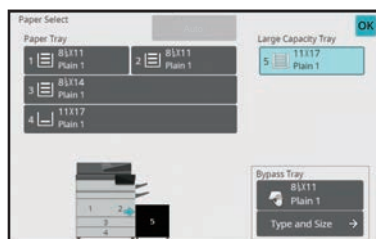

- When the bypass tray is selected, specify the paper type and size based on the paper loaded into the bypass tray.
[SPECIFYING A TYPE AND SIZE OF PAPER LOADED ON BYPASS TRAY \(page 3-32\)](#)
- In normal mode, you can also open the [Paper Select] screen by tapping the machine image on the base screen.



To automatically select the tray, tap the [Auto] key.



AUTOMATIC 2-SIDED COPYING

USING THE AUTOMATIC DOCUMENT FEEDER FOR 2-SIDED COPYING

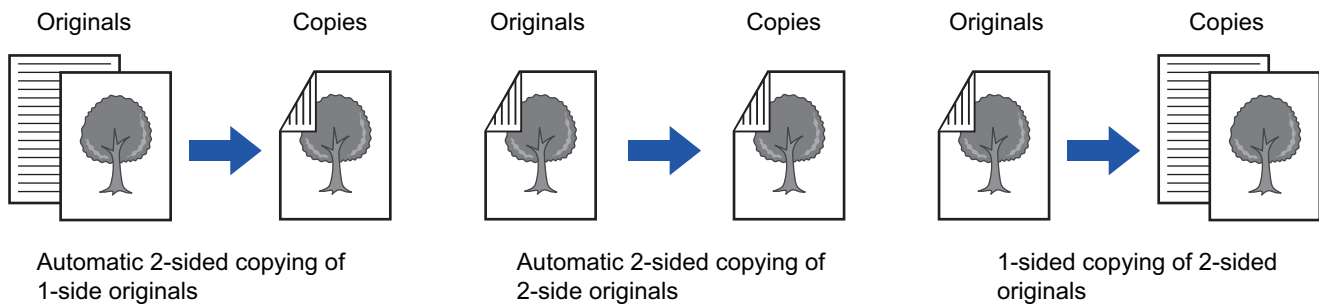

- To make 2-sided copies, configure the 2-sided copy settings before scanning the original.
- Dual-side copy helps to save paper.

1

Place the original in the document feeder tray of the automatic document feeder.

[AUTOMATIC DOCUMENT FEEDER \(page 1-34\)](#)

2

Tap the [2-Sided Copy] key.

[PREVIEW SCREEN \(page 2-11\)](#)

3

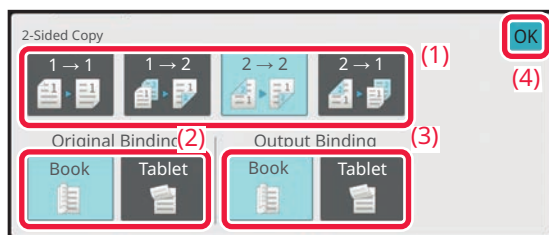

Select 2-sided copy mode.

- (1) Select the 2-sided copy type.
- (2) When the original is set to "2-Sided", select "Book" or "Tablet" in "Original Binding".
- (3) When the output is set to "2-Sided", select "Book" or "Tablet" in "Output Binding".
- (4) After the settings are completed, tap [OK].

4

Check the paper (tray) you want to use for copying, and tap the keys for any other settings you want to select.

Tap the [Original] key and specify the orientation of the original to have the orientation be correctly recognized.

[SPECIFYING THE ORIENTATION OF THE ORIGINAL \(page 3-26\)](#)

For details on the functions that can be set, see step 3 in "[COPYING \(page 3-6\)](#)".

5

Check the preview.

[PREVIEW SCREEN \(page 2-11\)](#)



6

Tap the [Start] key to start copying.

USING THE DOCUMENT GLASS FOR 2-SIDED COPYING

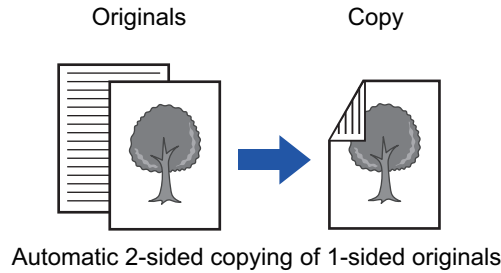

Dual-side copy helps to save paper.

1

Place the original on the document glass.

[DOCUMENT GLASS \(page 1-38\)](#)

2

Tap the [2-Sided Copy] key.

[BASIC PROCEDURE FOR MAKING COPIES \(page 3-6\)](#)

3

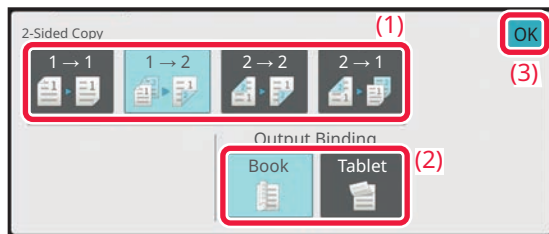

Select the 2-sided copy mode.

- (1) Tap the [1 → 2] key.
- (2) When the output is set to "2-Sided", select "Book" or "Tablet" in "Output Binding".
- (3) After the settings are completed, tap [OK].



- The [2 → 2] key and [2 → 1] key cannot be used when copying from the document glass.
- Depending on the size of the placed original, there may be cases where the same size of paper as the original is not selected automatically. In this case, change the paper tray manually.

4

Check the paper (tray) you want to use for copying, and tap the keys for any other settings you want to select.

Tap the [Original] key and specify the orientation of the original to have the orientation be correctly recognized.

[SPECIFYING THE ORIENTATION OF THE ORIGINAL \(page 3-26\)](#)

For details on the functions that can be set, see step 3 in "[COPYING \(page 3-6\)](#)".



5

Tap the [Start] key.

6

Set the next original, and tap the [Start] key to scan the original.

Tap the same key you tapped in step 5.
Repeat this step until all originals have been scanned.

7

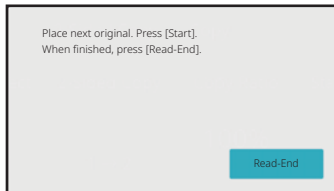

Tap the [Read-End] key to start copying.



CHANGING THE EXPOSURE AND ORIGINAL IMAGE TYPE

AUTOMATIC ADJUSTMENT OF EXPOSURE AND ORIGINAL TYPE

Automatic exposure adjustment operates by default to automatically adjust the exposure level and original type as appropriate for the original being copied. ([Auto] is displayed.)

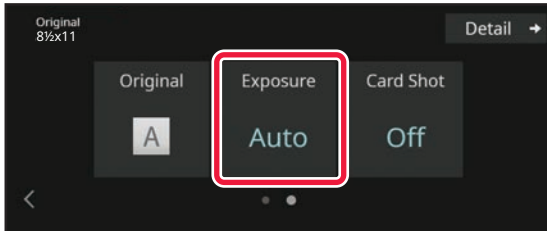

MANUAL ADJUSTMENT OF EXPOSURE AND ORIGINAL TYPE

This section explains how to select the original type depending on the original to be copied or manually adjust the exposure.

1

Tap the [Exposure] key.

[COPY MODE \(page 3-3\)](#)

2

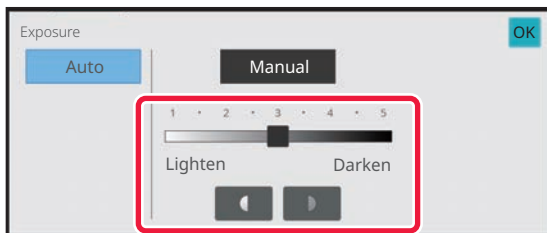

Tap   or slide the slider to adjust the copy exposure.

After the adjustment, tap [OK] key.

This completes the procedure in easy mode.

3

To select more detailed settings, tap the [Detail] key to switch to normal mode.

[EASY MODE \(page 3-3\)](#)

4

Tap the [Exposure] key.



5

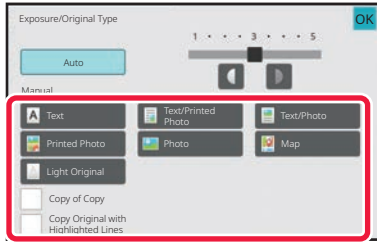

Tap the required original image type key to specify the original type.

Tap the key matching the original.

Original image type select keys

- Text : Use this mode for regular text documents.
- Text/Printed Photo : This mode provides the best balance for copying an original which contains both text and printed photographs, such as a magazine or catalogue.
- Text/Photo : This mode provides the best balance for copying an original which contains both text and photographs, such as a text document with a photo pasted on.
- Printed Photo : This mode is best for copying printed photographs, such as photos in a magazine or catalogue.
- Photo : Use this mode to copy photos.
- Map : This mode is best for copying the light color shading and fine text found on most maps.
- Light Original : Use this mode for originals with light pencil writing.



- When using a copy or printed page from the machine as an original:
When using a copy or printed page from the machine as an original, tap the [Copy of Copy] checkbox so that appears.
[Copy of Copy] is available when [Auto], [Text], [Printed Photo], or [Text/Printed Photo] is selected as the original image type.
- When you want to make fluorescent marker parts more visible:
When using a page with highltd lines as an original, tap the [Copy Original with Highlighted Lines] checkbox so that appears.

6

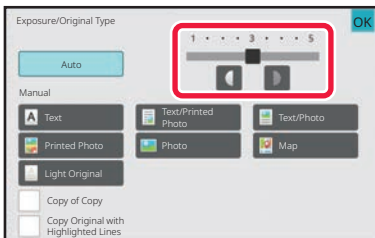

Tap or slide the slider to adjust the copy exposure.

If you adjust the exposure with the original type selected to [Auto], the original image type is automatically selected to [Text/Printed Photo].

After the adjustment, tap [OK] key.



Guidelines for the exposure level when [Text] is selected for "Exposure/Original Type"

- 1 to 2: Dark originals such as a newspaper
- 3: Normal density originals
- 4 to 5: Originals written in pencil or light colored text



ENLARGE/REDUCE

AUTO RATIO SELECT

This section explains how to automatically select the appropriate ratio to meet the paper size when manually changing the paper tray to make a copy on paper that has a size different from the original.

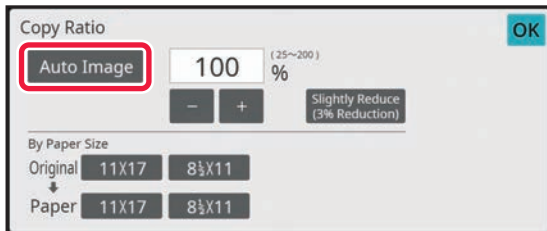

For a non-standard size original, the size must be entered in order to use Auto Image.

1

Manually select the paper tray, and place the original.

Place the original in the document feeder tray of the automatic document feeder, or on the document glass.

[SELECTING THE PAPER TRAY FOR COPYING \(page 3-13\)](#)

[AUTOMATIC DOCUMENT FEEDER \(page 1-34\)](#)

[DOCUMENT GLASS \(page 1-38\)](#)

2

Tap the [Copy Ratio] key.

[COPY MODE \(page 3-3\)](#)

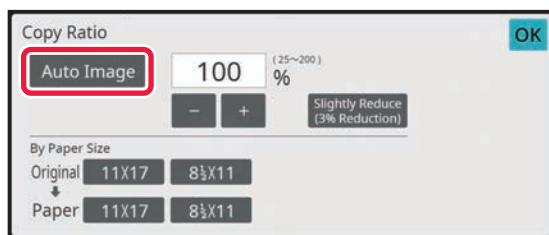
3

Tap the [Auto Image] key.

The reduction or enlargement ratio is automatically selected based on the original size and the selected paper size. The automatically selected ratio will appear in the ratio display.



- **To cancel the Auto Ratio Selection setting:**

Tap [Auto Image] to deselect it.

- **To return the ratio to 100%:**

Tap the [100%] key.



MANUAL RATIO SELECTION

This section explains how to specify any ratio when making a copy on paper that has a size different from the original or changing the image size for copying.

The following three methods can be used to specify the ratio.

Specifying the desired zoom ratio

You can adjust the zoom ratio in 1% increments using   or the 10 key to specify the desired zoom ratio.

You can also select the enlargement or reduction ratio between commonly used fixed sizes from the preset ratio keys.

Up to two ratio values can be added to preset ratio keys, respectively for enlargement and reduction.

Specifying the paper size

Specify the paper sizes of the original and output to automatically obtain the appropriate ratio.

For example, when you select 11" x 17" (A3) as the original size and 8-1/2" x 11" (A4) as the paper size, the ratio is automatically set to 64% (70%).

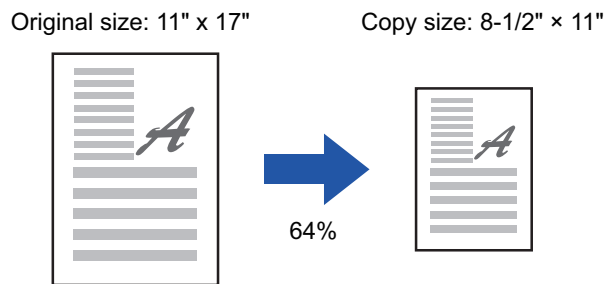

Specifying the image dimensions

Specify the image sizes of the original and output to automatically obtain the appropriate ratio.

To make a copy with the same ratio between the vertical and horizontal sizes, enter either one of the vertical and horizontal sizes.

For example, when you enter 90mm as the source size and 135mm as the output size, the aspect ratio will be automatically set to 150%.

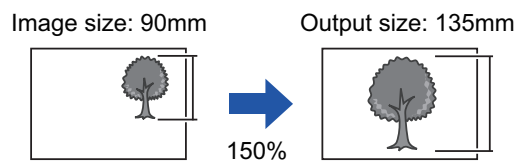

When the automatic document feeder is used, the vertical and horizontal ratio selection ranges are both between 25% to 200%.



To return the ratio to 100%:
Tap the [100%] key.



Specifying the desired zoom ratio

1

Tap the [Copy Ratio] key.

[COPY MODE \(page 3-3\)](#)

2

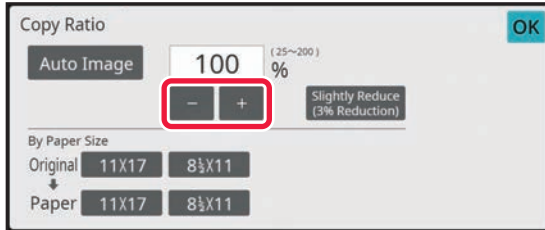

Tap **- +** to set the ratio.

After the settings are completed, tap [OK] key.

Check that a paper size suitable for the ratio is selected.



- If you tap the [Slightly Reduce (3% Reduction)] key, the ratio will be set lower than the specified one by 3%.

In normal mode

- There are two setting screens. Use the [Other Ratio] key to switch between the screens.
- To quickly set the area, first specify a value close to the desired value by the numeric keys, then adjust it with **- +**.
- Up to two frequently used ratio values can be added to the preset ratio key, respectively for enlargement and reduction.



To cancel all settings:

Tap the [CA] key.

Specifying the paper size

1

Tap the [Copy Ratio] key.

[COPY MODE \(page 3-3\)](#)

2

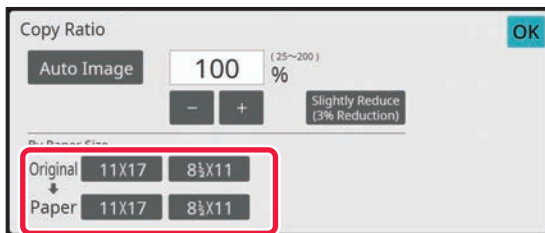

Specify the original size (paper size of the loaded original) and the copy size (paper size of the copy output).

After the settings are completed, tap [OK] key.



To cancel all settings:

Tap the [CA] key.



Specifying the image dimensions

1

Tap the [Detail] key to change to normal mode.

[EASY MODE \(page 3-3\)](#)

2

Tap the [Copy Ratio] key.

3

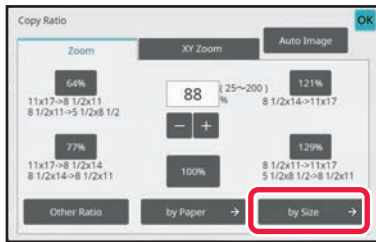

Tap the [by Size] key of the [Zoom] tab.

4

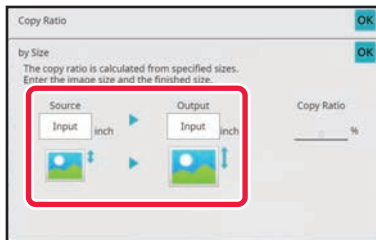

Specify the image size (dimensions of the image to be enlarged or reduced) and the output size (dimensions of the enlarged and reduced images).

Tap the area of image size and output size, and enter the sizes using the numeric keys.

After the settings are completed, tap [OK] key.



• **If you have entered an incorrect size:**

Tap the [C] key on the numeric keys that appears when you tap the entry area, and set to the correct size.

• **To cancel all settings:**

Tap the [CA] key.



ENLARGING/REDUCING THE LENGTH AND WIDTH SEPARATELY

This section explains how to individually specify the horizontal and vertical copy ratios.

When 50% is selected for the horizontal ratio and 70% is selected for the vertical ratio

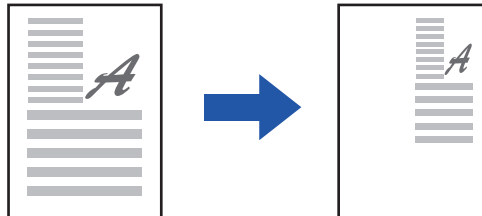



The following three methods can be used to specify the ratio.

Using the preset ratio key

Specify any ratio by combination of preset ratio key, which is pre-registered.

Specify the desired ratio

Specify any ratio by combining   , which allows you to adjust the ratio in 1% increments.

Specifying the image dimensions

Specify the image sizes of the original and output to automatically obtain the appropriate ratio.
Enter the vertical and horizontal sizes.



When the automatic document feeder is used, the vertical and horizontal ratio selection ranges are both between 25% to 200%.



To cancel the XY zoom setting:
Tap the [Zoom] tab or the [CA] key.



Using the preset ratio key

1

Tap the [Detail] key to change to normal mode.

[EASY MODE \(page 3-3\)](#)

2

Tap the [Copy Ratio] key, and then tap the [XY Zoom] tab.

3

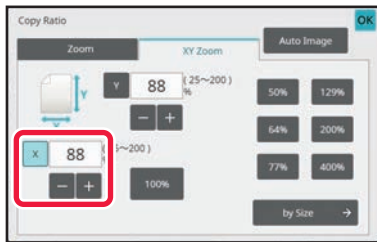

Tap the [X] key, and set the X (horizontal) ratio.



- To quickly set the ratio, first specify a value close to the desired one, then adjust it with **-** **+**.
- Tap each area of the X (horizontal) and Y (vertical) directions, and enter the sizes using the numeric keys.

4

Tap the [Y] key, and set the Y (vertical) ratio in the same way as the [X] key.

After the settings are completed, tap [OK] key.

Check that a paper size suitable for the ratio is selected.



Specifying the image dimensions

1

Tap the [by Size] key.

[Specifying the desired zoom ratio \(page 3-21\)](#)

2

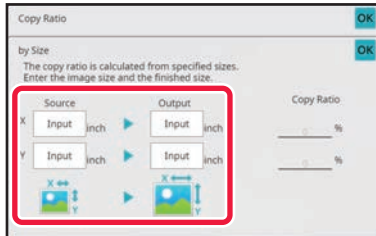

Specify the X and Y dimensions of the image size and those of the output size.

Check that a paper size suitable for the ratio is selected. After the settings are completed, tap [OK] key.



Tap the image size and output size areas, and enter the sizes using the numeric keys.



• **If you have entered an incorrect size:**

Tap the [C] key on the numeric keys that appears when you tap the entry area, and set to the correct size.

• **To cancel all settings:**

Tap the [CA] key.



SELECTING THE ORIENTATION AND SIZE OF THE ORIGINAL

When the original size is a non-standard size or is not detected correctly, manually specify the original size. Set the orientation of the image to ensure that the orientation of the placed original is correctly recognized.



Set the orientation and size of the original before scanning the original

SPECIFYING THE ORIENTATION OF THE ORIGINAL

By specifying the starting side (top or left side) of the placed original, the orientation of the original will be correctly recognized.

Finishing position settings and N-Up layout settings are specified using the recognized orientation.

In Easy mode

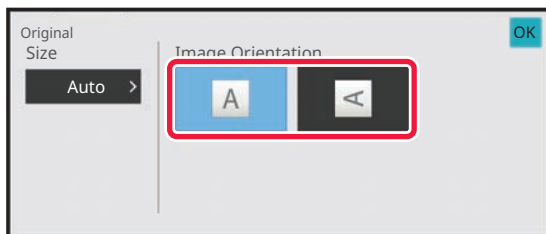

In Normal mode



SPECIFY THE ORIENTATION AND SIZE OF THE ORIGINAL

1

Tap the [Original] key to set the orientation of the original.

[COPY MODE \(page 3-3\)](#)

2

Tap the [Auto] key.



3

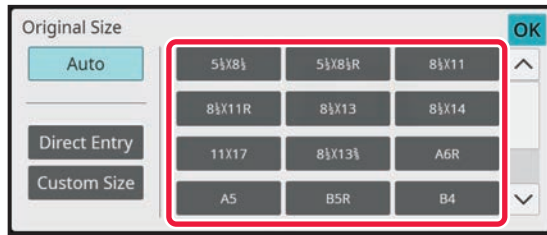

Tap the appropriate original size key.

After the settings are completed, tap [OK] key.

SPECIFYING THE ORIENTATION AND SIZE OF A NON-STANDARD SIZE ORIGINALS

1

Tap the [Original] key to set the orientation of the original.

[COPY MODE \(page 3-3\)](#)

2

Tap the [Auto] key.

3

Tap the [Direct Entry] key.

4

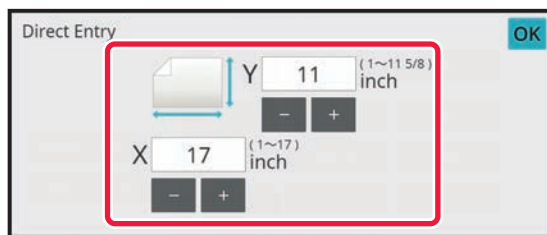

Specify the original size.

After the settings are completed, tap [OK] key.



- Tap the areas displaying width and height sizes respectively, and enter the sizes using the numeric keys.
- It is convenient to use **- +** to finely adjust the entered size.

5

Tap the [OK] key.

Make sure that the original size you have set is displayed in the upper left corner of the screen.



STORING FREQUENTLY USED ORIGINAL SIZES

Store the frequently used non-standard original sizes. This section explains how to store, retrieve, change, and delete non-standard original sizes.



- The stored original size will be retained even if the main power is turned off.
- A total of up to 12 non-standard original sizes can be registered for copying, fax, and image sending.
- The added original sizes will also appear in other modes.
- You can register, modify, and delete the original size only in Normal mode.

STORING ORIGINAL SIZES (MODIFY/DELETE)

1

Tap the [Detail] key to change to normal mode.

[EASY MODE \(page 3-3\)](#)

2

Tap the [Original] key.

3

Tap the [Custom Size] tab.

4

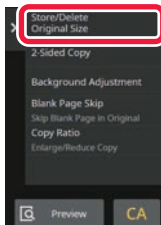

Tap [Store/Delete Original Size] on the action panel.



5

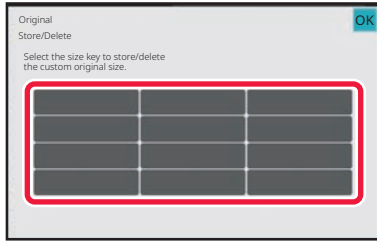

Tap a key () for storing a custom original size.

Tap a key that does not show a size.



To modify or delete a previously stored key:

Tap the key that you want to modify or delete. The following screen will appear.

- To modify the key, tap the [Modify] key and go to the next step.
- To delete the key, tap the [Delete] key. Make sure that the original size has been cleared and tap the [OK] key.

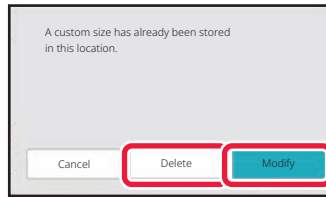

6

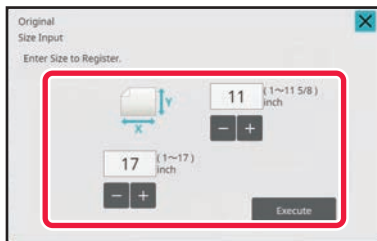

Specify the original size.

Tap the areas displaying width and height sizes respectively, and enter the sizes using the numeric keys.



It is convenient to use **- +** to finely adjust the entered size.

7

Tap the [OK] key.

After the settings are completed, tap the **X** key, and check that the key of the size stored on the original screen is added properly. After you have checked it, tap [OK].



To cancel the operation:

Tap the [CA] key.



Retrieving a stored original size

1

Perform steps 1 to 2 in [SPECIFY THE ORIENTATION AND SIZE OF THE ORIGINAL \(page 3-26\)](#).

2

Tap the [Custom Size] key.

3

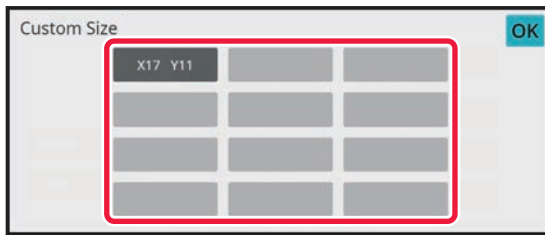

Tap the key of the original size that you wish to retrieve.

After selecting the key of the original size, tap the [OK] key.



To cancel the operation
Tap the [CA] key.

4

Tap the [OK] key.

Make sure that the original size you have set is displayed in the upper left corner of the screen.



MAKING COPIES USING THE BYPASS TRAY

MAKING COPIES USING THE BYPASS TRAY

In addition to plain paper, the bypass tray allows you to make copies on transparency film, tab paper, and other special media.



For detailed information on paper that can be loaded into the bypass tray, see "[APPLICABLE PAPER TYPES \(page 1-12\)](#)".
For precautions on loading paper into the bypass tray, see "[LOADING PAPER INTO THE BYPASS TRAY \(page 1-28\)](#)".

1

Load paper into the bypass tray.

[LOADING PAPER INTO THE BYPASS TRAY \(page 1-28\)](#)

2

Tap the [Paper Select] key, and tap the bypass tray key.

The bypass tray key displays the size and type of the loaded paper.

[SELECTING THE PAPER TRAY FOR COPYING \(page 3-13\)](#)



When the setting requires change, tap the [Type and Size] key and select the paper size and type.

[SPECIFYING A TYPE AND SIZE OF PAPER LOADED ON BYPASS TRAY \(page 3-32\)](#)

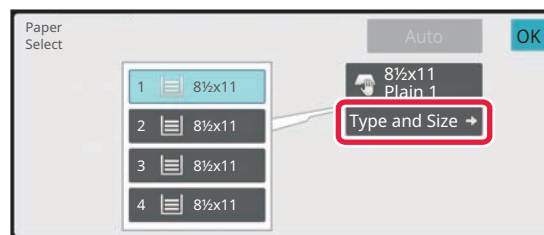

3

Place the original.

Place the original in the document feeder tray of the automatic document feeder, or on the document glass.

[AUTOMATIC DOCUMENT FEEDER \(page 1-34\)](#)

[DOCUMENT GLASS \(page 1-38\)](#)

4

Tap the [Start] key to start copying.



SPECIFYING A TYPE AND SIZE OF PAPER LOADED ON BYPASS TRAY

1

Tap the [Paper Select] key.

[SELECTING THE PAPER TRAY FOR COPYING \(page 3-13\)](#)

2

Tap the [Type and Size] key, and tap the key that meets the type of the loaded paper.

3

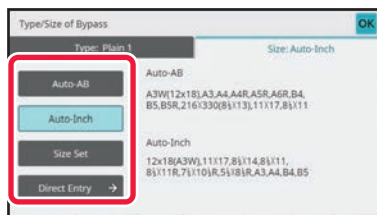

Tap the [Size] tab, and tap the key that meets the size of the loaded paper.

- **[Auto-AB]:**
Automatically detects the appropriate AB paper size when loading paper such as A4 or B5.
- **[Auto-Inch]:**
Automatically detects the appropriate inch paper size when loading paper such as 8-1/2"x11".
- **[Size Set]:**
Tap this key to manually specify the paper size that is not detected automatically.
- **[Direct Entry]:**
Tap this key to enter a numeric value for the size of the loaded paper.

After the settings are completed, tap [OK] key.



To directly enter a paper size

- Tap the [inch] key to set a paper size in inches, or tap the [AB] key to set it in millimeters.
- After you have entered the paper size using the **- +** key, tap the [OK] key.

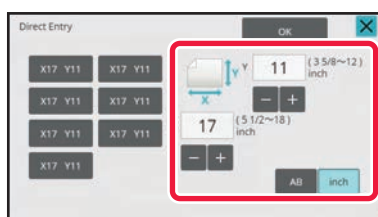



OUTPUT

Configure the output settings for copies using Sort, Group, Offset, Separator Page, Staple, Punch, or Fold. Also specify the output destination of copies.

You can tap the [Output] key in normal mode to configure settings for all output functions.

Settings for the staple and punch functions can also be configured from simple mode.

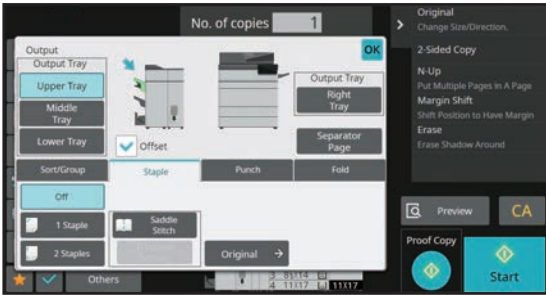

Output screen of normal mode

Output Tray

Specify the destination to output copies.

If a finisher (large stacker) or saddle stitch finisher (large stacker) is installed, you can select [Upper Tray], [Middle Tray], or [Lower Tray], or if a saddle finisher is installed, you can select from [Top Tray], [Finisher Tray], or [Right Tray].

Offset

This function outputs copies while shifting them set by set. Setting the checkbox to enables the offset function, and setting it to disables the function.

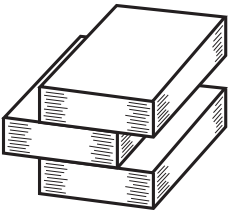

Offset enabled

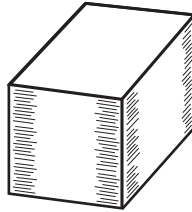

Offset disabled



This function is available when a finisher or saddle stitch finisher is installed and [Upper Tray], [Lower Tray] or [Finisher Tray] is selected as the output tray.



Selecting the staple function clears the Offset checkmark automatically.



Separator Page

This function inserts separator pages for every specified number of copies or for every job before they are output.

[REPEATING THE SAME IMAGE ON ONE SHEET \(REPEAT LAYOUT\) \(page 3-59\)](#)

Sort/Group

Select the sorting method when copying the scanned original.

"Sort" sorts the scanned original on a set basis, and outputs them. "Group" sorts the scanned original on a page basis, and outputs them.

[SORT/GROUP SETTING \(page 3-36\)](#)

Staple

Each set of copies can be stapled, or the sheets can be folded at the center and stapled.

[Staple ON \(excluding saddle stitch\) \(page 3-38\)](#)

[Saddle Stitch \(page 3-39\)](#)



- The staple function is available only when the finisher or saddle stitch finisher is installed.
- The saddle stitch function is available only when the saddle stitch finisher is installed.

Punch

This function punches copies and outputs them.

[PUNCH SETTINGS \(page 3-43\)](#)



The punch function is available only when the punch module is installed.

Fold

Copies can be folded and output.

[FOLD SETTING \(page 3-45\)](#)



The folding function is available when a finisher or saddle finisher is installed and [Upper Tray], [Lower Tray] or [Finisher Tray] is selected as the paper output destination.



CHANGING OUTPUT DESTINATION

Specify the destination to output copies.

1

Tap the [Detail] key to change to normal mode.

[COPY MODE \(page 3-3\)](#)



Tap the [Original] key and specify the orientation of the original to have the orientation be correctly recognized.

[SPECIFYING THE ORIENTATION OF THE ORIGINAL \(page 3-26\)](#)

2

Tap the [Output] key.

3



Select the output tray from "Output Tray".

After the settings are completed, tap [OK] key.



- If a finisher (large stacker) or saddle stitch finisher (large stacker) is installed, select the [Upper Tray], [Middle Tray] or [Lower Tray] key.
- If a finisher or saddle stitch finisher is installed, select the [Top Tray] or [Finisher Tray] key.



SORT/GROUP SETTING

This section explains how to select the sorting method when outputting the scanned original.

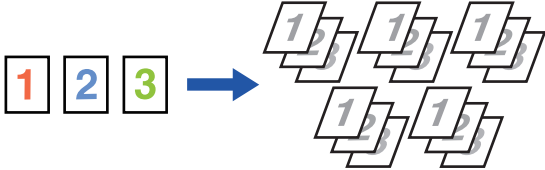
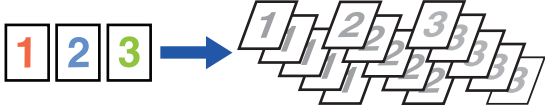
Auto	Enables the sort mode when the original is placed in the automatic document feeder, and enables the group mode when the original is placed on the document glass.
Sort	Sorts the scanned original on a set basis, and outputs them. Example: When 5 is set for the number of copies in sorting 
Group	Groups the scanned original on a page basis, and outputs them. Example: When 5 is set for the number of copies in grouping 

1

Tap the [Detail] key to change to normal mode.

[EASY MODE \(page 3-3\)](#)



Tap the [Original] key and specify the orientation of the original to have the orientation be correctly recognized.
[SPECIFYING THE ORIENTATION OF THE ORIGINAL \(page 3-26\)](#)

2

Tap the [Output] key.

3

Tap the [Sort/Group] tab, then tap the [Auto] key, the [Sort] key, or the [Group] key.

After the settings are completed, tap [OK] key.















- You can select the offset output checkbox to have each set of output be offset from the previous set to enable easy removal from the output tray.
- To change the output tray, tap the [Output Tray] key, and select the output destination.

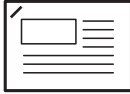
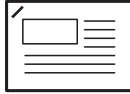

STAPLE SETTINGS

Specify whether or not the set of output will be stapled.

Portrait orientation

Original Orientation	Staple	Staple Position		
		Left	Top	Right
Portrait orientation	1 Staples			
	2 Staples			
	Stapleless Staple			
Landscape orientation	1 Staples			
	2 Staples			
	Stapleless Staple			



- You can view staple positions on the "[PREVIEW SCREEN \(page 2-11\)](#)". Text will be printed at the preset size regardless of the copy ratio or paper size setting.
- A finisher, finisher (large stacker), saddle stitch finisher or saddle stitch finisher (large stacker) is required to use the staple function.
- A saddle stitch finisher or saddle stitch finisher (large stacker) is required to use the saddle stitch function.
- A finisher (large stacker) or saddle stitch finisher (large stacker) is required to use the stapleless staple.



Staple ON (excluding saddle stitch)

1

Tap the [Staple / Punch] key.

[COPY MODE \(page 3-3\)](#)



Tap the [Original] key and specify the orientation of the original to have the orientation be correctly recognized.

[SPECIFYING THE ORIENTATION OF THE ORIGINAL \(page 3-26\)](#)

2

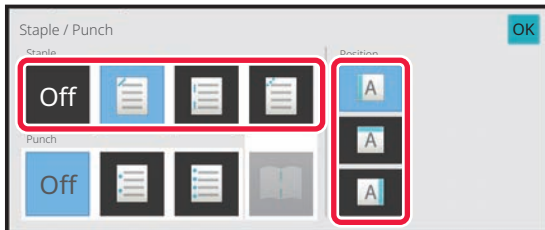

Select the number of staples and staple position.

- After the settings are completed, tap [OK] key.
- A binding position cannot be selected for stapleless stapling.



In normal mode

- Tap the [Output] key and [Staple] tab.

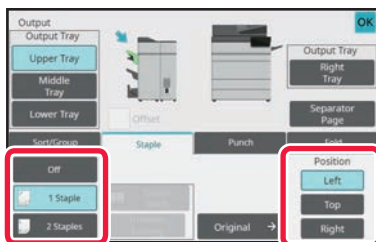

- To change the output paper output tray, select the output destination in [Output Tray] of [Other functions] before setting the staples.
- If the number of scanned originals exceeds the staple sheet limit, a message is displayed. Tap [Continue] or [Cancel].
[Cancel]: Cancels the staple sort setting.
[Continue]: Continues sorting without stapling.



Saddle Stitch

1

Tap the [Staple / Punch] key.

[COPY MODE \(page 3-3\)](#)



Tap the [Original] key and specify the orientation of the original to have the orientation be correctly recognized.

[SPECIFYING THE ORIENTATION OF THE ORIGINAL \(page 3-26\)](#)

2

Select .

3

Select binding edge and original settings.

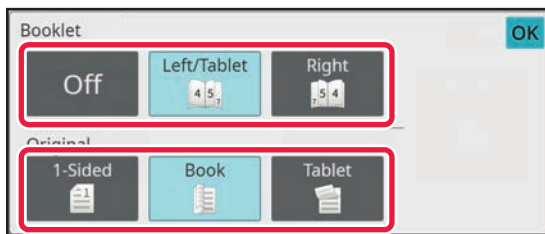

[MAKING COPIES IN PAMPHLET FORMAT \(BOOKLET\) \(page 3-67\)](#)

After the settings are completed, tap [OK] key.



Staple settings in normal mode

1

Tap the [Detail] key to change to normal mode.

[EASY MODE \(page 3-11\)](#)



Tap the [Original] key and specify the orientation of the original to have the orientation be correctly recognized.

[SPECIFYING THE ORIENTATION OF THE ORIGINAL \(page 3-26\)](#)

2

Tap the [Output] key.

3

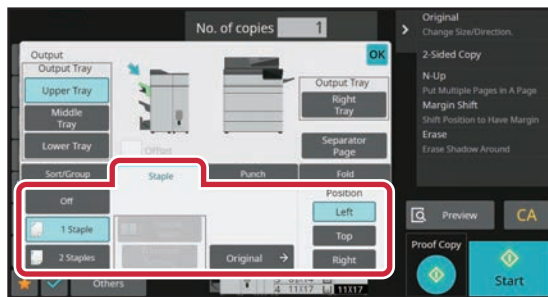

Tap the [Staple] tab, and tap the staple position key.

Staple position can be selected from "Position" when selecting keys other than [Off], [1 Staple (Diagonal)], and [Saddle Stitch].

After the settings are completed, tap [OK] key.



- Stapleless Staple requires a finisher or saddle finisher to be installed.
- If you perform 1-staple stapling with a finisher (large stacker) or saddle stitch finisher (large stacker) installed, all staples will be stapled diagonally.
- If the number of scanned originals exceeds the staple sheet limit, a message is displayed. Tap the [Continue] or [Cancel] key.
[Continue]: Continues sorting without stapling.
[Cancel]: Cancels the staple sort setting.



To cancel the staple function:

Tap the [Off] key.



Saddle stitching for sorted copies

This function staples each set of copies at two positions in the center of paper, folds them in half, and outputs them. For saddle folding, it trims a side drop, offering a good-looking output image.

The setting procedure in normal mode is explained.

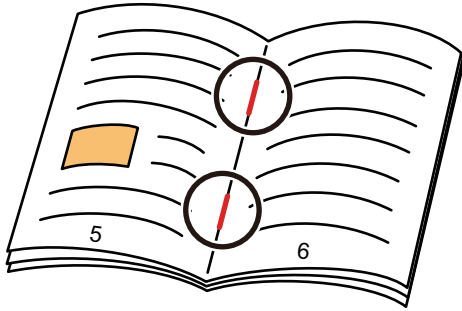

- You can view staple positions in "[PREVIEW SCREEN \(page 2-11\)](#)".
- A saddle stitch finisher is required to use the saddle stitch function.
- The trimmer function is available when a trimmer unit is installed on the machine.

Saddle Stitch (Normal mode)

1

Tap the [Detail] key to change to normal mode.

[EASY MODE \(page 3-11\)](#)



Tap the [Original] key and specify the orientation of the original to have the orientation be correctly recognized.
[SPECIFYING THE ORIENTATION OF THE ORIGINAL \(page 3-26\)](#)

2

Tap the [Output] key.

3

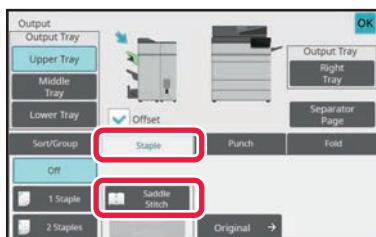

Tap the [Staple] tab, and tap the [Saddle Stitch] key.



4

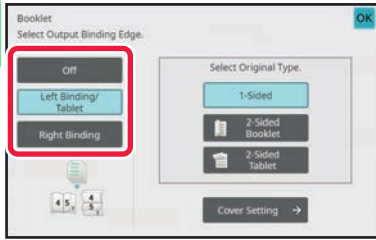

Tap the [Left Binding/Tablet] or [Right Binding] key to select an original and configure the cover sheet setting.

After the settings are completed, tap [OK] key.



- The original will be scanned from the innermost side when folded.
- If the number of scanned originals exceeds the staple sheet limit, a message is displayed. Tap [Divide], [Continue] or [Cancel].
[Cancel].: Cancels printing.
[Divide]: Divide the document into the number of sheets that can be stapled and saddle staple them.
[Continue]: Continue printing without saddle stapling.



To cancel the Saddle Stitch:
Tap the [Off] key.

Trimmer Setting

1

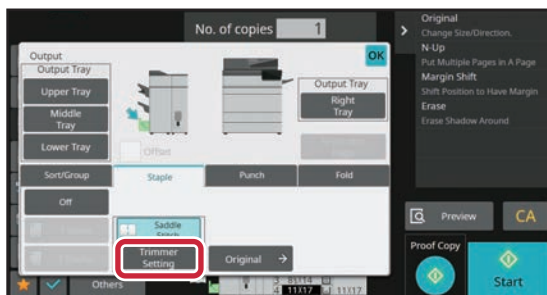

When Saddle Stitch is selected, tap the [Trimmer Setting] key.

2

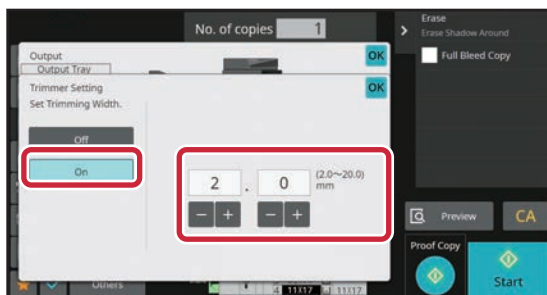

Tap the [On] key, and specify the trimming width.

Tap the numeric value display field of the trimming width, and enter the allowable range using the numeric keys. Otherwise, tap **- +**. After the settings are completed, tap [OK] key.



To cancel the Trimmer Setting:
Tap the [Off] key.



PUNCH SETTINGS

This function punches copies and outputs them to the tray.

Example: When the original is in either portrait or landscape orientation, and the punch position is set to the left

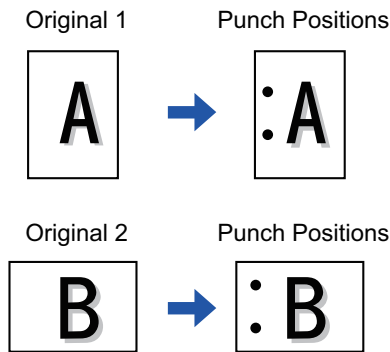

Original Orientation	Punch Position		
	Left	Top	Right
OFF	Does not punch.		
Portrait orientation			
Landscape orientation			



- When staple and punch are set at the same time, punch positions are linked to staple positions.
- You can view punch positions on the "[PREVIEW SCREEN \(page 2-11\)](#)".
- A punch module is required for paper punch.
- You cannot use 12" x 18" (A3W) size paper or special media such as transparency film and tab paper.
- You cannot use a paper punch together with the staple and paper folding.
However, it can be used with them if the paper size used is 11" x 17", A3, B4 or 8K for Z-fold.

1

Tap the [Staple / Punch] key.

[COPY MODE \(page 3-3\)](#)



Tap the [Original] key and specify the orientation of the original to have the orientation be correctly recognized.
[SPECIFYING THE ORIENTATION OF THE ORIGINAL \(page 3-26\)](#)

2

Select punching and set the position.

After the settings are completed, tap [OK].



Normal mode

1

Tap the [Detail] key to change to normal mode.

[EASY MODE \(page 3-11\)](#)



Tap the [Original] key and specify the orientation of the original to have the orientation be correctly recognized.

[SPECIFYING THE ORIENTATION OF THE ORIGINAL \(page 3-26\)](#)

2

Tap the [Output] key.

3

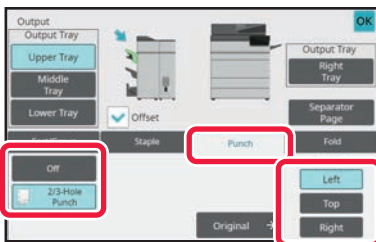

Tap the [Punch] tab, select punching and set the position.

To change the output tray, tap the [Output Tray] key, and select the output destination.

After the settings are completed, tap [OK] key.



To cancel the punch Setting:

Tap the [Off] key.



FOLD SETTING

This function is used to fold copies before delivery to the output tray.
 When a paper folding unit is installed, you can fold papers in Z-fold and C-fold.
 When a saddle stitch finisher is installed, you can use saddle folds.
 The paper sizes that can be selected vary depending on the type of paper fold.
 Example: Fold Inside, Fold Outside

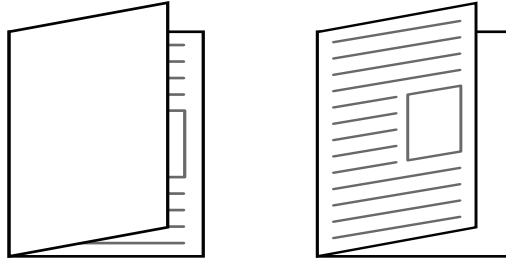

To change the default fold setting:

In "Settings (administrator)", select [System Settings] → [Copy Settings] → [Initial Status Settings] → [Fold].



- A saddle stitch finisher or saddle stitch finisher (large stacker) is required to use the Saddle Fold function.
- A folding unit is required to use the Z-Fold, C-Fold, Accordion Fold, Double Fold, and Half Fold.
- The fold function cannot be used in combination with the staple function and punch function. However, when the finisher or saddle stitch finisher is installed and the paper size to be used for Z-folding is 11" x 17", A3, B4, or 8K, the punch function can be used together. In addition, when the finisher (large capacity) or saddle stitch finisher (large capacity) is installed, and when the paper size to be used for Z-folding is 11" x 17", A3, B4, or 8K, the staple function and punch function can be used together.
- The folding function cannot be combined with the staple function or punch function.
- You can check the selected folding method in "[PREVIEW SCREEN \(page 2-11\)](#)".

Types of folds and paper sizes available

Folding types	Usable paper	Print Side	Fold Orientation	Folding image
Saddle Fold	Saddle stitch finisher: 12" x 18", 11" x 17", 8-1/2" x 14", 8-1/2" x 11"R, A3W, A3, B4, A4R, 8-1/2" x 13-1/2", 8-1/2" x 13-2/5", 8-1/2" x 13", 8K, 16KR Saddle stitch finisher (large stacker): 12" x 18", 11" x 17", 8-1/2" x 14", 8-1/2" x 13-1/2", 8-1/2" x 13-2/5", 8-1/2" x 13",	Inside	-	
		Outside	-	



Folding types	Usable paper	Print Side	Fold Orientation	Folding image
Half Fold	8-1/2" × 11"R, A4R	Inside	-	
		Outside	-	
C-Fold	8-1/2" × 11"R, A4R	Inside	Open Right	
			Open Left	
		Outside	Open Right	
			Open Left	



Folding types	Usable paper	Print Side	Fold Orientation	Folding image
Accordion Fold	8-1/2" × 11"R, A4R	-	Open Right	
		-	Open Left	
Double Fold	8-1/2" × 11"R, A4R	Inside	Open Right	
			Open Left	
		Outside	Open Right	
			Open Left	



Folding types	Usable paper	Print Side	Fold Orientation	Folding image
Z-Fold	11" × 17", 8-1/2" × 14", 8-1/2" × 11"R, A3, B4, A4R	-	Open Right	
		-	Open Left	

*1 Cannot be used when a finisher (large capacity) or saddle stitch finisher (large capacity) is installed.

*2 Cannot be used when a finisher or saddle finisher is installed.

1

Tap the [Detail] key to change to normal mode.

[EASY MODE \(page 3-3\)](#)



Tap the [Original] key and specify the orientation of the original to have the orientation be correctly recognized.

[SPECIFYING THE ORIENTATION OF THE ORIGINAL \(page 3-26\)](#)

2

Tap the [Output] key.

3

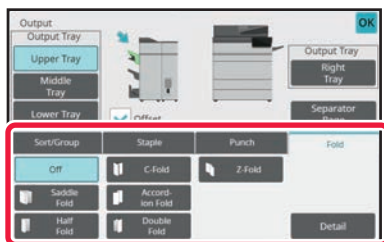

Tap the [Fold] tab, and tap the folding type key.



To cancel the paper folding function:

Tap the [Off] key.



4



Tap the [Detail] key.

For the setting method, see "[Detail Type for each Folding Type \(page 3-49\)](#)".

After the settings are completed, tap the [OK] key.

Detail Type for each Folding Type

Saddle Fold

Specify "Print Side" and "Multiple Fold".



The Multiple Fold function folds five sheets at a time. For example, if an original has 12 A4 size plain sheets, they are folded three times in total: 5 sheets + 5 sheets + 2 sheets. However, some types of paper reduces the number of sheets that are folded every set. For example, heavy paper is folded on a three-sheet basis.

Half Fold

Specify "Print Side".

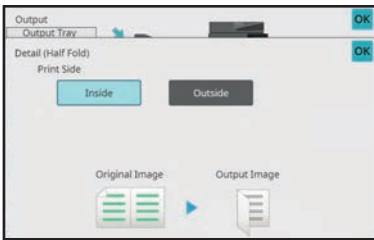

C-Fold

Specify "Print Side" and "Fold Orientation".

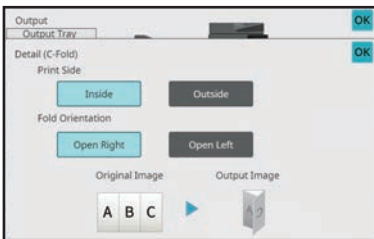



Accordion Fold

Specify "Fold Orientation".

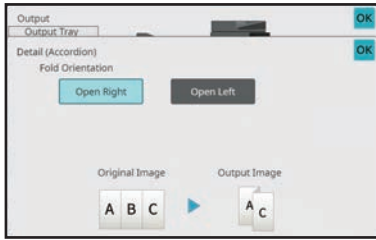

Double Fold

Specify "Print Side" and "Fold Orientation".



Z-Fold

Specify the paper size and "Fold Orientation" for Z-folding.





INSERTING SEPARATOR PAGES BETWEEN COPIES OR JOBS

This function inserts separator pages between each set of copies or between each job.

When you insert separator pages between sets of copies, you can specify whether to insert the separator page before or after each set. You can also specify the number of copies that makes one set.

When you insert separator pages between jobs, you can specify whether to insert a separator page before or after each job.

Separator page insertion examples

In the following examples, four copies of a two-page original are output.

Inserting a separator page before each set of two copies

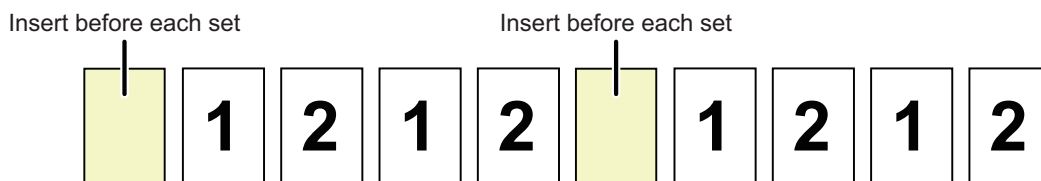

Inserting a separator page after each set of two copies

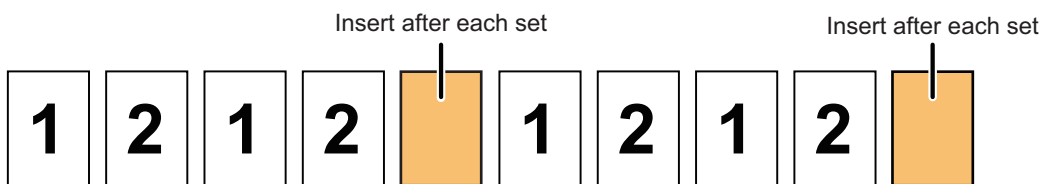

Inserting separator pages before and after a job

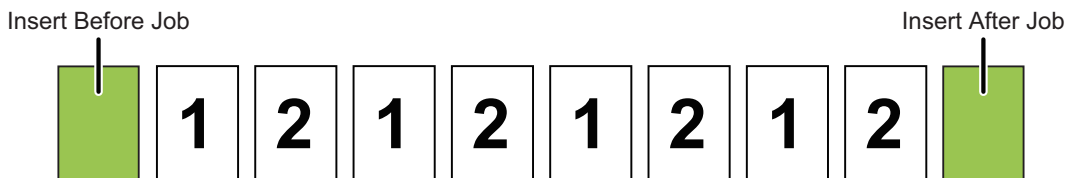

- When this function is combined with Sort/Group and Staple/Punch, Z-fold and half fold are not applied to the separator pages.
- This function cannot be used with the saddle stitch or fold function.
- This function cannot be used in combination with staple/punch and insertion of divider for each job.
- When used in combination with the offset function, a separator page is never offset by itself; the separator page is always offset together with the set of output.

1

Tap the [Detail] key to change to normal mode.

[EASY MODE \(page 3-3\)](#)



Tap the [Original] key and specify the orientation of the original to have the orientation be correctly recognized.

[SPECIFYING THE ORIENTATION OF THE ORIGINAL \(page 3-26\)](#)

2

Tap the [Output] key.



3

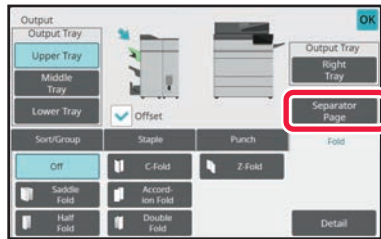

Tap the [Separator Page] key.

4

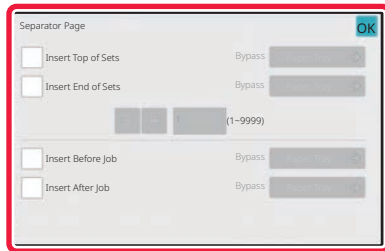

Specify the separator page insertion mode.

- To insert separator pages between sets of copies, set the [Insert Top of Sets] or [Insert End of Sets] checkbox to . Next, tap to specify the number of copies in each set.
- To insert separator pages between jobs, set the [Insert Before Job] or [Insert After Job] checkbox to .
- After the settings are completed, tap [OK] key.



To change the separator page tray:

Tap the [Paper Tray] key to display the tray selection screen. Tap the separator page tray in the tray selection screen. For more information, see "[SELECTING THE PAPER TRAY FOR COPYING \(page 3-13\)](#)" and "[SPECIFYING A TYPE AND SIZE OF PAPER LOADED ON BYPASS TRAY \(page 3-32\)](#)".



To cancel the separator page insertion setting:

Clear the checkmark for separator page insertion mode.



BATCH COPY FUNCTIONS

COPYING MULTIPLE ORIGINALS AS A SINGLE PAGE (N-Up)

This function copies multiple original pages onto a single sheet of paper in a uniform layout.

Select 2-Up to copy two original pages onto one sheet, 4-Up to copy four original pages onto one sheet, or 8-Up to copy eight original pages onto one sheet.

This function is convenient when you wish to present multiple pages in a compact format, or show a view of all pages in a document.

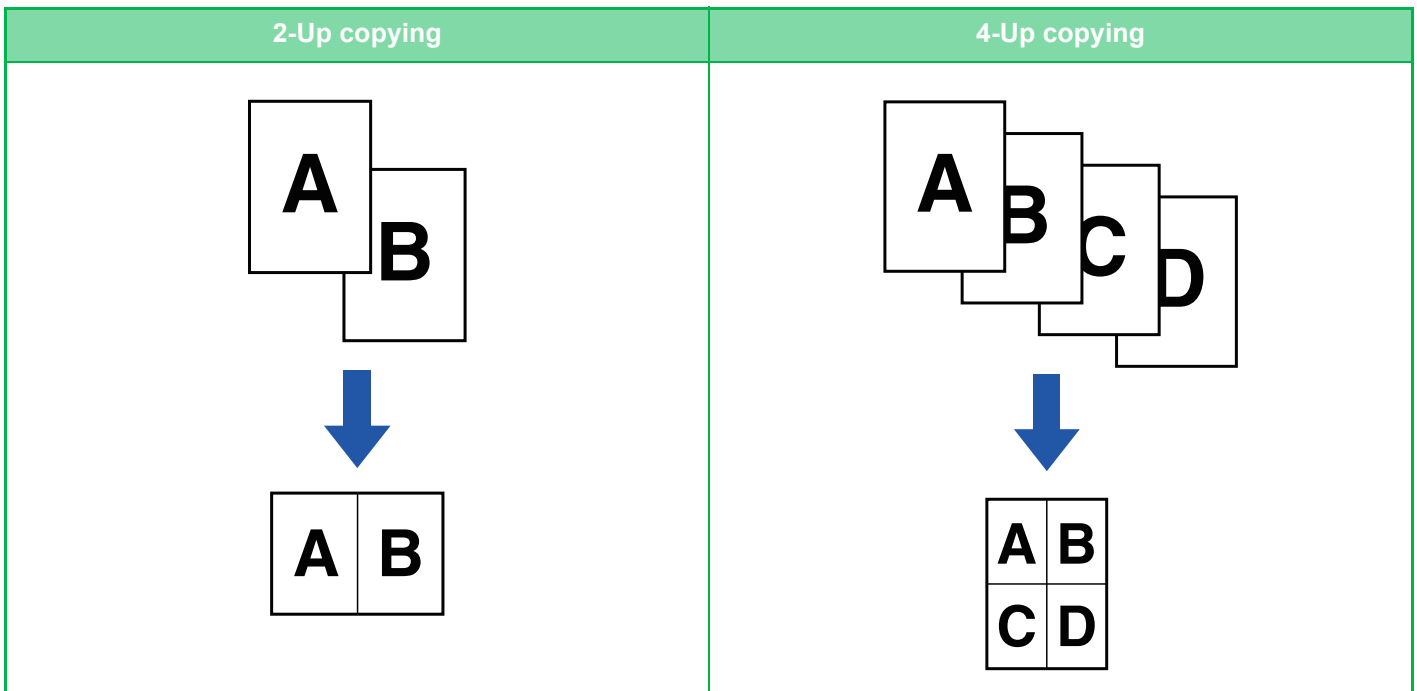

When inserting a cover sheet, select Cover Setting to copy only a front sheet to one page and collectively copy the second and subsequent pages.

1

Place the original.

Place the original in the document feeder tray of the automatic document feeder, or on the document glass.

[AUTOMATIC DOCUMENT FEEDER \(page 1-34\)](#)

[DOCUMENT GLASS \(page 1-38\)](#)



- When using the document glass to scan multiple original pages, change the original and tap the [Start] key.
- In Normal mode, go to step 4.



2

Tap the [N-Up] key.

[COPY MODE \(page 3-3\)](#)



Tap the [Original] key and specify the orientation of the original to have the orientation be correctly recognized.
[SPECIFYING THE ORIENTATION OF THE ORIGINAL \(page 3-26\)](#)

3

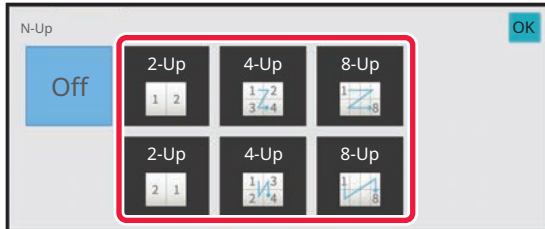

Tap the number of originals you want to copy collectively, and select the layout key.

If needed, the images will be rotated.
If you have finished selecting settings, go to step 7.

4

To select more detailed settings, tap the [Detail] key to switch to normal mode.

[EASY MODE \(page 3-3\)](#)

5

Tap the [N-Up] key.

6

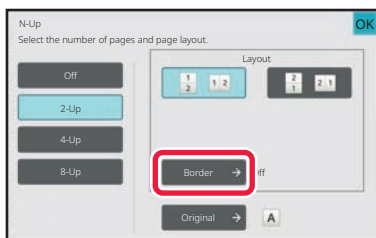

Tap [Border], and select the border.

A line can be inserted between pages arranged on a sheet.
After the settings are completed, tap [OK] key.



- **To cancel the N-Up setting:**
Tap the [Off] key.
- **To cancel all settings:**
Tap the [CA] key.

7

Tap the [Start] key to start copying.



COPYING EACH FACING PAGE OF A BOUND DOCUMENT (DUAL PAGE COPY)

This function copies the left and right half of an original successively. This function is useful when making copies of the facing pages of a book or other bound document.

Copying the facing pages of a book or bound document

Books and bound documents are copied into 2 separate pages.

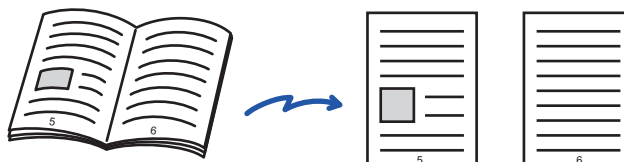

- Specify dual page copy before scanning the original.
- To erase shadows caused by the binding of a book or other bound document, use the erase function. This function cannot be used in combination with Center Erase.
- This function cannot be used in combination with 2-sided Original and Image Orientation: Horizontal.



To use Dual Page Copy in Easy mode

In "Settings (administrator)", select [System Settings] → [Common Settings] → [Operation Settings] → [Easy Mode Settings] → [Easy Copy].

1

Tap the [Detail] key to change to normal mode.

[EASY MODE \(page 3-3\)](#)

2

Tap the [Others] key, and tap the [Dual Page Copy] key.

A checkmark appears on the icon.

After the settings are completed, tap the [OK] key.



- When dual page copy is selected, 8-1/2" x 11" (A4) size paper is automatically selected.
- If you want to use paper in another tray, tap the [Paper Select] key and select the tray containing the desired paper from the paper tray selection screen that appears.
[SELECTING THE PAPER TRAY FOR COPYING \(page 3-13\)](#)



To cancel the dual page copy setting:

Tap the [Dual Page Copy] key to uncheck it.



3

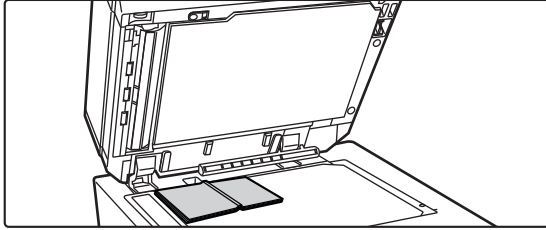

Place the original on the document glass.

[DOCUMENT GLASS \(page 1-38\)](#)

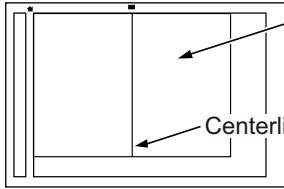

The page on this side is copied first.

Centerline of original



To cancel all settings:
Tap the [CA] key.

4

Tap the [Start] key to start copying.



COPYING BOTH SIDES OF A CARD AS A SINGLE PAGE (CARD SHOT)

This function copies the front and reverse sides of a card on one sheet, not on separate sheets. This function is convenient for making copies for identification purposes and helps save paper. For example, both sides of a card can be copied to a single sheet in A4 portrait or landscape.

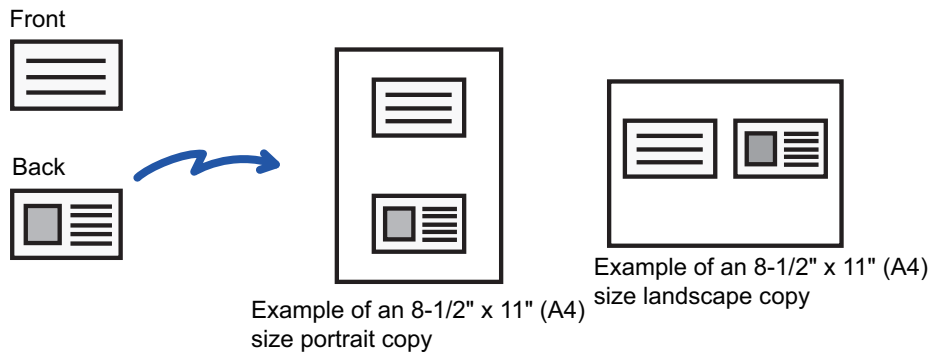

1

Select the paper to be used for card shot.

Set a paper by referring to the "[SELECTING THE PAPER TRAY FOR COPYING \(page 3-13\)](#)".

2

Tap the [Detail] key to change to normal mode.

[EASY MODE \(page 3-3\)](#)

3

Tap the [Others] key, and tap the [Card Shot] key.

4

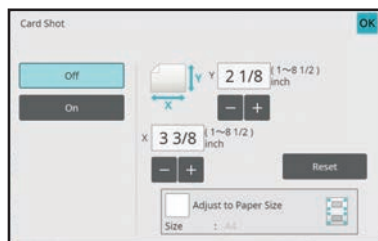

Tap the [On] key, and specify the original size as required.

After the settings are completed, tap [OK] and [Back] keys in sequence.



- Tap the areas displaying width and height sizes respectively, and enter the sizes using the numeric keys.
- If the image is missing, enter a slightly larger size.
- To quickly set the size, first specify a value close to the desired ratio value by the numeric keys, then adjust it by tapping **-** **+**.
- When you set the [Adjust to Paper Size] checkbox to , the original is enlarged or reduced with the ratio appropriate to the original size.



To cancel the Card Shot settings:
Tap the [Off] key.

5

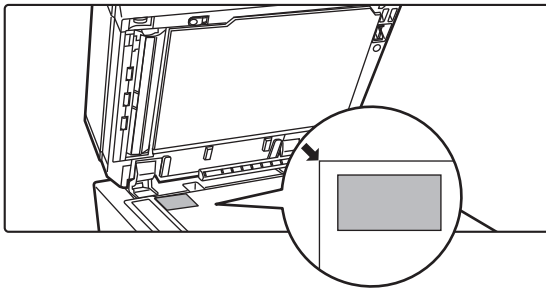

Place a card face down on the document glass, and tap the [Start] key.

[DOCUMENT GLASS \(page 1-38\)](#)



If the image is missing, shift the original inward and set it.

6

Place a card face up on the document glass, and tap the [Start] key to scan the reverse side.



- Copy settings cannot be changed when scanning additional pages.
- **To cancel all settings:**
Tap the [CA] key.

7

Tap the [Read-End] key to start copying.



REPEATING THE SAME IMAGE ON ONE SHEET (REPEAT LAYOUT)

This function copies multiple same original images on one sheet.
You can set any of the following three types of repeat copy.

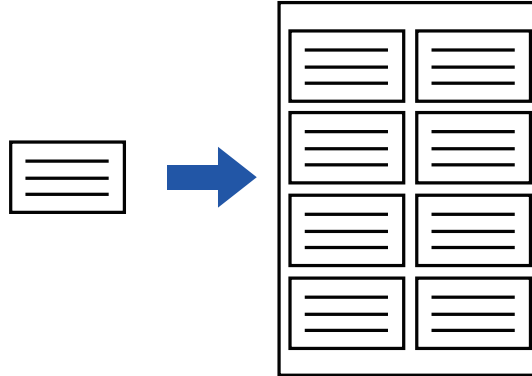

Repeat method	Description
Auto Repeat	The maximum repeat count to copy images on a sheet is calculated automatically according to the original size, paper size, and copy ratio being selected from the base screen.
Fixed Repeat	When you select a repeat count, original size, and paper size to copy images on a sheet, the copy ratio is calculated automatically and the original is copied.
Photo Repeat	This function repeatedly copies on 8-1/2" x 11" (A4) or 11" x 17" (A3) papers without changing the copy ratio of the photo size original. You can select any of the following five types of original size: <ul style="list-style-type: none"> • E/L Size, Postcard (Up to 3" x 5" (148 mm x 105 mm)) • Up to 5" x 7" (100 mm x 150 mm) • Card (Up to 2-1/2" x 4" (70 mm x 100 mm)) • ID Photo (Up to 2-1/2" x 2-1/2" (65 mm x 70 mm)) • Card (Up to 2-1/8" x 2-5/8" (57 mm x 100 mm)) * Reduction will be 95%.



- Repeat Layout cannot be selected in easy mode.
- Repeat Layout must be specified before scanning the original.
- If the copy ratio automatically obtained in [Fixed Repeat] exceeds 25 to 400% (using document glass) or 25 to 200% (using automatic document feeder), it will result in an error. Select the number of faces to repeat again.
- Always place an original on the document glass for photo repeating.
- Repeat Layout can be combined with Staple / Punch or Saddle Stitch.



- This function cannot be combined with Mixed Size Original or 2-Sided Copy.
- Photo Repeat cannot be combined with Image Orientation.



Copy by automatically calculating the repeat count (Auto Repeat)

1

Place the original.

Place the original in the document feeder tray of the automatic document feeder, or on the document glass.

[AUTOMATIC DOCUMENT FEEDER \(page 1-34\)](#)

[DOCUMENT GLASS \(page 1-38\)](#)

2

Tap the [Detail] key to change to normal mode.

[EASY MODE \(page 3-3\)](#)

3

Tap the [Others] key, and then tap the [Repeat Layout] key.

4

Tap the [Auto Repeat] key.

5

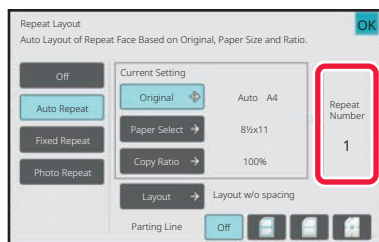

Check the repeat faces which have been calculated automatically.

Change the original size, paper size, or copy ratio by tapping the respective [Original], [Paper Select], or [Copy Ratio] key when necessary.

[SELECTING THE ORIENTATION AND SIZE OF THE ORIGINAL \(page 3-26\)](#)

[MANUAL RATIO SELECTION \(page 3-20\)](#)

[SELECTING THE PAPER TRAY FOR COPYING \(page 3-13\)](#)



Set so that there are one or more repeat faces.

6

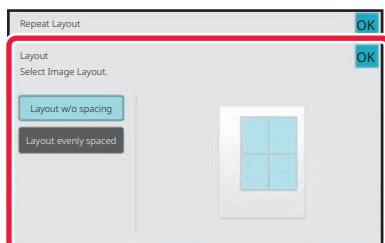

Tap the [Layout] key.

Tap the [Layout w/o spacing] key or the [Layout evenly spaced] key, and then tap the [OK] key.



7

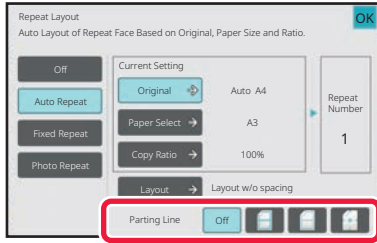

Specify the repeat partition line.

After the settings are completed, tap [OK] key.



- **To cancel the Auto Repeat setting:**
Tap the [Off] key.
- **To cancel all settings:**
Tap the [CA] key.

8

Tap the [Start] key to start copying.

Copy by specifying a repeat count (Fixed Repeat)

1

Perform steps 1 to 3 in [Copy by automatically calculating the repeat count \(Auto Repeat\) \(page 3-60\)](#).

2

Tap the [Fixed Repeat] key.

3

Tap the [Original] and [Paper Select] keys to select an original size and a paper size, respectively.

[SELECTING THE ORIENTATION AND SIZE OF THE ORIGINAL \(page 3-26\)](#)
[SELECTING THE PAPER TRAY FOR COPYING \(page 3-13\)](#)

4

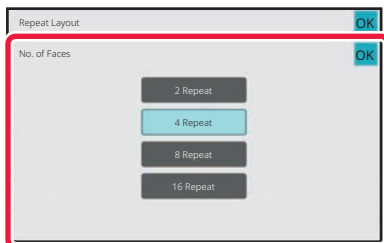

Tap [No. of Faces] to set a repeat count.

After the settings are completed, tap [OK] key.
The automatic calculation result is shown as the copy ratio.



If the calculated copy ratio exceeds the range from 25% to 400% (using document glass) or 25 to 200% (using automatic document feeder), an error occurs.



5

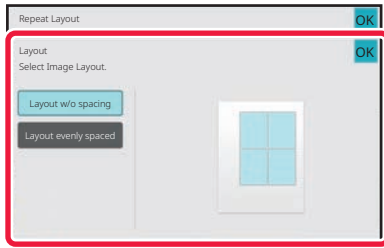

Tap the [Layout] key.

Tap the [Layout w/o spacing] key or the [Layout evenly spaced] key, and then tap the [OK] key.

6

Specify the repeat partition line.

After the settings are completed, tap [OK] key.



• **To cancel the fixed repeat setting:**

Tap the [Off] key.

• **To cancel all settings:**

Tap the [CA] key.

7

Tap the [Start] key to start copying.



Repeat a photo size original in actual size (Photo Repeat)

1

Perform steps 1 to 3 in [Copy by automatically calculating the repeat count \(Auto Repeat\) \(page 3-60\)](#).

2

Tap the [Photo Repeat] key.

3

Place the original on the document glass.

4

Tap the [Original] key and select an original size.

When you tap the original size key, the original direction is indicated in the "How To Set". Place the original to meet the displayed orientation.

After the settings are completed, tap [OK] key.

5

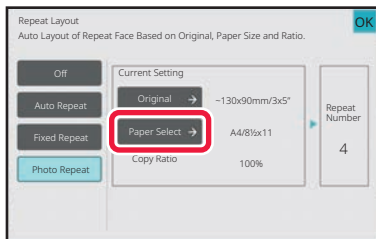

Tap the [Paper Select] key and select a paper size.

After the settings are completed, tap [OK] and [Back] keys in sequence.

The automatic calculation result is shown as the copy ratio.



When you tap the [*Up to 57x100mm(Card) *~ 2 1/8 x 2 5/8"] key on the [Original] screen, you can select the A4 paper size only.



- **To cancel the photo repeat setting:**
Tap the [Off] key.
- **To cancel all settings:**
Tap the [CA] key.

6

Tap the [Start] key to start copying.



COPYING MULTIPLE BUSINESS CARDS (BUSINESS CARD COPY)

Business Card Copy can be used to copy up to 8 business cards on one sheet of paper.

This function can be used when you want to create the list of business cards, and when you want to file business cards.

1-Sheet Layout, 2-Sheet Layout, 8-Sheet Layout

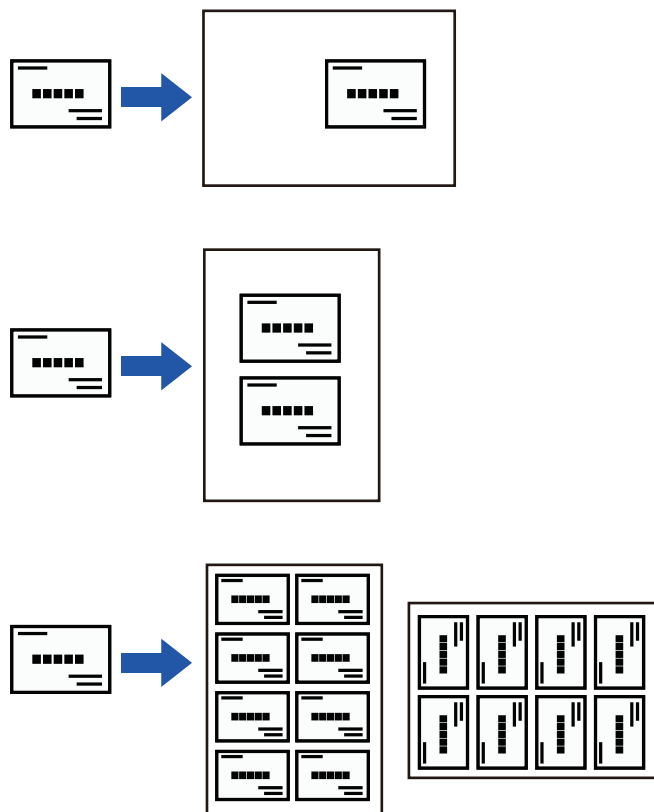

Business Card Copy cannot be selected in easy mode.

1

Tap the [Detail] key to change to normal mode.

[EASY MODE \(page 3-3\)](#)

2

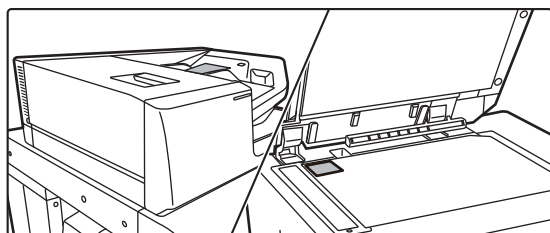

Place a business card, and select the paper to be used to copy the card.

Refer to "[SELECTING THE PAPER TRAY FOR COPYING \(page 3-13\)](#)" to select the paper.



3

Tap the [Others] key, and then tap the [Business Card Copy] key.

4

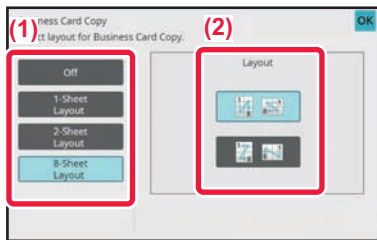

Specify settings for Business Card Copy.

(1) Specify the number of business cards to be copied and touch the [1-Sheet Layout] key or the [2-Sheet Layout] or the [8-Sheet Layout] key.

(2) When [8-Sheet Layout] is selected, select the desired layout from "Layout".

After the settings are completed, tap [OK] and [Back] keys in sequence.



- **To cancel the business card copy setting:**

Tap the [Off] key.

- **To cancel all settings:**

Tap the [CA] key.

5

Tap the [Start] key to start copying.



The zoom is fixed at 100%.



Copy results of 8-Sheet Layouts

Originals (Original orientation)		Settings	Results								
1st A 5th E 2nd B 6th F 3rd C 7th G 4th D 8th H			<table border="1"> <tr><td>A</td><td>E</td></tr> <tr><td>B</td><td>F</td></tr> <tr><td>C</td><td>G</td></tr> <tr><td>D</td><td>H</td></tr> </table>	A	E	B	F	C	G	D	H
A	E										
B	F										
C	G										
D	H										
			<table border="1"> <tr><td>A</td><td>B</td></tr> <tr><td>C</td><td>D</td></tr> <tr><td>E</td><td>F</td></tr> <tr><td>G</td><td>H</td></tr> </table>	A	B	C	D	E	F	G	H
A	B										
C	D										
E	F										
G	H										
1st A 2nd B 3rd C 4th D 5th E 6th F 7th G 8th H			<table border="1"> <tr><td>D</td><td>C</td><td>B</td><td>A</td></tr> <tr><td>H</td><td>G</td><td>F</td><td>E</td></tr> </table>	D	C	B	A	H	G	F	E
D	C	B	A								
H	G	F	E								
			<table border="1"> <tr><td>G</td><td>E</td><td>C</td><td>A</td></tr> <tr><td>H</td><td>F</td><td>D</td><td>B</td></tr> </table>	G	E	C	A	H	F	D	B
G	E	C	A								
H	F	D	B								



OTHER FUNCTIONS

OUTPUT AND LAYOUT EDITING FUNCTIONS

MAKING COPIES IN PAMPHLET FORMAT (BOOKLET)

Copies made by "Booklet" can be folded at the center to create a booklet.
This function is convenient for arranging copies into an attractive booklet or pamphlet.

Booklet copy using 8 original pages

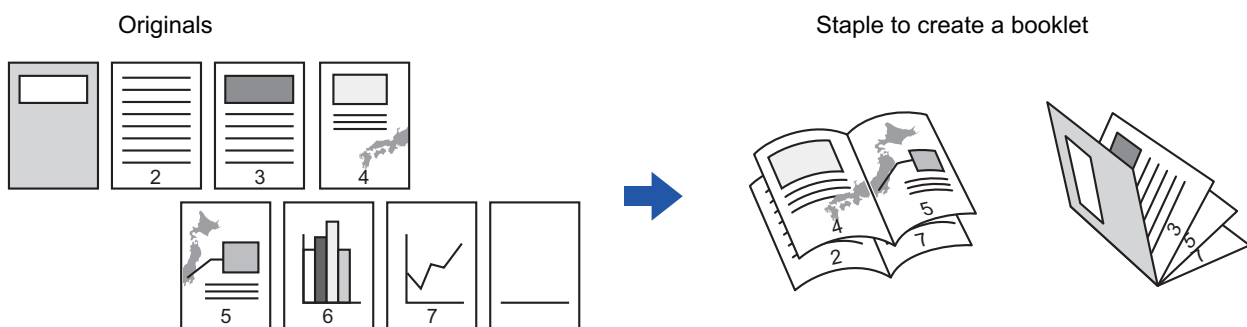

Binding side

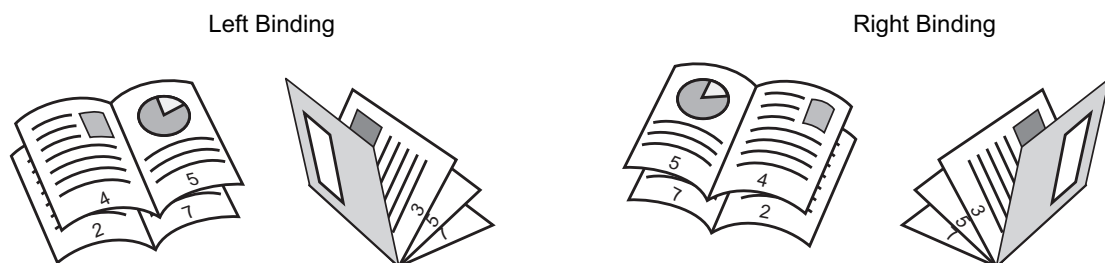

- Booklet cannot be selected in easy mode.
- To make Booklet copies of a book or other bound original, use the book copy function.
[COPYING A PAMPHLET \(BOOK COPY\) \(page 3-73\)](#)
- When Booklet is selected, 2-sided copying mode is automatically selected. When settings are selected that prevent 2-sided copying, the booklet function cannot be used.
- Scan the originals in order from the first page to the last page. The order of copying will be automatically adjusted by the machine. Four original pages will be copied onto each sheet of paper. Blank pages will be automatically produced at the end of pamphlet copies if the number of original pages is not a multiple of four.
- When a saddle stitch finisher is installed, you can select [Output] and set the Saddle Stitch (Staple each set of copies at two positions in the center of paper).
[STAPLE SETTINGS \(page 3-37\)](#)



To staple copies automatically when Booklet is enabled:

From the "Settings (administrator)", select [System Settings] → [Common Settings] → [Device Control] → [Condition Settings] → [Automatic Saddle Stitch].

This is used to activate Saddle Stitch automatically when Booklet is enabled when a saddle stitch finisher is installed. To make pamphlet copies without stapling when the [Automatic Saddle Stitch] option is ON, tap the [Output] key. Then, select [Booklet] and tap the [Off] key on the saddle stitch screen.

1

Place the original.

Place the original in the document feeder tray of the automatic document feeder, or on the document glass.

[AUTOMATIC DOCUMENT FEEDER \(page 1-34\)](#)

[DOCUMENT GLASS \(page 1-38\)](#)



If the originals are 2-sided, place them in the document feeder tray.

2

Tap the [Others] key and then the [Booklet] key, or tap the [Output] key and then the [Saddle Stitch] key.

3

Select the binding edge.



To cancel the booklet setting:

Tap the [Off] key.

4

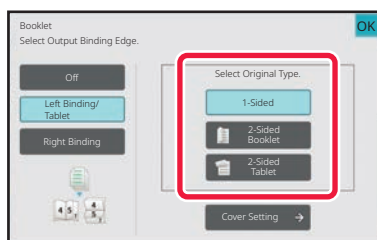

Tap the [1-Sided], [2-Sided Booklet] or [2-Sided Tablet] key as appropriate for the original.

When not inserting a cover, go to step 6.



5

When inserting a cover, tap the [Cover Setting] key, and tap the [On] key.

After the settings are completed, tap the [OK] and [Back] keys in sequence.



To change the cover input tray:

- Tap the [Paper Tray] key to display the tray selection screen.
- Tap the cover input tray on the tray selection screen.
- For more information, see "[SELECTING THE PAPER TRAY FOR COPYING \(page 3-13\)](#)".



- If the cover will be copied on, label sheets, transparency film, and tab paper cannot be used.

To cancel all settings:

Tap the [CA] key.

6

Tap the [Start] key to start copying.



COPYING MULTIPLE ORIGINALS ON EACH BOOKLET PAGE (BOOKLET 2-Up/4-Up)

This function copies two or four original pages equally on one page of pamphlet copy paper.

This function is convenient for arranging minimum number of copies into an attractive booklet or pamphlet format.

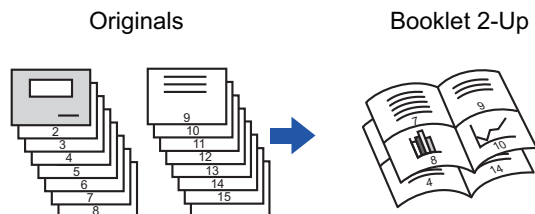

- Booklet 2-Up/4-Up cannot be selected in easy mode.

- The following paper sizes and number of sheets are available for booklet 2-Up or 4-Up.

Paper size: 12"x 18", 11"x 17", 8-1/2"x 14", 8-1/2"x 11"R, A3W, A3, B4, A4R, B5R

Number of stapled sheets: Max. 15 sheets

- Scan the originals in order from the first page to the last page. The order of copying will be automatically adjusted by the machine.

Eight or 16 original pages will be copied onto each sheet of paper. Blank pages will be automatically produced at the end if the number of original pages is not a multiple of eight or 16.

1

Place the original.

Place the original in the document feeder tray of the automatic document feeder, or on the document glass.

[AUTOMATIC DOCUMENT FEEDER \(page 1-34\)](#)

[DOCUMENT GLASS \(page 1-38\)](#)



If the originals are 2-sided, place them in the document feeder tray.

2

Tap the [Output] key, and tap the [Saddle Stitch] key.

3

Select the binding edge.



To cancel the booklet setting:

Tap the [Off] key.



4

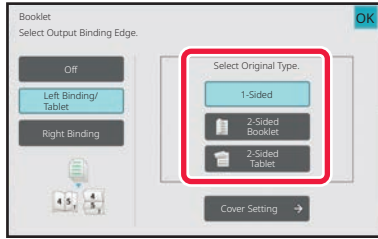

Tap the [1-Sided], [2-Sided Booklet] or [2-Sided Tablet] key as appropriate for the original.

When not inserting a cover, go to step 6.

5

When inserting a cover, tap the [Cover Setting] key, and tap the [On] key.



To change the cover input tray:

Tap the [Paper Tray] key to display the tray selection screen.
Tap the cover input tray on the tray selection screen.

For more information, see "[SELECTING THE PAPER TRAY FOR COPYING \(page 3-13\)](#)".

- To make a copy on a cover sheet, check the [Make Copy on Cover (Duplex)] box so that appears.



• If the cover will be copied on, label sheets, transparency film, and tab paper cannot be used.

To cancel all settings:

Tap the [CA] key.

6

Tap [N-Up] on the action panel.

7

Tap the key of the N-Up sheets you wish to use.

If needed, the images will be rotated.



To cancel the N-Up setting

Tap the [Off] key.

8

Select the layout.



9

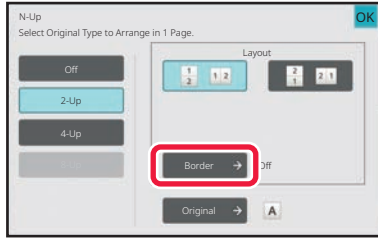

Tap [Border], and select the border.

A line can be inserted between pages arranged on a sheet. After the settings are completed, tap [OK] key twice, and [Back] keys in sequence.



To cancel all settings:
Tap the [CA] key.

10

Tap the [Start] key to start copying.



COPYING A PAMPHLET (BOOK COPY)

This function makes a copy of the two facing pages of an open book or other bound document.

Copies made with this function can be folded at the center to create a booklet.

This function is convenient for arranging copies into an attractive booklet or pamphlet.

Book copy flow (when the original has 4 pages)

Scan the original in the order of "cover and back cover" → "inside of cover and 1st page" → "2nd and 3rd page" → "4th page and inside of back cover" to copy.

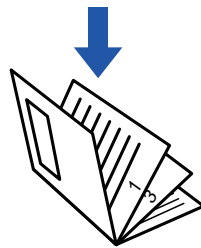
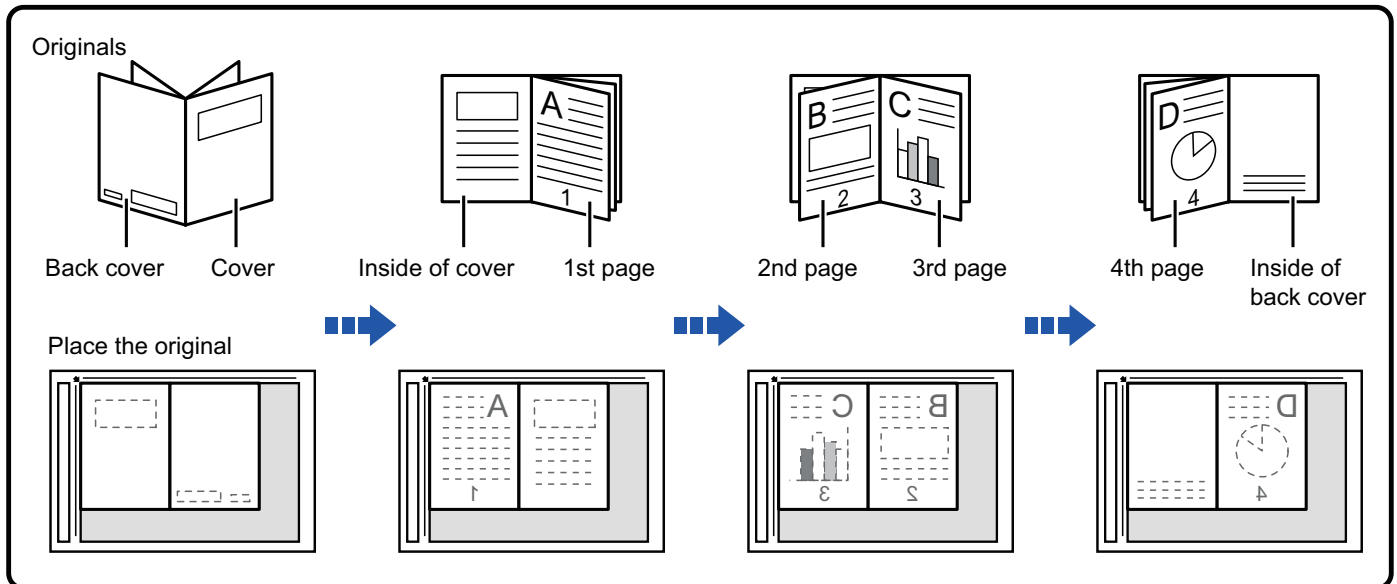

- Book Copy cannot be selected in easy mode.
- Book Copy must be specified before scanning the original.
- Four original pages will be copied onto each sheet of paper. Blank pages will be automatically added at the end if the total number of original pages is not a multiple of four.
- This function can be combined with saddle stitch or fold if a saddle stitch finisher is installed.
- When the book copy function is selected, 2-sided copying mode is automatically selected. When settings are selected that prevent 2-sided copying, the book copy function cannot be used.

1

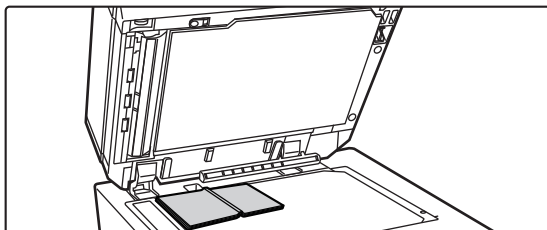

Place the original on the document glass.

Place the opened pages of the "front and last sheets".
[DOCUMENT GLASS \(page 1-38\)](#)



2

Tap the [Others] key, and tap the [Book Copy] key.

3

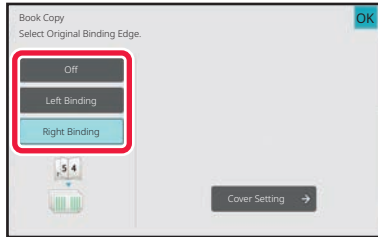

Select a binding position.

When not inserting a cover, tap the [OK] and [Back] keys in sequence. Then, go to step 5.



To cancel the book copy setting:
Tap the [Off] key.

4

When inserting a cover, tap the [Cover Setting] key, and tap the [On] key.

To make a copy on the inserted cover sheet, check the [Make Copy on Cover (Duplex)] box so that appears. After the settings are completed, tap the [OK] and [Back] keys in sequence.



To change the cover input tray:

Tap the [Paper Tray] key to display the tray selection screen. Tap the cover input tray on the tray selection screen. For more information, see "[SELECTING THE PAPER TRAY FOR COPYING \(page 3-13\)](#)".



- If the cover will be copied on, label sheets, transparency film, and tab paper cannot be used.
- This setting is not available when the covers/inserts function is disabled in the setting mode.

5

Tap the [Start] key to scan the first original page.

Scanning of the original starts.

6

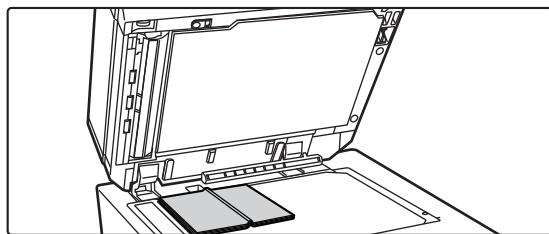

Place the next opened original pages, and tap the [Start] key.

Tap the same key you tapped in step 5.
 Repeat this step until all original pages have been scanned.
 Scan the remaining original pages in the following order:
 Inside of the front cover and the 1st page (facing pages)
 The 2nd and 3rd pages (facing pages)
 ⋮
 The last page and inside of back cover (facing pages)



- Copy settings cannot be changed when scanning additional pages.
- **To cancel all settings:**
Tap the [CA] key.



7

Tap the [Read-End] key to start copying.



SPLITTING A PAMPHLET ORIGINAL BY PAGE (BOOK DIVIDE)

This function splits a saddle-stitch original such as a catalogue or a pamphlet page by page, and copies in sequence.

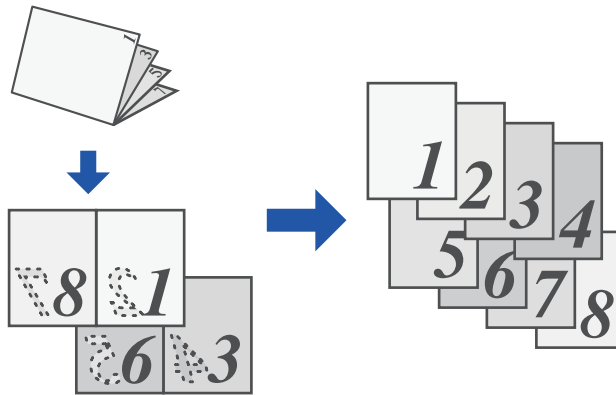

- Book Divide cannot be selected in easy mode.
- Book Divide must be specified before scanning the original.
- This function supports three original binding edges: left binding, right binding, and top open.
- The scanned original is split in the center.

1

Tap the [Others] key, and tap the [Book Divide] key.

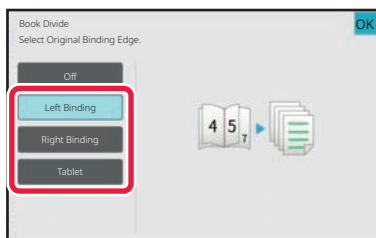
2

Select the binding edge of the pamphlet original.



Check the preview image displayed in the screen, and make sure that the binding edge is correct.



- **To cancel the Book Divide setting:**
Tap the [Off] key.
- **To cancel all settings:**
Tap the [CA] key.

3

Tap the [Start] key to start copying.



PAPER, AND TIME SAVING FUNCTIONS

SKIPPING BLANK PAGES IN AN ORIGINAL (BLANK PAGE SKIP)

If the scanned original contains blank pages, this function skips them to copy only non-blank pages. The machine detects blank pages, enabling you to skip useless copies without checking an original.

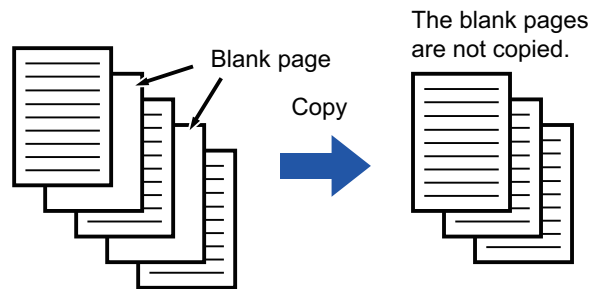

- If an original of which one side is blank is scanned, blank pages are skipped for 2-sided copying.
- Depending on the original, some pages that are not blank may be detected as blank pages and thus not being copied, and some pages that are blank may not be detected as blank and thus copied.



To use Blank Page Skip in Easy mode

In "Settings (administrator)", select [System Settings] → [Common Settings] → [Operation Settings] → [Easy Mode Settings] → [Easy Copy].

1

Place the original.

Place the original in the document feeder tray of the automatic document feeder, or on the document glass.

[AUTOMATIC DOCUMENT FEEDER \(page 1-34\)](#)

[DOCUMENT GLASS \(page 1-38\)](#)

2

Tap the [Others] key, and tap the [Blank Page Skip] key.



3

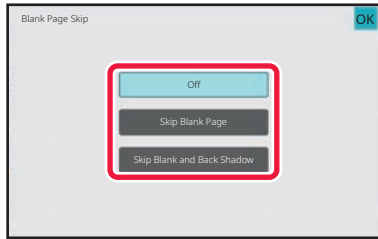

Tap the [Skip Blank Page] or [Skip Blank and Back Shadow] key.

After the settings are completed, tap [OK] and [Back] keys in sequence.



To cancel all settings:
Tap the [CA] key.

4

Tap the [Start] key.

5

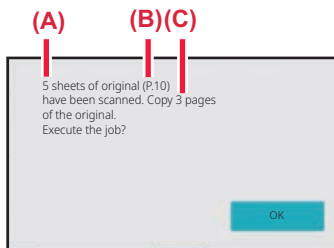

Check the confirmation message, and tap the [OK] key to start copying.

On the confirmation screen, the number of scanned original sheets appears in (A), the number of scanned sides in (B), and the number of copies excluding blank pages in (C).

For example, if five original sheets that include two blank pages are scanned by duplex scanning, the result is displayed as follows:

5 pages of original have been scanned. (P.10)

Copy 8 pages of originals.



ADJUSTING THE BACKGROUND BY MAKING LIGHT AREAS OF THE ORIGINAL DARKER OR LIGHTER (BACKGROUND ADJUSTMENT)

You can adjust the background by making light areas of the original darker or lighter.

Changing the level of [Background Adjustment] to the [+] side makes the background darker, while changing to the [-] side makes it lighter.

Darkness of the light area can be adjusted by this function.

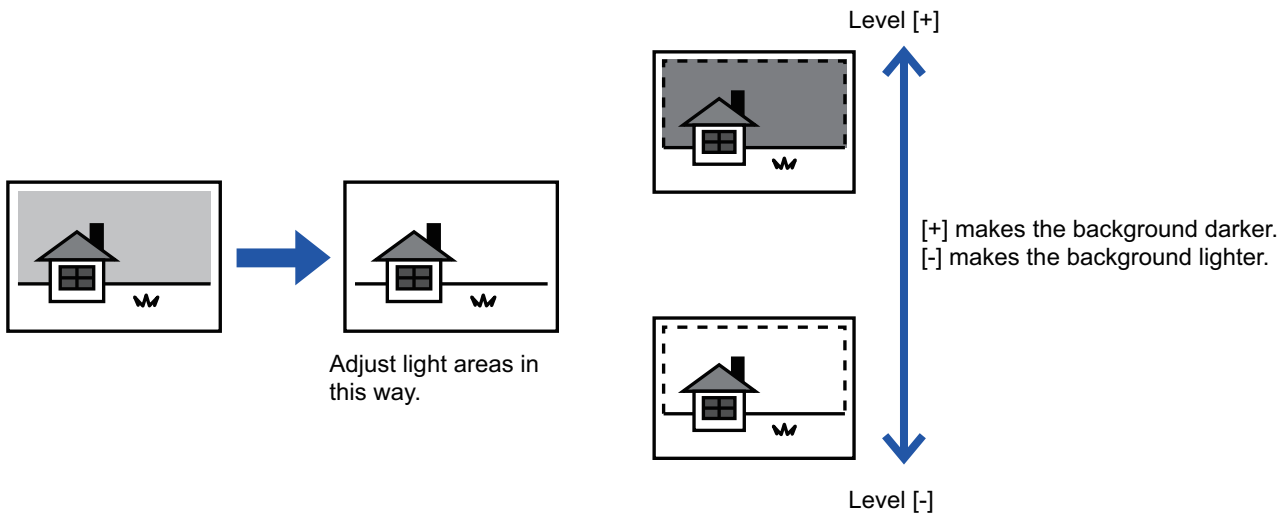

- Background Adjustment cannot be selected in easy mode.
- You must select Background Adjustment before scanning the original.

1

Tap the [Others] key, and tap the [Background Adjustment] key.

2

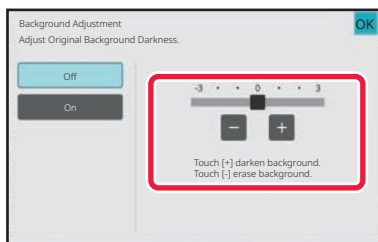

Tap **[-]** **+** or move the slider to set the value.

After the settings are completed, tap [OK] and [Back] keys in sequence.



To cancel the Background Adjustment setting:
Tap the [Off] key.



3

Place the original.

Place the original in the document feeder tray of the automatic document feeder, or on the document glass.

[AUTOMATIC DOCUMENT FEEDER \(page 1-34\)](#)

[DOCUMENT GLASS \(page 1-38\)](#)



To cancel all settings:

Tap the [CA] key.

4

Tap the [Start] key to start copying.



MAKING A PROOF COPY (PROOF COPY)

This function makes a proof copy before printing the specified number of copies. Check the preview image with a proof copy. If necessary, change the settings. Using this function stores the scanned original in the machine, saving you the trouble of re-scanning the original in the changed setting.

Proof copy flow

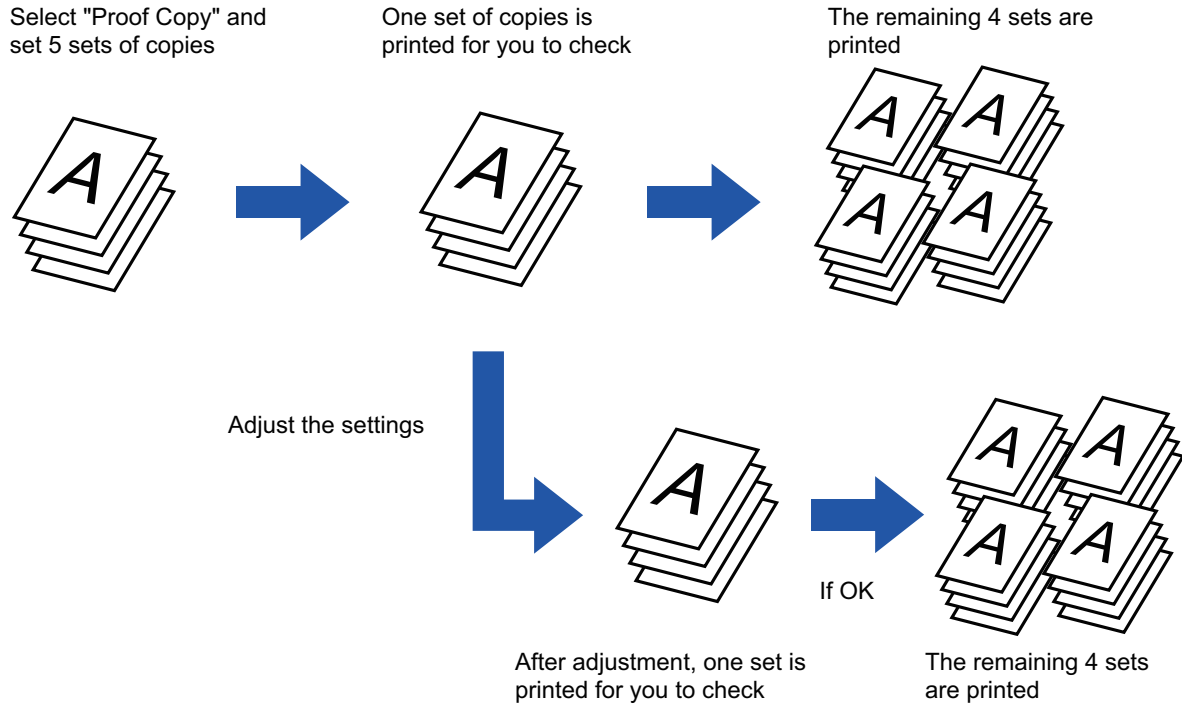

- Proof Copy cannot be selected in easy mode.
- Proof Copy must be specified before scanning the original.
- If Proof Copy is executed while the machine is printing another job, the job in progress is interrupted, and a proof copy is printed preferentially. The interrupted job will resume after proof copying has been completed. However, if proof copy is executed during printing of a job for which both 2-sided printing and staple function are enabled, the proof copy will be printed after the job in progress is finished. If the [Start Print] key is tapped to execute printing of the remaining sets while the machine is printing another job, the remaining sets will be printed after all previously reserved jobs are completed.

1

Place the original.

Place the original in the document feeder tray of the automatic document feeder, or on the document glass.

[AUTOMATIC DOCUMENT FEEDER \(page 1-34\)](#)

[DOCUMENT GLASS \(page 1-38\)](#)

2

As necessary, specify the required functions such as "Exposure" and "Copy Ratio".



To cancel all settings:

Tap the [CA] key.



3

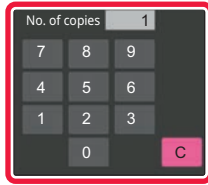

Set the number of copies (number of sets) using the numeric keys.



Up to 9999 copies (sets) can be set.



If an incorrect number of copies is set
Tap the [C] key, and enter the correct number.

4

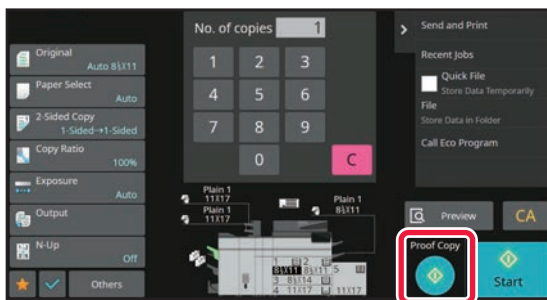

Tap the [Proof Copy] key.

Make only one set of copies.

5



Check the copy result. If no problem is found, tap the [Start Print] key.

As necessary, change the settings and repeat proof copying until you are satisfied with the copy result.



You can also change the number of copies. To change the number of copies, use the numeric keys.



- In Proof Copy, unavailable function keys are not displayed.
- Some available functions may be restricted.
- **To cancel all settings:**
Tap the [CA] key.



CHECKING THE NUMBER OF SCANNED ORIGINAL SHEETS (ORIGINAL COUNT)

This function counts the number of scanned original sheets, and displays the result before making a copy. By allowing you to check the number of original sheets that were scanned, this helps reduce the occurrence of copy mistakes.



- Original count cannot be selected in easy mode.
- The count result is displayed with the number of scanned original sheets, not the number of scanned original pages. For example, when 2-sided copying is performed using one original, the number "1" will appear to indicate that one original sheet was scanned, not "2" to indicate the front-side page and the reverse side page.
- Original Count must be specified before scanning the original.

1

Tap the [Others] key, and tap the [Original Count] key.

A checkmark appears on the icon.
After the settings are completed, tap the [Back] key.



To cancel the Original Count setting:
Tap the [Original Count] key to uncheck it.

2

Place the original in the document feeder tray of the automatic document feeder.

[AUTOMATIC DOCUMENT FEEDER \(page 1-34\)](#)

3

Tap the [Start] key.

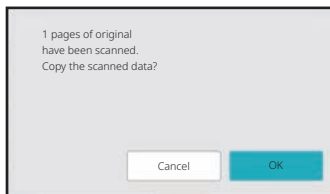
4

Check the number of original sheets.

The number that is displayed is the number of scanned original sheets, not the number of scanned original pages. For example, when 2-sided copying is performed using one original, the number "1" will appear to indicate that one original sheet was scanned, not "2" to indicate the front-side page and the reverse side page.



If the displayed number of original sheets is different from the actual number of sheets
Tap the [Cancel] key to stop the job.

5

Tap the [OK] key to start copying.



If this function is combined with [Job Build], the count result is displayed after the [Read-End] key has been tapped.



USING TWO MACHINES TO REDUCE THE COPY TIME (TANDEM COPY)

This function shares a copy job half-and-half between two machines connected to the network, enabling the reduction of the copy time.

Primary unit and secondary unit

The primary unit performs only scanning, and a secondary unit registered in the primary unit performs only printing without scanning the original.

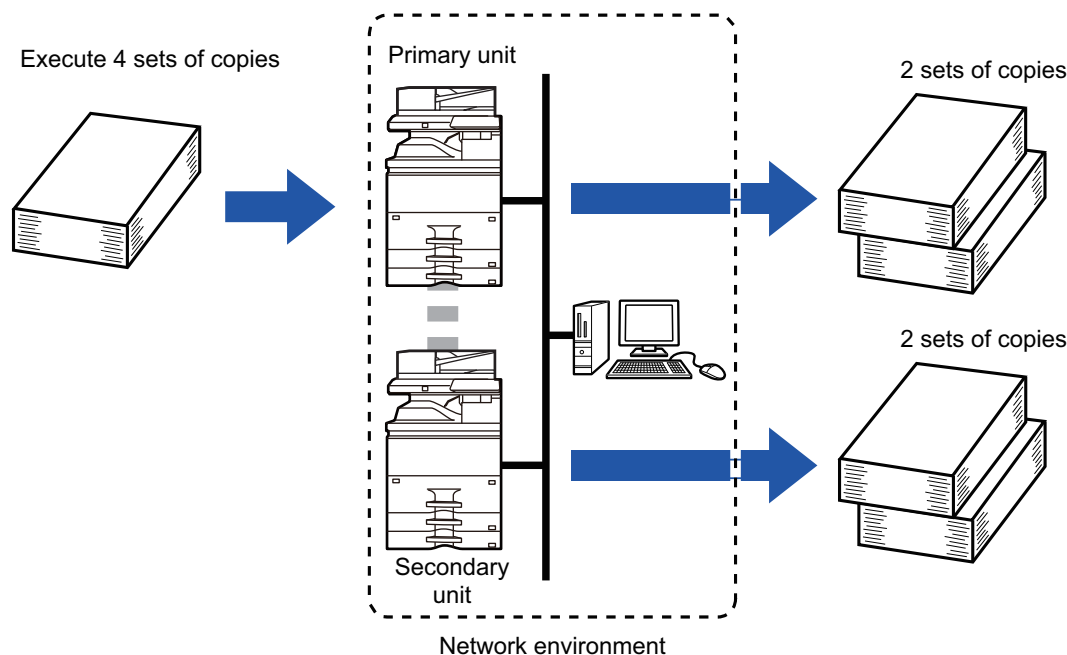

- Tandem Copy cannot be selected in easy mode.
- To use this function, two machines must be connected to your network.
- Even if more machines are connected to the network, this function can only be used to have one other machine share a job.
- To configure the tandem connection setting, register IP address information of the secondary unit in the primary unit. For the port number, it is best to use the initial setting (50001). Unless you experience difficulty with this setting, do not change the port number. The tandem setting should be configured by your network administrator. If the primary unit and secondary unit will switch roles, configure the IP address of the primary unit in the secondary unit. The same port number can be used for both machines.
- In this situation:
 - A saddle stitch finisher is installed in the primary unit while not installed in a secondary unit.
 - Tandem Copy is enabled when specifying copies without stapling.
 - Tandem Copy is disabled when specifying copies with stapling.
- As shown here, if Tandem Copy is enabled using a function provided in the primary unit and not provided in a secondary unit, a message will appear.
- If a machine runs out of paper
 - If either the primary unit or the secondary unit run out of paper, the machine that ran out of paper will hold the job while the machine that still has paper continues the job. When paper is added to the machine that ran out, the job resumes.
- If user authentication is specified
 - Tandem Copy is enabled when user authentication is specified in the primary unit.
 - Tandem Copy is disabled when user authentication is specified in the secondary unit while it is not specified in the primary unit.
- If an odd number of sets is being made, one more set is output to the primary unit.



1

Tap the [Others] key, and tap the [Tandem Copy] key.

A checkmark appears on the icon.
After the settings are completed, tap the [Back] key.



To cancel the Tandem Copy setting:
Tap the [Tandem Copy] key to uncheck it.

2

Place the original.

Place the original in the document feeder tray of the automatic document feeder, or on the document glass.
When using the document glass to scan multiple original pages, change the original and tap the [Start] key.
[AUTOMATIC DOCUMENT FEEDER \(page 1-34\)](#)
[DOCUMENT GLASS \(page 1-38\)](#)

3

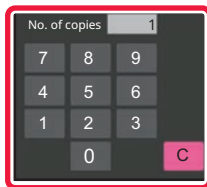

Tap the number of copies key to specify the number of copies.

Up to 9999 copies (sets) can be set. The specified number of copies are shared between the primary and secondary units. If the number of copies is odd, the primary unit makes more copies than the secondary unit.



- **If an incorrect number of copies is set:**
Tap the [C] key and then enter the correct number.
- **To cancel all settings:**
Tap the [CA] key.

4

Tap the [Start] key to start copying.



To cancel Tandem Copy:
Tap the [Cancel Copy] keys on both the primary and secondary units.



SECURITY REINFORCEMENT FUNCTIONS

PADDING UNAUTHORIZED COPY PREVENTION DATA (HIDDEN PATTERN PRINT)

Characters to prevent unauthorized copying such as pre-set or customized text are placed as invisible characters in a background pattern.

When an output sheet with a pattern print is copied, the hidden characters will appear.

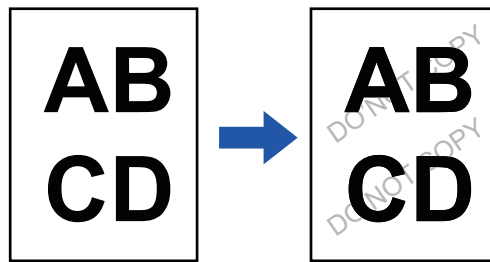

- Hidden Pattern Print cannot be selected in easy mode.
- "Hidden Pattern Print" is a function provided for the purpose of deterring unauthorized copying. It does not guarantee the prevention of information leakage.
- Text may not be completely hidden on an output sheet with a hidden pattern print under certain machine conditions. In such a case, adjust the contrast by selecting the [Hidden Pattern Print Setting] from the "Settings (administrator)".
- When copying an output sheet with a hidden pattern print, the hidden pattern may not emerge depending on settings other than "Hidden Pattern Print".
- The hidden pattern may not emerge on copies with certain types of devices or under certain setting conditions used to copy an output sheet with a hidden pattern print.

1

Place the original.

Place the original in the document feeder tray of the automatic document feeder, or on the document glass.

[AUTOMATIC DOCUMENT FEEDER \(page 1-34\)](#)

[DOCUMENT GLASS \(page 1-38\)](#)

2

Tap the [Others] key, and tap the [Hidden Pattern Print] key.



3

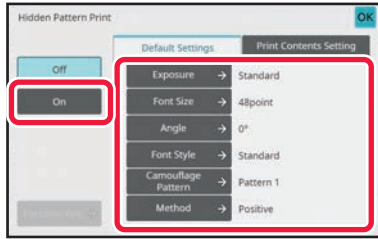

Tap the [On] key, and specify each item in the [Default Settings] tab as required.



We recommend you to select the [Positive] option for the "Method".

4

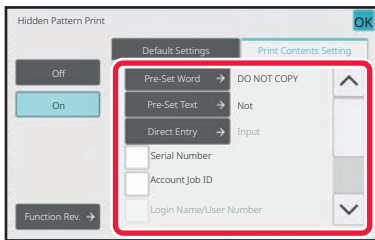

Specify each item in the [Print Contents Setting] tab as required.

To specify print settings, you can select the required one from pre-set text or use the soft keyboard. You can also print serial number and account job ID. After the settings are completed, tap [OK] and [Back] keys in sequence.



- Tapping the [Function Rev.] key displays the settings of the [Print Contents Setting] tab.
- The hidden pattern print preview may slightly differ from the actual pattern and exposure as the preview is used for simple pattern color checking.



- **To cancel the Hidden Pattern Print setting:**
Tap the [Off] key.
- **To cancel all settings:**
Tap the [CA] key.

5

Tap the [Start] key to start copying.



OUTPUT POSITION AND MARGIN ADJUSTMENT FUNCTIONS

ADDING MARGINS (MARGIN SHIFT)

This function shifts the copy image right, left or down to adjust the margin. This is convenient when you wish to bind the copies with a string or in a binder. **Shifting the image to the right so the copies can be bound at the left edge**

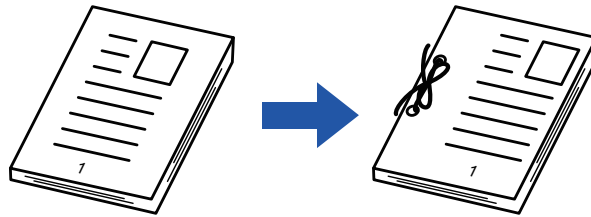

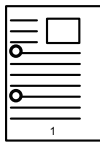
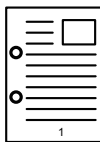
Not using the Margin Shift	Using the Margin Shift
	
<p>The punch holes cut off part of the image.</p>	<p>The image is moved to allow space for the holes so the image is not cut off.</p>

Margin Shift

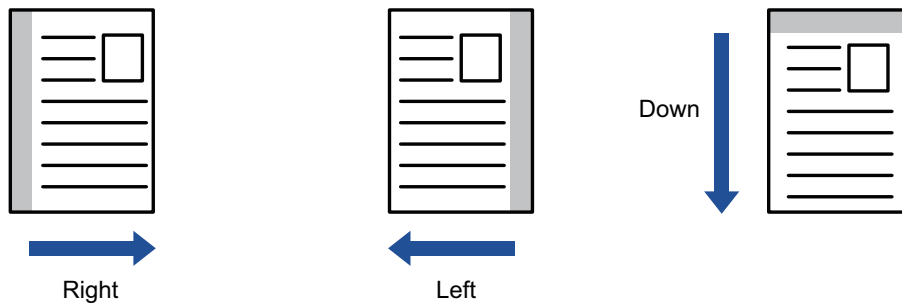

- Margin Shift cannot be selected in easy mode.
- Rotation copy cannot be used in combination with the margin shift function.



1

Place the original.

Place the original in the document feeder tray of the automatic document feeder, or on the document glass.

[AUTOMATIC DOCUMENT FEEDER \(page 1-34\)](#)

[DOCUMENT GLASS \(page 1-38\)](#)

2

Tap the [Others] key, and tap the [Margin Shift] key.

3

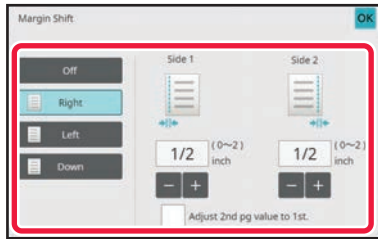

Tap the image shift direction.

4

Sets a margin shift width.

Tap the numeric value display indicating the margin shift area on the front side or reverse side, and enter the area using the numeric keys.

After the settings are completed, tap [OK] and [Back] keys in sequence.



If you set the [Adjust 2nd pg value to 1st.] checkbox to ,  goes out and you can set sides 1 and 2 separately.



To cancel the margin shift setting:

Tap the [Off] key.

To cancel all settings:

Tap the [CA] key.

5

Tap the [Start] key to start copying.



ERASING PERIPHERAL SHADOWS FOR COPYING (ERASE)

The erase function is used to erase shadows around the edges of copies that occur when copying thick originals or books.

When a thick book is copied

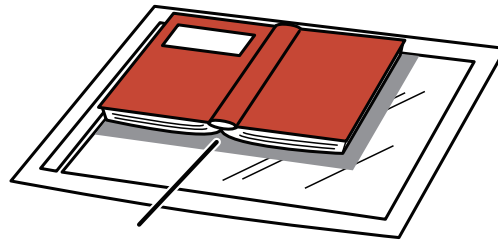

Shadows appear here

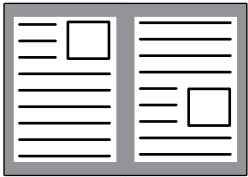
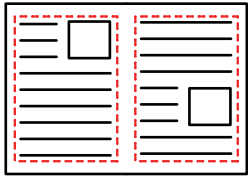

Not using the Erase	Using the Erase
	
<ul style="list-style-type: none"> • Shadows appear on the copy 	<p>Shadows do not appear on the copy</p>

Erase modes (Outer Frame Erase, Center Erase, Edge + Center Erase, Side Erase)

Outer Frame Erase

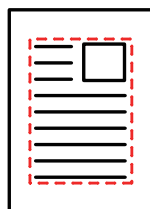

Center Erase

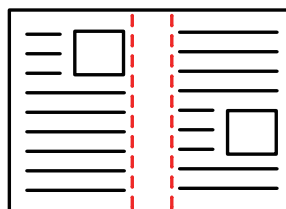

Edge + Center Erase

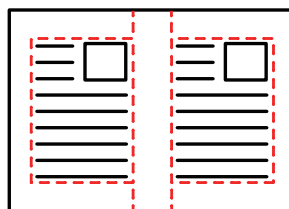

Side Erase

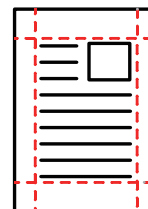

- Erase cannot be selected in easy mode.
- If a ratio setting is used in combination with an erase setting, the erase width will change according to the selected ratio. If the erase width setting is 1" (20 mm) and the image is reduced to 50%, the erase width will be 1/2" (10 mm).
- This function erases the parts of the image where shadows tend to form, but does not detect shadows and erase only the shadows.
- When Erase is selected, the orientation of the original is automatically set to portrait.



1

Place the original.

Place the original in the document feeder tray of the automatic document feeder, or on the document glass.
[AUTOMATIC DOCUMENT FEEDER \(page 1-34\)](#)
[DOCUMENT GLASS \(page 1-38\)](#)

2

Tap the [Others] key, and tap the [Erase] key.

3

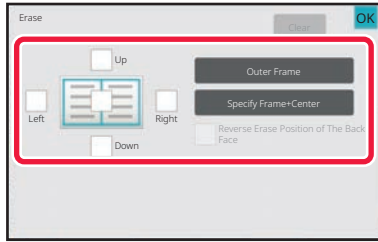

Tap the checkbox of the edge that you wish to erase, and specify the erase position.

Check that the tapped checkbox is set to .
 If the [Outer Frame] key is tapped, the [Up], [Down], [Left], and [Right] checkboxes are set to .
 If the [Specify Frame+Center] key is tapped, all the checkboxes are set to .



Specify the erase edge on the reverse side when erasing edges of one to three sides of Up, Down, Left, and Right on the front side to scan a 2-sided original.

- If the [Reverse erase position of back face] checkbox is set to , the edge in the position opposite to the erased edge on the front side will be erased.
- If the [Reverse erase position of back face] checkbox is set to , the edge in the same position as on the front side will be erased.

4

Specify the erase width.

Tap the numeric value display indicating the erase width area on the front side or reverse side, and enter the area using the numeric keys.
 After the settings are completed, tap [OK] and [Back] keys in sequence.



To quickly set the area, first specify a value close to the desired value by the numeric keys, then adjust it with **-** **+**.



- **To cancel the erase setting:**
Tap the [Clear] key.
- **To cancel all settings:**
Tap the [CA] key.

5

Tap the [Start] key to start copying.



COPYING ORIGINALS WITH NO EDGE CUT-OFF (FULL BLEED COPY)

This feature lets you copy an entire original to paper larger than the original size with no image cut-off at the edges.

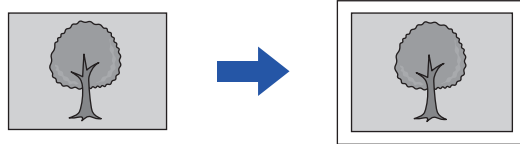

- Full Bleed Copy cannot be selected in easy mode.
- The punch function cannot be used.

1

Tap the [Others] key, and tap the [Full Bleed Copy] key.

"Select larger paper size than output image size of original." is displayed on the page.

Tap [OK] key.

When you have finished selecting other settings, tap the [Back] key.



To cancel the full bleed copy setting:

Tap the [Full Bleed Copy] key to uncheck it.

2

Place the original.

[AUTOMATIC DOCUMENT FEEDER \(page 1-34\)](#)

[DOCUMENT GLASS \(page 1-38\)](#)

3

Select paper larger than the output image

[SELECTING THE PAPER TRAY FOR COPYING \(page 3-13\)](#)

[SPECIFYING A TYPE AND SIZE OF PAPER LOADED ON BYPASS TRAY \(page 3-32\)](#)



To cancel all settings:

Tap the [CA] key.

4

Tap the [Start] key to start copying.



COPYING IN THE CENTER OF THE PAPER (CENTERING)

This function centers the copied image on the paper.

This lets you place the image in the center of the paper when the original size is smaller than the paper size or when the image is reduced.

Not using the centering function	Using the centering function
	



- Centering cannot be selected in easy mode.
- Centering must be specified before scanning the original.



- When the original size or the paper size is displayed as a special size, this function cannot be used.
- This function cannot be used in combination with an enlargement setting. If enlargement of 101% or more is selected, the enlargement is automatically returned to 100%.

1

Tap the [Others] key, and tap the [Centering] key.

A checkmark appears on the icon.

After the settings are completed, tap the [Back] key.



- **To cancel the centering setting:**
Tap the [Centering] key to clear the checkmark.
- **To cancel all settings:**
Tap the [CA] key.

2

Tap the [Start] key to start copying.



SPECIFYING A PAPER POSITION (POSITION IMAGE)

This function moves the scanned original to a specified position to make a copy. You can make a copy in any desired position as you can fine adjust the position. We recommend that you specify the top as the starting side of the original.

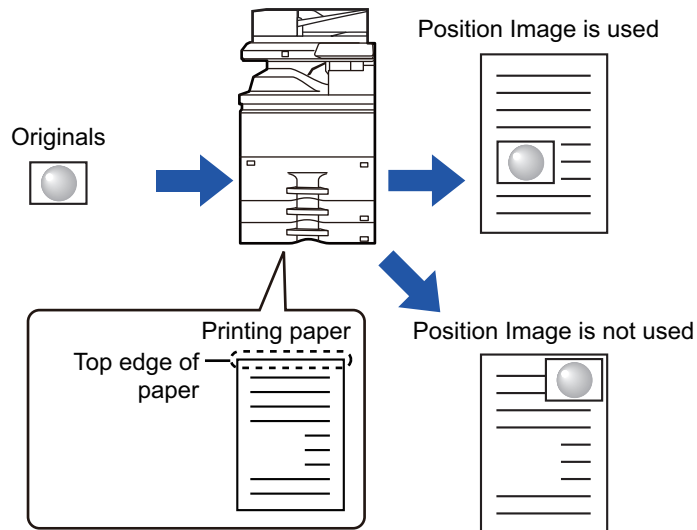

Position Image cannot be selected in easy mode.

1

Copy the original that you want to use for Move Copy.

Copying is performed without using move copy.

2

Measure the movement amount with the top as the starting side of the output copy.

3

Tap the [Others] key, and tap the [Position Image] key.



- Tap the [Original] key and specify the orientation of the original to have the orientation be correctly recognized.
- [SPECIFYING THE ORIENTATION OF THE ORIGINAL \(page 3-26\)](#)



4

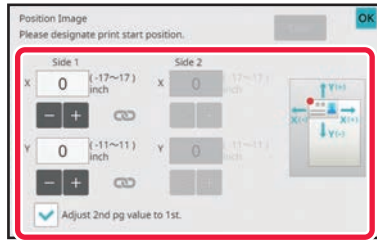

Sets a movement distance.

Tap the area indicating the movement distance on the front or reverse side, and enter the distance using numeric keys. After the settings are completed, tap [OK] and [Back] keys in sequence.



- To quickly set the area, first specify a value close to the desired value by the numeric keys, then adjust it with **-** **+**.
- If you set the [Adjust 2nd pg value to 1st.] checkbox to ,  goes out and you can set sides 1 and 2 separately.
- If you want to copy in the horizontal orientation, specify "Left" as the starting side of the original. Even if you copied in the horizontal orientation, setting the starting side of the original to the top enables measurement of the movement distance in the same way as in the vertical orientation.



To cancel the Position Image setting:
Tap the [Clear] key.

5

Place the original.

Place the original in the document feeder tray of the automatic document feeder, or on the document glass.
[AUTOMATIC DOCUMENT FEEDER \(page 1-34\)](#)
[DOCUMENT GLASS \(page 1-38\)](#)



To cancel all settings:
Tap the [CA] key.

6

Tap the [Start] key to start copying.



SCANNING FUNCTIONS

COLLECTIVELY SCANNING A LARGE NUMBER OF ORIGINALS (JOB BUILD)

This function divides the originals into sets and feeds each set through the automatic document feeder one set at a time when copying a very large number of originals.

This saves you the trouble of sorting the copies.

When scanning originals that are separated into sets, scan the set that has the first page first.

The individual copy settings can be configured for each set of originals to be scanned separately.

Up to 100 sets of originals can be scanned for one job.

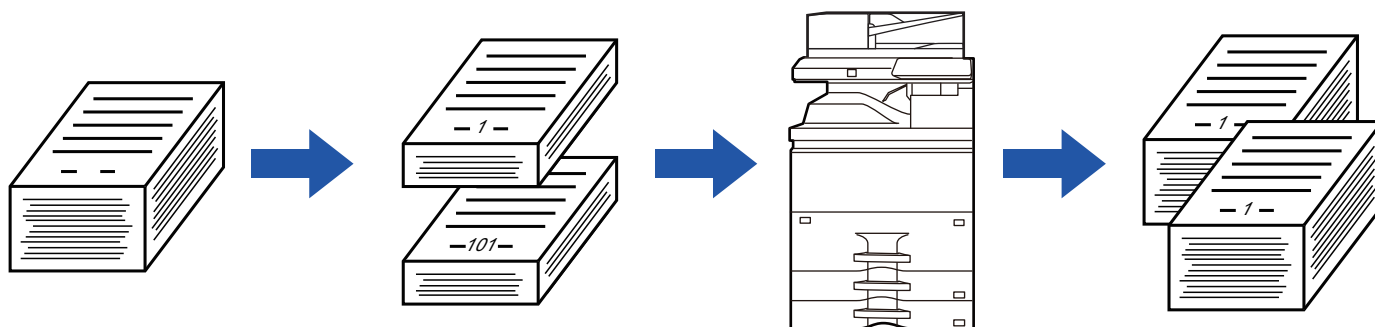

- You must select Job Build mode before scanning the original.
- If you needed to change all original settings, change before scanning the original.
- If the Quick File Folder of document filing mode is full, copying in job build mode will be impeded. Delete unnecessary files from the Quick File Folder.



The Job Build mode cannot be combined with other functions.

- Dual Page Copy
- Book Copy
- Card shot
- Multi-Page Enlargement
- Book Divide
- Repeat Layout



To use Job Build in Easy mode

In "Settings (administrator)", select [System Settings] → [Common Settings] → [Operation Settings] → [Easy Mode Settings] → [Easy Copy].



Copying in job build mode

1

Tap the [Others] key, and tap the [Job Build] key.

A checkmark appears on the icon.
After the settings are completed, tap the [OK] key.



To cancel the job build setting
Tap the [Job Build] key to uncheck it.

2

Change settings as needed.

3

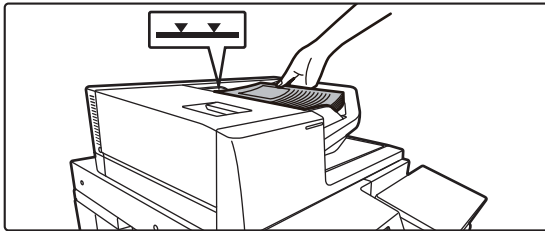

Place the original in the document feeder tray of the automatic document feeder, and tap the [Start] key to scan the first original.

Insert the originals all the way into the document feeder tray. Originals can be stacked up to the indicator line.
[AUTOMATIC DOCUMENT FEEDER \(page 1-34\)](#)

4

Place the next set of originals and tap the [Start] key.

Repeat this step until all originals have been scanned.



- To change copy settings for each set of originals, tap the [Change Setting] key. For more information, see [“Changing the copy settings for each set of originals \(page 3-98\)”](#).
- If you tap the [Preview] key, you cannot scan additional pages.

5

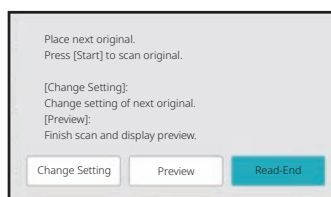

Repeat until all pages have been scanned and check the preview image in the preview screen.



To cancel all settings:
Tap the [CA] key.

6

Tap the [Read-End] key to start copying.



Changing the copy settings for each set of originals

As necessary, change copy settings for each set of originals.

Perform the steps below before scanning the next set of originals in step 4 of "[Copying in job build mode \(page 3-97\)](#)".



A [Separator Page] setting cannot be changed for the second and later sets.

1

Tap the [Change Setting] key.

2

Change copy settings.

3

Place the next set of originals and tap the [Start] key.

Repeat this step until all originals have been scanned.



SCANNING ORIGINALS OF DIFFERENT SIZES (MIXED SIZE ORIGINAL)

This feature copies originals in different sizes at the same time even when 8-1/2" x 14" (B4) size originals are mixed with 11" x 17" (A3) size originals.

When scanning the originals, the machine automatically detects the size of each original and uses paper appropriate for that size.

When mixed size original is combined with auto ratio selection, the ratio is adjusted individually for each original according to the selected paper size, enabling printing on a uniform paper size.

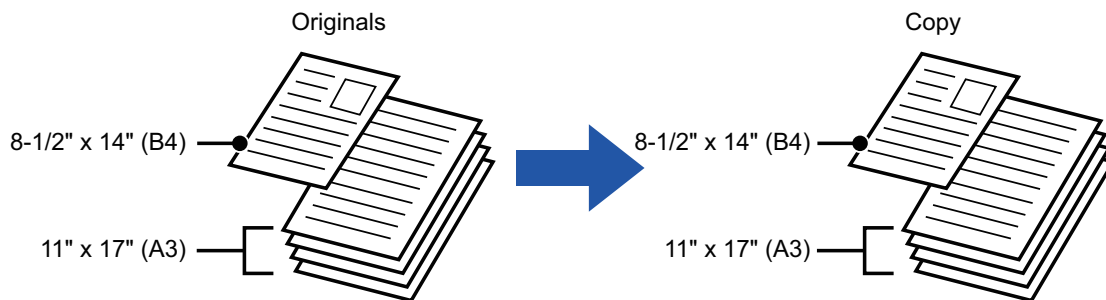

When mixed size original is combined with auto ratio selection

(When 11" x 17" (A3) is selected with the auto ratio selection, 8-1/2" x 14" (B4) size original is enlarged to 11" x 17" (A3) size for printing.)

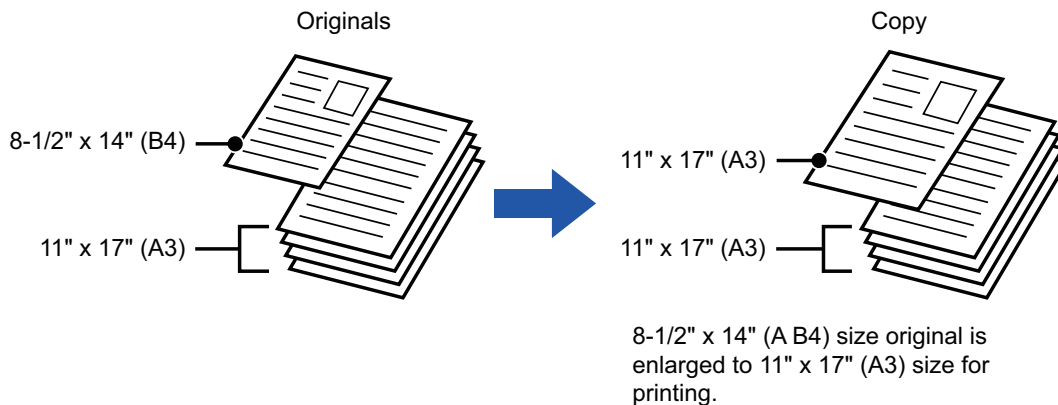



There are two settings for mixed size originals.

Same Width	<p>Use this setting for originals that are in 2 types of different sizes but have sides that are the same length. The originals are inserted in the document feeder tray with the sides that are the same length aligned together on the left.</p> <ul style="list-style-type: none"> • 11" x 17" and 8-1/2" x 11" • 8-1/2" x 14" and 8-1/2" x 11"R • 8-1/2" x 14" and 5-1/2" x 8-1/2" • 8-1/2" x 13" and 8-1/2" x 11"R • 8-1/2" x 13" and 5-1/2" x 8-1/2" • 8-1/2" x 11"R and 5-1/2" x 8-1/2" • A3 and A4 • B4 and B5 • A4R and A5
Different Width	<p>Use this setting when the originals are in 2 types of different sizes and do not have sides that are the same length. This setting can only be used for the following combinations of sizes:</p> <ul style="list-style-type: none"> • 11"x17" and 8-1/2"x14" • 11"x17" and 8-1/2"x13" • 11"x17" and 5-1/2"x8-1/2" • A3 and B4 • A3 and B5 • B4 and A5 • A4 and B5 • B4 and A4R • B4 and A5 • B5 and A4R • B5 and A5 <p>Use this setting when the originals are in 3 types of different sizes and do not have sides that are the same length. This setting can only be used for the following combinations of sizes:</p> <ul style="list-style-type: none"> • A4R, B4, and A3 • A5, B4, and A3 • A4R, B5, and A3 • A5, B5, and A3 • A4R, A4, and B4 • A5, A4, and B4 • B5, A4R, and A4 • A5, B5, and A4 • B5R, A4R, and B4 • A5, B5R, and B4 • B5R, A4R, and B5 • A5, B5, and B5R



- Mixed Size Original cannot be selected in easy mode.
- Mixed Size Original must be specified before scanning the original.



When [Different Width] is selected, the staple function cannot be used.

1

Tap the [Others] key, and tap the [Mixed Size Original] key.

2



Tap the [Same Width] key or the [Different Width] key as appropriate for the originals.

After the settings are completed, tap [OK] and [Back] keys in sequence.



To cancel the mixed size original setting
Tap the [Off] key.



3

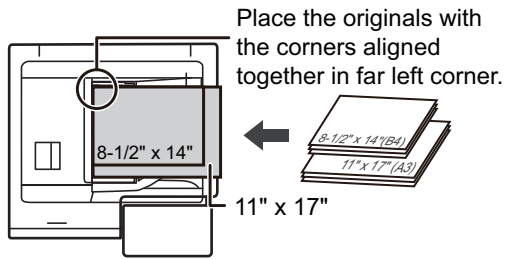

Place the original face up on the document feeder tray with the corners aligned together in far left corner.

Place the original as shown on the Mixed Size Original screen.



For mixed size originals, set "Original" to "Auto".

4

Tap the [Start] key to start copying.



SCANNING THIN ORIGINALS (SLOW SCAN MODE)

When you wish to scan thin originals using the automatic document feeder, you can use this function, which helps prevent thin originals from misfeeding.

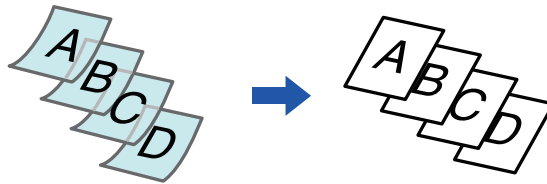

- Slow Scan Mode cannot be selected in easy mode.
- Slow Scan Mode must be specified before scanning the original.



The "2-Sided→2-Sided" and "2-Sided→1-Sided" modes of automatic 2-sided copying cannot be used.

1

Tap the [Others] key, and tap the [Slow Scan Mode] key.

A checkmark appears on the icon.
After the settings are completed, tap the [Back] key.



To cancel slow scan mode:
Tap the [Slow Scan Mode] key to clear the checkmark.

2

Place the original in the document feeder tray of the automatic document feeder.

[AUTOMATIC DOCUMENT FEEDER \(page 1-34\)](#)



If the originals are inserted with too much force, they may crumple and misfeed.

3

Tap the [Start] key to start copying.



SCANNING HEAVY ORIGINALS (HEAVY PAPER SCAN)

When you wish to scan heavy originals using the automatic document feeder, you can use this function, which helps prevent heavy originals from misfeeding.

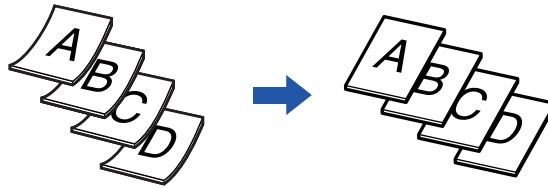

- Heavy Paper Scan cannot be selected in easy mode.
- Heavy Paper Scan must be specified before scanning the original.

1

Tap the [Others] key, and tap the [Heavy Paper Scan] key.

A checkmark appears on the icon.

After the settings are completed, tap the [Back] key.



To cancel Heavy Paper Scan:

Tap the [Heavy Paper Scan] key to clear the checkmark.

2

Place the original in the document feeder tray of the automatic document feeder.

[AUTOMATIC DOCUMENT FEEDER \(page 1-34\)](#)



If the originals are inserted with too much force, they may crumple and misfeed.

3

Tap the [Start] key to start copying.



ADJUSTING RESOLUTION WHEN SCANNING (RESOLUTION)

This function adjusts the resolution when scanning the original, enabling the high-quality output or speed-priority output according to the application.



- Resolution cannot be selected in easy mode.
- Resolution must be specified before scanning the original.
- The resolution setting is applied when making a full-size copy.

1

Tap the [Others] key, and tap the [Scan Resolution] key.

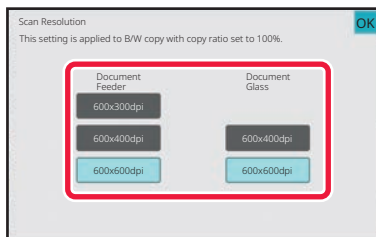
2

Select the resolution.

The resolution can be set to both the document feeder and document glass.

After the settings are completed, tap [OK] and [Back] keys in sequence.

3

Place the original.

Place the original in the document feeder tray of the automatic document feeder, or on the document glass.

[AUTOMATIC DOCUMENT FEEDER \(page 1-34\)](#)

[DOCUMENT GLASS \(page 1-38\)](#)

4

Tap the [Start] key to start copying.



TEXT AND IMAGE ADDITION FUNCTIONS

PRINTING DATES, PAGE NUMBERS, AND WATERMARKS (STAMP)

This function prints information such as the "Date" or "Stamp", which is not shown on the original, on copies. You can print the following six types of information.

- Date
- Page No.
- Stamp
- Copies
- Text
- Watermark

For the stamp or watermark, you can print text such as "CONFIDENTIAL" or "PRIORITY". You can print pre-set text or any characters as the text.

Each of the items above can be printed on the header or footer of each sheet.

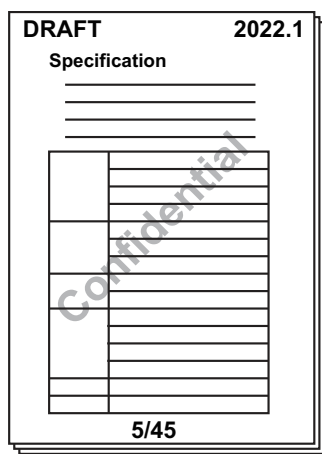

- Stamp cannot be selected in easy mode.
- If the selected stamp content of one position overlaps the stamp content of another position, priority will be given in the following order: watermark, right side, left side, center. Content that is hidden due to overlapping will not be printed.
- Text will be printed at the preset size regardless of the copy ratio or paper size setting.
- Text will be printed at the preset exposure regardless of the exposure setting.
- Depending on the size of the paper, some printed content may be cut off or shifted out of position.



Text Setting (Stamp) in Print menu

In "Settings (administrator)", select [System Settings] → [Copy Settings] → [Condition Settings] → [Text /Image Printing] → [Text Settings (Stamp)]

Register preset text to be used in [Stamp].



When [Stamp] is combined with other functions:

Combined function name	Print operation
Margin Shift	Together with the image, the stamp content is shifted the amount of the margin width.
Tab Copy Centering	Unlike a copy image that moves, the image will be printed in the position set in the stamp.
Dual Page Copy Book Divide Card Shot	Stamp items are printed for each copy sheet.
N-Up	Stamp items are printed for each original page.
Booklet Book Copy	Stamp items are printed for each page when compiling.
Covers/Inserts	Use the stamp settings to select whether or not the item is printed on inserted covers and inserts.

1

Place the original.

Place the original in the document feeder tray of the automatic document feeder, or on the document glass.
[AUTOMATIC DOCUMENT FEEDER \(page 1-34\)](#)
[DOCUMENT GLASS \(page 1-38\)](#)

2

Tap the [Others] key, and tap the [Stamp] key.

3

Tap a tab to be printed, and tap the format.

The format of the [Text] tab can be entered using pre-set text or soft keyboard.
[Setting using the \[Text\] tab \(page 3-107\)](#)



When you tap the  tab, the display tab is switched.

4

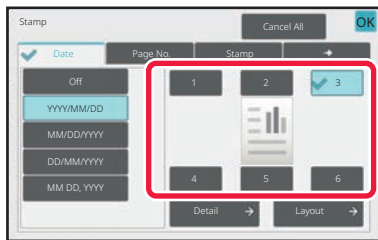

Tap a key of the desired print position.

Tap any of [1] to [6] keys.



- Tapping the [Detail] key allows you to configure setting for each setting position.
- Tapping the [Layout] key allows you to check the printing position or detailed settings.



- **To cancel the text settings:**
Tap the [Cancel All] key.
- **To cancel all settings:**
Tap the [CA] key.



5

Tap the [Start] key to start copying.

Setting using the [Text] tab

Tap the [Direct Entry] key in the [Text] tab to display the soft keyboard.
Use the soft keyboard to enter any characters.

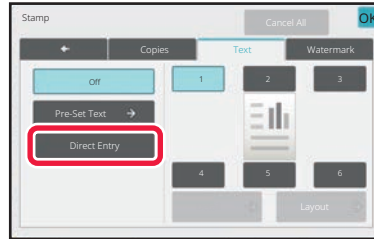

Selecting the format from pre-set text

Tapping the [Pre-Set Text] key allows you to select the required one of the registered formats for printing.
Tapping the [Store/Delete] key allows you to edit, delete, or store pre-set text.

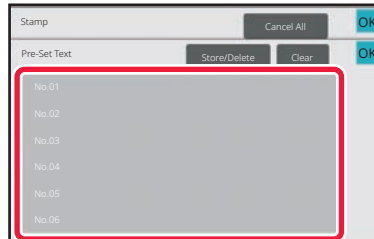



ADDING A REGISTERED IMAGE TO AN ORIGINAL (CUSTOM IMAGE)

This function adds an image registered in the machine to an original to make a copy.

Following are two types of custom images.

- Custom stamp (Stamp image)

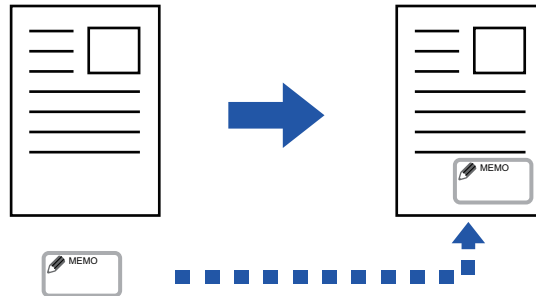

- Custom watermark (Stamp image with gray-scale watermark)

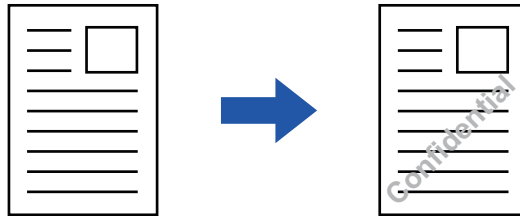

The combination with other functions is described in the table below.

Combined function	Custom image operations
Margin Shift	Shifts in the same way as for an original image.
Erase	Makes a stamp copy as normal.
Dual Page Copy	Makes a stamp copy by sheet.
Booklet	Makes a stamp copy as normal.
Job Build	Makes a stamp copy as normal.
Tandem Copy	Based on the tandem copy.
Covers/Inserts	Based on the custom image setting.
Separator Page	Printing does not take place on separator pages.
Transparency Inserts	Makes a stamp copy as normal.
N-Up	Makes a stamp copy by sheet.
Book Copy	Makes a stamp copy as normal.
Tab Copy	Makes a stamp copy as normal regardless of image shift setting.
Card Shot	Makes a stamp copy by sheet.
Business Card Copy	Makes Business Card Copy by sheet.
Mirror Image	Makes a stamp copy as normal without mirror image reverse.



Combined function	Custom image operations
B/W Reverse	Prints an image as normal without B/W reverse. However, the following condition is set when printed on a dark background. Custom stamp: Printed in white Custom watermark: Printed without being whitened
Full Bleed Copy	Makes a stamp copy as normal.
Centering	Makes a stamp copy as normal without centering.
Stamp	Makes a stamp copy on the Stamp menu.
Photo Repeat	Cannot be combined.
Multi-Page Enlargement	Cannot be combined.
Hidden Pattern Print	Makes a stamp copy under a pattern print.
Tracking Information Print	Makes a stamp copy under a tracking information print.
Repeat Layout	Cannot be combined.
Position Image	Prints an image at the original position regardless of the Position Image setting.
Book Divide	Makes a stamp copy by sheet.



- Custom Image cannot be selected in easy mode.
- An image must be registered in advance from the printer driver to the machine.
[REGISTERING A CUSTOM IMAGE \(page 4-52\)](#)
- A custom stamp image is copied by sheet, not by original. If N-Up is enabled, user stamps are copied for each set of pages.
- A custom stamp image is copied with the registered size. The size remains unchanged even when the copy ratio is enlarged or reduced.
- A different custom image cannot be specified for each page.
- If an image runs off of the specified paper depending on the registered size or position, the excess will not be copied.
- Custom Image can be combined with Tandem Copy. Stamp copy is performed when a custom image with the same file name is registered in both the primary and secondary units. If it is not registered, a copy will be made without a custom image.

1**Place the original.**

Place the original in the document feeder tray of the automatic document feeder, or on the document glass.

[AUTOMATIC DOCUMENT FEEDER \(page 1-34\)](#)

[DOCUMENT GLASS \(page 1-38\)](#)

2**Tap the [Others] key, and tap the [Custom Image] key.****3****Tap the [Custom Stamp] or [Custom Watermark] key.****4****Tap the [Image] key to select an image.**

Select the required thumbnail image(s) from the available selection.



5

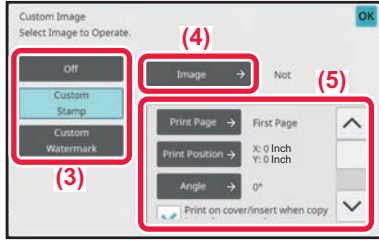

Set [Print Page] or [Print Position].

After the settings are completed, tap [OK] and [Back] keys in sequence.



- **To cancel the custom image setting:**
Tap the [Off] key.
- **To cancel all settings:**
Tap the [CA] key.

6

Tap the [Start] key to start copying.

For settings related to custom stamp and custom water mark, see the following table.

For custom stamp

Print Page	Specify a page(s) for stamp copy. First Page or All Pages
Print Position	Specify a position for stamp copy.
Print Angle	Specify the corner of the image. 0 degrees, -90 degrees, 90 degrees, or 180 degrees

For custom watermark

Print Pattern	Specify the image watermark print pattern. Transparent: Makes an original image transparent for stamp copy. Overlap: Hides a watermark added to an original image for stamp copy.
Exposure	Select the exposure of a watermark from nine levels.
Print Page	Specify a page(s) for stamp copy. First Page or All Pages
Print Position	Specify a position for stamp copy.
Print Angle	Specify the corner of the image. 0 degrees, -90 degrees, 90 degrees, or 180 degrees



INSERTING COVERS IN COPIES (COVERS/INSERTS)

This function inserts a different type of paper into the pages corresponding to the front and back covers of a copy job. It is helpful when you want to change cover paper to make resources look better. Configure insertion sheet settings if needed.



- To insert insertion sheets, see "[INSERTING INSERTION SHEETS IN COPIES \(COVERS/INSERTS\) \(page 3-119\)](#)".
- For N-Up, the layout is based on the first page and excludes covers.

Copying on a front cover and inserting together with a back cover

A different type of paper is inserted as a front cover, and a back cover is inserted to the last of the copy job.

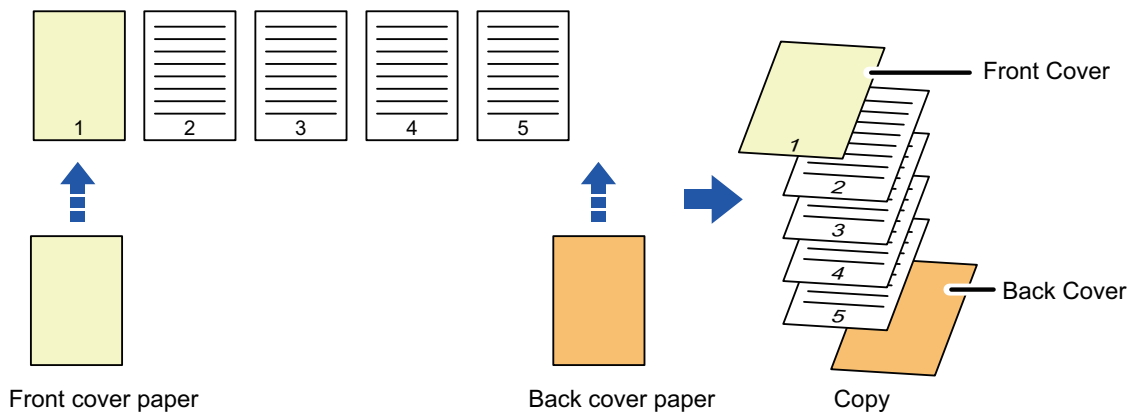

Cover inserting examples

The following shows the copy results when front and back covers are inserted into six 1-sided original pages or three 2-sided original pages in the four copy modes below.

1-sided copying of 1-sided originals

Setting conditions for each cover		Resulting copies
Front Cover	Back Cover	
Not copied	Not copied	<p>Inserts cover sheets at the beginning and end of copies.</p>
1-sided copy	Not copied	<p>Makes a 1-sided copy on the first original page for front cover, and inserts a back cover at the end of copies.</p>
2-sided copy	Not copied	<p>Makes a 2-sided copy on the first and second original pages for front cover, and inserts a back cover at the end of copies.</p>



Setting conditions for each cover		Resulting copies
Front Cover	Back Cover	
Not copied	1-sided copy	<p>Inserts a front cover at the beginning of copies, and makes a 1-sided copy on the sixth original page for back cover.</p>
Not copied	2-sided copy	<p>Inserts a front cover at the beginning of copies, and makes a 2-sided copy on the fifth and sixth original pages for back cover.</p>
1-sided copy	1-sided copy	<p>Makes a 1-sided copy on the first original page for front cover, and also makes a 1-sided copy on the sixth original page for back cover.</p>
1-sided copy	2-sided copy	<p>Makes a 1-sided copy on the first original page for front cover, and also makes a 2-sided copy on the fifth and sixth original pages for back cover.</p>
2-sided copy	1-sided copy	<p>Makes a 2-sided copy on the first and second original pages for front cover, and also makes a 1-sided copy on the sixth original page for back cover.</p>
2-sided copy	2-sided copy	<p>Makes a 2-sided copy on the first and second original pages for front cover, and also makes a 2-sided copy on the fifth and sixth original pages for back cover.</p>

2-sided copying of 1-sided originals

Setting conditions for each cover		Resulting copies
Front Cover	Back Cover	
Not copied	Not copied	<p>Inserts cover sheets at the beginning and end of copies.</p>

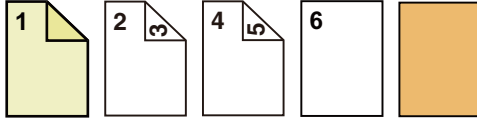
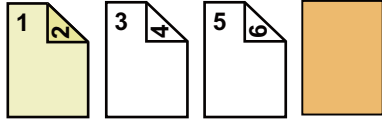
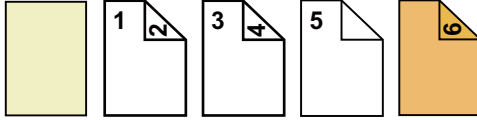
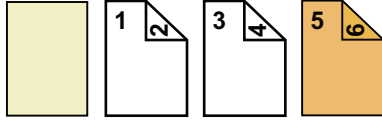
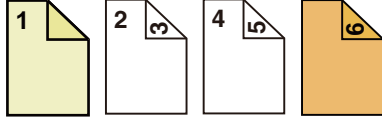
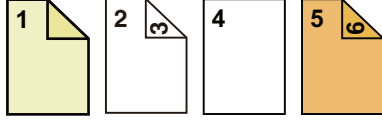
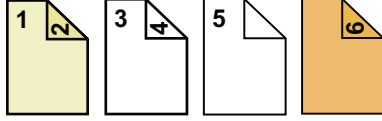

Setting conditions for each cover		Resulting copies
Front Cover	Back Cover	
1-sided copy	Not copied	 <p>Makes a 1-sided copy on the first original page for front cover, and also makes a 1-sided copy on the sixth original page. Inserts cover sheets at the end of copies.</p>
2-sided copy	Not copied	 <p>Makes a 2-sided copy on the first and second original pages for front cover, and inserts a back cover at the end of copies.</p>
Not copied	1-sided copy	 <p>Inserts a front cover at the beginning of copies, and makes a 1-sided copy on the sixth original page for back cover. A 1-sided copy is made on the fifth original page.</p>
Not copied	2-sided copy	 <p>Inserts a front cover at the beginning of copies, and makes a 2-sided copy on the fifth and sixth original pages for back cover.</p>
1-sided copy	1-sided copy	 <p>Makes a 1-sided copy on the first original page for front cover, and also makes a 1-sided copy on the sixth original page for back cover.</p>
1-sided copy	2-sided copy	 <p>Makes a 1-sided copy on the first original page for front cover, and also makes a 2-sided copy on the fifth and sixth original pages for back cover.</p>
2-sided copy	1-sided copy	 <p>Makes a 2-sided copy on the first and second original pages for front cover, and also makes a 1-sided copy on the sixth original page for back cover. A 1-sided copy is made on the fifth original page.</p>

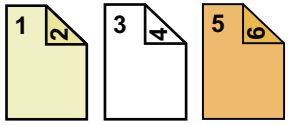

Setting conditions for each cover		Resulting copies
Front Cover	Back Cover	
2-sided copy	2-sided copy	 <p>Makes a 2-sided copy on the first and second original pages for front cover, and also makes a 2-sided copy on the fifth and sixth original pages for back cover.</p>

1-sided copying of 2-sided originals

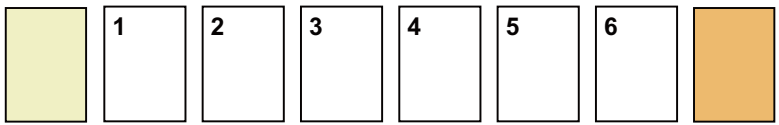
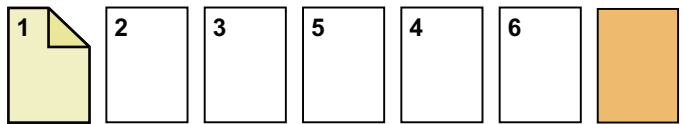
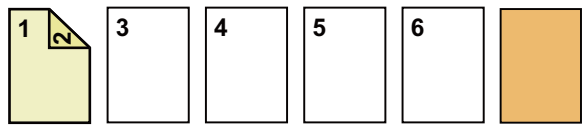
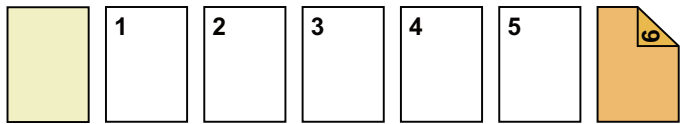
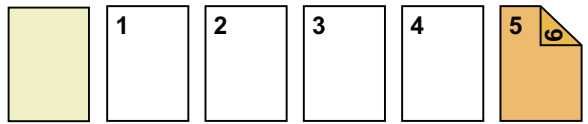
Setting conditions for each cover		Resulting copies
Front Cover	Back Cover	
Not copied	Not copied	 <p>Inserts cover sheets at the beginning and end of copies.</p>
1-sided copy	Not copied	 <p>Makes a 1-sided copy on the first original page for front cover, and inserts a back cover at the end of copies.</p>
2-sided copy	Not copied	 <p>Makes a 2-sided copy on the first and second original pages for front cover, and inserts a back cover at the end of copies.</p>
Not copied	1-sided copy	 <p>Inserts a front cover at the beginning of copies, and makes a 1-sided copy on the sixth original page for back cover.</p>
Not copied	2-sided copy	 <p>Inserts a front cover at the beginning of copies, and makes a 2-sided copy on the fifth and sixth original pages for back cover.</p>

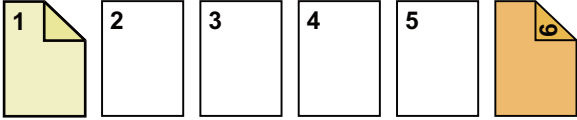
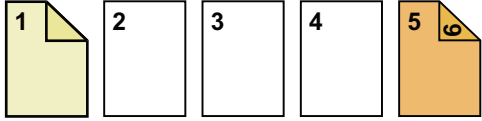
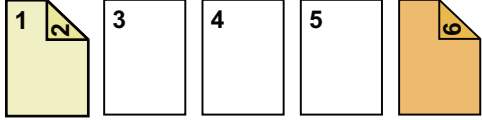
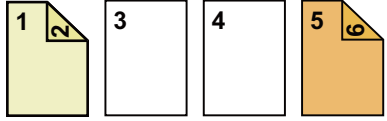

Setting conditions for each cover		Resulting copies
Front Cover	Back Cover	
1-sided copy	1-sided copy	 <p>Makes a 1-sided copy on the first original page for front cover, and also makes a 1-sided copy on the sixth original page for back cover.</p>
1-sided copy	2-sided copy	 <p>Makes a 1-sided copy on the first original page for front cover, and also makes a 2-sided copy on the sixth original page for back cover.</p>
2-sided copy	1-sided copy	 <p>Makes a 2-sided copy on the first and second original pages for front cover, and also makes a 1-sided copy on the sixth original page for back cover.</p>
2-sided copy	2-sided copy	 <p>Makes a 2-sided copy on the first and second original pages for front cover, and also makes a 2-sided copy on the fifth and sixth original pages for back cover.</p>

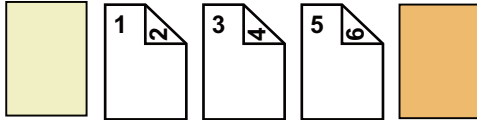
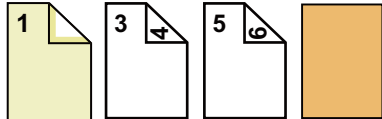
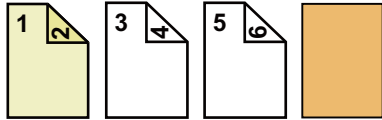
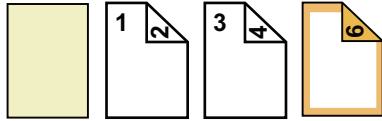
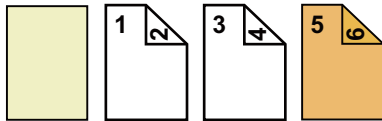
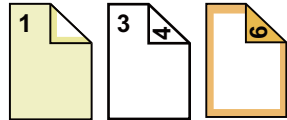
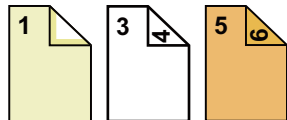

2-sided copying of 2-sided originals

Setting conditions for each cover		Resulting copies
Front Cover	Back Cover	
Not copied	Not copied	 <p>Inserts cover sheets at the beginning and end of copies.</p>
1-sided copy	Not copied	 <p>Makes a 1-sided copy on the first original page for front cover, and inserts a back cover at the end of copies. *The second original page is not copied.</p>
2-sided copy	Not copied	 <p>Makes a 2-sided copy on the first and second original pages for front cover, and inserts a back cover at the end of copies.</p>
Not copied	1-sided copy	 <p>Inserts a front cover at the beginning of copies, and makes a 1-sided copy on the sixth original page for back cover. * The fifth original page is not copied.</p>
Not copied	2-sided copy	 <p>Inserts a front cover at the beginning of copies, and makes a 2-sided copy on the fifth and sixth original pages for back cover.</p>
1-sided copy	1-sided copy	 <p>Makes a 1-sided copy on the first original page for front cover, and also makes a 1-sided copy on the sixth original page for back cover. The second and the fifth original pages are not copied.</p>
1-sided copy	2-sided copy	 <p>Makes a 1-sided copy on the first original page for front cover, and also makes a 2-sided copy on the fifth and sixth original pages for back cover. * The second original page is not copied.</p>

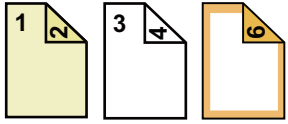
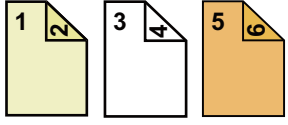

Setting conditions for each cover		Resulting copies
Front Cover	Back Cover	
2-sided copy	1-sided copy	 <p>Makes a 2-sided copy on the first and second original pages for front cover, and also makes a 1-sided copy on the sixth original page for back cover. * The fifth original page is not copied.</p>
2-sided copy	2-sided copy	 <p>Makes a 2-sided copy on the first and second original pages for front cover, and also makes a 2-sided copy on the fifth and sixth original pages for back cover.</p>



- Covers/Inserts cannot be selected in easy mode.
- Before using the covers/inserts function, load insertion sheets in the tray.
- When selecting the covers/inserts function, place the originals in the document feeder tray, select 1-sided or 2-sided copying, and select the number of copies and any other desired copy settings. When these settings have been completed, perform the procedure to select covers/inserts.
- One sheet can be inserted for each of front and back covers.



- When performing 2-sided copying of 2-sided originals, an insertion sheet cannot be inserted between the front and reverse sides of an original.
- This function cannot be used in combination with the saddle stitch function.

1

Place the original in the document feeder tray of the automatic document feeder.

[AUTOMATIC DOCUMENT FEEDER \(page 1-34\)](#)

2

Tap the [Others] key, and then tap the [Covers/Inserts] key.

3

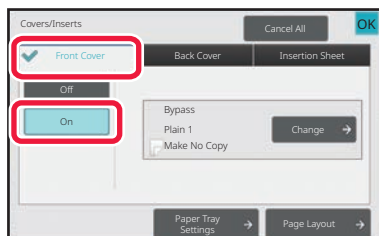

Tap the [Front Cover] key, and then tap the [On] key.

When inserting a back cover, tap the [Back Cover] tab, and then tap the [On] key.



4

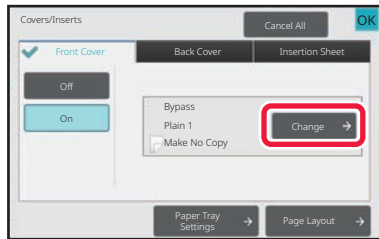

Tap the [Change] key.

5

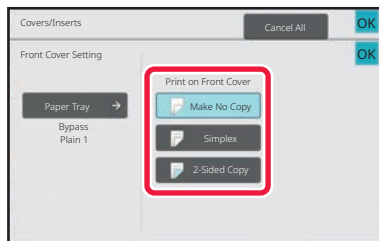

Configure copy setting of a front cover sheet.

When only inserting a cover, tap the [Make No Copy] key. If you selected the [2-Sided Copy] key, tap the [Book] or [Tablet] key for the front cover binding. After the settings are completed, tap [OK] key.



To change the cover input tray:

Tap the [Paper Tray Settings] key to display the input tray setting screen. On the input tray setting screen, tap the [Paper Tray] key of [Front Cover] or [Back Cover].

For more information, see "[SELECTING THE PAPER TRAY FOR COPYING \(page 3-13\)](#)".



- If the cover will be copied on, label sheets, transparency film, and tab paper cannot be used. If not copied on, tab paper can be inserted.
- **To cancel cover sheet insertion:**
Tap the [Off] key.
- **To cancel the front cover, back cover, and insertion sheet settings at the same time:**
Tap the [Cancel All] key.
- **To cancel all settings:**
Tap the [CA] key.

6

Tap the [Start] key to start copying.



INSERTING INSERTION SHEETS IN COPIES (COVERS/INSERTS)

This function inserts a sheet of paper into a specific page as an insertion sheet. There are 8 types of insertion sheets. Insertion positions can be specified. Insert covers if needed.



When inserting covers, see "[INSERTING COVERS IN COPIES \(COVERS/INSERTS\) \(page 3-111\)](#)".

Example: Inserting sheets after pages 3 and 5

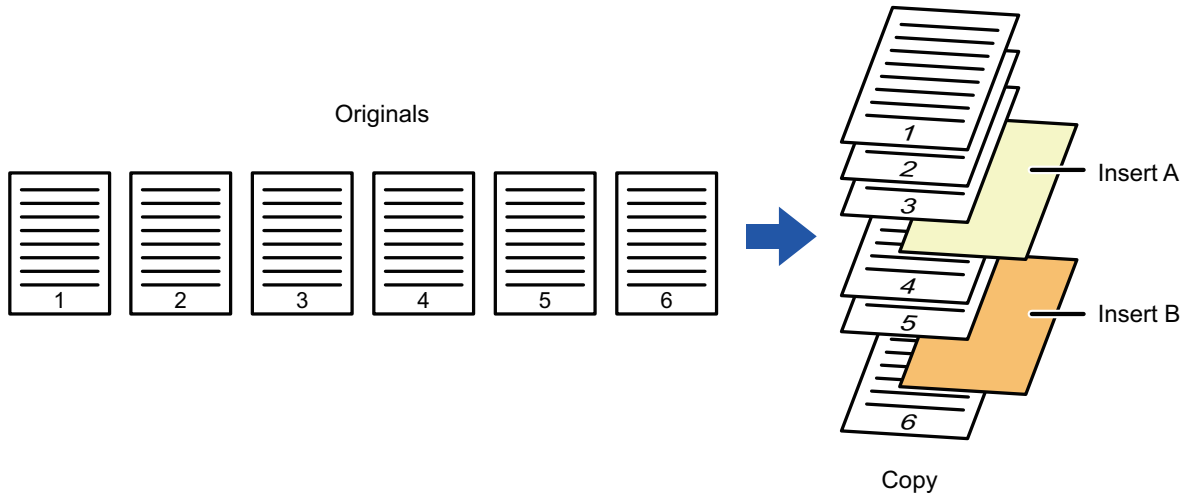

Sheet inserting examples

The following examples show the copy results when insertion sheets are inserted into six 1-sided originals or three 2-sided originals using two copy modes.

1-sided original copying

Insertion sheet setting conditions	Resulting copies	
	Insert an insertion sheet in 1-sided copy mode.	Insert an insertion sheet in 2-sided copy mode.
Not copied	<p>Inserts an insertion sheet between the second and third pages of copies.</p>	
1-sided copy	<p>Makes a 1-sided copy of the third original page on an insertion sheet.</p>	

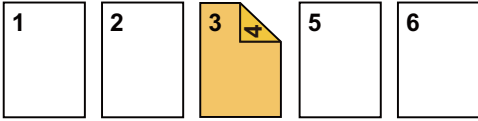
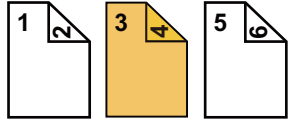

Insertion sheet setting conditions	Resulting copies	
	Insert an insertion sheet in 1-sided copy mode.	Insert an insertion sheet in 2-sided copy mode.
2-sided copy	 <p>Makes a 2-sided copy of the third and fourth original pages on an insertion sheet.</p>	

2-sided original copying

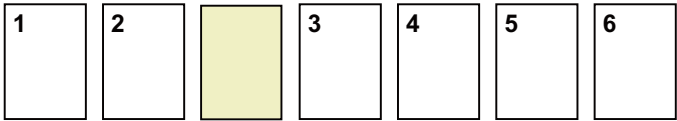
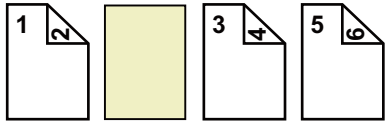
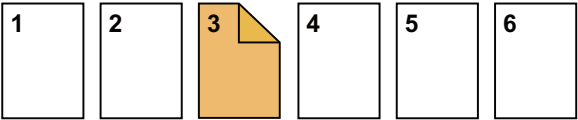
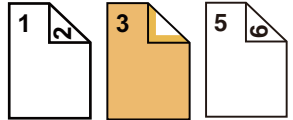
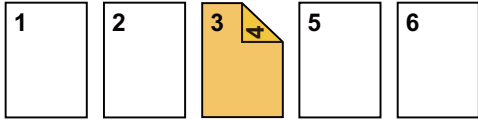
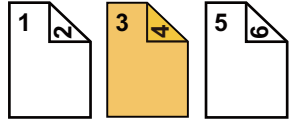
Insertion sheet setting conditions	Resulting copies	
	Insert an insertion sheet in 1-sided copy mode.	Insert an insertion sheet in 2-sided copy mode.
Not copied	 <p>Inserts an insertion sheet between the second and third pages of copies.</p>	
1-sided copy	 <p>Makes a 1-sided copy of the third original page on an insertion sheet.</p>	 <p>* The fourth original page is not copied.</p>
2-sided copy	 <p>Makes a 2-sided copy of the third and fourth original pages on an insertion sheet.</p>	



- Covers/Inserts cannot be selected in easy mode.
- Before using the covers/inserts function, load insertion sheets in the tray.
- When selecting the covers/inserts function, place the originals in the document feeder tray, select 1-sided or 2-sided copying, and select the number of copies and any other desired copy settings. When these settings have been completed, perform the procedure to select covers/inserts.
- The insertion sheet size must be the same as the copy size.
- Up to 100 insertion sheets can be inserted.



- The document glass is not available for this function.
- Take care that two insertion sheets cannot be inserted into the same page.
- When performing 2-sided copying of 2-sided originals, an insertion sheet cannot be inserted between the front and reverse sides of an original.
- This function cannot be used in combination with the saddle stitch function.



1

Place the original in the document feeder tray of the automatic document feeder.

[AUTOMATIC DOCUMENT FEEDER \(page 1-34\)](#)

2

Tap the [Others] key, and then tap the [Covers/Inserts] key.

3

Tap the [Insertion Sheet] tab.

4

Tap the [Insertion Type A] key, and tap the insert page display key.

The Insertion Type B to Type H settings are the same as the Insertion Type A settings.

5

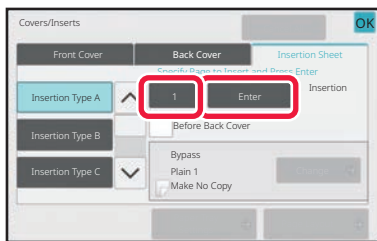

Enter the number of the page you want to insert a sheet into using numeric keys, and then tap the [Enter] key.

The total number of insertion sheets is displayed at the side of [Enter] key. Repeat these steps for the number of insertion sheets.

After the settings are completed, tap [OK] key.



• If you have entered an incorrect insert page number:

Tap the [Page Layout] key and change the page.

[CHECKING, EDITING, AND DELETING THE PAGE LAYOUT OF COVERS AND INSERTION SHEETS \(PAGE LAYOUT\) \(page 3-123\)](#)

• To cancel insertion sheets:

Tap the [Cancel All] key.

6

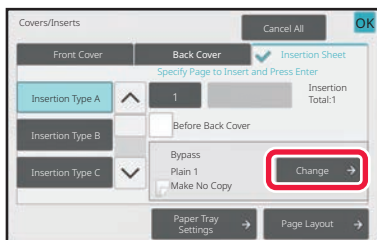

Tap the [Change] key.



7

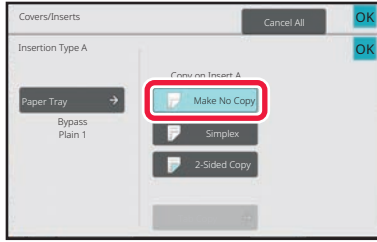

When only inserting insertion sheet A, tap the [Make No Copy] key.

When making a copy on insertion sheet A, tap the [Simplex] or [2-Sided Copy] key.

If you selected [2-Sided Copy], tap the [Book] key or [Tablet] key for the insert sheet binding.

After the settings are completed, tap [OK] key.



• **To change an insertion sheet:**

Tap the [Paper Tray] key, and select the tray with insertion sheets loaded.

• To copy on tab paper, tap the [Tab Copy] key.

[COPYING CAPTIONS ONTO TAB PAPER \(TAB COPY\) \(page 3-126\)](#)



• When copying on both sides of an insertion sheet, you cannot use label sheets, transparency films, or tab paper for insertion. If not copied on, tab paper can be inserted.

• **To cancel all settings:**

Tap the [CA] key.

8

Tap the [Start] key to start copying.



CHECKING, EDITING, AND DELETING THE PAGE LAYOUT OF COVERS AND INSERTION SHEETS (PAGE LAYOUT)



The editing contents are different between the registered covers and insertion sheets as shown below.

- For the "Cover Sheet", you can change settings such as the paper type, copy/do not copy, 1-Sided, and 2-Sided.
- For "Insert Sheet", you can change only the page number you want to insert an insert sheet into.

1

Tap the [Others] key, and then tap the [Covers/Inserts] key.

2

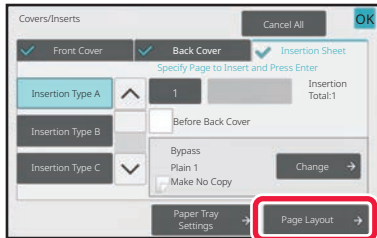

Tap the [Page Layout] key.



If the settings for the covers or insertion sheets are not configured, the [Page Layout] key is disabled.

3

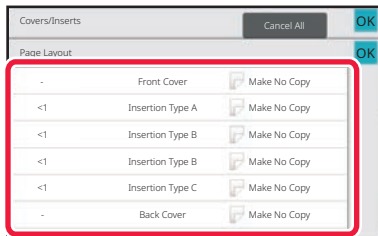

Check the page layout.

To exit this job after checking the page layout, tap the [OK] key.

To edit or delete, tap the required key. When deleting, tap the [Delete] key.

When editing, tap the [Modify] key.

When setting consecutive insertion of different types of inserts at the same page, you can tap [Replace Order of Inserts] on the action panel to change the order.

4

Change cover or insertion sheet settings.

For the cover, you can change the copy mode.

You can change the page number you want to insert an insert sheet into.

After the settings are completed, tap [OK] key.



INSERTING INSERTION SHEETS IN BETWEEN TRANSPARENCY FILMS (TRANSPARENCY INSERTS)

When copying on transparency film, the sheets may stick together due to static electricity.

The transparency inserts function can be used to automatically insert a sheet of paper between each sheet of transparency film, making the sheets easy to handle.

It is also possible to copy on insertion sheets.

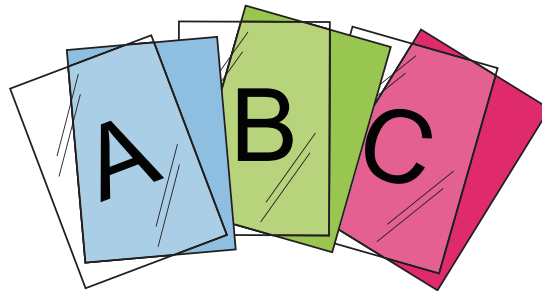

- Transparency Inserts cannot be selected in easy mode.
- When performing 2-sided copying, only "2-Sided→1-Sided" mode can be used.



- The number of copies cannot be selected in this mode.
- Transparency film can be loaded in the bypass tray or tray 4.

1

Load transparency film in the bypass tray or tray 4.

When loading paper in the bypass tray, place the paper with the print side facing down. When loading paper in tray 4, place the paper with the print side facing up.

[MAKING COPIES USING THE BYPASS TRAY \(page 3-31\)](#)

2

Place the original.

Place the original in the document feeder tray of the automatic document feeder, or on the document glass.

[AUTOMATIC DOCUMENT FEEDER \(page 1-34\)](#)

[DOCUMENT GLASS \(page 1-38\)](#)

3

Tap the [Others] key, and then tap the [Transparency Inserts] key.



4

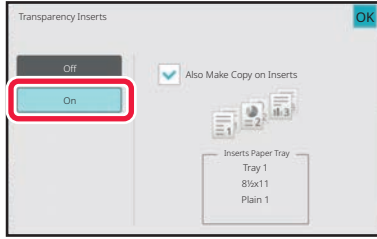

Tap the [On] key.

When making a copy on insertion sheets, tap the [Also Make Copy on Inserts] checkbox to set to .

After the settings are completed, tap [OK] key.



- **To cancel the transparency inserts setting:**

Tap the [Off] key.

- **To cancel all settings:**

Tap the [CA] key.

5

Tap the [Start] key to start copying.



FUNCTIONS FOR SPECIFIC USES

COPYING CAPTIONS ONTO TAB PAPER (TAB COPY)

Load a tab sheet in the bypass tray, and make a copy on a tab.

Prepare originals for captions that match the tab positions.

The image is shifted by the width of the tab.

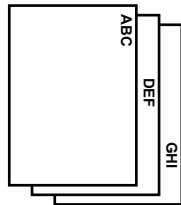

Prepare originals that match the tab positions.

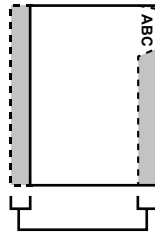

Prepare originals that match the tab positions.

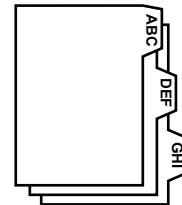

Relation between the originals and the tab paper

Tab copying with a left binding

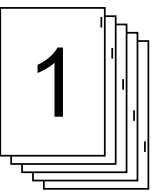
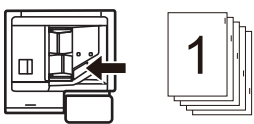
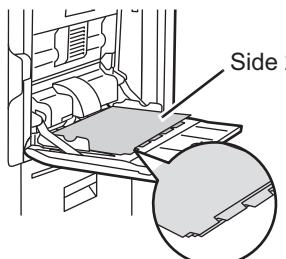
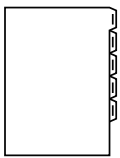
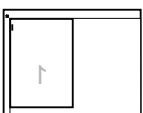
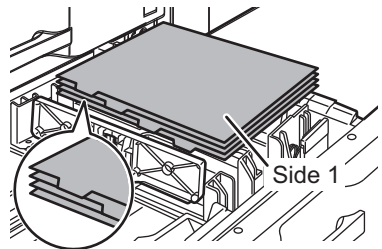
Originals	Placing the originals	Loading tab paper
<p>Originals</p> 	<p>Document feeder tray</p>  <p>Insert the originals so that the side with no tab text enters first.</p>	<p>Bypass tray</p> 
<p>Final image</p> 	<p>Document glass</p>  <p>Place so that the side with the tab text is on the left.</p>	<p>Tray 4</p>  <p>Load the tab paper so that the tab on the first sheet is toward you.</p> <p>Place the first sheet of tab paper so that the tab faces away from you.</p>

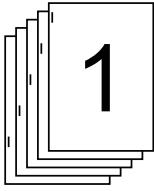
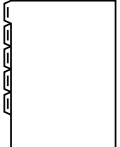
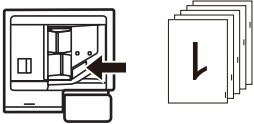
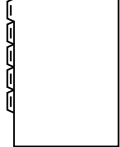
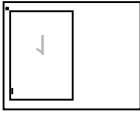
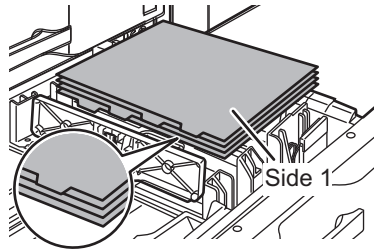

Tab copying with a right binding

Originals	Placing the originals	Loading tab paper
<p>Originals</p> 	<p>Document feeder tray</p>  <p>Insert the originals so that the side with no tab text enters first.</p>	<p>Bypass tray</p>  <p>Side 2</p> <p>Load the tab paper so that the tab on the first sheet is away from you.</p>
<p>Final image</p> 	<p>Document glass</p>  <p>Place so that the side with the tab text is on the left.</p>	<p>Tray 4</p>  <p>Side 1</p> <p>Place the first sheet of tab paper so that the tab faces toward you.</p>



- Tab Copy cannot be selected in easy mode.
- Tab Copy must be specified before scanning the original.

1

Tap the [Others] key, and tap the [Tab Copy] key.

2

Tap the [On] key.

3

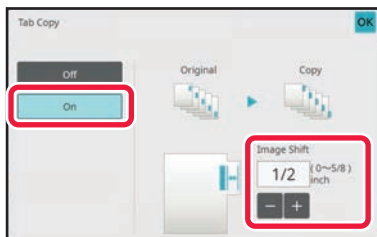

Sets an image shift width (tab width).

- Tap the numeric value display indicating the image shift width, and enter a shift width using numeric keys.
- After the settings are completed, tap [OK] and [Back] keys in sequence.



To cancel the tab copy setting:
Tap the [Off] key.

4

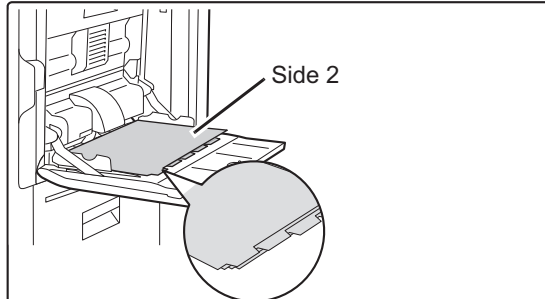

Load the tab paper.

When using the bypass tray

When using the bypass tray, place the paper with the print side down.

Place the paper so that the sides with the tabs enter the machine last.

After loading tab paper into the bypass tray, configure the bypass tray settings as explained in "[MAKING COPIES USING THE BYPASS TRAY \(page 3-31\)](#)".

Tab copying with a left binding

Place the tab paper with the side 2 facing up, and the tab on the first sheet is on the near side.

Tab copying with a right binding

Place the tab paper with the side 2 facing up, and the tab on the first sheet is on the back side.

When using the tray 4

When using the tray 4, place the paper with the print side up. Place the paper so that the sides with the tabs enter the machine last.

After loading tab paper into the tray 4, configure the bypass tray settings as explained in "[LOADING TAB PAPER INTO TRAY 4 \(page 1-21\)](#)".

Tab copying with a left binding

Place the tab paper with the side 1 facing up, and the tab on the first sheet is on the near side.

Tab copying with a right binding

Place the tab paper with the side 1 facing up, and the tab on the first sheet is on the back side.



The width of the tab paper can be as wide as 8-1/2" x 11" paper (8-1/2") plus 5/8" (or A4 width (210 mm) plus 20 mm).

5

Place the original and tap the [Preview] key.

Place the original in the document feeder tray of the automatic document feeder, or on the document glass.

[AUTOMATIC DOCUMENT FEEDER \(page 1-34\)](#)

[DOCUMENT GLASS \(page 1-38\)](#)



To cancel all settings:
Tap the [CA] key.



6

Tap the [Start] key to start copying.



MAKING A POSTER-SIZED COPY (MULTI-PAGE ENLARGEMENT)

This function separately copies an enlarged original image on multiple sheets.

For example, an 8-1/2" x 11" (A4) size original can be enlarged on 8 sheets of 11" x 17" (A3) paper.

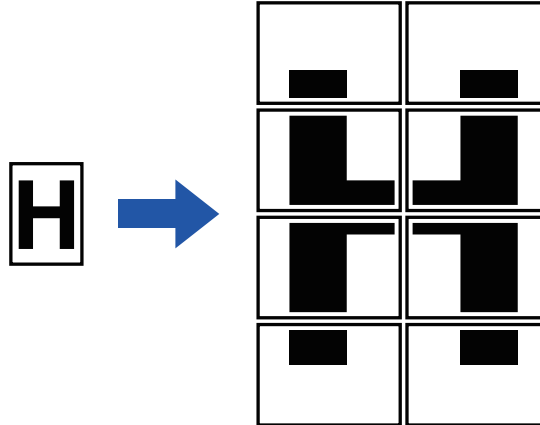

- Multi-Page Enlargement cannot be selected in easy mode.
- You must select Multi-Page Enlargement before scanning the original.
- Place an original on the document glass.
- When Multi-Page Enlargement is selected, the image orientation is changed to vertical.
- Overlap of sections of image
 - There will be a margin around the edges of each copy.
 - Areas for overlapping the copies will be created at the leading and trailing edges of each copy.
- The paper size, number of sheets required for the enlarged image, and the ratio are automatically selected based on the selected original size and enlargement size. (The paper size and ratio cannot be selected manually.)

1

Tap the [Others] key, and tap the [Multi-Page Enlargement] key.

2

Select the [AB] or [Inch] tab to meet the original size for poster-sized copy, and tap the key that meets the original size.

Tapping the key of the original size displays the keys that show the available enlargement size, copy paper size, and number of sheets.



3



Tap the key of the size you want to enlarge the original to.

The image orientation appears.
After the settings are completed, tap [OK] key.



When printing the copy image and margin border, set the [Print Paste Position Mark] checkbox to .



• **To cancel Multi-Page Enlargement setting:**

Tap the [Clear] key.

Even when the multi-page enlargement setting is canceled, the automatically selected ratio is retained.

• **To return the ratio to 100%:**

Tap the [Copy Ratio] key on the base screen to display the ratio menu, and then tap the [100%] key.

4

Place the original on the document glass based on the orientation displayed on the screen.

After the settings are completed, tap [OK] key.

5

Tap the [Start] key to start copying.



COPYING WITH MIRROR IMAGE (MIRROR IMAGE)

This function makes copies by inverting the original into a mirror image.

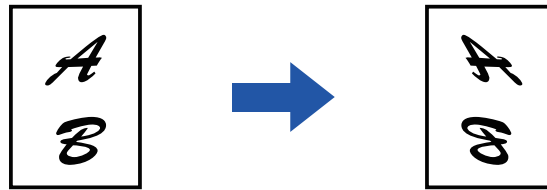

- Mirror Image cannot be selected in easy mode.
- Specify the Mirror Image before scanning an original.

1

Tap the [Others] key, and tap the [Mirror Image] key.

- A checkmark appears on the icon.
- After the settings are completed, tap [OK] key.



To cancel the mirror image setting:
Tap the [Mirror Image] key to uncheck it.

2

Place the original.

Place the original in the document feeder tray of the automatic document feeder, or on the document glass.
[AUTOMATIC DOCUMENT FEEDER \(page 1-34\)](#)
[DOCUMENT GLASS \(page 1-38\)](#)

3

Tap the [Start] key to start copying.



OUTPUT AND DENSITY ADJUSTMENT FUNCTIONS

REVERSING WHITE AND BLACK IN A COPY (B/W REVERSE)

This function reverses black and white in a copy to create a negative image.

Originals with large black areas (which use a large amount of toner) can be copied using Black/White Reverse to reduce toner consumption.

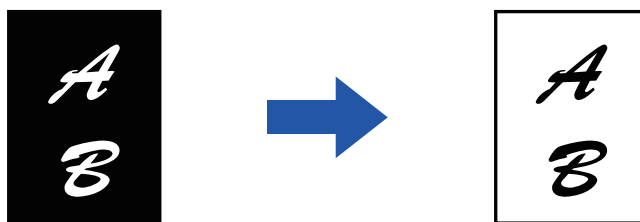

- B/W Reverse cannot be selected in easy mode.
- B/W Reverse must be specified before scanning the original.
- When this function is selected, the "Exposure/Original Type" setting for exposure adjustment automatically changes to "Text".

1

Tap the [Others] key, and tap the [B/W Reverse] key.

A checkmark appears on the icon.
After the settings are completed, tap the [Back] key.



To cancel the B/W reverse setting:
Tap the [B/W Reverse] key to uncheck it.

2

Place the original.

Place the original in the document feeder tray of the automatic document feeder, or on the document glass.
[AUTOMATIC DOCUMENT FEEDER \(page 1-34\)](#)
[DOCUMENT GLASS \(page 1-38\)](#)



To cancel all settings:
Tap the [CA] key.

3

Tap the [Start] key to start copying.



EASY ADJUSTMENT OF THE IMAGE QUALITY (QUICK IMAGE QUALITY ADJUSTMENT)

You can easily adjust the outlines of images and text.



- Quick Image Quality Adjustment cannot be selected in easy mode.
- You must select Quick Image Quality Adjustment before scanning the original.

1

Tap the [Others] key, and tap the [Quick Image Quality Adjustment] key.

2

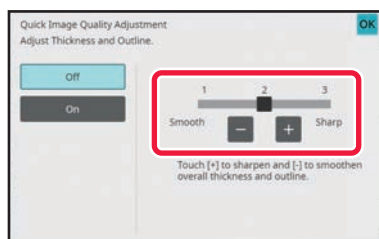

Tap or slide the slider to adjust the image quality.

After the settings are completed, tap [OK] key.



To cancel the quick image quality adjustment setting:
Tap the [Off] key.

3

Place the original.

Place the original in the document feeder tray of the automatic document feeder, or on the document glass.

[AUTOMATIC DOCUMENT FEEDER \(page 1-34\)](#)

[DOCUMENT GLASS \(page 1-38\)](#)



To cancel all settings:
Tap the [CA] key.

4

Tap the [Start] key to start copying.



ADJUSTING THE SHARPNESS OF AN IMAGE (SHARPNESS)

This function adjusts the sharpness to make a sharper or softer image.

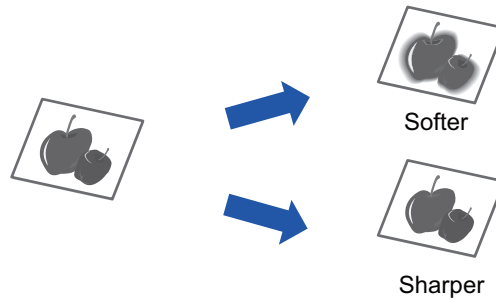

- Sharpness cannot be selected in easy mode.
- Sharpness must be specified before scanning the original.

1

Tap the [Others] key, and tap the [Sharpness] key.

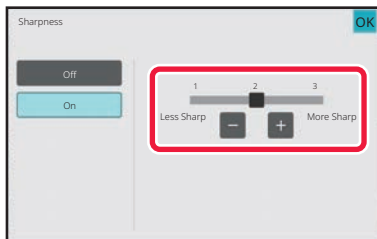
2

Tap **- +** or slide the slider to adjust the sharpness.

Select [More Sharp] for sharper outlines, or [Less Sharp] for softer outlines.

After the settings are completed, tap [OK] key.



To cancel the sharpness setting:
Tap the [Off] key.

3

Place the original.

Place the original in the document feeder tray of the automatic document feeder, or on the document glass.

[AUTOMATIC DOCUMENT FEEDER \(page 1-34\)](#)

[DOCUMENT GLASS \(page 1-38\)](#)



To cancel all settings:
Tap the [CA] key.

4

Tap the [Start] key to start copying.



THE ADJUST DENSITY AREA FOR COPY (GRAY BALANCE)

The density is divided into three ranges, and you can adjust the density of each range. If needed, you can also adjust all three density ranges at once.

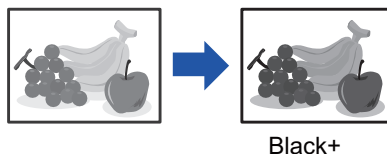

- Gray Balance cannot be selected in easy mode.
- Gray Balance must be specified before scanning the original.

1

Tap the [Others] key, and tap the [Gray Balance] key.

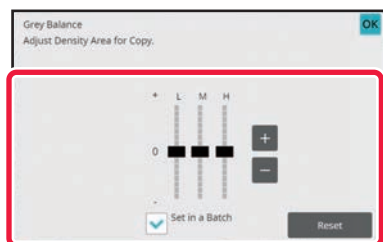
2

Tap the **- +** key or slide the slider to adjust the gray balance.

- To adjust each range, set the [Set in a Batch] checkbox to .
- To adjust a slider individually with the **- +** keys, tap the slider you want to adjust and tap the **- +** keys.
- After the settings are completed, tap [OK] key.



To return the gray balance of the current tab to the default balance:

Tap the [Reset] key.

The values of all gradations currently being adjusted will return to their default gray balance values.

3

Place the original.

Place the original in the document feeder tray of the automatic document feeder, or on the document glass.

[AUTOMATIC DOCUMENT FEEDER \(page 1-34\)](#)

[DOCUMENT GLASS \(page 1-38\)](#)

4

Tap the [Start] key to start copying.



CONVENIENT COPY FUNCTIONS

INTERRUPT COPY

This function suspends a job in progress, and preferentially prints the original specified with interrupt copy. When you need to make an urgent copy and the machine is busy with a long copy run or other job, use interrupt copy.



- The [Interrupt] key does not appear while an original is being scanned.
- Depending on the settings of the job in progress, the [Interrupt] key may not appear.
- Interrupt copy cannot be used in combination with the following functions: Job Build, Tandem Copy, Book Copy, Card Shot, Multi-Page Enlargement, Original Count, Proof Copy, Preview Setting, and Book Divide.
- If you use the document glass for interrupt copy, you cannot select the booklet, covers/inserts function, or N-Up setting. If any of these functions are necessary, use the automatic document feeder.

1

Tap the [Interrupt] key.

The interrupt mode screen appears.



If user authentication is specified:

Tap the [Interrupt] key to display the user authentication screen. Enter the login name and password to perform user authentication.

2

Place the original.

Place the original in the document feeder tray of the automatic document feeder, or on the document glass.

[AUTOMATIC DOCUMENT FEEDER \(page 1-34\)](#)

[DOCUMENT GLASS \(page 1-38\)](#)

3

Configure copy settings.



To cancel interrupt copy, tap the [Cancel] key.

4

Tap the [Start] key to start interrupt copying.

When the interrupt copy job is completed, the interrupted job will resume.



The interrupt copy function does not display the preview of the scanned original.



SEND DATA WHILE COPYING

This function allows you to send a fax while making a copy, send an e-mail with an image attached, or save data in the network folder.



You need to store the destination in the address book in advance.

[STORING ADDRESSES THROUGH DIRECT ENTRY \(page 6-19\)](#)

The fax and image send transmission starts after the copy, and the settings same as the copy are used for transmission. However, the same results as the copy may not be provided by some functions.

1

Tap the [Detail] key to change to normal mode.

[EASY MODE \(page 3-3\)](#)

2

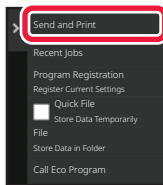

Tap [Send and Print] on the action panel.

3

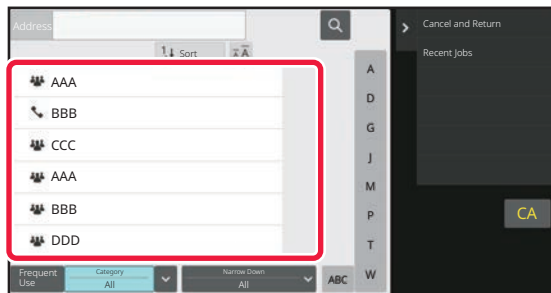

Select a recipient from the address book.

[SELECTING "Contacts" OR "Group" \(page 6-16\)](#)

After you have selected the recipient, tap the [Enter Address] key.



- You cannot use the soft keyboard to enter an address. If you cannot find the recipient in the address book, enter it in the address book.
- An Internet Fax address cannot be selected.

4

Place the original.

Place the original in the document feeder tray of the automatic document feeder, or on the document glass.

[AUTOMATIC DOCUMENT FEEDER \(page 1-34\)](#)

[DOCUMENT GLASS \(page 1-38\)](#)



5

Set each copy item as required.

These copy settings are used for fax transmission. However, some settings may be unavailable depending on the function.



You can preview the scanned original by tapping the [Preview] key.

6

Tap the [Start] key to start copying.

After the copy, the transmission starts.



After the copy, you cannot preview the settings before transmission.

COPY JOBS

When you tap the job status display, jobs are displayed in a list. To check the status of a copy job, tap the [Print] tab. When you wish to stop or delete jobs or to perform priority processing, read "[STOPPING/DELETING A JOB, PRIORITY PROCESSING AND CHECKING THE STATUS \(page 2-52\)](#)".





PROGRAMS

Programs are set from the base screen of normal mode.

[EASY MODE \(page 3-3\)](#)



Programs cannot be stored in easy mode.

STORING A PROGRAM

This function collectively stores copy settings as one program. The stored program can be retrieved using an easy operation.

For information about how to retrieve a program, see "[RETRIEVING A PROGRAM \(page 3-142\)](#)".

For example, suppose 11" x 17" (A3) size CAD drawings are copied once a month for archive purposes using the following settings:

- The 11" x 17" (A3) size CAD drawings are reduced to 8-1/2" x 11" (A4) size.
- To reduce paper use by half, 2-sided copying is used.
- Margin shift is used to allow a margin to punch holes for filing.

11" x 17" (A3) size CAD drawings

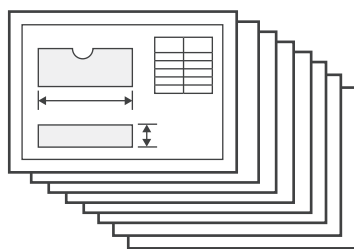

Copy

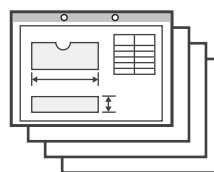



When a job program is not stored	When a job program is stored
<p>Set reduction from 11" x 17" (A3) to 8-1/2" x 11" (A4)</p> <p>↓</p> <p>Change the exposure setting.</p> <p>↓</p> <p>Set 2-sided copying.</p> <p>↓</p> <p>Set margins.</p> <p>↓</p> <p>Set punch hole settings.</p> <p>↓</p> <p>Tap the [Start] key.</p>	<p>Retrieve the stored program.</p> <p>↓</p> <p>Tap the [Start] key.</p>
<p>Considerable time is required to copy the drawings each month because the above settings must be selected. In addition, mistakes are occasionally made when selecting the settings, so some copies must be redone.</p>	<p>The settings are stored in a program, so they can be selected by the touch of a key. This is simple and takes no time. In addition, the settings are all stored so there are no chances for mistakes, and thus no need to redo copies due to setting mistakes.</p>



- Up to 48 programs can be stored.
- Program settings remains registered even when the main power has been turned off.
- A program can also be stored in the home screen or favorite as a shortcut; therefore, it is helpful when retrieving it.

1

Specify the copy function to be stored.



In the base screen, display [Program Registration] on the action panel.

2

Tap [Program Registration] on the action panel.

3

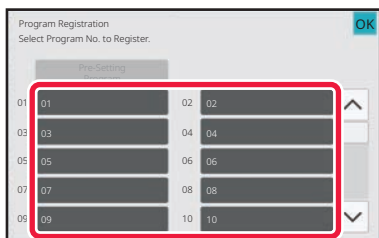

Tap an unused key.

A key with a program stored is displayed in color. Tap a key with no program stored.



If you do not set a name for the program, a serial number will be automatically assigned as the name.



4

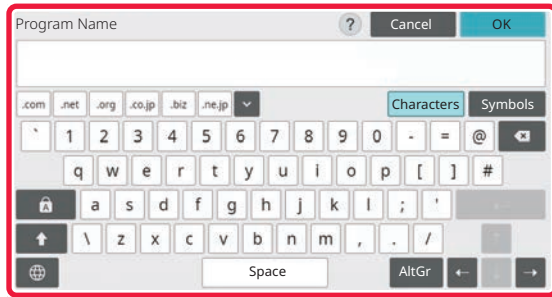

Set a name for the program and tap the [OK] key.

A registration completion message appears.

5

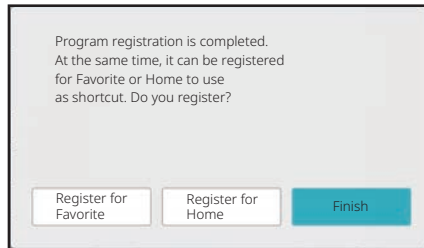

Select whether or not the program will be added to the home screen or the favorites.

To specify print settings, you can select the required one from pre-set text or use the soft keyboard. You can also print serial number and account job ID.

When you have completed the settings, tap [OK] and the [Back] keys in sequence.



- If user authentication is enabled, the shortcut key for the program is registered in the user's home screen or favorite.
- If user authentication is disabled, the administrator password entry screen appears. When the administrator password is entered, the registration is completed.
- The number of copies cannot be stored.

RETRIEVING A PROGRAM

1

Tap [Call Program] on the action panel.

2

Tap the key of the program you want to retrieve.



You can tap [Register in Favorite] or [Register for Home] on the action panel to register a shortcut key for the selected program in the favorite or home screen.



DELETING AND RENAMING A PROGRAM

This section explains how to delete copy settings in a program and rename a program.



A program that is already stored cannot be deleted.

Deleting a program

1

Tap [Call Program] on the action panel.

2

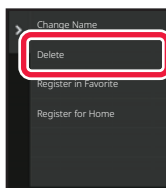

Tap [Delete] on the action panel.

3

Tap the key of the program you want to delete, and tap [Delete].

Renaming a program

1

Tap [Call Program] on the action panel.

2

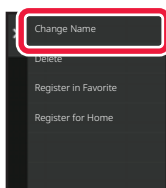

Tap [Change Name] on the action panel.

3

Tap the key of the required program, and rename the program. Then tap the [OK] key.

After the settings are completed, tap [OK] key.



PRINTER

PRINTER FUNCTION OF THE MACHINE

PRINTER FUNCTION	4-3
WINDOWS ENVIRONMENT	4-3
macOS ENVIRONMENT	4-3

PRINTING IN A WINDOWS ENVIRONMENT

BASIC PRINTING PROCEDURE	4-4
PRINTER DRIVER SETTINGS SCREEN / REFERRING TO HELP	4-6
SELECTING THE PAPER	4-7
PRINTING WHEN THE USER AUTHENTICATION FUNCTION IS ENABLED	4-8
FREQUENTLY USED FUNCTIONS	4-10
SAVING SETTINGS AT THE TIME OF PRINTING	4-10
USING SAVED SETTINGS	4-11
CHANGING THE PRINTER DRIVER DEFAULT SETTINGS	4-12
SHARE FAVORITE SETTINGS BETWEEN SERVER AND CLIENT	4-13

PRINTING IN A macOS ENVIRONMENT

BASIC PRINTING PROCEDURE	4-14
SELECTING THE PAPER	4-15
PRINTING WHEN THE USER AUTHENTICATION FUNCTION IS ENABLED	4-16

FREQUENTLY USED FUNCTIONS

SELECTING THE RESOLUTION	4-18
2-SIDED PRINTING	4-19
FITTING THE PRINT IMAGE TO THE PAPER	4-21
PRINTING MULTIPLE PAGES ON ONE PAGE	4-23
PRINTING WHILE SKIPPING BLANK PAGES	4-25
STAPLING OUTPUT/PUNCHING HOLES IN OUTPUT	4-26
STAPLE FUNCTION	4-26
PUNCH FUNCTION	4-26

CONVENIENT PRINTING FUNCTIONS

CONVENIENT FUNCTIONS FOR CREATING PAMPHLETS AND POSTERS	4-29
CREATE A PAMPHLET (BOOKLET/SADDLE STITCH)	4-29
TRIMMING THE EXCESS OF FOLDED PAPER	4-31
PRINTING WITH MARGIN SHIFT SETTING (MARGIN)	4-33
CREATE A LARGE POSTER (POSTER PRINTING)	4-35
FUNCTIONS TO ADJUST THE SIZE AND ORIENTATION OF THE IMAGE	4-36
ADJUST PRINT POSITION ON ODD AND EVEN PAGES SEPARATELY (PRINT POSITION)	4-36
ROTATING THE PRINT IMAGE 180 DEGREES (ROTATE 180 DEGREES)	4-37
ENLARGING/REDUCING THE PRINT IMAGE (ZOOM SETTING/ENLARGE OR REDUCE)	4-38
ADJUST THE LINE THICKNESS (WIDTH)	4-40
PRINT A MIRROR-IMAGE (MIRROR-IMAGE REVERSE/VISUAL EFFECTS)	4-44
IMAGE MODE ADJUSTING FUNCTION	4-45
ADJUST THE BRIGHTNESS AND CONTRAST OF THE IMAGE (IMAGE ADJUSTMENT)	4-45
PRINTING FAINT TEXT AND LINES IN BLACK (TEXT TO BLACK/VECTOR TO BLACK)	4-46
SELECTING IMAGE SETTINGS TO MATCH THE IMAGE TYPE	4-47
FUNCTIONS TO COMBINE TEXT AND IMAGES	4-49
ADDING A WATERMARK TO PRINTED PAGES (WATERMARK)	4-49
PRINTING AN IMAGE OVER THE PRINT DATA (IMAGE STAMP)	4-51
REGISTERING A CUSTOM IMAGE	4-52
OVERLAY A FIXED FORM ON THE PRINT DATA (OVERLAYS)	4-53
ADDING THE NUMBER OF COPIES (COPIES STAMP)	4-55
PRINT FUNCTIONS FOR SPECIAL PURPOSES	4-56
PRINTING SPECIFIC PAGES ON DIFFERENT PAPER (DIFFERENT PAPER)	4-56
ADDING INSERTS WHEN PRINTING ON TRANSPARENCY FILM (TRANSPARENCY INSERTS)	4-59
INSERTING SEPARATOR PAGES BETWEEN JOBS OR COPIES	4-62
PRINTING A CARBON COPY (CARBON COPY)	4-63
PRINTING TEXT ON TABS OF TAB PAPER (TAB SHIFT/TAB PAPER PRINT)	4-64
TWO-SIDED PRINTING WITH SPECIFIC PAGES PRINTED ON THE FRONT SIDE (CHAPTER INSERTS)	4-67
FOLDING PAPER FOR PRINTING (FOLD)	4-68





INSERT PRESET DATA BEFORE OR AFTER EACH PAGE (PAGE INTERLEAVE)..... 4-74

PRINT THE SAME IMAGE IN TILE PATTERN (REPEAT PRINT)..... 4-75

PRINTING PATTERN DATA (HIDDEN PATTERN PRINT)..... 4-76

CHANGING THE RENDERING METHOD AND PRINTING JPEG IMAGES (USE DRIVER TO RENDER JPEGS)..... 4-78

MAXIMIZING THE PRINT AREA ON THE PAPER (PRINT AREA)..... 4-79

CONVENIENT PRINTER FUNCTIONS..... 4-80

 USING TWO MACHINES TO PRINT A LARGE PRINT JOB (TANDEM PRINT)..... 4-80

 SAVING AND USING PRINT FILES (DOCUMENT FILING)..... 4-81

 AUTOMATICALLY PRINT ALL STORED DATA..... 4-84

 PRINTING AND SENDING SIMULTANEOUSLY..... 4-85

PRINTING WITHOUT THE PRINTER DRIVER

EXTENSION OF PRINTABLE FILES..... 4-86

DIRECTLY PRINTING A FILE ON AN FTP SERVER..... 4-86

DIRECTLY PRINTING A FILE IN USB MEMORY..... 4-88

DIRECTLY PRINTING A FILE IN A NETWORK FOLDER..... 4-89

DIRECTLY PRINTING FROM A COMPUTER..... 4-93

 SUBMIT PRINT JOB..... 4-93

 FTP PRINT..... 4-94

 E-MAIL PRINT..... 4-94

Universal Print..... 4-96

 BEFORE CONNECTING THE Universal Print SERVICE..... 4-96

Universal Print Settings..... 4-97

 REGISTERING THE MACHINE WITH Azure Active Directory... 4-97

 REGISTERING THE MACHINE WITH EACH CLIENT PC. 4-97

 DELETE FROM Azure Active Directory..... 4-97

PRINTER JOBS

CHECKING THE PRINT STATUS..... 4-98

PRINTING AN ENCRYPTED PDF FILE..... 4-98

CHANGING TO ANOTHER PAPER SIZE AND PRINTING WHEN PAPER RUNS OUT..... 4-99

PRINT RELEASE FUNCTION

PRINT RELEASE FUNCTION..... 4-100

 INTER-GROUP PRINTING..... 4-100

BEFORE USING THE PRINT RELEASE FUNCTION.... 4-101

 SETTINGS REQUIRED ON THE MACHINE..... 4-101

 INSTALLING THE PRINTER DRIVER OF THE PRIMARY UNIT..... 4-102

USING THE PRINT RELEASE FUNCTION..... 4-102

 STORING A JOB IN THE PRIMARY UNIT FROM YOUR COMPUTER..... 4-102

 PRINTING/DELETING A JOB STORED IN THE PRIMARY UNIT FROM A SECONDARY UNIT..... 4-104

APPENDIX

PRINTER DRIVER SPECIFICATIONS LIST..... 4-105

SPECIFYING A BILLING CODE USING THE PRINTER DRIVER..... 4-109

 ENABLE BILLING CODE..... 4-109

AUTHENTICATION BY SINGLE SIGN-ON..... 4-111

 Settings..... 4-111



PRINTER FUNCTION OF THE MACHINE

PRINTER FUNCTION

To enable printing from your computer, a printer driver must be installed.
See the table below to determine which printer driver to use in your environment.

WINDOWS ENVIRONMENT

Printer driver type
PCL6 The machine support the Hewlett-Packard PCL6 printer control languages.
PS <ul style="list-style-type: none">• This printer driver supports the PostScript 3 page description language developed by Adobe.• If it is desired to use the Windows standard PS printer driver, the PPD driver must be used.



- To install the printer driver and configure settings in a Windows environment, see the Software Setup Guide.
- The User's Manual mainly uses PCL6 printer driver screens to explain how to print in a Windows environment. The printer driver screens may differ slightly depending on the printer driver you are using.

macOS ENVIRONMENT

Printer driver type
PS PS This printer driver supports the PostScript 3 page description language developed by Adobe and uses a PPD file.



- To install the printer driver and configure settings in a macOS environment, see the Software Setup Guide.
- The explanations of screens and procedures for use in a macOS environment generally assume that macOS 11 is being used and a PPD driver is installed. The screens may be different depending on the version of the operating system or the software application.



If a notice page is printed

- If a print job cannot be printed as specified and the reason is not shown on the operation panel, a notice page indicating the reason will print. Read the message and take appropriate action. For example, a notice page will print if the following occurs:
 - There is more print data than can be held in memory.
 - You selected a function that has been prohibited by the administrator.



PRINTING IN A WINDOWS ENVIRONMENT

BASIC PRINTING PROCEDURE

The following example explains how to print a document from "WordPad", which is a standard accessory application in Windows.



- The menu used to execute printing may vary depending on the application.
- The button that is used to open the printer driver properties window (usually [Property] or [Preferences]) may vary depending on the application.
- The machine name that normally appears in the [Printer] menu is [BP-xxxxx]. ("xxxxx" is a sequence of characters that varies depending on the machine model.)

1

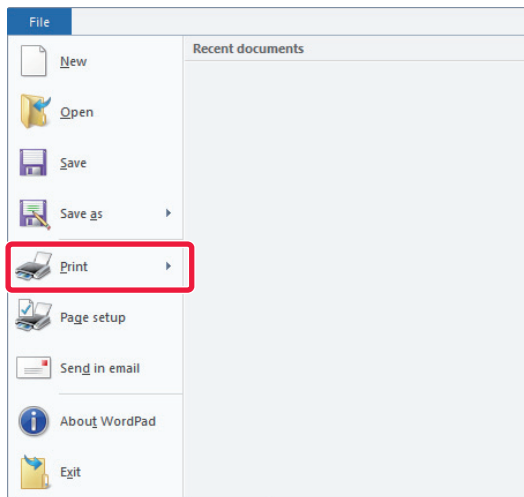

Select [Print] from the [File] menu of WordPad.

2

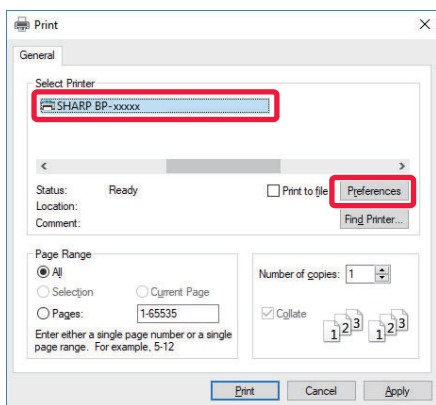

Select the printer driver for the machine and click the [Preferences] button.

The button that is used to open the printer driver properties window (usually [Property] or [Preferences]) may vary depending on the application.



3

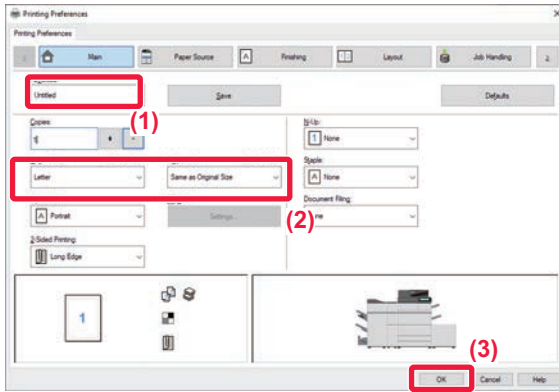

Select print settings.

(1) Click the [Main] tab.

(2) Select the original size.

- You can register up to seven user-defined sizes in the menu. To store an original size, select [Custom Paper] or one of [User1] to [User7] from the menu, and click the [OK] button.

To select settings on other tabs, click the desired tab and then select the settings.

[PRINTER DRIVER SETTINGS SCREEN / REFERRING TO HELP \(page 4-6\)](#)

- If an original size larger than the largest paper size that the machine supports is set, select the paper size for printing in "Output Size".
- If an "Output Size" different from the "Original Size" is selected, the print image will be adjusted to match the selected paper size.

(3) Click the [OK] button.

4

Click the [Print] button.

Printing begins.



PRINTER DRIVER SETTINGS SCREEN / REFERRING TO HELP

The printer driver settings screen consists of 9 tabs. Click a tab to select the settings on that tab.

You can check information on each of the settings in the Help screen. Click the [Help] button at the bottom right of the screen.

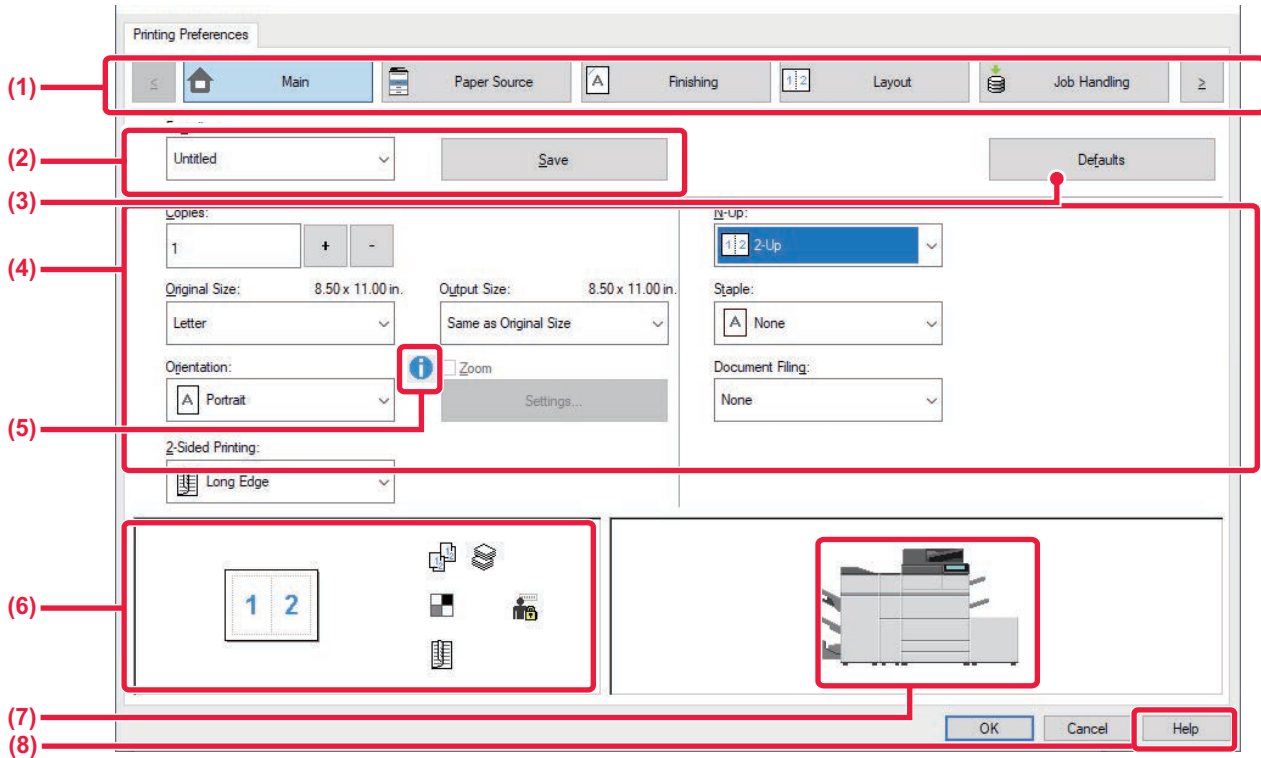

(1) Tabs: Click to change the tabs shown.

- [Main]: Frequently used functions are grouped on this tab. The settings are also on other tabs, and each setting on this tab is linked to the corresponding setting on the other tab.
- [Paper Source]: Set the size and type of paper used for printing, and the paper tray.
- [Finishing]: Select a finishing function such as stapling, punch, or folding, and set the output tray.
- [Layout]: Select functions related to the layout such as two-sided printing and booklet.
- [Job Handling]: Set Document Filing and user authentication.
- [Inserts]: Select insertion functions such as covers, inserts, and tab paper.
- [Stamp]: Select the watermark or stamp function.
- [Image Quality]: Select various image quality settings.
- [Detailed Settings]: Select tandem print and other detailed print settings.

(2) Favorites

Settings configured on each tab at the time of printing can be saved as Favorite.
[FREQUENTLY USED FUNCTIONS \(page 4-10\)](#)

(3) Defaults

Return the settings on the currently selected tab to their default state.

(4) Setup Items

Displays the settings on each tab.

(5) Information icon()

Some restrictions exist on the combinations of settings that can be selected in the printer driver properties window. When a restriction exists on a selected setting, an information icon () will appear next to the setting. Click the icon to view an explanation of the restriction.



(6) Print image

This lets you visually check how the current settings affect the print image. Finishing settings are indicated by icons.

(7) Machine image

This shows the options that are installed on the machine, and the paper trays and output trays that are used.

(8) [Help] button

Displays the Help window of the printer driver.



- Help can be displayed for a setting by clicking the setting and pressing the [F1] key.
- You can click the  button in the upper right corner of the settings screen and then click a setting to show Help for that setting in a sub-window.

SELECTING THE PAPER

Before printing, check the paper sizes, paper types, and paper remaining in the machine's trays. To check the most recent tray information, click the [Tray Status] button in the [Paper Source] tab.

The "Output Size" setting and the "Paper Tray" setting are related as follows:

• **When "Paper Tray" is set to [Auto Select]**

The tray that contains paper of the size and type selected in "Output Size" and "Paper Type" is automatically selected.

• **When "Paper Tray" is set to any setting other than [Auto Select]**

The specified tray is used for printing regardless of the "Output Size" setting.

When you have set "Paper Type" to [Bypass Tray], be sure to select "Paper Type". Check the paper type that is set for the bypass tray of the machine, check that paper of that type is actually loaded into the bypass tray, and then select the appropriate paper type.

• **When "Paper Type" is set to [Auto Select]**

A tray with plain paper or recycled paper of the size specified in "Output Size" is automatically selected. (The factory default setting is plain paper 1 only.)

• **When "Paper Type" is set to anything other than [Auto Select]**

A tray with the specified type of paper and the size specified in "Output Size" is used for printing.



Special media can also be placed in the bypass tray.

For the procedure for loading paper in the bypass tray, see "[LOADING PAPER INTO THE BYPASS TRAY \(page 1-28\)](#)".



When [Enable Detected Paper Size in Bypass Tray] (disabled by factory default) or [Enable Selected Paper Type in Bypass Tray] (enabled by factory default), which you can reach by selecting [System Settings] in "Settings (administrator)" → [Printer Settings] → [Condition Settings] → [Bypass Tray Settings] is enabled, printing will not take place if the paper size or paper type specified in the printer driver is different from the paper size or paper type specified in the settings of the bypass tray.



PRINTING WHEN THE USER AUTHENTICATION FUNCTION IS ENABLED

The user information (such as login name and password) that must be entered varies depending on the authentication method being used, so check with the administrator of the machine before printing.



- If you have configured "Printing Policy" on the [Configuration] tab so that user authentication is always performed, users are required to be authenticated for each print job. This is done by entering authentication information in a dialog box that appears each time printing is performed.
- The machine's user authentication function cannot be used when the PPD driver* is installed and the Windows standard PS printer driver is used.
For this reason, the machine can be configured to prohibit users from executing printing unless their user information is stored in the machine.
* The PPD driver enables the machine to print using the Windows standard PS printer driver.

1

In the printer driver properties window of the application, select the printer driver of the machine and click the [Preferences] button.



The button that is used to open the printer driver properties window (usually [Property] or [Preferences]) may vary depending on the application.



2

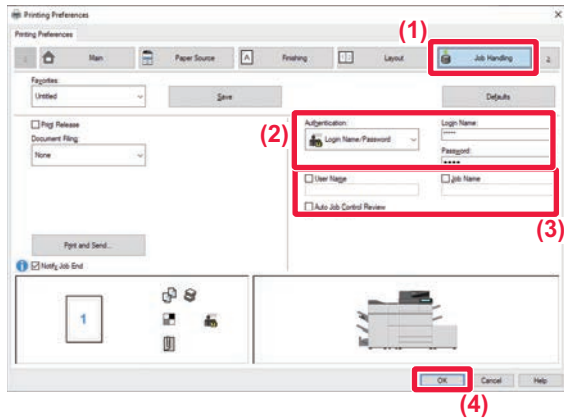

Enter your user information.

(1) Click the [Job Handling] tab.

(2) Enter your user information.

- When authentication is performed by login name, select [Login Name] and enter your login name.
- When authentication is performed by login name/password, click [Login Name/Password] and enter your login name and password. Enter the password using 1 to 32 characters
- When the machine's authentication destination is Active Directory, [Single Sign-on] can be selected. For information on single sign-on, refer to "[AUTHENTICATION BY SINGLE SIGN-ON \(page 4-111\)](#)".
- When authentication is performed by user number, select [User Number] and enter your 5 to 8 digit user number.

(3) Enter the user name and job name as necessary.

- Click the [User Name] checkbox, and enter your user name using up to 32 characters. The entered user name will appear on the touch panel of the machine. If you do not enter a user name, your PC login name will appear.
- Click the [Job Name] checkbox, and enter a job name using up to 30 characters. The entered job name will appear as a file name on the touch panel of the machine. If you do not enter a job name, the file name set in the application will appear.
- To have a confirmation window appear before printing starts, select the [Auto Job Control Review] checkbox.

(4) Click the [OK] button to execute printing.



Authentication by Single Sign-on requires that Active Directory authentication be performed on the machine and your computer. This can only be used when your computer is running Windows.



FREQUENTLY USED FUNCTIONS

SAVING SETTINGS AT THE TIME OF PRINTING

Settings configured on each of the tabs at the time of printing can be saved as Favorite. Saving frequently used settings or complex settings under an assigned name makes it easy to select those settings the next time you need to use them. Settings can be saved from any tab of the printer driver properties window. Settings configured on each tab are listed at the time of saving, allowing you to check the settings as you save them.



Deleting saved settings

In step 2 of "[USING SAVED SETTINGS \(page 4-11\)](#)", select the user settings that you want to delete and click the [Delete] button.

1

Select the machine's printer driver from the print window of the application, and click the [Preferences] button.



The button that is used to open the printer driver properties window (usually [Property] or [Preferences]) may vary depending on the application.

2

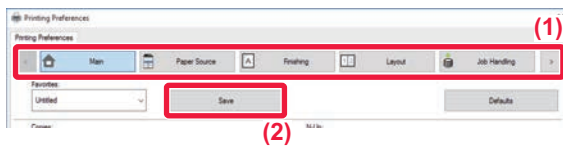

Register Print Settings.

- (1) Configure the print settings on each tab.
- (2) Click the [Save] button.

3

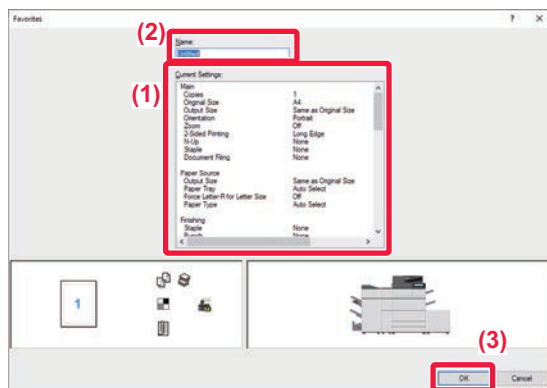

Check and save the settings.

- (1) Check the displayed settings.
- (2) Enter a name for the settings using up to 20 characters.
- (3) Click the [OK] button.



USING SAVED SETTINGS

You can specify the saved favorites through just one click to apply frequently used settings or complicated settings to your printing.

1

Select the machine's printer driver from the print window of the application, and click the [Preferences] button.



The button that is used to open the printer driver properties window (usually [Property] or [Preferences]) may vary depending on the application.

2

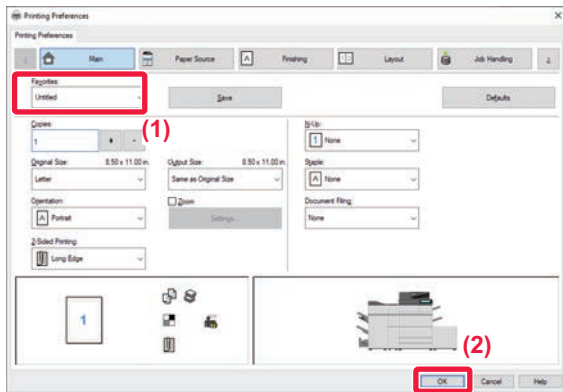

Select favorite settings.

(1) Select the favorite settings you want to use.

(2) Click the [OK] button.

3

Start printing.



CHANGING THE PRINTER DRIVER DEFAULT SETTINGS

You can change the default settings of the printer driver.

Changes you have made in the printer driver properties window when you execute printing from the application are returned to the default settings specified here when you exit the application.

1

Click the [Start] button, select [Settings] → [Device] → [Printers & scanners].



- In Windows 11, click the [Start] button, select [Bluetooth & devices] → [Printers & scanners].
- In Windows 8.1/Windows Server 2012, right-click the [Start] button, select [Control Panel] → [View devices and printers] (or [Devices and Printers]).

2



Click the printer driver name of the machine and click [Manage].

3

Click [Start].

4

Configure the settings and click the [OK] button.

For explanations of the settings, see printer driver Help.



SHARE FAVORITE SETTINGS BETWEEN SERVER AND CLIENT

When using this machine as a shared printer, if "Favorite" is set in the printer driver of the shared server, this setting can also be used on the shared destination computer.

When "Share Favorites" is enabled...

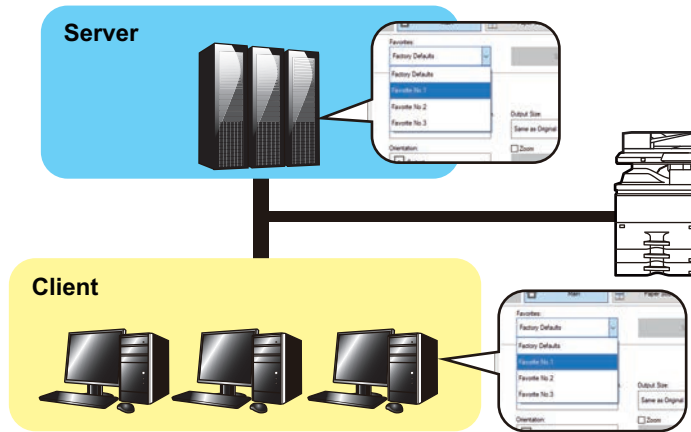

The favorite settings configured on the server can be used on the client computer. Configure the following settings in the printer driver of the shared server.

1

Click the [Start] button, select [Settings] → [Device] → [Printers & scanners].



- In Windows 11, click the [Start] button, select [Bluetooth & devices] → [Printers & scanners].
- In Windows 8.1/Windows Server 2012, right-click the [Start] button, select [Control Panel] → [View devices and printers] (or [Devices and Printers]).

2

Click the printer driver name of the machine and click [Manage].

3

Click [Printer Properties].

4

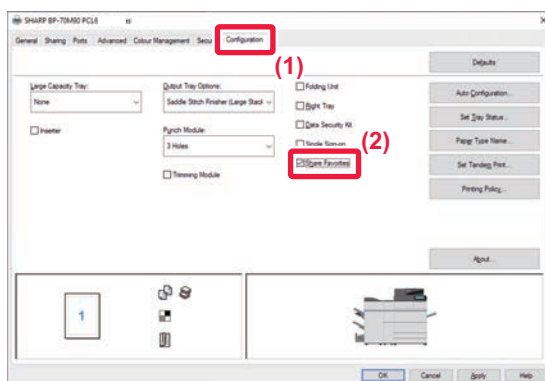

Configure the sharing settings.

- (1) Click the [Configuration] tab.
- (2) Set the [Share Favorites] check box to ,



PRINTING IN A macOS ENVIRONMENT

BASIC PRINTING PROCEDURE

The following example explains how to print a document from the standard accessory application "TextEdit" in macOS.



- To install the printer driver and configure settings in a macOS environment, see the Software Setup Guide.
- The explanations of screens and procedures for use in a macOS environment generally assume that macOS 11 is being used and a PPD driver is installed. The screens may be different depending on the version of the operating system or the software application.
- The menu used to execute printing may vary depending on the application.

1

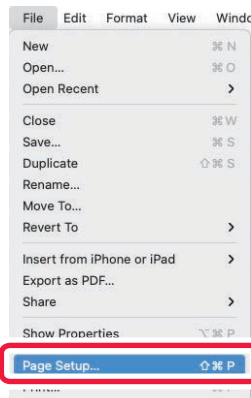

Select [Page Setup] from the [File] menu and select the printer.

If the printer drivers appear as a list, select the name of the printer driver to be used from the list.

2

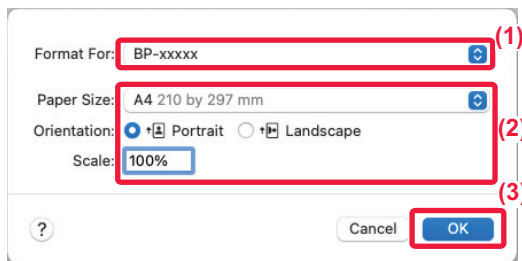

Select paper settings.

(1) Make sure that the correct printer is selected.

(2) Select paper settings.

Paper size, paper orientation, and enlarge/reduce settings can be selected.

(3) Click the [OK] button.

3

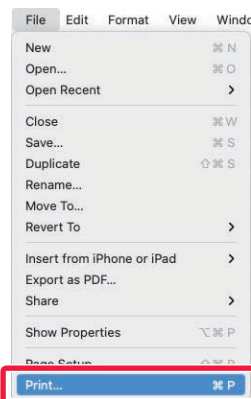

Select [Print] from the [File] menu.



4

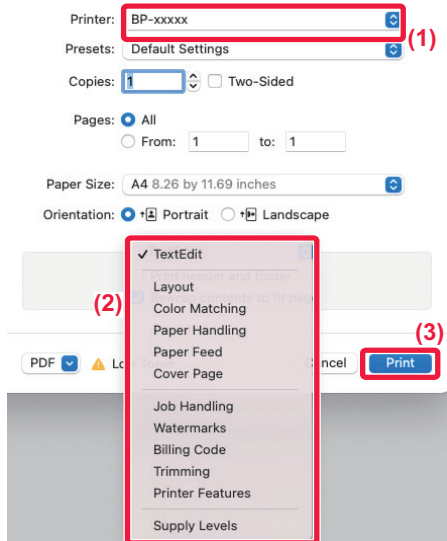

Select print settings.

- (1) Make sure that the correct printer is selected.
- (2) Select an item from the menu and configure the settings as needed.
- (3) Click the [Print] button.

SELECTING THE PAPER

This section explains the [Paper Feed] settings in the print settings window.

• **When [Auto Select] is selected:**

A tray that is set for plain or recycled paper (only plain paper 1 in the factory default setting) of the size specified in "Paper Size" on the page setup screen is automatically selected.

• **When a paper tray is specified:**

The specified tray is used for printing regardless of the "Paper Size" setting on the page setup screen.

For the bypass tray, also specify the paper type. Check that the paper type that is set for the bypass tray of the machine, check that paper of that type is actually loaded into the bypass tray, and then select the appropriate bypass tray (paper type).

• **When a paper type is specified:**

A tray with the specified type of paper and the size specified in "Paper Size" on the page setup screen is used for printing.



Special media can also be placed in the bypass tray.

For the procedure for loading paper in the bypass tray, see "[LOADING PAPER INTO THE BYPASS TRAY \(page 1-28\)](#)".



When [Enable Detected Paper Size in Bypass Tray] (disabled by factory default) or [Enable Selected Paper Type in Bypass Tray] (enabled by factory default), which you can reach by selecting [System Settings] in "Settings (administrator)" → [Printer Settings] → [Condition Settings] → [Bypass Tray Settings] is enabled, printing will not take place if the paper size or paper type specified in the printer driver is different from the paper size or paper type specified in the settings of the bypass tray.



PRINTING WHEN THE USER AUTHENTICATION FUNCTION IS ENABLED

The user information (such as login name and password) that must be entered varies depending on the authentication method being used, so check with the administrator of the machine before printing.



The menu used to execute printing may vary depending on the application.

1

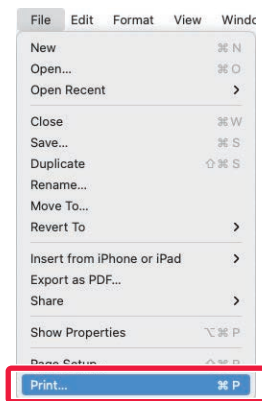

In the application, select [Print] from the [File] menu.



2

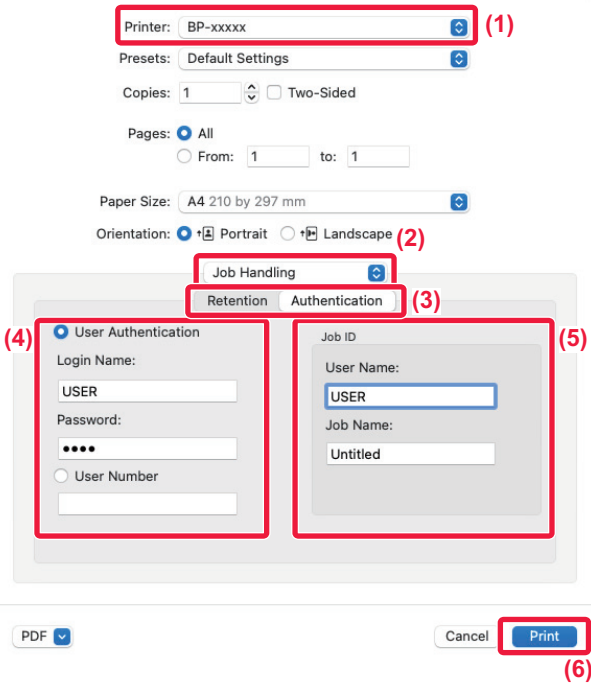

Enter your user information.

(1) Make sure that the machine's printer name is selected.

(2) Select [Job Handling].

(3) Click the [Authentication] tab.

(4) Enter your user information.

- When authentication is carried out using the login name/password, enter your login name in "Login Name" and your password (1 to 32 characters) in "Password".
- When authentication is carried out using the user number, enter your user number (5 to 8 digits) in "User Number".

(5) Enter the user name and job name as necessary.

- **User Name**
Enter your user name using up to 32 characters. The entered user name will appear on the touch panel of the machine. If you do not enter a user name, your PC login name will appear.
- **Job Name**
Enter a job name using up to 32 characters. The entered job name will appear as a file name on the touch panel of the machine. If you do not enter a job name, the file name set in the application will appear.

(6) Click the [Print] button.



FREQUENTLY USED FUNCTIONS

SELECTING THE RESOLUTION

The following three selections are available for "Print Mode" (resolution):

600 dpi	This mode is suitable for printing data such as regular text or a table.
600 dpi (High Quality)	The print quality of photos and text are high.
1200 dpi	Select this mode to print photos with higher definition, and to print fine lines clearly.

Windows

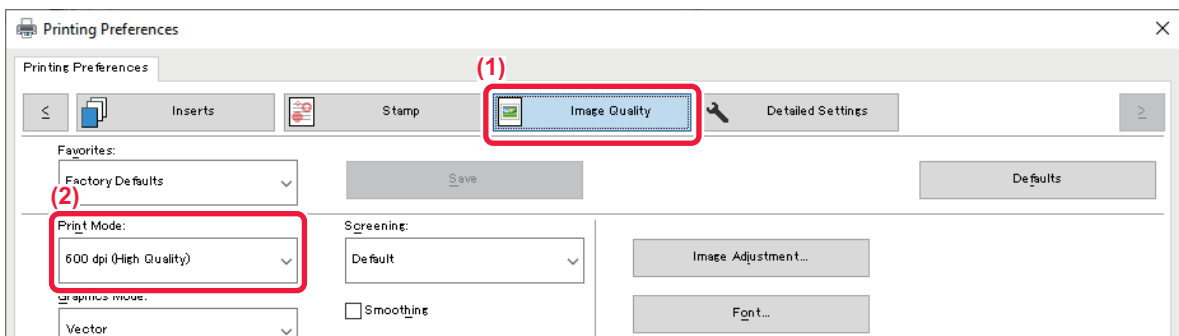

- (1) Click the [Image Quality] tab.
- (2) Select "Print Mode".

macOS

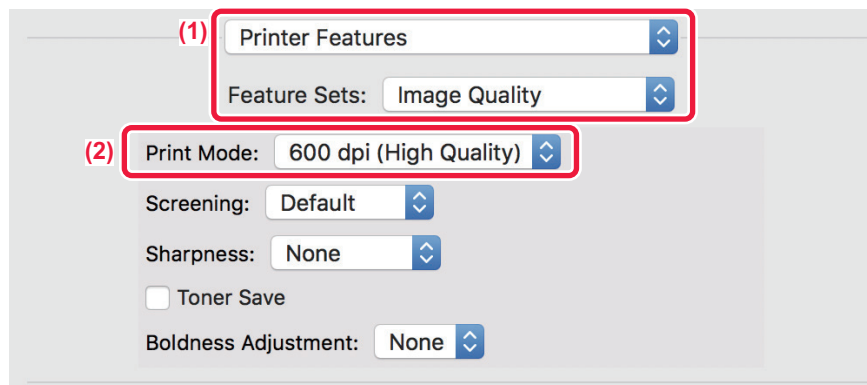



- (1) Select [Printer Features] and then select [Image Quality].
- (2) Select "Print Mode".

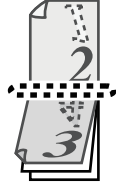

2-SIDED PRINTING

The machine can print on both sides of the paper. This function is useful for many purposes, and is particularly convenient when you want to create a simple pamphlet. 2-sided printing also helps conserve paper.

Paper orientation	Print results	
	Long Edge	Short Edge
		
Landscape	Short Edge	Long Edge
		
	The pages are printed so that they can be bound at the left or right side.	The pages are printed so that they can be bound at the top.

Windows

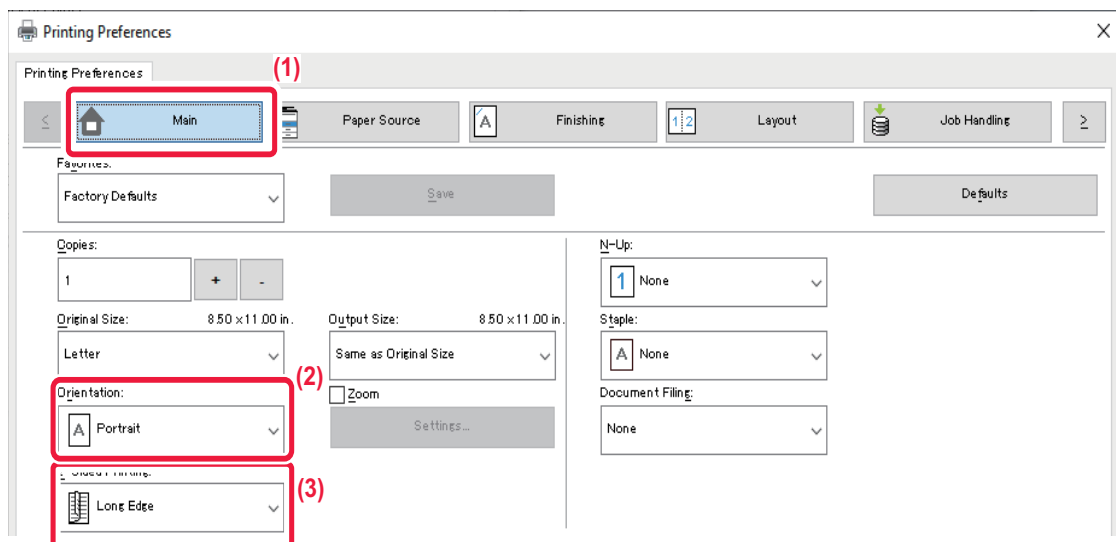

- (1) Click the [Main] tab.
- (2) Select the paper orientation.
- (3) Select [Long Edge] or [Short Edge].



If necessary, you can select the method of implementing 2-sided printing. Click the [Other Settings] button on the [Detailed Settings] tab, and select the mode from "Duplex Style".



macOS

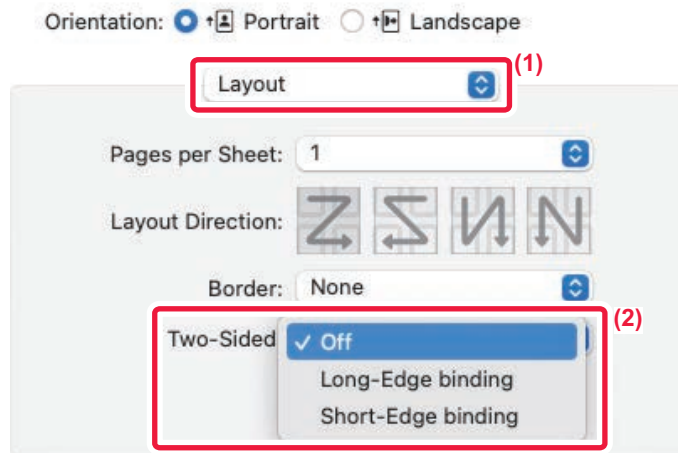

(1) Select [Layout].

(2) Select [Long-Edge binding] or [Short-Edge binding].



FITTING THE PRINT IMAGE TO THE PAPER

This function automatically enlarges or reduces the print image to match the size of the paper loaded in the machine. This function is convenient when enlarging a letter or A4 size document to ledger or A3 size to make it easier to view, or when printing a document on paper that is different in size from the original document.

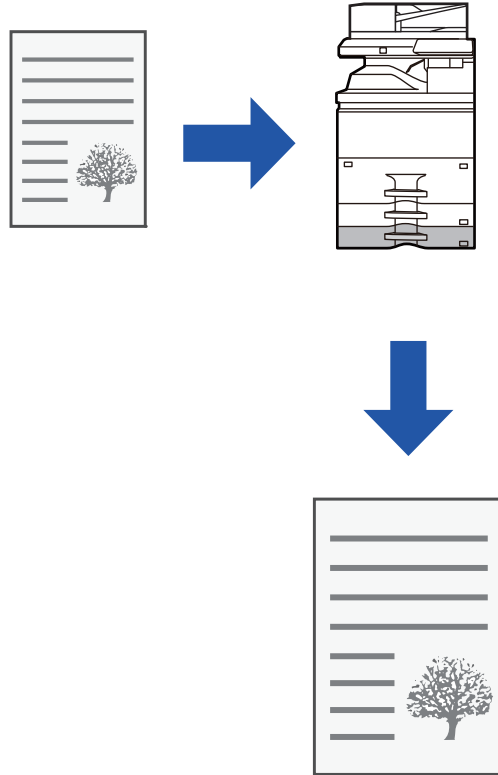

The following example explains how to print a Letter (or A4) size document on A3 (or ledger) size paper.

Windows

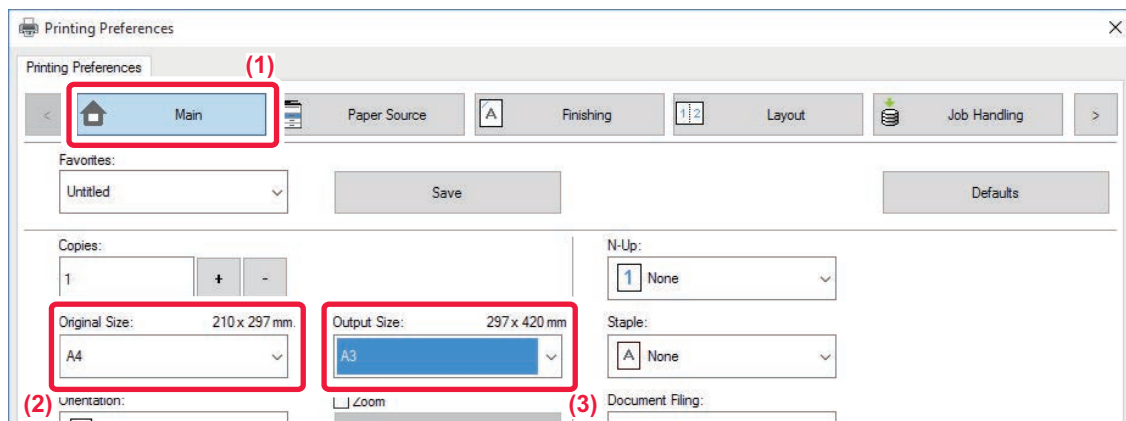

- (1) Click the [Main] tab.
- (2) Select the original size from [Original Size] (for example: A4).
- (3) Select the actual paper size to be used for printing from [Output Size] (for example: A3).

If the output size is larger than the original size, the printed image will be automatically enlarged.



If A0, A1, A2, B1, B2, or B3 size is selected in "Original Size", Letter (or A4) is automatically selected in "Output Size".



macOS

Printer: BP-xxxxx

Presets: Default Settings

Copies: 1 Two-Sided

Pages: All
 From: 1 to: 1

Paper Size: A4 210 by 297 mm (1)

Orientation: Portrait Landscape

Paper Handling (2)

Collate pages

Pages to Print: All pages

Page Order: Automatic (3)

Scale to fit paper size (4)

Destination Paper Size: A3

Scale down only

- (1) Check the paper size for the print image (for example: A4).
- (2) Select [Paper Handling].
- (3) Select [Scale to fit paper size].
- (4) Select the actual paper size to be used for printing (for example: A3).



When you select A0 (Fit to Page), A1 (Fit to Page), A2 (Fit to Page), B1 (Fit to Page), B2 (Fit to Page), or B3 (Fit to Page) in "Paper Size", the selected paper size will be selected after the "Suggested Paper" in "Destination Paper Size".







PRINTING MULTIPLE PAGES ON ONE PAGE

This function reduces the print image and prints multiple pages on a single sheet of paper. You can print only the first page in the original size and print multiple reduced pages on the subsequent sheets.

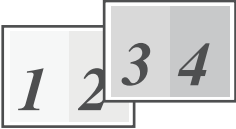
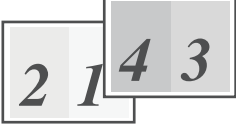
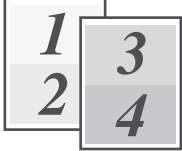
For example, when [2-Up] (2 pages per sheet) or [4-Up] (4 pages per sheet) is selected, the following print results will be obtained, depending on the selected page order.

This is convenient when you want to print multiple images such as photos on a single sheet of paper, and when you want to conserve paper. When used in combination with 2-sided printing, this function saves more paper.

2-Up (2 pages per sheet)			
Left to Right 	Right to Left 	Top To Bottom (When the print orientation is landscape) 	
4-Up (4 pages per sheet)			
Right, and Down 	Down, and Right 	Left, and Down 	Down, and Left 



- [N-Up] that can be set on the [Layout] tab can also be set on the [Main] tab. ("Order" can only be set in the [Layout] tab.)
- Note the following when printing multiple pages on one sheet:
 - The page orders for 6-Up, 8-Up, 9-Up, and 16-Up are the same as for 4-Up.
 - In a Windows environment, the page order can be viewed in the print image in the printer driver properties window.
 - In a macOS environment, the page orders are displayed as selections.
 - In a macOS environment, the number of pages that can be printed on a single sheet is 2, 4, 6, 9, or 16. Printing 8 pages on one sheet is not supported.
- For information on the "Repeat" function, see "[PRINT THE SAME IMAGE IN TILE PATTERN \(REPEAT PRINT\) \(page 4-75\)](#)".



The function for printing only the first page normally can only be used in the PCL6 printer driver.



Windows

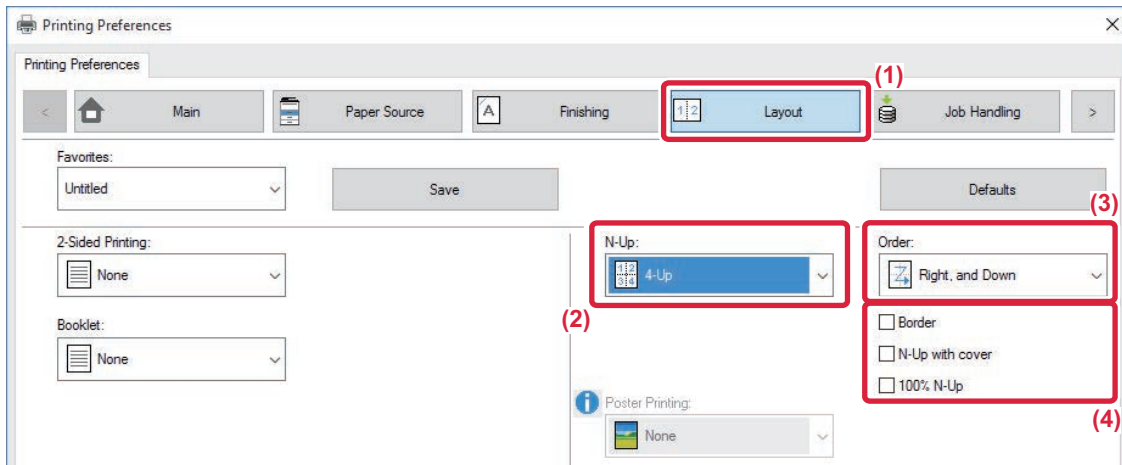

- (1) Click the [Layout] tab.
- (2) Select the number of pages per sheet.
- (3) Select the order of the pages.
- (4) If you wish to print borderlines, click the [Border] checkbox so that the checkmark appears.
 - To print the first page normally (as a cover), select the [N-Up with cover] checkbox (). (PCL6 only)
 - When [100% N-Up] is selected () for jobs such as N-Up copying of two A4 size pages onto one A3 sheet, the pages will be printed at the full size of the original. If you select [Border] at this time, only the border will be printed.

macOS

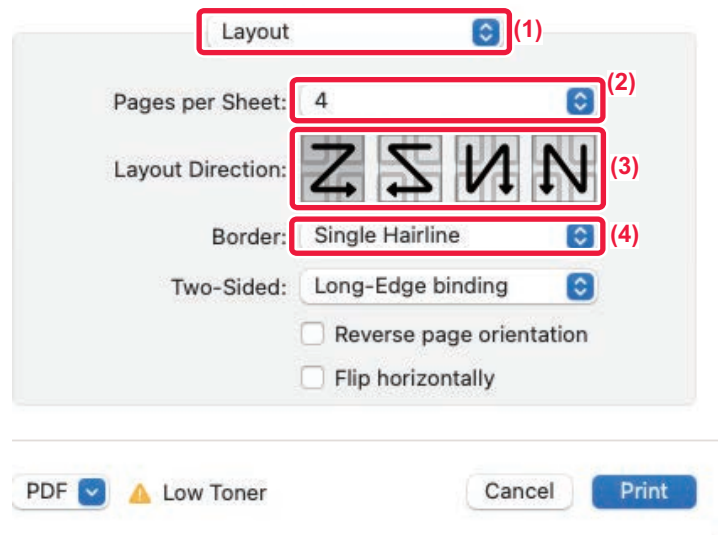

- (1) Select [Layout].
- (2) Select the number of pages per sheet.
- (3) Select the order of the pages.
- (4) If you wish to print borderlines, select the desired type of borderline.



PRINTING WHILE SKIPPING BLANK PAGES

If the scanned original contains blank pages, the blank pages are skipped during printing. The machine detects blank pages and does not print them. This eliminates unnecessary printing without you having to check for blank pages before printing.

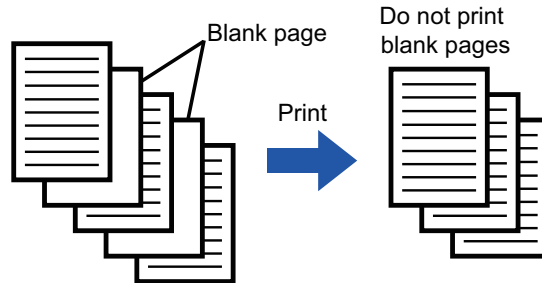

This function is available in a Windows environment.



- Depending on the state of the original, some pages that are not blank may be detected as blank pages and thus not being printed, or some pages that are blank may not be detected as blank and thus printed.
- In N-Up Print, blank pages are not excluded and are printed.

Windows

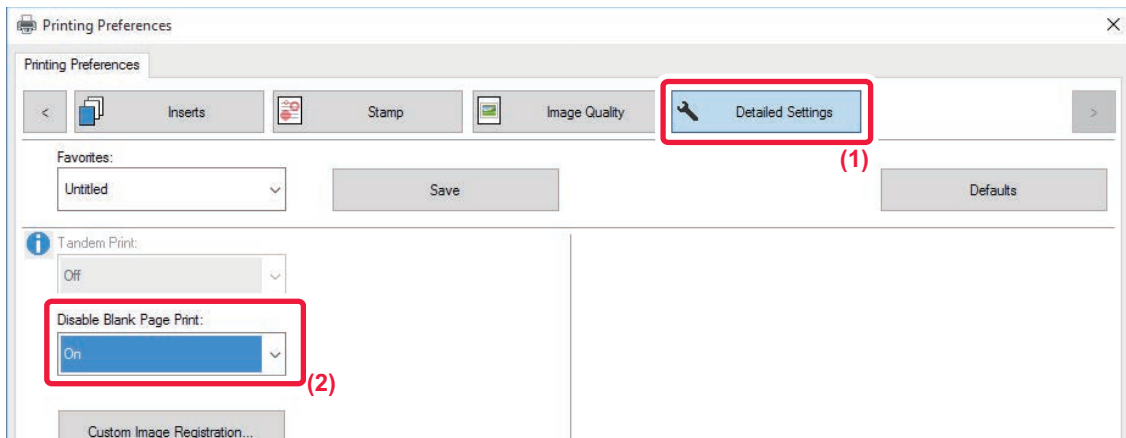

- (1) Click the [Detailed Settings] tab.
- (2) Select [On] in [Disable Blank Page Print].











STAPLING OUTPUT/PUNCHING HOLES IN OUTPUT

STAPLE FUNCTION

The staple function staples the output. To create materials with more sophisticated appearance, the staple function can be used in combination with 2-sided printing.

This function saves considerable time when preparing handouts for a meeting or other stapled materials.



The stapling positions and the number of staples can be selected to obtain the following stapling results.

1 Staple*		
Left 	Right 	Top 
2 Staples		
Left 	Right 	Top 
Stapleless		
Left 	Right 	Top 

* The staple orientation (" | " or " — ") varies depending on the size and orientation of the paper.

PUNCH FUNCTION

The punch function punches holes in the output. The punch hole positions are set by selecting the binding edge.

Left 	Right 	Top 
---	--	--



- A finisher, finisher (large stacker), saddle stitch finisher or saddle stitch finisher (large stacker) is required to use the staple function.
- A finisher (large stacker) or saddle stitch finisher (large stacker) is required to use the stapleless staple function.
- To use the punch function, installing a punch module in the finisher, finisher (large stacker), saddle stitch finisher or saddle stitch finisher (large stacker).
- For the maximum number of sheets that can be stapled, see "SPECIFICATIONS" in the Start Guide.
- The maximum number of sheets that can be stapled at once includes any covers and/or inserts that are inserted.
- For information on the saddle stitch function, see "[CREATE A PAMPHLET \(BOOKLET/SADDLE STITCH\) \(page 4-29\)](#)".



- The staple and offset (shifting the position of the paper that is output for each job) functions cannot be used simultaneously.
- When the finisher is disabled in the machine's settings, the staple function and punch function cannot be used.
- When the staple function or the punch function is disabled in the machine's settings, stapling or punching is not possible.

Windows

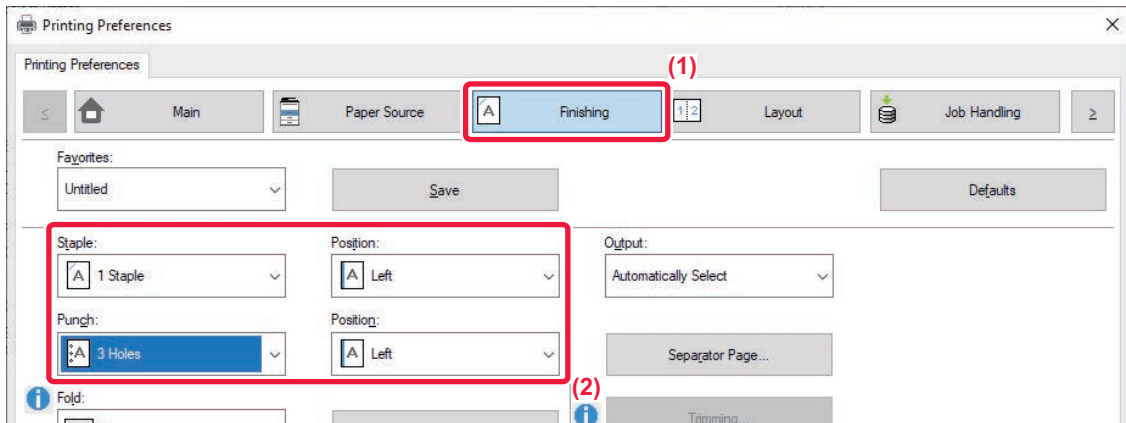

(1) Click the [Finishing] tab.

(2) Select the staple function or the punch function.

- For the staple function, select the number of staples in the "Staple" menu and the staple position in the "Position" menu.
- For the punch function, select the type of punch in the "Punch" menu and the punch position in the "Position" menu.



- In addition to the [Finishing] tab, [Staple] can also be set on the [Main] tab.
- On the [Paper Source] tab, use [Force Letter-R for Letter Size] to always use letter size paper in landscape orientation. Using this setting, when printing mixed legal size, the short sides will be printed with the same width, so you can staple them together.

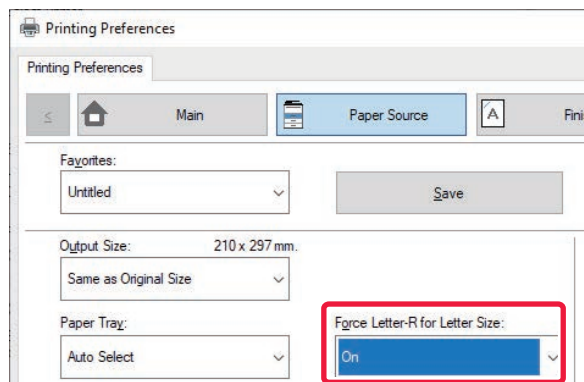



macOS

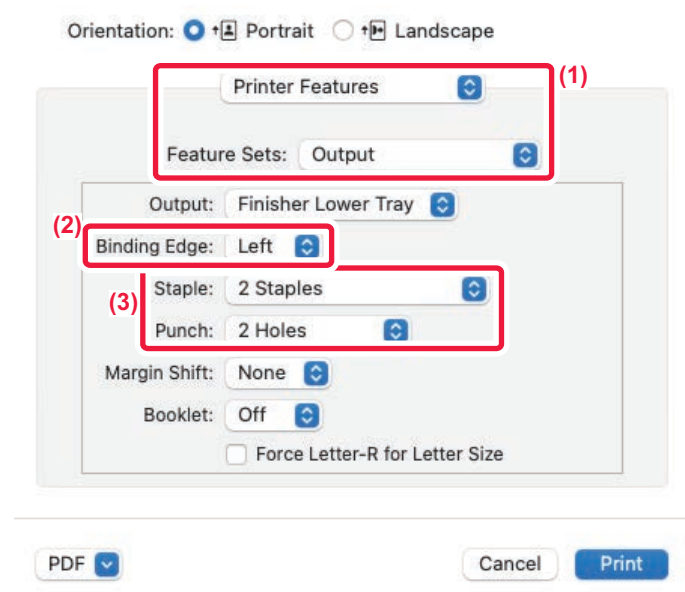

(1) Select [Printer Features] and then select [Output].

(2) Select "Binding Edge".

(3) Select the staple function or the punch function.

- For the staple function, select the number of staples in the "Staple" menu.
- For the punch function, select the type of punch in the "Punch" menu.



Use [Force Letter-R for Letter Size] to always use letter size paper in landscape orientation. Using this setting, when printing mixed legal size, the short sides will be printed with the same width, so you can staple them together.

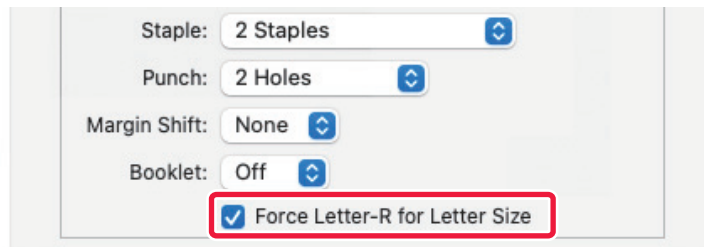



CONVENIENT PRINTING FUNCTIONS

CONVENIENT FUNCTIONS FOR CREATING PAMPHLETS AND POSTERS

CREATE A PAMPHLET (BOOKLET/SADDLE STITCH)

The pamphlet function prints on the front and back of each sheet of paper so that the sheets can be folded and bound to create a pamphlet.

If a saddle stitch finisher is installed and if "Booklet" and "Staple" are selected, this function automatically folds and outputs the copies. This is convenient when you wish to compile printed output into a pamphlet.

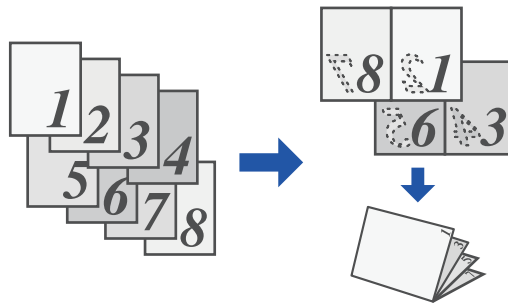

Windows

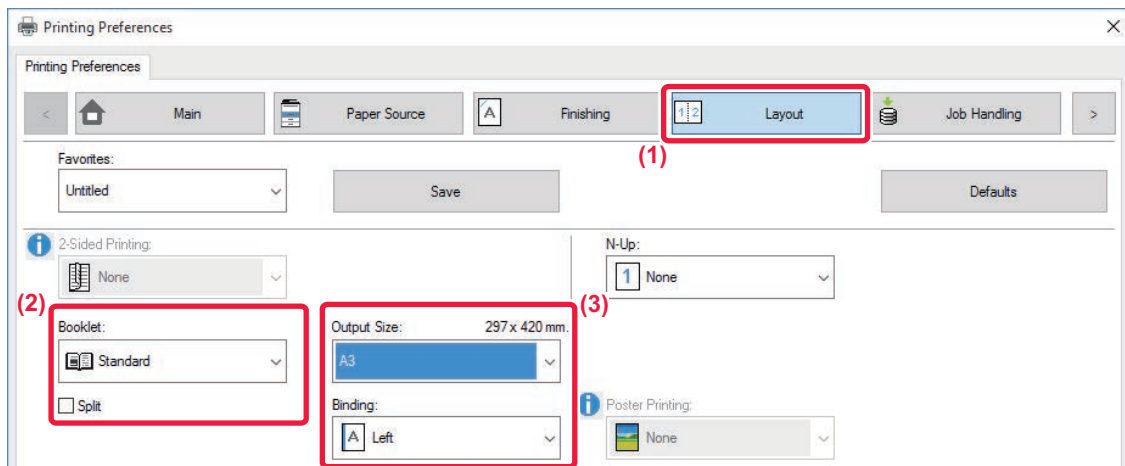

(1) Click the [Layout] tab.

(2) Select [Standard] or [Full Image] in "Booklet".

- When [Standard] is selected, the printed image will be enlarged or reduced to fit the paper selected in "Output Size".
- When [Full Image] is selected, the printed image will be enlarged or reduced to fit the size selected in "Fit To Paper Size". By selecting a paper size that is larger than the print image, you can cut off the edges of the paper after making the booklet to create a booklet with no margins.
- When the number of output pages will exceed the number of sheets that can be stapled, you can select the [Split] checkbox () to divide the output into multiple sub-booklets that can each be stapled. When stacked, the sub-booklets will have the same page order as the original pages.



(3) Select the specified output size and the binding edge.

- When [Standard] is selected, select the output paper size.
- When [Full Image] is selected, select the size to which you want to enlarge or reduce the print image in [Fit To Paper Size], and select the paper size you want to use for printing in "Output Size".

If a saddle stitch finisher is installed

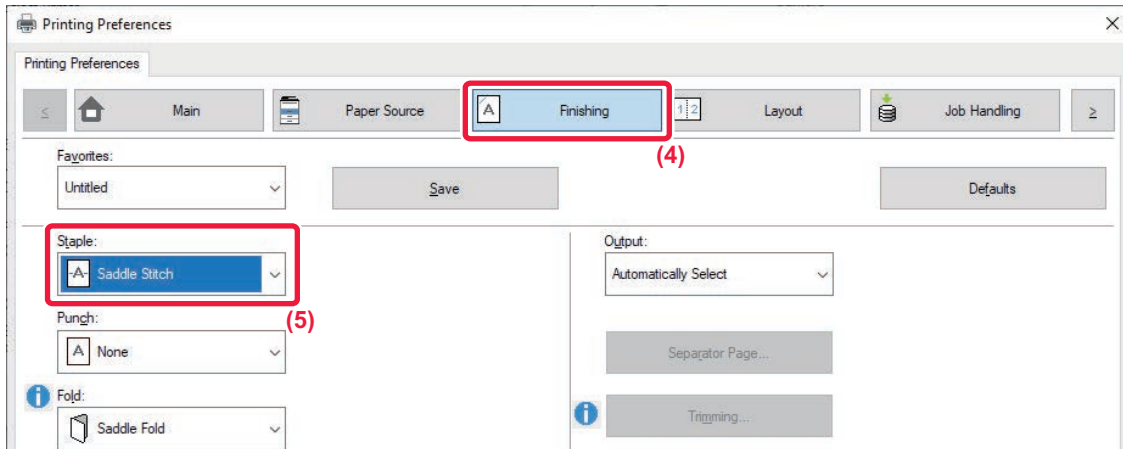

(4) Click the [Finishing] tab.

(5) Select [Saddle Stitch] from "Staple".



When a saddle stitch finisher (large stacker) is installed and the job is not output correctly with [Saddle Stitch], select [Saddle Stitch (Reverse)].

macOS

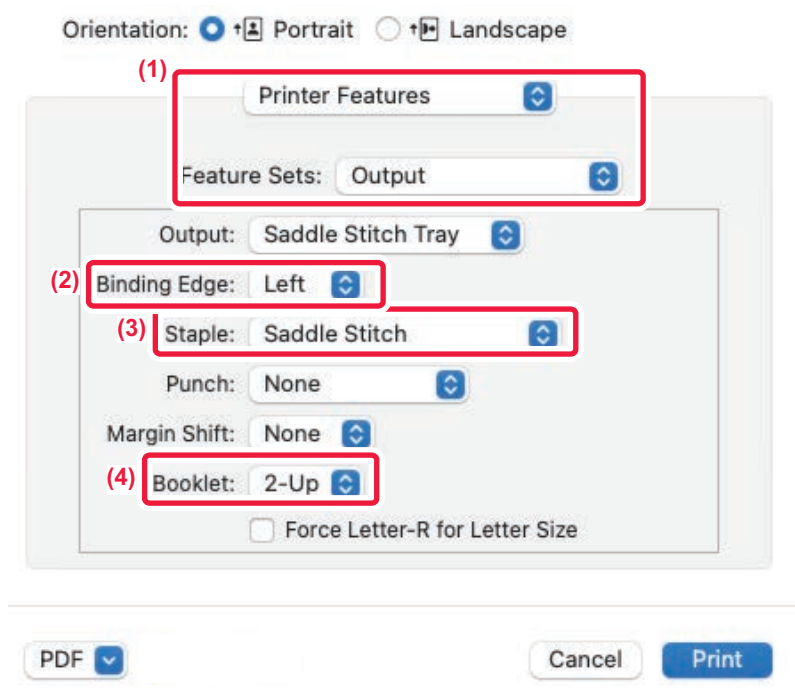

(1) Select [Printer Features] and then select [Output].

(2) Select "Binding Edge".

(3) Select [Saddle Stitch].

(4) Select [Tiled] or [2-Up].



TRIMMING THE EXCESS OF FOLDED PAPER

If a trimmer unit is installed, you can trim off excess edges of paper for a finer finish.

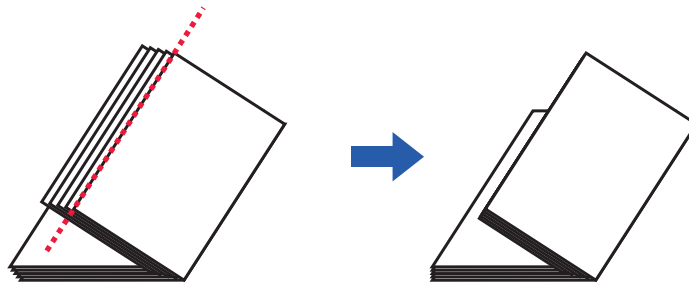

Windows

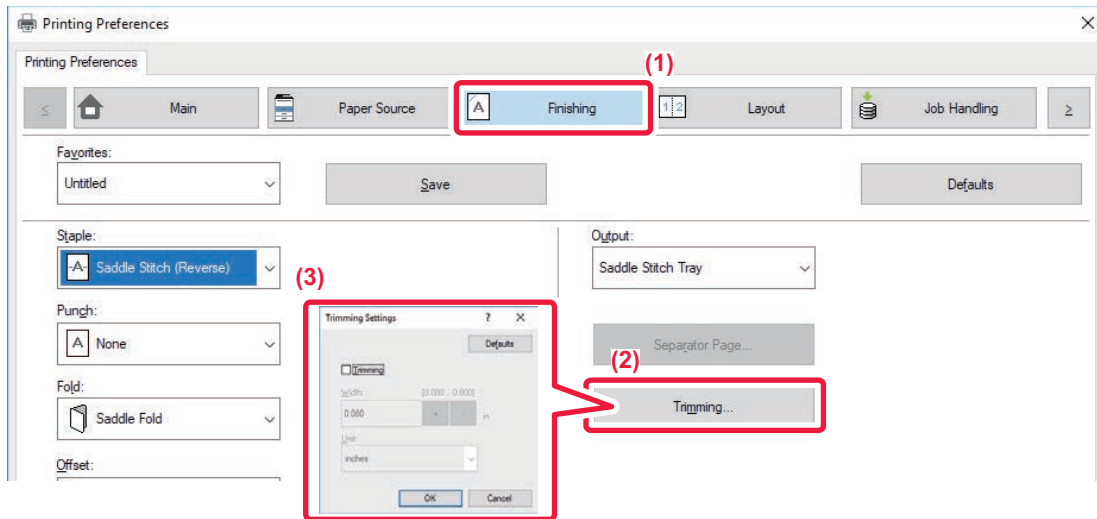

- (1) Click the [Finishing] tab.
- (2) Click the [Trimming] button.
- (3) Set the [Trimming] checkbox to , and specify "Trimming Width".



macOS

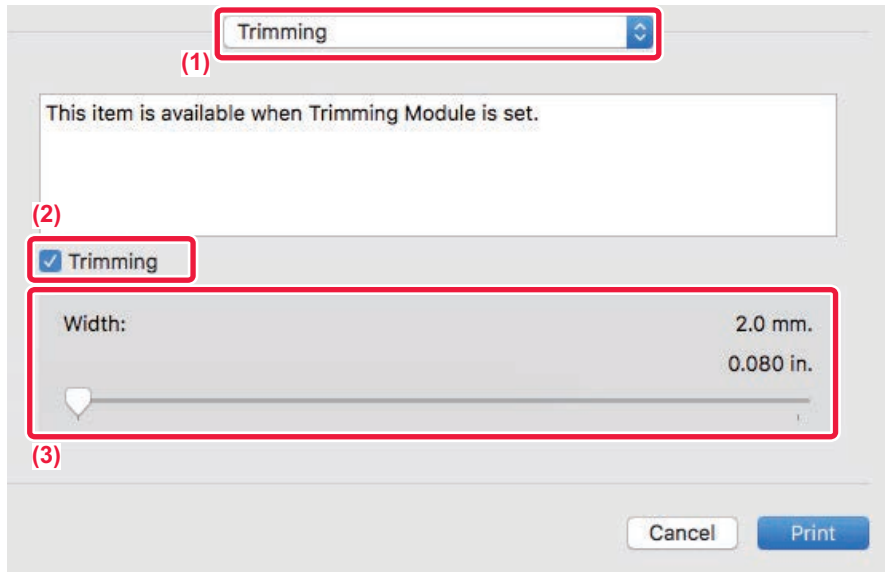

- (1) Select [Trimming].
- (2) Set the [Trimming] checkbox to .
- (3) Specify the trimming width.



PRINTING WITH MARGIN SHIFT SETTING (MARGIN)

This function shifts the print image to increase the margin at the left, the right, or the top of the paper.

If a finisher or saddle stitch finisher is installed, the staple and punch functions of the machine can also be used together.

This is convenient when you wish to staple or punch the output but the binding area overlaps the text.

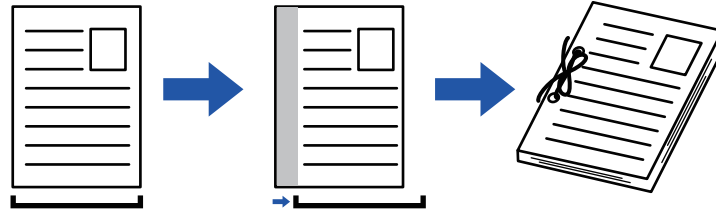

By shifting the image, the part of the image that is outside the print area will not be printed.

Windows

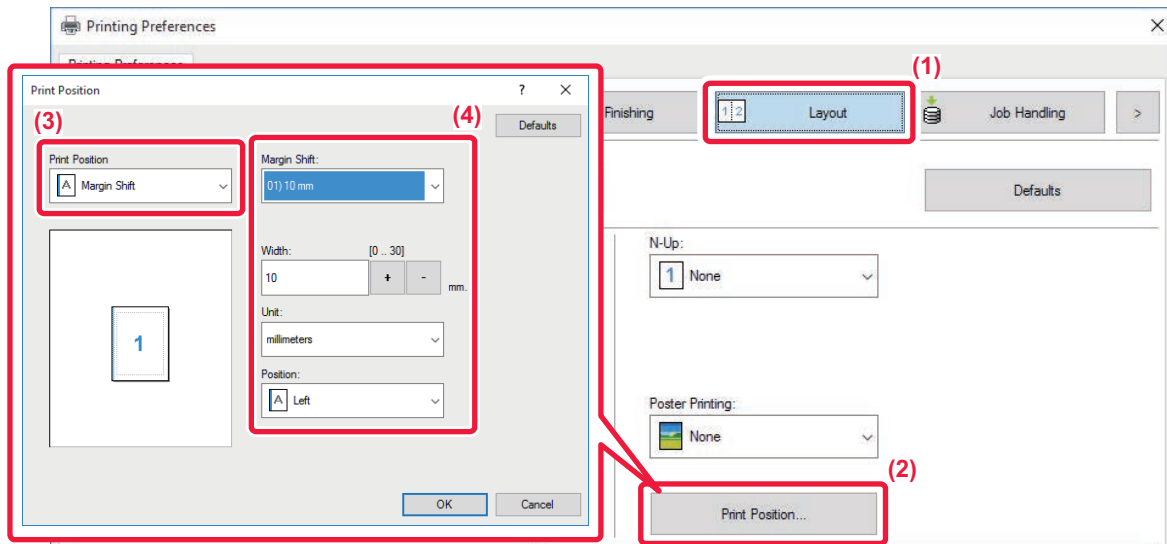

- (1) Click the [Layout] tab.
- (2) Click the [Print Position] button.
- (3) Select [Margin Shift].
- (4) Select the shift width.

Select from the "Margin Shift" menu. If you wish to configure another numeric setting, select the setting and click buttons or directly enter the number.



macOS

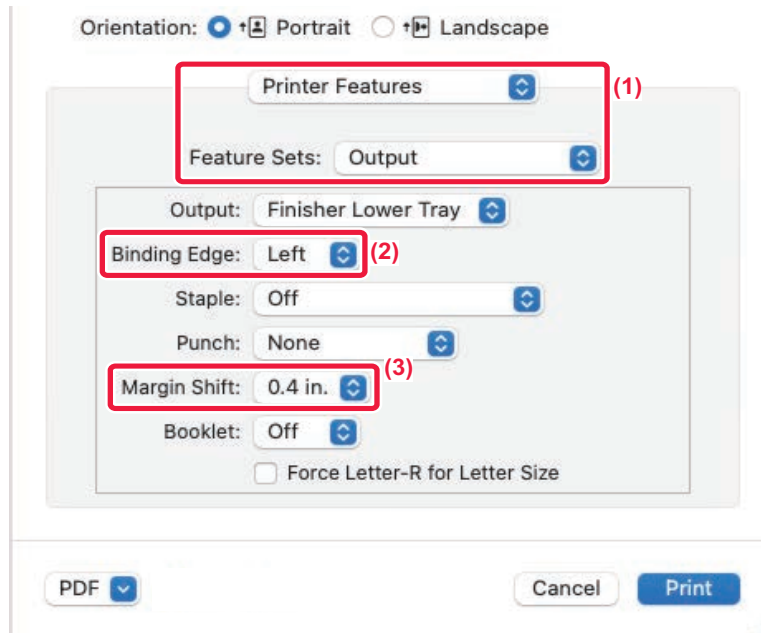

- (1) Select [Printer Features] and then select [Output].
- (2) Select "Binding Edge".
- (3) Select "Margin Shift".



CREATE A LARGE POSTER (POSTER PRINTING)

One page of print data is enlarged and printed using multiple sheets of paper (2 sheets (1 x 2), 4 sheets (2 x 2), 9 sheets (3 x 3) or 16 sheets (4 x 4)). The sheets can then be attached together to create a large poster.

To enable precise alignment of the edges of the sheets during attachment, borderlines can be printed or overlapping edges can be created (overlap function).

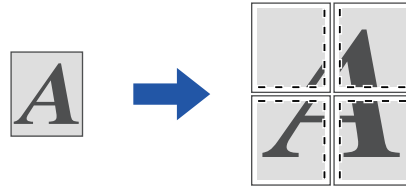

This function is available in a Windows environment.

Windows

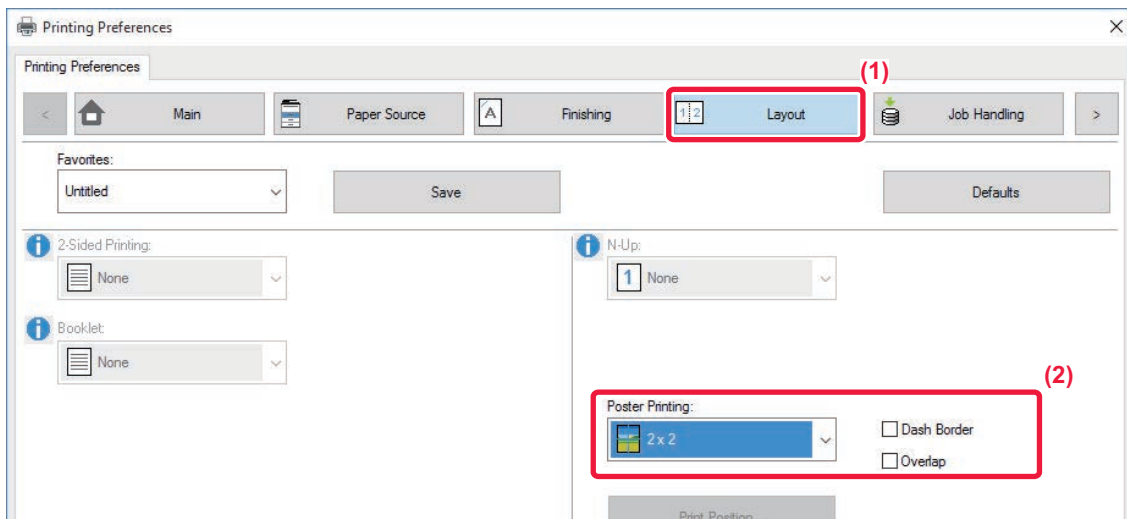

(1) Click the [Layout] tab.

(2) Select the number of sheets to be used in "Poster Printing".

If you wish to print borderlines and/or use the overlap function, click the corresponding checkboxes so that the appears.



FUNCTIONS TO ADJUST THE SIZE AND ORIENTATION OF THE IMAGE

ADJUST PRINT POSITION ON ODD AND EVEN PAGES SEPARATELY (PRINT POSITION)

This function sets different print positions (margins) separately for odd and even pages and prints the pages.



This function is available in a Windows environment.

Windows

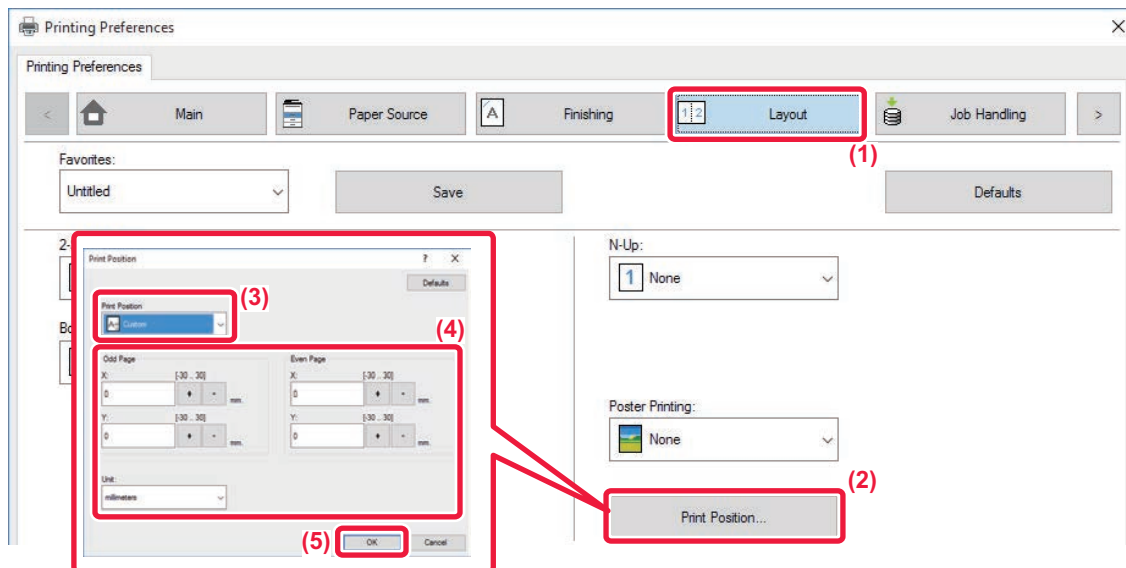

- (1) Click the [Layout] tab.
- (2) Click the [Print Position] button.
- (3) Select [Custom].
- (4) Set the amount of shifting of the print position for odd-numbered pages and even-numbered pages.
- (5) Click the [OK] button.



ROTATING THE PRINT IMAGE 180 DEGREES (ROTATE 180 DEGREES)

This feature rotates the image 180 degrees so that it can be printed correctly on paper that can be loaded in only one orientation (such as paper with punch holes).

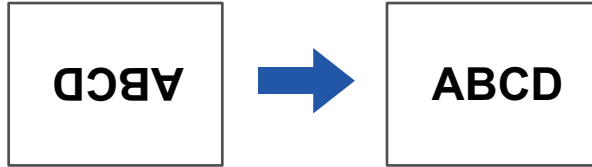

Windows

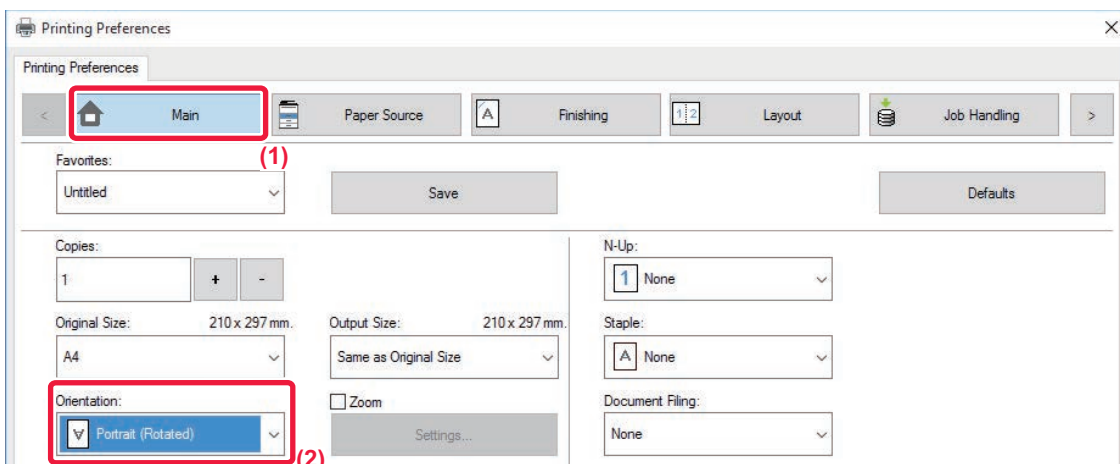

- (1) Click the [Main] tab.
- (2) Select [Portrait (Rotated)] or [Landscape (Rotated)] in "Orientation".

macOS

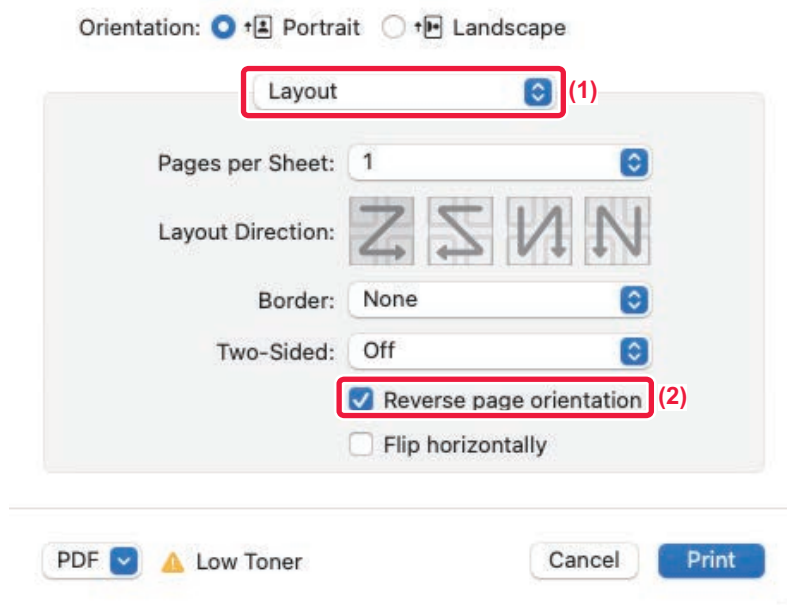

- (1) Select [Layout].
- (2) Select the [Reverse page orientation] checkbox so that appears.



ENLARGING/REDUCING THE PRINT IMAGE (ZOOM SETTING/ENLARGE OR REDUCE)

This function enlarges or reduces the image to a selected percentage.

This allows you to enlarge a small image or add margins to the paper by slightly reducing an image.

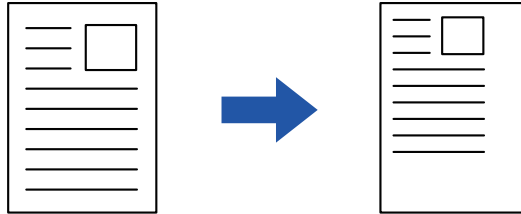

When using the PS printer driver (Windows), you can set the width and length percentages separately to change the proportions of the image.

Windows

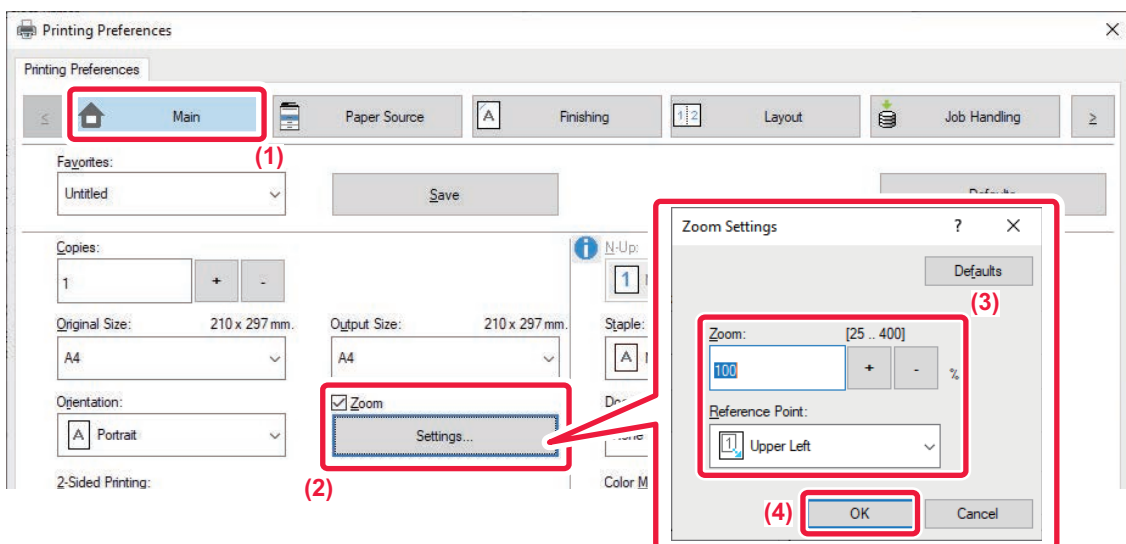

(1) Click the [Main] tab.

(2) Click the [Zoom] checkbox so that appears, and click the [Settings] button.

(3) Enter the percentage.

By clicking the button, you can specify the value in increments of 1%. In addition, select [Upper Left] or [Center] for the base point on the paper.

(4) Click the [OK] button.



macOS

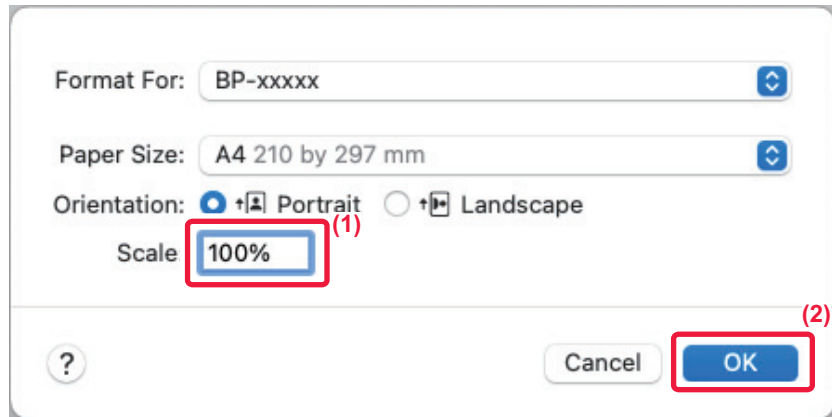

- (1) Select [Page Setup] from the [File] menu and enter the ratio (%).
- (2) Click the [OK] button.



ADJUST THE LINE THICKNESS (WIDTH)

Adjusting line widths used in data such as CAD

This function increases the thickness of the entire line when the print lines are not clear in CAD or other special applications.

When the data includes lines of varying widths, you can print all lines at the minimum width as necessary.

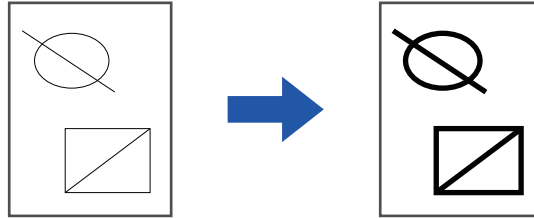

- This function is available in a Windows environment.
- This function can be used when the PCL6 printer driver is used.
- When printing from an application that processes lines as raster graphics, line widths cannot be adjusted.

Windows

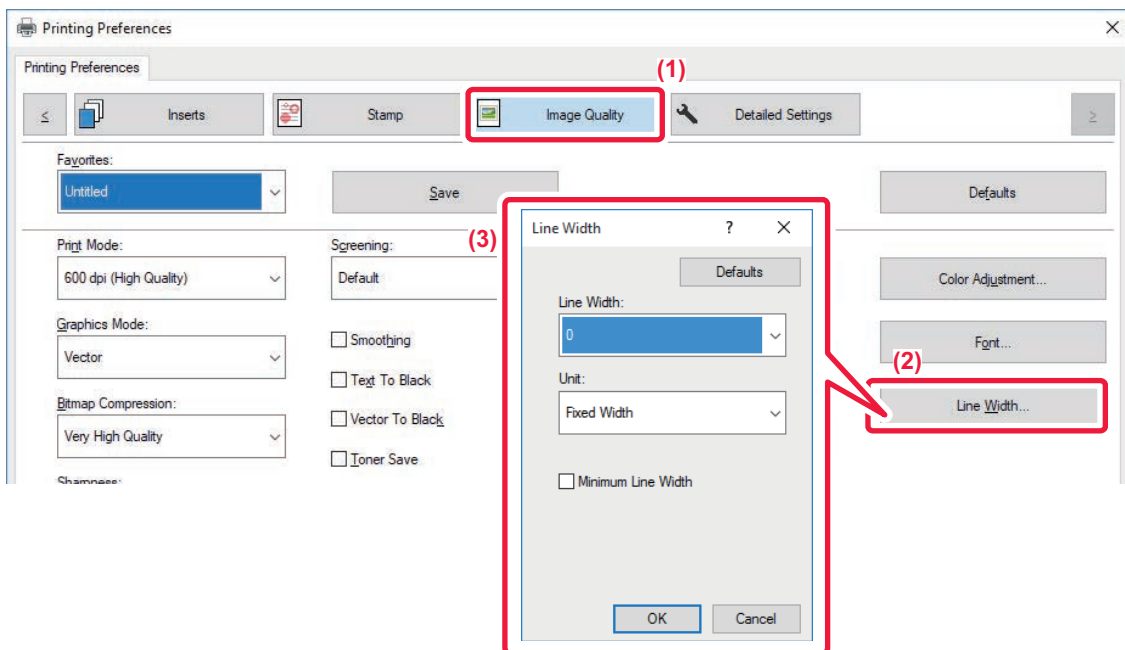

- (1) Click the [Image Quality] tab.
- (2) Click the [Line Width] button.
- (3) Set the line thickness and click the [OK] button.



- The units of line-width adjustment can be set to "Fixed Width" or "Ratio". Select from the "Unit" menu.
- To print all line data in the minimum line width, click the [Minimum Line Width] checkbox.



Thickening fine lines in Excel

When fine border lines in Excel do not print correctly, you can make the lines thicker.



- This function is available in a Windows environment.
- This function can be used when the PCL6 printer driver is used.
- Normally this setting is not necessary.

Windows

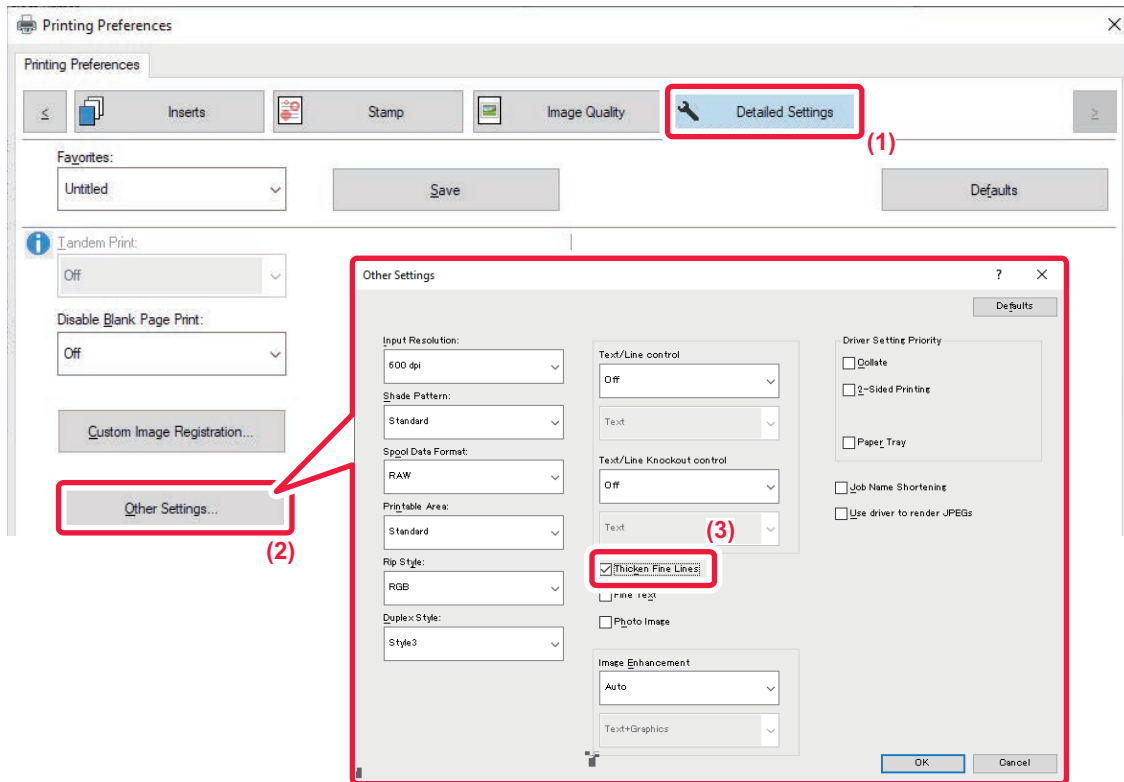

- (1) Click the [Detailed Settings] tab.
- (2) Click the [Other Settings] button.
- (3) Select the [Thicken Fine Lines] checkbox ().



Adjusting the thickness of text and lines

You can make text and lines thicker. You can also make edges smoother or sharper.

Windows

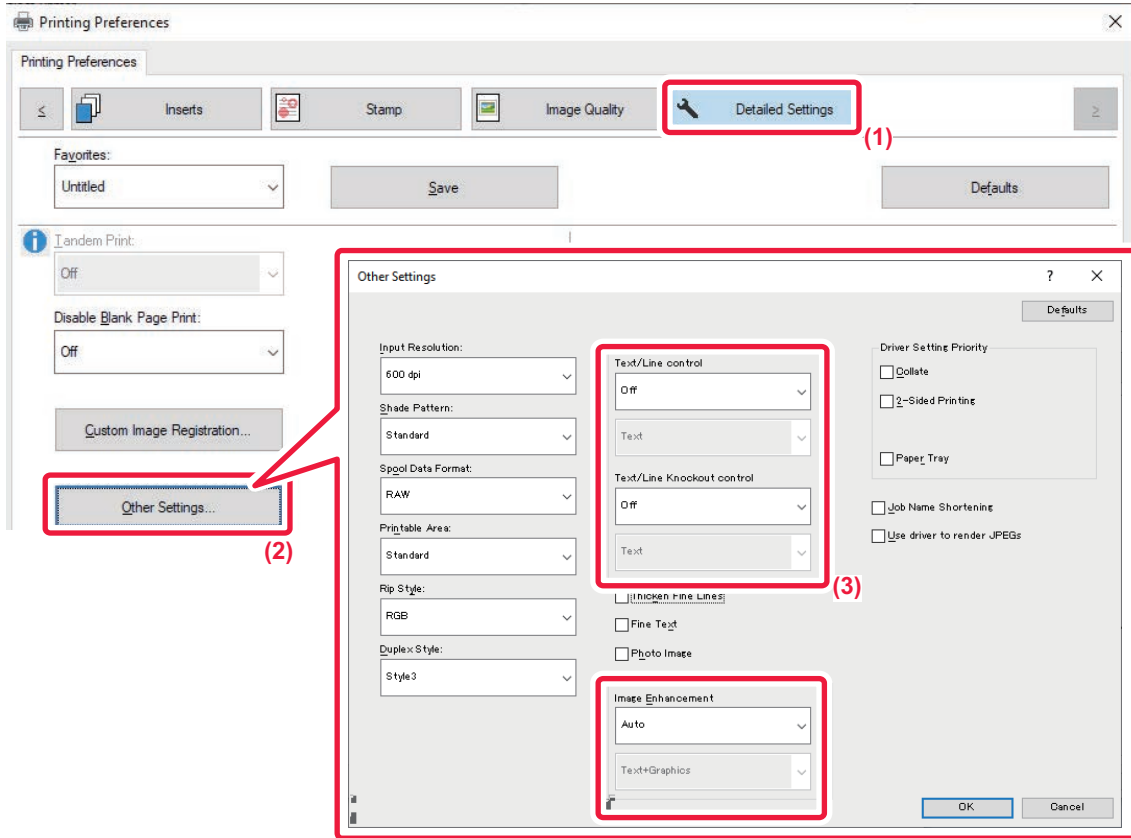

- (1) Click the [Detailed Settings] tab.
- (2) Click the [Other Settings] button.
- (3) Specify the settings.

Item		Description
Text/Line control	Text	You can make characters and text thicker.
	Graphics	
	Text+Graphics	
	Text+Graphics+Photo	
Text/Line Knockout control	Auto	You can make knockout text and lines thicker.
	Off	



Item		Description
Image Enhancement	Sharp	Text
		Text+Graphics
		Text+knockout text
		Text+Graphics+knockout text
		Text+Graphics+knockout
	Soft	Text
		Text+Graphics
		Text+knockout text
		Text+Graphics+knockout text
		Text+Graphics+knockout

You can make the edges of text and graphics smoother or sharper.
Auto: Perform optimal image enhancement.
Off: No image enhancement is applied.
Sharp: Image enhancement is applied sharply.
Soft: Image enhancement is applied smoothly.

macOS

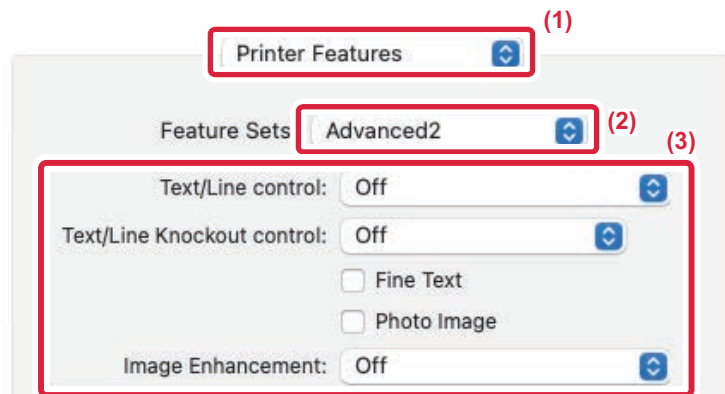

- (1) Select [Printer Features].
- (2) Select [Advanced2].
- (3) Specify the settings.



PRINT A MIRROR-IMAGE (MIRROR-IMAGE REVERSE/VISUAL EFFECTS)

The image is reversed to create a mirror image.

This function is conveniently used to print a design for a woodblock print or other printing medium.

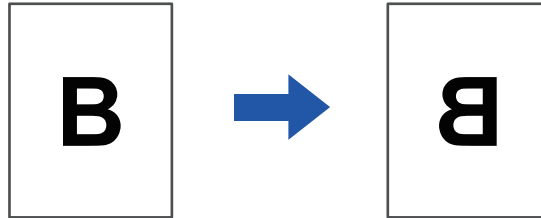

In a Windows environment, this function is only available when using the PS printer driver.

Windows

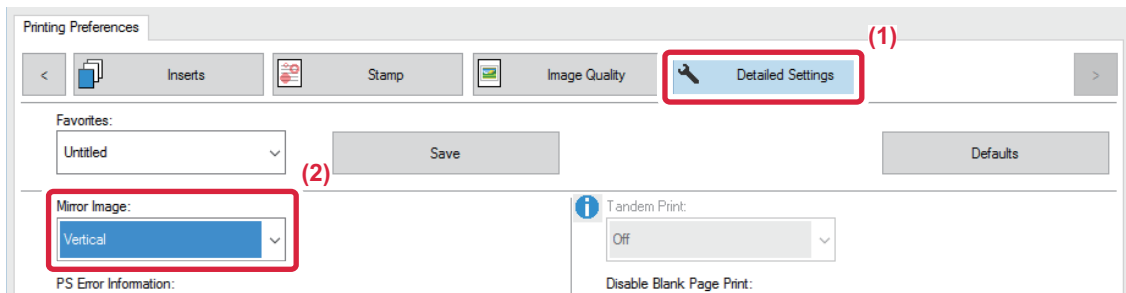

- (1) Click the [Detailed Settings] tab.
- (2) If you wish to reverse the image horizontally, select [Horizontal]. If you wish to reverse the image vertically, select [Vertical].

macOS

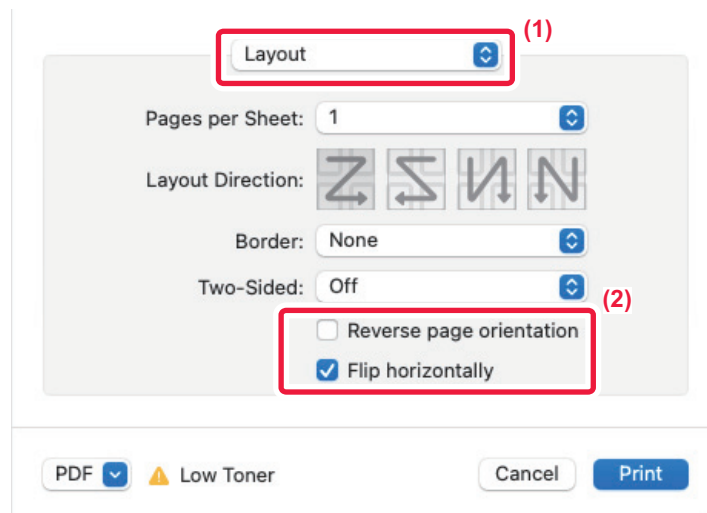

- (1) Select [Layout].
- (2) Select the [Flip horizontally] checkbox ().



IMAGE MODE ADJUSTING FUNCTION

ADJUST THE BRIGHTNESS AND CONTRAST OF THE IMAGE (IMAGE ADJUSTMENT)

This function adjusts the brightness and contrast in the print settings when a photo or other image is printed. This function makes simple corrections even if image editing software is not installed on your computer.



This function is available in a Windows environment.

Windows

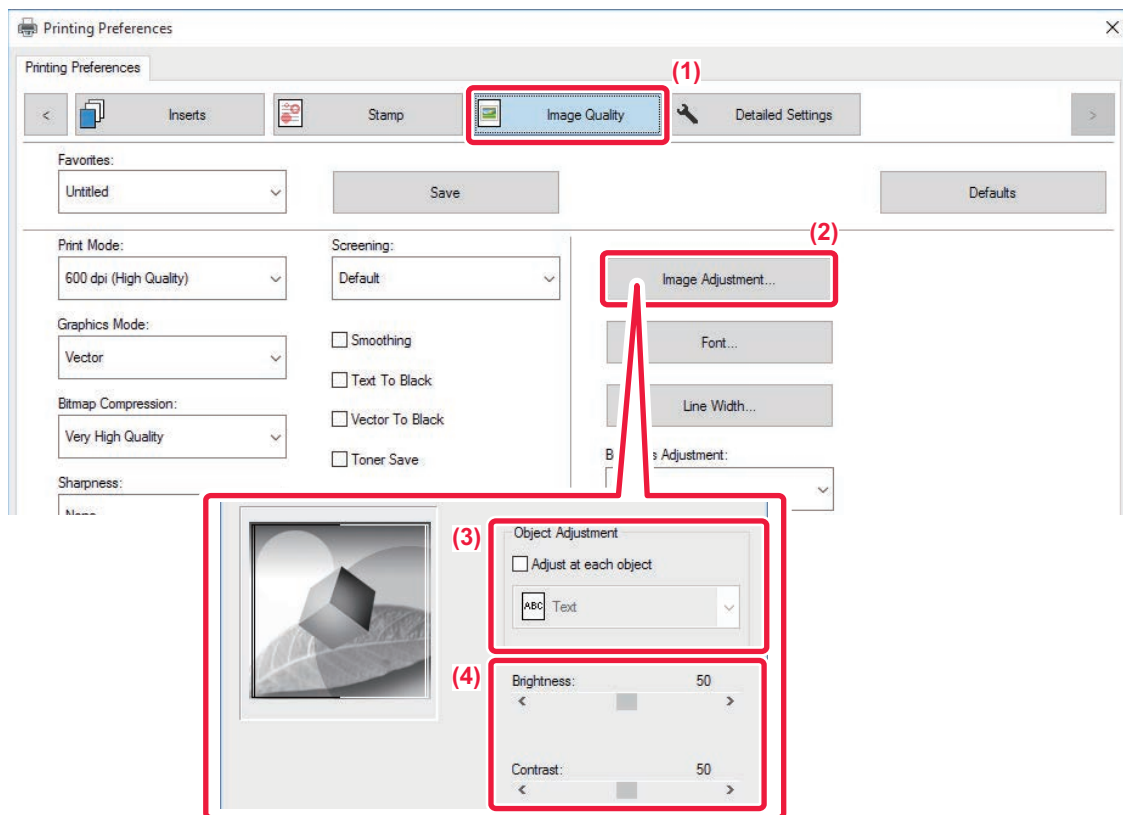

- (1) Click the [Image Quality] tab.
- (2) Click the [Image Adjustment] button.
- (3) To adjust objects (text, graphics, photos) individually, select the [Adjust at each object] checkbox () and select the object.
- (4) Drag the slide bar or click buttons to adjust the image.



PRINTING FAINT TEXT AND LINES IN BLACK (TEXT TO BLACK/VECTOR TO BLACK)

When printing a color image in grayscale, text and lines that are drawn in faint colors are printed in black. This function allows you to bring out color text and lines that are faint and difficult to see when printed in grayscale.

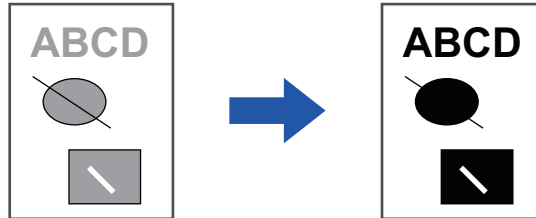

- Raster data such as bitmap images cannot be adjusted.
- This function is available in a Windows environment.

Windows

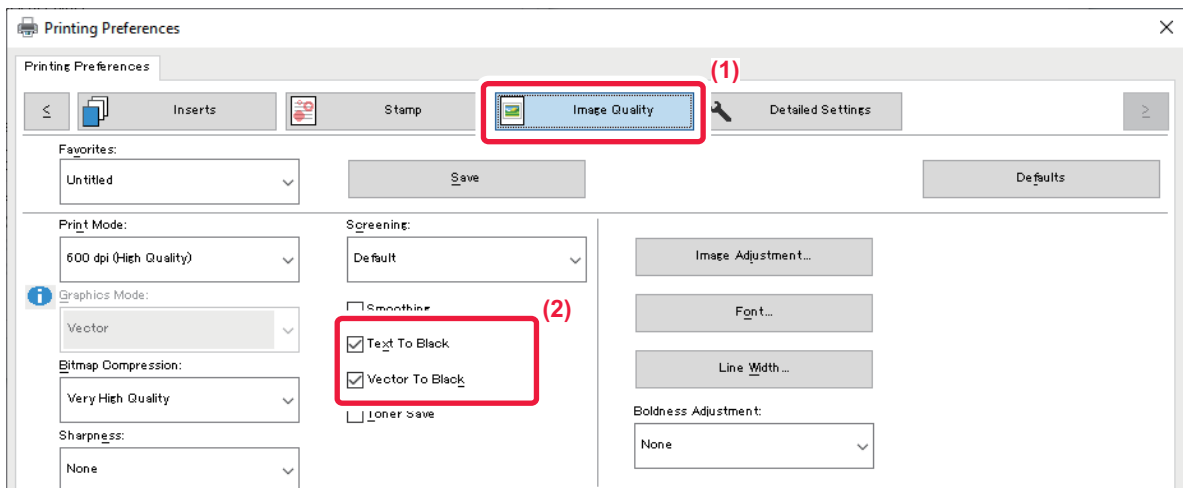

- (1) Click the [Image Quality] tab.
- (2) Select the [Text To Black] checkbox and/or the [Vector To Black] checkbox so that appears.
 - When [Text To Black] is selected, all text other than white text is printed in black.
 - When [Vector To Black] is selected, all vector graphics other than white lines and areas are printed in black.



SELECTING IMAGE SETTINGS TO MATCH THE IMAGE TYPE

Preset settings are available in the machine's printer driver for various uses.

Graphics mode	Select the graphics mode from "Raster" or "Vector".
Bitmap compression	The data compression ratio of bitmap is set. If the ratio is higher, the image quality becomes lower.
Screening	Select the screening to modify the image to suit specific preferences, according to the appropriate image processing method.
Sharpness	This setting creates a sharper image with clear outlines, or smooths the image for a softer effect.
Smoothing*	Resolution enhancement techniques (RETs) are used to smoothen the outlines of images. This setting processes the image to increase the resolution and smooth jagged image borders.

* This function is available in a Windows environment.

Windows

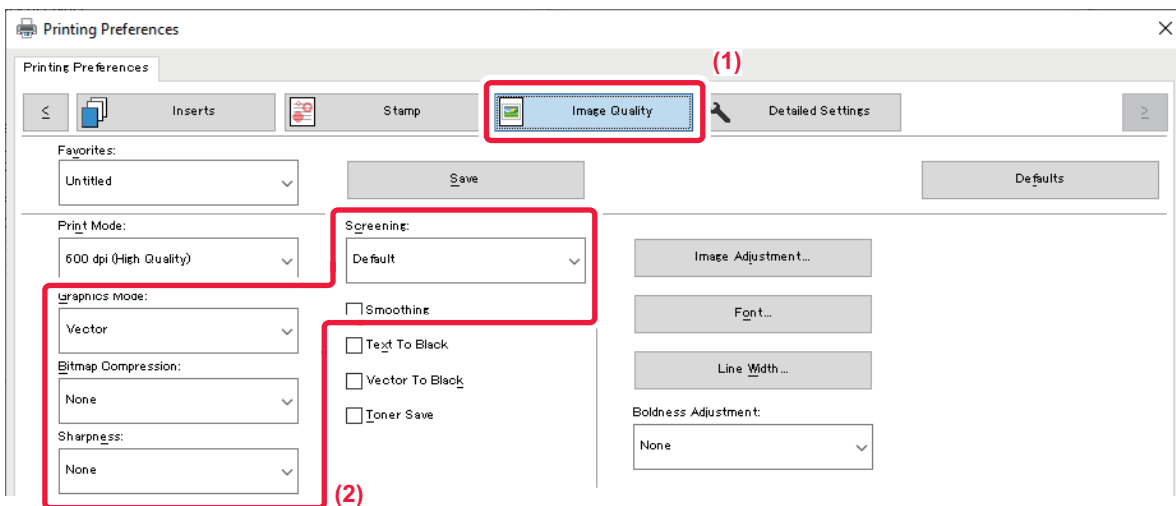

(1) Click the [Image Quality] tab.

(2) Specify the settings.



macOS

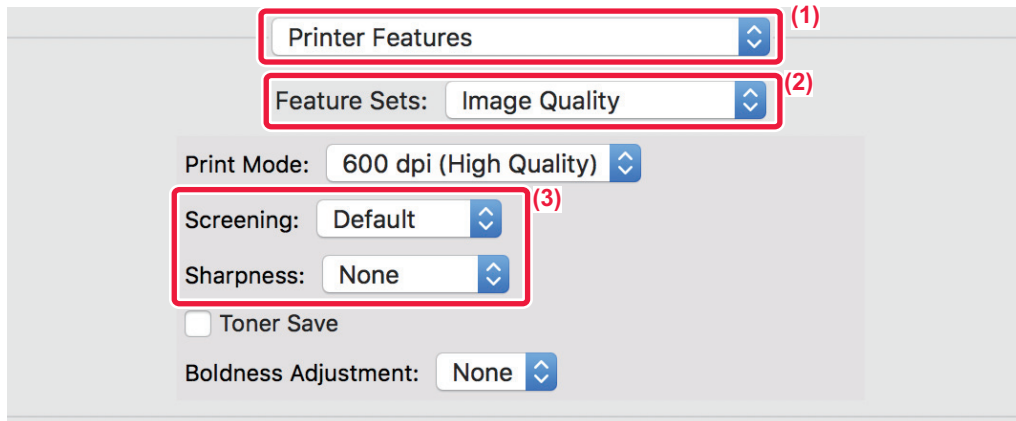

- (1) Select [Printer Features].
- (2) Select [Image Quality].
- (3) Specify the settings.



FUNCTIONS TO COMBINE TEXT AND IMAGES

ADDING A WATERMARK TO PRINTED PAGES (WATERMARK)

This function adds faint shadow-like text as a watermark in the background of the printed image. The size and angle of the watermark text can be adjusted.

The watermark text can be selected from the previously registered text in the list. When necessary, you can enter text to create an original watermark.

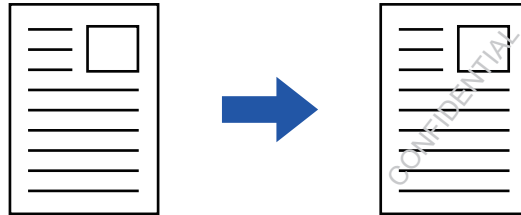

Windows

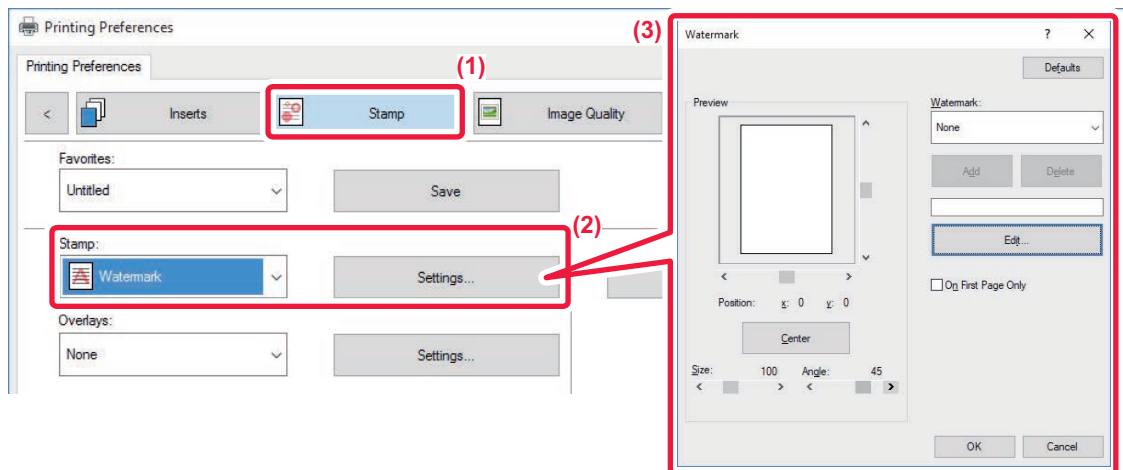

- (1) Click the [Stamp] tab.
- (2) Select [Watermark] from "Stamp" and click the [Settings] button.
- (3) Select the watermark to be used and click the [OK] button.

Click the [Edit] button to select other detailed settings.



If you want to create a new watermark, enter the text of the watermark in the text box and click the [Add] button.



macOS

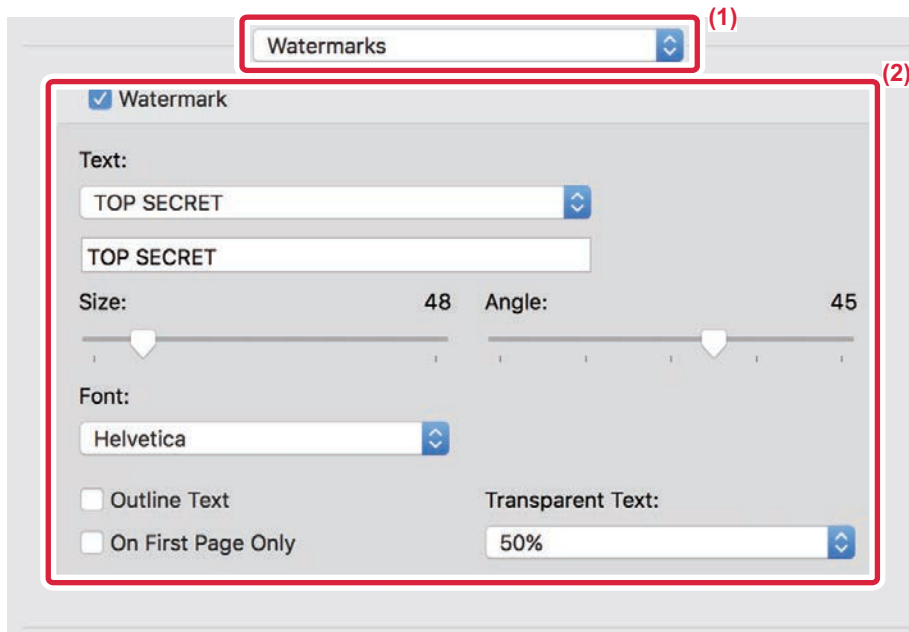

(1) Select [Watermarks].

(2) Click the [Watermark] checkbox and configure watermark settings.

- Configure detailed watermark settings such as selection of the text.
- Adjust the size and angle of the text by dragging the slide bar .



PRINTING AN IMAGE OVER THE PRINT DATA (IMAGE STAMP)

This function prints a bitmap or JPEG image stored on your PC over the print data.

This function prints a frequently used image or an icon of your own creation as if it is stamped on the print data. The size, position, and angle of the image can be adjusted.

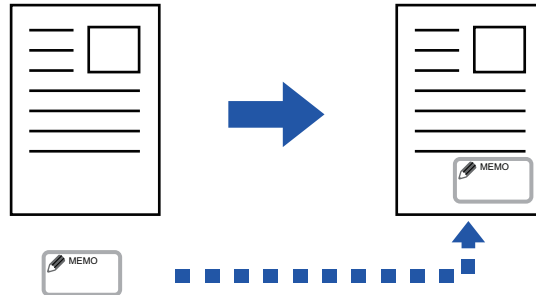

This function is available in a Windows environment.

Windows

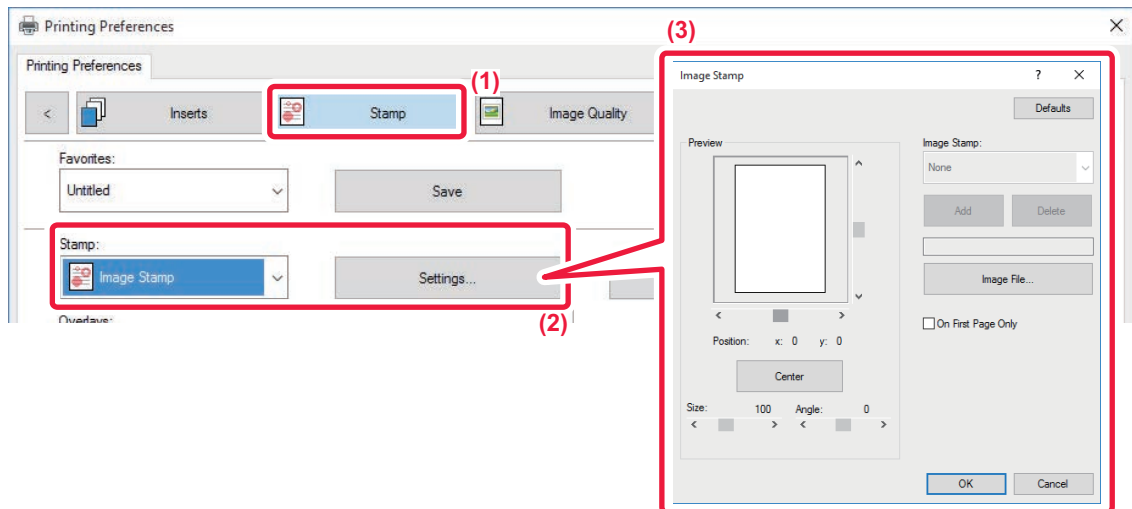

(1) Click the [Stamp] tab.

(2) Select [Image Stamp] from "Stamp" and click the [Settings] button.

(3) Select the image stamp to be used, and click the [OK] button.

- If an image stamp has already been stored, it can be selected from the menu.
- If you have not stored an image stamp, click the [Image File], select the file you wish to use for the image stamp, and click the [Add] button.



REGISTERING A CUSTOM IMAGE

This function registers images used as custom images from the printer driver to the machine.



- This function is available in a Windows environment.
- This function can be used when the PCL6 printer driver is used.

Windows

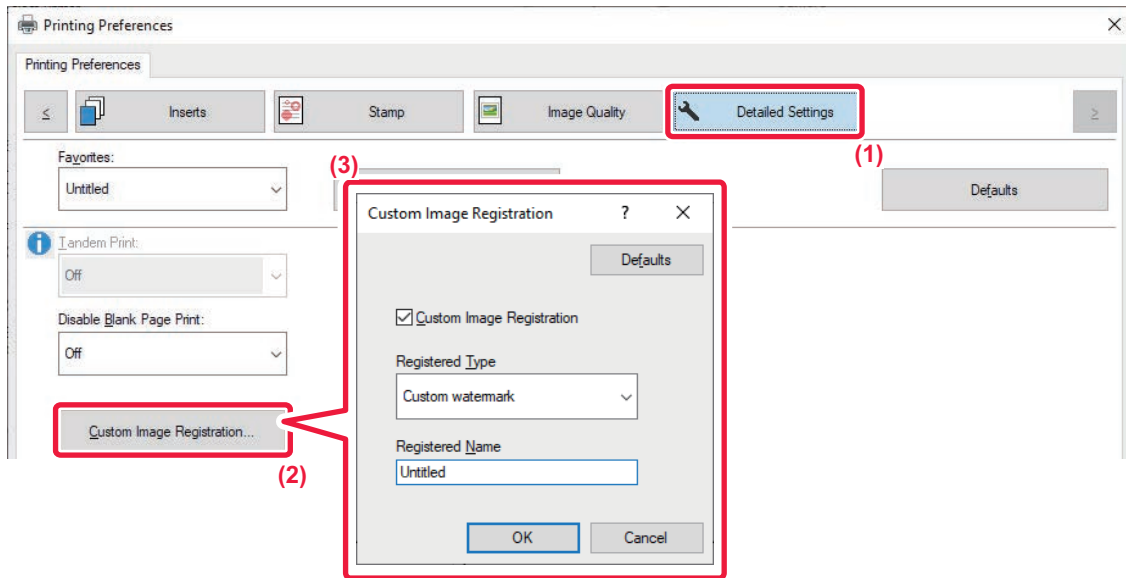

(1) Click the [Detailed Settings] tab.

(2) Click the [Custom Image Registration] button.

(3) Select the registration type and name of the custom image.

When [Custom stamp] is selected in "Registered Type", non-transparent stamp image is registered. When [Custom watermark] is selected, transparent watermark image is registered.



If you have attempted to store multiple pages of data, only the first page will be stored.



OVERLAY A FIXED FORM ON THE PRINT DATA (OVERLAYS)

This function overlays data on a fixed form you have prepared.

By creating table rulings or a decorative frame in an application different from that of the text file and registering the data as an overlay file, an attractive print result can be easily obtained without the need for complex manipulations.

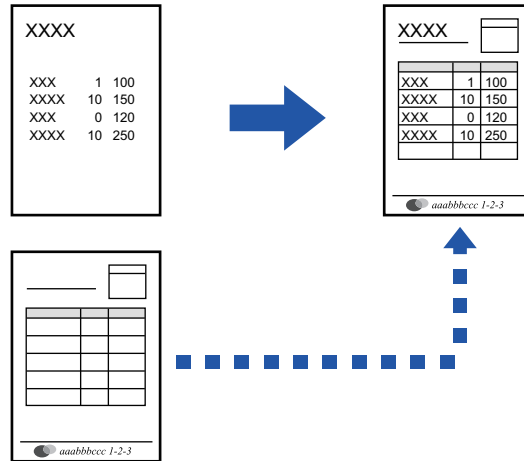

This function is available in a Windows environment.

Creating an overlay file

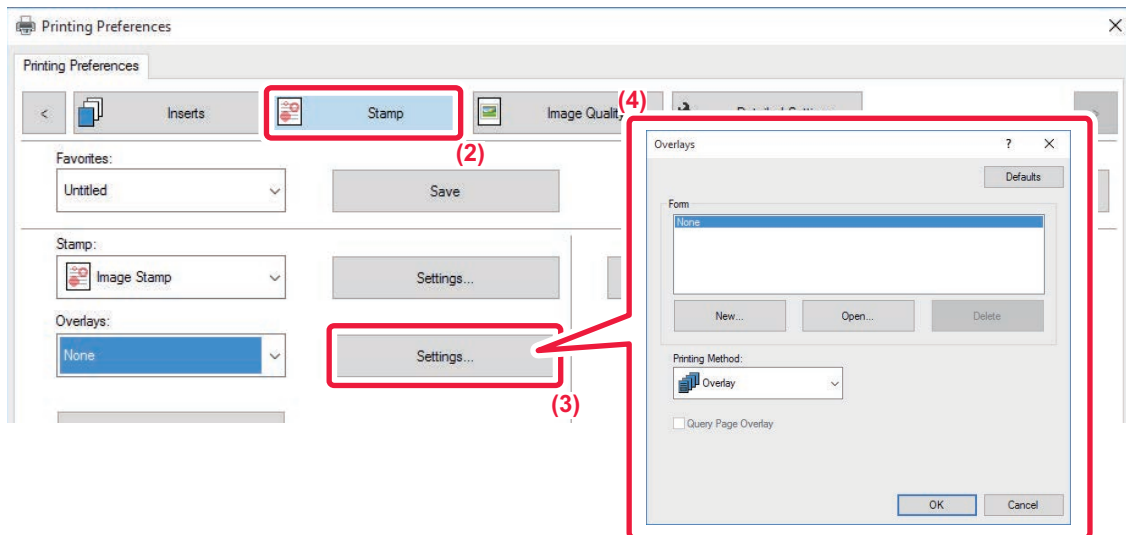

- (1) Open the driver properties window from the application that is used for creating overlay data.
- (2) Click the [Stamp] tab.
- (3) Click the [Settings] button.
- (4) Click the [New] button and specify the name and folder to be used for the overlay file that you wish to create.

The file will be created when the settings are completed and printing is started.



- When printing is started, a confirmation message will appear. The overlay file will not be created until the [Yes] button is clicked.
- When you click the [Open] button, the existing overlay file is registered.

Printing with an overlay file

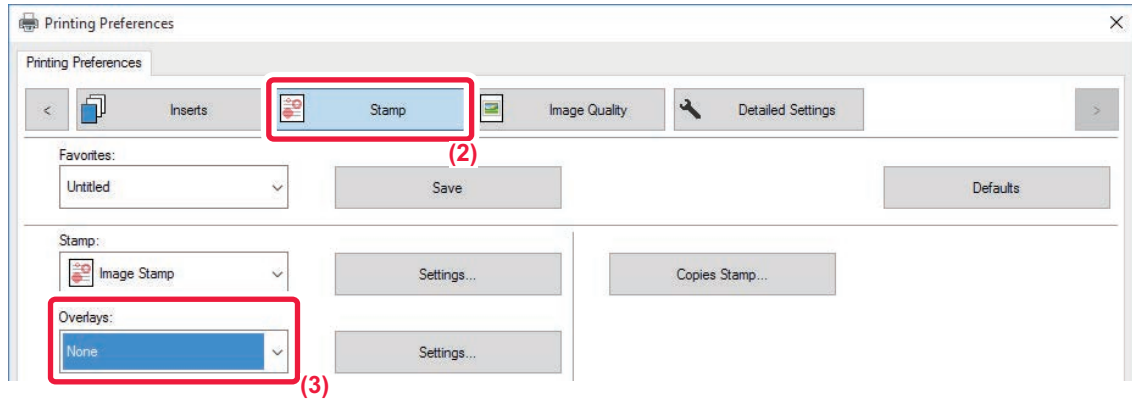

(1) Open the driver properties window from the application that is used for printing with an overlay file.

(2) Click the [Stamp] tab.

(3) Select an overlay file.

A previously created or stored overlay file can be selected from the menu.



ADDING THE NUMBER OF COPIES (COPIES STAMP)

You can add the number of copies to the header or footer of the print data. You can also set a copies number and print position.



This function is available in a Windows environment.

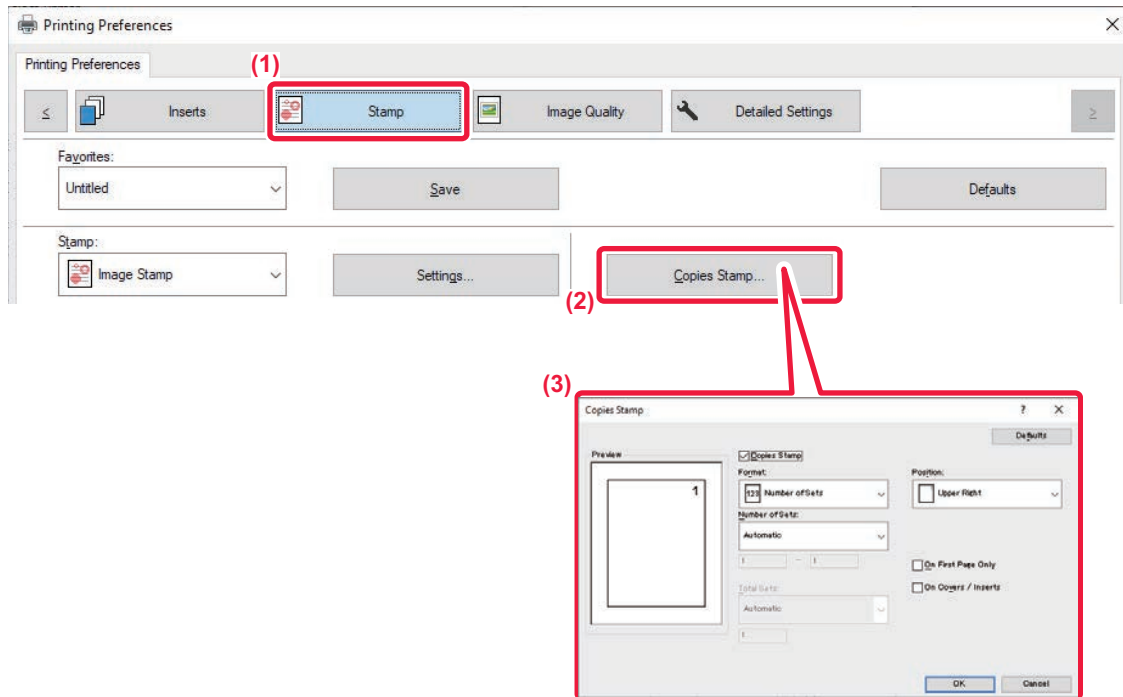

- (1) Click the [Stamp] tab.
- (2) Click the [Copies Stamp] button.
- (3) Select the settings, and click the [OK] button.



PRINT FUNCTIONS FOR SPECIAL PURPOSES

PRINTING SPECIFIC PAGES ON DIFFERENT PAPER (DIFFERENT PAPER)

In a Windows environment

The front and back covers and specified pages of a document are printed on paper that is different from the other pages. Use this function when you wish to print the front and back covers on heavy paper, or insert colored paper or a different paper type at specified pages.

As necessary, paper can be inserted as insertion sheets where nothing is printed.

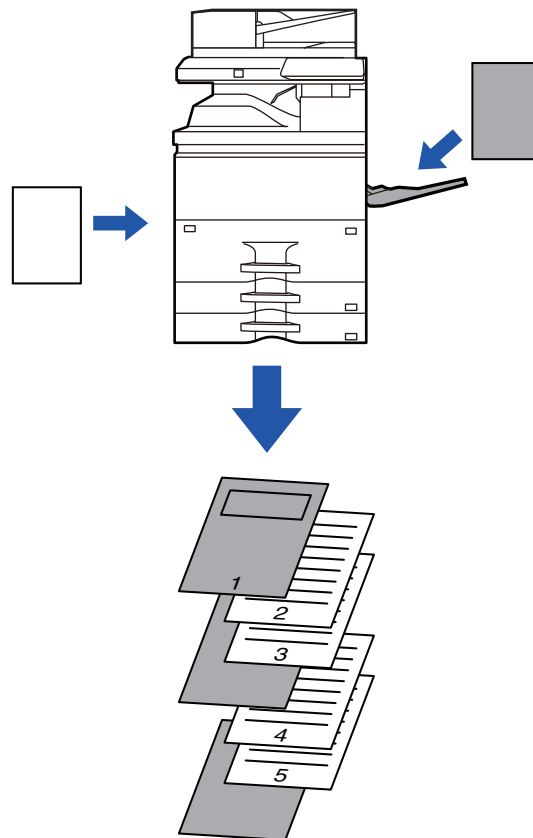

In a macOS environment

The front and back covers are printed using paper that is different from the other pages. This function can be used, for example, when you want to print only the front cover and last page on thick paper.



Windows

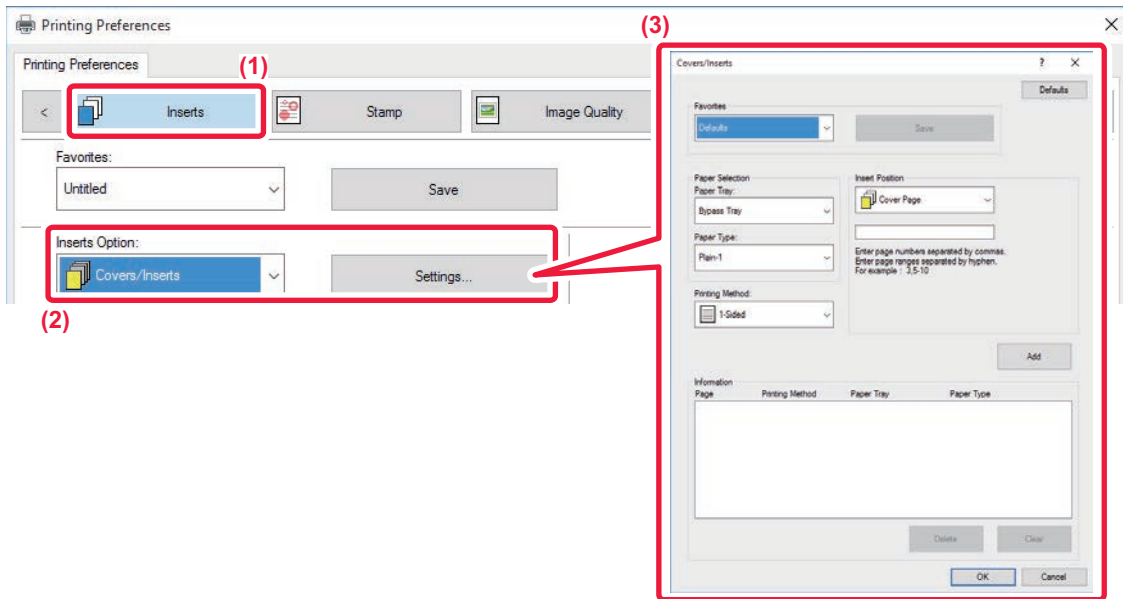

(1) Click the [Inserts] tab.

(2) Select [Covers/Inserts] from [Inserts Option], and click the [Settings] button.

(3) Select the paper insertion settings.

- Select the insertion position, paper source, and printing method from the corresponding menus.
- Click the [Add] button and your settings will appear in "Information".
- When you have finished selecting settings, click the [Save] button in "Favorites" to save the settings.



- When [Bypass Tray] is selected in "Paper Tray", be sure to select the "Paper Type" and load that type of paper in the bypass tray.
- When [Other Page] is selected for "Insert Position", specify the insert position by directly entering a page number. When "Printing Method" is set to [2-Sided Printing], the specified page and the next page after it will be printed on the front and reverse side of the paper, and thus an insert setting at a page printed on the reverse side will not be effective.



macOS

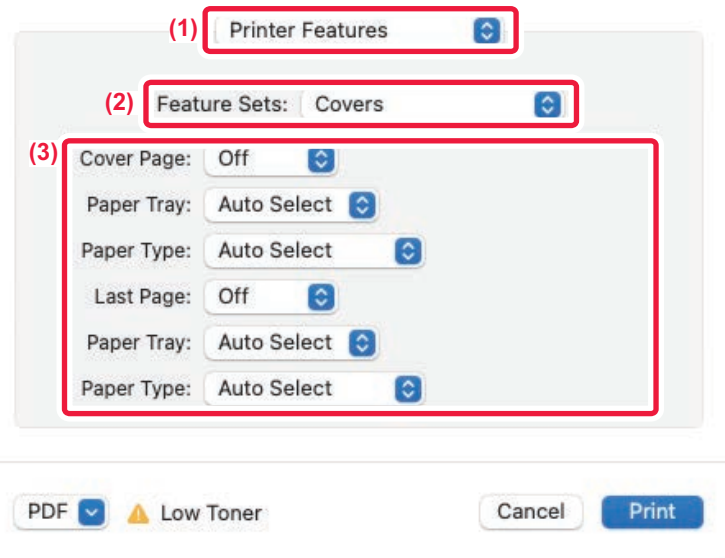

(1) Select [Printer Features].

(2) Select [Covers].

(3) Select the cover insertion settings.

Select the print setting, paper tray, and paper type for the front and back covers.



ADDING INSERTS WHEN PRINTING ON TRANSPARENCY FILM (TRANSPARENCY INSERTS)

When transparency film is used for printing, this function prevents the sheets of transparency film from sticking together by inserting a sheet of paper between each sheet of film. As necessary, the same content as that printed on each sheet of transparency film is also printed on the corresponding sheet of inserted paper.

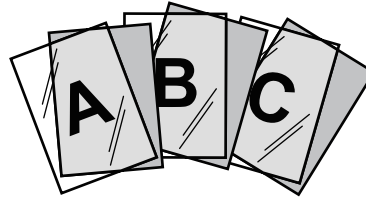

Windows

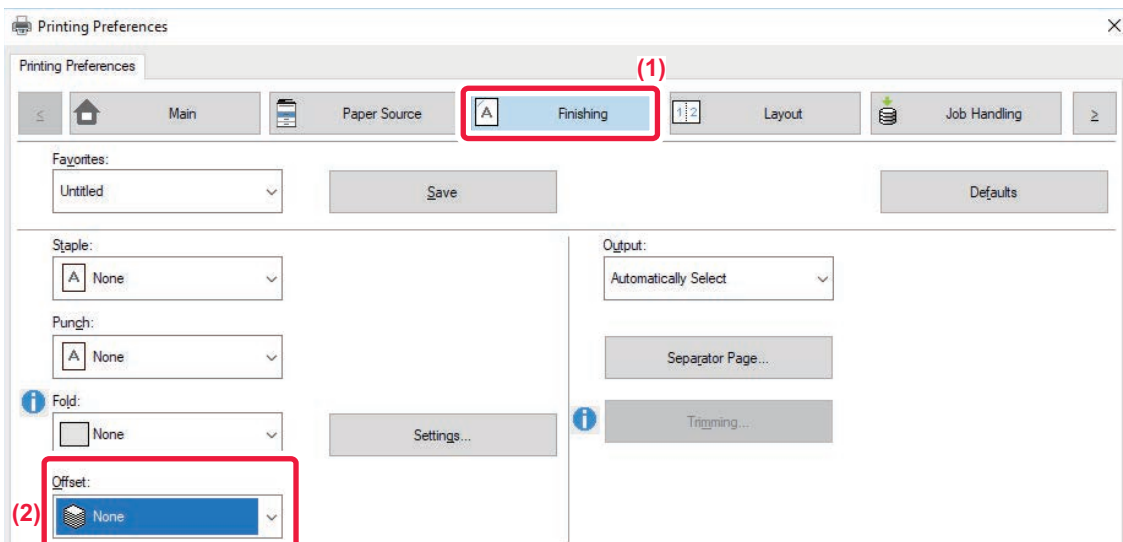

- (1) Click the [Finishing] tab.
Change to 1-sided printing in advance using the 2-sided printing setting.
- (2) Select [None].

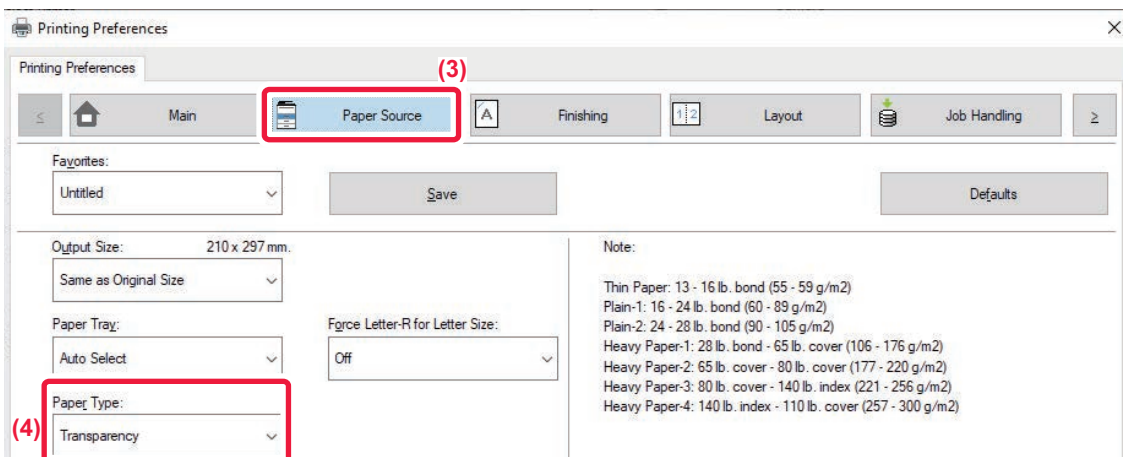

- (3) Click the [Paper Source] tab.
- (4) Select [Transparency].

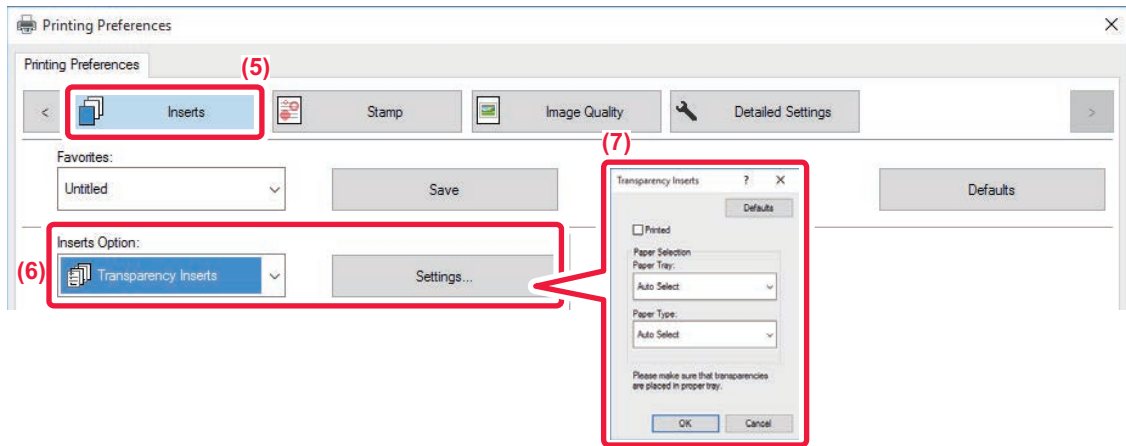

(5) Click the [Inserts] tab.

(6) Select [Transparency Inserts] and click the [Settings] button.

(7) Select the transparency insert settings.

When the [Printed] checkbox is selected to set to , the same content as that printed on the transparency film is also printed on the insert. Select the paper source and type if needed.



Set the paper type of the tray 4 or bypass tray to [Transparency] and load transparency film into the tray 4 or bypass tray.



macOS

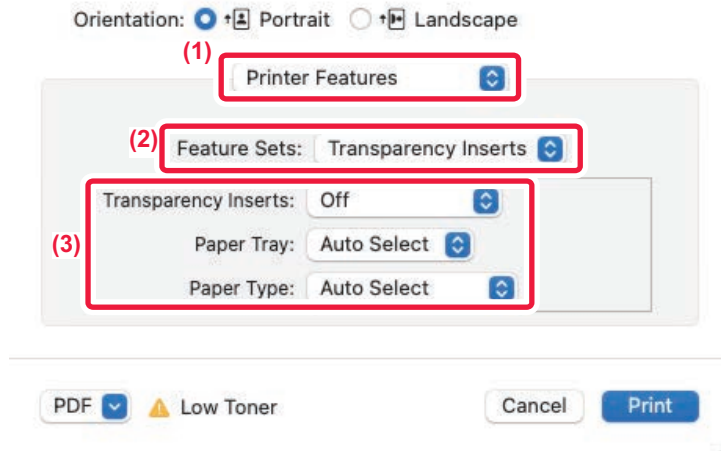

- (1) Select [Printer Features].
- (2) Select [Transparency Inserts] in "Feature Sets".
- (3) Select the transparency insert settings.

When [On (Printed)] is selected from "Transparency Inserts", the same content as that printed on the transparency film is also printed on the insert. Select the paper source and type if needed.



Set the paper type of the tray 4 or bypass tray to [Transparency] and load transparency film into the tray 4 or bypass tray.



INSERTING SEPARATOR PAGES BETWEEN JOBS OR COPIES

You can insert separator pages between jobs or the specified number of copies.

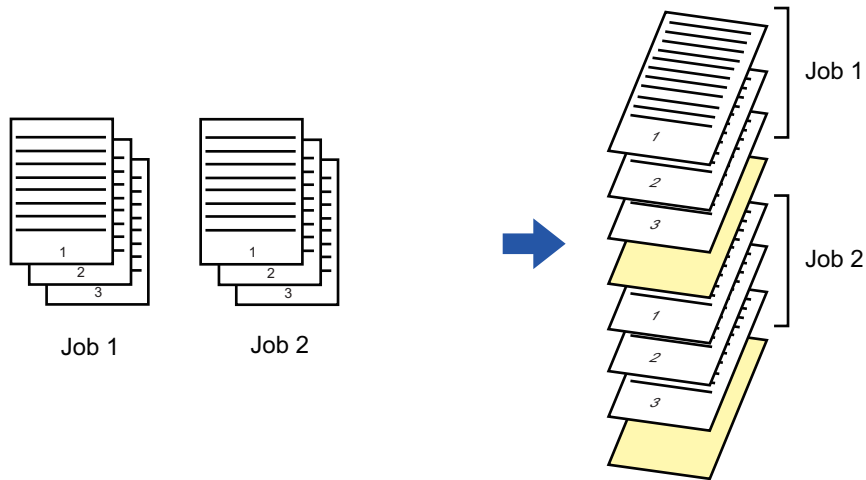

This function is available in a Windows environment.

Windows

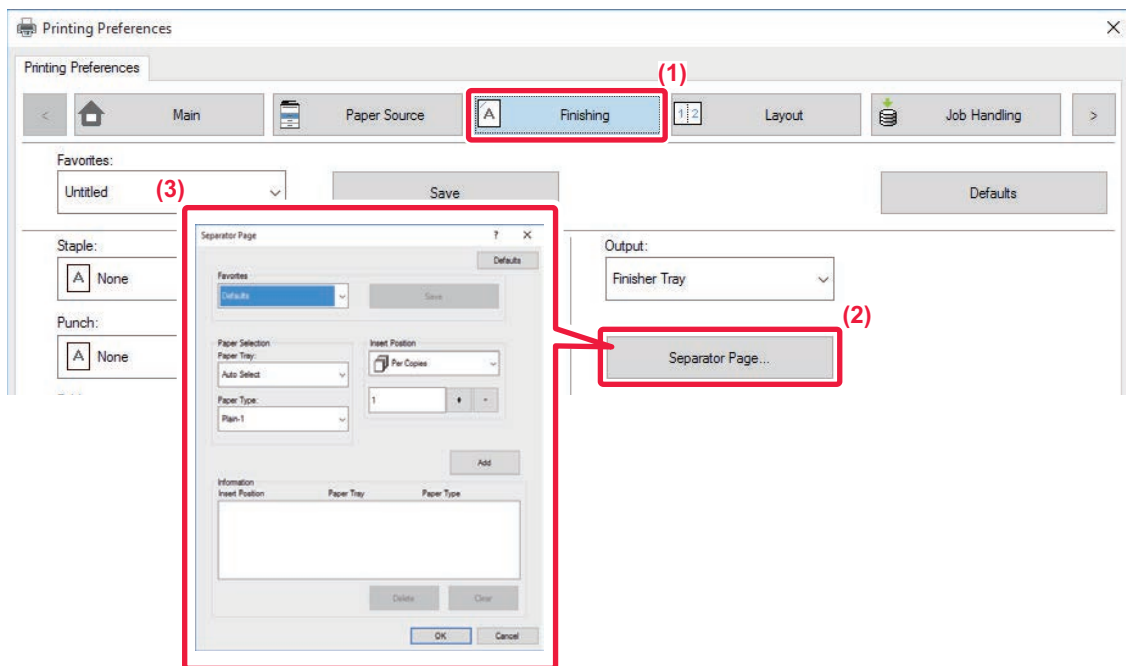

(1) Click the [Finishing] tab.

(2) Click the [Separator Page] button.

(3) Changing the settings

- Select the paper tray and paper type from "Paper Selection", and specify the separator page position in "Insert Position".
- To add a separator page each time printing of the set number of copies is completed, select [Per Copies] in "Insert Position".
- For example, if you are printing 10 copies and you select "5", a separator page will be added after the 5th copy and after the 10th copy.



When the bypass tray is selected, be sure to select the "Paper Type".



PRINTING A CARBON COPY (CARBON COPY)

This function prints an additional copy of the print image on paper that is of the same size but from a different paper tray. For example, if carbon copy print is selected when plain paper is loaded into tray 1 and colored paper is loaded into tray 2, a print result similar to a carbon copy slip is obtained with a single selection of the print command. If plain paper is loaded into tray 1 and recycled paper is loaded into tray 2 as necessary, selecting Carbon Copy simultaneously prints one copy for presentation and one copy as a duplicate.

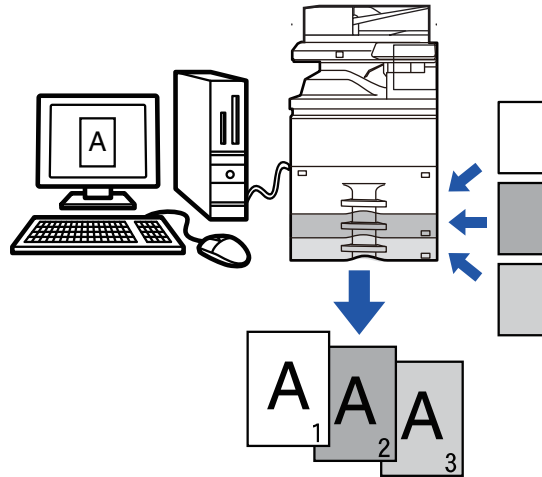

This function is available in a Windows environment.

Windows

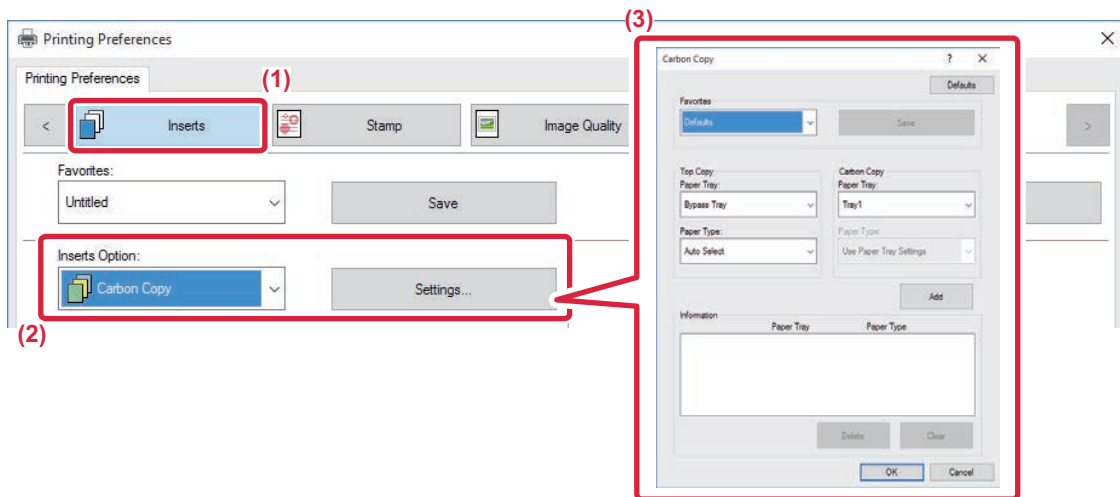

- (1) Click the [Inserts] tab.
- (2) Select [Carbon Copy] from "Inserts Option" and click the [Settings] button.
- (3) Select the tray for the first copy from "Top Copy", and then select the tray for the carbon copy from "Carbon Copy".



When the bypass tray is selected, be sure to select the "Paper Type".



PRINTING TEXT ON TABS OF TAB PAPER (TAB SHIFT/TAB PAPER PRINT)

There are two methods of printing on the tabs of tab paper: "Tab Shift" and "Tab Paper Print".

Tab Shift

Create the text to be printed on tab paper in an application, and set the text shifting distance in [Print Position] on the [Layout] tab of the printer driver property window. The text will be printed on the tabs.

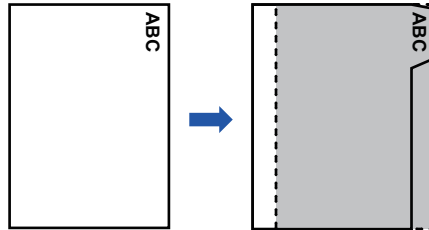

Tab Paper Print (for PCL6 only)

Tab sheets are printed while they are inserted between the desired pages.

Select [Tab Paper] in [Inserts Option] on the [Inserts] tab of the printer driver properties window, and enter the text that you want to print on the tabs. Specify the detailed settings such as the size of the tabs, the starting position, the distance between tabs, and the page numbers where tab sheets will be inserted.

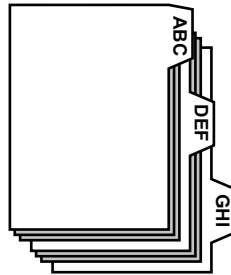

- These functions are available in a Windows environment.
- Tab paper must be loaded into the tray 4 and bypass tray.



Windows

Tab Shift

When you have finished preparing the data to be printed on tab papers in an application, take the following steps:

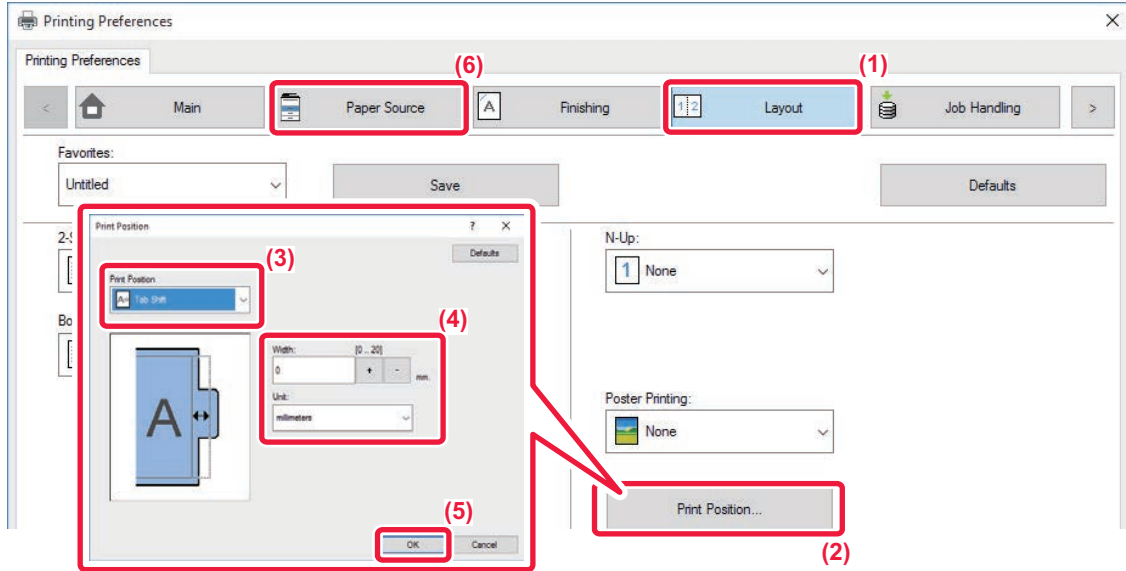

- (1) Click the [Layout] tab.
- (2) Click the [Print Position] button.
- (3) Select [Tab Shift].
- (4) Specify the distance of shifting the image by directly entering a value or by clicking the  button.
- (5) Click the [OK] button.
- (6) Select the paper source and type.

Click the [Paper Source] tab, and select [Tray 4] or [Bypass Tray] in "Paper Tray" and [Tab Paper] in "Paper Type".



- Tab paper can be loaded into tray4 or bypass tray.
- In the machine side, also specify the paper type for the tray with tab paper to be loaded in [Tab Paper].



Tab Paper Print (for PCL6 only)

Open the data into which you wish to insert tab paper, and then select the settings.

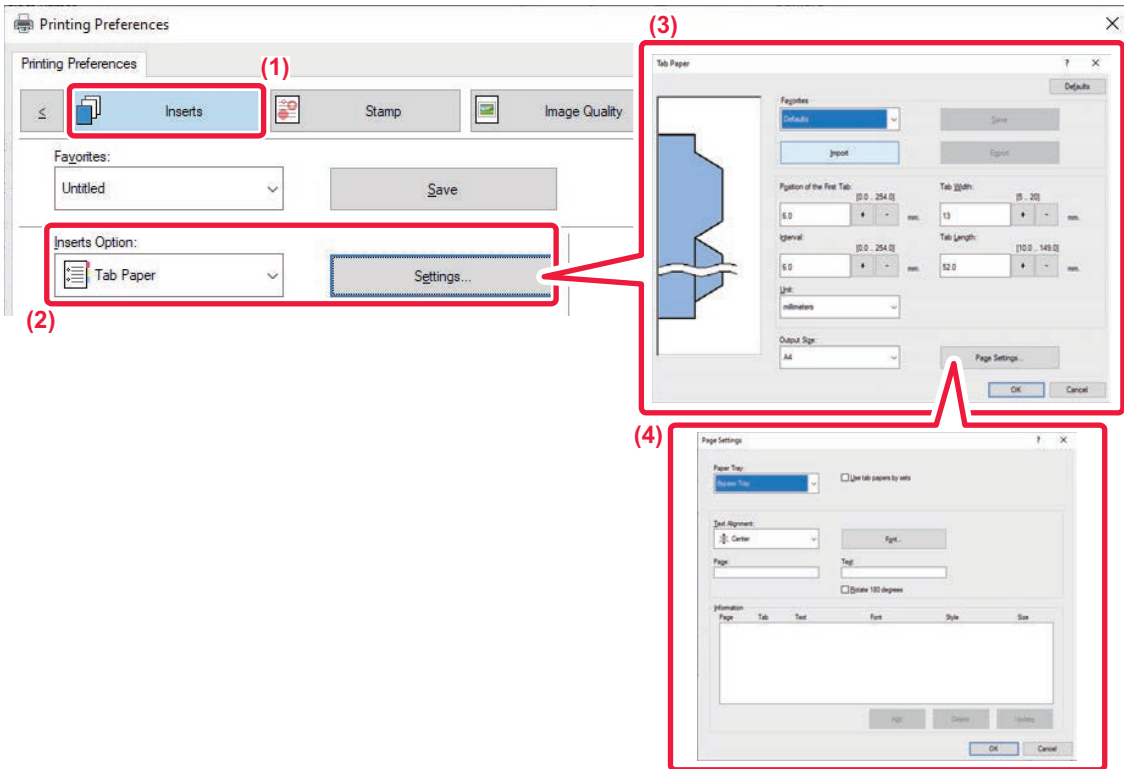

(1) Click the [Inserts] tab.

(2) Select [Tab Paper] from “Inserts Option”, and click the [Settings] button.

(3) Select the tab position settings.

For commercially available tab paper, use the existing settings such as [A4-5tab-D] in "Favorites". For other types of tab paper, the position of the first tab, the distance between tabs, and the horizontal and vertical dimensions of the tab can be directly entered or changed using the + - button. In addition, select the size of the tab paper from "Output Size".

(4) Select the page settings.

Specify the pages where you wish to insert tab paper and enter the text that you wish to print on the tabs. Also select the font and adjust the layout.



- Tab paper can be loaded into tray4 or bypass tray.
- In the machine side, also specify the paper type for the tray with tab paper to be loaded in [Tab Paper].
- The tab paper settings can be stored and a stored file can be opened from "Favorites".



TWO-SIDED PRINTING WITH SPECIFIC PAGES PRINTED ON THE FRONT SIDE (CHAPTER INSERTS)

This function prints specific pages on the front side of the paper.

When you specify a page (such as a chapter cover page) to be printed on the front side of the paper, it is printed on the front side of the next sheet even if it would normally be printed on the reverse side of the paper.



Example: When pages 4 and 8 are specified as page settings.
(4 has a reverse side, and 3 and 8 are blank on the reverse side.)



- This function is available in a Windows environment.
- This function can be used when the PCL6 printer driver is used.

Windows

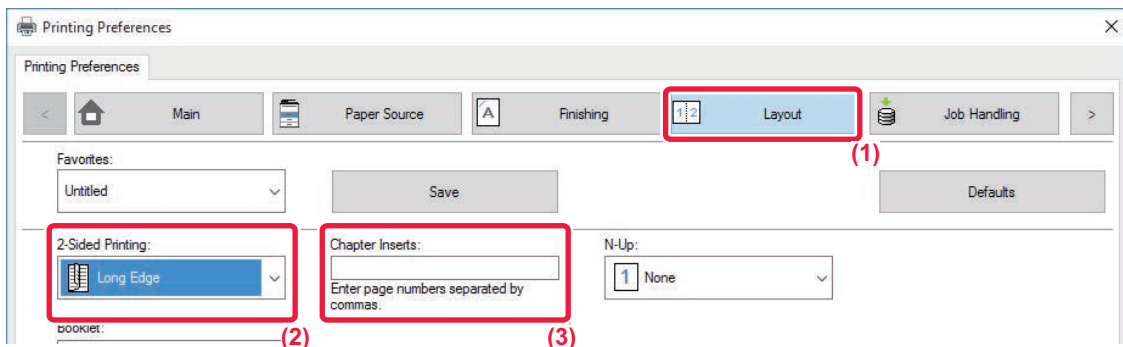

- (1) Click the [Layout] tab.
- (2) Select the 2-Sided Printing.
For information on the "2-Sided Printing" setting, see "[2-SIDED PRINTING \(page 4-19\)](#)".
- (3) Enter the page numbers of the initial pages of the chapters, separating the numbers with commas.



FOLDING PAPER FOR PRINTING (FOLD)

If a folding unit is installed, print paper can be folded.

For example, if A4 (8-1/2" × 11") and A3 (11" × 17") size print images are mixed, you can fold A3 (11" × 17") size paper to the A4 (8-1/2" × 11") size to adjust the width of the actual print paper to the A4 (8-1/2" × 11") size. When necessary, you can staple folded sheets.



To use the Half Fold and Saddle Fold (Staple) functions, you need to mount a saddle stitch finisher.

Types of paper folding functions

Folding types	Print Side	Fold Orientation	Folding results	Description
Saddle Fold	Inside	-		Multiple sheets are collectively folded in the center. When a saddle stitch finisher is installed, one or multiple sheets can be selected.
	Outside	-		
Half Fold	Inside	-		Paper is folded in the center. Copies are output sheet by sheet.
	Outside	-		



Folding types	Print Side	Fold Orientation	Folding results	Description
C-Fold	Inside	Open Right		For example, paper is folded in three so that it can be put into an envelope. Copies are output sheet by sheet.
		Open Left		
	Outside	Open Right		
		Open Left		
Accordion Fold	-	Open Right		For example, paper is folded in three so that it can be put into an envelope. Copies are output sheet by sheet.
	-	Open Left		



Folding types	Print Side	Fold Orientation	Folding results	Description
Double Fold	Inside	Open Right		For example, paper is folded in four so that it can be put into an envelope. Copies are output sheet by sheet.
		Open Left		
	Outside	Open Right		
		Open Left		
Z-Fold	-	Open Right		For example, if A4 (8-1/2" x 11") and A3 (11" x 17") size print images are mixed, only the A3 (11" x 17") size paper is folded and changed to A4 (8-1/2" x 11") size paper. Copies are output sheet by sheet.
	-	Open Left		



- When printing data in a pamphlet layout, the "Booklet" function can be used to conveniently fold and staple printed output to create a pamphlet. See "[CREATE A PAMPHLET \(BOOKLET/SADDLE STITCH\) \(page 4-29\)](#)".
- The Fold function cannot be used together with the Punch and Staple functions. However, when finisher (large capacity) or saddle stitch finisher (large capacity) is installed the Z-Fold function can be used together with the punch and staple functions when one of the following paper size is specified.
 - B4, A3, Ledger (11" × 17")
- When a saddle stitch finisher (large stacker) is mounted, the Saddle Fold function folds five sheets every set. For example, if an original has 12 A4 size plain sheets, they are folded three times in total: 5 sheets + 5 sheets + 2 sheets. However, some types of paper reduces the number of sheets that are folded every set. For example, heavy paper is folded on a three-sheet basis.
- When a saddle stitch finisher is installed, the Saddle Fold function folds sheets one by one.



Windows

Folding

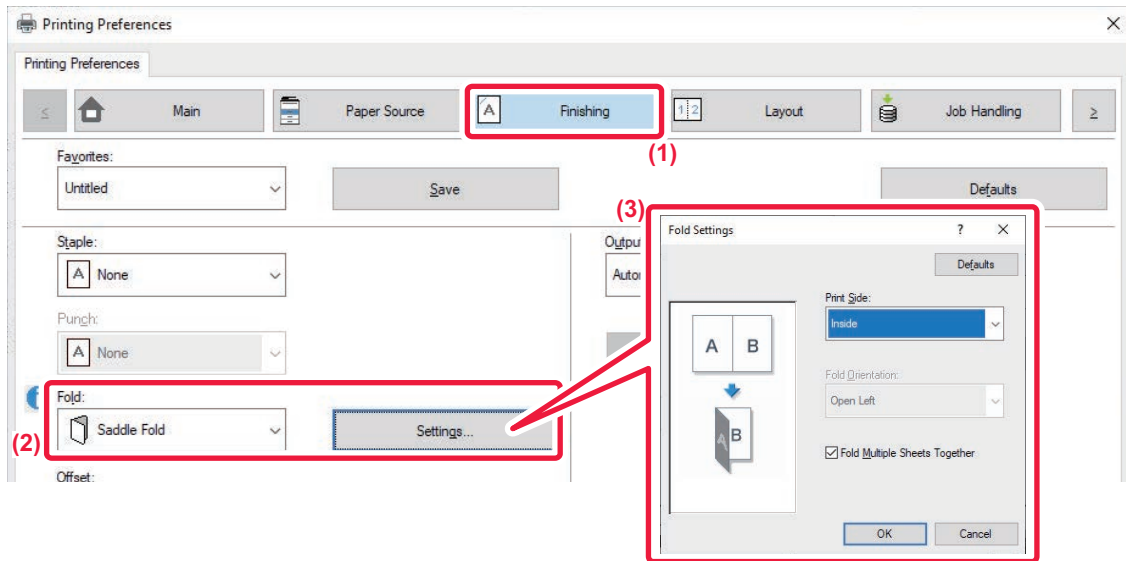

- (1) Click the [Finishing] tab.
- (2) Select the folding method in "Fold", and click the [Settings] button.
- (3) Select the desired folding method.

Folding (Z-Fold)

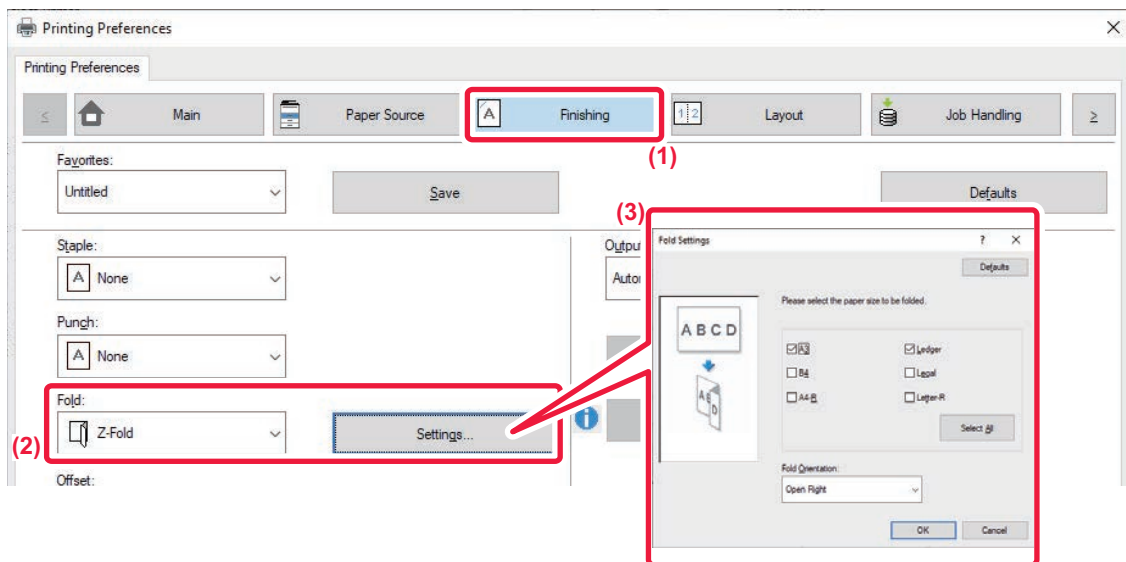

- (1) Click the [Finishing] tab.
- (2) Select the folding method in "Fold", and click the [Settings] button.
- (3) Select the paper to be folded and choose the opening direction.



If you select "Z-Fold", set the checkbox of the paper size for paper folding to .



macOS

Folding

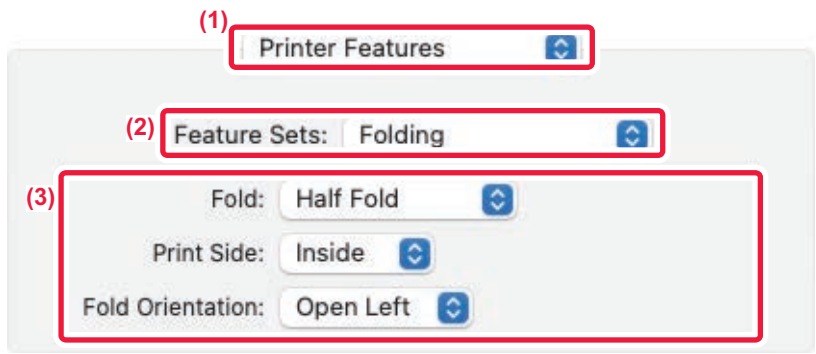

- (1) Select [Printer Features].
- (2) Select [Folding].
- (3) Select the desired folding method.

Folding (Z-Fold)

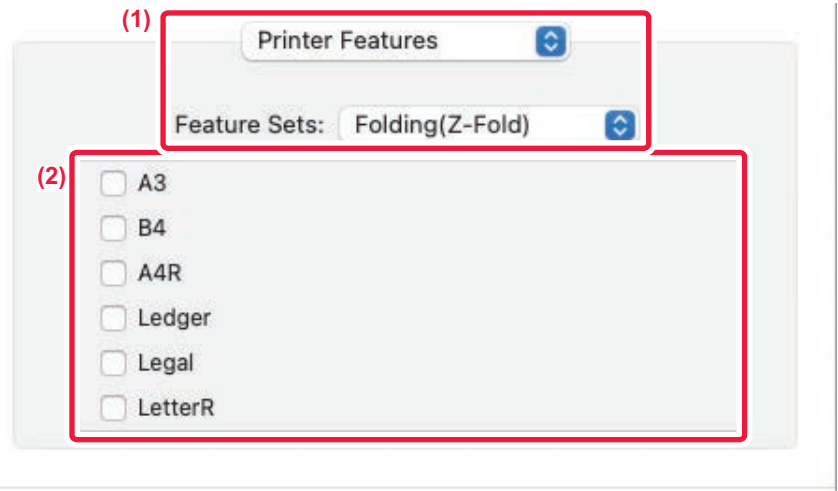

- (1) Select [Printer Features], then select [Folding(Z-Fold)].
- (2) Configure Fold settings.



INSERT PRESET DATA BEFORE OR AFTER EACH PAGE (PAGE INTERLEAVE)

This function inserts a preset data item into every page during printing.

You can easily create documents with opened page spread that is made up of text on the left-hand page and a memo space on the right-hand page.

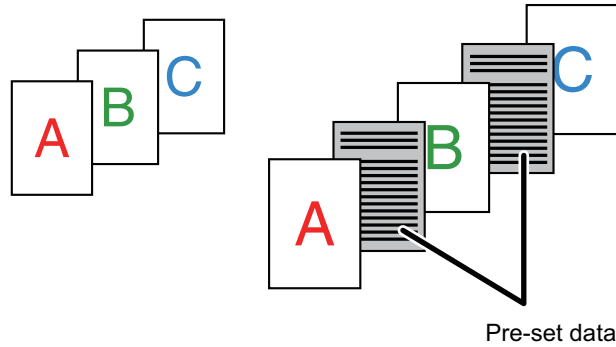

- This function is available in a Windows environment.
- This function can be used when the PCL6 printer driver is used.

Windows



You have to create page data to be inserted in advance.

For the procedure for creating page data, see "[Creating an overlay file \(page 4-53\)](#)" in "[OVERLAY A FIXED FORM ON THE PRINT DATA \(OVERLAYS\) \(page 4-53\)](#)".

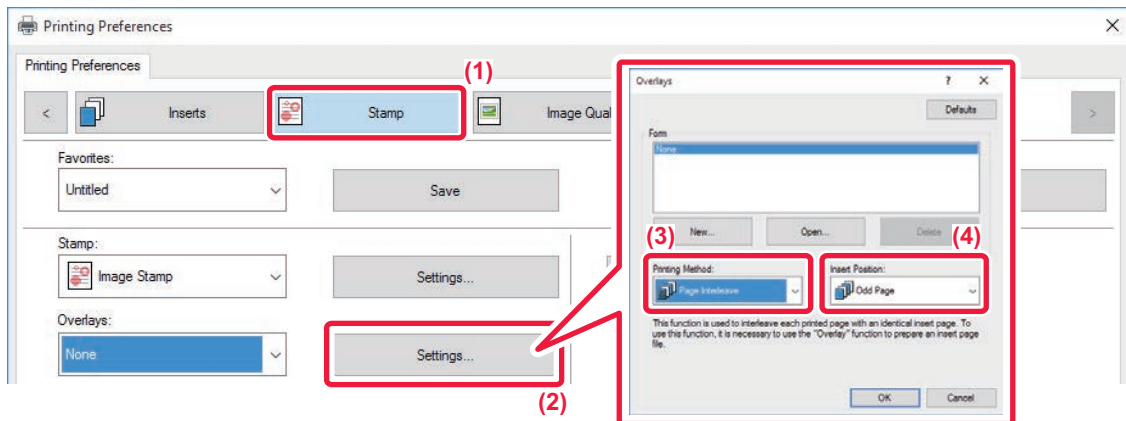

- (1) Click the [Stamp] tab.
- (2) Click the [Settings] button.
- (3) Select [Page Interleave] from the "Printing Method".
- (4) Set the overlay data to be inserted and set its insertion position.



PRINT THE SAME IMAGE IN TILE PATTERN (REPEAT PRINT)

This function prints the same image in tile pattern on a sheet. This is useful for producing name cards and stickers.

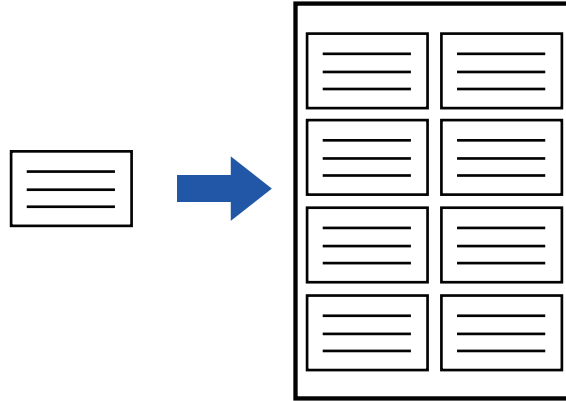

- This function is available in a Windows environment.
- This function can be used when the PCL6 printer driver is used.

Windows

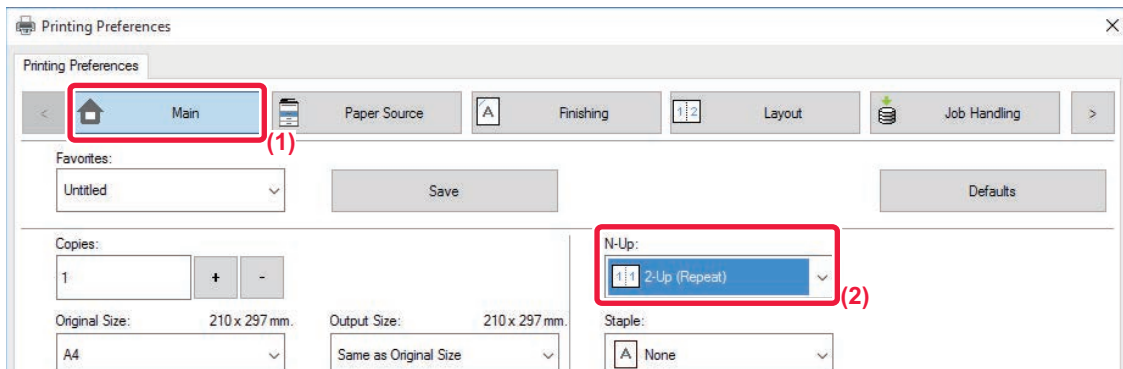

- (1) Click the [Main] tab.
- (2) Select the repeat count in "N-Up".



PRINTING PATTERN DATA (HIDDEN PATTERN PRINT)

This function prints pattern data such as "DO NOT COPY" behind the print data.

If paper with pattern data is duplicated, the pattern data emerges in the background, which will help to prevent information from being leaked through unauthorized document copying.

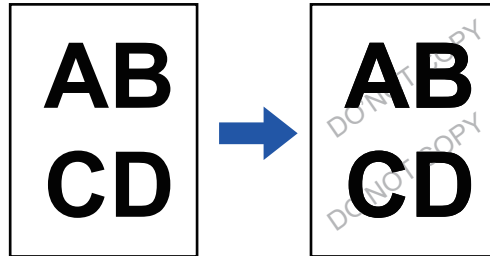

- This function is available in a Windows environment.
- This function can be used when the PCL6 printer driver is used.

Windows

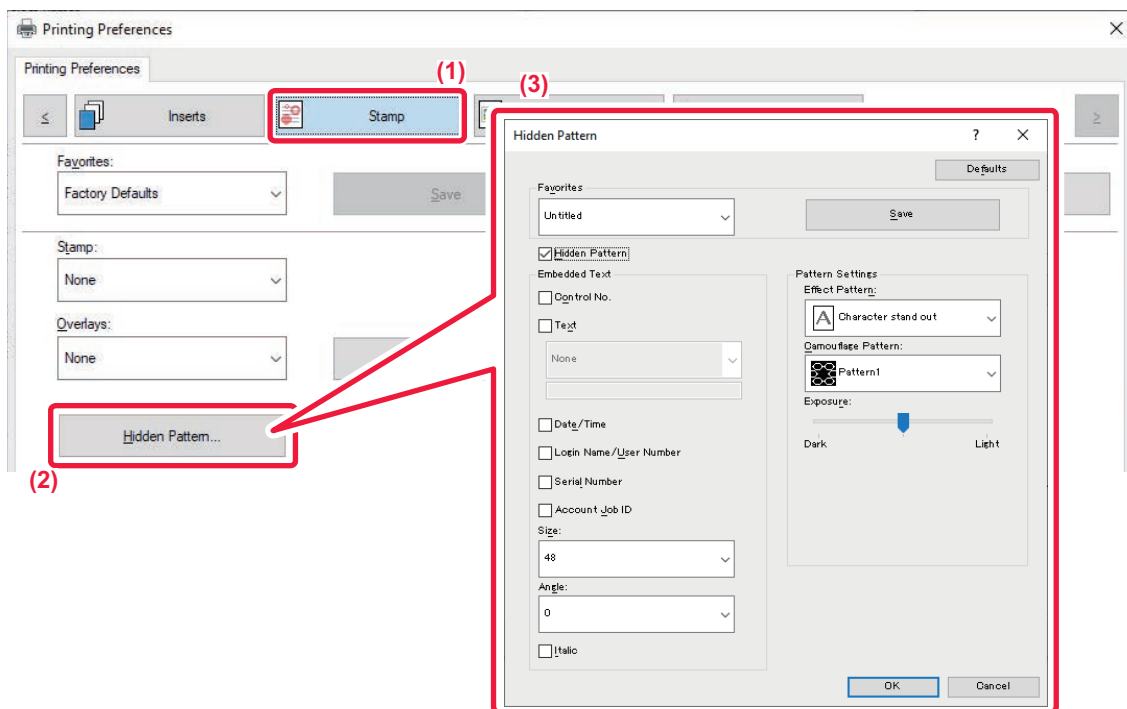

- (1) Click the [Stamp] tab.
- (2) Click the [Hidden Pattern] button.
- (3) Configure the settings for hidden pattern printing and click the [OK] button.



The hidden pattern printing function cannot be used when "Print Mode" is set to [1200 dpi].



-
- "Hidden Pattern" is a function provided for the purpose of deterring unauthorized printing. It does not guarantee the prevention of information leakage.
 - Text may not be completely hidden on an output sheet with a pattern print under certain machine conditions. In "Settings (administrator)", select [Security Settings] → [Hidden Pattern Print Setting] → [Contrast] if this is the case.
 - The hidden pattern may not emerge on copies with certain types of devices or under certain setting conditions used to copy an output sheet with a pattern print.
-



CHANGING THE RENDERING METHOD AND PRINTING JPEG IMAGES (USE DRIVER TO RENDER JPEGS)

In some situations, a document containing a JPEG image may not be printed correctly. This can be solved by changing the way the JPEG image is rendered.

When you print an original containing JPEG images, this function allows you to select whether the images are rendered in the printer driver or the machine.



- This function is available in a Windows environment.
- When images are rendered in the printer driver, it may take time until the printing is completed.

Windows

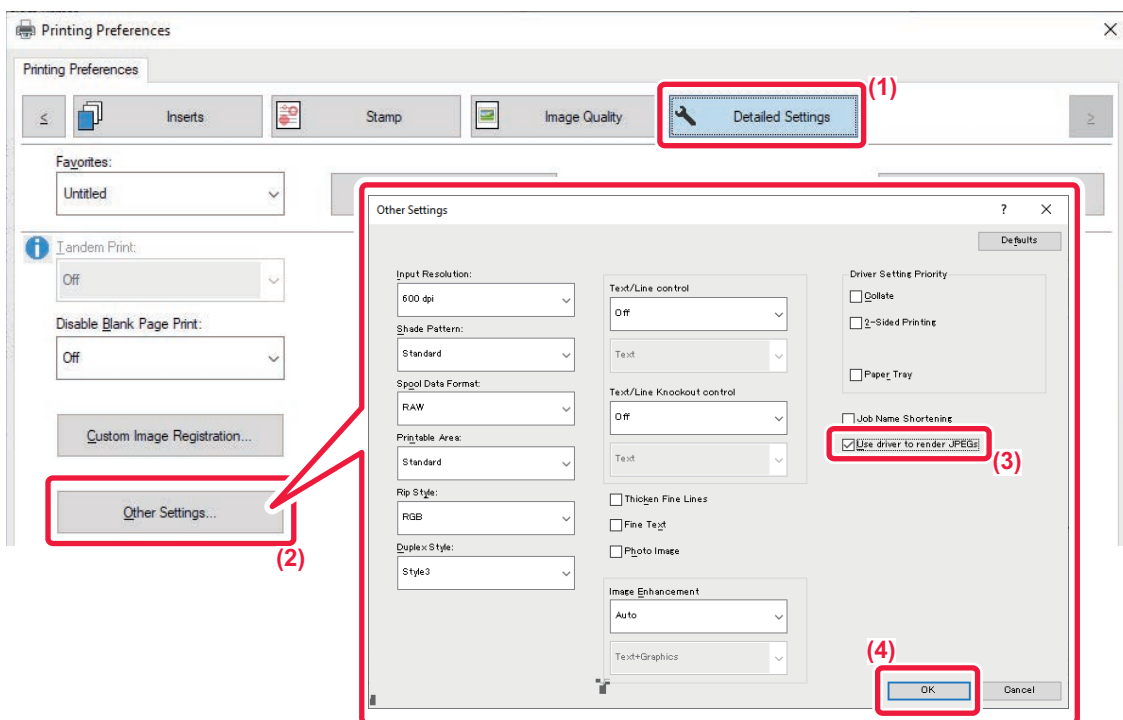

- (1) Click the [Detailed Settings] tab.
- (2) Click the [Other Settings] button.
- (3) Click the [Use driver to render JPEGs] checkbox so that appears.
- (4) Click the [OK] button.



MAXIMIZING THE PRINT AREA ON THE PAPER (PRINT AREA)

By maximizing the print area, you can print on the full paper size.

This function is available in a Windows environment.

Even when the print area is maximized, edges may be cut off.

Windows

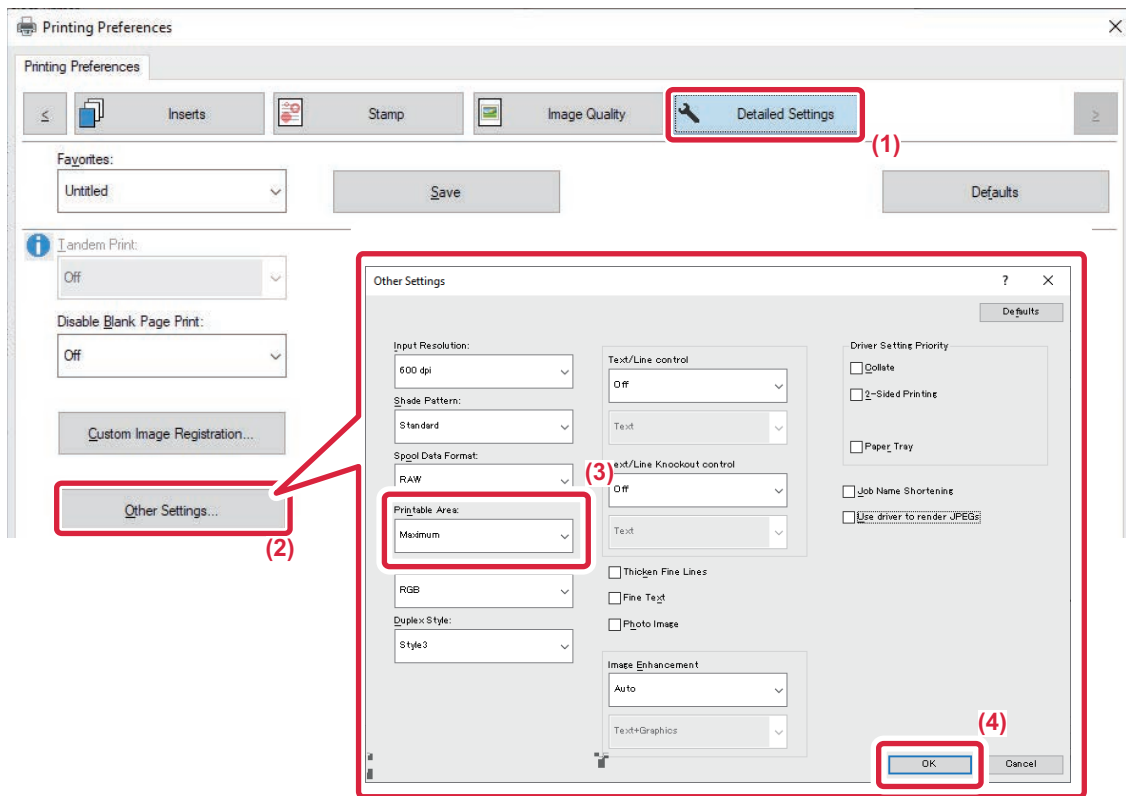

- (1) Click the [Detailed Settings] tab.
- (2) Click the [Other Settings] button.
- (3) Select [Maximum] from the "Printable Area".
- (4) Click the [OK] button.



CONVENIENT PRINTER FUNCTIONS

USING TWO MACHINES TO PRINT A LARGE PRINT JOB (TANDEM PRINT)

To use this function, two machines that can perform tandem printing are required.

Two machines connected to the same network are used to run a large print job in parallel. This function reduces the printing time when you handle a large number of prints.

Example: Printing four sets of copies (2 set of copies are executed by the primary and secondary units each)

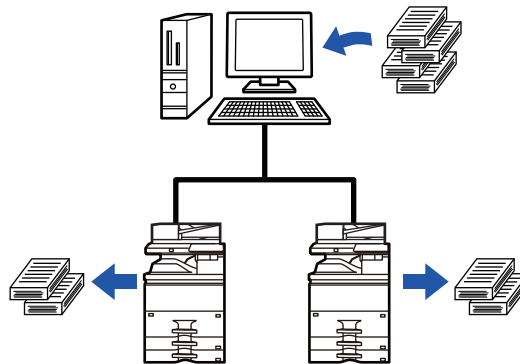

This function is available in a Windows environment.



To use the tandem print function, the IP address of the secondary unit must be registered in the printer driver.

Windows

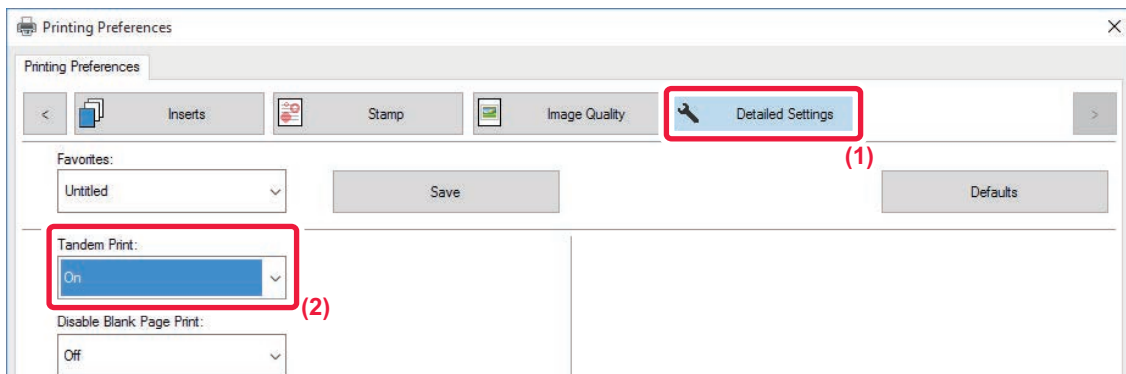

(1) Click the [Detailed Settings] tab.

(2) Select [On] in "Tandem Print".



The tandem print function can be used only when the printer driver has been installed using "Custom Installation" with [LPR Direct Print (Specify Address/Auto Search)] selected and with the [Yes] checkbox selected for "Do you want to use Tandem Print function?".



SAVING AND USING PRINT FILES (DOCUMENT FILING)

This function stores a print job as a file on the machine's local drive, allowing the job to be printed from the touch panel when needed. The location for storing a file can be selected to prevent the file from being mixed together with files of other users.

- **Hold Only**

This setting is used to hold a print job on the machine's local drive without printing it.

- **Hold After Print**

This setting is used to hold a print job on the machine's local drive after it is printed.

- **Sample Print**

When a print job is sent to the machine, only the first set of copies is printed. After checking the contents of the first set of copies, you can print the remaining sets from the operation panel of the machine. This prevents the occurrence of excessive misprints.

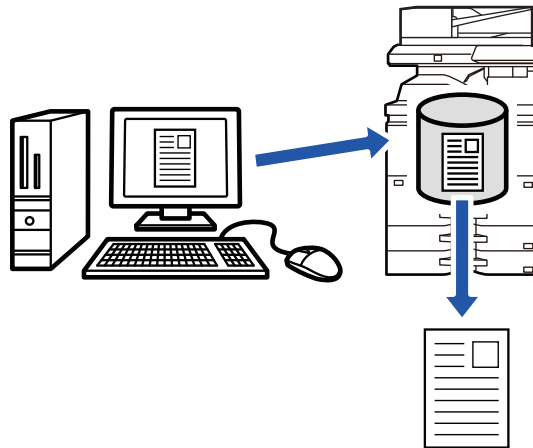

- For the procedure for printing files stored on the machine's local drive, see "[FILE PRINTING \(page 7-24\)](#)" in "Document Filing".
 - When printing from a PC, you can set a password (4 to 8 digits) to maintain the confidentiality of information in a stored file. When a password is set, the password must be entered to print data.
 - [Document Filing] that can be set on the [Job Handling] tab can also be set on the [Main] tab.
-



Windows

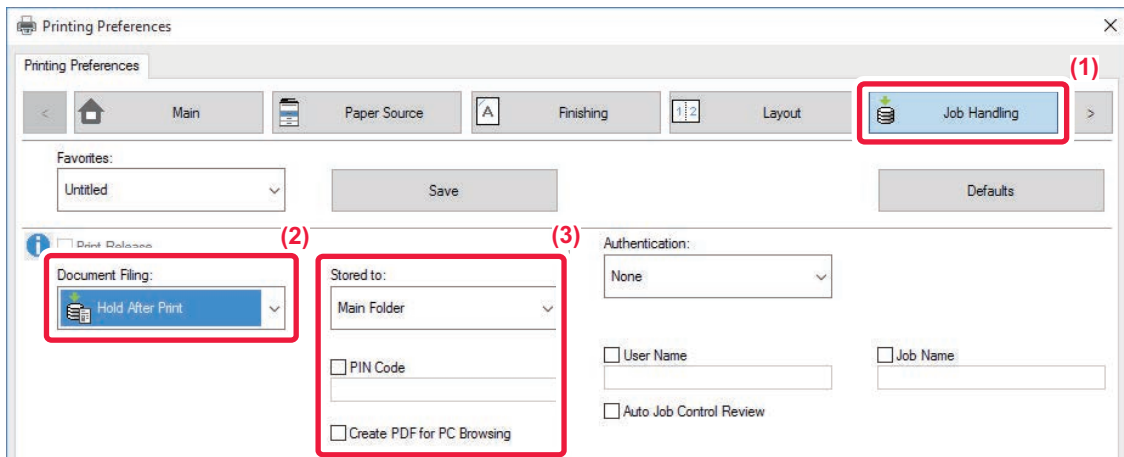

- (1) Click the [Job Handling] tab.
- (2) Select the function from the "Document Filing".
- (3) Select the folder for storing the file in "Stored to".

To enter a password (4 to 8 digit number), click the [PIN Code] checkbox so that the checkmark appears.
To create a public PDF for PC browsing, select the [Create PDF for PC Browsing] checkbox (.



- When [Quick File] is selected, "Document Filing" will be set to [Hold After Print].
- When [Quick File] is selected, the password entered in "Document Filing" is cleared.
- If necessary, you can select the data format from CMYK and RGB for data to be stored in the machine. Click the [Other Settings] button on the [Detailed Settings] tab and select the format from "Rip Style".
- To store a file in a custom folder, you must first create the custom folder using [Document Operations] in "Settings (administrator)" → [Document Filing]. If you have set a password for the custom folder, enter the password (5 to 8 digit number) in "PIN Code" on the stored to screen.



If you have configured to always use the force document filing function in "Printing Policy" on the [Configuration] tab, you cannot clear the [Document Filing] checkbox.



macOS

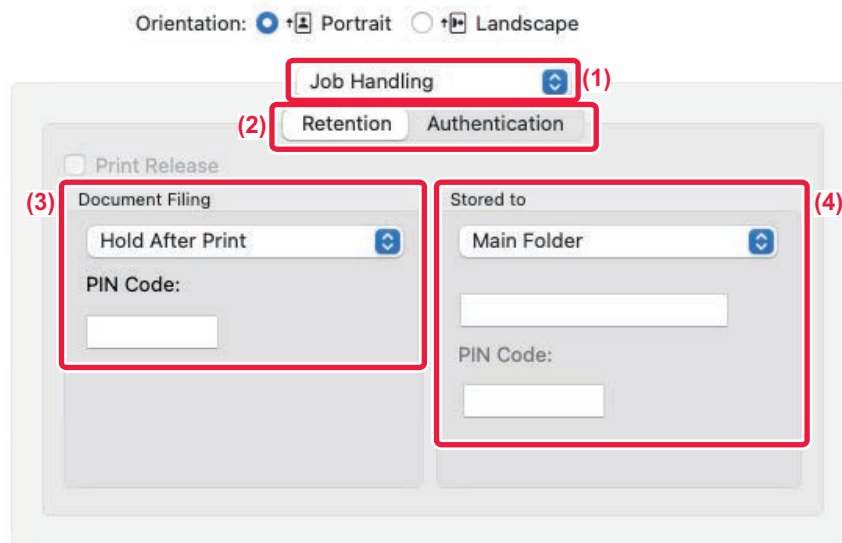

(1) Select [Job Handling].

(2) Select [Retention].

(3) Select how to save the print data in "Document Filing".

If necessary, you can enter a password (4 to 8-digit number).

(4) Select the folder to store the file in "Stored To".

If you selected [Custom Folder], enter the name of the custom folder where you want to save the file.



- When [Quick File] is selected, "Document Filing" will be set to [Hold After Print].
- When [Quick File] is selected, the password entered in "Document Filing" is cleared.
- If necessary, you can select the data format from CMYK and RGB for data to be stored in the machine. Select [Advanced1] in [Printer Features] and select the format from "Rip Style".
- To store a file in a custom folder, you must first create the custom folder using [Document Operations] in "Settings (administrator)" → [Document Filing]. If you have set a password for the custom folder, enter the password (5 to 8 digit number) in "PIN Code" on the folder selection screen.



AUTOMATICALLY PRINT ALL STORED DATA

When user authentication is enabled on the machine, all document filing (stored) print jobs of the user who logs in are automatically printed. After all jobs are printed, the stored jobs are deleted.



- To use the Print All function, the following steps are necessary:
In "Settings (administrator)", select [System Settings] → [Authentication Settings] → [Default Settings] and enable [Automatically print stored jobs after login].
- When executing document filing print, in addition to the user authentication information, click on the "User Name" checkbox to enter a user name.
Using this function in a Windows environment: [PRINTING IN A WINDOWS ENVIRONMENT \(page 4-4\)](#)
Using this function in a macOS environment: [PRINTING IN A macOS ENVIRONMENT \(page 4-14\)](#)



Files with a password and files that are protected by the document filing function of the machine will not be printed. Files in a folder (excluding My Folder) that has a password will also not be printed.

(1) Select [Job Handling].

(2) After logging in to the machine, a confirmation message will appear, and then tap the [OK] key.

The print files stored in the quick file folder, main folder, and custom folder will be printed automatically and then deleted.



PRINTING AND SENDING SIMULTANEOUSLY

This function prints data created in an application from the machine and simultaneously sends the data to the addresses stored in the machine.

This function allows you to complete two tasks, printing and sending, with one operation from the printer driver.



- Addresses must be stored in advance in the machine. For more information, see "[STORING ADDRESSES THROUGH DIRECT ENTRY \(page 6-19\)](#)".
- You must complete the preparatory steps for using each sending function of the machine. For more information, see the explanation of each sending function.



- This function is available in a Windows environment.
- This function can be used when the PCL6 printer driver is used.

Windows

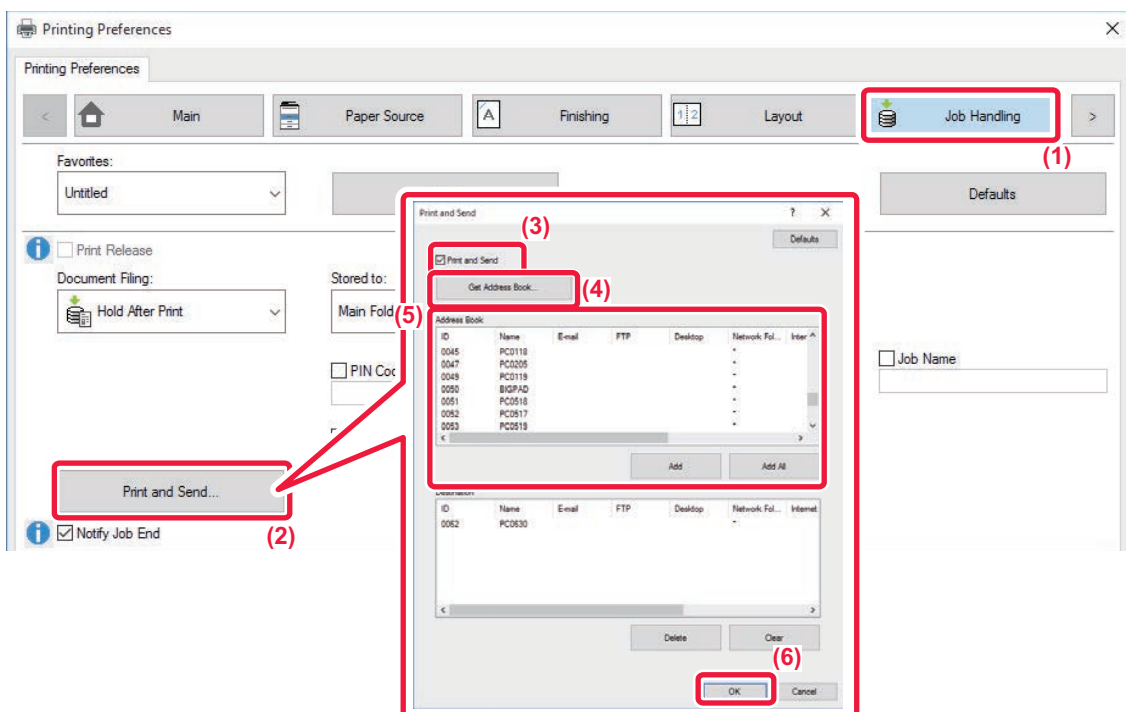

- (1) Click the [Job Handling] tab.
- (2) Click the [Print and Send] button.
- (3) Select the [Print and Send] checkbox so that appears.
- (4) Click the [Get Address Book] button.
- (5) From the "Address Book" list, select the address to which you wish to send the data, and click the [Add] button to add the address to the "Destination" list.
 - If you wish to send the data to all addresses, click the [Add All] button.
 - To delete an address from the "Destination" list, select the address and click the [Delete] button. If you wish to delete all addresses, click the [Delete All] button.



- Up to 50 destinations can be specified.
- Data cannot be sent to an Internet Fax address.

- (6) Click the [OK] button.
The printer driver settings are applied to sending settings.



PRINTING WITHOUT THE PRINTER DRIVER

EXTENSION OF PRINTABLE FILES

When you do not have the printer driver installed on your PC, or when the application used to open a file that you wish to print is not available, you can print directly to the machine without using the printer driver.

The file types (and corresponding extensions) that can be printed directly are shown below.

File Type	TIFF	JPEG	PNG	PCL	PS	PDF, Encrypt PDF, Compact PDF	DOCX, XLSX, PPTX
Extension	tiff, tif	jpeg, jpg, jpe, jif	png	pcl, prn	ps, prn	pdf	docx, xlsx, pptx



Some files may not print correctly even if shown in the above table.

DIRECTLY PRINTING A FILE ON AN FTP SERVER

When an FTP server is configured, you can directly select and print files on the FTP server from the touch panel of the machine. This function eliminates the need for downloading the files from the FTP server to your PC and sending print jobs from the PC to the machine.



When you select a PDF file that has a password, you must enter the password in the job status screen to begin printing.
[PRINTING AN ENCRYPTED PDF FILE \(page 4-98\)](#)

1

Tap the [File retrieve] key.



2

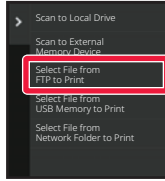

Tap the [Select File from FTP to Print] key on the action panel.

3

Tap the key of the FTP server that you wish to access.

When a server is selected, entry of a user name and password may be necessary. Enter your user name and password, and tap the [Enter] key.

4

Tap the key of the file that you wish to print, and tap the [Choose Print Settings] key on the action panel.

- When printing multiple files, tap the keys of the files you wish to print, and tap the [Print] key on the action panel.
- The icon appears to the left of keys of files that can be printed.
- The icon is displayed to the left of keys of folders on the FTP server. To display a folder or a file in a folder, tap this key.



- A total of 100 keys of files and folders can be displayed.
- Tap to move up one folder level.
- When you move down a folder level by tapping a folder key, appears. Tap this key to return to the file or folder name selection screen.
- Tap to switch to thumbnails.
- Tap the [File or Folder Name] key to change the order of the files and folders displayed on the screen. Each time the key is tapped, the order changes between ascending and descending.
- When you tap [Filter by File Type] in the action panel, the screen to specify the file format will be displayed. Select the file format you want to narrow down, and tap the [OK] key to display the list of files narrowed down to the selected file format. You can select other file formats in [Other].
- The file format that can be selected by narrowing down the list is always the same, regardless of the installation status of the peripheral device. There are some file formats that cannot be used depending on the status of the machine. When you select a file format that this machine does not support for printing, the [Start] key will be grayed out and you will not be able to print.

5

Select the print conditions.

- If you have selected multiple files in step 4, you can select only the number of prints.
- If you selected a PS or PCL file that includes print conditions in step 4, the print conditions in the file will be given priority.

6

Tap the [Start] key.

Printing begins after the selected file is downloaded.



DIRECTLY PRINTING A FILE IN USB MEMORY

Files in a USB memory device connected to the machine are printed from the operation panel of the machine without using the printer driver.

When the printer driver of the machine is not installed on your PC, you can copy a file into a commercially available USB memory device and connect the device to the machine to print the file directly.



- Use FAT32, NTFS or exFAT format for USB memory device.
- When the format of the USB memory device is FAT32, use a 32 GB or less USB memory device.



When you select a PDF file that has a password, enter the password in the job status screen to begin printing.
[PRINTING AN ENCRYPTED PDF FILE \(page 4-98\)](#)

1

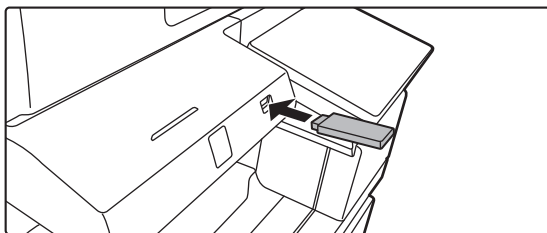

Connect the USB memory device to the machine.

2

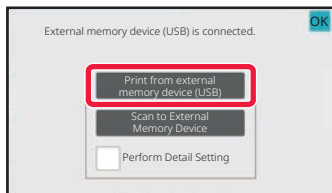

When the screen for selecting the action appears, tap [Print from external memory device (USB)].

If the screen does not appear, follow the steps below.

- (1) Tap the [File retrieve] key.
- (2) Tap the [Select File from USB Memory to Print] key on the action panel.

3

Tap the key of the file that you wish to print, and tap the [Choose Print Settings] key on the action panel.

- When printing multiple files, tap the keys of the files you wish to print, and tap the [Print] key on the action panel.
- The icon appears to the left of keys of files that can be printed.
- The icon is displayed to the left of keys of folders in the USB memory device. To display a folder or a file in a folder, tap this key.



- A total of 500 keys of files and folders can be displayed.
- Tap to move up one folder level.
- When you move down a folder level by tapping a folder key, appears. Tap this key to return to the file or folder name selection screen.
- Tap to switch to thumbnails.
- Tap the [File or Folder Name] key to change the order of the files and folders displayed on the screen. Each time the key is tapped, the order changes between ascending and descending.



4

Select the print conditions.

- If you have selected multiple files in step 3, you can select only the number of prints.
- If you selected a PS or PCL file that includes print conditions in step 3, the print conditions in the file will be given priority.

5

Tap the [Start] key.

Printing begins after the selected file is transferred.

6

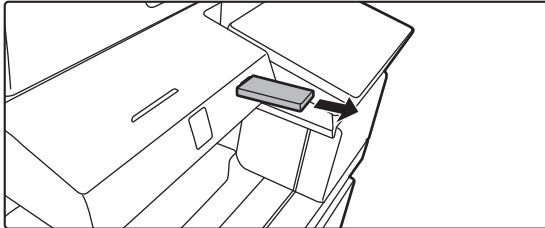

Remove the USB memory device from the machine.

DIRECTLY PRINTING A FILE IN A NETWORK FOLDER

You can specify and print a file in a network folder from the touch panel of the machine.

Even if the network folder is not registered, you can access the network folder by directly entering or referring to the path to the folder in the workgroup.



To register a network folder:

In "Settings (administrator)", select [System Settings] → [Printer Settings] → [Direct Print Settings (Network Folder)].



When you select a PDF file that has a password, you must enter the password in the job status screen to begin printing.

[PRINTING AN ENCRYPTED PDF FILE \(page 4-98\)](#)



PRINTING A FILE IN THE NETWORK FOLDER YOU HAVE CONFIGURED IN THE MACHINE'S SETTINGS

1

Tap the [File retrieve] key.

2

Tap the [Select File from Network Folder to Print] key on the action panel.

3

Tap the [Open Registered Network Folder.] key on the action panel and tap the network folder that you wish to access.



If a screen appears prompting you to enter a user name and password, check with your server administrator and enter the appropriate user name and password.





- When you tap the [Direct Input of Folder Path] key, a screen appears to allow direct input of the network folder path. For more information, see "[Entering the network folder path directly \(page 4-91\)](#)".
- When you select the workgroup, server, and network folder in sequence, you can access the network folder. For more information, see "[Referring to the network folder path \(page 4-92\)](#)".

4

Tap the key of the file that you wish to print, and tap the [Choose Print Settings] key on the action panel.

- When printing multiple files, tap the keys of the files you wish to print, and tap [Print] on the action panel.
- The  icon appears to the left of keys of files that can be printed.
- The  icon is displayed to the left of keys of folders in the network folder. To display a folder or a file in a folder, tap this key.
- When you tap [Filter by File Type] in the action panel, the screen to specify the file format will be displayed. Select the file format you want to narrow down, and tap [OK] key to display the list of files narrowed down to the selected file format. [Others] allows you to select other file types.
- The file formats that can be selected by narrowing down the list are always the same, regardless of the status of the peripheral device. Some file formats may not be available depending on the status of the unit. When you select a file format that this machine does not support for printing, the [Start] key will be grayed out and you will not be able to print.



- A total of 100 keys of files and folders can be displayed.
- Tap  to move up one folder level.
- To return to the network folder selection screen, tap .
- Tap  to switch to thumbnails.
- Tap the [File or Folder Name] key to change the order of the files and folders displayed on the screen. Each time the key is tapped, the order changes between ascending and descending.
- When you tap the [Filter by File Type] in the action panel. The screen to specify the file format will be displayed. Select the file format you want to narrow down, and tap the [OK] key to display the list of files narrowed down to the selected file format.
You can select other file formats in [Other].
- The file format that can be selected by narrowing down the list is always the same, regardless of the installation status of the peripheral device. There are some file formats that cannot be used depending on the status of the machine. When you select a file format that this machine does not support for printing, the [Start] key will be grayed out and you will not be able to print.



5

Select the print conditions.

- If you have selected multiple files in step 4, you can select only the number of prints.
- If you selected a PS or PCL file that includes print conditions in step 4, the print conditions in the file will be given priority.

6

Tap the [Start] key.

Printing begins after the selected file is transferred.

Entering the network folder path directly

1

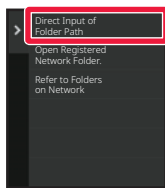

Tap [Direct Input of Folder Path] in step 3 of [“PRINTING A FILE IN THE NETWORK FOLDER YOU HAVE CONFIGURED IN THE MACHINE'S SETTINGS \(page 4-90\)”](#).

2

Enter the path to the folder, user name and password.

Access the network folder.

For the procedure for printing, see steps 4 to 6 of "Printing a file in the network folder you have configured in the machine's settings".



Referring to the network folder path

1

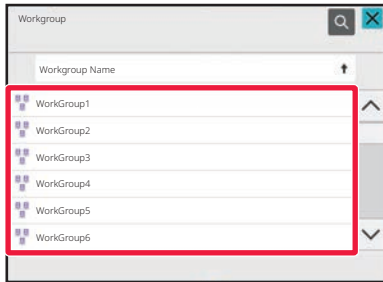

Tap the key of the workgroup that you wish to access in step 3 of "[PRINTING A FILE IN THE NETWORK FOLDER YOU HAVE CONFIGURED IN THE MACHINE'S SETTINGS \(page 4-90\)](#)".

2

Tap the key of the server or computer that you wish to access.

If a screen appears prompting you to enter a user name and password, check with your server administrator and enter the appropriate user name and password.



3

Tap the key of the network folder that you wish to access.

Access the network folder.

For the procedure for printing, see steps 4 to 6 of "[PRINTING A FILE IN THE NETWORK FOLDER YOU HAVE CONFIGURED IN THE MACHINE'S SETTINGS \(page 4-90\)](#)".



- Tap the  icon and enter a keyword to search for a workgroup, server, or network folder. To enter text, see "[STORING ADDRESSES THROUGH DIRECT ENTRY \(page 6-19\)](#)".
- Up to 100 workgroups, 100 servers, and 100 network folders are displayed.
- Tap  to move up one folder level.
- To return to the workgroup selection screen, tap .



DIRECTLY PRINTING FROM A COMPUTER

SUBMIT PRINT JOB

By selecting [Document Operations] → [Submit Print Job] from "Settings (Web version)" and specifying a file, you can directly print the file without using the printer driver.

In addition to a file on your PC, this procedure can be used to print any file that can be accessed from your PC, such as a file on another PC connected to the same network.

Files that can be printed are PDF, TIFF, JPEG, PCL, PS, XPS, DOCX, PPTX, and XLSX files with extensions pdf, tif, tiff, jpeg, jpg, jpe, jfif, pcl, ps, xps, docx, pptx, and xlsx Available only if the MFP supports PostScript.

Enter the password for the encrypted PDF data on Spool Queue of the Job Status screen.



- If you selected a PS or PCL file that includes print conditions, the print conditions in the file will be given priority.
- When user authentication is enabled in the settings of the machine, the print function may be restricted. For more information, ask your administrator.

Print Settings

Select print settings. Select the file you want to print in "Select File", select settings, and then click [Print].

Item	Description
Copies	Set the number of copies to be printed.
Paper Size	Set the print size.
Orientation	Select portrait or landscape for the print orientation.
2-Sided Print	Select one-sided printing, two-sided printing (booklet), or two-sided printing (tablet).
Output	If printing by set, select the "Print per Unit" checkbox.
Staple	Select staple settings.
Separator Page	Select to insert separator pages. Specify whether separator pages are to be added in front of or behind each set. Select the paper tray with the paper you want to use from the paper trays.
Punch	Set the punch.
Fold	Set the paper fold.
Trimmer	Set the trimmer.
Fit To Page	Print with the file expanded to the full paper size.
Print What	Select whether to print a sheet or to print the entire workbook when printing an Excel file.
Output Tray	Select the output tray for the print job.
Quick File	Save the print data in the Quick File Folder of the machine.
Print Glossy	Select this checkbox if the print job will be printed on glossy paper.
Billing Code	Select the checkbox of the Billing Code to assign, and then enter the billing code.

Qualcomm® DirectOffice™ is a product of Qualcomm Technologies, Inc. and/or its subsidiaries.
 Qualcomm® is a trademark of Qualcomm Incorporated, registered in the United States and other countries.
 DirectOffice™ is a trademark of CSR Imaging US, LP, registered in the United States and other countries.



FTP PRINT

You can print a file from your PC by simply dragging and dropping the file onto the FTP server of the machine.

Performing FTP print

Enter the IP address of this machine in the server name field of your FTP client application to connect to this machine. When you upload the file you want to print in the "lp" folder on the FTP server of this machine, printing will start automatically.



- If you selected a PS or PCL file that includes print conditions, the print conditions in the file will be given priority.
- When user authentication is enabled in the settings of the machine, the print function may be restricted. For more information, ask your administrator.

E-MAIL PRINT

If you configure your e-mail account in the machine, the machine periodically checks your mail server and automatically prints received e-mail attachments without using the printer driver.



- To perform e-mail print:
- In "Settings (administrator)", select [System Settings] → [Printer Settings] → [E-mail Print Settings], and register your e-mail account. (Administrator rights are required.)



Performing e-mail print

Using your PC's e-mail software, specify the e-mail address of the machine in "Address" and send e-mail attached with a file to be printed. Control commands can be entered in the message of the e-mail to specify the number of copies and print format. Commands are entered in the format "command name = value" as shown in the following example.

```
COPIES=2
DUPLEX=LEFT
ACCOUNTNUMBER=11111
PAPER=A4
```

As an example, the control commands include the following:

Function	Command name	Values
Copies	COPIES	1 to 9999
Staple*1	STAPLEOPTION	NONE, ONE, TWO, SADDLE, STAPLELESS
Punch*2	PUNCH	OFF, ON
Punch holes	PUNCH-NUMBER	TWO, THREE, FOUR, FOURWIDE
Collate	COLLATE	OFF, ON
2-sided Print	DUPLEX	TOP, LEFT, RIGHT, OFF
Account Number*3	ACCOUNTNUMBER	Number (5 to 8 digits)
File Format	LANGUAGE	PCL, PCLXL, POSTSCRIPT, PDF, TIFF, JPG
Paper	PAPER	Paper that can be used (LETTER, A4, or others)
Fold	V-FOLD	OFF, INSIDE, OUTSIDE
Fold (Z-Fold)*4	FOLD	OFF, A3, A4, B4, LEDGER, LEGAL, LETTER
Document Filing*5	FILE	OFF, ON
	FOLDERNAME	Up to 28 characters
Quick File*5	QUICKFILE	OFF, ON
Output	OUTTRAY	CENTER, RIGHT, FINISHER, TOPTRAY
Fit Page	FITIMAGETOPAGE	OFF, ON
Print Glossy	MEDIATYPE	GLOSSY
Print Pages	PRINTPAGES	1-2,5,9-
Print What	ALLSHEETS	OFF, ON

*1 Enabled only when a finisher, finisher (large stacker), saddle stitch finisher or saddle stitch finisher (large stacker) is installed. "STAPLELESS" is only enabled when a finisher (large stacker) or saddle stitch finisher (large stacker) that allows stapling without staples is installed.

*2 Enabled only when a punch module is attached to the finisher, finisher (large stacker), saddle stitch finisher or saddle stitch finisher (large stacker).

*3 Can be omitted except when authentication is by user number.

*4 When the folding unit is installed.

*5 Only enabled when either "Document Filing" or "Quick File" is "ON". When both are "ON", this is disabled.



- The mail text must be in a text format. If entered in Rich Text format (HTML), the commands will have no effect.
- If you enter "Config" in the mail text, a list of control commands is returned.
- If nothing is entered in the body text (message) of the e-mail, printing will take place according to the settings configured in "Settings (administrator)." → [System Settings] → [Printer Settings] → [Initial Status Settings]. If you selected a PS or PCL file that includes print conditions, the print conditions in the file will be given priority.
- Enter a file type only when you wish to specify the page-description language. Normally there is no need to enter a file type.
- Images such as the body of the received email and the logo in the signature may also be printed.

Qualcomm® DirectOffice™ is a product of Qualcomm Technologies, Inc. and/or its subsidiaries.

Qualcomm® is a trademark of Qualcomm Incorporated, registered in the United States and other countries.

DirectOffice™ is a trademark of CSR Imaging US, LP, registered in the United States and other countries.



Universal Print

Universal Print is a service that allows data from users and computers connected to Microsoft 365 to be printed on MFPs and printers via the Universal Print service operated by Microsoft. With Universal Print, MFPs and printers can be centrally monitored and configured using Azure Active Directory, rather than having to install a printer server and install printer drivers on each user's computer. monitoring and configuration.

Users can also print to MFPs and printers connected to the Universal Print service via the cloud, without having to install a printer driver on each user's computer.



This section describes the licenses and other information you will need to use Universal Print, assuming you have already prepared them.

Contact Microsoft for more information on the licenses required to use Universal Print.

BEFORE CONNECTING THE Universal Print SERVICE

Before connecting the machine to the Universal Print service, make sure that the machine is connected to the Internet beforehand and that [IPP INFRA] is enabled in the client port in "[Port Control \(page 10-185\)](#)" in the setting mode.

The machine must also be registered in Azure Active Directory and on the client PC before it can be used with the Universal Print service. For information on how to register with Azure Active Directory and client PCs, see "[Universal Print Settings \(page 4-97\)](#)".

Printing methods

Once registration is complete, you will be able to print from various Windows applications.

Open the print menu of each application, select the machine and print.

Printing permissions for invalid users

Prints from Universal Print are treated as jobs from "Other User". Therefore, if "[Disable Printing by Invalid User \(page 10-131\)](#)" is enabled in the setting mode, change it to disabled.

Also, if user authentication is enabled in the Sharp OSA application, the Sharp OSA application should allow invalid users to print.

Registering and deleting from the Universal Print service

You can register or delete the machine in "[Universal Print Settings \(page 4-97\)](#)".

Operation in power saving mode

Prints from Universal Print, as well as normal prints, can be made in the power saving mode, but will return and start printing as soon as the data is communicated to the machine.



When registered with Universal Print, the machine does not shift to "Low Power" in "[Sleep Mode Power Level \(page 9-5\)](#)".



Universal Print Settings

This function allows you to register or remove the device from the Azure Active Directory, check the current registration status, or enable or disable the Universal Print function.



To register with Azure Active Directory, launch the setting mode from your web browser.

REGISTERING THE MACHINE WITH Azure Active Directory

To register the machine with the Universal Print Service, follow the procedure below from the web administration screen.

(1) Open "Universal Print Settings" in System Settings.

(2) Check the printer name and click "Execute" under "Register with Universal Print".

You will be presented with a registration code and a URL for registering your code. The registration code is valid for 15 minutes. If you register after 15 minutes, you will have to start from the beginning.

(3) Click on the URL for code registration.

A separate window will open in which you can enter your registration code.

(4) Follow the instructions on the screen to enter the registration code.

(5) View the Azure Active Directory Universal Print management screen in a web browser.

(6) Select the registered printer and click [Share Printer].

(7) Click [Members], and then click [Add].

(8) Select a member or group from the list to use the machine.

To use the machine with the Universal Print service, continue with "Registering the machine with each client PC" below.

REGISTERING THE MACHINE WITH EACH CLIENT PC

To register the machine with each client PC, follow the procedure below on your computer.

(1) Click the [Start] button, select [Settings] → [Accounts].

(2) Click [Connect] under [Access work or school].

If necessary, follow the prompts to sign in with your Microsoft 365 account.

(3) Click [Home], and then click [Devices].

(4) Click [Printers & Scanners], and then click [Add Printer or Scanner].

(5) Select a registered machine from the list.

When you have completed this operation, the unit is ready to be used on the client PC.

DELETE FROM Azure Active Directory

This setting is available when the machine has already been registered for Universal Print Service.

To delete the machine from the Universal Print Service, in the web page (administrator), click [System Settings] → [Universal Print Settings], and then click the [Delete] key.



PRINTER JOBS

CHECKING THE PRINT STATUS

When you tap the job status display, jobs are displayed in a list. To check the status of a printer job, tap the [Print] tab. When you wish to stop or delete jobs or to perform priority processing, read "[STORING ADDRESSES THROUGH DIRECT ENTRY \(page 6-19\)](#)".

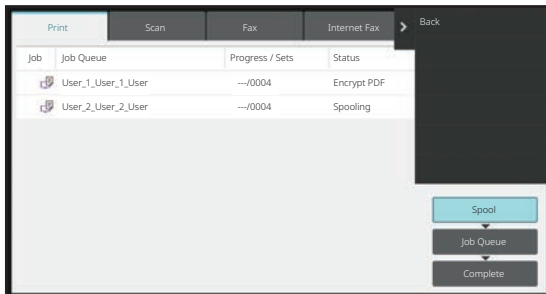

PRINTING AN ENCRYPTED PDF FILE

PDF encryption is used to protect a PDF file by requiring the entry of a password to print or edit the file. To directly print an encrypted PDF file on an FTP server or in a USB memory device, etc. connected to the machine, reset the password and begin printing.



- To print an encrypted PDF file using the printer driver, enter the password when opening the file on your PC.
- Printing is not possible if you do not know the password for the encrypted PDF file.
- Encrypted PDF versions that can be directly printed are 1.6 (Adobe Acrobat 7.0) and earlier.

(1) Tap the Job status display and tap the [Print] tab.

(2) Tap the [Spool] key.

When the list contains an encrypted PDF file, a message is displayed to indicate that an encrypted PDF file exists.

(3) Tap the print job key for the encrypted PDF file.



You cannot select multiple encrypted PDF files.

(4) Tap the [Enter Password for Encrypt PDF.] key on the action panel.

(5) Enter the password (32 characters or less) and tap the [Yes] key.



When both a master password and a user password (which is used to open the file) have been set, enter the master password.



CHANGING TO ANOTHER PAPER SIZE AND PRINTING WHEN PAPER RUNS OUT

If printing stops because the machine ran out of paper, or if the size of paper specified in the printer driver is not loaded in the machine, a message will appear in the touch panel.

Printing will begin automatically when paper is loaded in the machine. If paper of the desired size is not immediately available, you can use paper that is set in a different tray.



If you changed to a different paper size, printing may not take place correctly; for example part of the text or image may run off the paper.

- (1) Tap the job status display.
- (2) Tap the key of the job for which "Paper Empty" appeared.
- (3) Tap the [Reselect Paper] key on the action panel.
- (4) Tap the key for the tray containing the paper that you wish to use, and tap [OK].



PRINT RELEASE FUNCTION

PRINT RELEASE FUNCTION

When there are multiple machines that support the print release function on the same network, you can use the print release function to save data in the machine that is set as the primary unit and then print the saved data from secondary unit which you set (multiple secondary units can be set).

INTER-GROUP PRINTING

Primary and secondary units can be grouped.

Select a registered group, and use the print release function on the selected group.

Print release settings, such as Primary Unit, Secondary Unit, and group settings, can be configured from the web page (administrator) in [System Settings] → [Print Settings] → [Print Release Settings].

[Print Release Settings \(page 10-72\)](#)

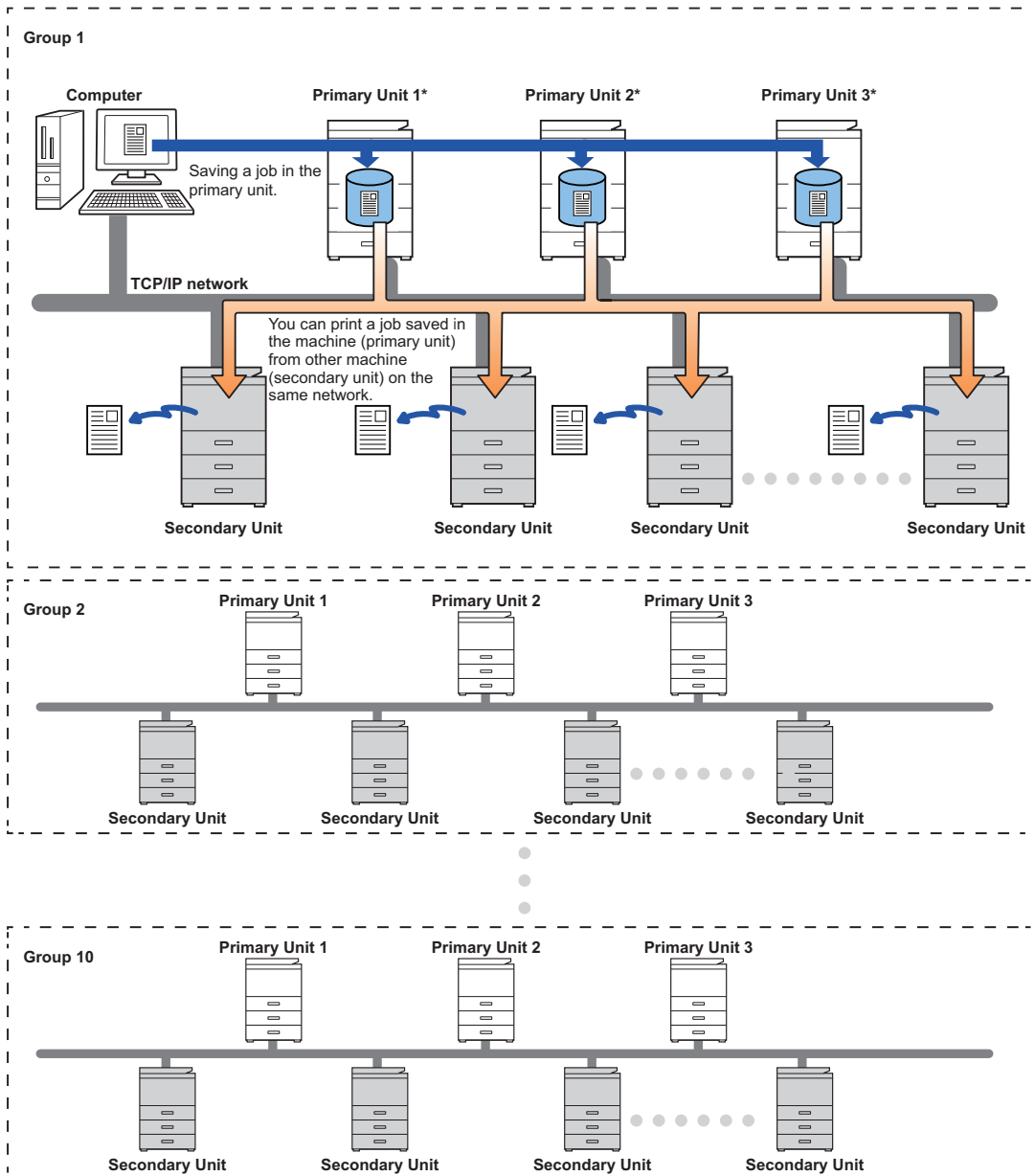

For models that support the print release function, and for the number of secondary units that can be controlled by one primary unit, consult your dealer.

* Available for models with local drive.



- Up to 3 primary units can be set.
- Up to 10 groups can be registered into Inter-Group Printing.
- When user authentication is enabled, only jobs of the logged-in user can be printed.
- In an environment with mixed models, some printer drivers may not produce the expected print result.

BEFORE USING THE PRINT RELEASE FUNCTION

This section explains settings that must be configured before you can use the Print Release function.

SETTINGS REQUIRED ON THE MACHINE

To use the print release function, configure in setting mode (administrator).

Fixing the IP address of the machine

If the machine is used in a DHCP environment, the IP address of the machine may change. If this happens, you will not be able to send print release information to the machine.

Adding the print release icon to the Home screen

It is not necessary this setting, if already added the print release icon.

1

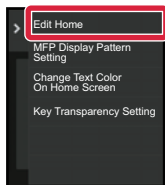

Tap [Edit Home] on the action panel.

2

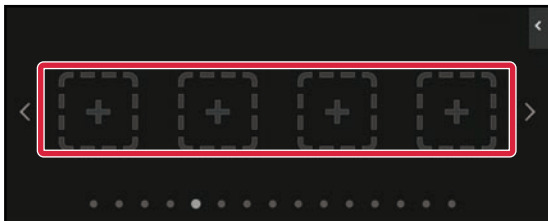

Tap a place without a shortcut key in home edit mode.

3

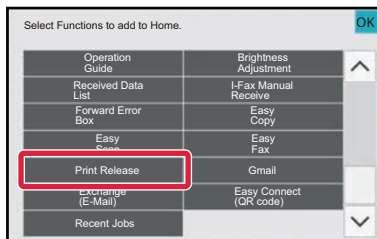

Tap [Print Release].

4

Tap the [Edit End] key.

Home Edit Mode is exited and you return to the home screen.



INSTALLING THE PRINTER DRIVER OF THE PRIMARY UNIT

Install the printer driver of the primary unit on your computer. For the procedures for installing the printer driver, see the Software Setup Guide.

USING THE PRINT RELEASE FUNCTION

This section explains how to store jobs in the primary unit, and how to select and print jobs from a secondary unit.

STORING A JOB IN THE PRIMARY UNIT FROM YOUR COMPUTER

When user authentication enabled in the machine, you must enter your user information (login name, password, etc.) in the settings screen of the printer driver in order to print.* For explanations of the settings, see "[PRINTER FUNCTION \(page 4-3\)](#)".

* The user information that is required varies depending on the enabled authentication method. Check with the machine administrator for this information.



Check the paper size and paper type used for printing.

Select a paper size and paper type that are supported by the machine to be used.

If you select a non-supported paper size or paper type, you may not be able to print.

In a Windows environment

1

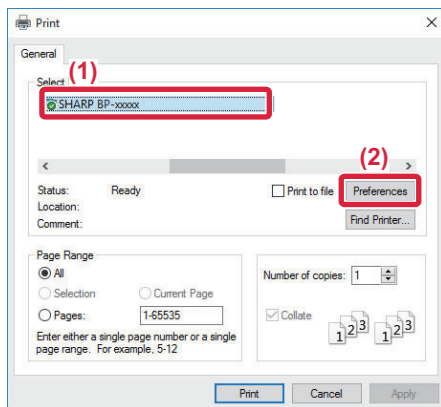

Open the printer driver properties window.

(1) Select the printer driver of the Primary Unit.

(2) Click the [Preferences] button.

2

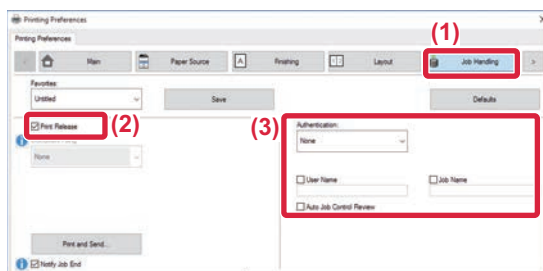

Configure the print release function.

(1) Click the [Job Handling] tab.

(2) Select the [Print Release] checkbox .

(3) Enter user information as needed.

For more information, see "[Authentication Settings \(page 10-126\)](#)".



- The print release function cannot be used at the same time as the document filing function.
- You can change the number of copies at the time of printing.
- If selecting the [Print Release] checkbox in [Printing Policy] on the [Configuration] tab, that function will always be enabled and information on various functions will no longer appear in the print settings screen.
- If less than 10 MB is free in the storage area of the primary unit, the job will not be stored. Delete unneeded jobs and print again.

3



Select any print settings that are needed, and click the [OK] button.

4

Start printing.

In a macOS environment

1

In the application, select [Print] from the [File] menu. Make sure that the machine's printer name is selected.

2

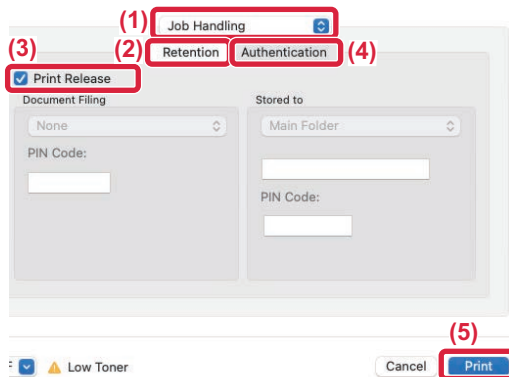

Configure the print release function.

- (1) Select [Job Handling].
- (2) Click [Retention].
- (3) Select the [Print Release] checkbox .
- (4) Click [Authentication] and enter your user information as needed.
If user authentication is not enabled, this step can be omitted.
For more information, see "[Authentication Settings \(page 10-126\)](#)".
- (5) Select any other print settings that are needed, and click the [Print] button.



- The print release function cannot be used at the same time as the document filing function.
- You can change the number of copies at the time of printing.
- If less than 10 MB is free in the storage area of the primary unit, the job will not be stored. Delete unneeded jobs and print again.

3

Start printing.



PRINTING/DELETING A JOB STORED IN THE PRIMARY UNIT FROM A SECONDARY UNIT

This section explains how to print and delete a stored job from a secondary unit.

1 Tap the [Print Release] key on the Home screen.

- A list of the jobs stored in the primary unit appears.
- If the main power of the primary unit is not on, a message will appear and you will not be able to view the stored jobs.

2

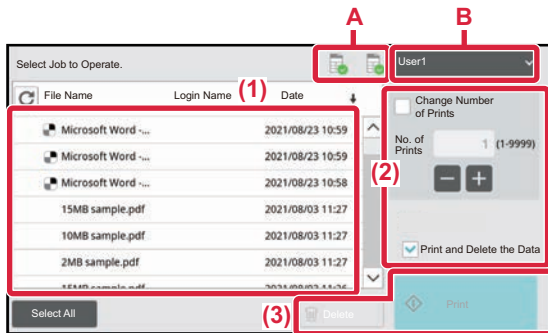

Print or delete the selected job.

(1) Tap the job you want to print or delete. The checkbox is selected .

You can select more than one job.
You can select all jobs with the [Select All] key.

(2) Configure print settings.

To delete the job from the primary unit after printing, select the [Print and Delete the Data] checkbox . (This step is no necessary when only deleting the job.)

(3) Start printing or deleting.

If you are deleting the job, a confirmation screen will appear. Select [Yes] to delete.

A: Machine icon

The communication status with the primary unit is displayed. By tapping the machine icon, detailed information is displayed.

B: Pull-down menu

Appears when the MFP group collaboration function is used. By selecting another MFP group in this pull-down menu, the print jobs of the other MFP groups are displayed.



When user authentication is enabled, only the print jobs of the logged-in user appear.



- If you selected a setting such as stapling that cannot be executed because the secondary unit does not have the necessary option, the setting will be disregarded.
- If the selected job is a PS file, the job will only be printed if the secondary unit supports PS file printing.



APPENDIX

PRINTER DRIVER SPECIFICATIONS LIST

For information on the setting items, refer to printer driver Help.

[PRINTER DRIVER SETTINGS SCREEN / REFERRING TO HELP \(page 4-6\)](#)



The specifications of each function in Windows PPD and macOS PS vary depending on the operating system version and the application.

Main

Function	PCL6	PS	Windows PPD	macOS PS
Copies	1-9999	1-9999	1-9999	1-9999
Collate	Yes	Yes	Yes	Yes
Original Size	Yes	Yes	Yes	Yes
Output Size	Yes	Yes	Yes	Yes
Orientation	Yes	Yes	Yes	Yes
Adjust to Paper Size	Yes	Yes	No	Yes
Zoom	Yes	Yes	Yes	Yes
2-Sided	Yes	Yes	Yes	Yes
N-Up	2, 4, 6, 8, 9, 16	2, 4, 6, 8, 9, 16	2, 4, 6, 9, 16	2, 4, 6, 9, 16
Staple	Yes	Yes	Yes	Yes
Document Filing	Yes	Yes	No	Yes



- Zoom (PCL6/Windows PPD): The horizontal and vertical proportion cannot be set separately.
- Staple: If a finisher or a saddle stitch finisher is installed (The punch module is also required in order to use the punch function.)

Paper Source

Function	PCL6	PS	Windows PPD	macOS PS
Output Size	Yes	Yes	No	No
Paper Tray	Yes	Yes	Yes	Yes
Paper Type	Yes	Yes	Yes	Yes
Tray Status	Yes	Yes	No	No
Force Letter-R for Letter Size	Yes	Yes	No	Yes



Finishing

Function	PCL6	PS	Windows PPD	macOS PS
Staple/Saddle Stitch	Yes	Yes	Yes	Yes
Punch	Yes	Yes	Yes	Yes
Fold	Yes	Yes	Yes	Yes
Offset	Yes	Yes	Yes	Yes
Output	Yes	Yes	Yes	Yes
Separator Page	Yes	Yes	No	Yes
Trimming	Yes	Yes	No	Yes



- Staple/Punch: If a finisher or a saddle stitch finisher is installed (The punch module is also required in order to use the punch function.)
- Fold: If a saddle stitch finisher is installed.

Layout

Function	PCL6	PS	Windows PPD	macOS PS
2-Sided	Yes	Yes	Yes	Yes
Chapter Inserts	Yes	No	No	No
Booklet	Yes	Yes	Yes	Yes
N-Up	Page No.	2, 4, 6, 8, 9, 16	2, 4, 6, 8, 9, 16	2, 4, 6, 9,16
	Repeat	Yes	No	No
	Order	Yes	Yes	No
	Border	Yes	Yes	Yes
	N-Up with cover	Yes	No	No
	100% N-Up	Yes	Yes	No
Poster Printing	Yes	Yes	No	No
Print Position	Margin Shift	0 inch to 1.2 inch (0mm to 30mm)	0 inch to 1.2 inch (0mm to 30mm)	0 inch to 1.2 inch (0mm to 30mm)
	Tab Shift	Yes	Yes	No
	Custom	Yes	Yes	No

Job Handling

Function	PCL6	PS	Windows PPD	macOS PS
Print Release	Yes	Yes	No	Yes
Document Filing	Yes	Yes	No	Yes
Create PDF for PC Browsing	Yes	No	No	No
Print and Send	Yes	No	No	No
Notify Job End	Yes	Yes	No	No
Authentication	Yes	Yes	No	Yes



Inserts

Function	PCL6	PS	Windows PPD	macOS PS
Covers/Inserts	Yes	Yes	Yes	Yes
Transparency Inserts	Yes	Yes	No	Yes
Carbon Copy	Yes	Yes	No	No
Tab Paper	Yes	Yes	Yes	Yes



Covers/Inserts (Windows PPD/macOS PS): Only covers can be inserted.

Stamp

Function	PCL6	PS	Windows PPD	macOS PS
Watermark	Yes	Yes	Yes	Yes
Image Stamp	Yes	Yes	No	No
Overlay	Yes	Yes	No	No
Hidden Pattern	Yes	No	No	No
Copies Stamp	Yes	No	No	No

Image Quality

Function	PCL6	PS	Windows PPD	macOS PS
Print Mode	Yes	Yes	Yes	Yes
Graphics Mode	Yes	No	No	No
Bitmap Compression	Yes	Yes	No	No
Sharpness	Yes	Yes	Yes	Yes
Screening	Yes	Yes	Yes	Yes
Smoothing	Yes	Yes	No	No
Text To Black	Yes	Yes	No	No
Vector To Black	Yes	Yes	No	No
Toner Save	Yes	Yes	Yes	Yes
Image Adjustment	Yes	Yes	No	No
Font	Yes	Yes	No	No
Line Width	Yes	No	No	No
Boldness Adjustment	Yes	Yes	Yes	Yes



Toner Save: This setting may not operate in some applications and operating systems.



Detailed Settings

Function	PCL6	PS	Windows PPD	macOS PS
Mirror Image	No	Yes	Yes	Yes
PS Error Information	No	Yes	Yes	No
PS Pass-Through	No	Yes	No	Yes
Job Compression	No	Yes	No	Yes
Tandem Print	Yes	Yes	No	No
Disable Blank Page Print	Yes	Yes	No	No
Custom Image Registration	Yes	No	No	No
Other Settings				
• Input Resolution	Yes	Yes	No	No
• Shade Pattern	Yes	No	No	No
• Spool Data Format	Yes	Yes	No	No
• Printable Area	Yes	Yes	No	No
• Rip Style	Yes	Yes	No	No
• Duplex Style	Yes	Yes	No	No
• Job Name Shortening	Yes	Yes	No	No
• Use driver to render JPEGs	Yes	Yes	No	No
• Expand	No	No	No	No
• Thicken Fine Lines	Yes	No	No	No
• Fine Text	Yes	Yes	Yes	Yes
• Text/Line control	Yes	Yes	Yes	Yes
• Text/Line knockout control	Yes	Yes	Yes	Yes
• Photo Image	Yes	Yes	Yes	Yes
• Image Enhancement	Yes	Yes	Yes	Yes
• Driver Setting Priority	Yes	Yes	No	No



SPECIFYING A BILLING CODE USING THE PRINTER DRIVER

You can enter a billing code using the printer of the machine.

For an overview of a billing code, refer to "[BILLING CODE \(page 9-25\)](#)".

ENABLE BILLING CODE

This setting is required only in the Windows environment. (Always usable under macOS environment)

1

Click the [Start] button, select [Settings] → [Device] → [Devices and Printers].



- In Windows 11, click the [Start] button, select [Bluetooth & devices] → [Printers & scanners].
- In Windows 8.1/Windows Server 2012, right-click the [Start] button, select [Control Panel] → [View devices and printers] (or [Devices and Printers]).

2

Right-click the printer driver icon of the machine and select [Printer Properties].

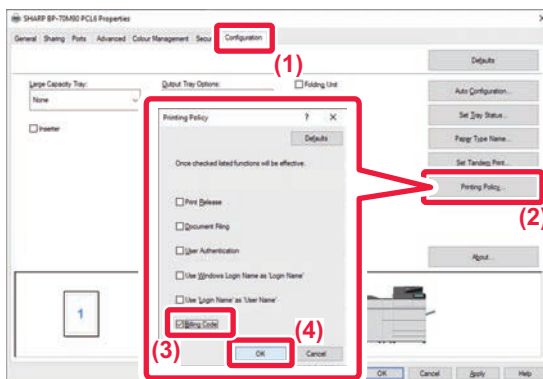
3

Specify a billing code

- (1) Click the [Configuration] tab.
- (2) Click the [Printing Policy] button.
- (3) Set the [Billing Code] check box to .
- (4) Click the [OK] button.



Windows

When printing starts, the billing code setting screen appears.
Enter the main code and sub code, and click the [OK] button.
To retain the specified billing code, set [Always Use This Billing Code] to .

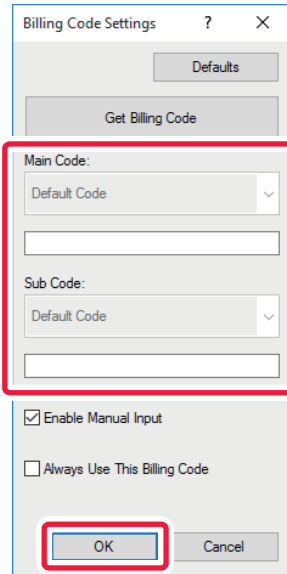

- You can click [Get Billing Code] to get the machine's billing code list and select the billing code from the list.
- If you have started printing without specifying a billing code, a use code is recorded in the job log.

macOS

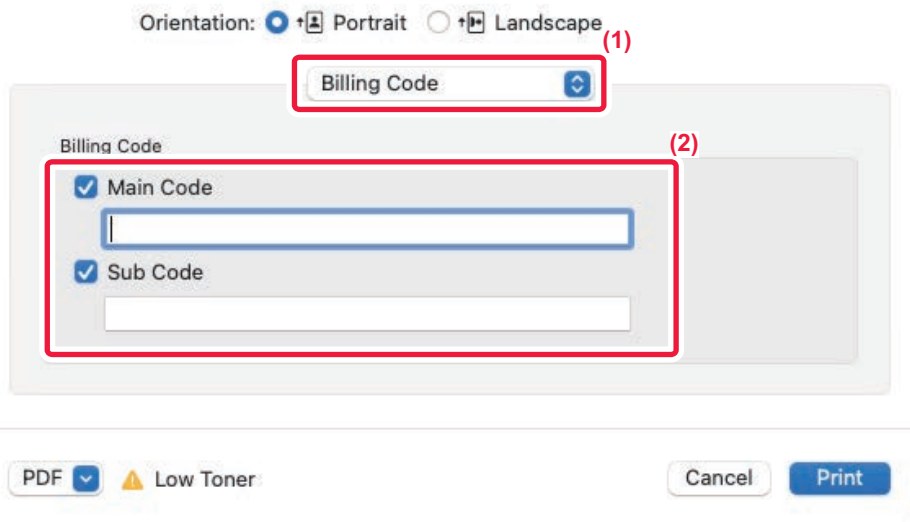

- (1) Select [Billing Code].
- (2) Enter the main code and sub code.



AUTHENTICATION BY SINGLE SIGN-ON

When the user authentication is used, you must enter your user name and password to print from a printer driver. The Single Sign-on function can be used when Active Directory authentication is used on both the machine and the computer.

When you use this function and print from the printer driver, the print job is sent to the machine using the authentication information that you used to log in to the computer. This allows easy printing of jobs from the printer driver without the need to enter your user name or password each time you print when user authentication is enabled.



Authentication by Single Sign-on requires that Active Directory authentication be performed on the machine and your computer. This can only be used when your computer is running Windows.

Settings

Active Directory must be enabled on the machine in advance. For information on Active Directory, refer to "[ACTIVE DIRECTORY LINKING FUNCTION \(page 9-24\)](#)". After enabling Active Directory, configure the settings below in the printer driver.

(1) Click the [Start] button, select [Settings] → [Device] → [Devices and Printers].

- In Windows 11, click the [Start] button, select [Bluetooth & devices] → [Printers & scanners].
- In Windows 8.1/Windows Server 2012, right-click the [Start] button, select [Control Panel] → [View devices and printers] (or [Devices and Printers]).

(2) Right-click the machine's printer driver icon and select [Printer Properties].

The printer properties appear.

(3) Click the [Configuration] tab.

(4) Set the [Single Sign-on] checkbox to .

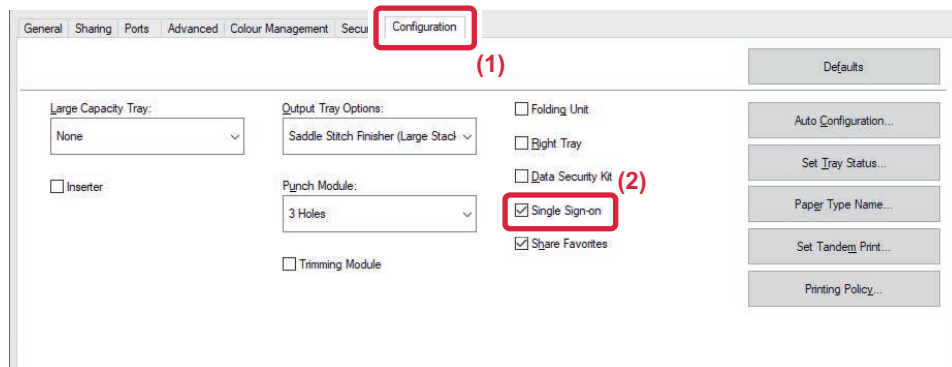

Authentication Option

For the authentication method, refer to "[PRINTING WHEN THE USER AUTHENTICATION FUNCTION IS ENABLED \(page 4-8\)](#)".

(1) Click the [Job Handling] tab.

(2) In [Authentication], select [Single Sign-on].



- Single Sign-on authentication is also possible from the Job Handling dialog box and the User Authentication dialog box.
- When Single Sign-on is enabled, [Print and Send] cannot be used.
- If you logged in to the machine in advance before using Single Sign-on, you will have the permissions of the user account you used to log in.
If you use Single Sign-on without logging in to the machine, the user permissions will be those of "User". This may limit the functions that you can use.
- If Single Sign-on is used without logging in to the machine, the user name in the job log will be the name set by printer driver. If the user name is not set by printer driver, the user name in the job log will be the computer login name.



FACSIMILE

BEFORE USING THE MACHINE AS A FAX

BEFORE USING THE MACHINE AS A FAX	5-3
FAX MODE	5-6
EASY MODE	5-6
NORMAL MODE	5-7
FAX TRANSMISSION SEQUENCE	5-8

ENTERING DESTINATIONS

ENTERING DESTINATIONS	5-10
ENTERING A DESTINATION NUMBER USING THE NUMERIC KEYS	5-10
RETRIEVING A DESTINATION FROM AN ADDRESS BOOK	5-11
THE SELECTED DESTINATIONS	5-13
USING A SEARCH NUMBER TO RETRIEVE A DESTINATION	5-14
RETRIEVING A DESTINATION FROM A GLOBAL ADDRESS BOOK	5-15
RETRIEVING A DESTINATION FROM A MOBILE ADDRESS BOOK	5-17
USING A TRANSMISSION LOG TO RESEND	5-19
SENDING BY CHAIN DIALING	5-21

BASIC TRANSMISSION METHODS

BASIC TRANSMISSION METHODS	5-22
FAX TRANSMISSION METHODS	5-22
ORIGINAL ORIENTATION	5-24
AUTOMATIC REDUCTION OF THE TRANSMITTED IMAGE	5-25
TRANSMITTABLE ORIGINAL SIZES	5-25
THE SIZE OF THE PLACED ORIGINAL	5-25
WHEN THE LINE IS BUSY	5-26
WHEN A COMMUNICATION ERROR OCCURS	5-26
FAX DEST. CONFIRMATION MODE	5-27
CHECKING THE IMAGE TO BE TRANSMITTED	5-28
FAX TRANSMISSION METHODS	5-29
USING THE AUTOMATIC DOCUMENT FEEDER FOR TRANSMISSION	5-29
USING THE AUTOMATIC DOCUMENT FEEDER FOR FAXING IN DIRECT TX MODE	5-30
USING THE DOCUMENT GLASS FOR TRANSMISSION	5-32
USING THE DOCUMENT GLASS TO SEND A FAX IN DIRECT TX MODE	5-34
TRANSMISSION USING THE SPEAKER	5-36
SENDING THE SAME FAX TO MULTIPLE DESTINATIONS (BROADCAST TRANSMISSION)	5-37
RESENDING TO UNSUCCESSFUL BROADCAST TRANSMISSION DESTINATIONS	5-40

SENDING A FAX DIRECTLY FROM A COMPUTER (PC-Fax)	5-41
DELETING A TRANSMISSION LOG	5-41
SET THE SCANNING OF THE ORIGINALS	5-42
AUTOMATICALLY SCANNING BOTH SIDES OF AN ORIGINAL (2-Sided Original)	5-42
AUTO DETECTION	5-43
SPECIFYING THE ORIGINAL SCAN SIZE IN PAPER SIZE	5-44
SPECIFYING THE ORIGINAL SCAN SIZE USING NUMERIC VALUES	5-46
STORING FREQUENTLY USED ORIGINAL SIZES	5-48
SPECIFYING THE SEND SIZE OF THE IMAGE	5-52
CHANGING THE EXPOSURE	5-54
CHANGING THE RESOLUTION	5-55

FAX RECEPTION

RECEIVING A FAX	5-56
RECEIVING A FAX AUTOMATICALLY	5-56
RECEIVING A FAX MANUALLY	5-58
PRINTING RECEIVED DATA	5-59
PRINTING A PIN CODE-PROTECTED FAX (Hold setting for received data print)	5-59
PRINTING RECEIVED DATA AT A SPECIFIED TIME	5-60
CHECKING THE IMAGE BEFORE PRINTING	5-61
FORWARDING RECEIVED DATA	5-63
FORWARDING RECEIVED FAXES (FAX DATA FORWARD)	5-63
FORWARDING RECEIVED DATA TO PRESET DESTINATIONS (INBOUND ROUTING SETTINGS)	5-65
SAVING RECEIVED FAXES TO THE MACHINE'S STORAGE (INBOUND ROUTING)	5-69
FORWARDING RECEIVED DATA MANUALLY	5-70
SAVING RECEIVED DATA	5-72

OTHERS FUNCTIONS

COMMON FUNCTIONS	5-73
STORING FAX OPERATIONS (PROGRAM)	5-74
OPERATING FAX TRANSMISSION AND RECEPTION REMOTELY	5-76
CALLING A FAX MACHINE AND INITIATING RECEPTION (POLLING)	5-76
INITIATING POLLING RECEPTION MANUALLY	5-78
SENDER-RELATED FEATURES	5-79
ADDING YOUR SENDER INFORMATION TO FAXES (FAX OWN NUMBER SENDING)	5-79
TEMPORARILY CHANGING THE SENDER INFORMATION (OWN NAME SELECT)	5-80





ASSUMING A SPECIFIC USAGE. 5-82
 CHANGING THE PRINT SETTINGS FOR THE TRANSACTION REPORT (TRANSACTION REPORT) 5-82

POLLING MEMORY FUNCTIONS 5-84
 SENDING A FAX WHEN ANOTHER MACHINE POLLS YOUR MACHINE (POLLING MEMORY) 5-84
 RESTRICTING POLLING ACCESS (POLLING SECURITY SETTING) 5-84
 SCANNING A DOCUMENT INTO POLLING MEMORY 5-85
 CHECKING THE DOCUMENT IN THE PUBLIC BOX 5-86
 DELETING A DOCUMENT FROM THE PUBLIC BOX 5-87

PERFORMING F-CODE COMMUNICATION

F-CODE COMMUNICATION. 5-88
 F-CODE COMMUNICATION 5-88
 CREATING MEMORY BOXES IN THE MACHINE FOR F-CODE COMMUNICATION 5-89
 F-CODE DIALING 5-90
 F-CODE CONFIDENTIAL TRANSMISSION 5-90
 CONFIDENTIAL TRANSMISSION USING F-CODES 5-91
 CHECKING FAXES RECEIVED BY F-CODE CONFIDENTIAL RECEPTION 5-92
 POLLING RECEPTION USING F-CODES 5-93
 SCANNING A DOCUMENT INTO A MEMORY BOX FOR F-CODE POLLING TRANSMISSION 5-95
 CHECKING THE DOCUMENT IN THE F-CODE MEMORY POLLING BOX 5-97
 DELETING A DOCUMENT STORED FOR F-CODE POLLING TRANSMISSION 5-98
 RELAY REQUEST TRANSMISSION USING F-CODES 5-99
 RELAY BROADCAST TRANSMISSION USING F-CODES 5-101

USING AN EXTERNAL TELEPHONE

CONNECTING AN EXTERNAL TELEPHONE 5-102
 CONNECTING AN EXTERNAL TELEPHONE 5-102
 RECEIVING A FAX AFTER ANSWERING A CALL ON THE EXTERNAL TELEPHONE (REMOTE RECEPTION) 5-103
 MAKING AND RECEIVING PHONE CALLS 5-103

CHECK THE COMMUNICATION STATUS

FAX JOBS 5-104
COMPLETED FAX TRANSMISSION/RECEPTION JOBS 5-104
 FAX RECEPTION JOBS 5-104
 TIMER TRANSMISSION JOBS 5-104
 RETRY JOBS 5-105
 RECEPTION JOBS WHEN THE INBOUND ROUTING SETTINGS ARE ENABLED 5-105
 RECEIVED DATA IS NOT PRINTED 5-105
 RECEIVED FAX IS PRINTED 5-105

CHECKING IMAGE SENDING ACTIVITIES 5-105
 PRINTING IMAGE SENDING ACTIVITY REPORTS 5-105
 INFORMATION APPEARING IN THE RESULT COLUMN 5-105



BEFORE USING THE MACHINE AS A FAX

BEFORE USING THE MACHINE AS A FAX

To use the machine as a facsimile, connect the telephone line, and set the telephone line type.



The facsimile expansion kit is required in order to make use of fax functionality.

1

Connecting to the telephone line.

Insert the plug on one end of the telephone line cord into the telephone line jack (LINE) of the machine as shown until it clicks, and insert the other plug into a wall telephone jack until it clicks.

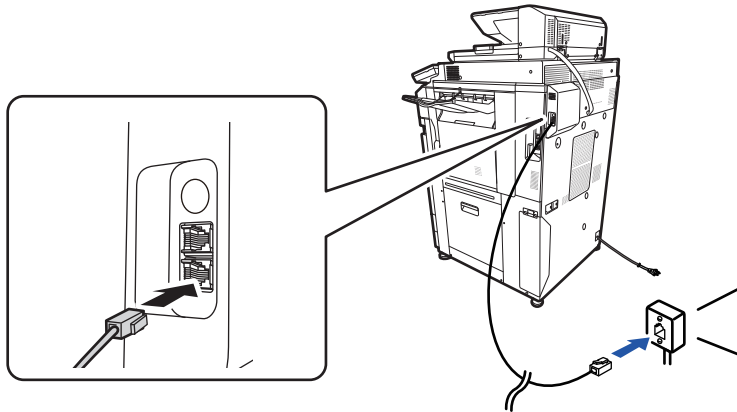

If the connection cable is not properly connected, "Sending has failed. Please check network connection." will appear when you attempt to send a fax. Properly connect the connection cable.



2

Make sure the main power switch is in the " | " position.

When the main power indicator is lit up, the main power is in the " | " position. If the main power indicator is not lit up, turn the main power switch to the " | " position and press the [POWER] button on the operation panel.

[TURNING ON THE POWER \(page 1-10\)](#)



When "Settings (administrator)" → [System Settings] → [Image Send Settings] → [Fax Settings] → [Condition Settings] → [Auto Wake Up Print] is enabled, even if the power to the machine is turned off (the main power switch is on), when a fax is received, the machine will automatically turn on and output the received data. When [Auto Wake Up Print] is disabled and the [Power] button is unlit, the received data is stored in memory in the machine and will not be output until the power is turned on.



If the fax function will be used, and in particular if reception or timer transmission will take place at night, do not turn the main power off.

3

Setting the telephone line type.

The machine's dial mode setting must be set to match the type of telephone line you are using.

* If the setting is incorrect, it may result in dialing failures or cause calls to be made to the wrong destination.



- **If you want to set the type of telephone line automatically**

In "Settings (administrator)", select [System Settings] → [Image Send Settings] → [Fax Settings] → [Default Settings] → [Dial Mode Setting], and tap the [Auto Select] key.

- **If necessary, you can set the type of telephone line manually.**

- **When you connect to a digital line When Digital Line Network is enabled, the send level will be 15 dB or less when you connect to a digital line. In "Settings (administrator)", select [System Settings] → [Image Send Settings] → [Fax Settings] → [Default Settings] → [Digital Line Network].**

4

Checking the date and time.

Verify that the correct date and time are set in the machine.



To set the date and time of the machine:

In "Settings", select [System Settings] → [Common Settings] → [Device Control] → [Clock Adjust].

5

Storing the sender fax number.

Store a sender name in [Sender Name] and a fax number in [Fax No.]. Be sure to configure this information, as it is required for communication.



To store the sender's name and address:

In "Settings (administrator)", select [System Settings] → [Image Send Settings] → [Common Settings] → [Own Number and Name Set] → [Sender Data Registration].



Storing destination addresses for each scan mode in the address book.

When using fax, it is convenient to previously store addresses in the address book.

For how to use the address books and how to store addresses, see the following item.

[ADDRESS BOOK \(page 6-14\)](#)

[STORING ADDRESSES THROUGH DIRECT ENTRY \(page 6-19\)](#)

[STORING ADDRESSES THROUGH GLOBAL ADDRESS SEARCH \(page 6-20\)](#)

[STORING ADDRESSES FROM FAX OR IMAGE SEND LOGS \(page 6-22\)](#)

[STORING GROUPS \(page 6-24\)](#)



FAX MODE

Fax mode has two modes: easy mode and normal mode.

Easy mode is limited to frequently used functions that allow you to smoothly perform most fax jobs.

If you need to select detailed settings or special functions, use normal mode. All functions can be used in normal mode.

EASY MODE

Easy mode makes it easy to select basic settings for fax.

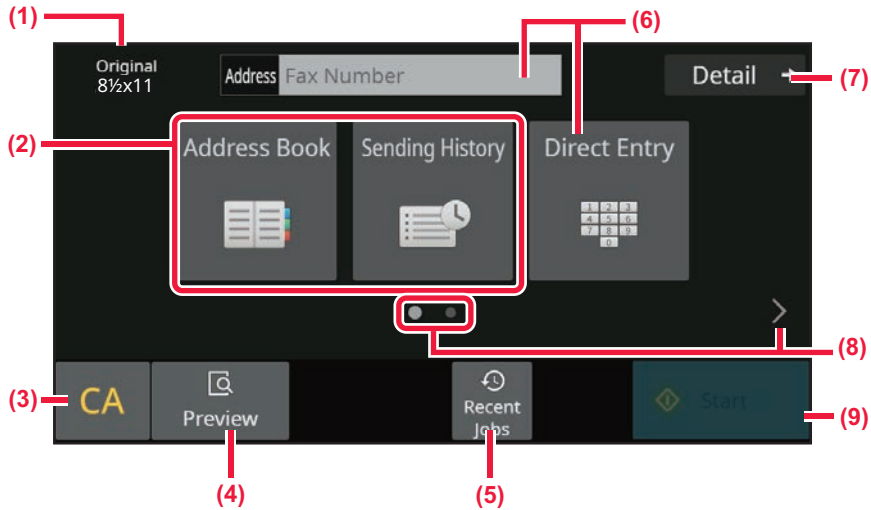

- (1) Show the size of the placed original.
- (2) Select an address.
[SPECIFYING THE ORIGINAL SCAN SIZE IN PAPER SIZE \(page 5-44\)](#)
[SPECIFYING THE ORIGINAL SCAN SIZE USING NUMERIC VALUES \(page 5-46\)](#)
- (3) Reset the address and settings.
- (4) Scans the original for preview.
[PREVIEW SCREEN \(page 2-11\)](#)
- (5) Recently used job setting can be loaded.
[OPERATION PANEL \(page 1-7\)](#)
- (6) Tap this key to display the numeric keys.
- (7) Change to normal mode.
[NORMAL MODE \(page 5-7\)](#)
- (8) Change the function display.
- (9) Immediately starts sending a fax.

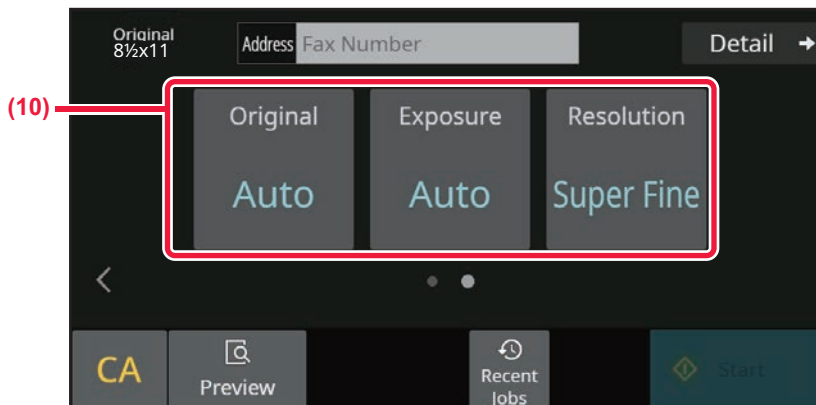

- (10) Select function to be set up.



You can select these functions in easy mode.

- Original ► [page 5-42](#)
- Exposure ► [page 5-54](#)
- Resolution ► [page 5-55](#)



• **To select a function in easy mode**

In "Settings", select [System Settings] → [Common Settings] → [Operation Settings] → [Easy Mode Settings] → [Easy Fax].

• **To cancel the warning message displayed when switching from easy mode to normal mode**

In "Settings (administrator)", select [System Settings] → [Common Settings] → [Operation Settings] → [Easy Mode Settings] → [Display a Confirmation Message when Selecting "Detail" in Easy Modes] to disable this setting.

NORMAL MODE

Normal mode lets you select any function setting that can be used for fax.

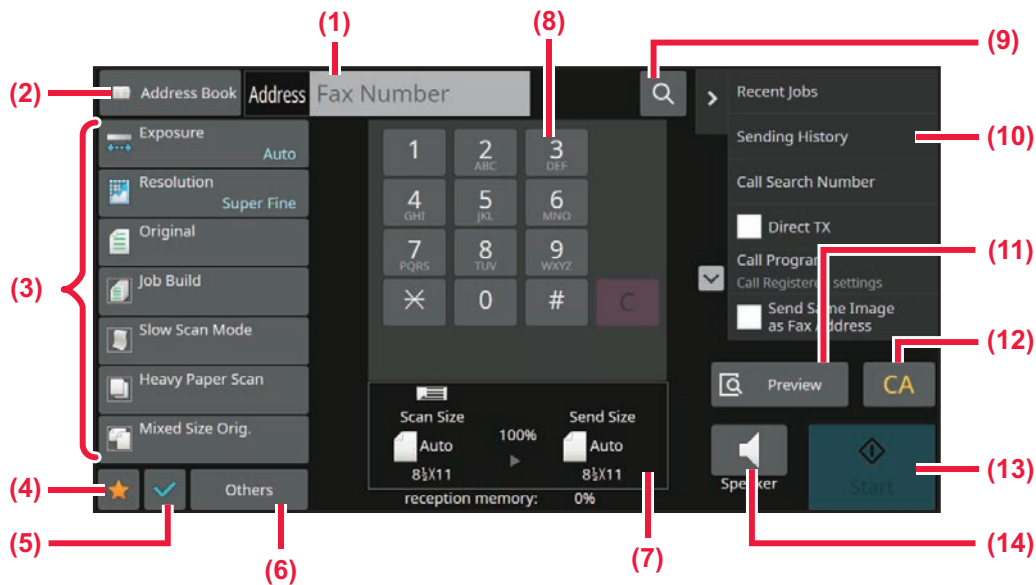

- | | |
|--|---|
| <p>(1) Tap to display the numeric keys.</p> <p>(2) Used to display the address book and enter a destination.</p> <p>(3) Used to change fax settings.</p> <p>(4) Displays the list of setting keys. Frequently used [Others], programs, and other settings can be registered.</p> <p>(5) Check the current settings.</p> <p>(6) Displays the list of keys other than the function keys indicated above.</p> | <p>(7) Displays the sizes of the original and the data to send.</p> <p>(8) Enter Fax No.</p> <p>(9) Finds an address.</p> <p>(10) Displays functions available in fax mode.</p> <p>(11) Scans the original for preview.
PREVIEW SCREEN (page 2-11)</p> <p>(12) Reset the address and settings.</p> <p>(13) Immediately starts sending a fax.</p> <p>(14) Connects a line before starting sending a fax.</p> |
|--|---|

SELECTING FAX MODE

Change the fax mode to other mode as explained in [CHANGING MODES \(page 2-10\)](#).



FAX TRANSMISSION SEQUENCE

This section explains the basic steps for sending a fax.

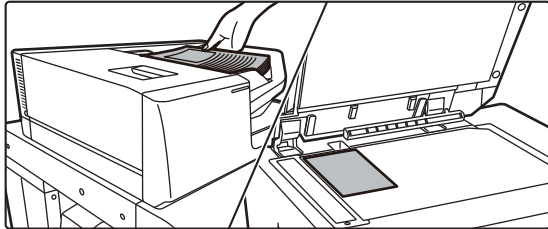
1

Place the original.

Place the original in the document feeder tray of the automatic document feeder, or on the document glass.
[AUTOMATIC DOCUMENT FEEDER \(page 1-34\)](#)
[DOCUMENT GLASS \(page 1-38\)](#)

2

Enter the destination fax number.

Tap the numeric keys to enter the destination number directly, or search and retrieve the address book or number.

In Easy mode

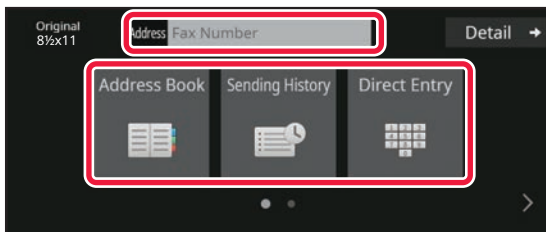

- [ENTERING A DESTINATION NUMBER USING THE NUMERIC KEYS \(page 5-10\)](#)
- [RETRIEVING A DESTINATION FROM AN ADDRESS BOOK \(page 5-11\)](#)
- [USING A TRANSMISSION LOG TO RESEND \(page 5-19\)](#)
- [RETRIEVING A DESTINATION FROM A MOBILE ADDRESS BOOK \(page 5-17\)](#)

In Normal mode

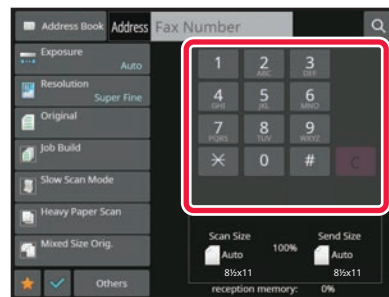

- [ENTERING A DESTINATION NUMBER USING THE NUMERIC KEYS \(page 5-10\)](#)
- [RETRIEVING A DESTINATION FROM AN ADDRESS BOOK \(page 5-11\)](#)
- [USING A SEARCH NUMBER TO RETRIEVE A DESTINATION \(page 5-14\)](#)
- [RETRIEVING A DESTINATION FROM A GLOBAL ADDRESS BOOK \(page 5-15\)](#)
- [RETRIEVING A DESTINATION FROM A MOBILE ADDRESS BOOK \(page 5-17\)](#)
- [USING A TRANSMISSION LOG TO RESEND \(page 5-19\)](#)



3

Configure the settings.

Specify the original scan size, exposure, resolution, etc.
If necessary, you can refer to the following functions for the setting.

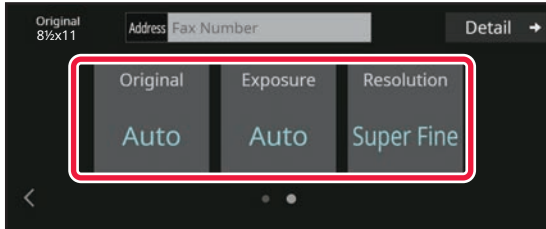
In Easy mode

- [SCANNING ORIGINALS \(page 6-131\)](#)
- [CHANGING THE EXPOSURE \(page 5-54\)](#)
- [CHANGING THE RESOLUTION \(page 5-55\)](#)

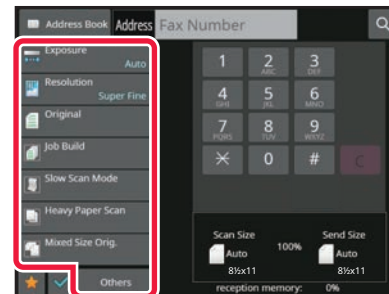
In Normal mode

- [SCANNING AND SENDING ORIGINALS COLLECTIVELY \(page 6-97\)](#)
- [SCANNING ORIGINALS \(page 6-131\)](#)
- [AUTOMATICALLY SCANNING BOTH SIDES OF AN ORIGINAL \(2-Sided Original\) \(page 5-42\)](#)
- [AUTO DETECTION \(page 5-43\)](#)
- [SPECIFYING THE ORIGINAL SCAN SIZE USING NUMERIC VALUES \(page 5-46\)](#)
- [SPECIFYING THE SEND SIZE OF THE IMAGE \(page 5-52\)](#)
- [CHANGING THE EXPOSURE \(page 5-54\)](#)
- [CHANGING THE RESOLUTION \(page 5-55\)](#)
- [SCANNING MANY ORIGINALS AT ONCE \(JOB BUILD\) \(page 6-113\)](#)
- [SCANNING A THIN ORIGINAL \(SLOW SCAN MODE\) \(page 6-134\)](#)
- [SCANNING ORIGINALS OF DIFFERENT SIZES \(MIXED SIZE ORIGINAL\) \(page 6-99\)](#)
- [CHECKING THE NUMBER OF SCANNED ORIGINAL SHEETS BEFORE TRANSMISSION \(ORIGINAL COUNT\) \(page 6-140\)](#)
- [OTHERS FUNCTIONS \(page 5-73\)](#)

4

Send the original.

Tap the [Start] key.



- To check a preview of a scanned image, tap the [Preview] key before tapping the [Start] key.
- **When the original is placed on the document glass:**
 - When sending a fax normally (memory transmission)
Repeat the steps for placing and scanning the originals the same number of times as there are originals. After scanning all originals, tap the [Read-End] key.
 - When sending a fax in direct transmission mode
Multi-page originals cannot be scanned in direct transmission mode. Tap the [Start] key to start transmission.
- In normal mode, if you tap [File] or [Quick File] on the action panel before starting fax transmission, you can save the scanned original as data.
[QUICK FILE \(page 7-9\)](#)
[FILE \(page 7-10\)](#)



ENTERING DESTINATIONS

ENTERING DESTINATIONS

This section explains how to enter a destination from the initial screen of easy mode.

[EASY MODE \(page 5-6\)](#)

ENTERING A DESTINATION NUMBER USING THE NUMERIC KEYS

1

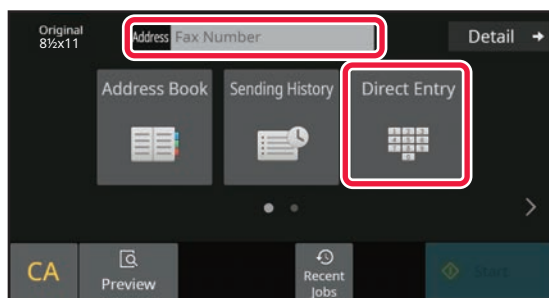

Tap the [Direct Entry] key or [Fax Number] to enter the destination fax number.

If you want to specify multiple destinations, tap **+** and enter the next fax number.

If you enter an incorrect number, tap the [C] key to delete the number and re-enter.

Entering a Pause Between Digits of the Number

Enter a pause after the number used to dial out from a PBX (for example, after "0"), or after the country code when dialing an international number.

1

Tap the [Pause] key.

A hyphen "-" is entered when the [Pause] key is tapped once.



If you want to enter a pause between digits of the number:

Enter a pause after the number used to dial out from a PBX (for example, after "0"), or after the country code when dialing an international number.

The [Pause] key appears on the numeric keys when the destination fax number is entered.

A hyphen "-" is entered when the [Pause] key is tapped once.



To set the length of pause:

In "Settings", select [System Settings] → [Image Send Settings] → [Fax Settings] → [Default Settings] → [Pause Time Setting].



RETRIEVING A DESTINATION FROM AN ADDRESS BOOK

A destination fax number is retrieved by simply tapping the one-touch key of that destination on the address book screen. (One-touch dialing)

It is also possible to store multiple fax numbers in a one-touch key, allowing you to retrieve all the numbers by simply tapping the key. This dialing method is convenient when you wish to send a fax to (or poll) multiple fax destinations. When destinations of other scan modes are stored in addition to fax destinations, an icon indicating the mode appears together with the name of the destination in each one-touch key.

	Fax
	Scan to E-mail
	Internet Fax (Direct SMTP)
	Scan to FTP
	Scan to Network Folder
	Scan to Desktop
	Group key with multiple destinations

- For information on the address book, see "[ADDRESS BOOK \(page 6-14\)](#)".
- For the procedure for storing an address in the address book, see "[STORING ADDRESSES THROUGH DIRECT ENTRY \(page 6-19\)](#)", "[STORING ADDRESSES THROUGH GLOBAL ADDRESS SEARCH \(page 6-20\)](#)", "[STORING ADDRESSES FROM FAX OR IMAGE SEND LOGS \(page 6-22\)](#)", "[STORING GROUPS \(page 6-24\)](#)".

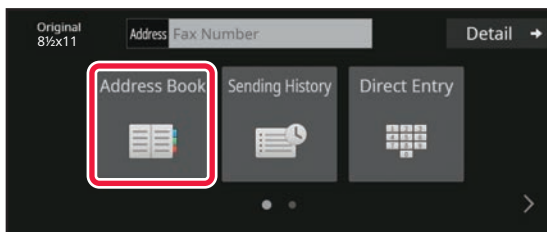
1

Tap the [Address Book] key.



2

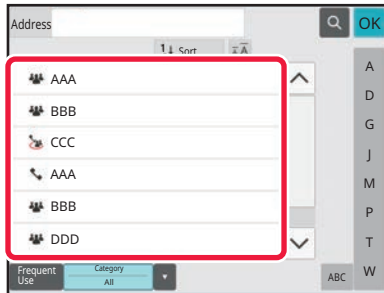

Tap a one-touch key of contact or group that includes the fax destination.

- The destinations displayed on the list can be narrowed with frequent use, categories, indexes, and keywords. (In normal mode, you can narrow down the destinations by job type.)
- Tapping [Sort] allows you to change the order of destinations displayed in the list.
- When adding a destination, tap another one-touch key.
- If two or more destinations are selected or specified, the total number of addresses appears next to address.
- Even if only a single destination is selected, the number of addresses appears when the destination is a contact or group in which multiple addresses are stored.
- For more information, see "[ADDRESS BOOK \(page 6-14\)](#)".



• If you select an incorrect destination:

Tap the key again to cancel the selection.

• To cancel a selected destination

Select the destination you want to cancel in the destination list screen, and tap the [Delete] key.



• To select a destination from the transmission log, tap the [Sending History] key.

[USING A TRANSMISSION LOG TO RESEND \(page 5-19\)](#)

• To check the entered destinations, tap the [Address Review] key.

[THE SELECTED DESTINATIONS \(page 5-13\)](#)

• The destination for transmission can be selected by tapping a stored destination.

• If an address that you do not have permission to use is included in the addresses, a message will appear when you press the [Start] key. To send only to the permitted addresses, press the [OK] key and then the [Enter for send] key.

In normal mode

• Tap the one-touch key, and then tap [Display Registered Information] on the action panel to display the detailed information.

• To retrieve a destination by using a search number, tap [Call Search Number] on the action panel.

[USING A TRANSMISSION LOG TO RESEND \(page 5-19\)](#)

• To retrieve a destination from a global address book, tap [Global Address Search] on the action panel.

[RETRIEVING A DESTINATION FROM A GLOBAL ADDRESS BOOK \(page 5-15\)](#)



To send to an address in other than the current mode

In "Settings (administrator)", remove the checkmark from [System Settings] → [Image Send Settings] → [Common Settings] → [Condition Settings] → [Address Book Default Selection] → [Apply Addresses of Sending Modes Only].



THE SELECTED DESTINATIONS

When multiple destinations have been selected, you can display and check the destinations. You can also delete a destination (cancel selection of the destination) if necessary.

1

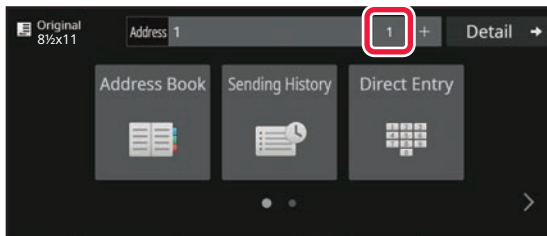

Tap the [All Destinations] key.

2

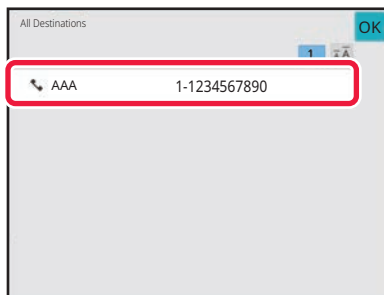

Confirm the destination.

After the confirmation is completed, tap **OK**.



- To confirm detailed information such as the type or name of the specified destination, tap the one-touch key of the target destination, and then tap the [Info.] key.
- If an address that you do not have permission to use is included, a prohibition mark will appear on the address.

DELETING SPECIFIED DESTINATIONS

Select the address and tap the [Delete] key.

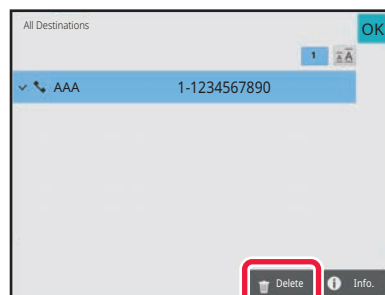

If you placed the original on the document glass and tapped the [Start] key, you cannot delete an address when changing settings.



USING A SEARCH NUMBER TO RETRIEVE A DESTINATION

The search number can be used to specify a destination stored in an address book.

1

Tap the [Detail] key to change normal mode.

[EASY MODE](#) (page 5-6)

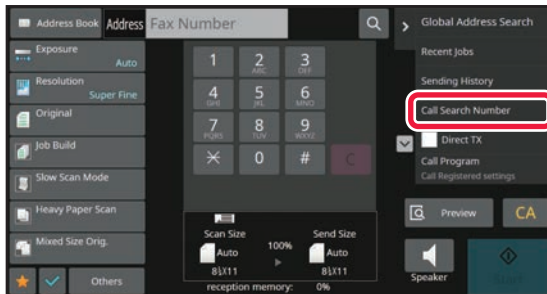
2

Tap [Call Search Number] on the action panel.

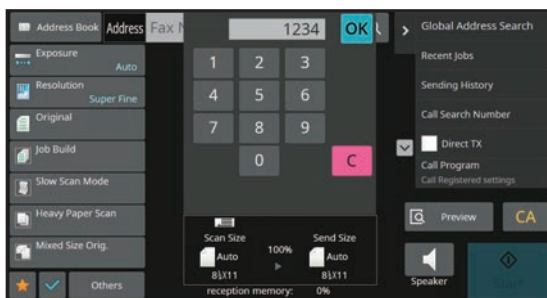
3

Enter a search number (4 digits) using the numeric keys and tap **OK**.

When the search number is entered, the stored address is retrieved and specified as a destination.



If an incorrect search number is entered:

Tap the [C] key to clear the number and enter the correct number.



- The search number is programmed when the destination is stored in the address book.
- If you do not know the search number, tap [Print Individual List] on the action panel to print and check the address list.
- When entering search numbers such as "0001" and "0011", "0" can be omitted. For example to enter "0001", enter "1" and tap **OK**.



RETRIEVING A DESTINATION FROM A GLOBAL ADDRESS BOOK

If an LDAP server is configured in the setting mode (Web version), you can search for the desired destination in the global address book and obtain the fax number when performing a fax transmission.

You can also add a retrieved address to the address book. However, addresses of the FTP/Desktop transmission cannot be stored from the machine.

1



In the base screen or address book screen, tap [Global Address Search] on the action panel.

2

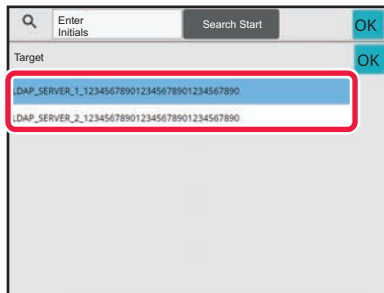

Tap [Target] and tap the LDAP server to be used.

- If an authentication screen for the LDAP server appears, enter your user name and password.
- If only one LDAP server has been stored, it is not necessary to take step 2. In this case, start from step 3.
- After the settings are completed, tap **OK**.

3

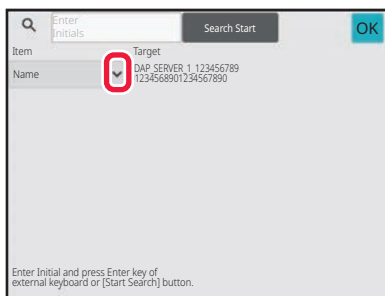

Tap  of [Item], and select an item to be searched from [Name/Address].



How to search

Enter the search characters (maximum of 64 characters). The system will look for names starting with the entered letters.

An asterisk ***** can be used as follows:

- XXX or ***XXX*** : Names containing the search characters will be searched
- XXX***** : Names beginning with "XXX"
- *XXX** : Names that end with "XXX"
- AA***XX** : Names that start with "AA" and end with "XX".



4



Enter a keyword and tap the [Search Start] key.

When you tap the keyword entry box, the soft keyboard appears.

The search results will appear after a brief interval.



- **If no destination is found:**

Tap the [Search Again] key.

- **To continuously add other destination:**

Tap the destination.



- **To check the destination information:**

Tap the one-touch key of the target destination, and then tap the [Info.] key. Tap **OK** to close the address information screen.

When you select the destination and tap the [New Registration with Address Book] on the action panel, the destination can be stored in the address book. This is convenient if you have entered a destination directly.



RETRIEVING A DESTINATION FROM A MOBILE ADDRESS BOOK

If the machine and mobile device are connected by Bluetooth, you can retrieve a destination from the mobile address book.

Destinations for fax transmission and e-mail transmission can be retrieved.



- The called address book is not saved in this machine.
- The maximum number of addresses that can be read from the mobile address book is 2000.
- For more information about the operation of mobile devices, please refer to the operation manual/help of the mobile device.



To use this function

Enable "Settings (administrator)" → [Network Settings] → [Bluetooth Setting] → [Bluetooth] to pair the machine and mobile device.

1

In Easy mode

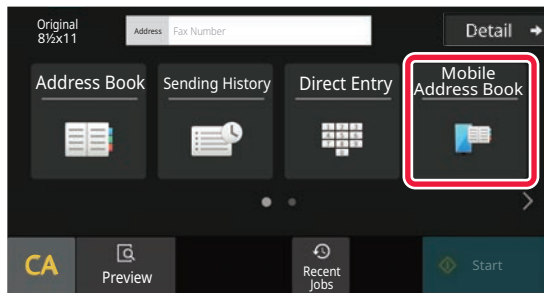

Tap the [Mobile Address Book] key.

In Normal mode



In the base screen or address book screen, tap [Refer to Mobile Address Book] on the action panel.



2

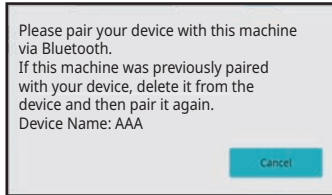

Operate the mobile device to be connected to pair it with the machine.

Device name of the machine is displayed on the screen.



When pairing with a mobile device that has been paired with this machine before, delete the information of this machine stored in the mobile device.

To set a device name to this machine

Configure in "Settings (administrator)" → [System Settings] → [Network Settings] → [Network Name Setting] → [Device Name].

The device name must be in 7 or less double-byte characters, or 15 or less single-byte characters.

3

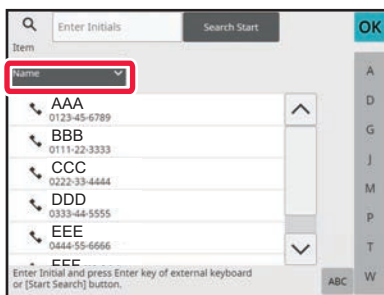

Tap (▼) of [Name], and select an item to be searched from [Initial], [Name] or [Address].

4

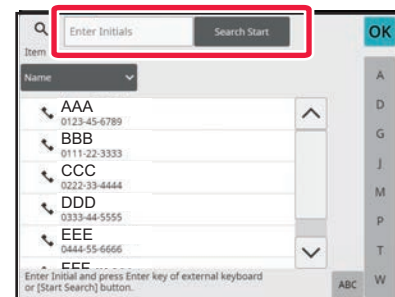

Enter a keyword and tap the [Search Start] key.

When you tap the keyword entry box, the soft keyboard appears.

The search results will appear after a brief interval.



- **If no destination is found:**
Tap the [Search Again] key to add more search letters.
- **To continuously add other destination.**
Tap the destination.



USING A TRANSMISSION LOG TO RESEND

Select a destination from a transmission log and resend the data.

The destinations of the most recent 50 transmissions by fax, Scan to E-mail, and/or Internet fax are stored. One of these can be selected to resend to that destination. The destinations of the FTP/Desktop transmission and Scan to Network Folder are also shown in the transmission log.

In normal mode, you can also add an address in a transmission history to the address book. This is a convenient way to store the fax numbers and addresses of destinations that were manually entered. However, addresses of the Network Folder transmission cannot be stored from the machine.



- If numeric keys were tapped during the previous transmission, the number may not be redialed correctly.
- The fax addresses below are not stored as addresses for which resend is possible.
 - One-touch key for a contact in which multiple destinations are stored.
 - Group destinations
 - Broadcasting destinations

1

In Easy mode

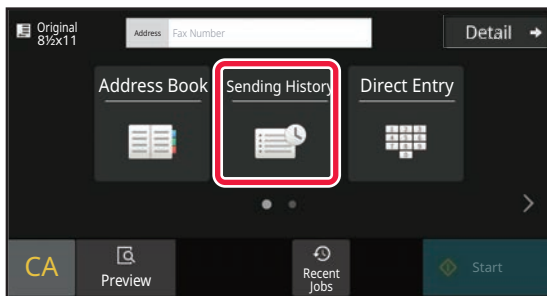

Tap the [Sending History] key.

In Normal mode

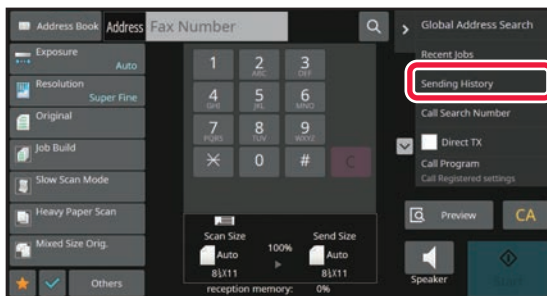

In the base screen or address book screen, tap [Sending History] on the action panel.



2

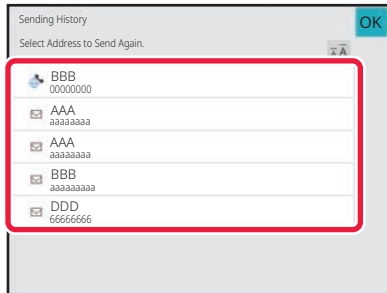

Tap the key of the fax destination that you wish to redial.

The last 50 addresses used for transmission are displayed.



To cancel the resend setting:

Tap the highlighted key.



In normal mode

- To add an address to the address book, select the address and tap [New Registration with Address Book] or [Additional Registration with Address Book] on the action panel.
- You can select an address and tap [Delete the Selected History] or [Delete All Histories] on the action panel to delete one or all histories.



SENDING BY CHAIN DIALING

Number sequences entered using the numeric keys and/or one-touch keys can be linked together with pauses and dialed as a single number.

For example when dialing an international number, tap the [Pause] key between the identification number of an international telephone service company (e.g., "001") and the country code (e.g., "81" for Japan) to insert a pause for smoother line connection.

The time (in seconds) set in "Settings", select [System Settings] → [Image Send Settings] → [Fax Settings] → [Default Settings] → [Pause Time Setting] defines the length of pause. Set a value from 1 to 15 seconds in increments of 1 second.

On the screen, a hyphen "-" indicates a pause.

If two seconds are set in [Pause Time Setting], tapping the [Pause] key three times enters pauses for 6 seconds.

Example: Using chain dialing to dial an international number

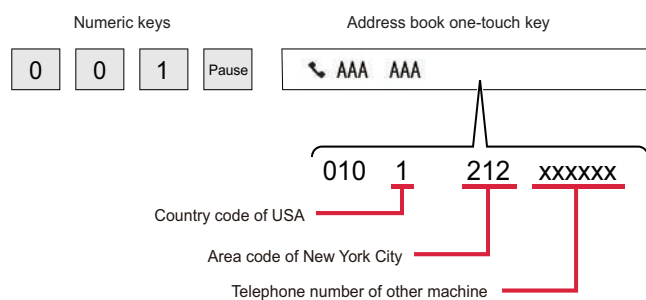

- Addresses that can be selected are addresses that only have one fax address saved.
- After entering the number with the numeric keys, tap the [Pause] key to enter the next number with the numeric keys, or tap the [Chain Dial] key on the action panel to select an address from the address book.
- After selecting the address from the address book, select [Chain Dial Combine with Direct Input] on the action panel to enter the next number with the numeric keys, or [Chain Dial Combine with Address Book] to select an address from the address book.



BASIC TRANSMISSION METHODS

BASIC TRANSMISSION METHODS

This section explains how to enter a destination from the initial screen of easy mode.

[SELECTING FAX MODE \(page 5-7\)](#)

FAX TRANSMISSION METHODS

The methods that can be used to send a fax from the machine are described below. Select the method that best suits your needs.

To fax a large number of sheet originals:

Use the automatic document feeder.

The originals will be scanned into memory and then transmitted (memory transmission).

When multiple original sheets are placed in line idle state, they will be sent in sequence from the scanned page in parallel with the scanning process (Quick On Line Sending).

If transmission cannot begin immediately because the line is in use, all pages will be scanned and stored in memory.

[USING THE AUTOMATIC DOCUMENT FEEDER FOR TRANSMISSION \(page 5-29\)](#)

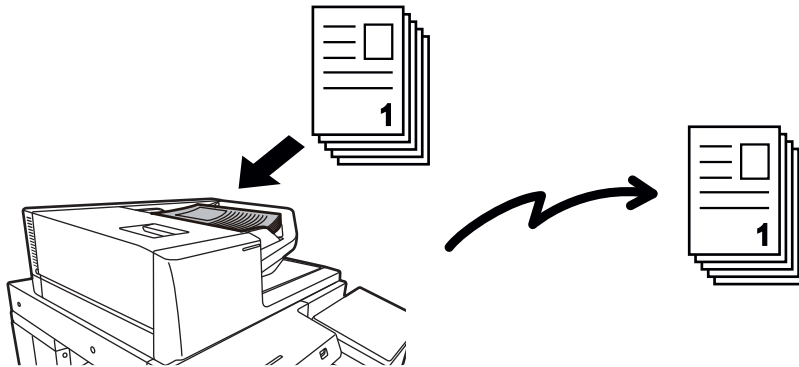

Storing a fax job

If transmission cannot begin immediately because the line is in use, all pages will be scanned and stored in memory. If you want to attempt to send a fax while another job is in progress, you can store the fax job. To check the stored fax job, display the job status screen.

[FAX JOBS \(page 5-104\)](#)



- If memory becomes full while the first original page is being scanned, transmission will stop.
- When the transmission is finished, the scanned original pages are cleared from memory. However, when the document filing function is used, the transmitted fax is stored.
[QUICK FILE \(page 7-9\)](#)
[FILE \(page 7-10\)](#)
- If Job Build is enabled, you can select the automatic document feeder or the document glass to scan the original. This sending method may not be available depending on the function.
[SCANNING MANY ORIGINALS AT ONCE \(JOB BUILD\) \(page 6-113\)](#)



In the following situations, the transmission will be automatically reserved (memory transmission)

- When the line is busy or a communication error occurs and automatic resending is enabled.
[WHEN A COMMUNICATION ERROR OCCURS \(page 5-26\)](#)
- The line of the machine will be busy if another fax is being sent, received, or if the machine is in the busy state.
- Another fax transmission was reserved ahead of your fax.
- One of the following functions is being used for transmission.
 - Broadcast transmission, F-code transmission, Timer transmission, Dual Page Scan, Book Divide, N-Up, Card Shot, Job Build, Original Count
- The document glass is being used (except when the speaker is being used to dial).



To disable the Quick On Line Sending setting:

- In "Settings", select [System Settings] → [Image Send Settings] → [Fax Settings] → [Send Settings] → [Quick On Line Sending].
- If you disable this setting, transmission will not begin until all pages have been scanned. Note that this setting does not apply to manual transmission.

To fax thick originals or pages of a book:

Place the original on the document glass.

[USING THE DOCUMENT GLASS FOR TRANSMISSION \(page 5-32\)](#)

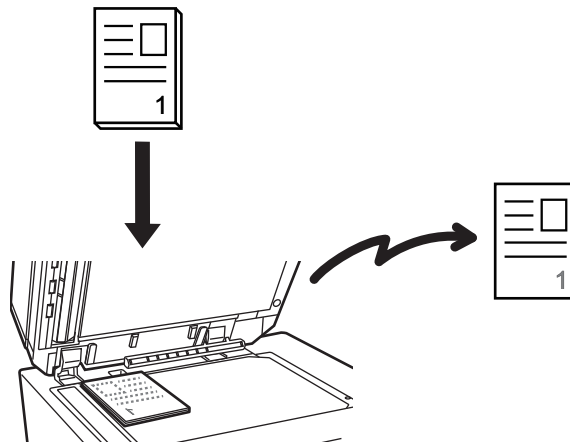

- Quick On Line Sending is not available when a fax is being sent from the document glass.
- When the document glass is used, multiple original pages cannot be scanned at a time. In this case, the original pages can be separated into multiple times of scanning.

If you wish to send a fax ahead of other previously reserved fax transmissions:

Send the fax in direct transmission mode. The original is transmitted directly to the receiving fax machine without being scanned into memory.

When direct transmission mode is used, transmission will begin as soon as the transmission in progress is completed (ahead of any previously reserved transmissions).

Tap [Direct TX] on the action panel to send a fax.

[USING THE AUTOMATIC DOCUMENT FEEDER FOR FAXING IN DIRECT TX MODE \(page 5-30\)](#)

[USING THE DOCUMENT GLASS TO SEND A FAX IN DIRECT TX MODE \(page 5-34\)](#)







When transmission in direct transmission mode ends, the mode automatically changes back to memory transmission mode.



In direct transmission mode, the [Preview] key cannot be used for transmission.

ORIGINAL ORIENTATION

When an 8-1/2" x 11" (A4) original is placed in vertical orientation (), the image is automatically rotated 90 degrees and transmitted in horizontal orientation () (Rotation Sending).

If the original is placed in horizontal orientation (), it is transmitted in that orientation () without being rotated.

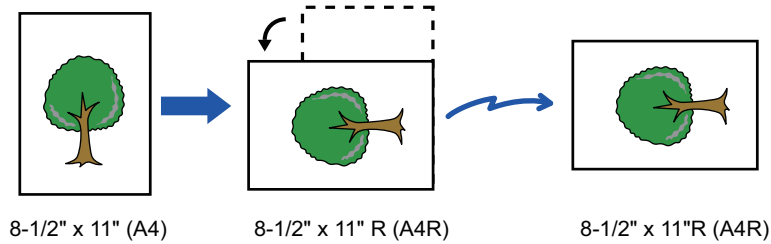

Rotation sending is not available for originals with 8-1/2" x 11" R or 5-1/2" x 8-1/2" (A4R, B5, or A5) size.



To cancel the rotation sending setting:

In "Settings (administrator)", select [System Settings] → [Image Send Settings] → [Fax Settings] → [Send Settings] → [Rotation Sending Setting].

If this setting is disabled, the original will be transmitted in the orientation in which it is placed.

Because of this, some receiving machines may reduce the received data.



AUTOMATIC REDUCTION OF THE TRANSMITTED IMAGE

If the width of the transmitted image is larger than the width of the paper in the receiving machine, the image will be automatically reduced to fit the receiving machine's paper width.

Example: Reduced sizes and reduction ratios

Transmitted image width	Receiving machine's paper width	Reduced size	Scaling
11" x 17" (A3)	B4	B4	1:0.8
11" x 17" (A3)	8-1/2" x 11" (A4)	A4R	1:0.7
B4	8-1/2" x 11" (A4)	A4R	1:0.8



To cancel the Auto Reduction Sending setting:

In "Settings", select [System Settings] → [Image Send Settings] → [Fax Settings] → [Send Settings] → [Auto Reduction Sending Setting].

If this setting is disabled, the image will be sent at full size and part of the image may be cut off.

TRANSMITTABLE ORIGINAL SIZES

For information on the original sizes that can be loaded, see "[AUTOMATIC DOCUMENT FEEDER \(page 1-34\)](#)" and "[DOCUMENT GLASS \(page 1-38\)](#)".

THE SIZE OF THE PLACED ORIGINAL

When a standard size original is placed, the original size is automatically detected and displayed in "Scan Size" on the base screen.

[AUTO DETECTION \(page 5-43\)](#)

Standard sizes are sizes that the machine can automatically detect. The standard sizes are set in "Original Size Detector Setting" in setting mode.



When the automatic original detection function is operating and the original (of inch or non-standard size) is placed, the closest size may be displayed or the original size may not appear. In this event, manually set the correct original size.

[SPECIFYING THE ORIGINAL SCAN SIZE IN PAPER SIZE \(page 5-44\)](#)

[SPECIFYING THE ORIGINAL SCAN SIZE USING NUMERIC VALUES \(page 5-46\)](#)



To specify the size that the machine can automatically detect:

In "Settings (administrator)", select the group of detected original sizes in [System Settings] → [Common Settings] → [Device Control] → [Condition Settings] → [Original Size Detector Setting].

List of original size detector settings

[DETECTABLE ORIGINAL SIZES \(page 1-32\)](#)



WHEN THE LINE IS BUSY

If the line is busy when you send a fax, transmission will be attempted again automatically after a preset interval. This function only operates in memory transmission mode. In direct transmission mode or manual transmission mode, the transmission will be canceled. Wait for a brief period and then try sending the fax again.

**To cancel transmission:**

Do so from the job status screen.

[STOPPING/DELETING A JOB. PRIORITY PROCESSING AND CHECKING THE STATUS \(page 2-52\)](#)

**To set the number of recall attempts and the interval between attempts when the connection cannot be established because the line is busy, or for other reasons:**

In "Settings (administrator)", select [System Settings] → [Image Send Settings] → [Fax Settings] → [Send Settings] → [Recall in Case of Line Busy].

When this setting is enabled, note that the machine will not attempt the call again when manual transmission or direct transmission is used.

WHEN A COMMUNICATION ERROR OCCURS

If a communication error occurs or the other fax machine does not answer the call within a preset period of time, transmission will automatically be attempted again after a preset interval. This function only operates in memory transmission mode.



Faxes sent by direct transmission or manual transmission are not automatically resent.

**To cancel transmission:**

Do so from the job status screen.

[STOPPING/DELETING A JOB. PRIORITY PROCESSING AND CHECKING THE STATUS \(page 2-52\)](#)

**To set the number of recall attempts and the interval between attempts when a transmission fails due to an error:**

In "Settings (administrator)", select [System Settings] → [Image Send Settings] → [Fax Settings] → [Send Settings] → [Recall in Case of Communication Error].



FAX DEST. CONFIRMATION MODE

This mode displays a destination confirmation message when a fax is sent to prevent accidental transmission to the wrong destination. Set it in setting mode. If a fax is sent while this function is enabled, an address confirmation message will appear when the [Start] key is tapped.

The message that appears will vary depending on the method used to specify the destination.



After tapping the [Speaker] key while "Fax Dest. Confirmation Mode" is enabled, the destination cannot be specified using the numeric keys, one-touch key, [Call Search Number] key, or [Sending History] key. However, it is possible to send through a telephone.



- **To display the destination confirmation message prior to fax transmission:**

In "Settings", select [System Settings] → [Image Send Settings] → [Fax Settings] → [Default Settings] → [Fax Dest. Confirmation Mode].

- **To check destinations other than fax:**

In "Settings", select [System Settings] → [Image Send Settings] → [Fax Settings] → [Default Settings] → [Fax Dest. Confirmation Mode] → [Apply to Addresses Other Than Fax].

- **To disable fax broadcast when Fax Dest. Confirmation Mode is enabled:**

In "Settings", select [System Settings] → [Image Send Settings] → [Fax Settings] → [Send Settings] → [Disable Fax Broadcasting].

Destination specified by one-touch key/search number/global address search

Tap the [Start] key to display all destinations in the destination confirmation screen. Check that the destinations are correct, and tap the [Enter for send] key to start scanning of the original.

If the destination is not correct, tap the [OK] key and select the destination again.



- You can select multiple one-touch keys for contacts or groups including fax destinations.
- Before tapping the [Enter for send] key, you can change scan or other settings.



Destination specified using the numeric keys

With "Fax Dest. Confirmation Mode" enabled, and "Require Re-entry when Directly Entering the Fax Destination" enabled

Tap the [Start] key to display the confirmation message.

Tap the [OK] key, re-enter the destination using the numeric keys, and tap the [Enter Address] key.

If the re-entered destination is correct, scanning will begin.

If the re-entered destination is not correct, a message will appear. Tap the [OK] key and re-enter the destination. If an incorrect address is entered three times for confirmation, all the previous settings are canceled, and you will return to the base screen.

With "Fax Dest. Confirmation Mode" enabled, and "Require Re-entry when Directly Entering the Fax Destination" disabled

Tap the [Start] key to display entered destinations in the destination confirmation screen. Check that the destinations are correct, and tap the [Enter for send] key to start scanning of the original.



- You can use the numeric keys to enter fax numbers serially. In that case, tap  to enter the destination fax number to be added.
- If the [Sub Address] key was tapped to enter a sub-address and passcode, the fax number must be re-entered during confirmation. After re-entering the fax number, tap the [Sub Address] key and enter the sub-address and passcode.
- If chain dialing was used, tap the [Pause] key to enter "-" during confirmation.
- Before tapping the [Enter for send] key, you can change scan or other settings.



To set whether to re-enter at direct entry:

In "Settings (administrator)", select [System Settings] → [Image Send Settings] → [Fax Settings] → [Condition Settings] → [Fax Dest. Confirmation Mode] → [Require Re-entry when Directly Entering the Fax Destination].

When a fax that was selected from the Sending History has been resent

A confirmation screen is displayed based on the method used to specify the destination during the previous transmission.

CHECKING THE IMAGE TO BE TRANSMITTED

Check the image that will be sent in the touch panel before transmission.

You can tap the [Preview] key and then scan the original to check a preview of the scanned image. As you can adjust the exposure and resolution to scan the original while checking it in the preview screen, you can send a better quality original to the destination.

[PREVIEW SCREEN \(page 2-11\)](#)

The settings and functions that can be changed while and after an image is scanned for preview are as follows:

Exposure, Send Size, 2-Sided Booklet/Tablet, Resolution, Erase, N-Up, File, Quick File, Timer, Own Name Select, and Transaction Report.



- Depending on the size of the transmission data, part of the preview image may not appear in the preview screen in the touch panel.
- The preview function is not available when the original size is set to Long Size.



FAX TRANSMISSION METHODS

This section explains how to enter a destination from the initial screen of easy mode.

[EASY MODE \(page 5-6\)](#)

USING THE AUTOMATIC DOCUMENT FEEDER FOR TRANSMISSION

Storing scanned originals in machine's memory before transmitting them is called "Memory TX".

This section explains how to scan the original through the automatic document feeder and send the data by the memory transmission function.



- To fax a thick original or other original that cannot be placed in the automatic document feeder, open the automatic document feeder and place the original on the document glass.
- If there is a fax job in progress when the transmission operation is performed, the fax is transmitted when the job in progress is finished.
- If the memory becomes full while the originals are being scanned, a message will appear and scanning will stop. When Quick On Line Sending is enabled for transmission, the scanned originals are sent.



• **To disable the Quick On Line Sending setting:**

In "Settings (administrator)", select [System Settings] → [Image Send Settings] → [Fax Settings] → [Send Settings] → [Quick On Line Sending].

If you disable this setting, memory transmission will not begin until all pages have been scanned.

• **To set the scan complete sound:**

In "Settings (administrator)", select [System Settings] → [Common Settings] → [Sound Settings] → [Beep Sound Settings (Common)] → [Scan Complete Sound (Image Send)].

• **Always stamp scanned originals:**

In "Settings (administrator)", select [System Settings] → [Image Send Settings] → [Common Settings] → [Condition Settings] → [Default Verification Stamp]. When this is enabled, originals are always stamped without the need to select "Verification Stamp".

• **To disable the Disabling of Document Feeder setting:**

In "Settings (administrator)", select [System Settings] → [Common Settings] → [Device Control] → [Condition Settings] or [Enable/Disable Settings] → [Disabling of Document Feeder].

1

Place the original in the document feeder tray of the automatic document feeder.

[AUTOMATIC DOCUMENT FEEDER \(page 1-34\)](#)

2

Specify the destination fax number.

- [ENTERING A DESTINATION NUMBER USING THE NUMERIC KEYS \(page 5-10\)](#)
- [RETRIEVING A DESTINATION FROM AN ADDRESS BOOK \(page 5-11\)](#)
- [USING A SEARCH NUMBER TO RETRIEVE A DESTINATION \(page 5-14\)](#)
- [RETRIEVING A DESTINATION FROM A GLOBAL ADDRESS BOOK \(page 5-15\)](#)
- [RETRIEVING A DESTINATION FROM A MOBILE ADDRESS BOOK \(page 5-17\)](#)
- [USING A TRANSMISSION LOG TO RESEND \(page 5-19\)](#)

3

Tap the [Start] key to begin transmission.

When scanning is completed, the machine beeps.



- Tap the [Preview] key to check the preview of an image before sending a fax. For more information, see "[FAX TRANSMISSION METHODS \(page 5-29\)](#)".
- When all originals have been scanned, "Job stored." will be displayed together with a job control number. This number is recorded in the transaction report and image sending activity report and can be used to check fax jobs. [PRINTING IMAGE SENDING ACTIVITY REPORTS \(page 5-105\)](#)



To cancel scanning the original:
Tap the [Cancel Scan] key.

USING THE AUTOMATIC DOCUMENT FEEDER FOR FAXING IN DIRECT TX MODE

Sending a scanned original without saving it in the machine's memory is called "Direct TX". This section explains how to scan the original through the automatic document feeder and directly send it.



To fax a thick original or other original that cannot be placed in the automatic document feeder, open the automatic document feeder and place the original on the document glass.



- The following functions cannot be used with direct transmission:
Timer Transmission, N-Up, Card Shot, Job Build, Polling Memory, Original Count, File, Quick File, Memory Box, Book Divide, Poling, 2-Sided Scan, Search Global Address Book
- Resending will not take place when a direct transmission is not successful due to a communication error or other reason.
- If a fax transmission is already in progress when the direct transmission operation is performed, the direct transmission will wait until the previous transmission is finished. When the previous transmission is completed, the direct transmission will begin.
- While the direct transmission is waiting, the job status display can be tapped to display the job status screen. No other operations are possible.
[FAX JOBS \(page 5-104\)](#)
- The [Preview] key cannot be used for transmission.
- To disable the Disabling of Document Feeder setting:
In "Settings (administrator)", select [System Settings] → [Common Settings] → [Device Control] → [Condition Settings] or [Enable/Disable Settings] → [Disabling of Document Feeder].

1

Tap the [Detail] key to change to normal mode.

[EASY MODE \(page 5-6\)](#)

2

Place the original in the document feeder tray of the automatic document feeder.

[AUTOMATIC DOCUMENT FEEDER \(page 1-34\)](#)



3



Specify the destination fax number, and tap [Direct TX] on the action panel.

4

Specify the destination fax number.

- [ENTERING A DESTINATION NUMBER USING THE NUMERIC KEYS \(page 5-10\)](#)
- [RETRIEVING A DESTINATION FROM AN ADDRESS BOOK \(page 5-11\)](#)
- [USING A SEARCH NUMBER TO RETRIEVE A DESTINATION \(page 5-14\)](#)
- [USING A TRANSMISSION LOG TO RESEND \(page 5-19\)](#)



- Only one destination can be specified. A one-touch key in which multiple destinations are stored cannot be used.
- The destination cannot be retrieved from a global address book.

5

Tap the [Start] key to begin transmission.



- If a fax transmission is already in progress when the direct transmission operation is performed, the direct transmission will wait until the previous transmission is finished. When the previous transmission is completed, the direct transmission will begin.
- While the direct transmission is waiting, you can only check the job status.
- [JOB STATUS \(page 2-52\)](#)



To cancel scanning the original:

- Tap the [Cancel Scan] key.



USING THE DOCUMENT GLASS FOR TRANSMISSION

Storing scanned originals in machine's memory before transmitting them is called "Memory TX".

This section explains how to scan the original placed on the document glass and send the data by the memory transmission function.



- If a fax is being received when the transmission operation is performed, the transmission will be reserved and transmission will take place after fax reception is completed.
- If the memory becomes full while the originals are being scanned, a message will appear and transmission will be canceled.



Do not place any objects under the original size detector. Closing the automatic document feeder with an object underneath may damage the original size detector plate and prevent correct detection of the document size.

1

Place the original on the document glass.

[EASY MODE \(page 5-6\)](#)



- When faxing a multi-page original, scan each page in order starting from the first page.

2

Specify the destination fax number.

- [ENTERING A DESTINATION NUMBER USING THE NUMERIC KEYS \(page 5-10\)](#)
- [RETRIEVING A DESTINATION FROM AN ADDRESS BOOK \(page 5-11\)](#)
- [USING A SEARCH NUMBER TO RETRIEVE A DESTINATION \(page 5-14\)](#)
- [RETRIEVING A DESTINATION FROM A GLOBAL ADDRESS BOOK \(page 5-15\)](#)
- [RETRIEVING A DESTINATION FROM A MOBILE ADDRESS BOOK \(page 5-17\)](#)
- [USING A TRANSMISSION LOG TO RESEND \(page 5-19\)](#)

3

Tap the [Start] key to begin transmission.

When scanning is completed, the machine beeps.

4

If you have another page to scan, change pages and then tap the [Start] key.

Repeat until all originals have been scanned.



- If no action is taken for one minute, scanning automatically ends and the transmission is reserved.



5

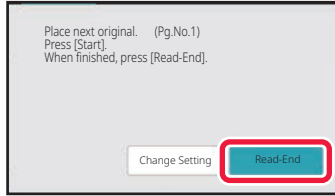

Tap the [Read-End] key.

A beep sounds.

Open the automatic document feeder and remove the original.



To cancel scanning:

Tap the [CA] key before the [Read-End] key is tapped.



- When all originals have been scanned, "Job stored." will be displayed together with a job control number. This number can be used to locate the job in the Transaction Report or in the Image Sending Activity Report. [PRINTING IMAGE SENDING ACTIVITY REPORTS \(page 5-105\)](#)
- If no action is taken for one minute after the confirmation screen is displayed, scanning automatically ends and the transmission is reserved.
- The [Change Setting] key can be tapped, if necessary, to change the exposure, resolution, scan size, and send size for each original page scanned. However, when "N-Up" or "Card Shot" is selected in Others, only the exposure can be changed when scanning an even-numbered original page.



To cancel transmission:

Tap the [CA] key before the [Read-End] key is tapped.



USING THE DOCUMENT GLASS TO SEND A FAX IN DIRECT TX MODE

Sending a scanned original without saving it in the machine's memory is called "Direct TX".

This section explains how to scan the original placed on the document glass and directly send data.

When sending a fax from the document glass in direct transmission mode, only one page can be transmitted.



- The following functions cannot be used with direct transmission:
Timer Transmission, N-Up, Card Shot, Job Build, Polling Memory, Original Count, File, Quick File, Memory Box, Book Divide, Poling, 2-Sided Scan, Search Global Address Book
- Resending will not take place when a direct transmission is not successful due to a communication error or other reason.
- If a fax transmission is already in progress when the direct transmission operation is performed, the direct transmission will wait until the previous transmission is finished. When the previous transmission is completed, the direct transmission will begin.
- While the direct transmission is waiting, the job status display can be tapped to display the job status screen. No other operations are possible.
[FAX JOBS \(page 5-104\)](#)
- The [Preview] key cannot be used for transmission.



Do not place any objects under the original size detector. Closing the automatic document feeder with an object underneath may damage the original size detector plate and prevent correct detection of the document size.

1

Tap the [Detail] key to change to normal mode.

[CHANGING MODES \(page 2-10\)](#)

2

Place the original on the document glass.

[DOCUMENT GLASS \(page 1-38\)](#)



When faxing a multi-page original, scan each page in order starting from the first page.

3

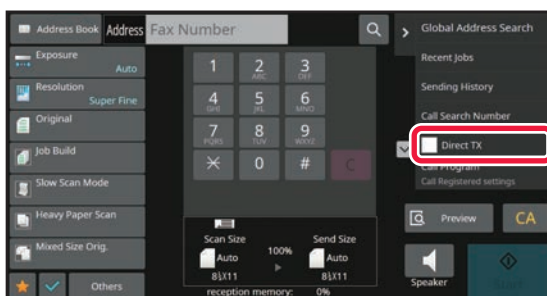

Specify the destination fax number, and tap [Direct TX] on the action panel.



4

Specify the destination fax number.

- [ENTERING A DESTINATION NUMBER USING THE NUMERIC KEYS \(page 5-10\)](#)
- [RETRIEVING A DESTINATION FROM AN ADDRESS BOOK \(page 5-11\)](#)
- [USING A SEARCH NUMBER TO RETRIEVE A DESTINATION \(page 5-14\)](#)
- [USING A TRANSMISSION LOG TO RESEND \(page 5-19\)](#)



- Only one destination can be specified. A one-touch key in which multiple destinations are stored cannot be used.
- The destination cannot be retrieved from a global address book.

5

Tap the [Start] key to begin transmission.

When the line has been connected to the destination, scanning of the original starts.



If a fax transmission is already in progress when the direct transmission operation is performed, the direct transmission will wait until the previous transmission is finished. When the previous transmission is completed, the direct transmission will begin.

While the direct transmission is waiting, you can only check the job status.

[JOB STATUS \(page 2-52\)](#)



To cancel scanning the original:

Tap the [Cancel Scan] key.



TRANSMISSION USING THE SPEAKER

When the speaker is used to dial, the fax is sent after the number is dialed and the connection is established.



- If a person answers, you will be able to hear his or her voice, but you will not be able to speak.
- When the speaker is used, transmission takes place without scanning the original into memory.
- A destination that includes an F-code (sub-address and passcode) cannot be used.
- A one-touch key that has multiple destinations or has a non-fax destination cannot be used.
- In speaker mode, the [Preview] key cannot be used for transmission.

1

Tap the [Detail] key to switch to the normal mode.

[EASY MODE \(page 5-6\)](#)

2

Place the original.

Place the original in the document feeder tray of the automatic document feeder, or on the document glass.

[AUTOMATIC DOCUMENT FEEDER \(page 1-34\)](#)

[DOCUMENT GLASS \(page 1-38\)](#)

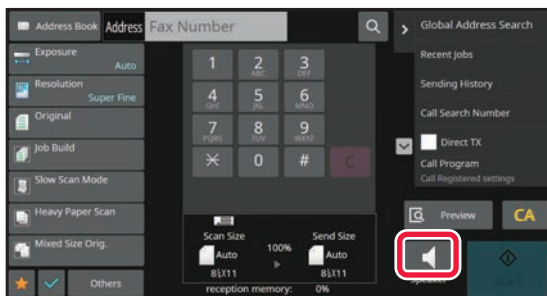
3

Tap the [Speaker] key.

When the connection is established, you will hear the dial tone through the machine's speaker.



Tapping allows you to use the slider or keys to adjust the volume of the speaker.

4

Specify the destination fax number.

- [ENTERING A DESTINATION NUMBER USING THE NUMERIC KEYS \(page 5-10\)](#)
- [RETRIEVING A DESTINATION FROM AN ADDRESS BOOK \(page 5-11\)](#)
- [USING A SEARCH NUMBER TO RETRIEVE A DESTINATION \(page 5-14\)](#)
- [USING A TRANSMISSION LOG TO RESEND \(page 5-19\)](#)



A one-touch key in which multiple destinations are stored cannot be used

5

When the connection is made, tap the [Start] key to begin transmission.



To cancel transmission:

To stop transmission, tap the [Sending canceled] key. To stop communication, tap the [Speaker] key.



SENDING THE SAME FAX TO MULTIPLE DESTINATIONS (BROADCAST TRANSMISSION)

You can send a fax to multiple destinations in a single operation when, for example, sending a report to branch offices in different regions. This function is called "Broadcasting".

One operation allows you to send data to up to 500 destinations, including the reserved send jobs. (For example, if broadcast transmission jobs with 450 destinations are already reserved, data can be broadcasted to up to 50 destinations.)

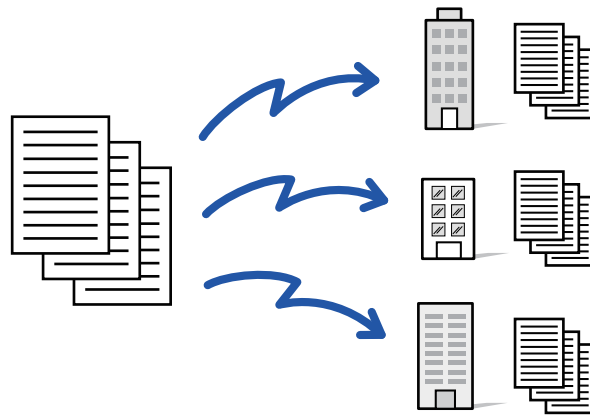

It is convenient to store destinations you frequently use for broadcast transmission as contacts or groups. A maximum of 500 destinations can be stored in one contact.

For broadcast transmission, the contact or group key can be simply tapped to retrieve multiple fax numbers.

You can also send faxes with the one-touch key by setting the [Set as Default used] checkbox to when addresses are registered. If you wish to temporarily remove a destination from the stored addresses, open the detail confirmation screen and remove the destination in the screen.

[ADDRESS BOOK \(page 6-14\)](#)

[STORING ADDRESSES THROUGH DIRECT ENTRY \(page 6-19\)](#)

[STORING ADDRESSES THROUGH GLOBAL ADDRESS SEARCH \(page 6-20\)](#)

[STORING ADDRESSES FROM FAX OR IMAGE SEND LOGS \(page 6-22\)](#)

[STORING GROUPS \(page 6-24\)](#)



When the checkbox of "Settings (administrator)" -[System Settings] → [Image Send Settings] → [Common Settings] → [Default Settings] → [Address Book Default Selection] → [Apply Addresses of Sending Modes Only] is selected (factory default setting), the fax is only sent to those destinations that are for fax among the destinations that are set to [Set as Default used]. If the checkmark is removed , the fax can be sent to destinations of other modes.

When a one-touch key is used to dial, the number of fax numbers that are dialed is the number of destinations that are stored in the one-touch key. When a one-touch key that has 10 destinations is used, 10 fax numbers are dialed.



- Broadcast transmission is available only for memory transmission.
- If this function is combined with "Timer Transmission", broadcast transmission can be performed at any time, such as at night.
A broadcast transmission can also be used in combination with other convenient functions.
- Even if a color original is being used, it will be sent to fax and Internet fax destinations in black and white. A long original is also sent in black and white.
- If you wish to send the same image as fax to all destinations, tap [Send Same Image as Fax Address] on the action panel.
- When Scan to E-mail and Internet Fax destinations are included, the send width for Scan to E-mail and Internet Fax will be the same as the send width for fax.
- Direct SMTP addresses cannot be included in a transmission.



1

Place the original.

Place the original in the document feeder tray of the automatic document feeder, or on the document glass.
[AUTOMATIC DOCUMENT FEEDER \(page 1-34\)](#)
[DOCUMENT GLASS \(page 1-38\)](#)

2

Specify all destinations.

- [ENTERING A DESTINATION NUMBER USING THE NUMERIC KEYS \(page 5-10\)](#)
- [RETRIEVING A DESTINATION FROM AN ADDRESS BOOK \(page 5-11\)](#)
- [USING A SEARCH NUMBER TO RETRIEVE A DESTINATION \(page 5-14\)](#)
- [RETRIEVING A DESTINATION FROM A GLOBAL ADDRESS BOOK \(page 5-15\)](#)
- [RETRIEVING A DESTINATION FROM A MOBILE ADDRESS BOOK \(page 5-17\)](#)
- [USING A TRANSMISSION LOG TO RESEND \(page 5-19\)](#)



After entering a destination using the numeric keys, if you wish to enter another destination using the numeric keys, tap **+** before entering the next destination.
+ can be omitted before or after a destination entered using a one-touch key.
If "Be sure to press Next Address Key ([+]) before selecting the next address." is enabled in setting mode, tap **+** before specifying the next destination.

3

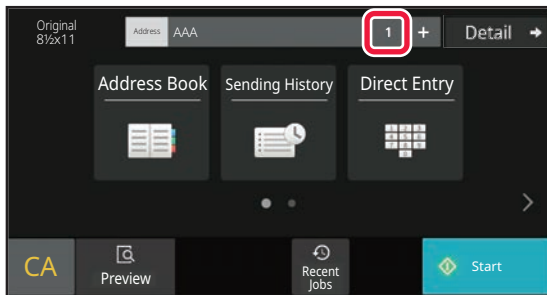

Tap the [All Destinations] key.

4

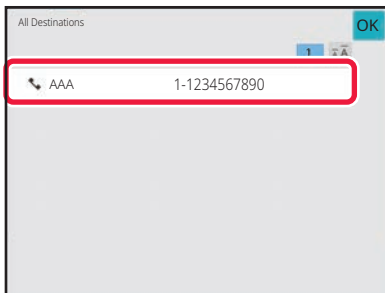

Confirm the destination.



To cancel a specified destination:

Select the address you want to cancel in the address list screen, and tap the [Delete] key.



5

Tap the [Start] key to start scanning of the original.

- If you inserted the original pages in the document feeder tray, all pages are scanned. A beep will sound to indicate that scanning and transmission have ended.
- When you place the original on the document glass, scan each page one at a time. When scanning finishes, place the next original and tap the [Start] key. Repeat the procedure until all pages have been scanned and then tap the [Read-End] key. A beep will sound to indicate that scanning and transmission have ended.



You can tap the [Preview] key to check a preview of the image before sending a fax. For more information, see "[CHECKING THE IMAGE TO BE TRANSMITTED \(page 5-28\)](#)".



RESENDING TO UNSUCCESSFUL BROADCAST TRANSMISSION DESTINATIONS

The results of a completed broadcast transmission can be checked in the job status screen. If transmission to any of the destinations failed, resend the fax to those destinations.

1

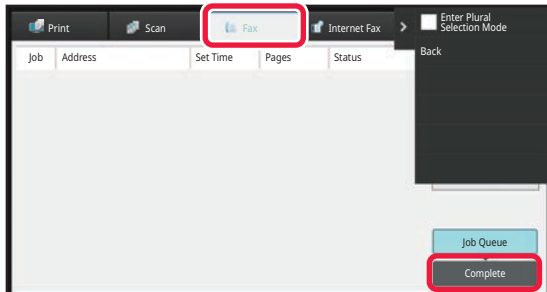

Tap the job status display, and tapping the [Fax] tab.

2

Tap the [Complete] key.

3

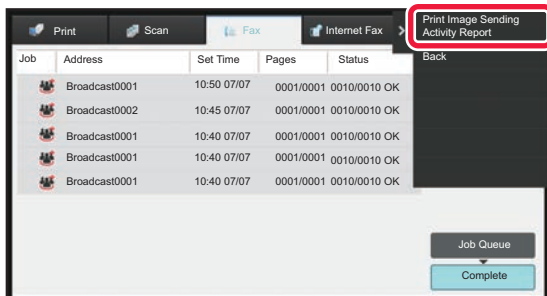

After tapping the key of the completed broadcast transmission, tap [Check Details of Selected Job] on the action panel.



If the broadcast transmission included destinations of different modes, the same broadcast transmission key will appear in each of those modes.

4

After tapping the [Failed] tab, tap [Resend to All Addresses Which Failed in Sending] on the action panel to resend the image.



- The steps to follow after [Resend to All Addresses Which Failed in Sending] is tapped differ depending on whether or not the document filing function is used.
- **Using document filing:**
You will return to the document filing resend screen with the unsuccessful destinations entered. Perform the document filing resend procedure. (There is no need to re-scan the original.)
If the job was stored in a confidential folder or was stored as confidential file, a password entry screen will appear after you tap the [Retry] key. Enter the password.
- **Not using document filing:**
You will return to the base screen with the unsuccessful destinations entered. Place the original and perform the steps of the broadcast transmission.



SENDING A FAX DIRECTLY FROM A COMPUTER (PC-Fax)

A file on a computer can be sent via the machine as a fax (PC-Fax function). Faxes are sent using the PC-Fax function in the same way that documents are printed. Select the PC-Fax driver as the printer driver for your computer and then select the Print command in the application. Image data for transmission will be created and sent as a fax.

By using the "Log Viewer" application, faxes can be sent using the transmission log displayed in the Log Viewer.

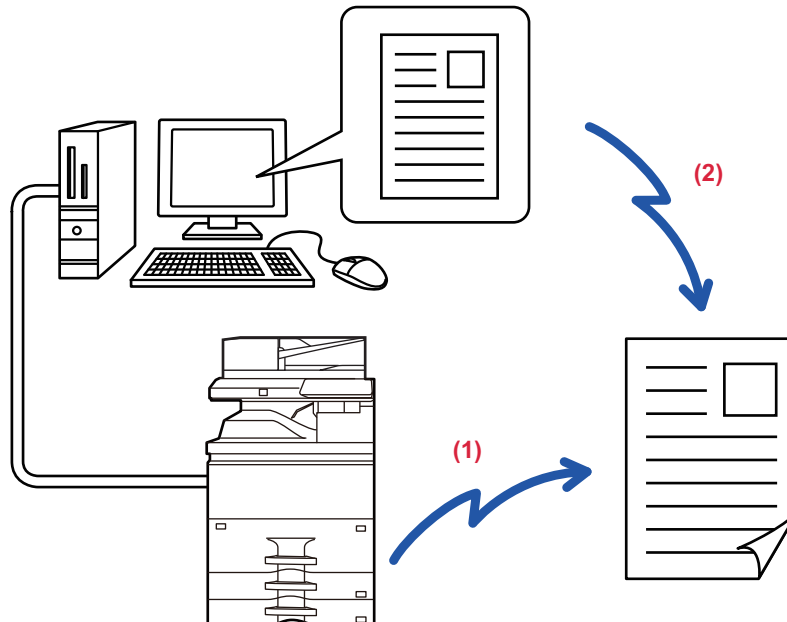

(1) **PC-I-Fax Send**

(2) **Log Viewer**

Re-send faxes using the transmission log

For the procedures for using this function, see the PC-Fax driver Help.



- To use the PC-Fax function, the PC-Fax driver must be installed. For more information, see the Software Setup Guide.
- This function can only be used on a Windows® computer.



Only transmission is available for this function. Faxes cannot be received by your computer.

DELETING A TRANSMISSION LOG

You can check transmission logs from the action panel of each image send mode.

You can delete an address selected in a transmission log, or delete all addresses.

[STOPPING/DELETING A JOB, PRIORITY PROCESSING AND CHECKING THE STATUS \(page 2-52\)](#)



SET THE SCANNING OF THE ORIGINALS

This section explains how to enter a destination from the initial screen of easy mode.

[EASY MODE \(page 5-6\)](#)

AUTOMATICALLY SCANNING BOTH SIDES OF AN ORIGINAL (2-Sided Original)

The automatic document feeder will automatically scan both sides of the document.

For example, a 2-sided original can be scanned, and its front and back sides can be sent as 2 pages.



- 2-sided scanning is not possible when direct transmission or speaker transmission is performed.
- You cannot use 2-sided scanning when the original size is set to Long Size.
- 2-sided scanning is not possible when "Settings (administrator)" - [System Settings] → [Common Settings] → [Device Control] → [Condition Settings] or [Enable/Disable Settings] → [Disabling of Document Feeder is enabled].



2-sided scanning automatically turns off after transmission has ended.

1

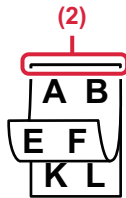

Tap the [Original] key, and tap the [Book] key or [Tablet] key.

See the figure on the left to check the binding edge of the original and select the key to be tapped.

- (1) Book
- (2) Tablet



In normal mode, tap the [2-Sided Booklet] key or [2-Sided Tablet] key.



2

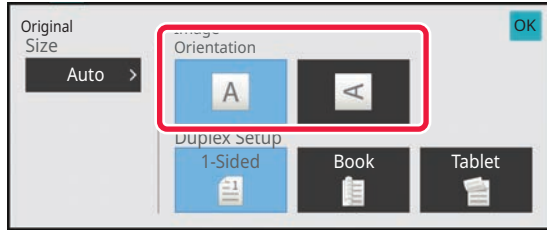

Tap the [Image Orientation] key with the same orientation as the placed original.

If this setting is not correct, a suitable image may not be transmitted.

After the settings are completed, tap **OK**.



To cancel 2-sided scanning:

Tap the [1-Sided] key.

In normal mode, tap the [2-Sided Booklet] key or the [2-Sided Tablet] key that has been forcibly displayed and cancel the display.

AUTO DETECTION

When the original is placed, its size is automatically detected.

In normal mode, the size of the placed original is shown as the "Scan Size" and the transmission size is shown as the "Send Size" in the initial screen.

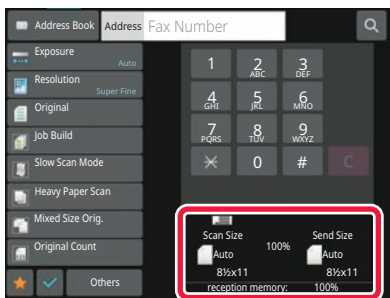

In the above screen, the scan size (the placed original) is 8-1/2" x 11" (A4) and the send size is auto. For example, if the scan size is 8-1/2" x 11" (A4) and the send size is 5-1/2" x 8-1/2" (B5), the image will be reduced before transmission.

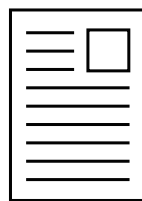

8-1/2" x 11" (A4)



5-1/2" x 2-1/2" (B5)



- Only standard original sizes can be automatically detected.

[NORMAL MODE \(page 3-5\)](#)

- When the original size is an inch size or a non-standard size, or if the size is not detected correctly, manually specify the original scan size.

[SPECIFYING THE ORIGINAL SCAN SIZE IN PAPER SIZE \(page 5-44\)](#)

[SPECIFYING THE ORIGINAL SCAN SIZE USING NUMERIC VALUES \(page 5-46\)](#)



SPECIFYING THE ORIGINAL SCAN SIZE IN PAPER SIZE

When the original size is not standard (inch size or non-standard size) or is not detected correctly, manually specify the original size.



When [Long Size] is selected, the 2-sided scanning setting and send size cannot be changed.
The image is sent in Mono2 only.

In Easy mode

1

Tap the [Original] key.

2

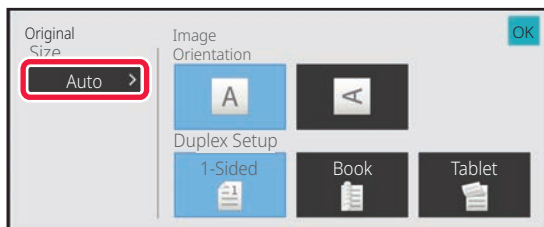

Tap the [Auto] key.

3



Tap a key of the desired original size.

After the settings are completed, tap **OK**



If you are sending a long original, perform the setting in normal mode.



In Normal mode

1

Tap the [Detail] key to change to normal mode.

[EASY MODE \(page 5-6\)](#)

2

Tap the [Original] key.

3

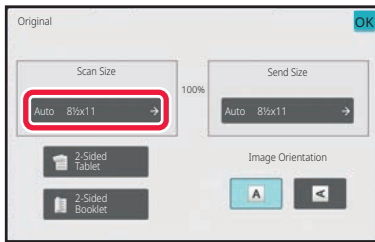

Tap the [Scan Size] key.

4

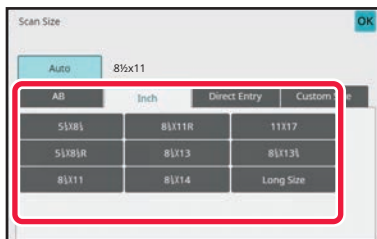

Tap the appropriate original size key.

After the settings are completed, tap **OK**.



If you are sending a long original, tap the [Long Size] key.

Use the automatic document feeder to scan a long original. The maximum width that can be scanned is 1,000 mm (39-3/8") (the maximum height is 297 mm (11-5/8")).

[TRANSMITTABLE ORIGINAL SIZES \(page 5-25\)](#)



SPECIFYING THE ORIGINAL SCAN SIZE USING NUMERIC VALUES

When scanning a non-standard size original such as a postcard, specify the original size by numeric values after placing the original. The width can be from 1" to 17" (25 mm to 432 mm), and the height can be from 1" to 11-5/8" (25 mm to 297 mm).



When the scan size is specified by numeric values, the send size cannot be specified.

In Easy mode

1

Tap the [Original] key.

2

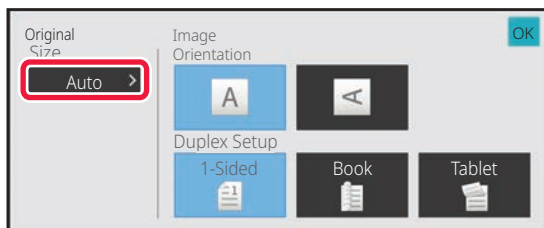

Tap the [Auto] key.

3



Tap the [Direct Entry] key.

4

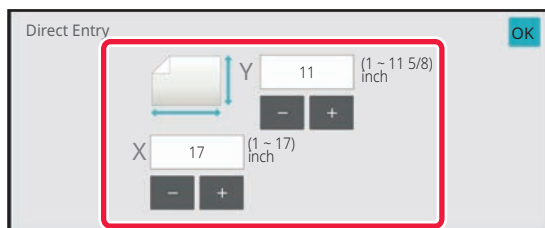

Specify the original size.



Tap the areas displaying width and height sizes respectively, and enter the sizes using the numeric keys. It is convenient to use ($-$ $+$) to finely adjust the entered size.

5

Tap **OK** twice.

On the base screen, check that the specified size is displayed on the [Original] key.



To cancel the specified size settings:

Tap the [Auto] key.



In Normal mode

1

Tap the [Detail] key to change to normal mode.

[EASY MODE \(page 5-6\)](#)

2

Tap the [Original] key.

3

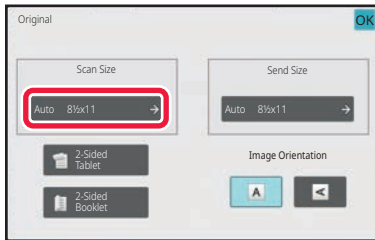

Tap the [Scan Size] key.

4

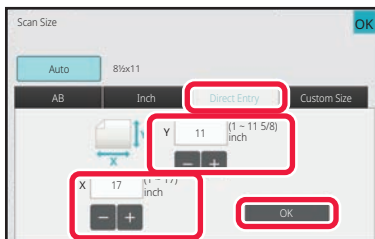

Tap the [Direct Entry] key, and enter the scan size.

- Tap the areas displaying width and height sizes respectively, and enter the sizes using the numeric keys.
- It is convenient to use **- +** to finely adjust the entered size.

5

Tap the [Execute] key.

After the settings are completed, tap **OK** twice.

On the base screen, check that the specified size is displayed on the [Original] key.



To cancel the specified size settings:

Tap the [Auto] key.



STORING FREQUENTLY USED ORIGINAL SIZES

Store the frequently used non-standard original sizes. This section explains how to store, retrieve, change, and delete non-standard original sizes.



- The stored original size will be retained even if the main power is turned off.
- A total of up to 12 non-standard original sizes can be registered for copying, fax, and image sending.
- The added original sizes will also appear in other modes.

Storing original sizes (Modify/Delete)

1

Tap the [Detail] key to change to normal mode.

[EASY MODE \(page 5-6\)](#)

2

Tap the [Original] key.

3

Tap the [Scan Size] key and tap the [Custom Size] tab.

4

Tap [Store/Delete] key.



5

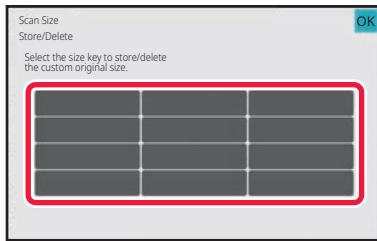

Tap a key () for storing a custom original size.

Tap a key that does not show a size.



To modify or delete a previously stored key:

- Tap the key that you want to modify or delete. The following screen will appear.
- To modify the key, tap the [Modify] key and go to the next step.
- To delete the key, tap the [Delete] key. Make sure that the original size has been cleared and tap the **OK** key.

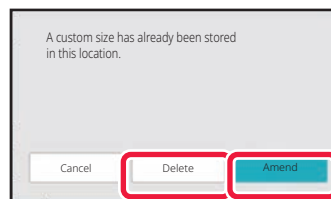

6

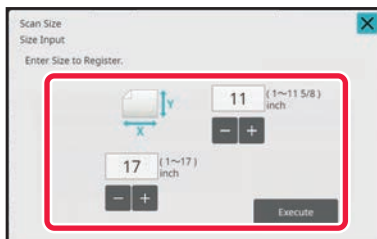

Specify the original size.

Tap the areas displaying width and height sizes respectively, and enter the sizes using the numeric keys.



It is convenient to use **- +** to finely adjust the entered size.

7

Tap the [Execute] key.

Tap the **OK** key, and check that the key of the size stored on the Scan Size screen is added properly. After you have checked it, tap **OK**.



To cancel the operation:

Tap the [CA] key.



Retrieving a stored original size
In Easy mode

1

Tap the [Original] key.

2

Tap the [Auto] key.

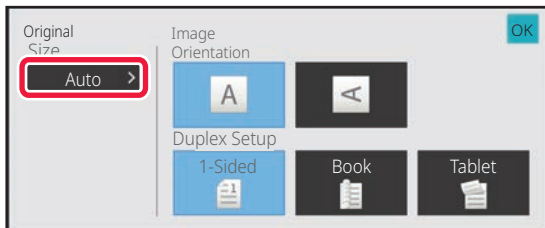

3

Tap the [Custom Size] key.

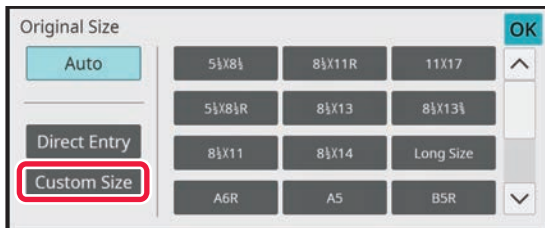

4

Tap the key of the original size that you wish to retrieve.

Tap **OK** twice.

On the base screen, check that the specified size is displayed on the [Original] key.

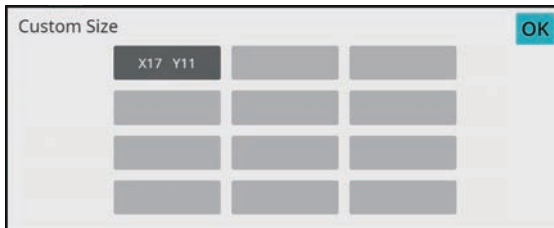

To cancel the operation
Tap the [CA] key.



In Normal mode

1

Tap the [Detail] key to change to normal mode.

[EASY MODE \(page 5-6\)](#)

2

Tap the [Original] key.

3

Tap the [Scan Size] key and tap the [Custom Size] tab.

4



Tap the key of the original size that you wish to retrieve.

After selecting the key of the original size, tap the **OK** key. Check that the specified size is displayed on the scan size screen.



To cancel the operation

Tap the [CA] key.



SPECIFYING THE SEND SIZE OF THE IMAGE

Tap this key to specify the send size as a paper size. If the specified send size is larger than the scan size, the image will be enlarged. If the specified send size is smaller than the scan size, the image will be reduced.



The send size cannot be specified when [Long Size] is selected for the scan size, or when the scan size is specified by numeric values.

1

Tap the [Detail] key to change to normal mode.

[EASY MODE \(page 5-6\)](#)

2

Tap the [Original] key.

3

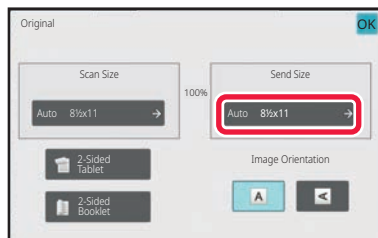

Tap the [Send Size] key.

4

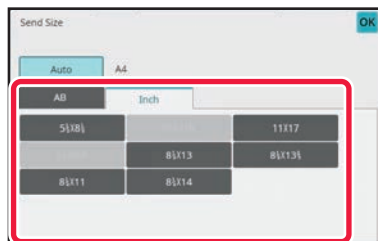

Tap the desired send size key.

After the settings are completed, tap **OK**.



Depending on the paper size specified for the "Scan Size", it may not be possible to select some sizes for the "Send Size". You cannot tap size keys that are unavailable for the "Send Size".



5

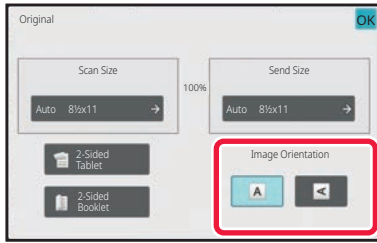

Tap the [Image Orientation] key with the same orientation as the placed original.

If this setting is not correct, a suitable image may not be transmitted.

After the settings are completed, tap **OK**.



To configure the default setting of image orientation:

Select [System Settings] → [Image Send Settings] → [Common Settings] → [Condition Settings] → [Image Orientation] in "Settings (administrator)".



The ratio used for reduction or enlargement of the original will appear between the "Scan Size" and the "Send Size".



CHANGING THE EXPOSURE

The exposure can be changed to suit the darkness of the original.



When using the automatic document feeder, the exposure setting cannot be changed once scanning has begun. (However, when "Job Build" or "Preview Setting" in "Others" is used, the exposure can be changed each time a new set of originals is inserted.)

Exposure settings

Exposure		Suggestion
Auto		This setting automatically adjusts the exposure for light and dark parts of the original.
Manual	1-2	Select this setting when the original consists of dark text.
	3	Select this setting for a normal original (neither dark nor light).
	4-5	Select this setting when the original consists of light text.

1

After tapping the [Exposure] key, tap the [Manual] key.

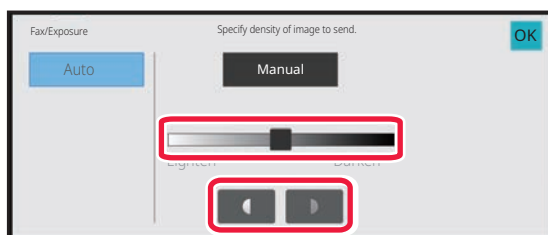
2

Adjust the exposure with the slider or



After the adjustment, tap **OK**.



When [Auto] is selected, the exposure will be set to "3".



CHANGING THE RESOLUTION

The resolution can be specified to match the characteristics of the original, such as text or photo, the size of the text, and the darkness of the image.

Resolution settings

Resolution	Suggestion
Standard	Select this setting when your original consists of normal-sized text (like the text in this manual).
Fine	Select this setting when your original has small text or diagrams with fine lines. The original will be scanned at twice the resolution of the [Standard] setting.
Super Fine	Select this setting when your original has intricate pictures or diagrams. A higher-quality image will be produced than with the [Fine] setting.
Ultra Fine	Select this setting when your original has intricate pictures or diagrams. This setting gives the best image quality. However, transmission will take longer than with the other settings.
Half Tone	Select this setting when your original is a photograph or has gradations of color (such as a color original). This setting will produce a clearer image than [Fine], [Super Fine], or [Ultra Fine] used alone. Halftone cannot be selected when [Standard] is used.

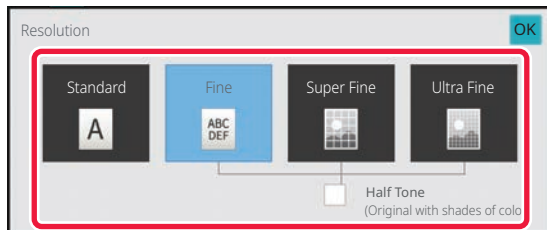

- When using the automatic document feeder, the resolution setting cannot be changed once scanning has begun. (However, when "Job Build" or "Preview Setting" in "Others" is used, the resolution can be changed each time a new set of originals is inserted.)
- When a fax is sent at [Ultra Fine], [Super Fine], or [Fine] resolution, a lower resolution will be used if the receiving machine does not have that resolution.

1**Tap the [Resolution] key.****2****Tap the key of the desired resolution.**

When your original is a photograph or has gradations of color (such as a color original), and you wish to produce a clearer image than [Fine], [Super Fine], or [Ultra Fine] used alone, set the [Half Tone] checkbox to . Halftone cannot be selected when [Standard] is used. After the settings are completed, tap **OK**.



FAX RECEPTION

RECEIVING A FAX



This section explains how to enter a destination from the initial screen of easy mode.

[EASY MODE \(page 5-6\)](#)

RECEIVING A FAX AUTOMATICALLY

When the reception mode is set to "Auto Reception", the machine will receive and print faxes automatically.



- When fax reception is in progress, it is possible to reserve a transmission by performing the transmission in memory transmission mode.
[FAX TRANSMISSION METHODS \(page 5-22\)](#)
- The information indicator blinks in white from the start of fax reception until printing is completed.
- To print received faxes, make sure that the required paper is loaded into the machine's paper trays. It is not necessary to load 8-1/2" x 11" (A4) paper and 5-1/2" x 8-1/2" (B5) paper in both the vertical () and horizontal () orientations. Differences in orientation are automatically adjusted when faxes are received. When a fax smaller than 8-1/2" x 11" (A4) size is received, the size of the paper used for printing will vary depending on the orientation (vertical or horizontal) in which the sender placed the original.
- If a print job such as the copy or printer function has already been executed when printing the received data, the first reserved job is printed before the received data.
- Received faxes will not be printed when the machine cannot print due to an error condition such as out of paper, out of toner, or a paper misfeed. The faxes will be printed automatically when the error condition is cleared. (If the paper has run out, add paper and tap **OK** on the touch panel.)
- You can check current fax reception mode in the system area at the top of the screen.



- **To switch between auto reception and manual reception modes:**
Select [System Settings] in "Settings (administrator)" → [Image Send Settings] → [Fax Data Receive/Forward (Manual)] → [Fax Settings] → [Receive Settings].
- **Distinctive Ring Detection**
If multiple telephone numbers have been assigned to your telephone line, the number called can be identified by its ringing pattern. By using one number for voice calls and another number for faxes, you can tell which type of call you are receiving by the ringing pattern. You can set your machine to automatically receive faxes when your fax number is called by setting the pattern that corresponds to your fax number.
In "Settings (administrator)", select [System Settings] → [Image Send Settings] → [Fax Settings] → [Default Settings] → [Distinctive Ring Detection].

1

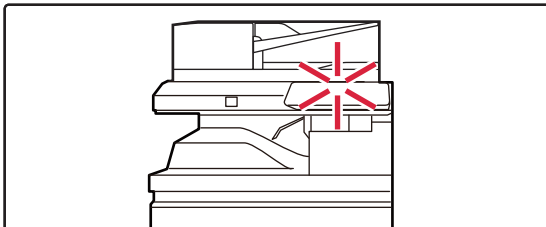

The machine rings and fax reception begins automatically.

When reception begins, the information indicator blinks in white.

A beep sounds when reception ends.



2

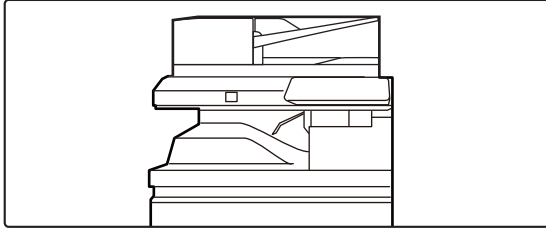

The faxes are printed automatically.

When printing ends, the Information indicator turns off.



If a PIN Code entry screen appears:

A PIN Code is registered to print the received fax data. When the correct PIN Code is entered, the received fax is printed.

[PRINTING A PIN CODE-PROTECTED FAX \(Hold setting for received data print\) \(page 5-59\)](#)

How to check the fax reception mode

You can check current fax reception mode in the system area at the top of the screen.

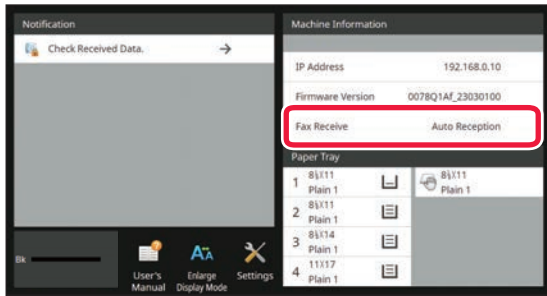



RECEIVING A FAX MANUALLY

A fax can be received manually using the touch panel (manually).



- When answering the telephone by tapping the [Speaker] key, you will be able to hear the voice of the caller, but you will not be able to speak.
- You can receive a fax after answering a call on an external telephone. Remote reception can also be used to receive a fax. [RECEIVING A FAX AFTER ANSWERING A CALL ON THE EXTERNAL TELEPHONE \(REMOTE RECEPTION\)](#) (page 5-103)



To switch between auto reception and manual reception modes:

Select [System Settings] in "Settings (administrator)" → [Image Send Settings] → [Fax Data Receive/Forward (Manual)] → [Fax Settings] → [Receive Settings].

1

When the machine rings, tap the [Detail] key to change to normal mode, and tap the [Speaker] key.

When the [Speaker] key is tapped, the [Receive] and appears.

[EASY MODE](#) (page 5-6)



- To adjust the speaker volume, tap the key and adjust with the slider or keys.
- If the received fax data remains unprinted, it will cause the fax memory to fill up, which may prevent some faxes from being received. When using this function, you should print the received data as soon as possible without leaving it in the fax memory.

You can view the remaining fax memory capacity on the fax mode base screen.

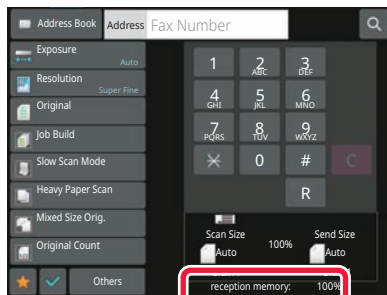

2

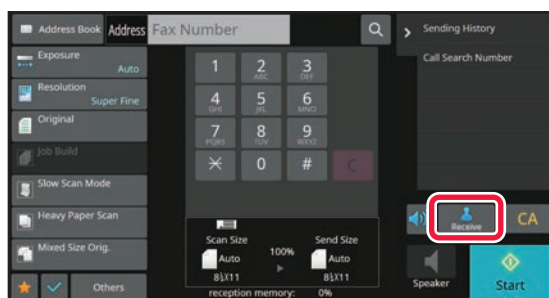

Tap the [Receive] key to receive a fax.

When printing ends, the Information indicator turns off.



PRINTING RECEIVED DATA

PRINTING A PIN CODE-PROTECTED FAX (Hold setting for received data print)

Enable this setting to have faxes received and stored in memory without being printed. To print the faxes, a PIN Code must be entered. When this function is used, a PIN Code entry screen appears in the touch panel when a fax is received.

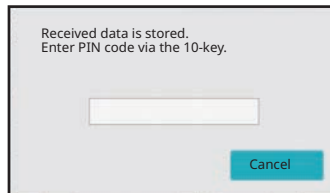

- **To enable the hold setting for received data print:**

In "Settings (administrator)", select [System Settings] → [Image Send Settings] → [Common Settings] → [Condition Settings] → [Hold Setting for Received Data Print].

These settings can only be configured when there is no received data in the machine memory (excluding data in a confidential or relay broadcast memory box).

- **Disable Switching of Display Order**

In "Settings (administrator)", select [System Settings] → [Image Send Settings] → [Common Settings] → [Condition Settings] → [Disable Switching of Display Order].

Disables to change the order of display (search number order, ascending, descending).

Once set, the display sequence is not changed. The display order will remain fixed at the order that is in effect when this setting is enabled.

Important points when using this function

If the received fax data is not printed or deleted, the fax memory will run low, and the machine will not be able to receive any faxes. When using this function, you should print the received data as soon as possible without leaving it in the fax memory.

You can view the remaining fax memory capacity on the fax mode base screen.

When little space remains in the fax memory, "Manual receive is disabled. Due to out of memory." appears on the touch panel.



- The received faxes will be stored in memory regardless of whether they are received automatically or manually.

- When the received data is transferred to other machine, data stored in memory is also transferred. At that time, the same PIN Code entry screen will appear as for printing. Forwarding will not take place unless the PIN Code is entered.



You can check the received data image on the touch panel before printing.

[CHECKING THE IMAGE BEFORE PRINTING \(page 5-61\)](#)

When the previously programmed 4-digit PIN Code is entered using the numeric keys, printing begins.

When the [Cancel] key is tapped, the PIN Code entry screen closes. It will reappear when you tap  or change modes.

The data in memory key will blink in the touch panel.



- **To display the received data list screen after entering the PIN Code:**

In "Settings (administrator)", select [System Settings] → [Image Send Settings] → [Common Settings] → [Condition Settings] → [Preview Setting] → [Received Data Image Check Setting].

- **To transfer received data to another machine:**

In "Settings (administrator)", select [System Settings] → [Image Send Settings] → [Inbound Routing (Forwarding/Storing Settings)].



PRINTING RECEIVED DATA AT A SPECIFIED TIME

You can start printing the received data at a specified time.

For stress-free printing, you should avoid printing large numbers of pages at peak times during the day, and when you do not urgently need to print.

For example, if it is set to print data received during the day at 20:00, the received data will not be printed immediately, and printing will begin automatically at 20:00.

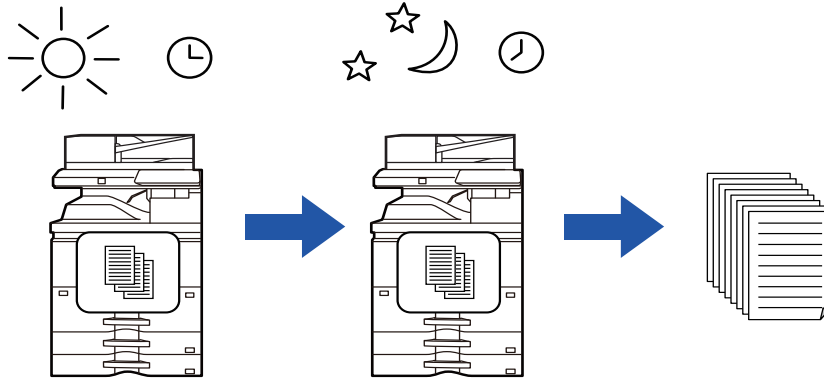

- The printed data is automatically deleted from memory.
- If the power is turned off at the specified time, printing will start at the timing when the power is turned on.
- This function can be used when "Settings (administrator)" - [System Settings] → [Image Send Settings] → [Common Settings] → [Condition Settings] → [Preview Setting] → [Received Data Image Check Setting] is enabled.



If Hold Setting for Received Data Print is enabled, this function is not available.



- **To print received data at the specified time:**

In "Settings", select [System Settings] → [Image Send Settings] → [Common Settings] → [Condition Settings] → [Time Specified Output of Received Data].

When "Change Password" or "Hold Setting for Received Data print" is , the password entry field is grayed out.

- **To disable the hold setting for received data print:**

In "Settings (administrator)", disable this function using [System Settings] → [Image Send Settings] → [Common Settings] → [Condition Settings] → [Hold Setting for Received Data Print].



CHECKING THE IMAGE BEFORE PRINTING

Check the image of received data on the touch panel before printing.

This function can be used when "Settings (administrator)" - [System Settings] → [Image Send Settings] → [Common Settings] → [Condition Settings] → [Preview Setting] → [Received Data Image Check Setting] is enabled*.

* The factory default setting is disabled.

Important points when using this function

If the received fax data is not printed or deleted, the fax memory will run low, and the machine will not be able to receive any faxes. When using this function, you should print the received data as soon as possible without leaving it in the fax memory.

You can view the remaining fax memory capacity on the fax mode base screen.

When data is received,  is shown at the top of the screen.

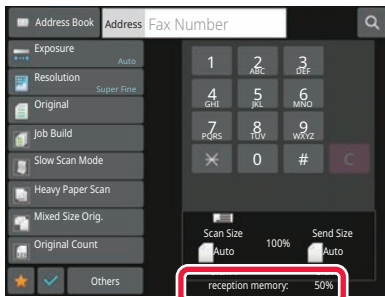

Depending on the size of the received data, part of the check image on the touch panel may not appear.

The received data list can be also shown in the job status screen that appears when you tap the job status display.

The received data can be forwarded, deleted, or saved from the received data list.

[FORWARDING RECEIVED DATA MANUALLY \(page 5-70\)](#)

[SAVING RECEIVED DATA \(page 5-72\)](#)

1

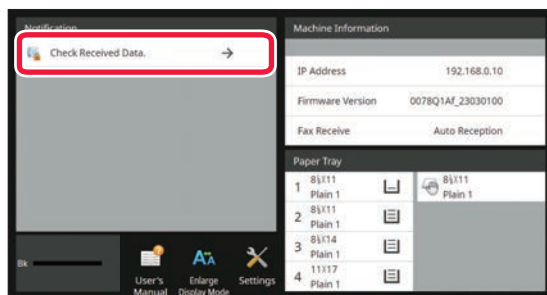

In the System Information, tap the [Check Received Data.].

The received data is listed.



You can also display the received data list by tapping the job status display and tapping [Check Received Data] on the action panel of Job Status screen.



2

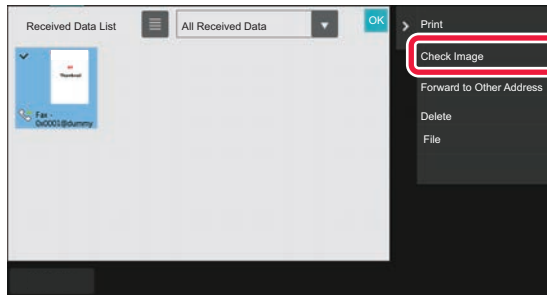

Tap the key of the received data you wish to check, and tap [Check Image] on the action panel.

Displays the received data image.



- Tap to show a list of received data. The list view or thumbnails view can be changed depending on the setting mode.
- To delete a received image, tap [Delete] on the action panel.
- To transfer the selected received image, tap [Forward to Other Address] on the action panel.
[FORWARDING RECEIVED DATA MANUALLY \(page 5-70\)](#)
- To save the selected received image, tap [File] on the action panel.
[SAVING RECEIVED DATA \(page 5-72\)](#)
- To store the sender fax number as a number for "Allow/Reject Number Setting", tap [Register as Junk Fax] on the action panel and, in the confirmation message screen, tap the [OK] key.
Specify a sender fax number as a number for "Allow/Reject Number Setting" by selecting, in "Settings (administrator)", select [System Settings] → [Image Send Settings] → [Fax Settings] → [Receive Settings] → [Allow/Reject Number Setting].

3



Tap the image you wish to print, and tap the [Print] on the action panel.

The machine starts printing the image.

- [Select All Page]: Selects all displayed images.
- [Release All Page]: Cancels all images that have been selected by "Select All Page".
- : Use these keys to enlarge or reduce an image.
- : Rotates image counterclockwise or clockwise.



- A preview image is an image for the touch panel. It will differ from the actual print result.
- Tap [Erase Specified Range] on the action panel to delete unwanted area of the image. Specify the image area you wish to delete in the Erase Specified Range screen.
- To forward the selected image, tap [Forward to Other Address] on the action panel.
[FORWARDING RECEIVED DATA MANUALLY \(page 5-70\)](#)
- To save the selected received image, tap [File] on the action panel.
[SAVING RECEIVED DATA \(page 5-72\)](#)



FORWARDING RECEIVED DATA

This section explains how to enter a destination from the initial screen of easy mode.

[EASY MODE \(page 5-6\)](#)

FORWARDING RECEIVED FAXES (FAX DATA FORWARD)

When the machine cannot print because it is out of paper or out of toner, received faxes can be forwarded to another previously stored fax machine. Store a recipient by selecting [\[Send Setting \(page 10-94\)\]](#) in Setting mode.

If the machine has received data, the information indicator blinks in white.

This function is convenient in an office or work area that has two or more telephone lines and another fax machine is connected to a different line than the machine.

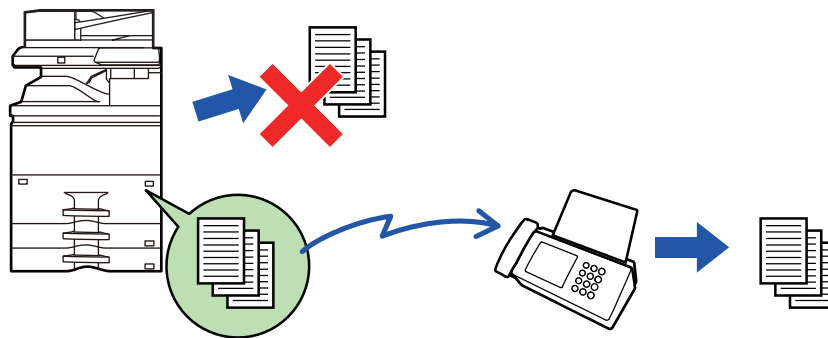

- If some pages of a fax that is being forwarded were successfully printed, only those pages that were not printed will be forwarded.
- A forwarded fax becomes a fax transmission job. If transmission does not take place because the transmission was canceled or an error occurred, the fax will be held in memory until it can be printed.
- All faxes received are forwarded. Note, however, that faxes received and stored in an F-code confidential memory box cannot be forwarded.
- If a PIN Code entry screen appears after tapping the [OK] key, "Hold Setting for Received Data Print" has been enabled. Enter the PIN Code using the numeric keys to begin forwarding.

[PRINTING A PIN CODE-PROTECTED FAX \(Hold setting for received data print\) \(page 5-59\)](#)

1

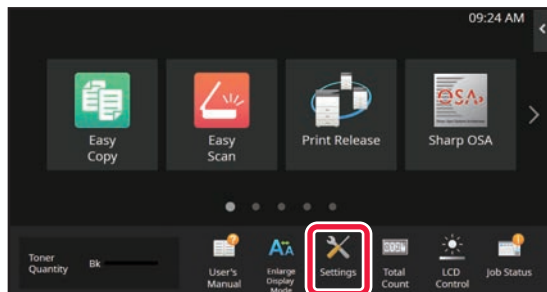

Make sure that the information indicator is blinking in white, and tap the [Settings] key in the home screen.

2

Tap the [System Settings] → [Image Send Settings] → [Fax Data Receive/Forward (Manual)] key.



3

Tap the [Execute] key in [Forward Received Data] to begin forwarding.



If a PIN Code entry screen appears, the "Hold Setting for Received Data Print" has been enabled. Enter the PIN Code using the numeric keys to begin forwarding.

[PRINTING A PIN CODE-PROTECTED FAX \(Hold setting for received data print\) \(page 5-59\)](#)



FORWARDING RECEIVED DATA TO PRESET DESTINATIONS (INBOUND ROUTING SETTINGS)

You can have received faxes automatically forwarded to a fax address, Internet fax address, e-mail address, file server address, desktop address, or network folder address. Received data can be forwarded to the specified destinations without being printed.

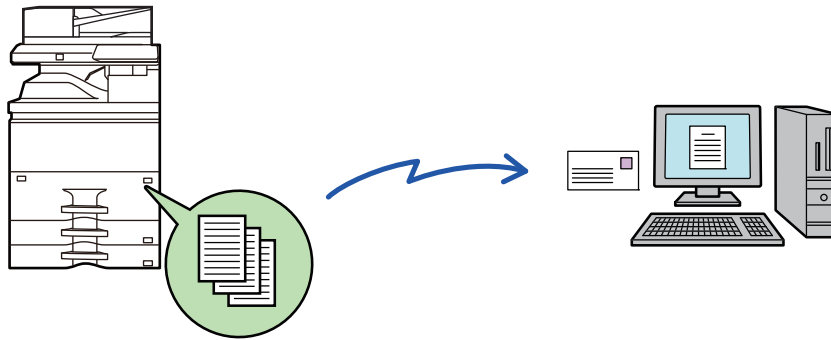

Configure all forwarding settings for received faxes in setting mode (Web version). For the procedure for accessing the setting mode (Web version), see Quick Start Manual.

The following explanation assumes that the setting mode (Web version) has been accessed with administrator rights.



Whether or not to forward data for each forwarding table can be quickly set.

- In "Settings (administrator)" - [System Settings] → [Image Send Settings] → [Inbound Routing (Forwarding/Storing) Settings] → [Administration Settings] → [Inbound Routing], tap [Enable]/[Disable] for each forwarding table that appears.



- This function cannot be used for faxes received by confidential reception.
- When faxes forwarded using this function are printed at the forwarding destination, the date and time of reception cannot be printed on the faxes. ("Receiving Date & Time Print" is disabled.)
- The received data is not forwarded to a hyperlink destination that is registered in the specified address.
- A direct SMTP address cannot be specified as a forwarding destination.

1

In "Settings (Web version)", click [System Settings] → [Image Send Settings] → [Inbound Routing (Forwarding/Storing) Settings] → [Administration Settings].

2

In "Inbound Routing", select [Enable] and click the [Submit] button.



- Users without administrator rights can be prohibited from storing, editing, and deleting forwarding tables in this screen, and from specifying which table is used. To do so, set the checkboxes for the following items to .
- Disable Registration of Forward Table
- Disable Change/Delete of Forward Table
- Disabling of Forward Condition Change
Specify in [Print Style Setting] whether or not to have the machine to print the faxes to forward when inbound routing is enabled. After the settings are completed, be sure to click the [Submit] button.
- [Always Print]: Always prints received data before forwarding the data.
- [Print at Error]: Prints received data only when an error prevents forwarding.
- [Save Only at Error]: Saves received data only when an error prevents forwarding. For the saved data, the error address can be confirmed and the data can be resent. From the [Scan] or [Fax] tab in the job status screen, tap [Check Error Box] on the action panel.

3

Click [Sender Address Registration] in the [Inbound Routing (Forwarding/Storing) Settings] menu in the "Settings (Web version)".

4

Enter the sender address or fax number in "Internet Fax Address" or "Fax Number" as appropriate, and click the [Add to List] button.

The entered address will be added to the "Address to be Entered" list. Enter the address directly (maximum of 1500 characters) or select the address from a global address book by clicking the [Global Address Search] button. To store multiple sender addresses or fax numbers, repeat these steps.



- If you wish to have only faxes from specified addresses forwarded, store the desired sender addresses. Send addresses stored here can be selected from a list when you store a forwarding table.
- A maximum of 500 sender numbers/addresses can be stored.
- To delete an entered address, select the address in "Address to be Entered" and click the [Delete] button.

5

When you have finished adding addresses, click the [Submit] button.

6

Click [Inbound Routing Settings] in the [Inbound Routing (Forwarding/Storing) Settings] in the "Settings (Web version)" menu and click the [Add] button.

7

Enter a "Table Name".

8

Select the sender whose faxes will be forwarded.

- To forward all received data, select [Forward All Received Data].
- To forward only data received from specific senders, select [Forward received data from specified senders only.]. To forward all data except data from specific senders, select [Forward all received data except that from specified senders.]. Then, select the appropriate senders from the list and click the [Add] button.



- When selecting senders from the "Sender Address Setting" list, you can use the [Shift] key or the [Ctrl] key on your keyboard to select multiple senders.

9

Select the forwarding conditions.

- To always forward received data, select [Always Forward].
- To specify a day and time on which received data will be forwarded, select [Forward received data only on specified days.] and select the checkbox (✓) of the desired day of the week. To specify a time, select the [Set Forwarding Time] checkbox (✓) and specify the time.



Up to three forwarding day and time settings can be set for one forwarding table, and a forwarding destination can be set for each set time. To configure these settings, use the [Forward Condition] tabs to access each setting.

10

Select the file format.

The format can be set separately for each forwarding address (for each of forwarding addresses 1, 2, and 3 in the table).



- Images forwarded in TIFF format may not be displayed correctly in some recipient environments. In this event, change the file format to PDF.
- If the Internet fax address is selected as a recipient, data is forwarded in TIFF regardless of the specified format.
- If a fax number is selected as a recipient, the file format is ignored.

11

Select the recipient from the address book.

You can specify multiple registered addresses or telephone numbers from the address book of the machine.

Up to 1,000 recipients can be registered for Recipients 1, 2, and 3 in total.

When you select the recipients from the address book, up to 1,000 recipients can be registered for e-mail and up to 400 recipients can be registered for network folder, FTP/Desktop, Internet fax, and fax.



A direct SMTP address cannot be specified as a forwarding destination.

12

Enter a recipient directly and specify the recipient.

- Specify this information if necessary.
- Enter an e-mail address, an Internet fax address, a direct SMTP address, or a fax number directly and tap the [Add] key.
- When you specify an e-mail address or a fax number, you can use the global address search.
- When you specify a fax number, also specify the international correspondence mode.
- When enter the recipients directly, up to 100 recipients can be registered for e-mail address, network folder, FTP/Desktop, Internet fax, and fax.

13

Click [Submit].



14 Click **[Inbound Routing Settings]** in the **[Inbound Routing (Forwarding/Storing) Settings]** in "Settings (Web version)".

15 From the forwarding table, select **[Forward to All Forward Destinations]** or **[Forward based on Forward Condition]**.

16 From the forwarding table, select **[Always Forward]** or **[Forward received data only on specified days.]**.

The forwarding permission settings that appear here are linked to the forwarding conditions set in step 10.

If you wish to use different forwarding conditions than those set in step 10, set the forwarding permission settings.



- To use the inbound routing function, enable the forwarding tables that you wish to use from among the stored tables.
- To delete a forwarding table, click the checkbox next to the table name so that it is selected () and click **[Delete]**.

17 Click **[Submit]**.



SAVING RECEIVED FAXES TO THE MACHINE'S STORAGE (INBOUND ROUTING)

Received faxes can be saved to the machine's storage. Saved faxes can be viewed on a computer.

Set PDF, TIFF (multi) or TIFF (single) for the saved Internet faxes.

You can also receive notification of the storage result or storage folder by E-mail.

Received faxes are saved in the following directory:

\\MFP\faxreceive

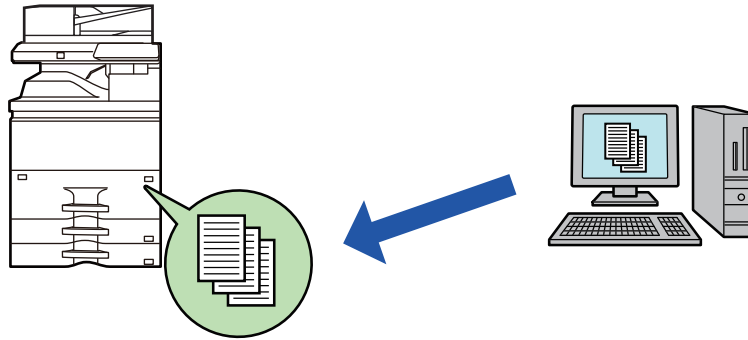

- Up to 500 files can be stored in one folder as received data.
- The "faxreceive" folder contains files of "Settings for Local Drive Storing of Received Data".
- The folder is automatically created.
- The file name for received data can be set in "File Name Setting" in "Settings for Local Drive Storing of Received Data" in "Inbound Routing (Storage) Settings".

How to save received faxes to the storage

1 In "Settings (administrator)", click [System Settings] → [Network Settings] → [Public Folder / NAS Setting]. (Administrator rights required.)

2 Select [Allowed] in "faxreceive:Use of Storage" and click the [Submit] button.



Settings for saving received faxes to the storage

- 1 In "Settings (administrator)", click [System Settings] → [Image Send Settings] → [Inbound Routing (Forwarding/Storing) Settings] → [Inbound Routing (Storage) Settings] (administrator rights are required).



- Data that can be saved are received faxes and received Internet faxes. Confidential reception and polling reception faxes cannot be saved.
- Depending on the setting, received faxes that cannot be saved because of the file number limit or other reason are either printed or saved in the inbound routing error box.

FORWARDING RECEIVED DATA MANUALLY

Received faxes can be forwarded manually after receipt.

This function is available when [System Settings] → [Image Send Settings] → [Common Settings] → [Condition Settings] → [Preview Setting] → [Received Data Image Check Setting] is enabled* in "Settings (administrator)".

* The factory default setting is disabled.

When data is received,  is shown at the top of the screen.

- 1

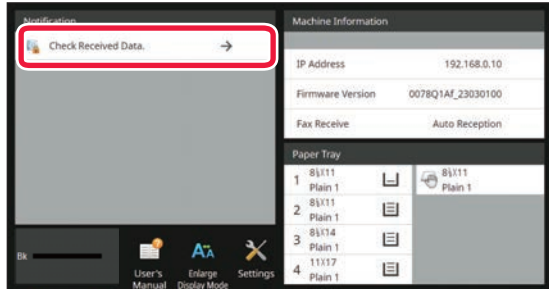

In the System Information, tap the [Check Received Data].

The received data is listed.



You can also display the received data list by tapping the job status display and tapping [Check Received Data] on the action panel of Job Status screen.



2

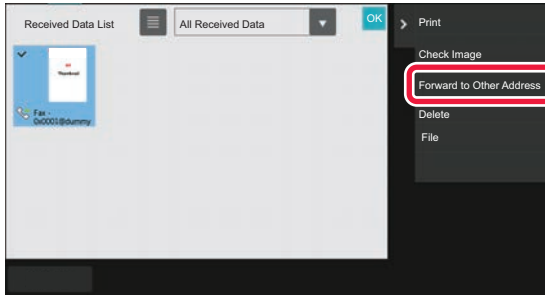

Tap the key of the received data you wish to forward, and tap [Forward to Other Address].

- Tap  to show a list of received data. The list view or thumbnails view can be changed depending on the setting mode.
- Multiple sets of received data can be selected.



- When you select a single received data only, you can tap [Check Image] on the action panel and check the image on the preview screen.
- To store the sender fax number as a number for "Allow/Reject Number Setting", tap [Register as Junk Fax] on the action panel and, in the confirmation message screen, tap the [Store] key.
- Specify a sender fax number as a number for "Allow/Reject Number Setting" by selecting, in "Settings (administrator)", select [System Settings] → [Image Send Settings] → [Fax Settings] → [Receive Settings] → [Allow/Reject Number Setting].

3

Select the destination from the Address Book screen, and tap the [Start] key.





SAVING RECEIVED DATA

You can save received faxes in the document filing folder.

This function is available when [System Settings] → [Image Send Settings] → [Common Settings] → [Condition Settings] → [Preview Setting] → [Received Data Image Check Setting] is enabled* in "Settings (administrator)".

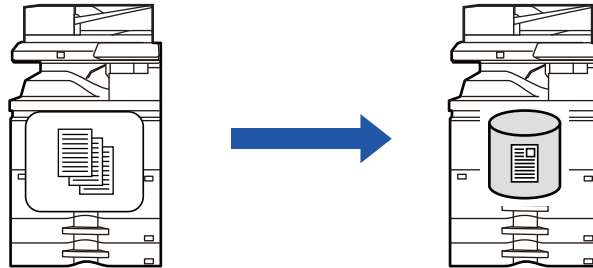
* The factory default setting is disabled.



When data is received,  is shown at the top of the screen.

1

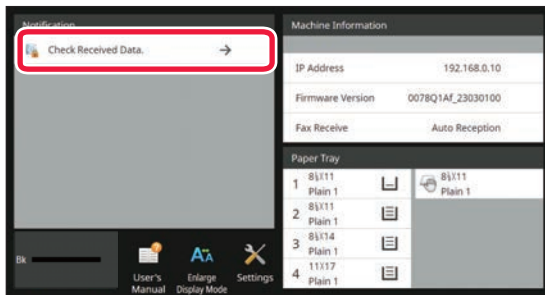

In the System Information, tap the [Check Received Data].

The received data is listed.



You can also display the received data list by tapping the job status display and tapping [Check Received Data] on the action panel of Job Status screen.

2

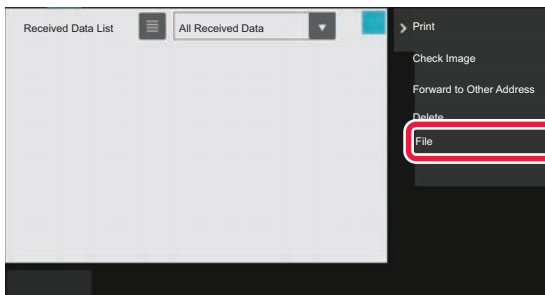

Tap the key of the received data you wish to save, and tap [File] on the action panel.

- Tap  to show a list of received data. The list view or thumbnails view can be changed depending on the setting mode.
- Multiple sets of received data can be selected.



- When you select a single received data only, you can tap [Check Image] on the action panel and check the image on the preview screen.
- To store the sender fax number as a number for "Allow/Reject Number Setting", tap [Register as Junk Fax] on the action panel and, in the confirmation message screen, tap the [Store] key. Specify a sender fax number as a number for "Allow/Reject Number Setting" by selecting, in "Settings (administrator)", select [System Settings] → [Image Send Settings] → [Fax Settings] → [Receive Settings] → [Allow/Reject Number Setting].

3

Set the file information, and tap the [Save] key.



OTHERS FUNCTIONS

COMMON FUNCTIONS

The following functionality is the same as scanner functionality.

For detailed explanations, see the explanation in the scanner/internet fax chapter.

N-Up Printing:	"SENDING TWO PAGES AS A SINGLE PAGE (N-Up) (page 6-97)"
Card Shot:	"SCANNING BOTH SIDES OF A CARD ONTO A SINGLE PAGE (CARD SHOT) (page 6-101)"
Job Build:	"SCANNING MANY ORIGINALS AT ONCE (JOB BUILD) (page 6-113)"
Mixed Size Original:	"SCANNING ORIGINALS OF DIFFERENT SIZES (MIXED SIZE ORIGINAL) (page 6-99)"
Dual Page Scan:	"SCANNING AN ORIGINAL AS TWO SEPARATE PAGES (DUAL PAGE SCAN) (page 6-116)"
Book Divide:	"SPLITTING A PAMPHLET BY PAGE AND TRANSMITTING THE PAGES SUCCESSIVELY (BOOK DIVIDE) (page 6-119)"
Erase:	"ERASING PERIPHERAL SHADOWS ON THE IMAGE (ERASE) (page 6-131)"
Slow Scan Mode:	"SCANNING A THIN ORIGINAL (SLOW SCAN MODE) (page 6-134)"
Heavy Paper Scan:	"SCANNING A HEAVY ORIGINAL (HEAVY PAPER SCAN) (page 6-136)"
Original Count:	"CHECKING THE NUMBER OF SCANNED ORIGINAL SHEETS BEFORE TRANSMISSION (ORIGINAL COUNT) (page 6-140)"
Timer:	"STARTING A TRANSMISSION AT A SPECIFIED TIME (TIMER TRANSMISSION) (page 6-147)"



STORING FAX OPERATIONS (PROGRAM)

This function collectively stores various settings as one program. The stored program can be retrieved using an easy operation.

For example, suppose that the same 8-1/2" x 11" (A4) size documents are distributed to branch offices in various regions once a month.

- (1) The same documents are faxed to each branch office
- (2) To save paper, two document pages are faxed as a single page
- (3) Smudges on the edges of the documents are erased before transmission

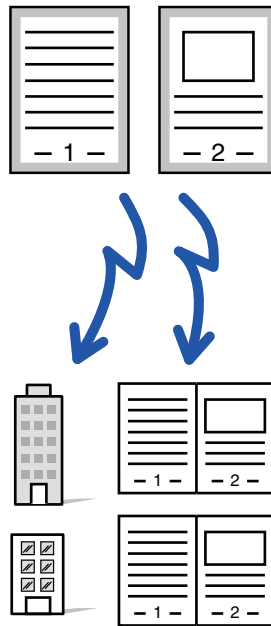

When a job program is not stored	When a job program is stored
Enter the fax number for each branch. ↓ Specify N-Up. ↓ Specify Erase. ↓ Tap the [Start] key. Scan and send the original.	Call the registered program. ↓ Tap the [Start] key. Scan and send the original.
Considerable time is required to send the documents each month because the above settings must be selected. In addition, mistakes are occasionally made when selecting the settings.	When a program is stored, settings are selected with ease by simply tapping the key of the program. In addition, transmission takes place according to the stored settings so there are no chances for mistakes.



- **To configure a program:**

Tap [Program Registration] that appears on the action panel when you operate any mode screens.

- **Prohibit registration of programs / prohibit deleting of registered programs:**

In "Settings (administrator)", select [System Settings] → [Image Send Settings] → [Common Settings] → [Enable/Disable Settings] → [Settings to Disable Transmission] → [Disable Registration/Delection of All Program Items].



- The settings stored in a program will be retained even after the program is used for transmission. The same settings can be used repeatedly for transmission.
- The following contents cannot be stored in programs:
 - Tapping the [Speaker] key, Quick File, File, page move and unspecified erase during preview, Metadata Entry, Send Settings, and Own Name Select.
- Up to 48 programs can be stored.
- Up to 500 destinations can be stored in one program.
- A program in which sub addresses and passcodes are specified as an F-code destination records all sub addresses and passcodes.

This section explains how to enter a destination from the initial screen of normal mode.

[EASY MODE \(page 5-6\)](#)

1

Place the original.

According to the function stored in the program, place the original in the document feeder tray of the automatic document feeder, or on the document glass.

[AUTOMATIC DOCUMENT FEEDER \(page 1-34\)](#)

[DOCUMENT GLASS \(page 1-38\)](#)

2

Tap [Call Program] on the action panel.

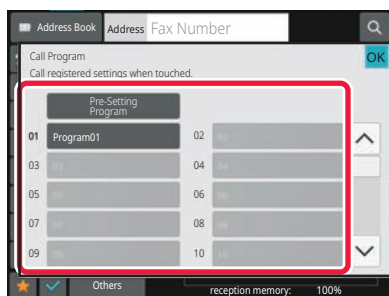
3

Tap the desired program key.

4

Configure additional settings as required.



Some settings cannot be added depending on the contents of the called program.

5

Tap the [Start] key to start scanning of the original.

If you inserted the original pages in the document feeder tray, all pages are scanned.

When you place the original on the document glass, scan each page one at a time.

After you have scanned the last original, tap the [Read-End] key.

A beep will sound to indicate that scanning and transmission have ended.



- You can tap the [Preview] key to check a preview of the image before sending a fax.
- For more information, see "[FAX TRANSMISSION METHODS \(page 5-29\)](#)".



OPERATING FAX TRANSMISSION AND RECEPTION REMOTELY

This section explains how to enter a destination from the initial screen of normal mode.

[EASY MODE \(page 5-6\)](#)

CALLING A FAX MACHINE AND INITIATING RECEPTION (POLLING)

When you connect to another machine and receive a document from it, this is called "Polling".

The document reception from another machine is called "Polling Reception".

You can enter multiple destination numbers. When you enter multiple destination numbers, the document is received by polling in the sequence you have entered the destination numbers.

Document reception by polling from multiple machines is called "Serial Polling".

Use the manual polling reception when you must start polling after listening to a recorded greeting, such as when using a fax information service.

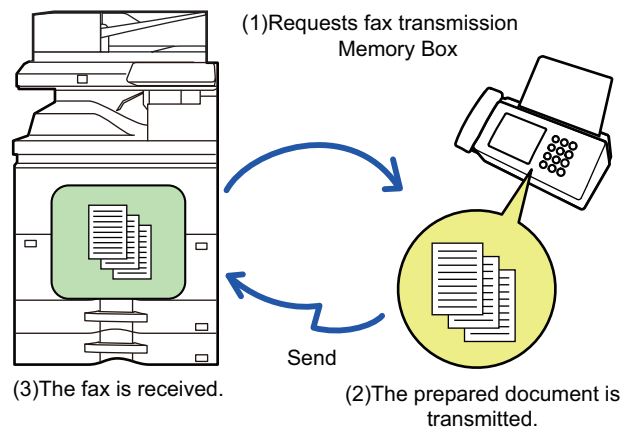

- Make sure there is no original in the machine when using the polling reception function.
- The function can only be used when the other machine is Super G3 or G3 compatible and has a polling function.
- The receiving machine bears the expense (phone charges) of the polling reception.
- If necessary, this function can be combined with the timer transmission to perform the polling reception at any time such as at night or when you are not present. (Only one timer polling reception can be set.)



1

Enter the destination fax number.

- [ENTERING A DESTINATION NUMBER USING THE NUMERIC KEYS \(page 5-10\)](#)
- [RETRIEVING A DESTINATION FROM AN ADDRESS BOOK \(page 5-11\)](#)
- [USING A SEARCH NUMBER TO RETRIEVE A DESTINATION \(page 5-14\)](#)
- [RETRIEVING A DESTINATION FROM A GLOBAL ADDRESS BOOK \(page 5-15\)](#)
- [USING A TRANSMISSION LOG TO RESEND \(page 5-19\)](#)



- Multiple fax numbers can be entered (maximum of 500).
- Polling will take place in the order that the multiple fax numbers were entered. Document reception by polling from multiple machines is called "Serial Polling".
- To enter multiple fax numbers, tap **+** after entering a fax number and enter the next fax number.



- In this procedure, one-touch keys that have a sub-address and passcode cannot be used.
- A one-touch key in which an address other than fax number is stored cannot be used.

2

Tap the [Others] key, and tap the [Polling] key.

A checkmark appears on the icon.

After the settings are completed, tap the [Back] key.

**To cancel the Polling setting:**

- Tap the [Polling] key to clear the checkmark.

3

Tap the [Start] key to initiate fax reception.

Your machine will call the other machine and initiate reception of the fax.



INITIATING POLLING RECEPTION MANUALLY

Use the manual polling reception when you must start polling after listening to a recorded greeting, such as when using a fax information service.



- Make sure there is no original in the machine when using the polling reception function.
- This function cannot be used to poll multiple machines (serial polling).
- The function can only be used when the other machine is Super G3 or G3 compatible and has a polling function.



The receiving machine bears the expense (phone charges) of the polling reception.

1

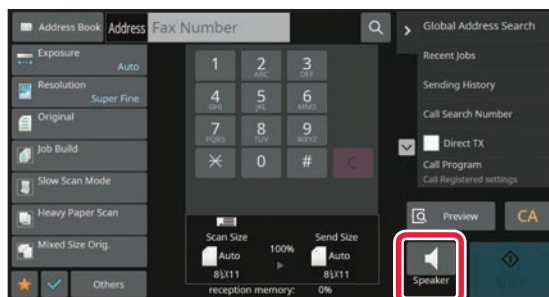

Tap the [Speaker] key.

You will hear the dial tone through the machine's speaker.

2

Enter the destination fax number.

- [ENTERING A DESTINATION NUMBER USING THE NUMERIC KEYS \(page 5-10\)](#)
- [RETRIEVING A DESTINATION FROM AN ADDRESS BOOK \(page 5-11\)](#)
- [USING A SEARCH NUMBER TO RETRIEVE A DESTINATION \(page 5-14\)](#)
- [RETRIEVING A DESTINATION FROM A GLOBAL ADDRESS BOOK \(page 5-15\)](#)
- [RETRIEVING A DESTINATION FROM A MOBILE ADDRESS BOOK \(page 5-17\)](#)
- [USING A TRANSMISSION LOG TO RESEND \(page 5-19\)](#)



One-touch key for a contact or group in which multiple destinations are stored, and one-touch key for which an address other than fax number is stored cannot be used.



After tapping the [Speaker] key, you can tap the [Speaker Volume] key to adjust the volume of the speaker.

3

Tap the [Others] key, and tap the [Polling] key to receive originals (data).

A checkmark appears on the icon.



To cancel the Polling setting:

Tap the [Polling] key to clear the checkmark.



SENDER-RELATED FEATURES

This section explains how to enter a destination from the initial screen of normal mode.

[EASY MODE \(page 5-6\)](#)

ADDING YOUR SENDER INFORMATION TO FAXES (FAX OWN NUMBER SENDING)

Your sender information (date, time, sender name, sender fax number or destination name, number of pages) is automatically added to the top of each fax page you transmit.

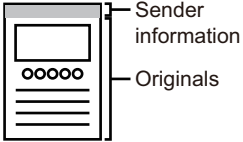
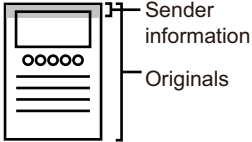
Outside scanned image (factory default setting)	Load
 <p>The transmitted image length will be length of sender information + length of original image. When the fax is printed by the receiving machine, it may be reduced or divided onto two pages.</p>	 <p>The sender information is printed inside the original image, and thus the transmitted image length is the length of the original. Note that the sender information will overlap part of the original image (the overlapped part of the original image will not appear).</p>

Example of the sender information printed

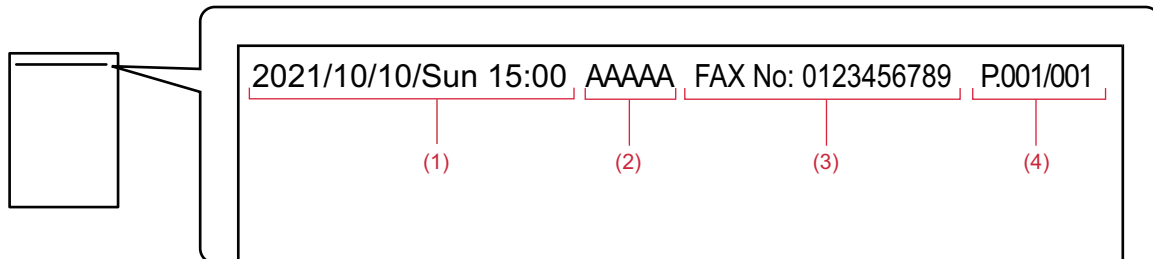

- (1) Date, time: The date and time of transmission.
- (2) Sender name: The sender name programmed in the machine.
- (3) Sender fax number or destination name (one-touch key name)
- (4) Page numbers: Page number/total pages



If destination name is set to be attached and the destination is not specified using a one-touch key, this information is not added to the fax and not printed.



- **To set the date and time:**
In "Settings", select [System Settings] → [Common Settings] → [Device Control] → [Clock Adjust].
- **To store a sender name and sender fax number:**
In "Settings (administrator)", select [System Settings] → [Image Send Settings] → [Common Settings] → [Own Name and Destination Set] → [Own Number and Name Set] → [Sender Data Registration].
When you use the Own Number Setting, always configure this information.
- **To add the number of pages to be transmitted:**
In "Settings", select [System Settings] → [Image Send Settings] → [Fax Settings] → [Send Settings] → [Printing Page Number at Receiver].
Page numbers appear in the format "page number/total pages". Only the page number is printed when "Manual Transmission" or "Quick On Line Sending" is used.
- **To select a sender fax number or destination:**
In "Settings", select [System Settings] → [Image Send Settings] → [Fax Settings] → [Send Settings] → [Sender Destination Name Switch].

TEMPORARILY CHANGING THE SENDER INFORMATION (OWN NAME SELECT)

You can temporarily change sender information to be used in the own number sending by selecting from data stored separately.



The function is released when the transmission with the changed sender information ends.



- **To store the sender information to be used for Own Name Select function:**
In "Settings (administrator)", select [System Settings] → [Image Send Settings] → [Common Settings] → [Own Name and Destination Set] → [Own Number and Name Set] → [Registration of Own Name Select].
- **Sender Name**
Enter the sender name. A maximum of 20 characters can be entered for the sender name.
After entering a sender name, tap the [Store] key.
The lowest unused registration number from 01 to 18 will be automatically assigned to the sender name. This number cannot be changed.
- **Sender Name List**
Displays a list of stored sender names.
When you select a sender name, it is deleted.

1

Place the original.

Place the original in the document feeder tray of the automatic document feeder, or on the document glass.

[AUTOMATIC DOCUMENT FEEDER \(page 1-34\)](#)

[DOCUMENT GLASS \(page 1-38\)](#)



2

Enter the destination fax number.

- [ENTERING A DESTINATION NUMBER USING THE NUMERIC KEYS \(page 5-10\)](#)
- [RETRIEVING A DESTINATION FROM AN ADDRESS BOOK \(page 5-11\)](#)
- [USING A SEARCH NUMBER TO RETRIEVE A DESTINATION \(page 5-14\)](#)
- [RETRIEVING A DESTINATION FROM A GLOBAL ADDRESS BOOK \(page 5-15\)](#)
- [RETRIEVING A DESTINATION FROM A MOBILE ADDRESS BOOK \(page 5-17\)](#)
- [USING A TRANSMISSION LOG TO RESEND \(page 5-19\)](#)

3

Tap the [Others] key, and tap the [Own Name Select] key.

4

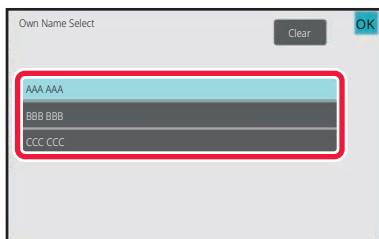
**Tap the sender information key to specify the sender information.**

After the settings are completed, tap the **OK** and [Back] keys in sequence.



To cancel the sender information setting:
Tap the [Clear] key.

5

Tap the [Start] key to start scanning of the original.

- If you inserted the original pages in the document feeder tray, all pages are scanned.
 - A beep will sound to indicate that scanning and transmission have ended.
 - When you place the original on the document glass, scan each page one at a time.
 - When scanning finishes, place the next original and tap the [Start] key. Repeat until all pages have been scanned and then tap the [Read-End] key.
- A beep will sound to indicate that transmission has ended.



- You can tap the [Preview] key to check a preview of the image before sending a fax.
- For more information, see "[CHECKING THE IMAGE TO BE TRANSMITTED \(page 5-28\)](#)". However, settings for this function cannot be changed in the preview screen.



ASSUMING A SPECIFIC USAGE

This section explains how to enter a destination from the initial screen of normal mode.

[EASY MODE \(page 5-6\)](#)

CHANGING THE PRINT SETTINGS FOR THE TRANSACTION REPORT (TRANSACTION REPORT)

A transaction report is automatically printed out to alert you when a transmission fails or when a broadcast transmission is performed.

The transaction report contains a description of the transmission (date, start time, name of destination, time required, number of pages, result, etc.).

[INFORMATION APPEARING IN THE RESULT COLUMN \(page 5-105\)](#)



- Transaction reports are printed based on conditions set in "Settings"; however, you can temporarily select different conditions for a transmission.
- For a broadcast transmission, changes to the transaction report print conditions apply to all destinations.



To set the printing conditions of transaction report:

In "Settings (administrator)", select [System Settings] → [Image Send Settings] → [Fax Settings] → [Default Settings] → [Transaction Report Print Select Setting].

1

Place the original.

Place the original in the document feeder tray of the automatic document feeder, or on the document glass.

[AUTOMATIC DOCUMENT FEEDER \(page 1-34\)](#)

[DOCUMENT GLASS \(page 1-38\)](#)

2

Enter the destination fax number.

- [ENTERING A DESTINATION NUMBER USING THE NUMERIC KEYS \(page 5-10\)](#)
- [RETRIEVING A DESTINATION FROM AN ADDRESS BOOK \(page 5-11\)](#)
- [USING A SEARCH NUMBER TO RETRIEVE A DESTINATION \(page 5-14\)](#)
- [RETRIEVING A DESTINATION FROM A GLOBAL ADDRESS BOOK \(page 5-15\)](#)
- [RETRIEVING A DESTINATION FROM A MOBILE ADDRESS BOOK \(page 5-17\)](#)
- [USING A TRANSMISSION LOG TO RESEND \(page 5-19\)](#)

3

Tap the [Others] key, and tap the [Transaction Report] key.

4

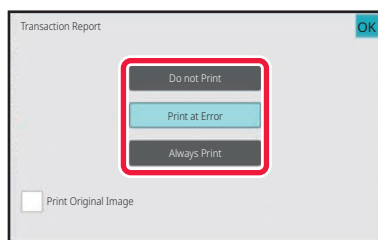

Tap the key of the print settings.

After the settings are completed, tap the **OK** and [Back] keys in sequence.

**To cancel the transaction report setting:**

Tap the [Do not Print] key.



- The print conditions for a transaction report are as follows:
 - "Always Print": A transaction report is printed no matter whether the transmission succeeds or fails.
 - "Print at Error": A transaction report is printed when transmission fails.
 - "Do not Print": Do not print a transaction report.
- Set the [Print Original Image] checkbox to to include the first page of the transmitted original in the transaction report.
- Even if the [Print Original Image] checkbox is , the original cannot be printed when speaker dialing, manual transmission, direct transmission, polling reception, or F-code transmission is used.

5**Tap the [Start] key to start scanning of the original.**

- If you inserted the original pages in the document feeder tray, all pages are scanned.
 - A beep will sound to indicate that scanning and transmission have ended.
 - When you place the original on the document glass, scan each page one at a time.
 - When scanning finishes, place the next original and tap the [Start] key. Repeat until all pages have been scanned and then tap the [Read-End] key.
- A beep will sound to indicate that transmission has ended.



You can tap the [Preview] key to check a preview of the image before sending a fax.

For more information, see "[CHECKING THE IMAGE TO BE TRANSMITTED \(page 5-28\)](#)". However, settings for this function cannot be changed in the preview screen.

Original image in transaction report

When [Print Original Image] is enabled, the first page of the transmitted original is printed on the same sheet as the transaction report. The original image is reduced to allow it to fit on the sheet. If the vertical scanning length (X direction) of the original is longer than 17-1/64" (432 mm), the part that exceeds 17-1/64" (432 mm) may be cut off.



POLLING MEMORY FUNCTIONS

This section explains how to enter a destination from the initial screen of normal mode.

[EASY MODE \(page 5-6\)](#)

SENDING A FAX WHEN ANOTHER MACHINE POLLS YOUR MACHINE (POLLING MEMORY)

Sending a document that has been scanned into memory when another machine polls your machine is called "Polling Memory". Prior to polling, the document that will be faxed to the other machine must be scanned into a polling memory box.

[SCANNING A DOCUMENT INTO POLLING MEMORY \(page 5-85\)](#)

This function can only be used when the other machine is Super G3 or G3 compatible and has a polling function.

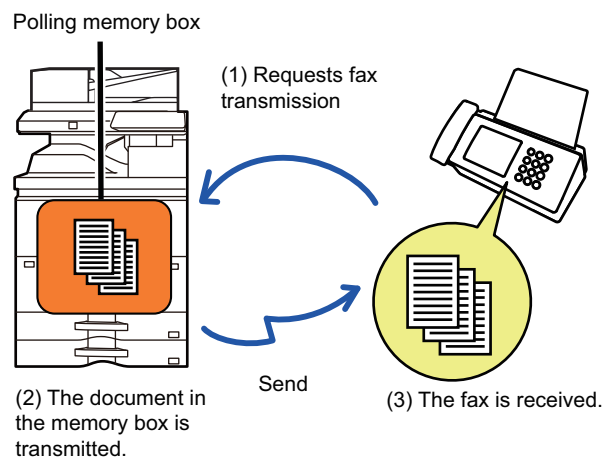

RESTRICTING POLLING ACCESS (POLLING SECURITY SETTING)

The following explains "Polling Security Setting", a feature restricting other machines that can use polling memory. When a machine requests fax transmission, you can only allow the machine to use polling memory if its programmed sender fax number matches a fax number stored in your machine as a polling passcode number. This function is called "Polling Security Setting".

To use this function, first store polling passcode numbers (the sender fax numbers programmed in the other machines) in settings mode of the machine, and then enable the polling security setting.



The polling security setting can be enabled for up to 10 other machines.



To set the polling security:

In "Settings (administrator)", select [System Settings] → [Image Send Settings] → [Fax Settings] → [Fax Polling Security] → [Set Fax Polling Security], [Add New], [Passcode Number Key List].

Note that these settings do not apply to F-code polling memory.



SCANNING A DOCUMENT INTO POLLING MEMORY

Follow these steps to scan a document into the memory box for polling transmission (Public Box).



If another document remains in the memory box (Public Box), the newly scanned document is added to the previous document. In this case, the number of polling times will be the number set for the newly scanned document.

1

Place the original.

Place the original in the document feeder tray of the automatic document feeder, or on the document glass.

[AUTOMATIC DOCUMENT FEEDER \(page 1-34\)](#)

[DOCUMENT GLASS \(page 1-38\)](#)

2

Select settings for the original to be scanned and other functions.



You cannot set the Program, Timer, Transaction Report, Polling, and Document Filing.

3

Tap the [Others] key, and tap the [Memory Box] key.

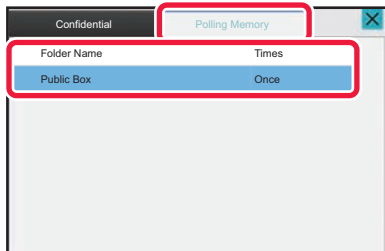
4

Tap the [Polling Memory] tab.

5

Tap the [Public Box] key from the folder list.



6

Tap [Change Number of Times] on the action panel.



7

Tap the [Once] key or [Unlimited] key to specify the number of times.

To repeat transmitting an original, tap the [Unlimited] key.
After the settings are completed, tap  and .

8

Tap the [Start] key to start scanning of the original.

- A preview of the image will appear in the touch panel when the original is scanned.
- If you inserted the original pages in the document feeder tray, all pages are scanned.
- When you place the original on the document glass, scan each page one at a time.
When scanning finishes, place the next original and tap the [Start] key. Repeat the procedure until all pages have been scanned and then tap the [Read-End] key.

CHECKING THE DOCUMENT IN THE PUBLIC BOX

You can check the document stored in the machine's memory box (public box) for memory polling.

1

Tap the [Others] key, and tap the [Memory Box] key.

2

Tap the [Polling Memory] tab.

3

Tap the [Public Box] key from the folder list.

When a document is not stored in the Public Box, the [Public Box] key is grayed out.

4

Tap [Check Image] on the action panel to check the document.

To print the document, tap [Print] on the action panel.



DELETING A DOCUMENT FROM THE PUBLIC BOX

Delete a document from the memory box (public box) when it is no longer required.

1

Tap the [Others] key, and tap the [Memory Box] key.

2

Tap the [Polling Memory] tab.

3

Tap the [Public Box] key from the folder list.

4

Tap [Empty out Box] on the action panel.



If you tap [Check Image] on the action panel, you can check the image on the touch panel before it is erased.

5

Tap the [Yes] key.

- The document is deleted and you return to the screen of step 2.
- If you tap [Check Image] on the action panel, you can check the image on the touch panel before it is erased.



To cancel the document deletion:

Tap the [No] key.



PERFORMING F-CODE COMMUNICATION

F-CODE COMMUNICATION

This section explains how to enter a destination from the initial screen of normal mode.

[EASY MODE \(page 5-6\)](#)

F-CODE COMMUNICATION

This function allows the machine to communicate with other machines that also support F-code.

It enables exchange of confidential documents (confidential communication), retrieval (polling) and distribution (polling memory) of information, distribution of information to multiple destinations (relay broadcast transmission) with other machines that support F-code communication. An F-code* is specified in each communication, enabling a higher level of security.

* F-code is a communication function based on the G3 standard of the ITU-T.

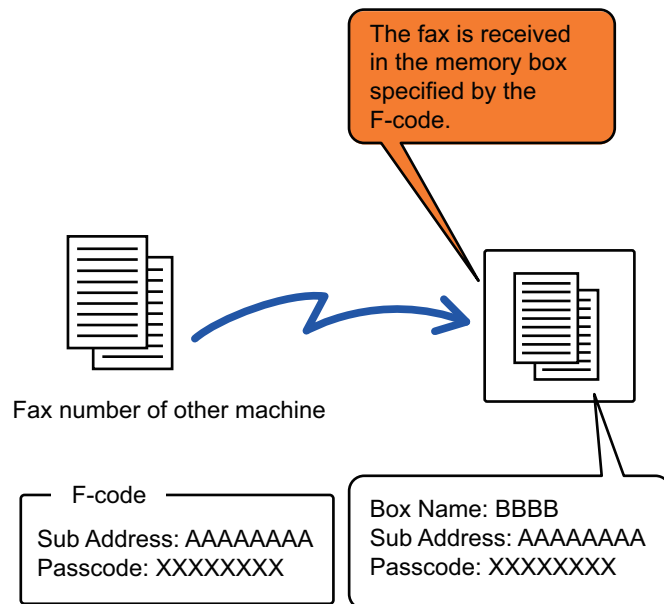

The ITU-T is a United Nations organization that establishes communications standards. It is a department of the International Telecommunication Union (ITU), which coordinates global telecommunications networks and services.



How F-codes work

A fax that is transmitted with an F-code is received in the memory box of F-code communication in the receiving machine specified by the F-code (sub-address and passcode). If the F-code sent by the transmitting machine does not match the F-code in the receiving machine, reception will not take place.

The products of other manufacturers may use different terms for "Sub Address" and "Passcode". If you need to contact the operator of another machine regarding sub-addresses and passcodes, refer to the terms used by the ITU-T in the table below.

The machine	ITU-T		
	F-code polling memory box	F-code confidential box	F-code relay broadcasting function
Sub Address	SEP	SUB	SUB
Passcode	PWD	SID	SID



An F-code consists of a sub-address and passcode, and cannot be longer than 20 digits.

CREATING MEMORY BOXES IN THE MACHINE FOR F-CODE COMMUNICATION

Before the F-code communication function can be used, special memory boxes must be created in "Settings".

Set the box name and F-code (sub-address and passcode) in each memory box, and store them.

After you have created a memory box, notify the other party of F-code communication of the sub-address and passcode of the box.

Items to be configured on the memory box are as follows:

- Memory Box Name
- Sub Address
- Passcode
- Recipient (only for F-code relay broadcast transmission)
- Print PIN (only for F-code confidential reception)



To create F-code memory boxes:

Create in "Settings" - [System Settings] → [Image Send Settings] → [Fax Settings] → [F-Code Memory Box].

To use the following F-code communication functions, F-code memory boxes must be created in your machine.

- F-code confidential reception
- F-code polling memory
- F-code relay broadcast transmission

To use the following F-code communication functions, F-code memory boxes must be created in the other machine.

- F-CODE CONFIDENTIAL TRANSMISSION
- F-code polling reception
- F-code relay request transmission



F-CODE DIALING

When performing an F-code operation, the F-code (sub-address and passcode) is appended to the fax number that is dialed. Check the F-code (sub-address and passcode) stored in the memory box in the other machine before you perform an F-code transmission. It is convenient to store an F-code (sub-address and passcode) together with the fax number in a one-touch key or group key.

To use the following F-code communication functions, your machine must dial the other machine.

- F-CODE CONFIDENTIAL TRANSMISSION
- F-code polling reception
- F-code relay request transmission

To use the following F-code communication functions, the other machine must dial your machine.

- F-code confidential reception
- F-code polling memory
- F-code relay broadcast transmission



If the destination machine does not have a passcode configured in the F-code, do not enter a passcode when dialing that machine.



Communication using the F-code (sub-address and passcode) is not available when dialing using a speaker or manual transmission.



To store and edit one-touch keys and group keys:

Select [Address Book] in "Settings".

F-CODE CONFIDENTIAL TRANSMISSION

By sending a fax to an F-code memory box (confidential) stored in the receiving machine (your machine or the other machine), the sender can direct the transmission specifically to the user of the box.

This is convenient for sending sensitive documents that you do not wish people other than the recipient to see, or when the receiving machine is shared by multiple departments.

To print an F-code confidential fax, the PIN Code must be entered.

[CHECKING FAXES RECEIVED BY F-CODE CONFIDENTIAL RECEPTION \(page 5-92\)](#)



The F-code (sub-address and passcode) of the memory box to be used should be verified by the sender and the recipient before the fax is sent.



To create F-code memory boxes:

Create in "Settings (administrator)" - [System Settings] → [Image Send Settings] → [Fax Settings] → [F-Code Memory Box].



CONFIDENTIAL TRANSMISSION USING F-CODES

Send a fax to a destination fax number after adding the F-code (sub-address and passcode).



If necessary, the F-code confidential transmission can be used in combination with a broadcast transmission or timer transmission. It is convenient to store this function in a program.



The F-code confidential transmission cannot be registered as a "Favorite" item.

1

Place the original.

Place the original in the document feeder tray of the automatic document feeder, or on the document glass.

[AUTOMATIC DOCUMENT FEEDER \(page 1-34\)](#)

[DOCUMENT GLASS \(page 1-38\)](#)

2

Specify the destination.

- (1) Tap the [Direct Entry] key.
- (2) Enter the destination line number using the numeric keys.
- (3) Tap the [Sub Address] key.
Symbol "/" is entered.
- (4) Enter the sub-address using the numeric keys.
- (5) Tap the [Passcode] key.
Symbol "/" is entered.
- (6) Enter the passcode using the numeric keys.



- If the sub-address and passcode are already registered, you can select a one-touch key as well.
- If the passcode is omitted for the memory box of destination machine, you can skip Steps (4) and (5).

3

Tap the [Start] key.

Scanning of the original starts.

- If you inserted the original pages in the document feeder tray, all pages are scanned.
A beep will sound to indicate that scanning and transmission have ended.
- When you place the original on the document glass, scan each page one at a time.
When scanning finishes, place the next original and tap the [Start] key. Repeat until all pages have been scanned and then tap the [Read-End] key.
A beep will sound to indicate that transmission has ended.



You can tap the [Preview] key to check a preview of the image before sending a fax.
For more information, see "[CHECKING THE IMAGE TO BE TRANSMITTED \(page 5-28\)](#)". However, settings for this function cannot be changed in the preview screen.



CHECKING FAXES RECEIVED BY F-CODE CONFIDENTIAL RECEPTION

When an F-code confidential fax received, the fax is stored in the memory box specified by the F-code. To check received faxes, enter the PIN Code.



- Confidential faxes are automatically given priority in the print job queue.
- The fax is automatically cleared from the memory box after being printed.



To print transaction report automatically when an F-code confidential fax is received:

In "Settings", select [System Settings] → [Image Send Settings] → [Fax Settings] → [Default Settings] → [Transaction Report Print Select Setting] → [Confidential Reception].



If you forget the PIN Code:

There is no way to use the machine to check a PIN Code that has been specified. Exercise care not to forget the PIN Code. Should you forget or need to verify the PIN Code, contact your dealer or nearest SHARP Service Department.

1

The machine rings and the fax is received.

A beep sounds when reception ends.

2

Tap the [Others] key, and tap the [Memory Box] key.

3

From the [Confidential] tab.

4

Tap the key of the memory box containing the confidential fax.

“” appears in the keys of memory boxes that have received faxes. The keys of memory boxes that have not received faxes are grayed out and cannot be tapped.

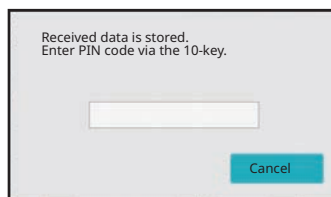
5

Enter the PIN Code using the numeric keys.



Take care to enter the correct PIN Code. If you make a mistake, a message will appear and you will return to the entry screen. You can tap the [Cancel] key to return to step 4.



6

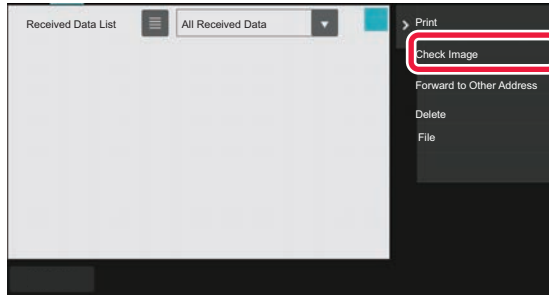

Tap the key of the received data you wish to check, and tap [Check Image] on the action panel.

Displays the received data image.

To print the document, tap [Print] on the action panel.

POLLING RECEPTION USING F-CODES

This function enables your machine to call another machine and initiate reception of a fax stored in an F-code memory box (polling memory) in the other machine. During the polling operation, your machine must correctly specify the F-code (sub-address and passcode) configured in the other machine. Otherwise, polling reception will not take place.

Transmission request (Polling) using an F-code

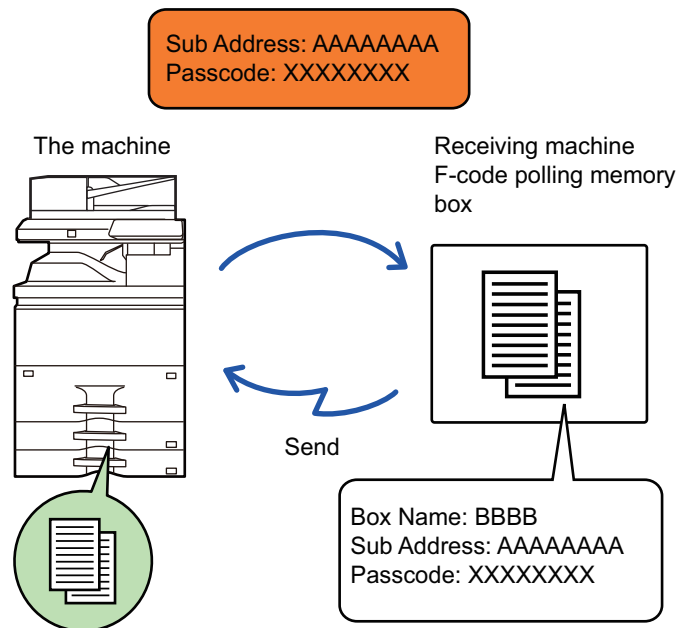

- Verify the F-code (sub-address and passcode) of the memory box in the other machine before you perform F-code polling reception.
- The receiving machine bears the telephone charges of the transmission.
- If necessary, use the F-code polling reception in combination with a broadcast transmission or timer transmission. Only one polling reception with a timer setting can be stored at a time.



- Polling multiple machines (serial polling) is not possible.
- Make sure there is no original in the machine when using the F-code for the polling reception function.
- The polling reception using the F-code cannot be registered as a "Favorite" item.

**1****Tap the [Others] key, and tap the [Polling] key.**

A checkmark appears on the icon.

After the settings are completed, tap the [Back] key.

**To cancel the Polling setting:**

Tap the [Polling] key to clear the checkmark.

2**Specify the destination.**

(1) Enter the destination line number using the numeric keys.

(2) Tap the [Sub Address] key.

Symbol "/" is entered.

(3) Enter the sub-address using the numeric keys.

(4) Tap the [Passcode] key.

Symbol "/" is entered.

(5) Enter the passcode using the numeric keys.



- If the sub-address and passcode are already registered, you can select a one-touch key as well.
- If the passcode is omitted for the memory box of destination machine, you can skip Steps (4) and (5).

3**Tap the [Start] key.**

Your machine will call the other machine and initiate reception of the fax.



SCANNING A DOCUMENT INTO A MEMORY BOX FOR F-CODE POLLING TRANSMISSION

When your machine receives a transmission request from another machine, this function sends a fax stored in an F-code memory box (polling memory) in your machine to that machine. The other machine must correctly specify the F-code (sub-address and passcode) configured in your machine. Otherwise, transmission will not take place. An original to be sent to the other machine using F-code polling communication must be previously scanned into an F-code memory box (polling memory) in your machine.

Transmission request (Polling) using an F-code

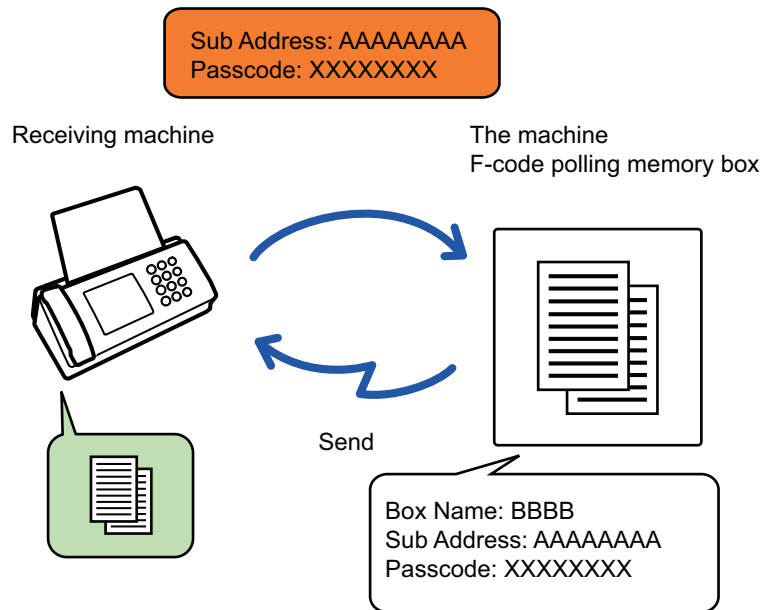

- If other documents have already been stored in the memory box, the document is added to the previously stored documents.
- By factory default, the document sent to the other machine will be deleted automatically.



To create F-code memory boxes:

Create in "Settings (administrator)" - [System Settings] → [Image Send Settings] → [Fax Settings] → [F-Code Memory Box].

1

Place the original.

Place the original in the document feeder tray of the automatic document feeder, or on the document glass.

[AUTOMATIC DOCUMENT FEEDER \(page 1-34\)](#)

[DOCUMENT GLASS \(page 1-38\)](#)

2

Select settings for the original to be scanned and other functions.



You cannot set the Program, Timer, Transaction Report, Polling, and Document Filing.



3

Tap the [Others] key, and tap the [Memory Box] key.

4

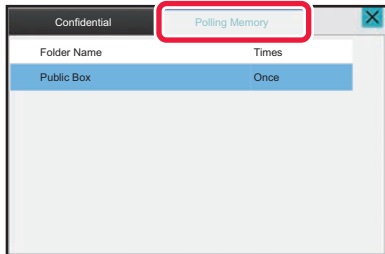

Tap the [Polling Memory] tab.



5

Tap the folder of the F-code memory polling box.

6

Tap [Change Number of Times] on the action panel, and set the polling times.

To erase the original after its transmission, tap the [Once] key. To repeat transmitting an original, tap the [Unlimited] key. Change the settings as necessary.

After the settings are completed, tap ,  and [Back] keys.

7

Tap the [Start] key.

Scanning of the original starts.

- If you inserted the original pages in the document feeder tray, all pages are scanned.
 - When you place the original on the document glass, scan each page one at a time.
 - When scanning finishes, place the next original and tap the [Start] key.
- Repeat until all pages have been scanned and then tap the [Read-End] key.



You can tap the [Preview] key to check a preview of the image before sending a fax.

For more information, see "[CHECKING THE IMAGE TO BE TRANSMITTED \(page 5-28\)](#)". However, settings for this function cannot be changed in the preview screen.



CHECKING THE DOCUMENT IN THE F-CODE MEMORY POLLING BOX

You can check the document stored in the F-code memory polling box.



A document in a memory box cannot be printed while the document is being transmitted. By factory default, the document sent to the other machine will be deleted automatically.

1

Tap the [Others] key, and tap the [Memory Box] key.

2

Tap the [Polling Memory] tab.

3

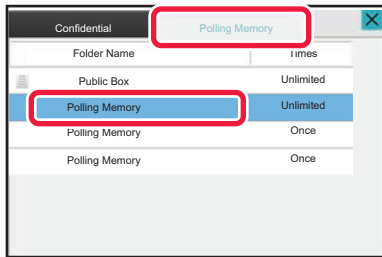

Tap the folder of the F-code memory polling box.

4

Tap [Check Image] on the action panel.

To print the document, tap the [Print] key.



DELETING A DOCUMENT STORED FOR F-CODE POLLING TRANSMISSION

Delete the document stored in an F-code memory polling box in order to be able to store a new document.



No original can be deleted from the memory box during communication.

1

Tap the [Others] key, and tap the [Memory Box] key.

2

Tap the [Polling Memory] tab.

3

Tap the folder of the F-code memory polling box.

4

Tap [Empty out Box] on the action panel.

If you tap [Check Image] on the action panel, you can check the image on the touch panel before it is erased.

5

Tap the [Yes] key.

The document is deleted, and you return to Step 2.



To cancel the document deletion:

Tap the [No] key.



RELAY REQUEST TRANSMISSION USING F-CODES

This function sends a fax to an F-code relay broadcast memory box in another machine and have that machine relay the fax to multiple destination machines.

When the destination machines are far from your machine, sending the fax to a relay machine that is close to the destination machines can help reduce telephone charges. A relay request transmission can be used in combination with the timer transmission function to further reduce cost.

The fax is transmitted in sequence to the end receiving machines registered in the F-code relay broadcast memory box.

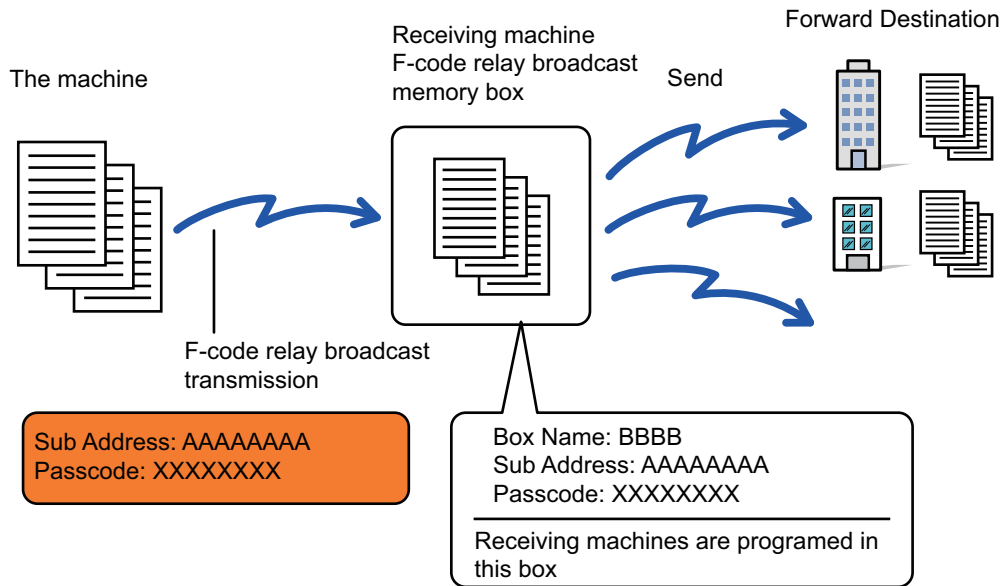

- F-code (sub-address and passcode) and the destination in the F-code relay broadcast memory box of the recipient machine should be verified by the recipient in advance.
- Before using this function, program the destination machines in the F-code relay broadcast memory box in the relay machine.
- It is not necessary for the destination machines to support F-code communication.
- Your machine (the machine that requests a relay broadcast transmission) only bears the cost of sending the fax to the relay machine. The relay machine bears the cost of sending the fax to each of the destination machines.
- If necessary, this function can be used in combination with a broadcast transmission or timer transmission. It is convenient to store this function in a program.



When faxes forwarded using this function are printed at the forwarding destination, the date and time of reception cannot be printed on the faxes. ("Receiving Date & Time Print" is disabled.)



To create F-code memory boxes:

Create in "Settings (administrator)" - [System Settings] → [Image Send Settings] → [Fax Settings] → [F-Code Memory Box].



1

Place the original.

Place the original in the document feeder tray of the automatic document feeder, or on the document glass.

[AUTOMATIC DOCUMENT FEEDER \(page 1-34\)](#)

[DOCUMENT GLASS \(page 1-38\)](#)

2

Specify the destination.

- [ENTERING A DESTINATION NUMBER USING THE NUMERIC KEYS \(page 5-10\)](#)
- [RETRIEVING A DESTINATION FROM AN ADDRESS BOOK \(page 5-11\)](#)
- [USING A SEARCH NUMBER TO RETRIEVE A DESTINATION \(page 5-14\)](#)
- [RETRIEVING A DESTINATION FROM A GLOBAL ADDRESS BOOK \(page 5-15\)](#)
- [RETRIEVING A DESTINATION FROM A MOBILE ADDRESS BOOK \(page 5-17\)](#)
- [USING A TRANSMISSION LOG TO RESEND \(page 5-19\)](#)



If the sub-address and passcode are stored in the one-touch key, it is not necessary to take steps 3 to 6. Go to step 7.

3

Tap the [Sub Address] key.

Enter "/".

4

Enter the sub-address using the numeric keys.

5

Tap the [Passcode] key.

Enter "/".

6

Enter the passcode using the numeric keys.

If a passcode has been omitted in the memory box of the destination machine, it is not necessary to take steps 5 and 6.

7

Tap the [Start] key.

Scanning begins.

- If you inserted the original pages in the document feeder tray, all pages are scanned.
A beep will sound to indicate that scanning and transmission have ended.
- When you place the original on the document glass, scan each page one at a time.
When scanning finishes, place the next original and tap the [Start] key. Repeat until all pages have been scanned and then tap the [Read-End] key.
A beep will sound to indicate that scanning and transmission have ended.
When the relay machine receives the fax, it will automatically transfer the fax to the destination machines programmed in the memory box.



When you use the automatic document feeder to scan an original, you can tap the [Preview] key to check a preview of the image before sending a fax. For more information, see "[CHECKING THE IMAGE TO BE TRANSMITTED \(page 5-28\)](#)"



RELAY BROADCAST TRANSMISSION USING F-CODES

When your machine receives an F-code relay request transmission, the fax is received and stored in an F-code relay broadcast memory box in your machine.

Your machine then relays the fax to each of the destination machines programmed in the memory box. Transmission to the destination machine takes place automatically.

The fax is transmitted in sequence to the end receiving machines registered in the F-code relay broadcast memory box.

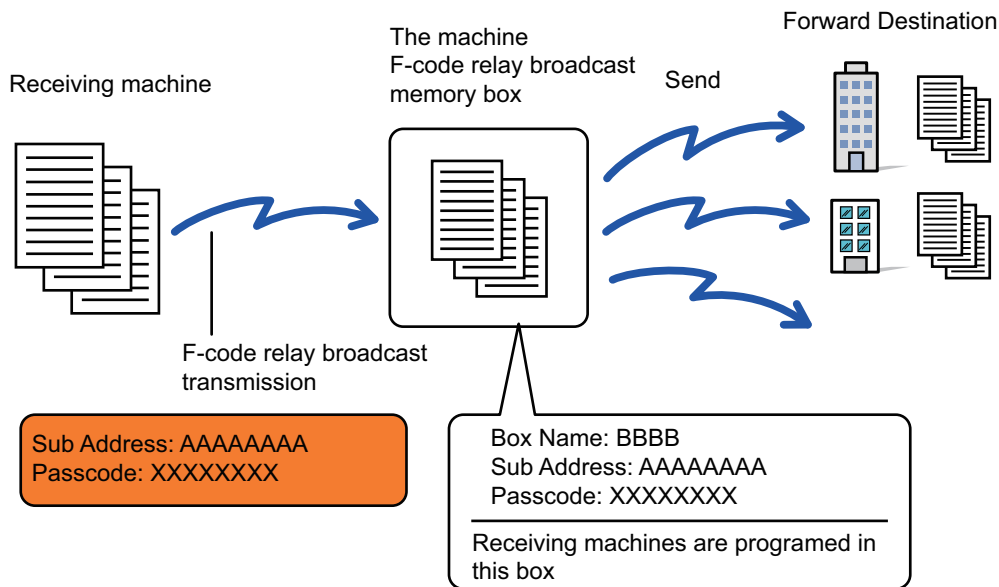

- Prior to carrying out the operation, inform the requesting party, who you will communicate with using F-code relay request transmission, of the sub-address and passcode of the F-code relay broadcast memory box in your machine.
- Program the destination machines in the F-code relay broadcast memory box when you create the box in your machine. [CREATING MEMORY BOXES IN THE MACHINE FOR F-CODE COMMUNICATION \(page 5-89\)](#)
- It is not necessary for the destination machines to support F-code communication.
- The machine that requests a relay broadcast transmission only bears the cost of sending the fax to your machine (the relay machine). Your machine bears the cost of sending the fax to each of the destination machines.
- If both direct SMTP and other sending methods are added to the forwarding destinations, transmission will not take place.



When faxes forwarded using this function are printed at the forwarding destination, the date and time of reception cannot be printed on the faxes. ("Receiving Date & Time Print" is disabled.)



USING AN EXTERNAL TELEPHONE

CONNECTING AN EXTERNAL TELEPHONE

CONNECTING AN EXTERNAL TELEPHONE

You can connect an existing telephone to the machine.

The telephone can be used for voice calls and to start fax reception on the machine. Connect the external telephone as shown below. After connecting an external telephone, configure the "External Telephone Setting" in setting mode (administrator).

Insert the plug on one end of the telephone line cord into the external telephone connection jack of the machine as shown until it clicks, and insert the other plug into a wall telephone jack until it clicks.

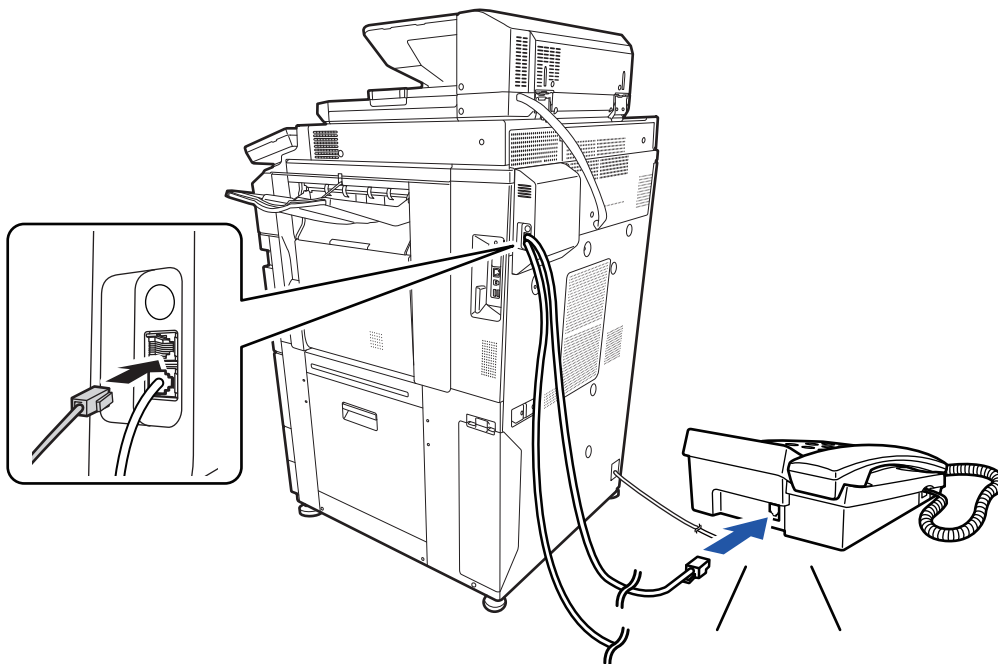

Enable the "Tel/Fax Auto Change" function. This is useful as the telephone or fax operation is selected automatically according to the calling.



- You cannot send a fax from your telephone.
- You can connect a telephone with a modular cable plug to your machine. Also, use the two-wire cable for telephone connection. If another type of cable is used, the telephone may not operate normally.
- If the plug on the telephone line cord does not fit into the jack on your external phone, contact your dealer or nearest SHARP Service Department.



RECEIVING A FAX AFTER ANSWERING A CALL ON THE EXTERNAL TELEPHONE (REMOTE RECEPTION)

Follow the steps below if you need to start fax reception after answering a call and speaking on the external telephone.

Dial [5], [*] and [*] buttons of the external telephone.

If you are using a pulse line, set the extension to send tone signals.



- **To receive a fax after answering a call on the external telephone:**

Set "Settings (administrator)" - [System Settings] → [Image Send Settings] → [Fax Data Receive/Forward (Manual)] → [Fax Settings] → [Receive Settings] to [Manual Reception].

- **To change the number to receive faxes:**

In "Settings", select [System Settings] → [Image Send Settings] → [Fax Settings] → [Default Settings] → [Remote Reception Number Setting]. Set a value from 00 to 99.

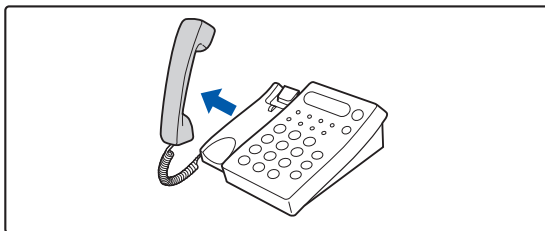
1

While the machine is ringing, pick up the receiver to speak.

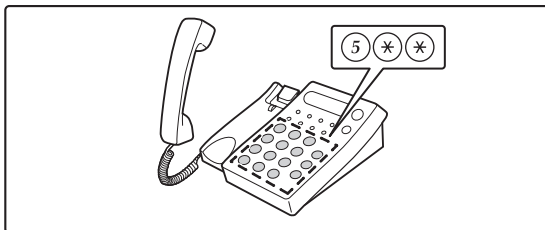
2

Signal the machine to start fax reception.

Press 5 5 * from the external telephone.

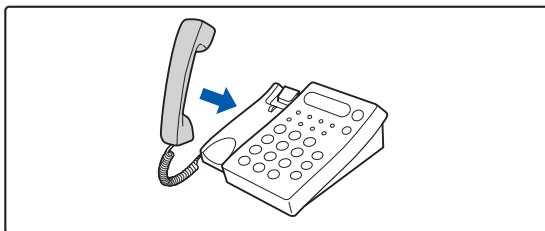
3

Replace the receiver.

The machine beeps when reception ends.

MAKING AND RECEIVING PHONE CALLS

You can make and receive calls like normal on your external phone. A phone call can also be made by dialing on the machine.



CHECK THE COMMUNICATION STATUS

FAX JOBS

When you tap the job status display, jobs are displayed in a list. To confirm the fax job status, tap the mode display and select the fax.

When you wish to stop or delete jobs or to perform priority processing, read the following items:

[STOPPING/DELETING A JOB IN PROGRESS OR RESERVED \(page 2-54\)](#)

[PRIORITY PROCESSING OF A RESERVED JOB \(page 2-55\)](#)

[CHECKING A RESERVED JOB OR THE JOB IN PROGRESS \(page 2-57\)](#)

[CHECKING COMPLETED JOBS \(page 2-58\)](#)

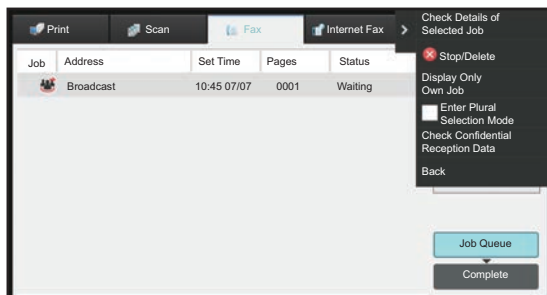

Fax jobs include reception, timer transmission, and data forwarding as well as usual transmission. For information on jobs in fax mode, see "[COMPLETED FAX TRANSMISSION/RECEPTION JOBS \(page 5-104\)](#)".

COMPLETED FAX TRANSMISSION/RECEPTION JOBS

A usual transmission job moves to the job list when transmission is completed. Then the status field displays "Send OK". However, received faxes, timer transmission faxes, retries, fax forwarding, and other fax jobs are displayed in the job status screen as follows:

FAX RECEPTION JOBS

When a fax is being received, the status field displays "Receiving" in the job queue list.

When reception is completed, the job moves to the completed job list and the status field displays "In Memory". After the fax is printed, the status changes to "Received".

TIMER TRANSMISSION JOBS

A timer transmission job appears at the end of the job queue list until the specified time is reached.

Transmission begins at the specified time. When transmission is completed, the job moves to the completed job list and the status field displays "Send OK".



RETRY JOBS

A retry job appears at the end of the job queue list.

Transmission of the retry job starts according to the [Recall in Case of Line Busy] setting in "Settings". When the transmission is completed, the retry job moves to the completed job list and the status changes to "Send OK".

RECEPTION JOBS WHEN THE INBOUND ROUTING SETTINGS ARE ENABLED

When the inbound routing settings are enabled, reception jobs are handled as follows depending on the print setting. [FORWARDING RECEIVED DATA TO PRESET DESTINATIONS \(INBOUND ROUTING SETTINGS\) \(page 5-65\)](#)

RECEIVED DATA IS NOT PRINTED

When a data is being received, "Receiving" appears in the job queue list. When the reception is completed, the status changes to "Waiting".

RECEIVED FAX IS PRINTED

When reception is completed, the status field displays "In Memory" in the completed job list. After the fax is printed, the status changes to "Received". Then a job is added for which the status field displays "Waiting" in the job queue list. When forwarding the received fax is completed, the field changes to "Forward OK".

CHECKING IMAGE SENDING ACTIVITIES

PRINTING IMAGE SENDING ACTIVITY REPORTS

You can have the machine print a log of recent image sending activity (date, name of other party, time required, result, etc.). The Image Sending Activity Report contains useful information such as the types of errors that occurred.

The most recent 200 transactions are included in the report.

You can have the machine print the Image Sending Activity Report each time the number of transactions reaches 201, or at a specified time (once a day only).



The contents of the Image Sending Activity Report are erased when the report is printed, and thus it cannot be reprinted.



To configure the image sending activity report:

In "Settings", select [System Settings] → [Image Send Settings] → [Fax Settings] → [Default Settings] → [Activity Report Print Select Setting].

INFORMATION APPEARING IN THE RESULT COLUMN

Error types and other information are printed in the result column of transaction and activity reports. When a transaction or activity report is printed, check the result of the transaction in the result column and take action as needed.



Examples of messages that are printed in the result column

Print Page	Description
Yes	The transaction was completed normally.
G3	Communication took place in G3 mode.
ECM	Communication took place in G3 ECM mode.
SG3	Communication took place in Super G3 mode.
Forward	The received data was forwarded.
No Response	No response from the receiving party.
Busy	Transmission was not possible because the other party was already using the line.
No	The transmission was canceled while in progress.
MEMORY OVER	The memory became full during quick on-line transmission.
FULL	The memory became full during reception.
LENGTH OVER	The transmitted fax was over 59" (1.5 m) long and therefore could not be received.
ORIGINAL ERROR	Direct transmission or manual transmission was not successful because a misfeed occurred.
PASS# NG	The connection was broken because the polling passcode was not correct.
NO RX POLL	The machine that was polled does not have a polling function.
RX POLL FAIL	The other machine refused the polling operation, or your machine broke the connection when polled because no data was in memory.
NO F-CODE POLL	The other machine refused an F-code polling operation, or your machine broke the connection when polled because no data was in its F-code memory polling box.
RX POLL# NG	The connection was broken because the sub-address for F-code polling memory was not valid.
F POLL PASS# NG	The connection was broken because the passcode for F-code polling memory was not valid.
BOX NO. NG	Your machine broke the connection because the specified sub-address for an F-code memory box does not exist.
F PASS# NG	Your machine broke the connection because the other machine sent an incorrect passcode for F-code communication.
RX NO F-CODE POLL	F-code polling was attempted, however, the other machine did not have an F-code polling memory box.
NO F FUNC	F-code communication was attempted, however, the other machine does not support F-code communication.
NO F-CODE	F-code communication was refused by the other machine because of an incorrect sub-address or other reason.
M. BOX: [xxxxxx] *****	Data was received and stored in a confidential or relay broadcast memory box, or data was sent from a memory polling box. The name of the memory box appears in [xxxxxx], and the type of F-code operation (relay request reception, polling memory transmission, or confidential reception) appears in *****.
FAIL xx (xxxx)	The transaction failed due to a communication error. First 2 digits of communication error number: Error code from 00 to 99. Last 4 digits of communication error number: Code for use by service technicians.
Rejected	A fax was sent from a party from which reception is blocked.



SCANNER/ INTERNET FAX

BEFORE USING THE MACHINE AS A NETWORK SCANNER

BEFORE USING THE MACHINE AS A NETWORK SCANNER FUNCTION	6-3
USES OF THE NETWORK SCANNER	6-3
BEFORE USING THE NETWORK SCANNER	6-4
STORING DESTINATIONS FOR SCAN TO DESKTOP	6-6
BEFORE SENDING TO A DIRECT SMTP ADDRESS	6-6
NETWORK SCANNER MODE	6-7
EASY MODE	6-7
NORMAL MODE	6-9
SELECTING NETWORK SCANNER MODE	6-9
IMAGE SEND SEQUENCE	6-10
ORIGINAL SIZE	6-13
TRANSMITTABLE ORIGINAL SIZES	6-13
THE SIZE OF THE PLACED ORIGINAL	6-13
ADDRESS BOOK	6-14
ADDRESS BOOK SCREEN	6-15
SELECTING "Contacts" OR "Group"	6-16
STORING ADDRESSES THROUGH DIRECT ENTRY	6-19
STORING ADDRESSES THROUGH GLOBAL ADDRESS SEARCH	6-20
STORING ADDRESSES FROM FAX OR IMAGE SEND LOGS	6-22
STORING GROUPS	6-24
EDITING/DELETING ADDRESSES IN ADDRESS BOOK	6-26
EDITING/DELETING CONTACTS AND GROUPS	6-26
EDITING/DELETING ADDRESSES	6-27
SETTING THE SCOPE FOR PUBLICIZING CONTACTS AND GROUPS	6-28
DELETING THE TRANSMISSION HISTORY	6-29
DELETING A SELECTED HISTORY	6-29
DELETING ALL TRANSMISSION HISTORIES	6-29
REGISTER AN ADDRESS BOOK IN THE WEB PAGE	6-30
Address Book	6-30
Category Setting	6-32

ENTERING DESTINATIONS

ENTERING DESTINATIONS	6-33
RETRIEVING A DESTINATION FROM AN ADDRESS BOOK	6-33
MY ADDRESS	6-35
VIEWING A LIST OF THE SELECTED DESTINATIONS	6-36
USING A SEARCH NUMBER TO RETRIEVE A DESTINATION	6-37

ENTERING AN ADDRESS MANUALLY	6-38
SPECIFYING A NETWORK FOLDER	6-39
RETRIEVING A DESTINATION FROM A GLOBAL ADDRESS BOOK	6-41
RETRIEVING A DESTINATION FROM A MOBILE ADDRESS BOOK	6-43
USING A TRANSMISSION LOG TO RESEND	6-45
SENDING ONLY THE URL OF A SCANNED FILE TO A SCAN DESTINATION	6-47

TRANSMITTING AN IMAGE

TRANSMITTING AN IMAGE	6-50
SENDING AN IMAGE IN SCAN MODE	6-50
CHANGING THE SUBJECT, FILE NAME, REPLY-TO, AND BODY TEXT AT THE TIME OF SCAN TRANSMISSION	6-53
SENDING A FAX IN INTERNET FAX MODE	6-56
CHANGING THE SUBJECT, FILE NAME, AND BODY TEXT AT THE TIME OF INTERNET FAX TRANSMISSION	6-58
SENDING THE SAME IMAGE TO MULTIPLE DESTINATIONS (BROADCAST TRANSMISSION)	6-61
SETTING MODES WHEN MULTIPLE TYPES OF ADDRESSES ARE INCLUDED IN A BROADCAST TRANSMISSION	6-63
RESENDING TO UNSUCCESSFUL BROADCAST TRANSMISSION DESTINATIONS	6-65
SENDING AN INTERNET FAX FROM A PC (PC-I-FAX)	6-67
IMAGE SETTINGS	6-68
AUTOMATICALLY SCANNING BOTH SIDES OF AN ORIGINAL (2-SIDED ORIGINAL)	6-68
SCAN SIZE AND SEND SIZE (ENLARGE/REDUCE)	6-69
SPECIFYING THE ORIGINAL SCAN SIZE IN PAPER SIZE	6-70
SPECIFYING THE ORIGINAL SCAN SIZE USING NUMERIC VALUES	6-72
STORING FREQUENTLY USED ORIGINAL SIZES	6-75
SPECIFYING THE SEND SIZE OF THE IMAGE	6-79
CHANGING THE EXPOSURE AND ORIGINAL IMAGE TYPE	6-81
CHANGING THE RESOLUTION	6-83
CHANGING FORMAT IN SCAN OR DATA ENTRY MODE	6-84
CHANGING FORMAT IN INTERNET FAX MODE	6-90
CHANGING COLOR MODE	6-90
SETTING SCAN SETTINGS AUTOMATICALLY (Auto Set)	6-92
CHECKING THE IMAGE TO BE TRANSMITTED	6-93





OTHER FUNCTIONS

STORING SCAN OPERATIONS (PROGRAM) 6-94

SCANNING AND SENDING ORIGINALS COLLECTIVELY 6-97

 SENDING TWO PAGES AS A SINGLE PAGE (N-Up) 6-97

 SCANNING ORIGINALS OF DIFFERENT SIZES (MIXED SIZE ORIGINAL) 6-99

 SCANNING BOTH SIDES OF A CARD ONTO A SINGLE PAGE (CARD SHOT) 6-101

 SIMULTANEOUSLY SCANNING MULTIPLE CARDS, RECEIPTS OR OTHER SMALL ORIGINALS TO INDIVIDUAL FILES (MULTICROP) 6-103

 SCANNING A BUSINESS CARD, READING THE TEXT STRING, CREATING A FILE, AND SENDING THE FILE (BUSINESS CARD SCAN) 6-106

 SCANNING MULTIPLE PHOTOS AT ONCE TO INDIVIDUAL FILES (Image Crop) 6-111

 SCANNING MANY ORIGINALS AT ONCE (JOB BUILD) 6-113

SCANNING AND SENDING AN ORIGINAL AS SEPARATE PAGES 6-116

 SCANNING AN ORIGINAL AS TWO SEPARATE PAGES (DUAL PAGE SCAN) 6-116

 SPLITTING A PAMPHLET BY PAGE AND TRANSMITTING THE PAGES SUCCESSIVELY (BOOK DIVIDE) 6-119

ADJUSTING COLORS AND SHADING 6-121

 ADJUSTING THE BACKGROUND BY MAKING LIGHT AREAS OF THE ORIGINAL DARKER OR LIGHTER (BACKGROUND ADJUSTMENT) 6-121

 ADDING CONTRAST TO THE SCANNED ORIGINAL BEFORE TRANSMISSION (CONTRAST) 6-123

 ENHANCING THE OUTLINE OF THE SCANNED ORIGINAL BEFORE TRANSMISSION (SHARPNESS) 6-125

 REMOVING CHROMATIC COLORS FROM THE SCANNED ORIGINAL BEFORE TRANSMISSION (DROP OUT COLOR) 6-127

 ADJUSTING RED/GREEN/BLUE (RGB Adjust) 6-129

SCANNING ORIGINALS 6-131

 ERASING PERIPHERAL SHADOWS ON THE IMAGE (ERASE) 6-131

 SCANNING A THIN ORIGINAL (SLOW SCAN MODE) 6-134

 SCANNING A HEAVY ORIGINAL (HEAVY PAPER SCAN) 6-136

 ELIMINATING BLANK PAGES FROM A TRANSMISSION (BLANK PAGE SKIP) 6-138

 CHECKING THE NUMBER OF SCANNED ORIGINAL SHEETS BEFORE TRANSMISSION (ORIGINAL COUNT) 6-140

AUTOMATICALLY ADJUST SKEWED SCAN DATA (Original Skew Adjustment) 6-142

SPECIFIC FUNCTIONS 6-144

 ADDING YOUR SENDER INFORMATION TO FAXES (I-FAX OWN ADDRESS SEND) 6-144

 CHANGING THE PRINT SETTINGS FOR THE TRANSACTION REPORT (TRANSACTION REPORT) 6-145

 STARTING A TRANSMISSION AT A SPECIFIED TIME (TIMER TRANSMISSION) 6-147

 ADDING A SIGNATURE WHEN SENDING AN IMAGE (ELECTRONIC SIGNATURE) 6-150

 ENCRYPTING THE TRANSMITTED DATA (ENCRYPTION) 6-152

INTERNET FAX RECEPTION FUNCTIONS

CHECKING THE INTERNET FAX ACTIVITY LOG 6-154

 PRINTING IMAGE SENDING ACTIVITY REPORTS 6-154

 INFORMATION APPEARING IN THE RESULT COLUMN 6-155

 RECEIVING INTERNET FAXES 6-156

 RECEIVING INTERNET FAXES MANUALLY 6-156

 PRINTING RECEIVED DATA 6-157

 PRINTING RECEIVED DATA AT A SPECIFIED TIME 6-158

 CHECKING THE IMAGE BEFORE PRINTING 6-159

FORWARDING RECEIVED DATA 6-161

 FORWARDING RECEIVED INTERNET FAX DATA (FAX DATA FORWARD) 6-161

 FORWARDING RECEIVED DATA TO PRESET DESTINATIONS (INBOUND ROUTING SETTINGS) 6-162

 SAVING RECEIVED FAXES TO THE MACHINE'S LOCAL DRIVE (INBOUND ROUTING) 6-165

 FORWARDING RECEIVED DATA MANUALLY 6-167

SAVING RECEIVED DATA 6-168

CHECKING THE STATUS OF TRANSMISSION/RECEPTION JOBS

IMAGE SEND JOBS 6-169

COMPLETED TRANSMISSION/RECEPTION JOBS . . . 6-170

SCANNING FROM A COMPUTER (PC Scan Mode)

BASIC SCANNING PROCEDURE 6-171

METADATA DELIVERY

PREPARATIONS FOR METADATA DELIVERY 6-175

 METADATA DELIVERY (DATA ENTRY) 6-175

 SETTINGS REQUIRED IN THE SETTING MODE (WEB VERSION) 6-176

 METADATA DELIVERY USING SCAN TO DESKTOP 6-176

TRANSMITTING METADATA 6-177

 TRANSMITTING METADATA 6-177

 METADATA FIELDS 6-178



BEFORE USING THE MACHINE AS A NETWORK SCANNER

BEFORE USING THE MACHINE AS A NETWORK SCANNER FUNCTION

USES OF THE NETWORK SCANNER

The network scanner allows you to create an image file from the original data scanned by the machine, and send the file over a network to a PC, FTP server, or other destinations. If necessary, it scans the original using a TWAIN-compliant application on your PC.

The network scanner function provides the following scanning modes.

Scanner mode

The scanner function of the machine sends a scanned original as described below based on the specification of the destination.

- **Scan to E-mail**

You can send a scanned file as an e-mail attachment. You can also save the file to the machine's local drive and send only a URL link (without attaching the file) that allows the recipient to download the file.

- **Scan to FTP**

The scanned file is sent to a specified folder of an FTP server.

When the file is sent, it is also possible to send an e-mail to a previously stored e-mail address to inform the recipient of the location of the file.

- **Scan to Desktop**

The scanned file is sent to a specified folder on your computer.

For information on Scan to Desktop, consult your dealer.

- **Scan to Network Folder**

The scanned file is sent to a network folder on a Windows PC on the same network as the machine.

When the file is sent, it is also possible to send an e-mail to a previously stored e-mail address to inform the recipient of the location of the file.

For the operating procedure, see "[SENDING AN IMAGE IN SCAN MODE \(page 6-50\)](#)".

Internet fax mode

The scanned file is sent as an Internet fax. Internet faxes are received if necessary.

The machine supports Direct SMTP, which lets you directly send Internet faxes within your company without using a mail server.



To use the Internet fax function, the Internet fax expansion kit must be installed.

For the operating procedure, see "[SENDING A FAX IN INTERNET FAX MODE \(page 6-56\)](#)".



Data entry mode

In data entry mode, information entered using the touch panel or automatically generated by the machine is sent to a directory on an FTP server or an application on a PC as a metadata file in XML format.



Installing the application integration module is required to use the metadata delivery function.

The application integration module can be combined with the network scanner to append a metadata file to a scanned image file.

Metadata is information about a file, how it is to be processed, and its relation to other objects.

For the operating procedure, see "[TRANSMITTING METADATA \(page 6-177\)](#)".

BEFORE USING THE NETWORK SCANNER

To use the machine as a network scanner, you must store sender information, configure server settings, store destinations in the address book, and perform other required operations.

1

Make sure the main power switch is in the " I " position.

When the main power indicator is lit up, the main power is in the " I " position. If the main power indicator is not lit up, turn the main power switch to the " I " position and press the [POWER] button on the operation panel.

[TURNING ON THE POWER \(page 1-10\)](#)

2

Check the date and time.

Verify that the correct date and time are set in the machine.



To set the date and time of the machine:

In "Settings", select [System Settings] → [Common Settings] → [Device Control] → [Clock Adjust].

3

Store the sender information.

Before using Scan to E-mail:

Store a default sender name in "Sender Name" and a reply e-mail address in "Reply E-mail Address".



• To store the sender's name and e-mail address that are used when a sender is not selected:

In "Settings (administrator)", select [System Settings] → [Image Send Settings] → [Scan Settings] → [Condition Settings] → [Default Reply.Address Set].

• Before using Internet fax:

Store a sender name in "Sender Name" and a sender Internet fax address in "Own Address".

• To store the sender's name and address:

In "Settings (administrator)", select [System Settings] → [Image Send Settings] → [Common Settings] → [Own Number and Name Set] → [Sender Data Registration].



Normally, the sender name and sender address are entered with the settings made in "Settings (Administrator)", [System Settings] → [Network Settings] → [Service Settings] → [SMTP] (tab) → [Sender Name, Sender Address]. When user authentication is enabled and "Settings (Administrator)", [System Settings] → [Authentication Settings] → [Default Settings] → [Set Email Address of Logged In User in the From/Sender Field of E-mail] is enabled, the user name and E-mail address of the logged-in user will be set as the From/Sender field of E-mail.



4

Configure settings required in the setting mode.

Configure server settings, default settings for the network scanner, and settings for Internet Fax.



• **To configure server settings:**

In "Settings (administrator)", select [System Settings] → [Network Settings] → [Services Settings]. (Administrator rights are required.)

• **To configure basic settings for the network scanner:**

In "Settings (administrator)", select [System Settings] → [Image Send Settings] → [Scan Settings]. (Administrator rights are required.)

• **To configure settings for Internet Fax:**

In "Settings (administrator)", select [System Settings] → [Image Send Settings] and then configure options in [Internet Fax Settings]. (Administrator rights are required.)

5

Store the destination addresses for each scan mode in the address book.

You can send an image by directly entering an address when using Scan to Image. It is convenient to previously store addresses in the address book.

Up to 6000 addresses can be stored in the address book. For information on the address book, see "ADDRESS BOOK".

For how to use the address books and how to store addresses, see the following item.

[RETRIEVING A DESTINATION FROM AN ADDRESS BOOK \(page 6-33\)](#)

[VIEWING A LIST OF THE SELECTED DESTINATIONS \(page 6-36\)](#)

[USING A SEARCH NUMBER TO RETRIEVE A DESTINATION \(page 6-37\)](#)

[ENTERING AN ADDRESS MANUALLY \(page 6-38\)](#)

[SPECIFYING A NETWORK FOLDER \(page 6-39\)](#)

[RETRIEVING A DESTINATION FROM A GLOBAL ADDRESS BOOK \(page 6-41\)](#)

[RETRIEVING A DESTINATION FROM A MOBILE ADDRESS BOOK \(page 6-43\)](#)

[USING A TRANSMISSION LOG TO RESEND \(page 6-45\)](#)



STORING DESTINATIONS FOR SCAN TO DESKTOP

To store your computer in the machine as a destination for Scan to Desktop, Network Scanner Tool Lite must be installed.

To scan an image to your computer, Network Scanner Tool Lite must be running on your computer.



For information on how to obtain and install Network Scanner Tool Lite, see the following URL.
https://global.sharp/products/copier/products/nst_lite/tips/index.html

BEFORE SENDING TO A DIRECT SMTP ADDRESS

The machine supports Direct SMTP, which lets you directly send Internet faxes within your company without using a mail server.

For the procedure for storing the Direct SMTP address in the address book, see "[STORING ADDRESSES THROUGH DIRECT ENTRY \(page 6-19\)](#)", "[STORING ADDRESSES THROUGH GLOBAL ADDRESS SEARCH \(page 6-20\)](#)" or "[STORING GROUPS \(page 6-24\)](#)". Stored Direct SMTP addresses are included in the address book for Internet fax mode.

If the destination is busy:

If the destination is busy, the machine will wait briefly and then automatically resend.



To cancel transmission:

Do so from the job status screen.

[STOPPING/DELETING A JOB, PRIORITY PROCESSING AND CHECKING THE STATUS \(page 2-52\)](#)



To set the number of recall attempts and the interval between attempts when the connection cannot be established because the line is busy, or for other reasons:

In "Settings (administrator)", select [System Settings] → [Image Send Settings] → [Internet Fax Settings] → [Send Setting] → [Recall in Case of Line Busy].

The factory default setting is two attempts at 3-minute intervals.

When a communication error occurs:

If a communication error occurs or the other fax machine does not answer the call within a preset period of time, transmission will automatically be attempted again after a preset interval.



To cancel transmission:

Do so from the job status screen.

[STOPPING/DELETING A JOB, PRIORITY PROCESSING AND CHECKING THE STATUS \(page 2-52\)](#)



To set the number of recall attempts and the interval between attempts when a transmission fails due to an error:

In "Settings (administrator)", select [System Settings] → [Image Send Settings] → [Internet Fax Settings] → [Send Setting] → [Recall in Case of Communication Error].

The factory default setting is two attempts at 3-minute intervals.



NETWORK SCANNER MODE

Network scanner mode has two modes: easy mode and normal mode.

Easy mode is limited to frequently used functions that allow you to smoothly perform most image send jobs.

If you need to select detailed settings or special functions, use normal mode. All functions can be used in normal mode.

EASY MODE

Easy mode makes it easy to select basic settings for network scanner mode.

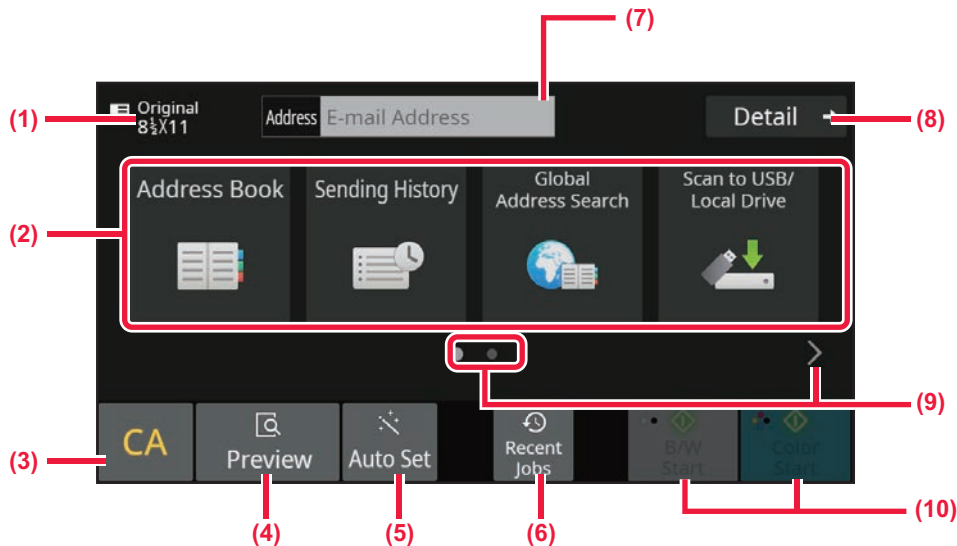

- | | |
|---|--|
| <p>(1) The original size is displayed.</p> <p>(2) Set an address.</p> <p>(3) Reset the address and settings.</p> <p>(4) Scans the original and shows a preview image.
▶ PREVIEW SCREEN (page 2-11)</p> <p>(5) Automatically set the original placement orientation, resolution, skipping of blank pages, automatically detect mono2/grayscale, and Original Skew Adjustment.
▶ SETTING SCAN SETTINGS AUTOMATICALLY (Auto Set) (page 6-92)</p> | <p>(6) Recently used job setting can be loaded.
▶ JOB STATUS (page 2-52)</p> <p>(7) Tap to display the soft keyboard.</p> <p>(8) Change to normal mode.
▶ NORMAL MODE (page 6-9)</p> <p>(9) Change the function display.</p> <p>(10) Starts black and white or color transmission.</p> |
|---|--|

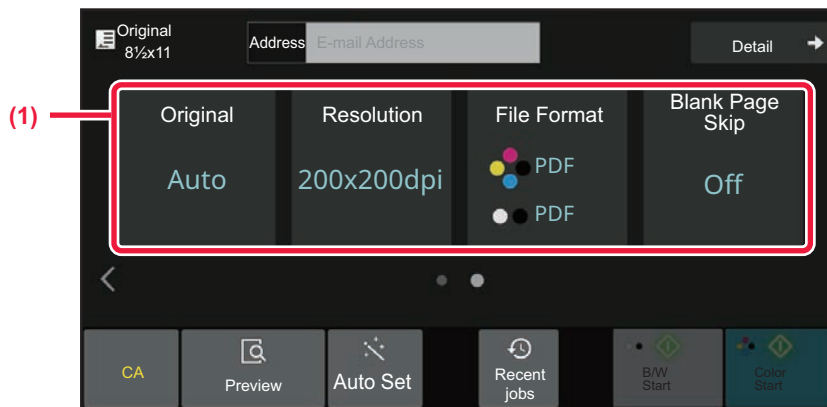

(1) Select the function you want to use.

You can select these functions in easy mode.

- Original: [▶ page 6-81](#)
- Resolution: [▶ page 6-83](#)
- File Format: [▶ page 6-84](#)
- Blank Page Skip: [▶ page 6-138](#)



- If able to search for My Address, a [Find My Address] key will be displayed next to the address entry.



To select a function in easy mode

In "Settings (administrator)", select [System Settings] → [Common Settings] → [Operation Settings] → [Easy Mode Settings] → [Easy Scan].

To cancel the warning message displayed when switching from easy mode to normal mode

In "Settings (administrator)", select [System Settings] → [Common Settings] → [Operation Settings] → [Easy Mode Settings] → [Display a Confirmation Message when Selecting "Detail" in Easy Modes] to disable this setting.



NORMAL MODE

Normal mode lets you select any function setting that can be used for network scanner.

This section explains the keys on a base screen, taking as an example the E-mail base screen. Several methods are available in the Image Send mode, including Scan to E-mail and Scan to FTP. The base screen layout slightly differs depending on how image is sent.

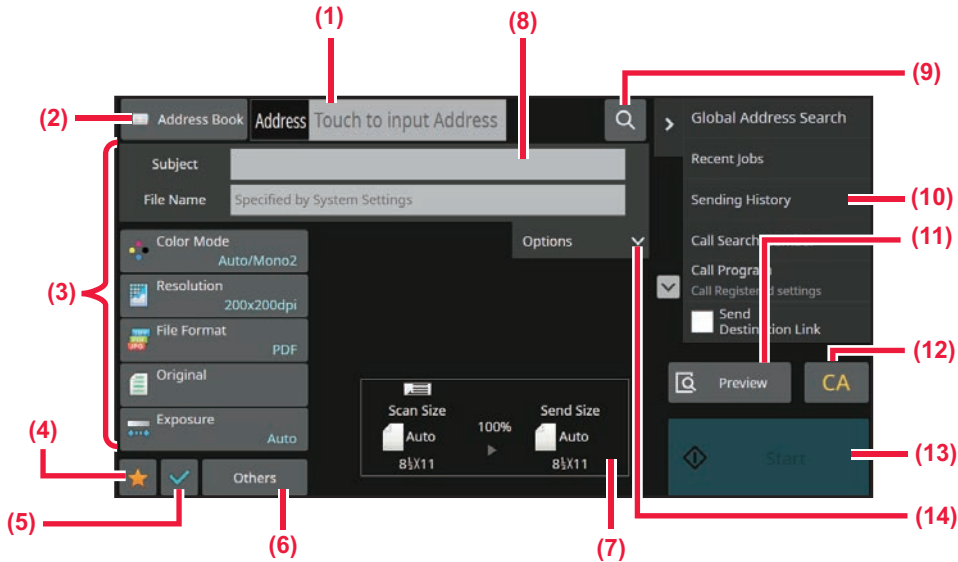

- | | |
|---|---|
| <ul style="list-style-type: none"> (1) Tap to display the soft keyboard. (2) Displays the address box to enter addresses. (3) Setting keys used for image send operations. (4) Displays the list of setting keys. Frequently used [Others], programs, and other settings can be registered. (5) Check the current settings. (6) Displays keys other than the function keys indicated above. (7) Displays the sizes of the original and the data to send. | <ul style="list-style-type: none"> (8) Enter subject, file name, and other items. (9) Searches for the address. (10) Displays the functions that can be used in image send mode. (11) Scans the original and shows a preview image. <ul style="list-style-type: none"> ► PREVIEW SCREEN (page 2-11) (12) Reset the address and settings. (13) Transmission will start immediately. (14) Enter reply address and body text. |
|---|---|

SELECTING NETWORK SCANNER MODE

Change the network scanner mode to other mode as explained in [CHANGING MODES \(page 2-10\)](#).

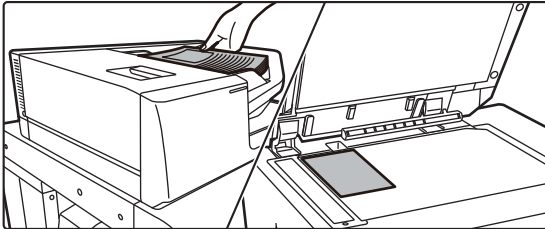

IMAGE SEND SEQUENCE

First, to place the machine in a desired image send mode, tap the appropriate icon in the Home screen.

[CHANGING MODES \(page 2-10\)](#)

1



Place the original.

Place the original in the document feeder tray of the automatic document feeder, or on the document glass.

- [AUTOMATIC DOCUMENT FEEDER \(page 1-34\)](#)
- [DOCUMENT GLASS \(page 1-38\)](#)

2

Enter the destination.

Tap the address key to directly enter the destination, or search and retrieve the address book or destination.

In Easy mode

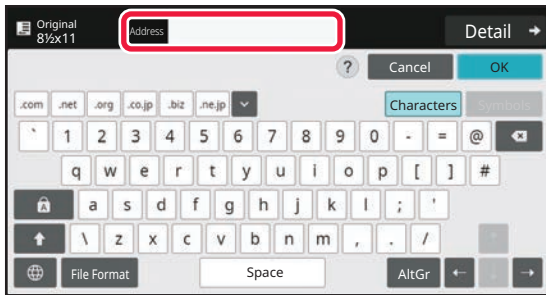

- [ENTERING AN ADDRESS MANUALLY \(page 6-38\)](#)
- [RETRIEVING A DESTINATION FROM AN ADDRESS BOOK \(page 6-33\)](#)
- [USING A TRANSMISSION LOG TO RESEND \(page 6-45\)](#)
- [RETRIEVING A DESTINATION FROM A GLOBAL ADDRESS BOOK \(page 6-41\)](#)
- [RETRIEVING A DESTINATION FROM A MOBILE ADDRESS BOOK \(page 6-43\)](#)

In Normal mode

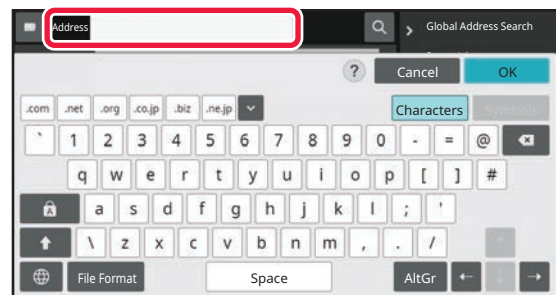

- [ENTERING AN ADDRESS MANUALLY \(page 6-38\)](#)
- [RETRIEVING A DESTINATION FROM AN ADDRESS BOOK \(page 6-33\)](#)
- [USING A SEARCH NUMBER TO RETRIEVE A DESTINATION \(page 6-37\)](#)
- [RETRIEVING A DESTINATION FROM A GLOBAL ADDRESS BOOK \(page 6-41\)](#)
- [RETRIEVING A DESTINATION FROM A MOBILE ADDRESS BOOK \(page 6-43\)](#)
- [USING A TRANSMISSION LOG TO RESEND \(page 6-45\)](#)
- [VIEWING A LIST OF THE SELECTED DESTINATIONS \(page 6-36\)](#)
- [SPECIFYING A NETWORK FOLDER \(page 6-39\)](#)



3

Select functions.

Specify the original scan size, exposure, file format, and other items.
If necessary, you can refer to the following functions for the setting.

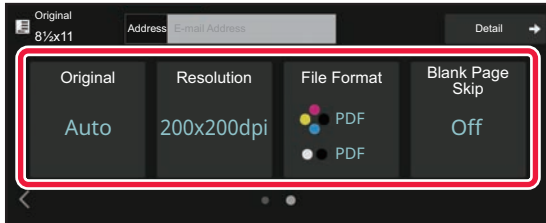
In Easy mode

[AUTOMATICALLY SCANNING BOTH SIDES OF AN ORIGINAL \(2-SIDED ORIGINAL\) \(page 6-68\)](#)
[CHANGING THE RESOLUTION \(page 6-83\)](#)
[CHANGING FORMAT IN SCAN OR DATA ENTRY MODE \(page 6-84\)](#)
[ELIMINATING BLANK PAGES FROM A TRANSMISSION \(BLANK PAGE SKIP\) \(page 6-138\)](#)

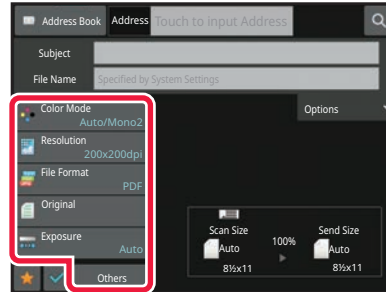
In Normal mode

[SCANNING AND SENDING ORIGINALS COLLECTIVELY \(page 6-97\)](#)
[ADJUSTING COLORS AND SHADING \(page 6-121\)](#)
[SCANNING ORIGINALS \(page 6-131\)](#)
[AUTOMATICALLY SCANNING BOTH SIDES OF AN ORIGINAL \(2-SIDED ORIGINAL\) \(page 6-68\)](#)
[SCAN SIZE AND SEND SIZE \(ENLARGE/REDUCE\) \(page 6-69\)](#)
[SPECIFYING THE ORIGINAL SCAN SIZE IN PAPER SIZE \(page 6-70\)](#)
[SPECIFYING THE ORIGINAL SCAN SIZE USING NUMERIC VALUES \(page 6-72\)](#)
[SPECIFYING THE SEND SIZE OF THE IMAGE \(page 6-79\)](#)
[CHANGING THE EXPOSURE AND ORIGINAL IMAGE TYPE \(page 6-81\)](#)
[CHANGING THE RESOLUTION \(page 6-83\)](#)
[CHANGING FORMAT IN SCAN OR DATA ENTRY MODE \(page 6-84\)](#)
[CHANGING FORMAT IN INTERNET FAX MODE \(page 6-90\)](#)
[CHANGING COLOR MODE \(page 6-90\)](#)

4

Send the original.

Tap the [B/W Start] or [Color Start] key ([Start] key in normal mode).



- You can tap the [Preview] key before tapping the [B/W Start] key or the [Color Start] key (the [Start] key in normal mode) to check a preview of the image.
- When the original is placed on the document glass, repeat the placing original and transmission procedures until all originals have been sent. After scanning all originals, tap the [Read-End] key.
- In normal mode, if you tap the [File] or [Quick File] on the action panel before sending image, you can save the scanned original as data.
[USING DOCUMENT FILING IN EACH MODE \(page 7-7\)](#)
- When the original is scanned while skewed, there is a function which automatically adjusts the skew. The automatic skew adjustment function is enabled when enabling auto configuration in easy mode. In normal mode, tap the [Others] key and then the [Original Skew Adjustment] key to switch.
[AUTOMATICALLY ADJUST SKEWED SCAN DATA \(Original Skew Adjustment\) \(page 6-142\)](#)



IF PAPER MISFEEDS IN THE AUTOMATIC DOCUMENT FEEDER

2 patterns can be set.

In "Settings (administrator)", select [System Settings] → [Image Send Settings] → [Scan Settings] → [Condition Settings] → [Quick On Line Sending].

- If enabled

When an original misfeeds, scanning stops, and scanned data up until that point is sent.

- If disabled

Even if an original misfeeds, scanning does not stop, the misfed original is set again, and scanning starts again. After all of the original has been scanned, the scanned data is sent.



ORIGINAL SIZE

TRANSMITTABLE ORIGINAL SIZES

For information on the original sizes that can be loaded, see [AUTOMATIC DOCUMENT FEEDER \(page 1-34\)](#) and [DOCUMENT GLASS \(page 1-38\)](#).

THE SIZE OF THE PLACED ORIGINAL

When a standard size original is placed, the original size is automatically detected and displayed in "Scan Size" on the based screen.

[SCAN SIZE AND SEND SIZE \(ENLARGE/REDUCE\) \(page 6-69\)](#)

Standard sizes are sizes that the machine can automatically detect. The standard sizes are set in "Original Size Detector Setting" in "Settings".



When the automatic original detection function is operating and the original (of inch or non-standard size) is placed, the closest standard size may be displayed or the original size may not appear. In this event, manually set the correct original size.

[SPECIFYING THE ORIGINAL SCAN SIZE IN PAPER SIZE \(page 6-70\)](#)

[SPECIFYING THE ORIGINAL SCAN SIZE USING NUMERIC VALUES \(page 6-72\)](#)



To specify the size that the machine can automatically detect:

Select the group of detected original sizes by selecting [System Settings] in "Settings (administrator)" → [Common Settings] → [Device Control] → [Condition Settings] → [Original Size Detector Setting].

List of original size detector settings

[DETECTABLE ORIGINAL SIZES \(page 1-32\)](#)



ADDRESS BOOK

"Contacts" and "Group" can be stored in the address book.

For a contact, more than one address can be stored, including fax, e-mail, Internet fax and direct SMTP addresses. Registering addresses stored as "Contacts" as well as directly entered addresses as "Group" enables you to easily send messages to multiple destinations simply by specifying a group.



The fax and Internet fax function may not be available depending on the country, region, or model.

Address Book

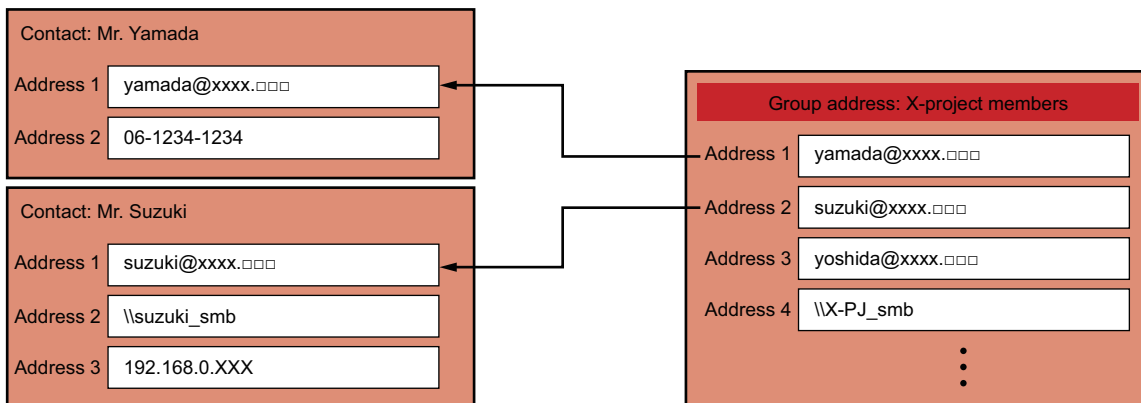

- Up to 2000 entries in all can be stored for "Contacts" and "Group".
- The address book can store up to 6000 addresses.
- One "Contacts" can store up to 500 addresses.
- One "Group" can store up to 500 addresses.
- A group that combines direct SMTP with other sending methods cannot be used for transmission.



ADDRESS BOOK SCREEN

To display the address book, tap the [Address Book] key on the base screen in image send mode such as fax, e-mail, or Internet fax. You can also display it by tapping the [Address Book] icon in the home screen. "Contacts" and "Group" registered are enabled for alphabetical search and selected condition-based advanced search.



- When the [Address Book] key is tapped on the e-mail base screen, groups and contacts having e-mail addresses are displayed.
- If user authentication is enabled, registered contacts can be shared within a specified group or stored as personal contacts that only you are allowed to access.
 - [SETTING THE SCOPE FOR PUBLICIZING CONTACTS AND GROUPS \(page 6-28\)](#)
- You can tap the [Find My Address] key while logging in and select your e-mail address from the user list. This is convenient when you want to send an e-mail to yourself.



Disable register an address book

- **Prohibiting registration from the machine**
In "Settings (administrator)", select [System Settings] → [Image Send Settings] → [Common Settings] → [Enable/Disable Settings] → [Settings to Disable Registration] → [Disable Registering Destination from Operation Panel].
- **Prohibiting registration from the web page**
In "Settings (administrator)", select [System Settings] → [Image Send Settings] → [Common Settings] → [Enable/Disable Settings] → [Settings to Disable Registration] → [Disable Registering Destination on Web Page].
- **Disable Switching of Display Order**
In "Settings (administrator)", select [System Settings] → [Image Send Settings] → [Common Settings] → [Condition Settings] → [Disable Switching of Display Order].
Disables to change the order of display (search number order, ascending, descending).
Once set, the display sequence is not changed. The display order will remain fixed at the order that is in effect when this setting is enabled.
- **The type of screen set in the initial screen of the address book is shown**
In "Settings (administrator)", select [System Settings] → [Image Send Settings] → [Common Settings] → [Condition Settings] → [Category Displayed as Default].
Select a category to be displayed with the default.
 - None
 - Frequent Use
 - Categories 1 to 32
- **Show all addresses regardless of the mode**
In "Settings (administrator)", select [System Settings] → [Image Send Settings] → [Common Settings] → [Condition Settings] → [Display all address type regardless of the mode being displayed currently].
Displays all destinations regardless of the displayed mode when this setting is enabled.
- **Enlarge the address book**
In "Settings (administrator)", select [System Settings] → [Image Send Settings] → [Common Settings] → [Condition Settings] → [Enlarge Address Book].
An enlarged address book list appears.



SELECTING "Contacts" OR "Group"

Tap a "Contacts" or "Group", and the tapped "Contacts" or "Group" is selected.
After selection, tap **OK**.

To add "Contacts" and "Group", refer to the following.

[STORING ADDRESSES THROUGH DIRECT ENTRY \(page 6-19\)](#)

[STORING ADDRESSES THROUGH GLOBAL ADDRESS SEARCH \(page 6-20\)](#)

[STORING ADDRESSES FROM FAX OR IMAGE SEND LOGS \(page 6-22\)](#)

[STORING GROUPS \(page 6-24\)](#)

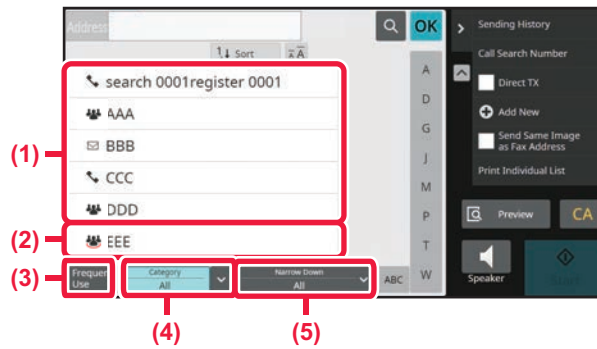

(1) One touch keys of "Contacts"

(2) One touch keys of "Group"

(3) [Frequent Use] key

(4) [Category] key

(5) [Narrow Down] key



Narrowing by frequent Use

Tap the [Frequent Use] key and select an address in the screen that appears. Addresses registered as "Frequent Use" addresses are shown.

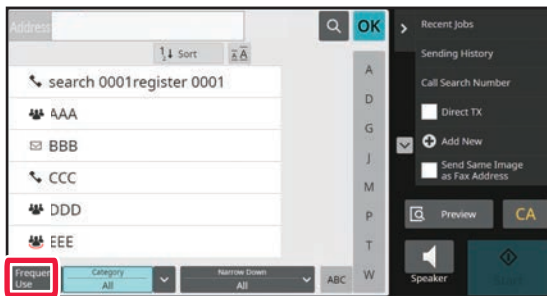

Narrowing by category

Tap the [Category] key to select a category on the screen that appears. The "Contacts" and "Group" in the selected category appear on a list. The narrowed-down condition is displayed under the [Category] key.



Narrowing by job type

Tap the [Narrow Down] key to select a job on the screen that appears. To narrow by "Group", tap the [Group] key. The "Contacts" and "Group" for the selected job appear on a list. The narrowed-down condition is displayed under the [Narrow Down] key.

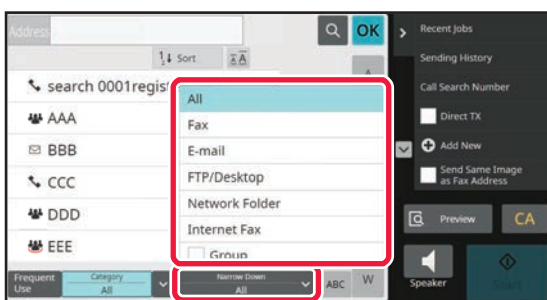



Narrowing by index

Search by alphabet to narrow down addresses.

For example, tap "A" on the index bar to display "Contacts" stored with search text starting with "A".

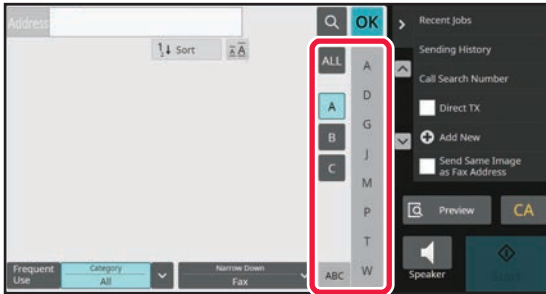

Narrowing by keyword

Tap to display a search screen. Select a target for search, enter a keyword and then tap the [Search Start] key. The search results are listed.

For example, if [Item] is [Name], search with a keyword "SH" lists contacts and groups starting with "SH".

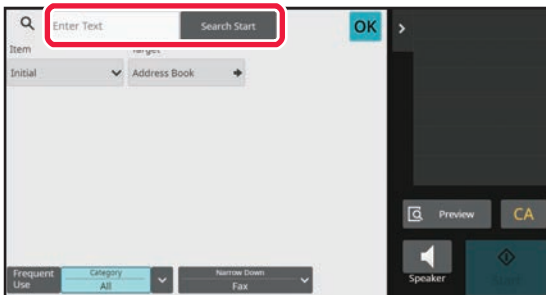

Displaying in the order of search numbers

Tapping the [Sort] key displays a list in ascending order, descending order, or in the order of search numbers.

The display is switched in the order of [Sort] (▲) (Up) → [Sort] (▼) (Down) → Search Number Order.

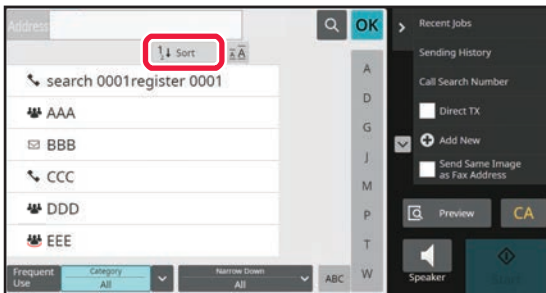



STORING ADDRESSES THROUGH DIRECT ENTRY

Store new names or addresses in the address book by directly entering them.

1

In the address book screen, tap **[Add New]** on the action panel, or tap the **[Address Control]** icon in the home screen.

2

Enter basic information.

Be sure to enter **[Name]** and **[Initial]**.

To specify a category, select one from a category list that appears when the entry box is tapped.

To register for frequent use, select the **[Also Register for Frequent Use]** checkbox .



To register a category name:

In "Settings (administrator)", select **[System Settings]** → **[Image Send Settings]** → **[Common Settings]** → **[Category Setting]**.



- If user authentication is enabled, the tab for address publication setting appears. Setting address publication enables stored "Contacts" and "Group" to be shared within a specified group or stored as personal contacts that only you are allowed to access.
- [SETTING THE SCOPE FOR PUBLICIZING CONTACTS AND GROUPS \(page 6-28\)](#)

3

Tap **[Fax Number]**, **[E-mail Address]**, **[Internet Fax Address]**, or **[Direct SMTP Address]** to enter the address, and tap **OK**.



- Select the checkbox to set that address as the preferred over the others if two or more addresses are stored for "Contacts".
- FTP, Desktop, and Network Folder addresses can be registered from **[Address Book]** in "Settings (Web version)".

4

Tap the **[Register]** key.

The first address of each address type is set as the default address. If no address has the checkbox next to it selected, a confirmation screen will appear asking you if you want to select a default address.



STORING ADDRESSES THROUGH GLOBAL ADDRESS SEARCH

Store the results of searching the global address book as new addresses in the address book.



Global address search requires an LDAP server.



Disable Destination Registration Using Global Address Search

In "Settings (administrator)", select [System Settings] → [Image Send Settings] → [Common Settings] → [Enable/Disable Settings] → [Settings to Disable Registration] → [Disable Destination Registration Using Global Address Search].

This disables address control from the global address search.

Configure the setting for each of the following items:

E-mail, Internet Fax, Fax

1

In the address book screen, tap [Add New] on the action panel, or tap the [Address Control] icon in the home screen.

2

Enter basic information.

Be sure to enter [Name] and [Initial].

To specify a category, select one from a category list that appears when the entry box is tapped.

To register for frequent use, select the [Also Register for Frequent Use] checkbox .



To register a category name:

In "Settings (administrator)", select [System Settings] → [Image Send Settings] → [Common Settings] → [Category Setting].



If user authentication is enabled, the tab for address publication setting appears. Setting address publication enables stored "Contacts" and "Group" to be shared within a specified group or stored as personal contacts that only you are allowed to access.

[SETTING THE SCOPE FOR PUBLICIZING CONTACTS AND GROUPS \(page 6-28\)](#)

3

Tap the [Global Search] key.



4

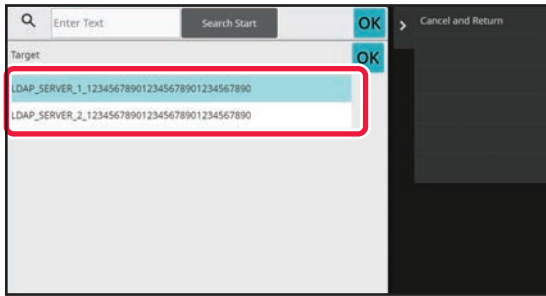

Select the server from the list of servers.

If an authentication screen appears, enter your user name and password, and tap the [OK] key.
After selecting a server, tap **OK**.

5

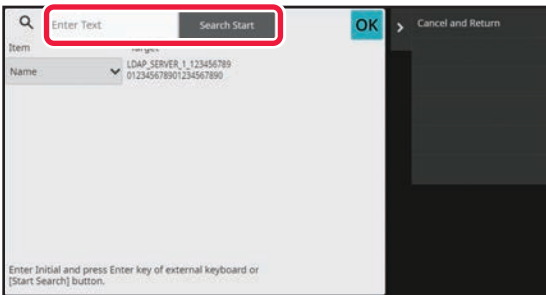

Tap the entry field to enter the search condition and then tap the [Search Start] key.

To change the search target, tap for [Item]. You can select [Name] or [Address].

6

Select one address from the search result list, and tap the **OK** key.



To check address information, select the address and tap the [Confirm Registered Information] key.

7

Tap the [Register] key.

The first address of each address type is set as the default address. If no address has the checkbox next to it selected, a confirmation screen will appear asking you if you want to select a default address.



STORING ADDRESSES FROM FAX OR IMAGE SEND LOGS

As a new registration, add an address you have entered via fax or image send operations to the address book.



FTP and desktop addresses cannot be stored in the address book from transmission logs.

1

In fax or image send mode, tap [Sending History] on the action panel.

2

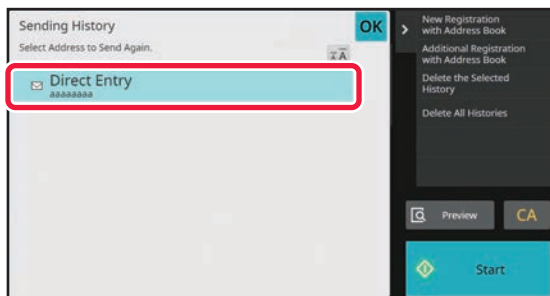

Select one address you want to register in the address book from the send logs, and then tap [New Registration with Address Book] on the action panel.



When you tap [Additional Registration with Address Book] on the action panel, you can add the address to a contact stored in the address book.

3

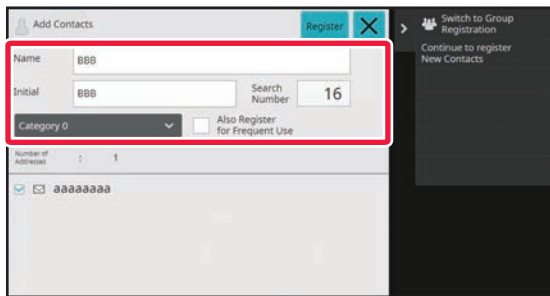

Enter basic information.

Be sure to enter [Name] and [Initial].

To specify a category, select one from a category list that appears when the entry box is tapped.

To register for frequent use, select the [Also Register for Frequent Use] checkbox .



If user authentication is enabled, the tab for address publication setting appears. Setting address publication enables stored "Contacts" and "Group" to be shared within a specified group or stored as personal contacts that only you are allowed to access.

[SETTING THE SCOPE FOR PUBLICIZING CONTACTS AND GROUPS \(page 6-28\)](#)



To register a category name:

In "Settings (administrator)", select [System Settings] → [Image Send Settings] → [Common Settings] → [Category Setting].

4

Tap the [Register] key.

The address is registered in the address book and the transmission log screen is restored.

The first address of each address type is set as the default address. If no address has the checkbox next to it selected, a confirmation screen will appear asking you if you want to select a default address.



5

Tap the [OK] key.



STORING GROUPS

Register "Group" by selecting addresses from those already stored as "Contacts". In this case of registration, only reference to addresses already stored takes place, and so, the total number of registered addresses (maximum 6000) in the address book does not increase. You can also directly enter a new address for a "Group".

1 In the address book screen, tap [Add New] on the action panel, or tap the [Address Control] icon in the home screen.

2

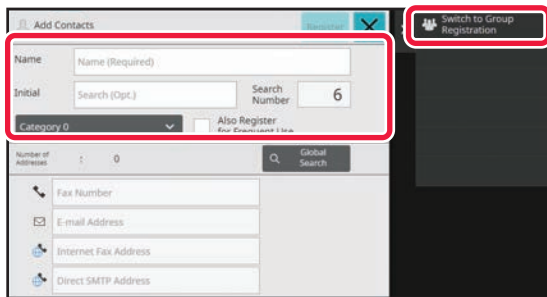

Enter the basic information, and tap [Switch to Group Registration] on the action panel.

3

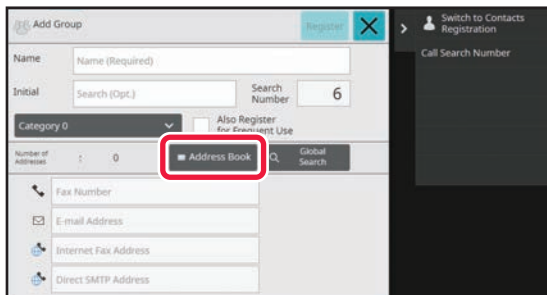

Tap the [Address Book] key.



To directly enter a new address for a "Group", tap [Fax Number], [E-mail Address], [Internet Fax Address], or [Direct SMTP Address].

4

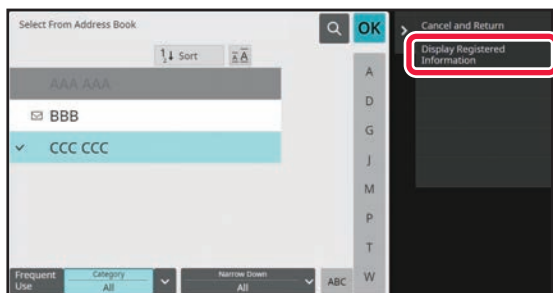

In the contact list, tap the "Contacts" that includes the address you want to add to the "Group", and tap [Display Registered Information] on the action panel.



5

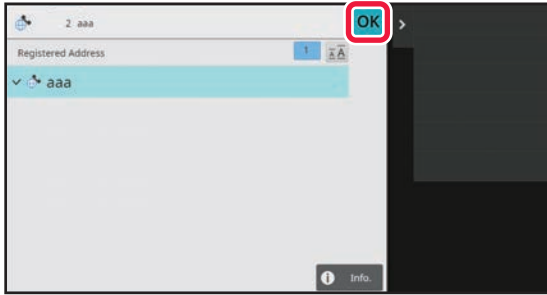

Tap the address to be registered in the "Group", and then tap the **OK** key.

You can select more than one address.

6

Repeat steps 3 through 5 to register addresses. After address registration is completed, tap **OK** key.

7

Tap the [Register] key.



EDITING/DELETING ADDRESSES IN ADDRESS BOOK

You can edit or delete "Contacts" or "Group" information stored in the address book as well as addresses listed under "Contacts" and "Group".

EDITING/DELETING CONTACTS AND GROUPS

1

In the address book screen, select a contact or group you wish to edit, and tap [Edit] on the action panel.

To delete a "Contacts" or "Group", tap [Delete] on the action panel.



- For editing, you can only select one "Contacts" or "Group" at a time.
- For deleting, you can select more than one "Contacts" or "Group" at a time.
- If you have logged in as the administrator, you can delete all addresses stored in the address book by tapping the [Delete All] that appears on the action panel.

2

The screenshot shows the 'Add Contacts' screen. It has a title bar with 'Add Contacts' and a 'Register' button with a close icon. Below the title bar are several input fields: 'Name' with 'AAA', 'Initial' with 'A', and 'Search Number' with '6'. There is a 'Category 0' dropdown menu and a checkbox for 'Also Register for Frequent Use'. Below these is a 'Number of Address' field with '1' and a 'Global Search' button. At the bottom, there is a phone number field with '123456789' and a 'Detail' button. At the very bottom, there is an 'Add' button and a row of icons for 'Fax', 'E-mail', 'Internet Fax', and 'Direct SMTP'. On the right side of the screen, there is a dark overlay with the text 'Continue to register New Contacts'.

Editing a "Contacts" or "Group"

- You can change basic information such as names and categories and also you can add addresses.
[STORING ADDRESSES THROUGH DIRECT ENTRY \(page 6-19\)](#)
[STORING ADDRESSES THROUGH GLOBAL ADDRESS SEARCH \(page 6-20\)](#)
[STORING ADDRESSES FROM FAX OR IMAGE SEND LOGS \(page 6-22\)](#)
[STORING GROUPS \(page 6-24\)](#)
- You can change the publicity scope.
[SETTING THE SCOPE FOR PUBLICIZING CONTACTS AND GROUPS \(page 6-28\)](#)



EDITING/DELETING ADDRESSES

1

Select a contact or group you wish to edit, and tap [Edit] on the action panel. In the address book screen, select the contact or group that has the address you want to edit, and tap [Edit] on the action panel.

Only one contact or group can be selected. If more than one is selected, the [Edit] key does not appear.

2

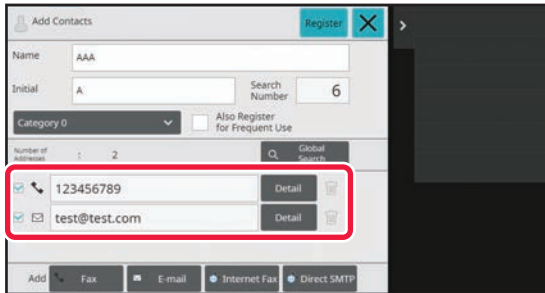

Tap the address display in the list of addresses.

To delete an address, tap the  key.



- To edit or delete, you can only select one address at a time.
- To check address information, tap the [Detail] key.



You cannot edit or delete an address for a job in a job queue.

3

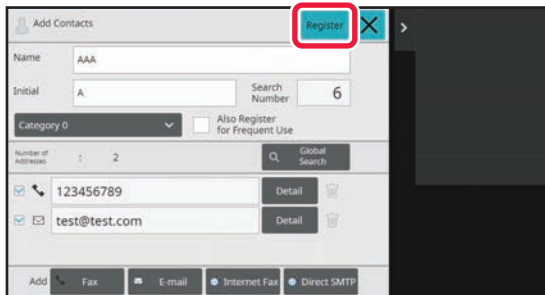

Edit an address.

After editing, tap the [Register] key.

4

Tap the [OK] key.



You can only edit addresses in the network folder on the edit screen. (The Add New screen cannot be displayed.)



SETTING THE SCOPE FOR PUBLICIZING CONTACTS AND GROUPS

"Contacts" and "Group" stored in the address book can be shared within a specified group or stored as personal contacts that only you are allowed to access.

If no publicity scope is specified, stored "Contacts" and "Group" are publicized to all users.



User authentication is required to set the scope for publicizing "Contacts" and "Group".

Scope for publicizing addresses	Description
Publicized to all	"Contacts" and "Group" are published to all users of the machine.
User	"Contacts" and "Group" are published only to the user. Registered addresses are preferentially displayed as "Personal Contacts" in the user's address book.
User Group	Publication of "Contacts" and "Group" is limited to the specified group. Up to eight groups per "Contacts" or "Group" can be set as the publicity scope.

1

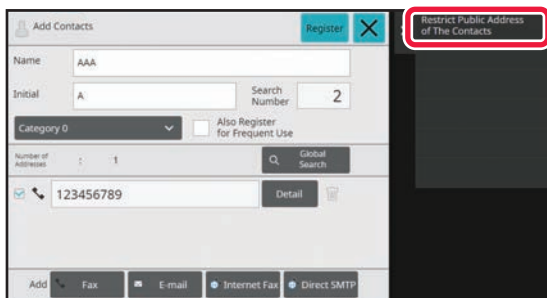

In the address registration screen, tap [Restrict Public Address of The Contacts] on the action panel.

2

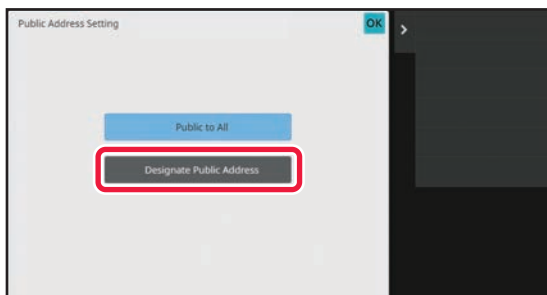

Tap the [Designate Public Address] key.

3

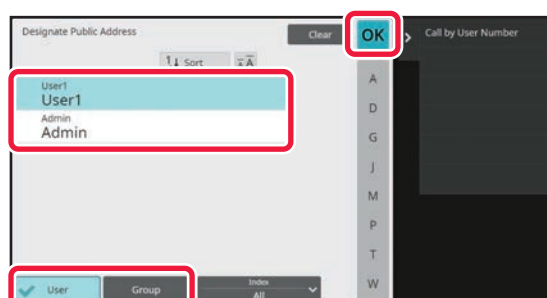

Tap [User] or [Group] and specify who the address is made public to.

After the settings are completed, tap **OK**.



If you have logged in as the administrator, select any user name desired from the user list.



To register a user:

In "Settings (administrator)", select [User Control] → [User Settings] → [User List] → [Add].

DELETING THE TRANSMISSION HISTORY

You can delete the fax or image send transmission history.



The transmission history is deleted in normal mode.

DELETING A SELECTED HISTORY

1

Tap the history you want to delete.

2

In the transmission log screen, tap [Delete the Selected History] on the action panel.

3

The message "Delete the Selected History?" will appear, tap the [Delete] key.
The selected transmission log is deleted.

DELETING ALL TRANSMISSION HISTORIES

1

In the transmission log screen, tap [Delete All Histories] on the action panel.

2

The message "Delete All Histories" will appear, tap the [Delete All] key.
All transmission logs are to be deleted.



REGISTER AN ADDRESS BOOK IN THE WEB PAGE

Address Book

Transmission destinations (contacts) such as fax and Scan to E-mail addresses, and groups of transmission destinations, can be stored in the address book. In setting mode, a list of stored contact and group information is displayed.

To edit a contact or group, select the name of the contact/group. To add a new contact or group, click the [Add] key.

Item	Description
Type	Select the contact or group.
Search Number	Store a number that can be used to search for a contact or group.
Address Name	Store a name for an address.
Initial	Store an initial that can be used to search for a contact or group.
Category	Enter a category for a contact or group.
Register this Address to be added to the [Frequent Use] index.	Add a contact to the "Frequent Use" index.
Address Public Setting	Set whether the address will be shared with all users or only selected users. If you select [Select user], click the user selection buttons to select the users with whom the address will be shared.
Share also to the following group	When this function is enabled, you can select a previously stored group from the list below and share the address with that group.
E-mail	
E-mail Address	To store a new address, select [New Address] and enter the address in the address entry field.
Global Address Search	To search for an address stored as a global address, click this key and select the address from the list.
File Type*	Select the file format used for a scanned image. Black & white: Select the compression format used for saving black & white images. Color/Grayscale: Select the compression format used for saving color/grayscale images. If the original is mainly text with a small number of colors, select "Reduce Colors" to scan with the appropriate settings and reduce the file size.
Set as Default used	Set an address as a default address.
Fax	
Fax Number	To store a new fax number, select [New Address] and enter the fax number in the fax number entry field.
Global Address Search	To search for a fax number stored as a global address, click this key and select the fax number from the list.
Transmission Mode	Select the communication speed and International Correspondence Mode.
Set as Default used	Set an address as a default address.



Item	Description
Internet Fax	
Internet Fax Address	To store a new address, select [New Address] and enter the address in the address entry field.
Global Address Search	To search for an address stored as a global address, click this key and select the address from the list.
Compression Mode	Set the compression format used for transmitted images.
Request Internet Fax Reception Report	Select whether or not you wish to receive a reception report by e-mail after transmission is completed.
Set as Default used	Set an address as a default address.
Direct SMTP	
Direct SMTP Address	To store a new address, select [New Address] and enter the address in the address entry field.
Add Hostname or IP Address.	When the receiving machine is set to only receive e-mail from specific addresses, enter the specified specific e-mail address in the [Direct SMTP Address] text box. Select the "Add Hostname or IP Address." checkbox and enter the host name or IP address of the receiving machine in the [Hostname or IP Address] text box. Example: When the e-mail address of the receiving machine is "user@sample_domain.com" and the IPv4 address is "192.168.123.45" Enter "user@sample_domain.com" in the [Direct SMTP Address] text box and enter "192.168.123.45" in the [Hostname or IP Address] text box.
Compression Mode	Set the compression format used for transmitted images.
Set as Default used	Set an address as a default address.
FTP	
FTP Address	To add a new address, select [New Address] and enter the address in [Hostname or IP Address].
Port Number	Set the port number used by the FTP server.
File Type*	Select the file format used for a scanned image. Black & white: Select the compression format used for saving black & white images. Color/Grayscale: Select the compression format used for saving color/grayscale images. If the original is mainly text with a small number of colors, select "Reduce Colors" to scan with the appropriate settings and reduce the file size.
Directory	Specify a directory in the FTP server to be used for transmission.
User Name	Enter a user name in the FTP server to be used for transmission.
Password	Enter the password associated with the entered user name.
Enable SSL	Use SSL/TLS to encrypt data before transmission.
Use PASV mode	Send data to an FTP server in PASV mode.
Enable Hyperlink to FTP server to be e-mailed	When sending data to an FTP server, send the data to the e-mail address that is specified in the hyperlink to the FTP server.
Set as Default used	Set an address as a default address.



Item	Description
Desktop	
Desktop Destination	To add a new address, select [New Address] and enter the address in [Hostname or IP Address].
Port Number	Enter the port of the destination computer.
Process Directory	Specify the directory to which the data is be to sent.
File Type*	Select the file format used for a scanned image. Black & white: Select the compression format used for saving black & white images. Color/Grayscale: Select the compression format used for saving color/grayscale images. If the original is mainly text with a small number of colors, select "Reduce Colors" to scan with the appropriate settings and reduce the file size.
User Name	Enter a user name in the computer to be used for transmission.
Password	Enter the password associated with the entered user name.
Enable SSL	Use SSL/TLS to encrypt data before transmission.
Set as Default used	Set an address as a default address.
Network Folder	
Network Folder Path	To store a new path, select [New Address] and enter the path in the path entry field.
User Name	Enter a user name in the computer to be used for transmission.
Password	Enter the password associated with the entered user name.
File Type*	Select the file format used for a scanned image. Black & white: Select the compression format used for saving black & white images. Color/Grayscale: Select the compression format used for saving color/grayscale images. If the original is mainly text with a small number of colors, select "Reduce Colors" to scan with the appropriate settings and reduce the file size.
Enable Hyperlink to Network Folder to be e-mailed	When sending data to a shared folder, send the data to the e-mail address that is specified in the hyperlink to the shared folder.
Set as Default used	Set an address as a default address.

* Depending on the model and upon installation of peripheral devices, High Compression PDF may be selected. When [OCR] is enabled, text in the scanned data is automatically recognized. For PDF, the text information is embedded in the PDF. For PDF, RTF, TXT(UTF-8), DOCX, XLSX, or PPTX, the recognized text is saved in the corresponding format.

Category Setting

A category can be renamed for greater ease of use.

Delete the previously entered characters and enter a new name (up to 127 characters).

The factory default names are "Category 1" to "Category 32".



ENTERING DESTINATIONS

ENTERING DESTINATIONS

RETRIEVING A DESTINATION FROM AN ADDRESS BOOK

In the address book screen, simply tap the one-touch key of a registered destination to retrieve the destination. If necessary, store multiple destinations in a one-touch key. Tapping the key will retrieve all the stored destinations. The address book screen shows all destinations used in each mode. Each one-touch key shows the name of the destination and an icon indicating the mode used for the destination.

	Fax
	Scan to E-mail
	Internet Fax
	Direct SMTP
	Scan to FTP
	Scan to Network Folder
	Scan to Desktop
	Group key with multiple destinations

- For information on the address book, see "[CHANGING MODES \(page 2-10\)](#)".
[ADDRESS BOOK \(page 6-14\)](#)
- For the procedure for storing the destinations in the address book, see "[STORING ADDRESSES THROUGH DIRECT ENTRY \(page 6-19\)](#)", "[STORING ADDRESSES THROUGH GLOBAL ADDRESS SEARCH \(page 6-20\)](#)", and "[STORING GROUPS \(page 6-24\)](#)".

1

Tap the [Address Book] key.

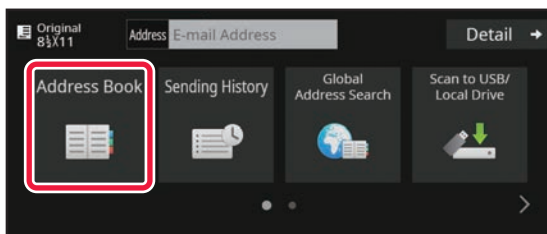
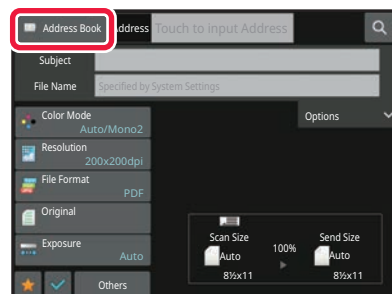
In Easy mode**In Normal mode**

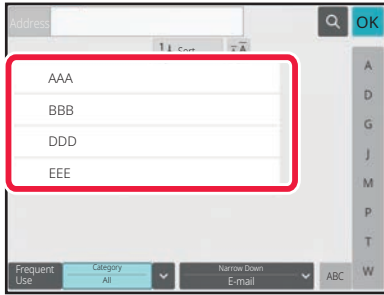

2

**Tap the one-touch key of contact or group that has a destination.**

- The destinations displayed on the list can be narrowed with categories, frequent use, indexes, and keywords. (In normal mode you can narrow down by job type.)
- Tapping the [Sort] key allows you to change the order of destinations displayed in the list.
- When adding a destination, tap another one-touch key.
- If two or more destinations are selected or specified, the total number of addresses appears next to address.
- Even if only a single destination is selected, the number of addresses appears when the destination is a contact or group in which multiple addresses are stored.
- For more information, see "[ADDRESS BOOK SCREEN \(page 6-15\)](#)".

**If you select an incorrect destination:**

Tap the key again to cancel the selection.



- To select a destination from the transmission log, tap the [Sending History] key.
[USING A TRANSMISSION LOG TO RESEND \(page 6-45\)](#)
- To check the entered destinations, tap the [Address Review] key.
[VIEWING A LIST OF THE SELECTED DESTINATIONS \(page 6-36\)](#)
- The destination for transmission can be selected by tapping a stored destination.
- If an address that you do not have permission to use is included in the addresses, a message will appear when you press the [Start] key. To send only to the permitted addresses, press the [OK] key and then the [Enter for send] key.

In Normal mode

- Tap the one-touch key, and then tap [Display Registered Information] on the action panel to display the detailed information screen.
- To retrieve a destination by using a search number, tap [Call Search Number] on the action panel.
[USING A TRANSMISSION LOG TO RESEND \(page 6-45\)](#)
- To retrieve a destination from a global address book, tap [Global Address Search] on the action panel.
[RETRIEVING A DESTINATION FROM A GLOBAL ADDRESS BOOK \(page 6-41\)](#)
- To retrieve a destination from the address book of the mobile device, tap [Refer to Mobile Address Book] on the action panel.

**To cancel a specified destination:**

Select the address you want to cancel in the address list screen, and tap the [Delete] key.

**To enable transmission to addresses of modes other than the current mode:**

Remove the checkmark from [System Settings] → [Image Send Settings] → [Common Settings] → [Condition Settings] → [Address Book Default Selection] → [Apply Addresses of Sending Modes Only] in "Settings (administrator)".



MY ADDRESS

My Address is the user's own e-mail address, and is the e-mail address that has been registered in the user list.

My Address can be used when login by login name / password is enabled in user authentication.

Use this address when you want to send a scanned image to your own e-mail address.

In E-mail mode, [Find My Address] appears on the action panel to let you immediately find and use My Address.

When you use the address book in easy scan screen or E-mail mode, the [Find My Address] button also appears at the top of the user list for easy access from the address book.



- My Address cannot be used in the following instances:
 - When address search from the user list is prohibited in the system settings
 - When user authentication is disabled, or is only by user number
 - When [Apply E-mail address of the user for login.] is enabled in [Default Address]
 - When the e-mail address of the logged in user has not been registered
 - After the [Next Address] key is pressed when [Be sure to press Next Address Key ([+]) before selecting the next address.] is enabled in System Settings - [Image Send Settings] → [Common Settings] → [Condition Settings]
 - When [S/MIME Settings] → [Disable sending to the addresses which cannot be encrypted.] is enabled in the security settings
- You can register [Find My Address] in the home screen. This is convenient when you frequently use My Address.



VIEWING A LIST OF THE SELECTED DESTINATIONS

When multiple destinations have been selected, you can display and check the destinations. You can also delete a destination from the list (cancel selection of the destination).

1

Tap the [Address Review] key.

In Easy mode

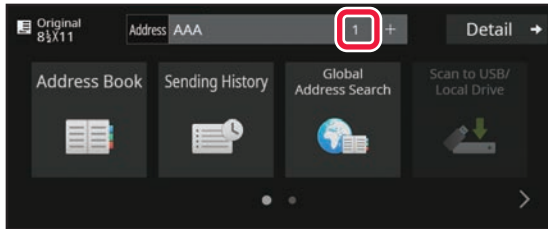

In Normal mode

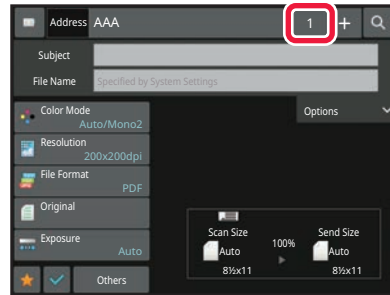

2

Confirm the destination.

After the confirmation is completed, tap **OK**.

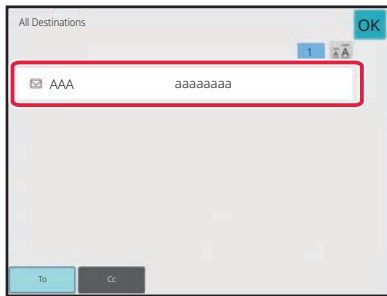

To confirm detailed information such as the type or name of the specified destination, tap the one-touch key of the target destination, and then tap the [Info.] key.

In normal mode, you can change the delivery type (To/Cc/Bcc). Tap the address and then tap [Change to To], [Change to Cc], or [Change to Bcc] on the action panel.

Deleting Specified Destinations

In step 2 of "VIEWING A LIST OF THE SELECTED DESTINATIONS", select the destination and tap the [Delete] key.

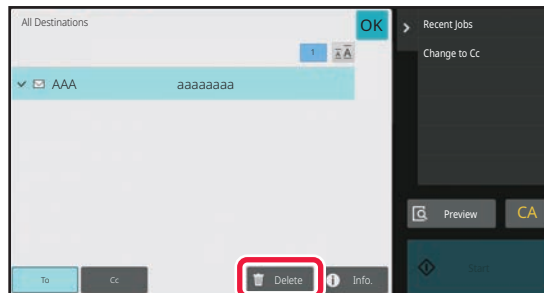

If you placed the original on the document glass and tapped the [Start] key, you cannot delete an address when changing settings.



USING A SEARCH NUMBER TO RETRIEVE A DESTINATION

The search number can be used to specify a destination stored in an address book.

1

Tap the [Detail] key to change to normal mode.

[EASY MODE \(page 6-7\)](#)

2

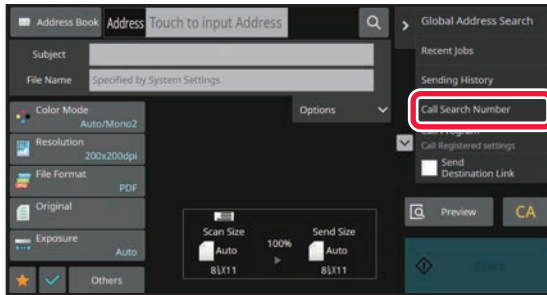

Tap [Call Search Number] on the action panel.

3

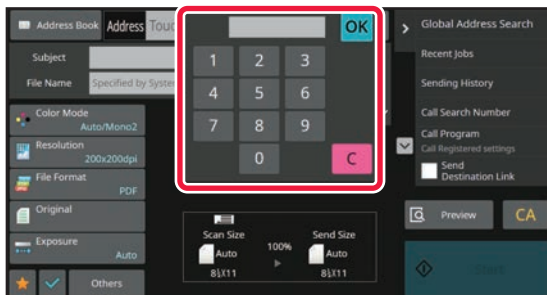

Enter a search number (4 digits) using the numeric keys and tap **OK**.

When the search number is entered, the stored address is retrieved and specified as a destination.



If an incorrect search number is entered:

Tap the [C] key to clear the number and enter the correct number.



- The search number is programmed when the destination is stored in the address book.
- If you do not know the search number, tap [Print Individual List] on the action panel to print and check the address list.
- When entering search numbers such as "0001" and "0011", "0" can be omitted. For example to enter "0001", enter "1" and tap the [OK] key.



ENTERING AN ADDRESS MANUALLY

1

In the base screen of a mode, tap [Text Box].

On the base screen of Internet Fax, tap [Text Box] to display the screen you want to select the address type. Tap either the [Internet Fax] or [Direct SMTP] key.

In easy mode, only the e-mail addresses can be entered.

In Easy mode

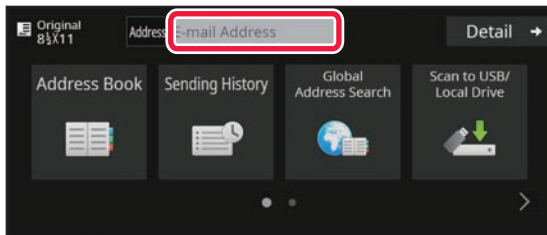

In Normal mode

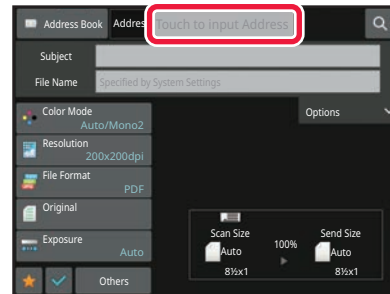

2

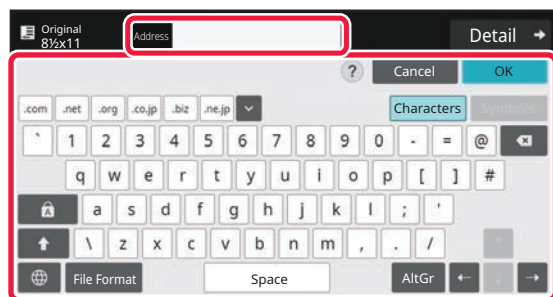

Enter the destination address on the soft keyboard that appears.

- In data entry mode, select the mode of the destination, and enter the destination address.
- For Scan to Network Folder mode, the network folder entry screen appears. See "[SPECIFYING A NETWORK FOLDER \(page 6-39\)](#)".
- After entering the destination address, tap the [OK] key to close the soft keyboard.



- For details on how to enter characters, refer to "[CHARACTER ENTRY \(page 2-62\)](#)" in "How to operate this machine".
- You can select [Bcc] if [Image Send Settings] → [Scan Settings] → [Default Settings] → [Bcc Setting] → [Enable Bcc] is enabled in [System Settings].
- When you want to display Bcc address on the job status screen or address list tab, [Image Send Settings] → [Scan Settings] → [Default Settings] → [Bcc Setting] → [Display Bcc Address on the Job Status Screen] is enabled in [System Settings].
- In Internet Fax mode, the transmission confirmation request setting screen will appear if [System Settings] - [Image Send Settings] → [Internet Fax Settings] → [Send Setting] → [I-Fax Reception Report On/Off Setting] is enabled. To request confirmation, tap the [Set] key. To cancel, tap the [Cancel] key. (When Direct SMTP is used, transmission confirmation is not performed.)



SPECIFYING A NETWORK FOLDER

1

Tap the [Browse] key in the network folder entry screen.

- To directly enter a folder, tap the [Folder Path] box. The soft keyboard is displayed.
- If a user name and password are required, check with the administrator of the server and enter the user name and password.



- For details on how to enter characters, refer to "[CHARACTER ENTRY \(page 2-62\)](#)" in "How to operate this machine".
- If a user authentication function other than authentication by user number is enabled, the login name of the current user is automatically entered in the user name field.
- If user authentication is not set and a network folder which has different passwords for each user is selected as the destination, a screen to enter a user name and password can be displayed at the time of sending. Configure in "Settings (administrator)" → [System Settings] → [System Control] → [Advanced Settings].
- Enter a password with up to 255 single-byte characters.

2

Tap the key of the workgroup that you wish to access.



- Tap the [Search] key and enter a keyword to search for a workgroup, server, or network folder.
- Up to 100 workgroups, 100 servers, and 100 network folders are displayed.
- Tap the [Cancel] key to return to the screen of step 1.

3

Tap the key of the server or computer that you wish to access.

If a screen appears prompting you to enter a user name and password, check with your server administrator and enter the appropriate user name and password.

4

Tap the key of the network folder.

After the settings are completed, tap the [OK] key. You will return to the screen of step 1. Tap the [OK] key again to accept the destination.



SELECTING A SUBFOLDER AS A DESTINATION

If there is only one shared folder selected as the destination, tapping [Select a Subfolder] changes the destination to the subfolder.



- If the destination is changed to a subfolder, hyperlink e-mail transmission will not take place.
- If a selected destination is a group destination, this function cannot be used.
- If [Send and Print] of the copy function is set, this function cannot be used.
- If [Disable Selection from Address Book] or [Disable Direct Entry] in "Settings (administrator)" → [System Settings] → [Device Control] → [Enable/Disable Settings] → [Settings to Disable Transmission] is prohibited, this function cannot be used.
- If [Approval Settings for Each Mode], [Approval Setting for Direct Entry], or [Approval Setting to Use a Local Address Book] in "Settings (administrator)" → [System Settings] → [User Control] → [Authority Group] is prohibited, this function cannot be used.



RETRIEVING A DESTINATION FROM A GLOBAL ADDRESS BOOK

When an LDAP server is configured in the "Settings (Web version)", look up an address in a global address book and retrieve the destination address for Scan to E-mail or Internet fax transmission (excluding Direct SMTP addresses). In normal mode, you can add an address retrieved by searching to the address book. However, addresses of the FTP/Desktop transmission cannot be stored from the machine.

1 In Easy mode

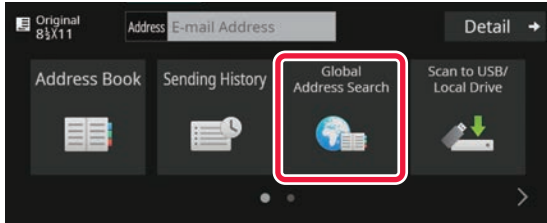

Tap the [Global Address Search] key.

In Normal mode

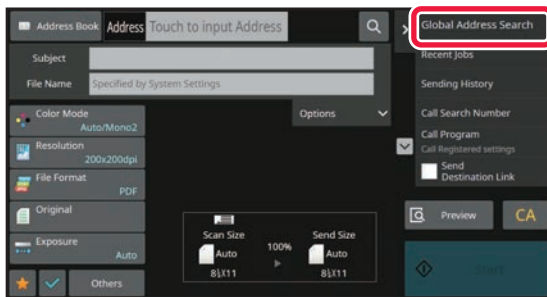

In the base screen or address book screen, tap [Global Address Search] on the action panel.

2

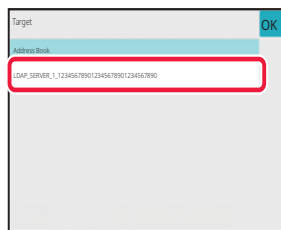

Tap [Destination] and tap the LDAP server to be used.

- If an authentication screen for the LDAP server appears, enter your user name and password.
- If only one LDAP server has been stored, it is not necessary to take step 2. In this case, start from step 3.



3



Tap of [Item], and select an item to be searched from [Name] or [Address].



How to search

- Enter the search characters (maximum of 64 characters). The system will look for names starting with the entered letters.
- An asterisk * is used as follows:
 - XXX* : Names beginning with "XXX"
 - *XXX : Names that end with "XXX"
 - *XXX* : Names containing "XXX"
 - AA*XX : Names that start with "AA" and end with "XX".

4

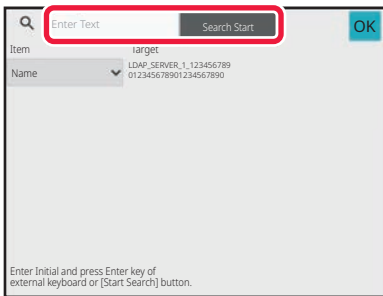

Enter a keyword and tap the [Search Start] key.

When you tap the keyword entry box, the soft keyboard appears. The search results will appear after a brief interval.



- **If no destination is found:**
Tap the [Search Again] key to add more search letters.
- **To continuously add other destination.**
Tap the destination.



To check the destination information:

Tap the one-touch key of the target destination, and then tap the [Info.] key. Tap to close the address information screen. In normal mode, you can select an address and tap [New Registration with Address Book] on the action panel to add the address to the address book. This is convenient if you have entered a destination directly.



RETRIEVING A DESTINATION FROM A MOBILE ADDRESS BOOK

If the machine and mobile device are connected by Bluetooth, you can retrieve a destination from the mobile address book.

Destinations for fax transmission and e-mail transmission can be retrieved.



- The called address book is not saved in this machine.
- The maximum number of addresses that can be read from the mobile address book is 2000.
- For more information about the operation of mobile devices, please refer to the operation manual/help of the mobile device.



To use this function

Enable "Settings (administrator)" → [Network Settings] → [Bluetooth Setting] → [Bluetooth] to pair the machine and mobile device.

1

In Easy mode

Tap the [Mobile Address Book] key.

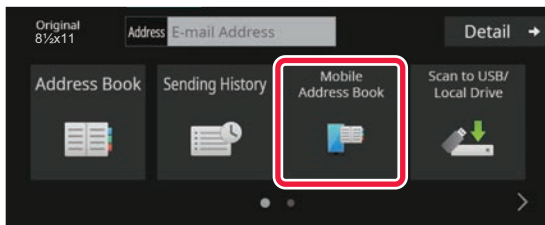

In Normal mode

In the base screen or address book screen, tap [Refer to Mobile Address Book] on the action panel.

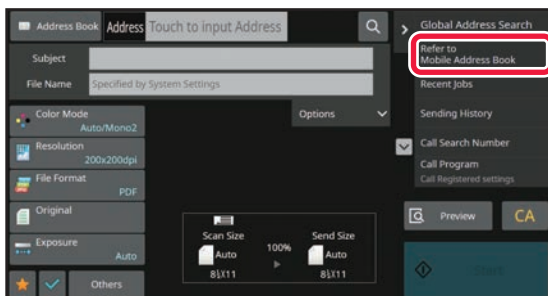



2

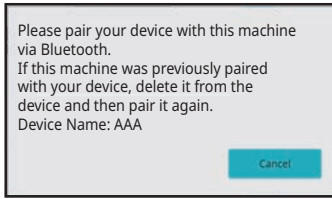

Operate the mobile device to be connected to pair it with the machine.

Device name of the machine is displayed on the screen.



When pairing with a mobile device that has been paired with this unit before, delete the information of this unit stored in the mobile device.

To set a device name to this machine

Configure in "Settings (administrator)" → [System Settings] → [Network Settings] → [Network Name Setting] → [Device Name].

The device name must be in 7 or less double-byte characters, or 15 or less single-byte characters.

3

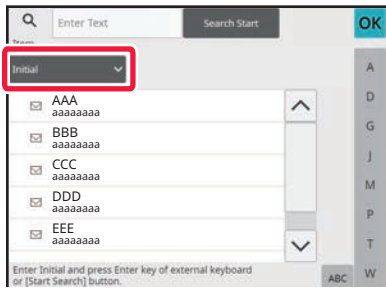

Tap (▼) of [Item], and select an item to be searched from [Initial], [Name] or [Address].

4

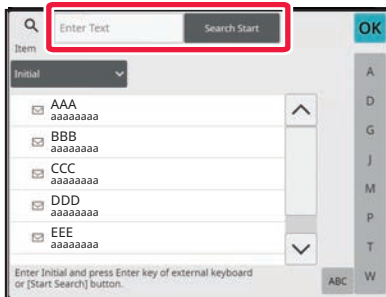

Enter a keyword and tap the [Search Start] key.

When you tap the keyword entry box, the soft keyboard appears.

The search results will appear after a brief interval.



- **If no destination is found:**
Tap the [Search Again] key to add more search letters.
- **To continuously add other destination.**
Tap the destination.



USING A TRANSMISSION LOG TO RESEND

Select a destination from a transmission log and resend the data.

The destinations of the most recent 50 transmissions by Scan to E-mail, Internet fax (including Direct SMTP addresses), and/or fax are stored. Select one of these to resend to that destination. The destinations of the FTP/Desktop transmission and Scan to Network Folder are also shown in the transmission log.

In normal mode, the addresses shown in the transmission log can also be stored in an address book. This is convenient when storing an address that was manually entered.



- When a destination for retransmission is selected in the transmission log screen, the mode of the selected destination is automatically selected.
- The following types of addresses are not stored for resending.
 - One-touch key for a contact or group in which multiple destinations are stored.
 - Group destinations
 - Broadcasting destinations
- The user name and password are not stored for security reasons. If a screen requiring you to enter such information appears, enter the information again.

1

In Easy mode

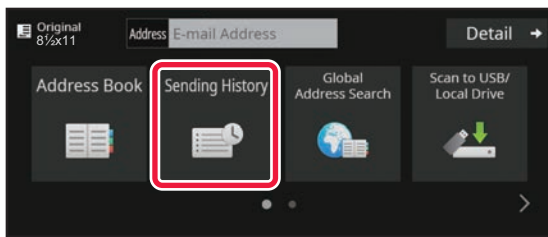

Tap the [Sending History] key

In Normal mode

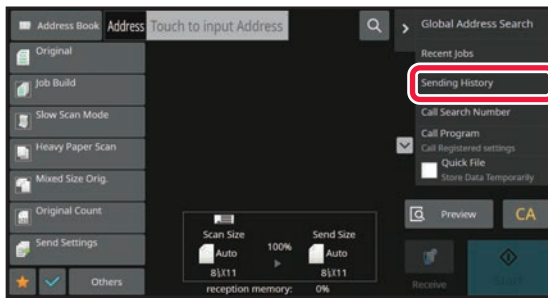

In the base screen or address book screen, tap [Sending History] on the action panel.



2

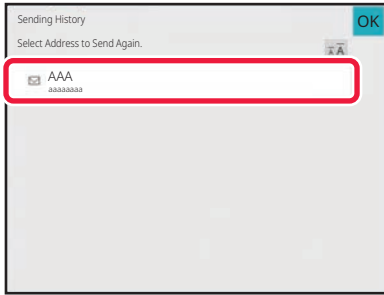

Tap the key of the destination to resend.

The last 50 addresses used for transmission are displayed. If a screen requiring you to enter the user name and password appears, enter the information.



To cancel the resend setting:

Tap the highlighted key.



In normal mode, you can select an address and tap [New Registration with Address Book] on the action panel to add the address to the address book. This is convenient if you have entered a destination directly.



SENDING ONLY THE URL OF A SCANNED FILE TO A SCAN DESTINATION

When using Scan to E-mail, some originals and/or scan settings may result in a large file.

When the file is large, there is a risk that the e-mail server may reject the file and it will not be sent.

This function saves the scanned file on the machine's local drive, and sends an e-mail providing only the file's URL information to the recipient.

This function helps reduce the load on the e-mail server and prevents non-delivery of scanned files caused by the e-mail server.

Upon receiving the e-mail, the recipient can use the URL in the e-mail to download the scanned file.

When the scanned file is too large

Scan to E-mail

Scanned file



Sending the file as an e-mail attachment

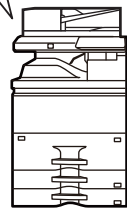

The attachment is too large and the e-mail server rejects the e-mail

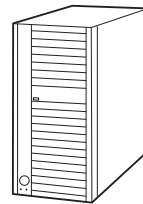

Sending fails



Destination

E-mail server

Sending only a URL to the recipient

Scanned file

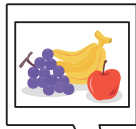

Save to the machine's local drive

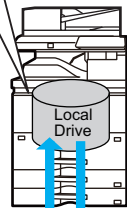

Send the URL of the save location by e-mail

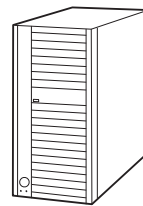

The e-mail arrives at the destination



Destination

E-mail server

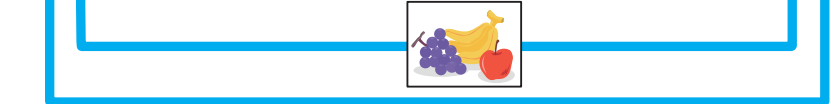

The recipient uses the URL in the e-mail to download the scanned file



Sending only a URL to the recipient

Using easy mode

When [Enable Send Destination Link as Default] is enabled in the settings (administrator), the scanned data is saved in the machine's local drive, and URL information is sent to the e-mail destination. When disabled, scanned data is sent by regular Scan to E-mail. This function enable/disable cannot be changed in the easy mode screen.

Using normal mode

[Send Destination Link] appears on the action panel of the home screen of Scan to E-mail. By selecting this checkbox , you can use this function.

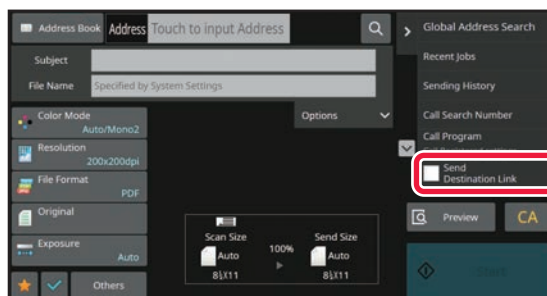

Number of URLs created

One URL is created per file to be downloaded.

Using [One Page per File]

Multiple scanned files will be created and saved at once, and a URL will be created for each file and sent to the recipient.

Using [Programmed]

Files will be created and saved in a format that varies by recipient, and a URL will be created for each file. A URL will be sent to each recipient for the file in the format for that recipient.



- To use this function, [Send Destination Link Settings] must be enabled in the System Settings (administrator).
- This function cannot be used in combination with metadata transmission or resending from document filing.
- If a subfolder is selected as the saving destination, this function cannot be used.
- Scanned files are saved in the standard folder area.
- Scanned files cannot be browsed by a method other than downloading.
- Scanned files cannot be manually deleted, and are retained for the save period set in the System Settings. However, scanned files will be deleted if Clear All Memory or Initialize Private Data/Data in Machine is executed, or you move to Advanced Security Settings.
- When all destinations in a broadcast transmission are e-mail addresses, URL information is sent to all destinations. If the file format of the saved scan data is the same for all destinations, the same URL will be sent. If the file format varies by destination, separate URLs will be sent.
- If the transmission includes recipients for different jobs (Scan to FTP, Scan to Desktop, etc.), transmission will take place by sending only a URL to the recipient to any e-mail addresses, while the scanned file will be sent directly in the normal way to recipients for other jobs.
- When [Document Administration Function] is enabled in the System Settings (administrator), the scanned file will be sent directly to the administrator, not by URL.
- Even when [Send Destination Link Settings] is disabled in the System Settings (administrator), the URL can be accessed and the scanned file downloaded during the file save period.
- The scanned file will be saved even if a send data limit is set in the System Settings (administrator) and the file exceeds the limit. The scanned file will be saved as a single file even if [If the send data exceeds maximum size, it will be sent in multiple files.] is enabled in the System Settings (administrator) and the file exceeds the limit. If there is a job other than a Scan to E-mail job in a broadcast transmission and the scanned file exceeds the [Maximum Size of Send Data (FTP/Desktop/Network Folder)] setting, transmission will not be possible.



- **To use this function**

Configure in "Settings (administrator)" → [System Settings] → [Image Send Settings] → [Scan Settings] → [Condition Settings] → [Send Destination Link Settings].

- **To always use this function in easy mode**

Configure in "Settings (administrator)" → [System Settings] → [Image Send Settings] → [Scan Settings] → [Condition Settings] → [Enable Send Destination Link as Default].

When this function is enabled and e-mail is sent in normal mode, the [Send Destination Link] checkbox in the action panel is always .

- **Save period for scanned files saved using this function**

Configure in "Settings (administrator)" → [System Settings] → [Image Send Settings] → [Scan Settings] → [Condition Settings] → [File Retention Period].

- **Protecting the URL by SSL/TLS**

Configure in "Settings (administrator)" → [System Settings] → [Image Send Settings] → [Scan Settings] → [Condition Settings] → [Enable SSL/TLS].



TRANSMITTING AN IMAGE

TRANSMITTING AN IMAGE

SENDING AN IMAGE IN SCAN MODE

An image can be sent in scan mode (Scan to E-mail, Scan to FTP, Scan to Desktop, and Scan to Network Folder).



- If the memory becomes full while the originals are being scanned, a message will appear and scanning will stop.
- When performing Scan to E-mail, take care not to send a file that is too large. In particular, multi-page files tend to be large. When sending a multi-page file or other large file, it may be necessary to reduce the number of scanned pages or reduce the send size.



Do not place any objects under the original size detector. Closing the automatic document feeder with an object underneath may damage the original size detector plate and prevent correct detection of the document size.

1

Place the original.





Place the original in the document feeder tray of the automatic document feeder, or on the document glass.

[AUTOMATIC DOCUMENT FEEDER \(page 1-34\)](#)



[DOCUMENT GLASS \(page 1-38\)](#)

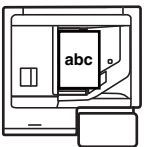
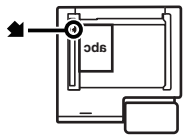

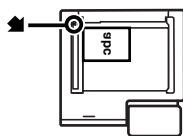
- When placing the originals, orient them as shown below.

Originals	Document feeder tray Place the original face up.	Document glass Place the original face down and align the corner with the tip of the  mark in the top left corner of the document glass scale.
Portrait orientation* 		
Landscape orientation* 		

*To place a large portrait-oriented original, place it as shown in the figure titled "Landscape orientation" and specify the placement orientation in step 4.

- Place 5-1/2" x 8-1/2" (A5) size originals in portrait (vertical) orientation (). If placed in landscape (horizontal) orientation (), an incorrect size will be detected. For an 5-1/2" x 8-1/2"R (A5R) size original, enter the original size manually.



2

Specify the destination.

- [RETRIEVING A DESTINATION FROM AN ADDRESS BOOK \(page 6-33\)](#)
- [VIEWING A LIST OF THE SELECTED DESTINATIONS \(page 6-36\)](#)
- [USING A SEARCH NUMBER TO RETRIEVE A DESTINATION \(page 6-37\)](#)
- [ENTERING AN ADDRESS MANUALLY \(page 6-38\)](#)
- [SPECIFYING A NETWORK FOLDER \(page 6-39\)](#)
- [RETRIEVING A DESTINATION FROM A GLOBAL ADDRESS BOOK \(page 6-41\)](#)
- [RETRIEVING A DESTINATION FROM A MOBILE ADDRESS BOOK \(page 6-43\)](#)
- [USING A TRANSMISSION LOG TO RESEND \(page 6-45\)](#)

The icon on the key indicates the type of destination stored in the key.

- Scan to E-mail
- Scan to FTP
- Scan to Network Folder
- Scan to Desktop



- After a one-touch key is tapped, if the screen is changed without tapping **+**, the destination of the tapped key is automatically specified.
- When performing Scan to E-mail, you can also send Cc or Bcc copies to other destinations. Tap the [Address Review] key to select destinations.
[VIEWING A LIST OF THE SELECTED DESTINATIONS \(page 6-36\)](#)
- Multiple destinations can be specified.
- To change [Subject], [File Name], [Reply-To], or [Body Text] in normal mode, tap a target entry box, or tap [Options].
[CHANGING THE SUBJECT, FILE NAME, REPLY-TO, AND BODY TEXT AT THE TIME OF SCAN TRANSMISSION \(page 6-53\)](#)

3

Tap the [Original] key.

4

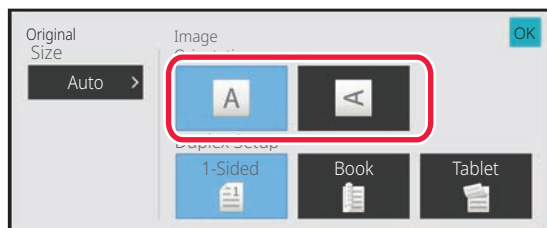
**Tap the appropriate orientation key.**

Specify the orientation of the original placed in step 1. After the settings are completed, tap **OK**.



- You can change exposure, resolution, file format, color mode, and other settings.
[AUTOMATICALLY SCANNING BOTH SIDES OF AN ORIGINAL \(2-SIDED ORIGINAL\) \(page 6-68\)](#)
[SCAN SIZE AND SEND SIZE \(ENLARGE/REDUCE\) \(page 6-69\)](#)
[CHANGING THE EXPOSURE AND ORIGINAL IMAGE TYPE \(page 6-81\)](#)
[CHANGING THE RESOLUTION \(page 6-83\)](#)
[CHANGING FORMAT IN SCAN OR DATA ENTRY MODE \(page 6-84\)](#)
[CHANGING COLOR MODE \(page 6-90\)](#)
- Tapping the [Others] key allows you to configure various functions, for example, collectively sending two original pages as one sheet or original pages with different sizes.



5

Tap the [B/W Start] or [Color Start] key to start scanning of the original.

- If the original was inserted in the document feeder tray, a beep will sound when scanning is completed and transmission will take place.
- If the original is placed on the document glass, the [Read-End] key appears in the touch panel. If the original is only one page, go to step 7. To scan more pages, go to step 6.



- You can tap the [Preview] key to check a preview of the image before sending an image. For more information, see "[CHECKING THE IMAGE TO BE TRANSMITTED \(page 6-93\)](#)".
- If the file format is set to [PDF/Encry.], [PDF/Encry./Reduce Colors], [PDF/Encry./Compact], or [PDF/Encry./Compact/U-Fine], you will be prompted to enter the password when you tap the [B/W Start] or [Color Start] key.
- Tap the password entry box to open the keyboard screen, enter a password using a maximum of 32 characters, and tap the [OK] and [Send] key in sequence. The recipient must use the password entered here to open the Encrypt PDF file.
- To cancel Encrypt PDF, tap the [Cancel] key. The format settings screen will appear to let you change the file type. Select a new file type and tap the [B/W Start] or [Color Start] key to begin transmission.

6

If the original was placed on the document glass, replace it with the next original and tap the [B/W Start] or [Color Start] key.

Repeat until all originals have been scanned.

7

Tap the [Read-End] key.

A beep will sound to indicate that the operation is completed.



- If no action is taken for one minute after the confirmation screen is displayed, scanning automatically ends and the transmission is reserved.
- Tap the [Change Setting] key to change the exposure, resolution, scan size, and send size for each original page scanned. However, when "Card Shot" is selected in Others, change only the exposure when scanning an even-numbered original page.
- When Scan to E-mail and Internet Fax destinations are included, the send width for Scan to E-mail and Internet Fax will be the same as the send width for fax.



- **To change the time until transmission takes place automatically:**
Select "Settings (administrator)" - [System Settings] → [Image Send Settings] → [Common Settings] → [Condition Settings] → [Job Auto Start Time During Scanning].
- **To set the scan complete sound:**
In "Settings (administrator)", select [System Settings] → [Sound Settings] → [Beep Sound Settings (Common)] → [Scan Complete Sound (Image Send)].



CHANGING THE SUBJECT, FILE NAME, REPLY-TO, AND BODY TEXT AT THE TIME OF SCAN TRANSMISSION

Change the subject, file name, reply-to, and body text when performing a scan transmission. If necessary, directly enter the text.



- When performing Scan to FTP, Scan to Desktop, or Scan to Network Folder, only the file name is used.
- If the subject or file name is not changed, the settings in [System Settings] → [Image Send Settings] → [Scan Settings] → [Subject Name Settings], [File Name Settings], and [Message Body Settings] in "Settings (administrator)" are used.
- If the reply-to address is not changed, the settings in [System Settings] → [Image Send Settings] → [Scan Settings] → [Condition Settings] → [Default Reply.Address Set] in "Settings (administrator)" are used. If this is not configured, the reply address configured in [Network Settings] → [Services Settings] → [SMTP] → [Sender Address] in the "Settings" is used. (Administrator rights are required.)
- To configure the candidates for the subject, file name, and body text, select [System Settings] → [Image Send Settings] → [Scan Settings] in "Settings (administrator)".
- For details on how to enter characters, refer to "[CHARACTER ENTRY \(page 2-62\)](#)" in "How to operate this machine".

1

Tap the [Detail] key to change to normal mode.

[EASY MODE \(page 6-7\)](#)

2

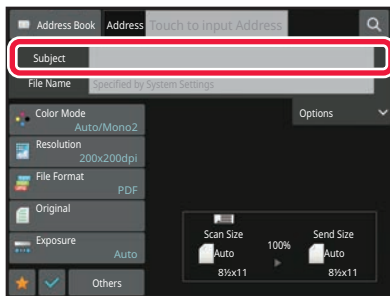

To change the subject, tap the [Subject] entry box.

3

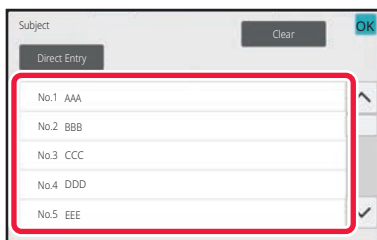

Tap a pre-set text key.

After the settings are completed, tap **OK**.



To cancel the selection of the subject:

Tap the [Clear] key.



If you wish to directly enter the text, tap the [Direct Entry] key to open the soft keyboard.

Enter the text and tap the [OK] key.



4

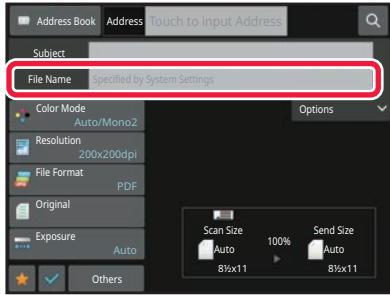

To change the file name, tap the [File Name] entry box.

After the settings are completed, tap **OK**.

- Tap the key of the file name from the list.
- To directly enter the file name, tap the [Direct Entry] key.
- A prompt is displayed in the file name. The prompt is changed according to the settings.

If the settings are not changed, "Following the System Settings" is displayed.

In [OCR Setting], if [File Name Auto Extraction] is enabled, "File Name Auto Extraction" will be displayed.



When scanning to a shared folder, if you set a file name that is the same as an existing file name in the shared folder, the file name will be changed to prevent overwriting of the existing file.

5

Tap [Options].

6

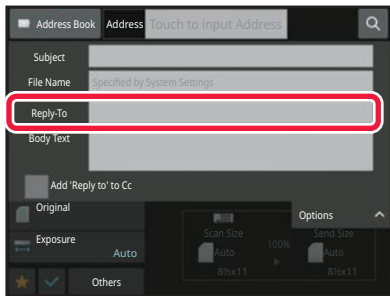

To change the reply address, tap the [Reply-To] entry box.



If user authentication is being used, the information of the user that logged in will be applied, and thus the reply address cannot be changed.

7

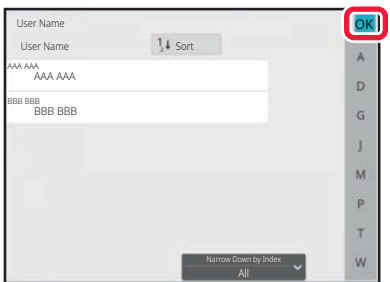

Tap the key that you wish to use for the reply address.

After the settings are completed, tap **OK**.

- You can select addresses from the user list in the same way as you would select the reply address. You can also tap [Global Address Search] on the action panel to specify a user stored in the global address book as the reply address.
- Tapping [Direct Entry] on the action panel allows you to directly enter the e-mail address.
- Selecting the [Add 'Reply to' to Cc] checkbox to adds a reply address to the Cc address.

8

To change the body text, tap the [Body Text] entry box.



9



Enter the body text.

After the settings are completed, tap **OK**.

- To select a pre-set text previously stored in the Setting mode (Web version), tap the [Pre-set Message] key.
- To directly enter the body text, tap the [Edit] key.



To clear all entered text:

Tap the [Clear All] key. When this key is tapped, the entire body of the message is erased immediately, not just the selected line.



- Enter up to 1800 characters. (A line break counts as one character.)
- To edit the selected line, tap the [Edit] key. The soft keyboard will appear with the selected text entered.



SENDING A FAX IN INTERNET FAX MODE

Transmits a fax in Internet Fax mode. This procedure can also be used to perform a direct transmission by Direct SMTP.



- If the memory becomes full while the originals are being scanned, a message will appear and scanning will stop.
- When all originals have been scanned, the message "Job stored." will be displayed together with a job control number. If necessary, use this number to locate the job in the Transaction Report or in the Image Sending Activity Report.
- If the job is a broadcast transmission, this number will also appear in the key of the job in the job status screen. For this reason, it is advisable to make a note of the number so that you can check the result easily.
- Mail Footer Registration: The specified text is automatically appended to the end of the body text of e-mail. This is convenient when you wish to append pre-set text such as a corporate policy. To enter the text to append, select [System Settings] → [Image Send Settings] → [Scan Settings] → [Message Body Settings] → [Mail Footer Registration] in "Settings (administrator)".
Enter up to 900 characters. (The appended text is not included in the maximum number of characters that can be entered in the e-mail body.)
To specify whether or not to append text, select [System Settings] → [Image Send Settings] → [Scan Settings] → [Message Body Settings] → [Add a Footer Automatically to the Mail Message Body] in "Settings".



If a default address has been configured using "Settings" → [System Settings] → [Image Send Settings] → [Scan Settings] → [Default Address] → [Default Address Setting], the mode cannot be changed, or the destination cannot be changed or added.
To switch to Internet fax mode, tap the [Cancel] key in the touch panel and then perform the transmission procedure.

1



Place the original.

Place the original in the document feeder tray of the automatic document feeder, or on the document glass.
[AUTOMATIC DOCUMENT FEEDER \(page 1-34\)](#)
[DOCUMENT GLASS \(page 1-38\)](#)



Do not place any objects under the original size detector. Closing the automatic document feeder with an object underneath may damage the original size detector plate and prevent correct detection of the document size.



- Place the original of the 5-1/2" x 8-1/2" (A5) size in the portrait orientation ().
- If placed in landscape orientation (), an incorrect size will be detected.
For an 5-1/2" x 8-1/2"R (A5R) size original, enter the original size manually.
[SPECIFYING THE ORIGINAL SCAN SIZE IN PAPER SIZE \(page 6-70\)](#)
- Rotation sending
8-1/2" x 11" and 5-1/2" x 8-1/2"R (A4, B5R and A5R) originals are rotated 90 degrees, and respectively sent in the 8-1/2" x 11"R and 5-1/2" x 8-1/2" (A4R, B5 and A5) orientations.
(Rotation sending is not available for originals with 8-1/2" x 11"R or 5-1/2" x 8-1/2" (A4R, B5, or A5) size.)
Example: When sending an 8-1/2" x 11" (A4) original

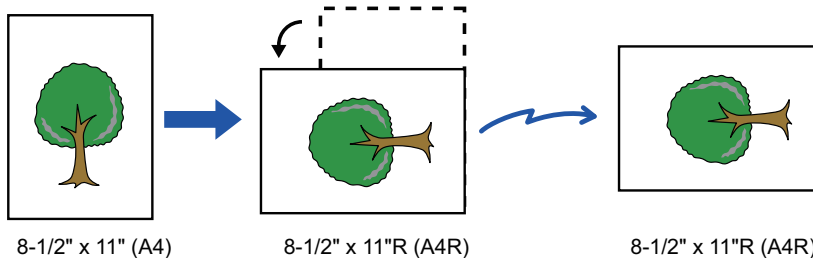



2

Tap the mode display to switch to the initial screen of Internet Fax mode.[SELECTING NETWORK SCANNER MODE \(page 6-9\)](#)

3

Specify the destination.[RETRIEVING A DESTINATION FROM AN ADDRESS BOOK \(page 6-33\)](#)[VIEWING A LIST OF THE SELECTED DESTINATIONS \(page 6-36\)](#)[USING A SEARCH NUMBER TO RETRIEVE A DESTINATION \(page 6-37\)](#)[ENTERING AN ADDRESS MANUALLY \(page 6-38\)](#)[SPECIFYING A NETWORK FOLDER \(page 6-39\)](#)[RETRIEVING A DESTINATION FROM A GLOBAL ADDRESS BOOK \(page 6-41\)](#)[RETRIEVING A DESTINATION FROM A MOBILE ADDRESS BOOK \(page 6-43\)](#)[USING A TRANSMISSION LOG TO RESEND \(page 6-45\)](#)The icon of  appears in one-touch keys in which Internet fax addresses are stored.

To change [Subject], [File Name], or [Body Text], tap the [Others] key and tap the [Send Settings] key.



[CHANGING THE SUBJECT, FILE NAME, AND BODY TEXT AT THE TIME OF INTERNET FAX TRANSMISSION \(page 6-58\)](#)

4

Tap the [Original] key.

- Set the density, resolution, and format in [System Settings] → [Image Send Settings] → [Internet Fax Settings] → [Server Settings] → [Default Settings] in "Settings (administrator)".
- Tapping the [Others] key allows you to configure various functions, for example, collectively sending two original pages as one sheet or original pages with different sizes.

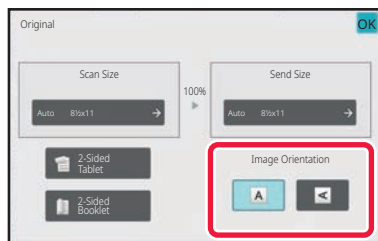
5

**Tap the appropriate orientation key.**After the settings are completed, tap .

6

Tap the [Start] key to start scanning of the original.

- If the original is placed on the document glass, the [Read-End] key appears in the touch panel. If the original is only one page, go to step 8. To scan more pages, go to the next step.
- If the original was inserted in the document feeder tray, a beep will sound when scanning is completed and transmission will take place.

You can tap the [Preview] key to check a preview of the image before sending an image. For more information, see "[CHECKING THE IMAGE TO BE TRANSMITTED \(page 6-93\)](#)".

7

If the original was placed on the document glass, replace it with the next original and tap the [Start] key.

Repeat until all originals have been scanned.



8

Tap the [Read-End] key.

A beep will sound to indicate that the operation is completed.
Open the automatic document feeder and remove the original.



- If no action is taken for one minute after the confirmation screen is displayed, scanning automatically ends and the transmission is reserved.
- Tap the [Change Setting] key to change the exposure, resolution, scan size, and send size for each original page scanned.
However, when "N-Up" or "Card Shot" is selected in Others, only change the exposure when scanning an even-numbered original page.

CHANGING THE SUBJECT, FILE NAME, AND BODY TEXT AT THE TIME OF INTERNET FAX TRANSMISSION

Change the subject, file name, and body text when performing an Internet fax transmission. If necessary, directly enter the text. Configure a file name, and other settings for an Internet fax using the Send Settings of the other functions.



- If the subject and file name are not changed, the settings in the Setting mode (Web version) are used.
- To configure the candidates for the subject, file name, and body text, click [System Settings] → [Image Send Settings] → [Scan Settings] in "Settings (administrator)".
- For details on how to enter characters, refer to "[CHARACTER ENTRY \(page 2-62\)](#)" in "How to operate this machine".

1

Tap the mode display to switch to the initial screen of Internet Fax mode.

[SELECTING NETWORK SCANNER MODE \(page 6-9\)](#)

2

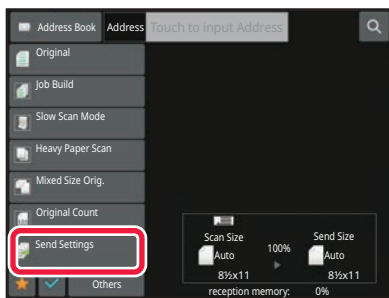

Tap the [Send Settings] key.

3

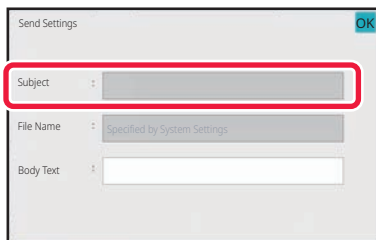

To change the subject, tap the [Subject] entry box.



4

Tap a pre-set text key.

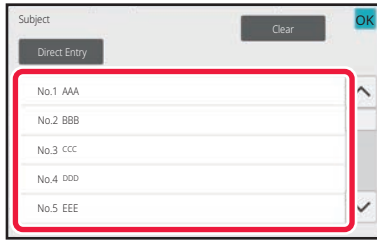

To cancel the selection of the subject:

Tap the [Clear] key.



If you wish to directly enter the text, tap the [Direct Entry] key to open the soft keyboard. Enter the subject and tap the [OK] key.

5

To change the file name, tap the [File Name] entry box.

6

Tap a pre-set text key.

• After the settings are completed, tap **OK**.

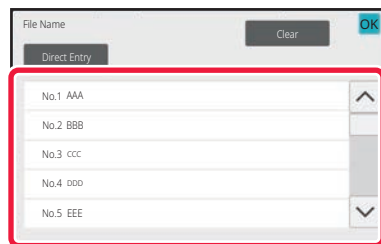

- To store the pre-set text for the file name, select [System Settings] in "Settings" → [Image Send Settings] → [Scan Settings] → [File Name Settings].
- If you wish to directly enter the text, tap the [Direct Entry] key to display the soft keyboard. Enter the file name and tap the [OK] key.



To cancel the selection of the file name:

Tap the [Clear] key.

7

To change the body text, tap the [Body Text] entry box.



8

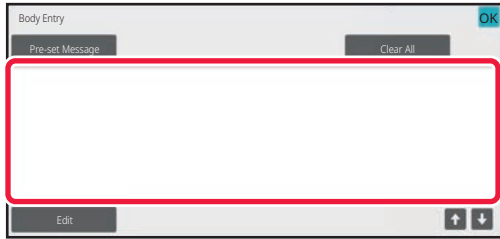

Enter the body text.

After the settings are completed, tap **OK**.

- To select a pre-set text previously stored in the Setting mode (Web version), tap the [Pre-set Message] key.
- To directly enter the body text, tap the [Edit] key.



To clear all entered text:

Tap the [Clear All] key. When this key is tapped, the entire body of the message is erased immediately, not just the selected line.



- Enter up to 1800 characters. (A line break counts as one character.)

Use to select on a line basis.

- To edit the selected line, tap the [Edit] key. The soft keyboard will appear with the selected text entered.



SENDING THE SAME IMAGE TO MULTIPLE DESTINATIONS (BROADCAST TRANSMISSION)

Send the same scanned image to multiple scan, Internet fax, and fax mode destinations in a single operation. One operation allows you to send data to up to 500 destinations, including the reserved send jobs. (For example, if broadcast transmission jobs with 450 destinations are already reserved, data can be broadcasted to up to 50 destinations.)

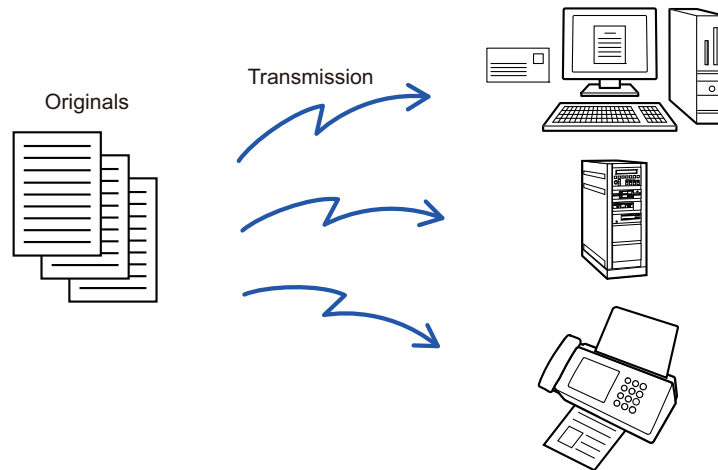

It is convenient to store destinations you frequently use for broadcast transmission as contacts or groups. A maximum of 500 destinations can be stored in one contact.

For broadcast transmission, the contact or group key can be simply tapped to retrieve multiple fax numbers.

You can also send faxes with the one-touch key by setting the [Set as Default used] checkbox to when addresses are registered. If you wish to temporarily remove a destination from the stored addresses, open the detail confirmation screen and remove the destination in the screen.

[USING A TRANSMISSION LOG TO RESEND \(page 6-45\)](#)



- When the checkbox of "Settings (administrator)" -[System Settings] → [Image Send Settings] → [Common Settings] → [Condition Settings] → [Address Book Default Selection] → [Apply Addresses of Sending Modes Only] is set to (factory default setting), the image is only sent to those destinations among the destinations that are set to [Set as Default used] which are for the currently selected mode. If the checkmark is removed , the image can also be sent to destinations of other modes.
- When broadcast transmission includes Internet Fax addresses, the document is sent in black and white to all addresses.
- When Internet Fax mode addresses are included in broadcast transmission addresses, the image data is converted and sent as image data for Internet Fax. Even when scanned in color, the image data is converted to Internet Fax black and white binary and sent to addresses such as e-mail addresses.
- If you wish to send the same image as fax to all destinations in normal mode, tap [Send Same Image as Fax Address] on the action panel. This cannot be selected when Internet Fax is included in the destinations.
- When Scan to E-mail and Internet Fax destinations are included, the send width for Scan to E-mail and Internet Fax will be the same as the send width for fax.
- Broadcast transmission is not possible to both direct SMTP addresses and other types of addresses.



A transmission is performed, ignoring hyperlinks with Scan to FTP and Scan to Network Folder addresses.



To register destinations in a contact or group:

- In the address book screen, tap [Add New] on the action panel, or tap the [Address Control] icon in the home screen.
- For more information, see "[STORING ADDRESSES THROUGH DIRECT ENTRY \(page 6-19\)](#)", "[STORING ADDRESSES THROUGH DIRECT ENTRY \(page 6-19\)](#)", "[USING A TRANSMISSION LOG TO RESEND \(page 6-45\)](#)", "[STORING GROUPS \(page 6-24\)](#)".



1

Place the original.

Place the original in the document feeder tray of the automatic document feeder, or on the document glass.
[AUTOMATIC DOCUMENT FEEDER \(page 1-34\)](#)
[DOCUMENT GLASS \(page 1-38\)](#)

2

Specify all destinations.

- [RETRIEVING A DESTINATION FROM AN ADDRESS BOOK \(page 6-33\)](#)
- [VIEWING A LIST OF THE SELECTED DESTINATIONS \(page 6-36\)](#)
- [USING A SEARCH NUMBER TO RETRIEVE A DESTINATION \(page 6-37\)](#)
- [ENTERING AN ADDRESS MANUALLY \(page 6-38\)](#)
- [SPECIFYING A NETWORK FOLDER \(page 6-39\)](#)
- [RETRIEVING A DESTINATION FROM A GLOBAL ADDRESS BOOK \(page 6-41\)](#)
- [RETRIEVING A DESTINATION FROM A MOBILE ADDRESS BOOK \(page 6-43\)](#)
- [USING A TRANSMISSION LOG TO RESEND \(page 6-45\)](#)



- One-touch keys that cannot be used for broadcast transmission are grayed out to prevent selection.
- If a Scan to FTP or Network Folder address is specified in a broadcast transmission, hyperlink e-mail transmission will not take place.



- If [System Settings] → [Image Send Settings] → [Common Settings] → [Condition Settings] → [Be sure to press Next Address Key ([+]) before selecting the next address.] is enabled in "Settings (administrator)", tap **+** before specifying the next destination.
- If you wish to send the same image (Mono2) as the one for the fax address to all destinations in normal mode, tap [Send Same Image as Fax Address] on the action panel.

3

Tap [Address Review] on the action panel.

4

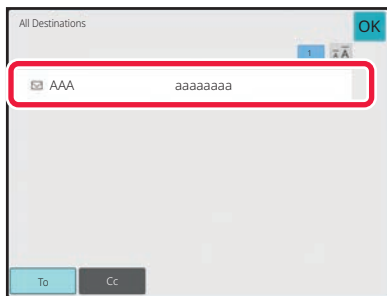

Confirm the destination.



- **To cancel a specified destination:**
Tap the key of the destination that you wish to cancel to release the selection.
- **To switch delivery types (To/Cc/Bcc):**
Tap the address that you want to change, and tap [Change to To], [Change to Cc], or [Change to Bcc] on the action panel.



5

Tap the [B/W Start] or [Color Start] key ([Start] key in normal mode) to start scanning of the original.

- If you inserted the original pages in the document feeder tray, all pages are scanned. A beep will sound to indicate that scanning and transmission have ended.
- When you place the original on the document glass, scan each page at a time. When scanning finishes, place the next original and tap the [B/W Start] or [Color Start] key ([Start] key in normal mode). Repeat until all pages have been scanned and then tap the [Read-End] key. A beep will sound to indicate that transmission has ended.



You can tap the [Preview] key to check a preview of the image before sending an image. For more information, see "[CHECKING THE IMAGE TO BE TRANSMITTED \(page 6-93\)](#)".

SETTING MODES WHEN MULTIPLE TYPES OF ADDRESSES ARE INCLUDED IN A BROADCAST TRANSMISSION

This section explains settings you should bear in mind if multiple types of addresses are included in a broadcast transmission.

When a broadcast transmission includes a mix of several types of addresses (such as scan mode and Internet Fax mode destinations), its settings are enabled for all addresses regardless of which mode screen is used to configure them. Note the following exceptions:

When Internet Fax addresses are not include

File format (file compression mode)	The compression mode set with [System Settings] → [Image Send Settings] → [Scan Settings] → [Condition Settings] → [Compression Mode at Broadcasting] in "Settings (administrator)" is used for all destinations.
Color Mode	When the color mode setting is [Full Color] in scan mode, the image will be sent in Mono2 to fax addresses and in color to scan addresses. To send the image in Mono2 to all addresses, tap [Send Same Image as Fax Address] on the action panel in normal mode
Original Count	An address of a mode in which the number of original sheets are specified, if it exists, is enabled.
Scan file size	If a broadcast transmission is performed that includes destinations for which an attachment size limit has been set using [Maximum Size of Send Data (E-Mail)] or [Maximum Size of Send Data (FTP/Desktop/Network Folder)] (in "Settings (administrator)", select [System Settings] → [Image Send Settings] → [Scan Settings] → [Condition Settings]), the limit will also apply to destinations for which a limit is not set.
N-Up	This mode is available only for Fax. It is linked to a mode with an appropriate function.
Drop Out color	This mode is available for Scanner and Data entry. It is linked to a mode with an appropriate function.
RGB	This mode is available for Scanner, Network Folder, and FTP/Desktop. It is linked to a mode with an appropriate function.



When Internet Fax addresses are included

When Internet Fax addresses are included in the destinations, the following restrictions apply.

Color Mode	Fixed at black & white binary.
File format (file compression mode)	Fixed at TIFF.
Original	Transmission will take place to all addresses using the same image width as Internet Fax.
Background Adjustment	Cannot be set.
Blank Page Skip	
Drop Out color	
Contrast	
Sharpness	
RGB	
Sign	
Encrypt	
Multicrop	
Business Card Scan	
Image Crop	



Broadcast transmission is not possible to both direct SMTP addresses and other types of addresses.



RESENDING TO UNSUCCESSFUL BROADCAST TRANSMISSION DESTINATIONS

The results of a completed broadcast transmission can be checked in the job status screen. If transmission to any of the destinations failed, resend the image to those destinations.

1 Tap the job status display.

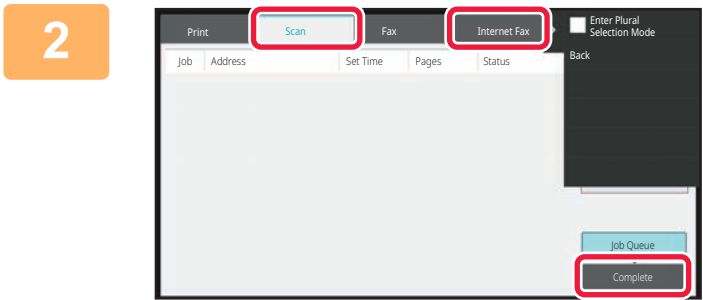

Tap the [Scan] tab or [Internet Fax] tab, and tap the [Complete] key.



If the broadcast transmission included destinations of different modes, the same broadcast transmission key will appear in each of those modes.

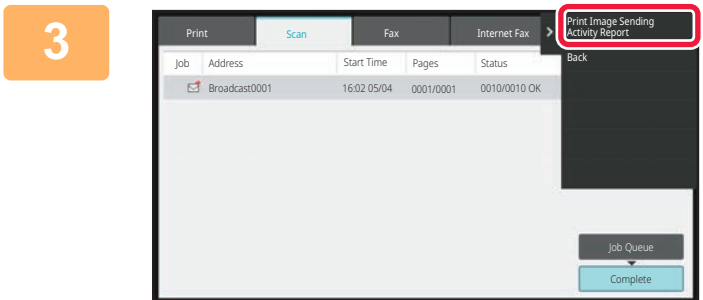

After tapping the key of the completed broadcast transmission, tap [Check Details of Selected Job] on the action panel.



4

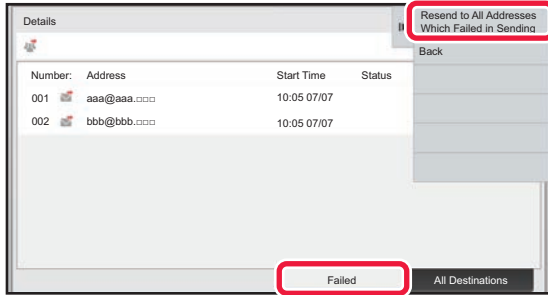

After tapping the [Failed] tab, tap [Resend to All Addresses Which Failed in Sending] on the action panel to resend the image.



- The steps to follow after [Resend to All Addresses Which Failed in Sending] is tapped differ depending on whether or not document filing is used.
- **Using document filing:**
You will return to the document filing resend screen with the unsuccessful destinations entered. Perform the document filing resend procedure. (There is no need to re-scan the original.)
- **Not using document filing:**
You will return to the base screen with the unsuccessful destinations entered. Place the original and perform the steps of the broadcast transmission.



SENDING AN INTERNET FAX FROM A PC (PC-I-FAX)

A file on a computer can be sent via the machine as a fax (PC-I Fax function).

Faxes are sent using the PC-I Fax function in the same way that documents are printed. Select the PC-Fax driver as the printer driver for your computer and then select the Print command in the application. Image data for transmission will be created and sent as an Internet fax.

By using the "Log Viewer" application, Internet faxes can be sent using the transmission log displayed in the Log Viewer. For the procedures for using this function, see the PC-Fax driver Help.

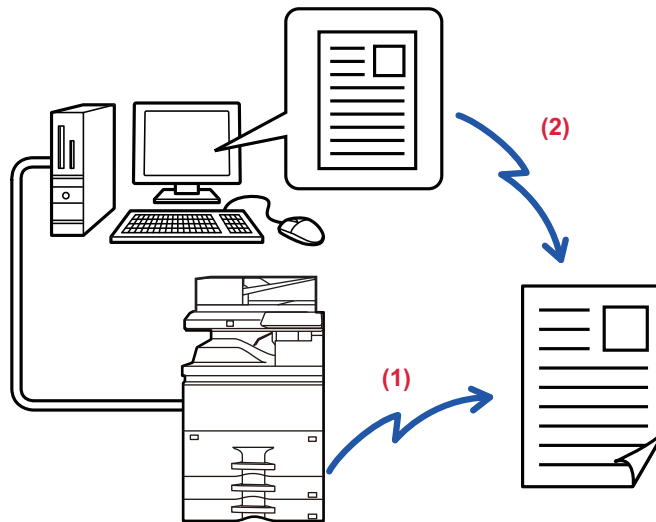

- (1) **PC-i-Fax Send**
- (2) **Log Viewer Re-send faxes using the transmission log**



- To send an Internet fax using the PC-I-Fax function, the PC-Fax driver must be installed and then updated using the CD-ROM that accompanies the Internet fax expansion kit. For more information, see the Software Setup Guide.
- This function can only be used on a Windows computer.



This function is available for transmission. Internet faxes received on the machine cannot be received to a computer that is connected to the machine.



IMAGE SETTINGS

AUTOMATICALLY SCANNING BOTH SIDES OF AN ORIGINAL (2-SIDED ORIGINAL)

The automatic document feeder is used to automatically scan both sides of an original.

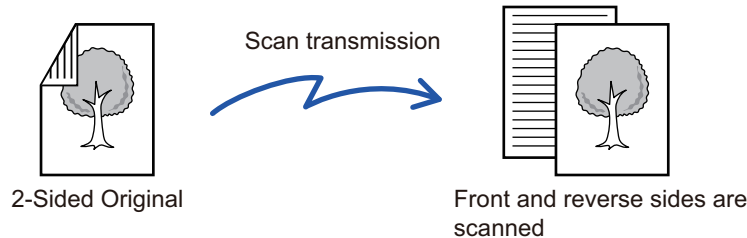

The settings on 2-sided scanning are cleared when transmission has completed.



- You cannot use 2-Sided scanning when the original size is set to Long Size.
- 2-sided scanning is not possible when "Settings (administrator)" - [System Settings] → [Common Settings] → [Device Control] → [Condition Settings] or [Enable/Disable Settings] → [Disabling of Document Feeder] is enabled.

1

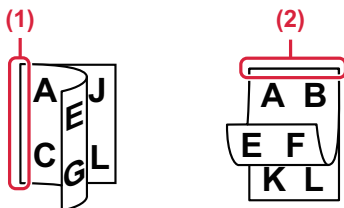

After tapping the [Original] key, tap the [Book] or [Tablet] key.

See the figure on the left to check the binding edge of the original and select the key to be tapped.

- (1) Book
- (2) Tablet



- In normal mode, tap the [2-Sided Tablet] or [2-Sided Book] key.

2

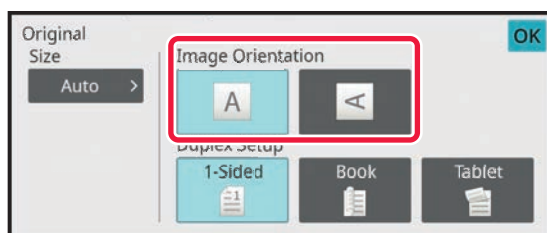

Tap the [Image Orientation] key with the same orientation as the placed original.

If this setting is not correct, a suitable image may not be transmitted.

After the settings are completed, tap **OK**.



To cancel 2-sided scanning:

Tap the [1-Sided] key.

In normal mode, tap the [2-Sided Tablet] key or the [2-Sided Book] key that has been forcibly displayed and cancel the display.



SCAN SIZE AND SEND SIZE (ENLARGE/REDUCE)

When the original is placed, its size is automatically detected.

In normal mode, the size of the placed original is indicated as the "Scan Size", and the size to be transmitted is indicated as the "Send Size".

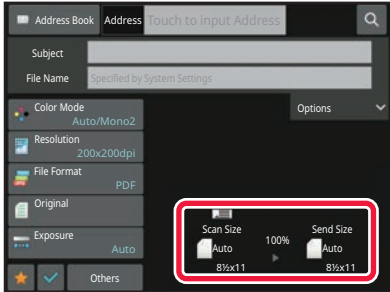

In the above screen, the scan size (the placed original) is 8-1/2" x 11" (A4) and the send size is auto. For example, if the scan size is 8-1/2" x 11" (A4) and the send size is 5-1/2" x 8-1/2" (B5), the image will be reduced before transmission.

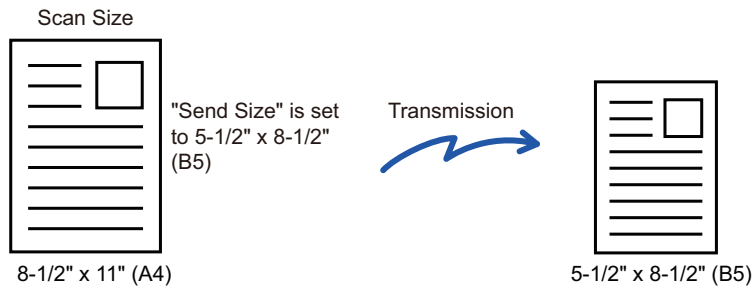

- Only standard original sizes can be automatically detected.
[THE SIZE OF THE PLACED ORIGINAL \(page 6-13\)](#)
- When the original size is an inch size or a non-standard size, or if the size is not detected correctly, manually specify the original scan size.
[SPECIFYING THE ORIGINAL SCAN SIZE IN PAPER SIZE \(page 6-70\)](#)
[SPECIFYING THE ORIGINAL SCAN SIZE USING NUMERIC VALUES \(page 6-72\)](#)



SPECIFYING THE ORIGINAL SCAN SIZE IN PAPER SIZE

When the original size is a non-standard size or is not detected correctly, manually specify the original size.



When [Long Size] is selected, the 2-sided scanning setting and send size cannot be changed. The image is sent in Mono2 only.

In Easy mode

1

Tap the [Original] key.

2

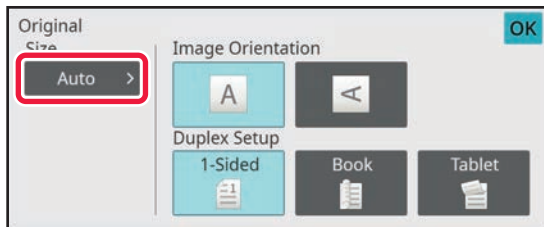

Tap the [Auto] key.

3



Tap a key of the desired original size. After the settings are completed, tap **OK**



If you are sending a long original, perform the setting in normal mode.



In Normal mode

1

Tap the [Detail] key to change to normal mode.

[EASY MODE \(page 6-7\)](#)

2

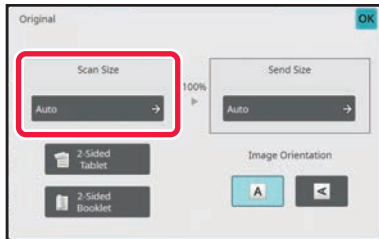

After tapping the [Original] key, tap the [Scan Size] key.

3

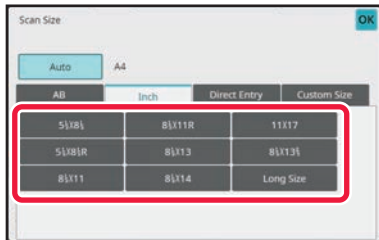

Tap the appropriate original size key.

After the settings are completed, tap **OK**.



If you are sending a long original, tap the [Long Size] key.

Use the automatic document feeder to scan a long original. The maximum width that can be scanned is 39-3/8" (1,000 mm) (the maximum height is 11-5/8" (297 mm)).

[TRANSMITTABLE ORIGINAL SIZES \(page 6-13\)](#)



SPECIFYING THE ORIGINAL SCAN SIZE USING NUMERIC VALUES

When scanning a non-standard size original such as a card or postcard, specify the original size using numeric values after placing the original.

The width can be from 1" to 17" (25 mm to 432 mm), and the height can be from 1" to 11-5/8" (25 mm to 297 mm).



When the scan size is specified by numeric values, the send size cannot be specified.

In Easy mode

1

Tap the [Original] key.

2

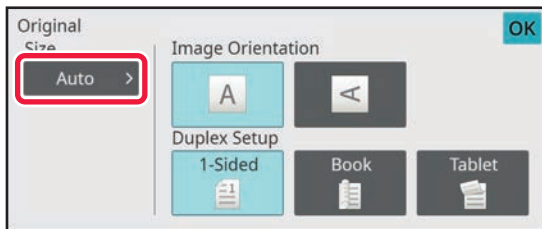

After tapping the [Original] key, tap the [Scan Size] key.

3



Tap the [Direct Entry] key.

4

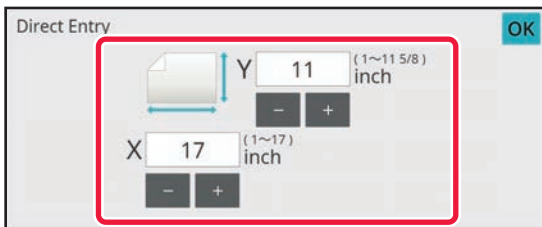

Specify the original size.



Tap the areas displaying width and height sizes respectively, and enter the sizes using the numeric keys. It is convenient to use (- +) to finely adjust the entered size.



5

Tap [Execute] twice.

On the base screen, check that the specified size is displayed on the [Original] key.



To cancel the specified size settings:

Tap the [Auto] key.



In Normal mode

1

Tap the [Detail] key to change to normal mode.

[EASY MODE \(page 6-7\)](#)

2

Tap the [Original] key.

3

After tapping the "Scan Size" key, tap the [Direct Entry] key.

4



Specify the original size.



Tap the areas displaying width and height sizes respectively, and enter the sizes using the numeric keys. It is convenient to use **- +** to finely adjust the entered size.

5

Tap the [Execute] key.

After the settings are completed, tap **OK** twice.

On the base screen, check that the specified size is displayed on the [Original] key.



To cancel the specified size settings:

Tap the [Auto] key.



STORING FREQUENTLY USED ORIGINAL SIZES

Store the frequently used non-standard original sizes. This section explains how to store, retrieve, change, and delete non-standard original sizes.



- The stored original size will be retained even if the main power is turned off.
- A total of up to 12 non-standard original sizes can be registered for copying, fax, and image sending.
- The added original sizes will also appear in other modes.

Storing original sizes (Modify/Delete)

1

Tap the [Detail] key to change to normal mode.

[EASY MODE \(page 6-7\)](#)

2

Tap the [Original] key.

3

Tap the [Scan Size] key and tap the [Custom Size] tab.

4



Tap [Store/Delete] key.



5

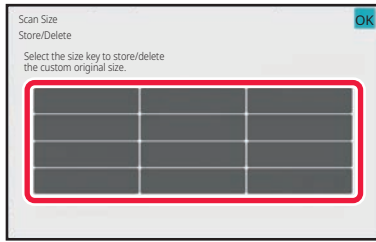

Tap a key () for storing a custom original size.

Tap a key that does not show a size.



To modify or delete a previously stored key:

- Tap the key that you want to modify or delete. The following screen will appear.
- To modify the key, tap the [Modify] key and go to the next step.
- To delete the key, tap the [Delete] key. Make sure that the original size has been cleared and tap the **OK** key.

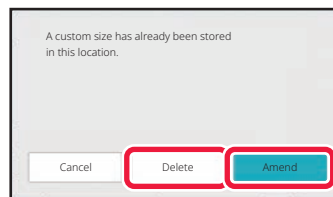

6

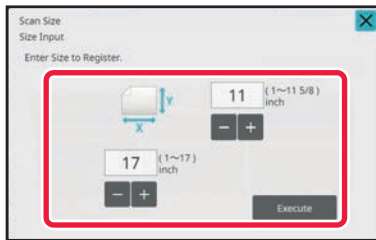

Specify the original size.

Tap the areas displaying width and height sizes respectively, and enter the sizes using the numeric keys.



It is convenient to use **- +** to finely adjust the entered size.

7

Tap the [Execute] key.

Tap the **OK** key, and check that the key of the size stored on the Scan Size screen is added properly. After you have checked it, tap **OK**.



To cancel the operation:

Tap the [CA] key.



Retrieving a stored original size
In Easy mode

1

Tap the [Original] key.

2

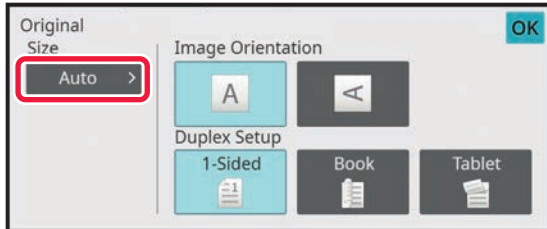

Tap the [Auto] key.

3



Tap the [Custom Size] key.

4

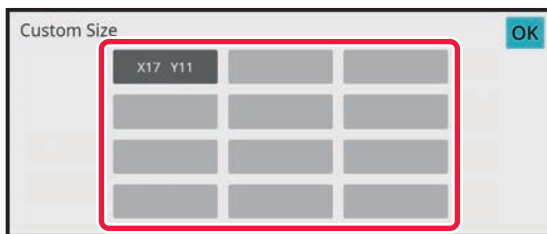

Tap the key of the original size that you wish to retrieve.

Tap **OK** twice.

On the base screen, check that the specified size is displayed on the [Original] key.



To cancel the operation
Tap the [CA] key.



In Normal mode

1

Tap the [Detail] key to change to normal mode.

[EASY MODE \(page 6-7\)](#)

2

Tap the [Original] key.

3

Tap the [Scan Size] key and tap the [Custom Size] tab.

4

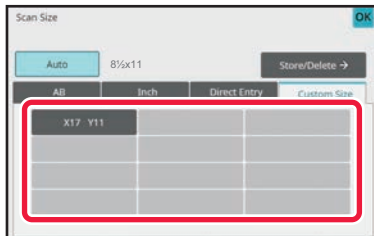

Tap the key of the original size that you wish to retrieve.

After selecting the key of the original size, tap the **OK** key. Check that the specified size is displayed on the scan size screen.



To cancel the operation

Tap the [CA] key.



SPECIFYING THE SEND SIZE OF THE IMAGE

Tap this key to specify the send size as a paper size. If the specified send size is larger than the scan size, the image will be enlarged. If the specified send size is smaller than the scan size, the image will be reduced.



- The send size cannot be specified when [Long Size] is selected for the scan size, or when the scan size is specified by numeric values.
- The send size cannot be specified when [TIFF-S] is selected for the format in Internet fax mode. (The send size is fixed at 8-1/2" x 11"R (A4R).)

1

Tap the [Detail] key to change to normal mode.

[EASY MODE \(page 6-7\)](#)

2

Tap the [Original] key.

3

Tap the [Send Size] key.

4

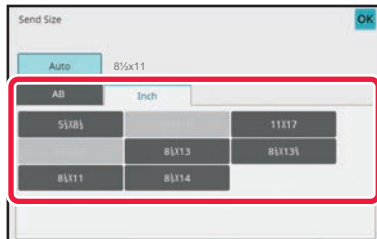

Tap the desired send size key.

After the settings are completed, tap **OK**.



Depending on the paper size specified for the "Scan Size", it may not be possible to select some sizes for the "Send Size". You cannot tap size keys that are unavailable for the "Send Size".



5

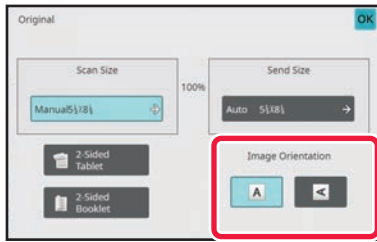

Tap the [Image Orientation] key with the same orientation as the original image.

If this setting is not correct, a suitable image may not be transmitted. After the settings are completed, tap **OK**.



To configure the default setting of image orientation, select [System Settings] → [Image Send Settings] → [Common Settings] → [Condition Settings] → [Image Orientation] in "Settings (administrator)".



The ratio used for reduction or enlargement of the original will appear between the "Scan Size" and the "Send Size".



CHANGING THE EXPOSURE AND ORIGINAL IMAGE TYPE

Optimum scanning is ensured by selecting exposure and original image type based on the original.



- When using the document glass to scan multiple original pages, change the exposure setting each time you change pages.
- The contrast for Internet Fax mode is set in the system settings.
[Internet Fax Settings \(page 10-109\)](#)



When using the automatic document feeder, the exposure setting cannot be changed once scanning has begun. (If "Job Build" is used in Others, change the exposure each time a new set of originals is inserted.)

Exposure settings

Exposure		Suggestion
Auto		This setting automatically adjusts the exposure for light and dark parts of the original.
Manual	1-2	Select this setting when the original consists of dark text.
	3	Select this setting for a normal original (neither dark nor light).
	4-5	Select this setting when the original consists of light text.

How to select the original type (Scan mode, Data entry mode)

Setup Items		Description
Auto		The original image type is automatically selected to match the original.
Manual	Text/Printed Photo	This mode provides the best balance for scanning an original which contains both text and printed photographs, such as a magazine or catalogue.
	Text/Photo	This mode provides the best balance for scanning an original which contains both text and photographs, such as a text document with a photo pasted on.
	Text	Use this mode for regular text documents.
	Photo	Use this mode to scan photos.
	Printed Photo	This mode is best for scanning printed photographs, such as photos in a magazine or catalogue.
	Map	This mode is best for copying maps with light color shading and fine text.



In Scan mode or Data entry mode

1

Tap the [Detail] key to change to normal mode.

[EASY MODE \(page 6-7\)](#)

2

Tap the [Exposure] key.

3

Tap the key assigned to the original type you wish to set based on the original type.

4

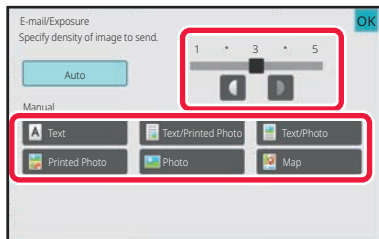

Tap to adjust the exposure.

After the settings are completed, tap .



When [Auto] is selected, changing the exposure sets the original image type to [Text/Printed Photo] automatically.



CHANGING THE RESOLUTION

Specify the resolution setting.

How to select the resolution

For normal text originals, 200 x 200 dpi produces an image that is sufficiently legible.

For photos and illustrations, a high resolution setting (600 x 600 dpi, etc.) will produce a sharp image.

However, a high resolution setting will result in a large file, and if the file is too large, transmission may not be possible.

In this event, reduce the number of pages scanned or take other measures to decrease the file size.

[CHANGING FORMAT IN SCAN OR DATA ENTRY MODE \(page 6-84\)](#)

[CHANGING FORMAT IN INTERNET FAX MODE \(page 6-90\)](#)

[SPECIFYING THE SEND SIZE OF THE IMAGE \(page 6-79\)](#)



When using the automatic document feeder, the resolution setting cannot be changed after scanning has begun. (However, when "Job Build" is used in Others, change the resolution each time a new set of originals is inserted.)



- When using the document glass to scan multiple original pages, change the resolution setting each time you change pages.
- The resolution for Internet Fax mode is set in the system settings.
[Internet Fax Settings \(page 10-109\)](#)

1

Tap the [Detail] key to change to normal mode.

[EASY MODE \(page 6-7\)](#)

2

Tap the [Resolution] key.

3

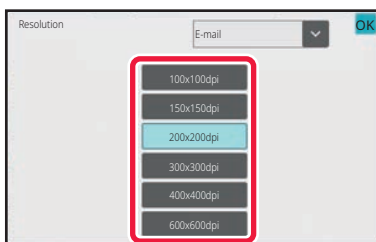

Tap the key of the desired resolution.

After the settings are completed, tap **OK**.



- This cannot be selected when Internet Fax addresses are included.
- If there is a mix of destinations in different modes, tap  to switch modes to set the resolution in each mode. However, FTP/Desktop and Network Folder are set to the same mode.
- If the file format in [File Format] is set to [Compact PDF], then this will set the resolution set in "Compact PDF Resolution Setting" in system settings.



CHANGING FORMAT IN SCAN OR DATA ENTRY MODE

Change the file format (file type and compression mode/compression ratio) for sending a scanned image at the time of transmission. In addition, if the scanned originals are divided into separate files, the number of pages per file can be changed.



The file type of [B/W] mode and the file type of [Color/Grayscale] mode are linked. The file type cannot be set separately for each. (When [JPEG] is selected for [Color/Grayscale] mode, [TIFF] is automatically selected for [B/W] mode.)

File format combinations

[Color/Grayscale] tab	[B/W] tab
PDF*1	PDF*1
Compact PDF*1	PDF*1
Compact PDF (Ultra Fine)*1	PDF*1
PDF/A-1a*1, 2	PDF/A-1a*1, 2
PDF/A-1b*1, 2	PDF/A-1b*1, 2
PDF/A*1, 3	PDF/A*1, 3
Compact PDF/A-1a*1, 2	PDF/A-1a*1, 2
Compact PDF/A-1b*1, 2	PDF/A-1b*1, 2
Compact PDF/A	PDF/A*1, 3
Compact PDF/A-1a (Ultra Fine)*1, 2	PDF/A-1a*1, 2
Compact PDF/A-1b (Ultra Fine)*1, 2	PDF/A-1b*1, 2
Compact PDF/A (Ultra Fine)*1, 3	PDF/A*1, 3
Encrypt PDF*1	Encrypt PDF*1
Encrypt/Compact PDF*1	Encrypt PDF*1
Encrypt/Compact PDF (Ultra Fine)*1	Encrypt PDF*1
TIFF	TIFF
JPEG	TIFF
XPS	XPS
TXT(UTF-8)*2	TXT(UTF-8)*2
RTF*2	RTF*2
DOCX*2	DOCX*2
XLSX*2	XLSX*2
PPTX*2	PPTX*2

*1 When PDF (including encrypted and high compression) is selected for the file format, Flate Compression can be used to reduce the file size.

*2 This item is not displayed when [Disabling of OCR] is set in the system settings.

*3 This item is displayed when [Disabling of OCR] is set in the system settings.



- The file format for sending a scanned image is specified when the destination is stored in a one-touch key; however, you can change the format at the time of transmission.
- If [PDF/Encry.] is specified for the file format, the password entry screen appears when scanning. Enter a password with up to 32 characters.



Note the following when [PDF/High] is specified in the [Color/Grayscale] file format.

- When broadcasting to an address with [PDF/High] specified, all files for the scanner will be sent as Compact PDF files.
- When broadcasting to an address with [PDF/High] and [PDF/Compact/U-Fine] specified, all files for the scanner will be sent as Compact PDF (Ultra Fine) files.
- If [PDF/High] is specified, the resolution cannot be changed in the scanner mode. The resolution set in "Compact PDF Resolution Setting" in system settings is set.
- If [PDF/High] is set when a resolution setting has been specified in scanner (or other) mode, the resolution setting will be canceled and the Compact PDF resolution will be used for transmission.
- When [PDF/High] is selected, [Resolution] cannot be changed while waiting for the next original or in [Change Setting] in the job build settings.
- If [PDF/High] is set when an original type setting has been specified in scanner (or other) mode, [Photo] will change to [Text/Photo] and [Map] will change to [Text/Printed Photo].
- The condition of the original may prevent the OCR function from correctly recognizing some characters and graphics, and omissions or incorrect recognition of characters may result.
- The OCR function is not guaranteed to completely reproduce all characters, graphics, or other contents of a scanned original.

Flate Compression

After compressing a PDF file by JPEG compression, this function compresses the file by lossless compression to further reduce the file size by a small amount. When the data contains significant solid color, this increases the effectiveness of compression.

When sending a PDF file, Flate Compression enables greater reduction of the file size than conventional methods. If the recipient's PDF viewer does not support Flate Compression, the recipient may not be able to view the PDF file. In this case, Flate Compression can be disabled.



To enable Flate Compression

Enable or disable Flate Compression in [System Settings] → [Image Send Settings] → [Scan Settings] → [Condition Settings] → [PDF Compression Options] in "Settings (administrator)".

1

Tap the [File Format] key.

If you are in data input mode, start from step 5.

2

Tap the [Color/Grayscale] or [B/W] key.



- The format setting for [B/W] mode is the file format with the [B/W Start] key is tapped.
- The format setting for [Color/Grayscale] mode is the file format with the [Color Start] key is tapped.
- When [Color/Grayscale] mode is selected, the [Compact] and [U-Fine] checkboxes appear. To suppress image quality deterioration and reduce the data size of a file to be transmitted, select Compact PDF. Select [U-Fine] only when you select Compact PDF.



3

Tap the key of the desired file type.

After the settings are completed, tap **OK**.

When the [B/W] key is selected

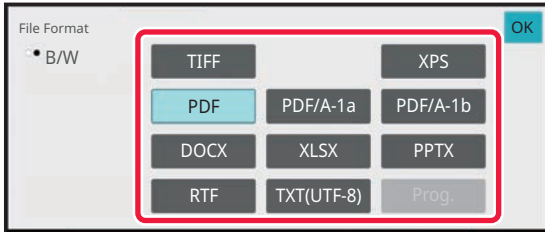

When the [Color/Grayscale] key is selected

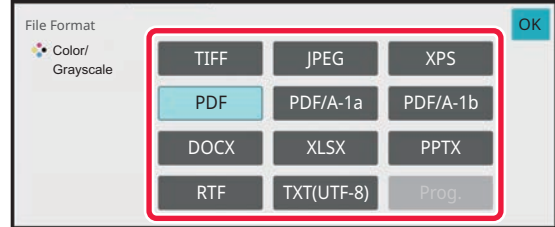

When [Disabling of OCR] is set in the system settings.

When the [B/W] key is selected

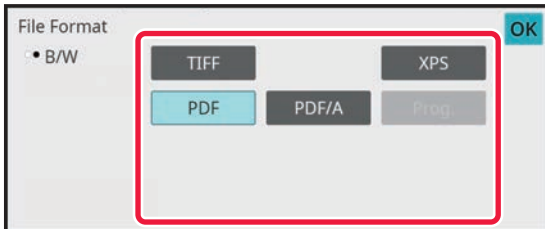

When the [Color/Grayscale] key is selected



4

To enable OCR, select the [OCR] checkbox () and tap [OCR Setting].

After the settings are completed, tap (**OK**).

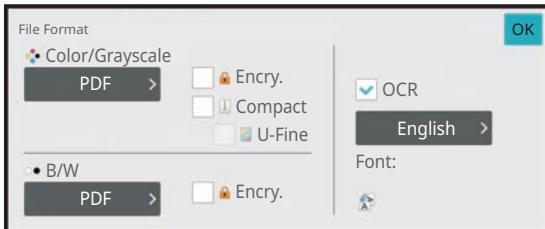



- This procedure cannot be used if [Disabling of OCR] is set in the system settings. Proceed to the next step.
- When "Long Size" is selected for the original, [OCR] cannot be used.
- Select the scanning language in the language settings. The following languages can be selected. Japanese, English, Spanish, French, German, Italian, Dutch, Swedish, Norwegian, Finnish, Danish, Hungarian, Czech, Polish, Russian, Greek, Portuguese, Turkish, Slovak, Catalan, Simplified Chinese, Traditional Chinese, Korean.
- When [RTF], [DOCX], [XLSX], or [PPTX] is selected for the file format, you can set the font of the output text.
- When the [Detect Image Direction] checkbox is selected (), the orientation of the original is detected and the image is rotated before transmission.
- When the [File Name Auto Extraction] checkbox is selected (), the text string that is read from the file is included in the file name. If a file name is set, the set file name will be used for transmission.
- You can set the accuracy of OCR in [OCR Accuracy:]. Select from [Auto] or [Priority Text]. When [Priority Text] is selected, the character reading accuracy is raised before scanning. When [Priority Text] is selected, accuracy in diagram and table areas may be degraded. Only change the setting when you particularly want to increase the accuracy of text areas.
- When the original is scanned while skewed, there is a function which automatically adjusts the skew.
[AUTOMATICALLY ADJUST SKEWED SCAN DATA \(Original Skew Adjustment\) \(page 6-142\)](#)

5

To select more detailed settings, tap the [Detail] key to switch to normal mode.

[EASY MODE \(page 6-7\)](#)

6

Tap the [File Format] key.

7

Tap the [Color/Grayscale] or [B/W] tab and select the format mode for scanning.



- The format setting for [B/W] mode is the file format with the color mode set to [Mono2].
- The format setting for [Color/Grayscale] mode is the file format with the color mode set to [Full Color] or [Grayscale].



8

Tap the key of the desired file type.

When the [B/W] key is selected

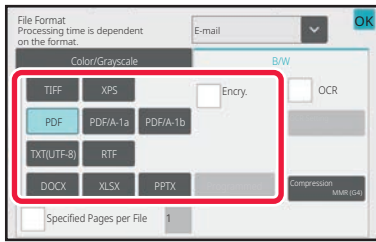

When the [Color/Grayscale] key is selected

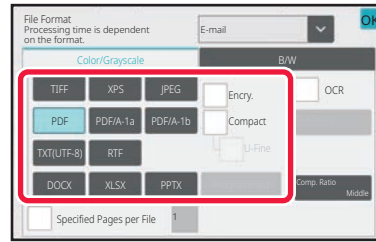

When [Disabling of OCR] is set in the system settings.

When the [B/W] key is selected

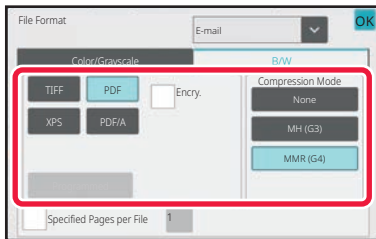

When the [Color/Grayscale] key is selected

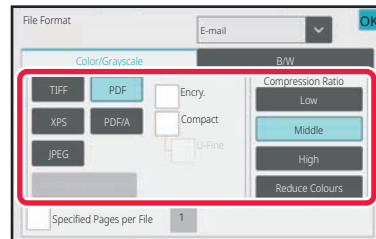

- When [Color/Grayscale] mode is selected, the [Compact] and [U-Fine] checkboxes appear. To suppress image quality deterioration and reduce the data size of a file to be transmitted, select Compact PDF. Select [U-Fine] only when you select Compact PDF.*
- Tap [Original Skew Adjustment] on the action panel to automatically correct the document skew. [AUTOMATICALLY ADJUST SKEWED SCAN DATA \(Original Skew Adjustment\) \(page 6-142\)](#)

9

Tap the [Compression Mode] key or [Compression Ratio] key.



This procedure cannot be used if [Disabling of OCR] is set in the system settings. Proceed to the next step.



10

Tap the Compression key or Compression Ratio key.

When the [B/W] key is selected

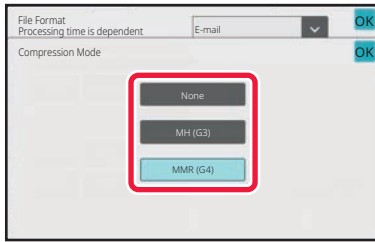

When the [Color/Grayscale] key is selected

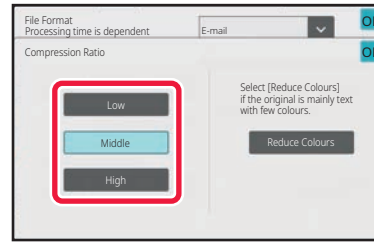

When [Disabling of OCR] is set in the system settings.

When the [B/W] key is selected

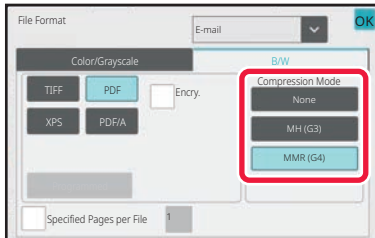

When the [Color/Grayscale] key is selected

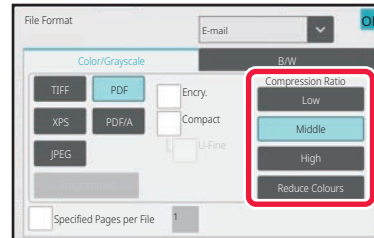

- In the [Color/Grayscale] tab, [Reduce Colors] is a file format that reduces the data size by limiting the number of colors and shades.
- When settings are completed, tap **OK**.

11

To change the number of pages per file, set the [Specified Pages per File] checkbox to , and use numeric keys to specify the number of pages per file.



- When the [Specified Pages per File] checkbox is , one file is created for each of the number of pages at the right. When the checkmark is removed, one file is created for all pages.
- When [Specified Pages per File] is selected, consecutive numbers are added to the created file names.
- When [JPEG] is selected for the file type, one file is created for each page. For this reason, the [Specified Pages per File] checkbox does not appear.



CHANGING FORMAT IN INTERNET FAX MODE

The format for Internet Fax mode is set in the system settings.

► [Internet Fax Settings \(page 10-109\)](#)

CHANGING COLOR MODE

Change the color mode used to scan the original.

In Easy mode

Tap the [B/W Start] or [Color Start] key when scanning the original.



To set the settings used when each key is tapped, select "Settings (administrator)" - [System Settings] → [Image Send Settings] → [Scan Settings] → [Initial Status Settings] → [Easy Scan Settings].

In Normal mode

Mode	Scanning method
Auto	The machine detects whether the original is color or black and white and automatically selects full color or black and white (Mono2 or Grayscale) scanning.
Full Color	The original is scanned in full color. This mode is best for full color originals such as catalogues.
Mono2	Colors in the original are scanned as black or white. This mode is best for text-only originals.
Grayscale	The colors in the original are scanned in black and white as shades of gray (grayscale).



This function cannot be used in Internet fax mode.

1

Tap the [Detail] key to switch to the normal mode.

► [EASY MODE \(page 6-7\)](#)

2

Tap the [Color Mode] key.

3

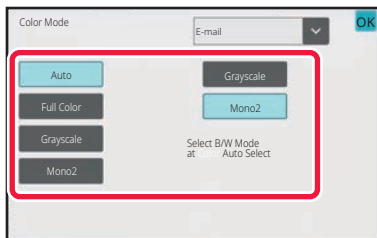

Tap the key of the desired color mode for the original.



If there is a mix of destinations in different send modes, tap  to select a send mode (E-mail, DeskTop/FTP or Data Entry) to set the color mode for each mode.



4

Tap the [Grayscale] or [Mono2] key to set the B/W mode for automatic color selection.

Specify whether Mono2 or grayscale is used when scanning black and white originals.
Note that if the file format is set to JPEG, scanning will take place in grayscale.
After the settings are completed, tap **OK**.



The B/W mode can be set only when the [Auto] key is selected in the color mode setting (step 3).



SETTING SCAN SETTINGS AUTOMATICALLY (Auto Set)

To automatically set scan settings appropriate for the original, tap the [Auto Set] key in the base screen of Easy Mode.

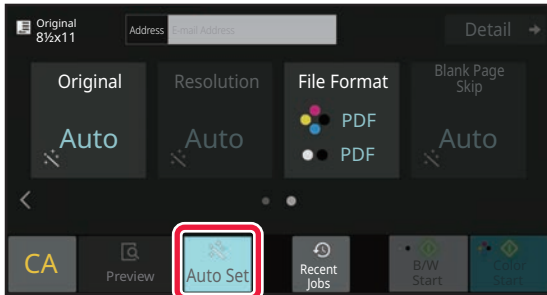

The following functions are set automatically.

- Image Orientation*1
- 1-Sided/2-Sided*1
- Resolution
- Blank Page Skip
- Automatically detecting mono2/grayscale
- Automatically adjusting the original skew
- Business Card Scan*1
- Automatically detecting the original size*2
- Automatically detecting the compression ratio

Each function setting value/parameter can be changed in setting mode.

*1 When the OCR function is enabled.

*2 When using the automatic document feeder.



- When "Auto Set" is enabled, grayed out functions cannot be enabled.
- When an Internet Fax address is selected, "Auto Set" cannot be enabled.



CHECKING THE IMAGE TO BE TRANSMITTED

Check the image that will be sent in the touch panel before transmission.

You can tap the [Preview] key to check a preview of the image before sending an image.

As you can adjust the exposure and resolution to scan the original while checking it in the preview screen, you can send a better quality original to the destination.



- Depending on the size of the transmission data, part of the preview image may not appear in the preview screen in the touch panel.
- The preview function is not available when the original size is set to Long Size.



OTHER FUNCTIONS

STORING SCAN OPERATIONS (PROGRAM)

This function collectively stores various settings as one program. The stored program can be retrieved using an easy operation.

For example, suppose 8-1/2" x 11" (A4) size documents are scanned into a file and sent to each branch office once a month.

- The same documents are sent to each branch office
- Each page of a bound document is successively transmitted
- Smudges on the edges of the documents are erased before transmission

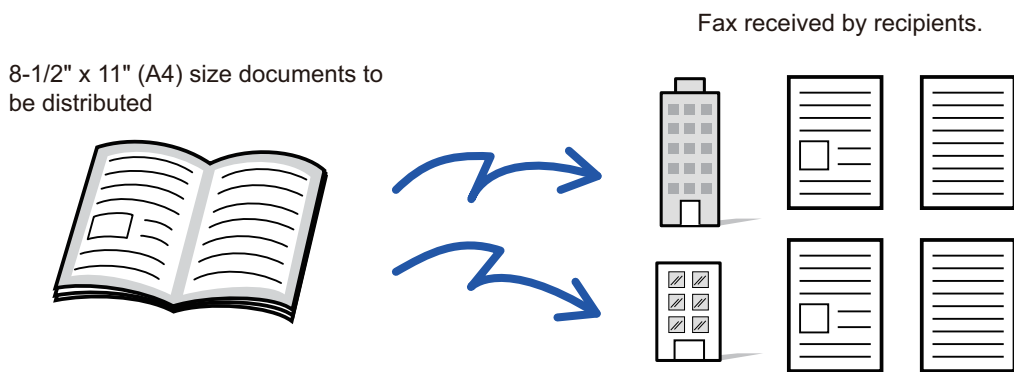

When a job program is not stored	When a job program is stored
<p>Enter the address of each branch office.</p> <p style="text-align: center;">↓</p> <p>Select Dual Page Scan.</p> <p style="text-align: center;">↓</p> <p>Specify Erase.</p> <p style="text-align: center;">↓</p> <p>Tap the [Start] key. Scan and send the original.</p>	<p>Tap the key of a stored program.</p> <p style="text-align: center;">↓</p> <p>Tap the [Start] key. Scan and send the original.</p>
<p>Considerable time is required to send the documents each month because the above settings must be selected. In addition, mistakes are occasionally made when selecting the settings.</p>	<p>When a program is stored, settings are selected with ease by simply tapping the key of the program. In addition, transmission takes place based on the stored settings so there are no chances for mistakes.</p>



To configure a program:

Tap [Program Registration] on the action panel that appears when you operate any mode screens.



- The settings stored in a program will be retained even after the program is used for transmission. The same settings can be used repeatedly for transmission.
- The following contents cannot be stored in programs:
 - Quick File
 - File
 - Page changes and unspecified erases during preview
 - Reply to/Add 'Reply to' to Cc
 - Own Name
 - Sign E-mail
 - Encrypt E-mail
- Up to 48 programs can be stored.
- Up to 500 destinations can be stored in one program.
- When registering a program, if the subject name or file name use the pre-set text set in the system, then by changing the pre-set text in system settings the program will call the changed subject name and file name. (If the pre-set text registered in the program is deleted, then the subject name and file name will be blank.)



This function cannot be used in data entry mode.

1

Tap the [Detail] key to switch to the normal mode.

[EASY MODE \(page 6-7\)](#)

2

Place the original and tap [Call Program] on the action panel.

According to the function stored in the program, place the original in the document feeder tray of the automatic document feeder, or on the document glass.

[AUTOMATIC DOCUMENT FEEDER \(page 1-34\)](#)

[DOCUMENT GLASS \(page 1-38\)](#)

3



Tap the desired program key.

The normal mode screen at program registration is displayed. If registered in other modes, then switch the screen.

4

Configure additional settings if needed.



Some settings cannot be added depending on the contents of the called program.



5

Tap the [Start] key to start scanning of the original.

- A beep will sound to indicate that scanning and transmission have ended.
- When you place the original on the document glass, scan each page one at a time.
When scanning finishes, place the next original and tap the [Start] key.
Repeat until all pages have been scanned and then tap the [Read-End] key.



You can tap the [Preview] key to check a preview of the image before sending an image. For more information, see "[CHECKING THE IMAGE TO BE TRANSMITTED \(page 6-93\)](#)".



SCANNING AND SENDING ORIGINALS COLLECTIVELY

SENDING TWO PAGES AS A SINGLE PAGE (N-Up)

Reduce two original pages to the equal size and send them as a single page. This function is convenient when you have a large number of original pages and wish to reduce the number of pages sent.

For the standard size (8-1/2" x 11" (A4) or 5-1/2" x 8-1/2" (B5 or A5)), original pages are scanned from both the single pass feeder and document glass.

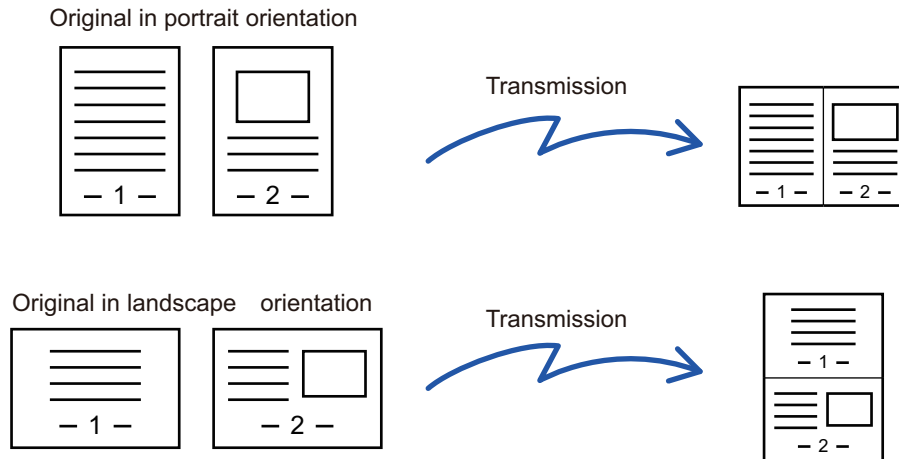

- This function cannot be used in scan mode or data entry mode.
- The N-Up is only available for originals with 8-1/2" x 11" (A4) or 5-1/2" x 8-1/2" (B5 or A5) size.
- Transmission is not possible at a size smaller than the original size.
- When the scan size of the original is specified by numeric values, this function cannot be used.
- This function cannot be used together with Dual Page Scan or Card Shot.

1

Place the original.

Place the original in the document feeder tray of the automatic document feeder, or on the document glass. When in fax mode, then after completing this procedure, proceed to Step 3.

[AUTOMATIC DOCUMENT FEEDER \(page 1-34\)](#)

[DOCUMENT GLASS \(page 1-38\)](#)

2

Tap the mode display to switch to the initial screen of Internet Fax mode.

[CHANGING MODES \(page 2-10\)](#)



3

Specify the destination.

- [RETRIEVING A DESTINATION FROM AN ADDRESS BOOK \(page 6-33\)](#)
- [VIEWING A LIST OF THE SELECTED DESTINATIONS \(page 6-36\)](#)
- [USING A SEARCH NUMBER TO RETRIEVE A DESTINATION \(page 6-37\)](#)
- [ENTERING AN ADDRESS MANUALLY \(page 6-38\)](#)
- [SPECIFYING A NETWORK FOLDER \(page 6-39\)](#)
- [RETRIEVING A DESTINATION FROM A GLOBAL ADDRESS BOOK \(page 6-41\)](#)
- [RETRIEVING A DESTINATION FROM A MOBILE ADDRESS BOOK \(page 6-43\)](#)
- [USING A TRANSMISSION LOG TO RESEND \(page 6-45\)](#)

When in fax mode, enter the destination number.

- [ENTERING A DESTINATION NUMBER USING THE NUMERIC KEYS \(page 5-10\)](#)
- [RETRIEVING A DESTINATION FROM AN ADDRESS BOOK \(page 5-11\)](#)
- [USING A SEARCH NUMBER TO RETRIEVE A DESTINATION \(page 5-14\)](#)
- [RETRIEVING A DESTINATION FROM A GLOBAL ADDRESS BOOK \(page 5-15\)](#)
- [RETRIEVING A DESTINATION FROM A MOBILE ADDRESS BOOK \(page 5-17\)](#)
- [USING A TRANSMISSION LOG TO RESEND \(page 5-19\)](#)

4

Tap the [Others] key, and tap the [N-Up] key.

A checkmark appears on the icon.
After the settings are completed, tap the [Back] key.



To cancel the N-Up setting

Tap the [N-Up] key to uncheck it.

5

Tap the [Original] key.

6

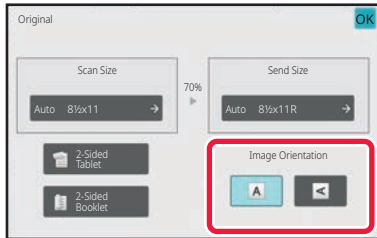

Tap the [Image Orientation] key with the same orientation as the original image.

If this setting is not correct, a suitable image may not be transmitted.
After the settings are completed, tap **OK**.

7

Tap the [Start] key to start scanning of the original.

- If you inserted the original pages in the document feeder tray, all pages are scanned. A beep will sound to indicate that scanning and transmission have ended.
- When you place the original on the document glass, scan each page one at a time. When scanning finishes, place the next original and tap the [Start] key. Repeat the procedure until all pages have been scanned and then tap the [Read-End] key. A beep will sound to indicate that scanning and transmission have ended.



You can tap the [Preview] key to check a preview of the image before sending an image. For more information, see "[CHECKING THE IMAGE TO BE TRANSMITTED \(page 6-93\)](#)" (When in fax mode, "[CHECKING THE IMAGE TO BE TRANSMITTED \(page 5-28\)](#)").

Tap the [Change Setting] key in the scan-end confirmation screen to change the exposure, resolution, scan size, and send size. (However, when scanning each even-numbered page of the original, only the exposure is changed.)



SCANNING ORIGINALS OF DIFFERENT SIZES (MIXED SIZE ORIGINAL)

Scan originals of different sizes at the same time; for example, when 8-1/2" x 14" (B4) size originals are mixed together with 11" x 17" (A3) size originals.

When scanning the originals, the machine automatically detects the size of each original.



This function can only be used with the combinations of original sizes as shown below.

- 11" x 17" and 8-1/2" x 14", 11" x 17" and 8-1/2" x 13", and 11" x 17" and 5-1/2" x 8-1/2"
- A3 and B4, A3 and B5, B4 and A4, and A4 and B5
- A4R and B5, B4 and A4R, B4 and A5, and B5 and A5
- A3, B4 and A4R, A3, B4 and A5, A3, A4R and B5, A3, B5 and A5, B4, A4R and A4, B4, A4 and A5, A4, A4R and B5, A4, B5 and A5
- B4, A4R and B5R, B4, B5R and A5, A4R, B5R and B5, B5, B5R and A5



- Mixed size scanning is not possible when "Settings (administrator)" - [System Settings] → [Common Settings] → [Device Control] → [Condition Settings] or [Enable/Disable Settings] → [Disabling of Document Feeder] is enabled.
- When Mixed Size Original is selected, an original scan size cannot be specified.
- After the original scan size has been selected, Mixed Size Original cannot be specified.
- Rotate cannot be used when Mixed Size Original is enabled.
- This function is not available if [System Settings] → [Common Settings] → [Device Control] → [Condition Settings] → [Original Size Detector Setting] is set to "AB-3" in "Settings (administrator)".

1

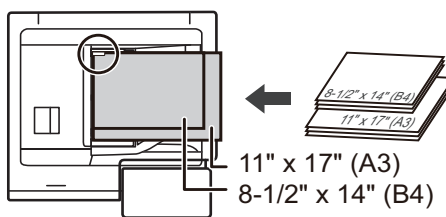

Place the original in the document feeder tray of the automatic document feeder.

Insert the originals with the corners aligned together in the far left corner of the document feeder tray.

When in fax mode, then after completing this procedure, proceed to Step 3.

[AUTOMATIC DOCUMENT FEEDER \(page 1-34\)](#)

2

Tap the mode display to switch to the initial screen of each mode.

[CHANGING MODES \(page 2-10\)](#)



3

Specify the destination.

[RETRIEVING A DESTINATION FROM AN ADDRESS BOOK \(page 6-33\)](#)

[VIEWING A LIST OF THE SELECTED DESTINATIONS \(page 6-36\)](#)

[USING A SEARCH NUMBER TO RETRIEVE A DESTINATION \(page 6-37\)](#)

[ENTERING AN ADDRESS MANUALLY \(page 6-38\)](#)

[SPECIFYING A NETWORK FOLDER \(page 6-39\)](#)

[RETRIEVING A DESTINATION FROM A GLOBAL ADDRESS BOOK \(page 6-41\)](#)

[RETRIEVING A DESTINATION FROM A MOBILE ADDRESS BOOK \(page 5-17\)](#)

[USING A TRANSMISSION LOG TO RESEND \(page 6-45\)](#)

When in fax mode, enter the destination number.

[ENTERING A DESTINATION NUMBER USING THE NUMERIC KEYS \(page 5-10\)](#)

[RETRIEVING A DESTINATION FROM AN ADDRESS BOOK \(page 5-11\)](#)

[USING A SEARCH NUMBER TO RETRIEVE A DESTINATION \(page 5-14\)](#)

[RETRIEVING A DESTINATION FROM A GLOBAL ADDRESS BOOK \(page 5-15\)](#)

[RETRIEVING A DESTINATION FROM A MOBILE ADDRESS BOOK \(page 5-17\)](#)

[USING A TRANSMISSION LOG TO RESEND \(page 5-19\)](#)

4

Tap the [Mixed Size Original] key. Otherwise, tap the [Others] key, and tap the [Mixed Size Original] key.

A checkmark appears on the icon.

After the settings are completed, tap the [Back] key.



For mixed size originals, set "Original" to "Auto".

**To cancel the mixed size original setting**

Tap the [Mixed Size Original] key to uncheck it.

5

Tap the [Start] key to start scanning of the original.

A beep will sound to indicate that scanning and transmission have ended.



Tap the [Preview] key to check the preview of an image before sending a fax. For more information, see "[CHECKING THE IMAGE TO BE TRANSMITTED \(page 6-93\)](#)" (When in fax mode, "[CHECKING THE IMAGE TO BE TRANSMITTED \(page 5-28\)](#)"). However, settings for this function cannot be changed in the preview screen.



SCANNING BOTH SIDES OF A CARD ONTO A SINGLE PAGE (CARD SHOT)

Send the front and reverse sides of a card as a single page, without the need to send each side separately.

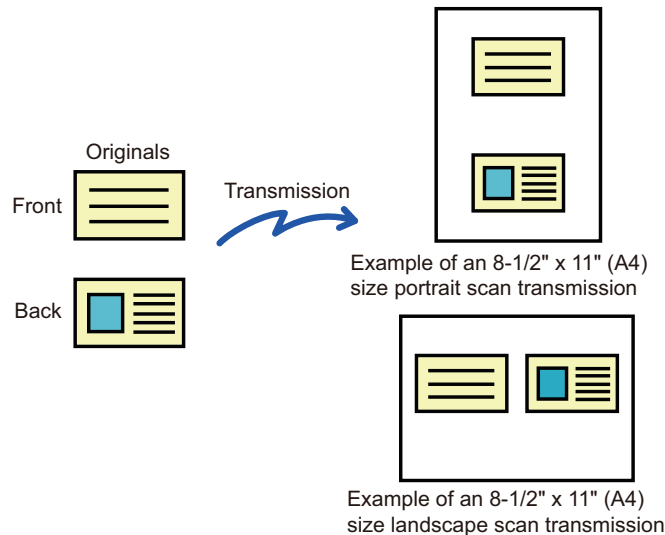

- If the scan size is larger than the send size, it will result in a sending failure.
- The ratio cannot be specified and "Rotation Sending Setting" cannot be selected.

1

Place a card face down on the document glass.

When in fax mode, then after completing this procedure, proceed to Step 3.
[DOCUMENT GLASS \(page 1-38\)](#)

2

Tap the mode display to switch to the initial screen of each mode.

[CHANGING MODES \(page 2-10\)](#)

3

Specify the destination.

[RETRIEVING A DESTINATION FROM AN ADDRESS BOOK \(page 6-33\)](#)
[VIEWING A LIST OF THE SELECTED DESTINATIONS \(page 6-36\)](#)
[USING A SEARCH NUMBER TO RETRIEVE A DESTINATION \(page 6-37\)](#)
[ENTERING AN ADDRESS MANUALLY \(page 6-38\)](#)
[SPECIFYING A NETWORK FOLDER \(page 6-39\)](#)
[RETRIEVING A DESTINATION FROM A GLOBAL ADDRESS BOOK \(page 6-41\)](#)
[RETRIEVING A DESTINATION FROM A MOBILE ADDRESS BOOK \(page 5-17\)](#)
[USING A TRANSMISSION LOG TO RESEND \(page 6-45\)](#)

When in fax mode, enter the destination number.

[ENTERING A DESTINATION NUMBER USING THE NUMERIC KEYS \(page 5-10\)](#)
[RETRIEVING A DESTINATION FROM AN ADDRESS BOOK \(page 5-11\)](#)
[USING A SEARCH NUMBER TO RETRIEVE A DESTINATION \(page 5-14\)](#)
[RETRIEVING A DESTINATION FROM A GLOBAL ADDRESS BOOK \(page 5-15\)](#)
[RETRIEVING A DESTINATION FROM A MOBILE ADDRESS BOOK \(page 5-17\)](#)
[USING A TRANSMISSION LOG TO RESEND \(page 5-19\)](#)



4

Tap the [Others] key, and tap the [Card Shot] key.

5

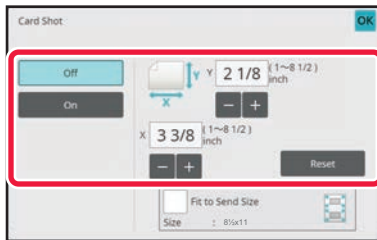

Tap the [On] key, and specify the original size as required.

After the settings are completed, tap **OK** and [Back] keys in sequence.



- Tap the areas displaying width and height sizes respectively, and enter the sizes using the numeric keys.
- To quickly set the size, first specify a value close to the desired ratio value by the numeric keys, then tap [-] or [+] for adjustment .
- To enlarge or reduce the images to fit the paper based on the entered original size, tap the [Fit to Send Size] key.
- After selecting Card Shot, tap the [Original] key in the base screen to change the original scan size or the send size. In this case, the screen of this step appears when you tap the scan size key. For the procedure for setting the send size, see [“SPECIFYING THE SEND SIZE OF THE IMAGE \(page 6-79\)”](#) (When in fax mode, [“SPECIFYING THE SEND SIZE OF THE IMAGE \(page 5-52\)”](#)).



To cancel the Card Shot settings

Tap the [Off] key.

6

Tap the [Start] key, and scan the front side.

7

Place a card face up on the document glass, and tap the [Start] key to scan the reverse side.



Before scanning the back of the card, tap the [Change Setting] key on the touch panel to change the exposure.

8

Tap the [Read-End] key.



If you will continue by scanning the front of the card, you can tap the [Change Setting] key to change the exposure, resolution, scan size, and send size.



SIMULTANEOUSLY SCANNING MULTIPLE CARDS, RECEIPTS OR OTHER SMALL ORIGINALS TO INDIVIDUAL FILES (MULTICROP)

This function automatically crops and scans multiple cards, receipts, or other small originals placed on the document glass to individual files.

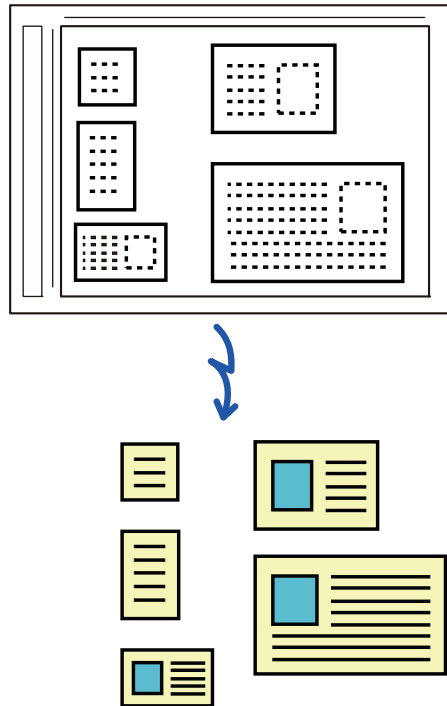

This function can be used with Scan to E-mail, Scan to FTP/Desktop, Scan to Network Folder, and Save to External Memory Device.

The e-mail will be sent without being divided if System Settings - [Image Send Settings] → [Scan Settings] → [Condition Settings] → [If the E-mail attachment(s) exceed maximum size, it will be sent in multiple files.] is enabled and [Maximum Size of Send Data (E-Mail)] is set. If the transmitted e-mail exceeds the limit, a send error occurs.



1

Place the multiple originals that you want to scan on the document glass.[DOCUMENT GLASS \(page 1-38\)](#)**Cautions when placing the originals**

- Up to 50 originals can be placed at once.
- Separate the originals by at least 5 mm.
- Available originals sizes are 40 to 297 mm in height and 40 to 432 mm in width.
- If the shape of an original is not square or rectangular, the original may not be cropped correctly.

2

Keep the auto document feeder open, not closed.

If you scan the originals with the auto document feeder closed, it will not be possible to detect the outlines of the originals and scanning will fail. Always use this function with the auto document feeder open. If a light source such as an electric light shines onto the originals during scanning, cropping may not be successful. Adjust the angle of the automatic document feeder so that the light source does not affect the image.



Do not look directly at the light during scanning.

3

Tap the mode display and change to the base screen of the desired mode.[CHANGING MODES \(page 2-10\)](#)

4

Specify the destination.[RETRIEVING A DESTINATION FROM AN ADDRESS BOOK \(page 6-33\)](#)[VIEWING A LIST OF THE SELECTED DESTINATIONS \(page 6-36\)](#)[USING A SEARCH NUMBER TO RETRIEVE A DESTINATION \(page 6-37\)](#)[ENTERING AN ADDRESS MANUALLY \(page 6-38\)](#)[SPECIFYING A NETWORK FOLDER \(page 6-39\)](#)[RETRIEVING A DESTINATION FROM A GLOBAL ADDRESS BOOK \(page 6-41\)](#)[RETRIEVING A DESTINATION FROM A MOBILE ADDRESS BOOK \(page 5-17\)](#)[USING A TRANSMISSION LOG TO RESEND \(page 6-45\)](#)

5

Tap the [Others] key, and tap the [Multicrop] key.

A checkmark appears on the icon. When you have completed the setting, tap the [Back] key.



When original count is enabled, the number of scanned originals will appear during scanning.



- To cancel the multicrop setting
- Tap the [Multicrop] key to remove the checkmark.



6

Tap the [Start] key to start scanning the originals.

When scanning is completed, place the next originals and tap the [Start] key.
Repeat the above step until you have scanned all originals, and then tap the [Read-End] key.
When transmission is completed, a beep sounds.

**• Restrictions when multicrop is enabled**

The following restrictions apply when multicrop is enabled. Restricted items may change automatically in some cases.

- Resolution: 600 x 600 dpi cannot be used.
- Scan size / send size: Only auto can be used.
- Two-sided original: Only one-sided original is enabled.
- Image Orientation: Cannot be used. (Each cropped original is corrected to the orientation that is least skewed.)
- Format: High compression and ultra-fine cannot be used.
- Compression / compression format: Reduce Colors cannot be used.
- One file per page: Cannot be set when the checkmark is enabled and the number is "1".
- The following functions cannot be used at the same time as multicrop.
Job Build, Slow Scan Mode, Mixed Size Original, Erase, Dual Page Scan, Book Divide, Card Shot, Blank Page Skip, File, Quick File, Preview, Business Card Scan, Image Crop
- When the Multicrop setting is canceled, the following items retain the setting changes that occurred when Multicrop was enabled.
Resolution, Scan Size, Send Size, 2-Sided Original, File Type, OCR, Compression Mode/Compression Ratio, Specified Pages per File
- Depending on the original, it may not be extracted to the file correctly.



SCANNING A BUSINESS CARD, READING THE TEXT STRING, CREATING A FILE, AND SENDING THE FILE (BUSINESS CARD SCAN)

(When OCR function is enabled in system settings)

You can scan a business card, extract the name and telephone number from the text string read by OCR, and create and send a vCard or other file.



- If [Disabling of OCR] is set in the system settings, business card scanning can be used, but only the image will be scanned and the business card information will not be scanned.
- This function can be used with Scan to E-mail, Scan to FTP/Desktop, Scan to Network Folder, and Save to External Memory Device.
The e-mail will be sent without being divided if System Settings - [Image Send Settings] → [Scan Settings] → [Condition Settings] → [If the E-mail attachment(s) exceed maximum size, it will be sent in multiple files.] is enabled and [Maximum Size of Send Data (E-Mail)] is set. If the transmitted e-mail exceeds the limit, a send error occurs.

For the information that can be extracted and output from a scanned business card, refer to the table below.

Item	Description
Name	The name is extracted.
Kana	When the language is set to Japanese, you can convert the name to kana.
Pinyin	When the language is set to Chinese, you can convert the name to pinyin.
Postal code	The postal code is extracted.
Address	The address is extracted.
Company/group name	The company/organization name is extracted.
Department	The department is extracted.
Job title	The position is extracted.
Telephone number	The telephone number is extracted. Up to five.
Fax number	The fax number is extracted. Up to five.
URL	The URL is extracted. Up to five.
E-mail address	The E-mail address is extracted.
Other	Other is used if none of the above apply.



1

Place the multiple business cards that you want to scan in the document feeder tray of the automatic document feeder or on the document glass.

You can scan business cards by setting them in the automatic document feeder.

[AUTOMATIC DOCUMENT FEEDER \(page 1-34\)](#)

[DOCUMENT GLASS \(page 1-38\)](#)

**Cautions when placing business cards**

- Up to 20 business cards can be placed at once.
- Separate the business cards by at least 5 mm.
- Available business card sizes are 45 x 85 mm to 110 x 110 mm.
- If the shape of a business card is not square or rectangular, the business card may not be cropped correctly.
- Place the business cards with the top side of the cards at the far side of the document glass as shown. If the cards are placed in the wrong orientation, it will not be possible to read the cards correctly.

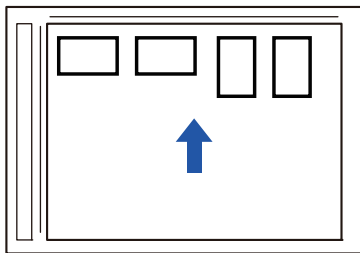
**Notes on loading business cards in the automatic document feeder**

- Up to 150 business cards (or a maximum loading height of 38 mm) can be scanned at one time.
- Supported business card sizes range from 51 x 89 mm to 55 x 91 mm.
- If the business card is not square or rectangular in shape, the business card will misfeed.
- When scanning a business card, be sure to set the image orientation.

2

(When using the document glass) Keep the auto document feeder open, not closed.

If you scan the business cards with the auto document feeder closed, it will not be possible to detect the outlines of the business cards and scanning will fail. Always use this function with the auto document feeder open. If a light source such as an electric light shines onto the originals during scanning, cropping may not be successful. Adjust the angle of the automatic document feeder so that the light source does not affect the image.



Do not look directly at the light during scanning.

3

Tap the mode display and change to the base screen of the desired mode.

[CHANGING MODES \(page 2-10\)](#)



4

Specify the destination.

- [RETRIEVING A DESTINATION FROM AN ADDRESS BOOK \(page 6-33\)](#)
- [VIEWING A LIST OF THE SELECTED DESTINATIONS \(page 6-36\)](#)
- [USING A SEARCH NUMBER TO RETRIEVE A DESTINATION \(page 6-37\)](#)
- [ENTERING AN ADDRESS MANUALLY \(page 6-38\)](#)
- [SPECIFYING A NETWORK FOLDER \(page 6-39\)](#)
- [RETRIEVING A DESTINATION FROM A GLOBAL ADDRESS BOOK \(page 6-41\)](#)
- [RETRIEVING A DESTINATION FROM A MOBILE ADDRESS BOOK \(page 6-43\)](#)
- [USING A TRANSMISSION LOG TO RESEND \(page 6-45\)](#)

5

Tap the [Others] key, and tap the [Business Card Scan] key.

When [Disabling of OCR] is set in the system settings, tap the [Business Card Scan] key and then a checkmark appears on the icon. After the settings are completed, tap the [Back] key.

6

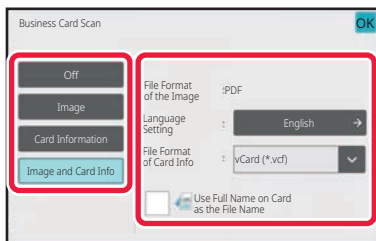
**Tap the [On] key, and change settings as needed.**

When you have completed the settings, tap the  key and then the [Back] key.



- This procedure cannot be used when [Disabling of OCR] is set in the system settings. Proceed to the next step.
- If original count is enabled, the number of scanned originals will appear during scanning.
- Change the language setting to match the language used on the business card. For the language settings, refer to [“CHANGING FORMAT IN SCAN OR DATA ENTRY MODE \(page 6-84\)”](#).
- To use the full name as the file name, enable [Use Full Name on Card as the File Name].
- To send the scanned image file together with the file format selected in [File Format], enable [Also Send Image].

**To cancel the business card scan setting**

Tap the [Off] key.



7

Tap the [Start] key to start scanning the originals.

When scanning is completed, place the next group of originals and tap the [Start] key.

Repeat the above step until you have scanned all originals, and then tap the [Read-End] key.

When transmission is completed, a beep sounds.

The image of the scanned business card is sent together with the VCard or CSV file set in File Format.

**• Restrictions when Business Card Scan is enabled**

The following restrictions apply when Business Card Scan is enabled. Restricted items may change automatically in some cases.

- Resolution: When [Image] is selected, except 600dpi can be used. When [Card Information] or [Image and Card Info] is selected, only 300 dpi and 400 dpi can be used.
- Scan size / send size: Only auto can be used.
- Two-sided original: When scanning from the automatic document feeder, if you select a setting other than [Card Information], 2-sided documents can be scanned. Otherwise, only 1-sided documents can be scanned.
- Image Orientation: Cannot be used. (Each cropped original is corrected to the orientation that is least skewed.)
- Format: High compression and ultra-fine cannot be used.
- Compression / compression format: Reduce Colors cannot be used.
- One file per page: Cannot be set when the checkmark is enabled and the number is "1".
- The following functions cannot be used at the same time as multicrop.
Job Build, Slow Scan Mode, Mixed Size Original, Erase, Dual Page Scan, Book Divide, Card Shot, Blank Page Skip, File, Quick File, Preview, Multicrop, Image Crop
- When the Business Card Scan setting is canceled, the following items retain the setting changes that occurred when Business Card Scan was enabled.
Resolution, Scan Size, Send Size, 2-Sided Original, File Type, OCR, Compression Mode/Compression Ratio, Specified Pages per File
- Depending on the business card, it may not be extracted to the file correctly.



File names

The user can assign any file name to a file.

When [Use Full Name on Card as the File Name] is enabled, the name on a scanned business card can be assigned as the file name.

If you do not set a file name, the machine will assign an automatically generated file name.

File name rules

File names are assigned as follows in each setting.

Setting	File	File name	Description
User entry	vCard	User_0001.vcf User_0002.vcf	The name entered by the user ("User" in this case) is inserted at the beginning of the file name.
	CSV	User.csv	
	Scanned image	User_0001.jpg User_0002.jpg	
File name auto extraction	vCard	AAAAAA_0001.vcf AAAAAA_0002.vcf BBBBBB_0001.vcf Untitled_0001.vcf Untitled_0002.vcf	Example: The names read from business cards are "AAAAAA", "BBBBB" When there are cards with the same first and last name such as "AAAAAA", the number at the end is a serial number. If the name could not be read, the file name is "Untitled". If there are multiple untitled files, the number at the end is a serial number.
	CSV	AAAAAA_0001.csv	
	Scanned image	AAAAAA_0001.jpg AAAAAA_0002.jpg BBBBBB_0001.jpg Untitled_0001.jpg Untitled_0002.jpg	
Automatic generation	vCard	MXxxxx_yyyyyy_zzzzzz_0001.vcf MXxxxx_yyyyyy_zzzzzz_0002.vcf	"xxxx" is the model name, "yyyyyy" is the scan date, and "zzzzzz" is the scan time.
	CSV	MXxxxx_yyyyyy_zzzzzz_0001.csv	
	Scanned image	MXxxxx_yyyyyy_zzzzzz_0001.jpg MXxxxx_yyyyyy_zzzzzz_0002.jpg	



- If the user sets a file name when file name auto extraction is enabled, the user's file name is given priority.



SCANNING MULTIPLE PHOTOS AT ONCE TO INDIVIDUAL FILES (Image Crop)

This function automatically scans photographs placed on the document glass to individual files.

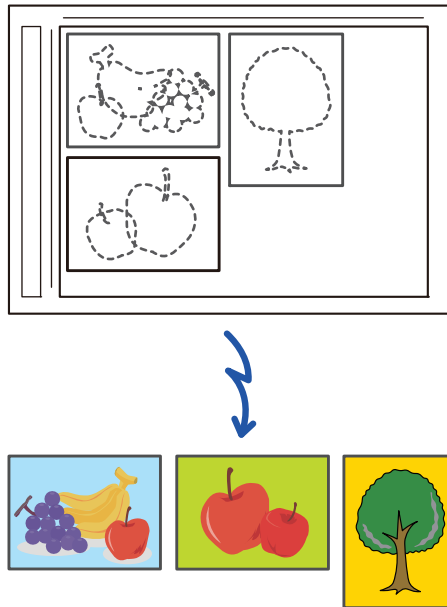

This function can be used with Scan to E-mail, Scan to FTP/Desktop, Scan to Network Folder, and Save to External Memory Device.

Settings (administrator) - "Image Send Settings" → "Scan Settings" → "Condition Settings" → "If the E-mail attachment(s) exceed maximum size, it will be sent in multiple files." is not applied.

If the transmitted e-mail exceeds the limit, a send error will occur.

1

Place the multiple originals that you want to scan on the document glass.

[DOCUMENT GLASS \(page 1-38\)](#)



Cautions when placing the originals

- Up to 50 originals can be placed at once.
- Separate the originals by at least 5 mm.
- Available originals sizes are 40 to 297 mm in height and 40 to 432 mm in width.
- If the shape of an original is not square or rectangular, the original may not be cropped correctly.
- The top and bottom of each original cannot be distinguished automatically, so take care to orient the originals appropriately.

2

Close the automatic document feeder.

The scanning method is different from multi-crop. Close the automatic document feeder.

3

Tap the mode display and change to the home screen of the desired mode.

[CHANGING MODES \(page 2-10\)](#)



4

Specify the destination.

- [RETRIEVING A DESTINATION FROM AN ADDRESS BOOK \(page 6-33\)](#)
- [VIEWING A LIST OF THE SELECTED DESTINATIONS \(page 6-36\)](#)
- [USING A SEARCH NUMBER TO RETRIEVE A DESTINATION \(page 6-37\)](#)
- [ENTERING AN ADDRESS MANUALLY \(page 6-38\)](#)
- [SPECIFYING A NETWORK FOLDER \(page 6-39\)](#)
- [RETRIEVING A DESTINATION FROM A GLOBAL ADDRESS BOOK \(page 6-41\)](#)
- [RETRIEVING A DESTINATION FROM A MOBILE ADDRESS BOOK \(page 6-43\)](#)
- [USING A TRANSMISSION LOG TO RESEND \(page 6-45\)](#)

5

Tap the [Others] key, and tap the [Image Crop] key.

A checkmark appears on the icon. After the settings are completed, tap the [Back] key.



- When original count is enabled, the number of scanned originals will appear during scanning.



To cancel the image crop setting

- Tap the [Image Crop] key to remove the checkmark.

6

Tap the [Start] key to start scanning the originals.

- When scanning is completed, place the next group of originals and tap the [Start] key.
- Repeat the above step until you have scanned all originals, and then tap the [Read-End] key.
- When transmission is completed, a beep sounds.



• Restrictions when image crop is enabled

The following restrictions apply when image crop is enabled. Restricted items may change automatically in some cases.

- Scan size / send size: Only auto can be used.
- Two-sided original: Only one-sided original is enabled.
- Image Orientation: Cannot be used. (Each cropped original is corrected to the orientation that is least skewed.)
- Format: High compression and ultra-fine cannot be used.
- Compression / compression format: Reduce Colors cannot be used.
- One file per page: Cannot be set when the checkmark is enabled and the number is "1".
- The following functions cannot be used at the same time as image crop.
Job Build, Slow Scan Mode, Mixed Size Original, Erase, Dual Page Scan, Book Divide, Card Shot, Blank Page Skip, File, Quick File, Preview, Multicrop Business Card Scan
- When the image crop setting is canceled, the following items retain the setting changes that occurred when image crop was enabled.
Resolution, Scan Size, Send Size, 2-Sided Original, File Type, OCR, Compression Mode/Compression Ratio, Specified Pages per File
- Depending on the photo, it may not be extracted to the file correctly.



SCANNING MANY ORIGINALS AT ONCE (JOB BUILD)

This function lets you separate an original consisting of numerous pages into sets, scan each set using the automatic document feeder, and transmit the pages in a single transmission. You can also send a fax by placing originals in both the automatic document feeder and on the document glass.

Use this function when there are more original pages than can be placed at once in the automatic document feeder.

When scanning originals that are separated into sets, scan the set that has the first page first.

The settings that you select for the first set can be used for all remaining sets.

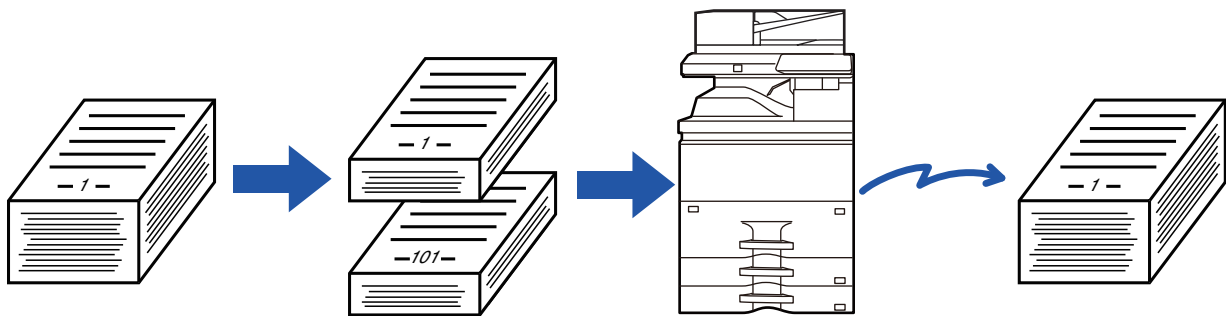

- To change all original settings, configure before scanning the original.
- Up to 9999 (excluding Internet Fax) pages can be scanned.
 - Note that when the memory is being used for other jobs, fewer pages can be scanned.
- If the memory becomes full during scanning, a message will appear and the transmission will be canceled.
- The scan settings can be changed for each set of originals.
- When in fax mode, this function is not available for Quick On Line Sending, manual transmission, Direct TX, or transmission using the speaker.
- Job build is not possible when "Settings (administrator)" - [System Settings] → [Common Settings] → [Device Control] → [Condition Settings] or [Enable/Disable Settings] → [Disabling of Document Feeder] is enabled.

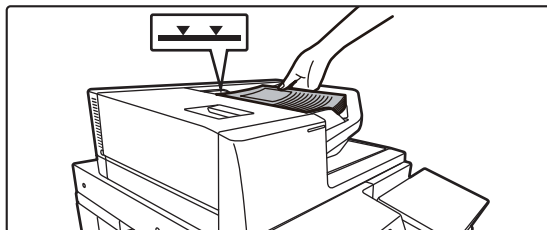
1

Place originals in the automatic document feeder.

Insert the originals all the way into the document feeder tray. Originals can be stacked up to the indicator line. When in fax mode, then after completing this procedure, proceed to Step 3.

[AUTOMATIC DOCUMENT FEEDER \(page 1-34\)](#)

2

Tap the mode display to switch to the initial screen of each mode.

[CHANGING MODES \(page 2-10\)](#)



3

Specify the destination.

- [RETRIEVING A DESTINATION FROM AN ADDRESS BOOK \(page 6-33\)](#)
- [VIEWING A LIST OF THE SELECTED DESTINATIONS \(page 6-36\)](#)
- [USING A SEARCH NUMBER TO RETRIEVE A DESTINATION \(page 6-37\)](#)
- [ENTERING AN ADDRESS MANUALLY \(page 6-38\)](#)
- [SPECIFYING A NETWORK FOLDER \(page 6-39\)](#)
- [RETRIEVING A DESTINATION FROM A GLOBAL ADDRESS BOOK \(page 6-41\)](#)
- [RETRIEVING A DESTINATION FROM A MOBILE ADDRESS BOOK \(page 6-43\)](#)
- [USING A TRANSMISSION LOG TO RESEND \(page 6-45\)](#)

When in fax mode, enter the destination number.

- [ENTERING A DESTINATION NUMBER USING THE NUMERIC KEYS \(page 5-10\)](#)
- [RETRIEVING A DESTINATION FROM AN ADDRESS BOOK \(page 5-11\)](#)
- [USING A SEARCH NUMBER TO RETRIEVE A DESTINATION \(page 5-14\)](#)
- [RETRIEVING A DESTINATION FROM A GLOBAL ADDRESS BOOK \(page 5-15\)](#)
- [RETRIEVING A DESTINATION FROM A MOBILE ADDRESS BOOK \(page 6-43\)](#)
- [USING A TRANSMISSION LOG TO RESEND \(page 5-19\)](#)

4

Tap the [Job Build] key.

A checkmark appears on the icon.



If you are performing Scan to E-mail, tap the [Others] key and then tap the [Job Build] key.



To cancel the job build setting:
Tap the [Job Build] key to uncheck it.

5

Change settings as needed.

6

Tap the [Start] key to scan the first original page.

7

Place the next set of originals and tap the [Start] key.

Repeat until all originals have been scanned.



- If needed, tap [Change Setting] before tapping the [Start] key, and change the original scan settings and send settings for the next original. The setting changes will be applied to the next job.
- If you tap the [Preview] key, you cannot scan additional pages.



To cancel scanning:
Tap the [CA] key. All the settings including scanned data will be cleared.



8

Tap the [Read-End] key.



When in fax mode, if no action is taken for one minute after the confirmation screen appears, scanning automatically ends and the transmission is reserved.



To change the time until automatic send:

In "Settings (administrator)", select [System Settings] → [Image Send Settings] → [Common Settings] → [Condition Settings] → [Job Auto Start Time During Scanning].



SCANNING AND SENDING AN ORIGINAL AS SEPARATE PAGES

SCANNING AN ORIGINAL AS TWO SEPARATE PAGES (DUAL PAGE SCAN)

The left and right sides of an original are scanned as two separate pages. This function is useful when you wish to successively scan each page of a book or other bound document.

When using dual page scan, the original must be placed on the document glass.

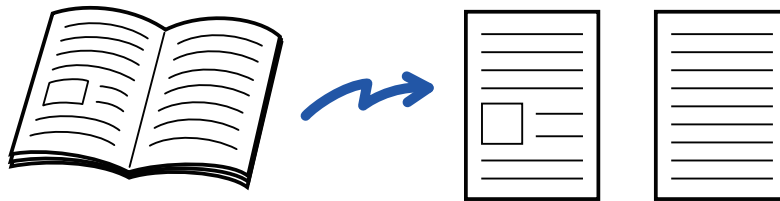

Original scan size	Transmitted image
11" x 17" (A3) x 1 page	8-1/2" x 11"(A4) x 2 pages



- This function is available when the original size setting is set to [Auto].
- Note that "Center Erase" and "Edge+Center Erase" cannot be used.



1

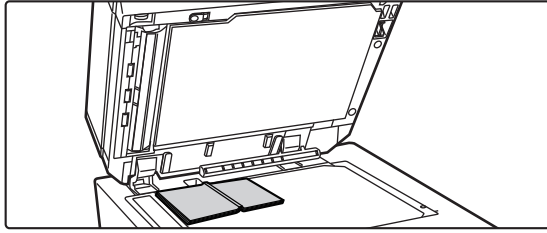

Place the original on the document glass.

[DOCUMENT GLASS \(page 1-38\)](#)

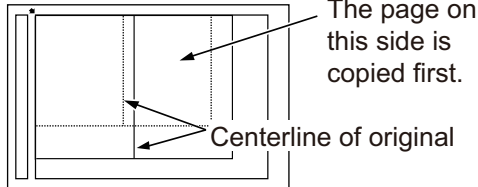

2

Tap the mode display to switch to the initial screen of each mode.

[CHANGING MODES \(page 2-10\)](#)

3

Specify the destination.

[RETRIEVING A DESTINATION FROM AN ADDRESS BOOK \(page 6-33\)](#)

[VIEWING A LIST OF THE SELECTED DESTINATIONS \(page 6-36\)](#)

[USING A SEARCH NUMBER TO RETRIEVE A DESTINATION \(page 6-37\)](#)

[ENTERING AN ADDRESS MANUALLY \(page 6-38\)](#)

[SPECIFYING A NETWORK FOLDER \(page 6-39\)](#)

[RETRIEVING A DESTINATION FROM A GLOBAL ADDRESS BOOK \(page 6-41\)](#)

[RETRIEVING A DESTINATION FROM A MOBILE ADDRESS BOOK \(page 6-43\)](#)

[USING A TRANSMISSION LOG TO RESEND \(page 6-45\)](#)

When in fax mode, enter the destination number.

[ENTERING A DESTINATION NUMBER USING THE NUMERIC KEYS \(page 5-10\)](#)

[RETRIEVING A DESTINATION FROM AN ADDRESS BOOK \(page 5-11\)](#)

[USING A SEARCH NUMBER TO RETRIEVE A DESTINATION \(page 5-14\)](#)

[RETRIEVING A DESTINATION FROM A GLOBAL ADDRESS BOOK \(page 5-15\)](#)

[RETRIEVING A DESTINATION FROM A MOBILE ADDRESS BOOK \(page 6-43\)](#)

[USING A TRANSMISSION LOG TO RESEND \(page 5-19\)](#)



4

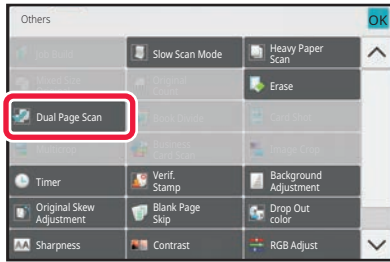

Tap the [Others] key, and tap the [Dual Page Scan] key.

A checkmark appears on the icon.

After the settings are completed, tap the [Back] key.



To cancel the dual page scan setting

Tap the [Dual Page Scan] key to uncheck it.

5

Tap the [Start] key to start scanning of the original.

When scanning finishes, place the next original and tap the [Start] key.

Repeat until all pages have been scanned and then tap the [Read-End] key.

A beep will sound to indicate that transmission has ended.



SPLITTING A PAMPHLET BY PAGE AND TRANSMITTING THE PAGES SUCCESSIVELY (BOOK DIVIDE)

The opened pages of a saddle-stitch pamphlet are split by page according to actual page order before transmission. When using this function, you do not need to sort the original pages to be sent.

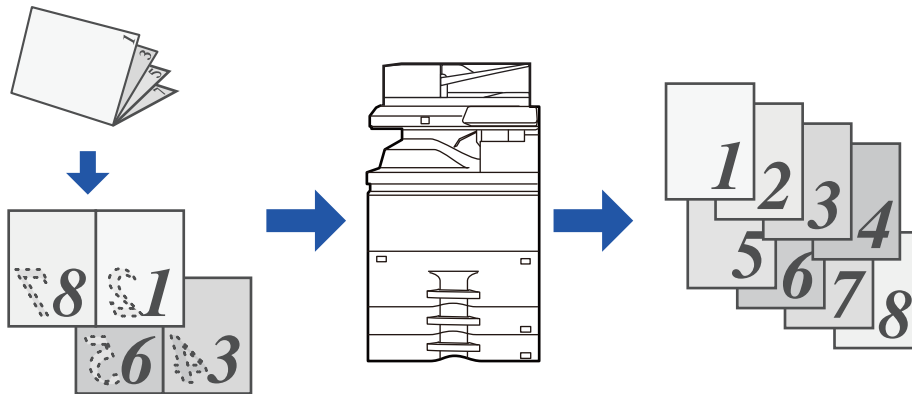

This function can be enabled when the original size setting is set to [Auto].



- The document glass is not available for this function.
- Book Divide is not possible when "Settings (administrator)" - [System Settings] → [Common Settings] → [Device Control] → [Condition Settings] or [Enable/Disable Settings] → [Disabling of Document Feeder] is enabled.

1

Place the original in the document feeder tray of the automatic document feeder.

When in fax mode, then after completing this procedure, proceed to Step 3.

[AUTOMATIC DOCUMENT FEEDER \(page 1-34\)](#)

2

Tap the mode display to switch to the initial screen of each mode.

[CHANGING MODES \(page 2-10\)](#)



3

Specify the destination.

- [RETRIEVING A DESTINATION FROM AN ADDRESS BOOK \(page 6-33\)](#)
 - [VIEWING A LIST OF THE SELECTED DESTINATIONS \(page 6-36\)](#)
 - [USING A SEARCH NUMBER TO RETRIEVE A DESTINATION \(page 6-37\)](#)
 - [ENTERING AN ADDRESS MANUALLY \(page 6-38\)](#)
 - [SPECIFYING A NETWORK FOLDER \(page 6-39\)](#)
 - [RETRIEVING A DESTINATION FROM A GLOBAL ADDRESS BOOK \(page 6-41\)](#)
 - [RETRIEVING A DESTINATION FROM A MOBILE ADDRESS BOOK \(page 6-43\)](#)
 - [USING A TRANSMISSION LOG TO RESEND \(page 6-45\)](#)
- When in fax mode, enter the destination number.
- [ENTERING A DESTINATION NUMBER USING THE NUMERIC KEYS \(page 5-10\)](#)
 - [RETRIEVING A DESTINATION FROM AN ADDRESS BOOK \(page 5-11\)](#)
 - [USING A SEARCH NUMBER TO RETRIEVE A DESTINATION \(page 5-14\)](#)
 - [RETRIEVING A DESTINATION FROM A GLOBAL ADDRESS BOOK \(page 5-15\)](#)
 - [RETRIEVING A DESTINATION FROM A MOBILE ADDRESS BOOK \(page 6-43\)](#)
 - [USING A TRANSMISSION LOG TO RESEND \(page 5-19\)](#)

4

Tap the [Others] key, and tap the [Book Divide] key.

5

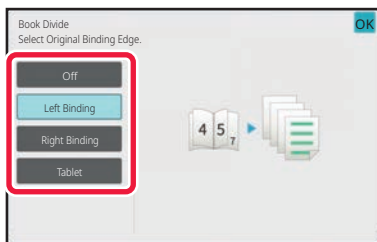

Select the binding edge of the pamphlet original.

After the settings are completed, tap **OK** and [Back] keys in sequence.



Check the preview image displayed in the screen, and make sure that the binding edge is correct.



To cancel the Book Divide setting:
Tap the [Off] key.

6

Tap the [Start] key to start scanning of the original.

A beep will sound to indicate that scanning and transmission have ended.



ADJUSTING COLORS AND SHADING

ADJUSTING THE BACKGROUND BY MAKING LIGHT AREAS OF THE ORIGINAL DARKER OR LIGHTER (BACKGROUND ADJUSTMENT)

You can adjust the background by making light areas of the original darker or lighter.

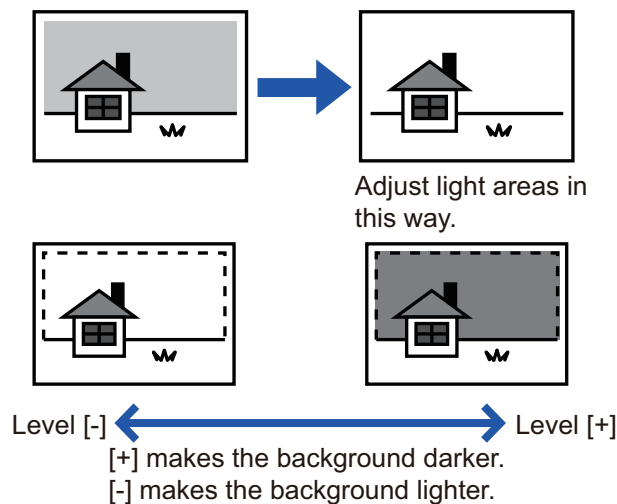

This function cannot be used in Internet fax mode.

1

Place the original.

Place the original in the document feeder tray of the automatic document feeder, or on the document glass.

[AUTOMATIC DOCUMENT FEEDER \(page 1-34\)](#)

[DOCUMENT GLASS \(page 1-38\)](#)

2

Tap the mode display to switch to the initial screen of each mode.

[CHANGING MODES \(page 2-10\)](#)

3

Specify the destination.

[RETRIEVING A DESTINATION FROM AN ADDRESS BOOK \(page 6-33\)](#)

[VIEWING A LIST OF THE SELECTED DESTINATIONS \(page 6-36\)](#)

[USING A SEARCH NUMBER TO RETRIEVE A DESTINATION \(page 6-37\)](#)

[ENTERING AN ADDRESS MANUALLY \(page 6-38\)](#)

[SPECIFYING A NETWORK FOLDER \(page 6-39\)](#)

[RETRIEVING A DESTINATION FROM A GLOBAL ADDRESS BOOK \(page 6-41\)](#)

[RETRIEVING A DESTINATION FROM A MOBILE ADDRESS BOOK \(page 6-43\)](#)

[USING A TRANSMISSION LOG TO RESEND \(page 6-45\)](#)

4

Tap the [Others] key, and tap the [Background Adjustment] key.



5

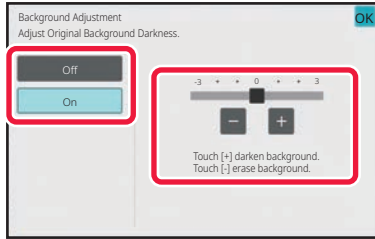

Tap **-** **+** or slide the slider to adjust the range to be suppressed.

After the settings are completed, tap **OK** and [Back] key in sequence.



To cancel the background adjustment setting:

Tap the [Off] key.

6

Tap the [Start] key to start scanning of the original.

- If you inserted the original pages in the document feeder tray, all pages are scanned. A beep will sound to indicate that scanning and transmission have ended.
- When you place the original on the document glass, scan each page one at a time. When scanning finishes, place the next original and tap the [Start] key. A beep will sound to indicate that transmission has ended.



- You can tap the [Preview] key to check a preview of the image before sending an image. For more information, see "[CHECKING THE IMAGE TO BE TRANSMITTED \(page 6-93\)](#)". However, settings for this function cannot be changed in the preview screen.
- When the color mode setting is [Mono2], the background adjustment function will not operate.



ADDING CONTRAST TO THE SCANNED ORIGINAL BEFORE TRANSMISSION (CONTRAST)

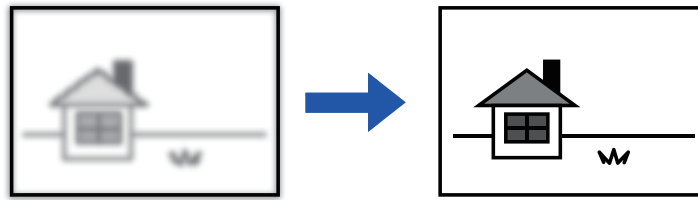

This function cannot be used in Internet fax mode.

1

Place the original.

Place the original in the document feeder tray of the automatic document feeder, or on the document glass.

[AUTOMATIC DOCUMENT FEEDER \(page 1-34\)](#)

[DOCUMENT GLASS \(page 1-38\)](#)

2

Tap the mode display to switch to the initial screen of each mode.

[CHANGING MODES \(page 2-10\)](#)

3

Specify the destination.

[RETRIEVING A DESTINATION FROM AN ADDRESS BOOK \(page 6-33\)](#)

[VIEWING A LIST OF THE SELECTED DESTINATIONS \(page 6-36\)](#)

[USING A SEARCH NUMBER TO RETRIEVE A DESTINATION \(page 6-37\)](#)

[ENTERING AN ADDRESS MANUALLY \(page 6-38\)](#)

[SPECIFYING A NETWORK FOLDER \(page 6-39\)](#)

[RETRIEVING A DESTINATION FROM A GLOBAL ADDRESS BOOK \(page 6-41\)](#)

[RETRIEVING A DESTINATION FROM A MOBILE ADDRESS BOOK \(page 6-43\)](#)

[USING A TRANSMISSION LOG TO RESEND \(page 6-45\)](#)

4

Tap the [Others] key, and tap the [Contrast] key.



5

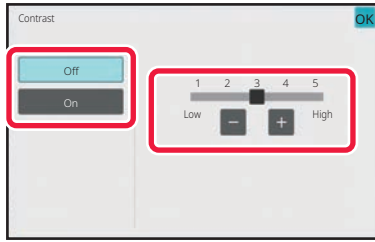

Tap **- +** or slide the slider to adjust the contrast level.

After the settings are completed, tap **OK** and [Back] keys in sequence.



To cancel the contrast settings:

Tap the [Off] key.

6

Tap the [Start] key to start scanning of the original.

- If you inserted the original pages in the document feeder tray, all pages are scanned. A beep will sound to indicate that scanning and transmission have ended.
- When you place the original on the document glass, scan each page one at a time. When scanning finishes, place the next original and tap the [Start] key. Repeat the procedure until all pages have been scanned and then tap the [Read-End] key. A beep will sound to indicate that scanning and transmission have ended.



You can tap the [Preview] key to check a preview of the image before sending an image. For more information, see "[CHECKING THE IMAGE TO BE TRANSMITTED \(page 6-93\)](#)". However, settings for this function cannot be changed in the preview screen.



ENHANCING THE OUTLINE OF THE SCANNED ORIGINAL BEFORE TRANSMISSION (SHARPNESS)



This function cannot be used in Internet fax mode.

1

Place the original.

Place the original in the document feeder tray of the automatic document feeder, or on the document glass.

[AUTOMATIC DOCUMENT FEEDER \(page 1-34\)](#)

[DOCUMENT GLASS \(page 1-38\)](#)

2

Tap the mode display to switch to the initial screen of each mode.

[CHANGING MODES \(page 2-10\)](#)

3

Specify the destination.

[RETRIEVING A DESTINATION FROM AN ADDRESS BOOK \(page 6-33\)](#)

[VIEWING A LIST OF THE SELECTED DESTINATIONS \(page 6-36\)](#)

[USING A SEARCH NUMBER TO RETRIEVE A DESTINATION \(page 6-37\)](#)

[ENTERING AN ADDRESS MANUALLY \(page 6-38\)](#)

[SPECIFYING A NETWORK FOLDER \(page 6-39\)](#)

[RETRIEVING A DESTINATION FROM A GLOBAL ADDRESS BOOK \(page 6-41\)](#)

[RETRIEVING A DESTINATION FROM A MOBILE ADDRESS BOOK \(page 6-43\)](#)

[USING A TRANSMISSION LOG TO RESEND \(page 6-45\)](#)

4

Tap the [Others] key, and tap the [Sharpness] key.



5

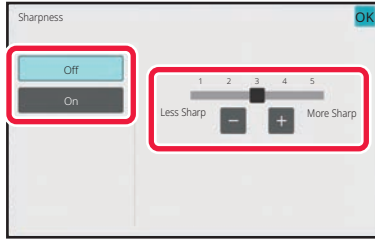

Tap **- +** or slide the slider to adjust the sharpness.

After the settings are completed, tap **OK** and [Back] keys in sequence.



To cancel the sharpness setting:
Tap the [Off] key.

6

Tap the [Start] key to start scanning of the original.

- If you inserted the original pages in the document feeder tray, all pages are scanned. A beep will sound to indicate that scanning and transmission have ended.
- When you place the original on the document glass, scan each page one at a time. When scanning finishes, place the next original and tap the [Start] key. Repeat the procedure until all pages have been scanned and then tap the [Read-End] key. A beep will sound to indicate that scanning and transmission have ended.



You can tap the [Preview] key to check a preview of the image before sending an image. For more information, see "[CHECKING THE IMAGE TO BE TRANSMITTED \(page 6-93\)](#)". However, settings for this function cannot be changed in the preview screen.



REMOVING CHROMATIC COLORS FROM THE SCANNED ORIGINAL BEFORE TRANSMISSION (DROP OUT COLOR)

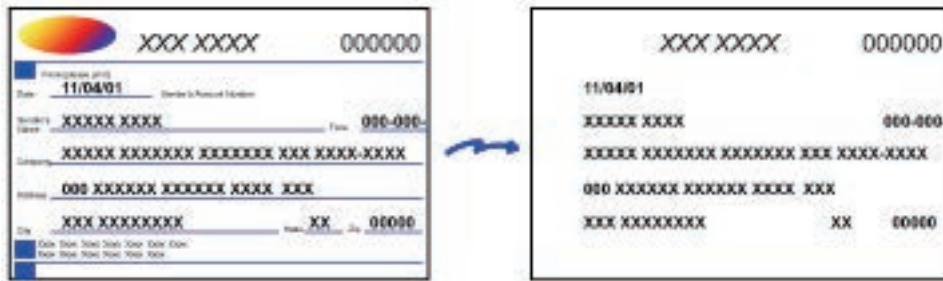

This function cannot be used in Internet fax mode.

1

Place the original.

Place the original in the document feeder tray of the automatic document feeder, or on the document glass.
[AUTOMATIC DOCUMENT FEEDER \(page 1-34\)](#)
[DOCUMENT GLASS \(page 1-38\)](#)

2

Tap the mode display to switch to the initial screen of each mode.

[CHANGING MODES \(page 2-10\)](#)

3

Specify the destination.

[RETRIEVING A DESTINATION FROM AN ADDRESS BOOK \(page 6-33\)](#)
[VIEWING A LIST OF THE SELECTED DESTINATIONS \(page 6-36\)](#)
[USING A SEARCH NUMBER TO RETRIEVE A DESTINATION \(page 6-37\)](#)
[ENTERING AN ADDRESS MANUALLY \(page 6-38\)](#)
[SPECIFYING A NETWORK FOLDER \(page 6-39\)](#)
[RETRIEVING A DESTINATION FROM A GLOBAL ADDRESS BOOK \(page 6-41\)](#)
[RETRIEVING A DESTINATION FROM A MOBILE ADDRESS BOOK \(page 6-43\)](#)
[USING A TRANSMISSION LOG TO RESEND \(page 6-45\)](#)

4

Tap the [Others] key, and then tap the [Drop Out Color] key.

A checkmark appears on the icon.
 After the settings are completed, tap the [Back] key.



To cancel the drop out color setting

Tap the [Drop Out Color] key to uncheck it.



5

Tap the [Start] key to start scanning of the original.

- If you inserted the original pages in the document feeder tray, all pages are scanned. A beep will sound to indicate that scanning and transmission have ended.
- When you place the original on the document glass, scan each page one at a time. When scanning finishes, place the next original and tap the [Start] key. Repeat the procedure until all pages have been scanned and then tap the [Read-End] key. A beep will sound to indicate that scanning and transmission have ended.



- You can tap the [Preview] key to check a preview of the image before sending an image. For more information, see [“CHECKING THE IMAGE TO BE TRANSMITTED \(page 6-93\)”](#).
- Tap the [Change Setting] key in the scan-end confirmation screen to change the exposure, resolution, scan size, and send size. (However, when scanning each even-numbered page of the original, only the exposure can be changed.)



ADJUSTING RED/GREEN/BLUE (RGB Adjust)

This function heightens or lightens any one of the three color components R (red), G (green), and B (blue).

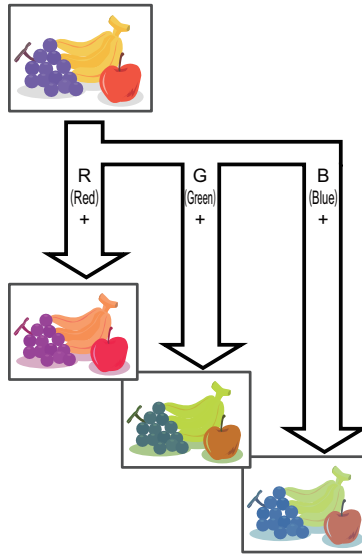
**1**

Place the original.

Place the original in the document feeder tray of the automatic document feeder, or on the document glass.
[AUTOMATIC DOCUMENT FEEDER \(page 1-34\)](#)
[DOCUMENT GLASS \(page 1-38\)](#)

2

Tap the mode display to switch to the initial screen of each mode.

[CHANGING MODES \(page 2-10\)](#)

3

Specify the destination.

[RETRIEVING A DESTINATION FROM AN ADDRESS BOOK \(page 6-33\)](#)
[VIEWING A LIST OF THE SELECTED DESTINATIONS \(page 6-36\)](#)
[USING A SEARCH NUMBER TO RETRIEVE A DESTINATION \(page 6-37\)](#)
[ENTERING AN ADDRESS MANUALLY \(page 6-38\)](#)
[SPECIFYING A NETWORK FOLDER \(page 6-39\)](#)
[RETRIEVING A DESTINATION FROM A GLOBAL ADDRESS BOOK \(page 6-41\)](#)
[RETRIEVING A DESTINATION FROM A MOBILE ADDRESS BOOK \(page 6-43\)](#)
[USING A TRANSMISSION LOG TO RESEND \(page 6-45\)](#)

4

Tap the [Others] key, and tap the [RGB Adjust] key.



5

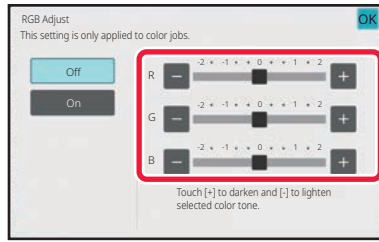

Tap **-** **+** of the color you want to adjust or slide the slider to adjust the coloring.

After the settings are completed, tap **OK** and [Back] keys in sequence.



To cancel the RGB Adjust setting:
Tap the [Off] key.

6

Tap the [Start] key to start scanning of the original.

- If you inserted the original pages in the document feeder tray, all pages are scanned. A beep will sound to indicate that scanning and transmission have ended.
- When you place the original on the document glass, scan each page one at a time. When scanning finishes, place the next original and tap the [Start] key. Repeat the procedure until all pages have been scanned and then tap the [Read-End] key. A beep will sound to indicate that scanning and transmission have ended.



- You can tap the [Preview] key to check a preview of the image before sending an image. For more information, see "[CHECKING THE IMAGE TO BE TRANSMITTED \(page 6-93\)](#)".
- Tap the [Change Setting] key in the scan-end confirmation screen to change the exposure, resolution, scan size, and send size. (However, when scanning each even-numbered page of the original, only the exposure can be changed.)



SCANNING ORIGINALS

ERASING PERIPHERAL SHADOWS ON THE IMAGE (ERASE)

When scanning thick originals or books, erase any peripheral shadows that may be produced on the image.

Scanning a thick book

When a bound document is scanned, shadows appear in the peripheral areas and around the binding portion of the scanned image.

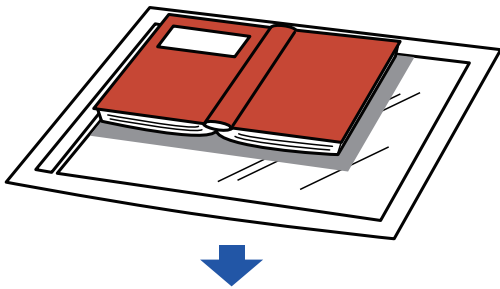

Not using the erase function	Using the erase function
Shadows appear in the image.	No shadows appear.

Erase modes

Outer Frame Erase

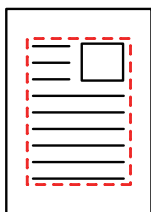

Center Erase

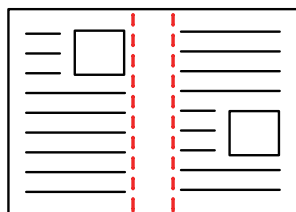

Edge + Center Erase

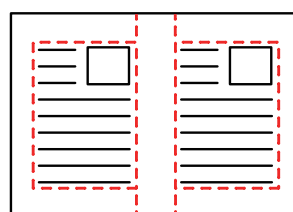

Side Erase

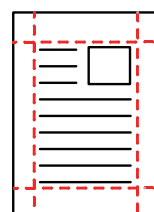

- This function erases the parts of the image where shadows tend to form, but does not detect shadows and erase only the shadows.
- If a ratio setting is used in combination with an erase setting, the erase width will change according to the selected ratio.
 - For example, if you set an erase width of 1/2" (10 mm) and reduce the image to 70% before scanning it, the erase width will be reduced to 3/8" (7 mm).
- When the erase setting is selected, the image orientation will be forcibly portrait.



To change the default erase width setting:

In "Settings (administrator)", select [System Settings] → [Image Send Settings] → [Common Settings] → [Condition Settings] → [Erase Width Adjustment].

The width can be set from 0" to 1" (0 mm to 20 mm). The factory default setting is 1/2" (10 mm). The setting changed here will apply to [System Settings] → [Copy Settings] → [Condition Settings] → [Erase Width Adjustment] in "Settings".

1

Place the original.

Place the original in the document feeder tray of the automatic document feeder, or on the document glass. When in fax mode, then after completing this procedure, proceed to Step 3.

[AUTOMATIC DOCUMENT FEEDER \(page 1-34\)](#)

[DOCUMENT GLASS \(page 1-38\)](#)

2

Tap the mode display to switch to the initial screen of each mode.

[CHANGING MODES \(page 2-10\)](#)

3

Specify the destination.

[RETRIEVING A DESTINATION FROM AN ADDRESS BOOK \(page 6-33\)](#)

[VIEWING A LIST OF THE SELECTED DESTINATIONS \(page 6-36\)](#)

[USING A SEARCH NUMBER TO RETRIEVE A DESTINATION \(page 6-37\)](#)

[ENTERING AN ADDRESS MANUALLY \(page 6-38\)](#)

[SPECIFYING A NETWORK FOLDER \(page 6-39\)](#)

[RETRIEVING A DESTINATION FROM A GLOBAL ADDRESS BOOK \(page 6-41\)](#)

[RETRIEVING A DESTINATION FROM A MOBILE ADDRESS BOOK \(page 6-43\)](#)

[USING A TRANSMISSION LOG TO RESEND \(page 6-45\)](#)

When in fax mode, enter the destination number.

[ENTERING A DESTINATION NUMBER USING THE NUMERIC KEYS \(page 5-10\)](#)

[RETRIEVING A DESTINATION FROM AN ADDRESS BOOK \(page 5-11\)](#)

[USING A SEARCH NUMBER TO RETRIEVE A DESTINATION \(page 5-14\)](#)

[RETRIEVING A DESTINATION FROM A GLOBAL ADDRESS BOOK \(page 5-15\)](#)

[RETRIEVING A DESTINATION FROM A MOBILE ADDRESS BOOK \(page 6-43\)](#)

[USING A TRANSMISSION LOG TO RESEND \(page 5-19\)](#)

4

Tap the [Others] key, and tap the [Erase] key.



5

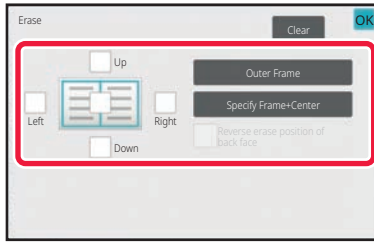

Tap the checkbox of the edge that you wish to erase, and specify the erase position.

Check that the tapped checkbox is set to .
 If the [Outer Frame] key is tapped, the [Up], [Down], [Left], and [Right] checkboxes are set to .
 If the [Specify Frame+Center] key is tapped, all the checkboxes are set to .



- Specify the erase edge on the reverse side when erasing edges of one to three sides of Up, Down, Left, and Right on the front side to scan a 2-sided original.
- If the [Reverse Erase Position of The Back Face] checkbox is set to , the edge in the position opposite to the erased edge on the front side will be erased.
- If the [Reverse Erase Position of The Back Face] checkbox is set to , the edge in the same position as on the front side will be erased.
- [Reverse Erase Position of The Back Face] is not possible when "Settings (administrator)" - [System Settings] → [Common Settings] → [Device Control] → [Condition Settings] or [Enable/Disable Settings] → [Disabling of Document Feeder] is enabled.

6

Specify the erase width.

After the settings are completed, tap **OK** and [Back] keys in sequence.



- Tap the numeric value display indicating the margin shift area on the front side or reverse side, and enter the area using the numeric keys.
- To quickly set the area, first specify a value close to the desired value by the numeric keys, then adjust it with **-** **+** .



To cancel the erase setting:

Tap the [Clear] key.

7

Tap the [Start] key to start scanning of the original.

- If you inserted the original pages in the document feeder tray, all pages are scanned.
A beep will sound to indicate that scanning and transmission have ended.
- When you place the original on the document glass, scan each page one at a time.
When scanning finishes, place the next original and tap the [Start] key.
Repeat until all pages have been scanned and then tap the [Read-End] key.
A beep will sound to indicate that transmission has ended.



You can tap the [Preview] key to check a preview of the image before sending an image. For more information, see "[CHECKING THE IMAGE TO BE TRANSMITTED \(page 6-93\)](#)" (When in fax mode, "[CHECKING THE IMAGE TO BE TRANSMITTED \(page 5-28\)](#)").



SCANNING A THIN ORIGINAL (SLOW SCAN MODE)

Use this function when you wish to scan thin originals using the automatic document feeder. This function helps prevent thin originals from misfeeding.

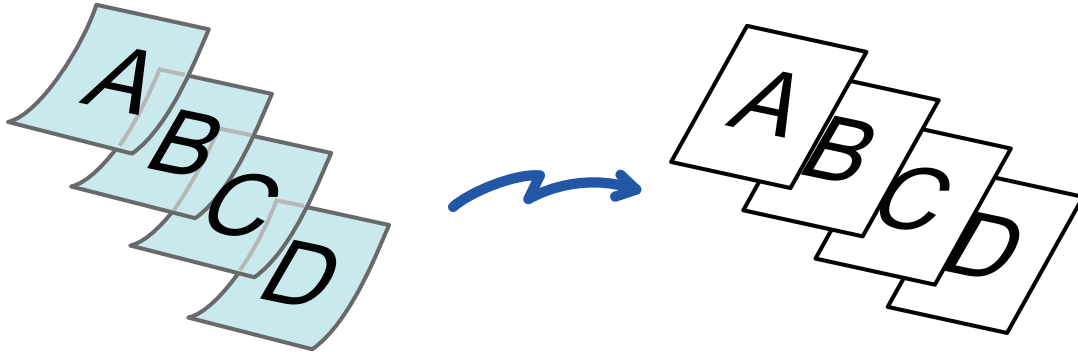

- When slow scan mode is selected, 2-sided scanning is not possible.
- Slow scan mode is not possible when "Settings (administrator)" - [System Settings] → [Common Settings] → [Device Control] → [Condition Settings] or [Enable/Disable Settings] → [Disabling of Document Feeder] is enabled.

1

Place the original in the document feeder tray of the automatic document feeder.

When in fax mode, then after completing this procedure, proceed to Step 3.

Adjust the original guides slowly.

[AUTOMATIC DOCUMENT FEEDER \(page 1-34\)](#)



If the originals are inserted with too much force, they may crumple and misfeed.

2

Tap the mode display to switch to the initial screen of each mode.

[CHANGING MODES \(page 2-10\)](#)



3

Specify the destination.

- [RETRIEVING A DESTINATION FROM AN ADDRESS BOOK \(page 6-33\)](#)
 - [VIEWING A LIST OF THE SELECTED DESTINATIONS \(page 6-36\)](#)
 - [USING A SEARCH NUMBER TO RETRIEVE A DESTINATION \(page 6-37\)](#)
 - [ENTERING AN ADDRESS MANUALLY \(page 6-38\)](#)
 - [SPECIFYING A NETWORK FOLDER \(page 6-39\)](#)
 - [RETRIEVING A DESTINATION FROM A GLOBAL ADDRESS BOOK \(page 6-41\)](#)
 - [RETRIEVING A DESTINATION FROM A MOBILE ADDRESS BOOK \(page 6-43\)](#)
 - [USING A TRANSMISSION LOG TO RESEND \(page 6-45\)](#)
- When in fax mode, enter the destination number.
- [ENTERING A DESTINATION NUMBER USING THE NUMERIC KEYS \(page 5-10\)](#)
 - [RETRIEVING A DESTINATION FROM AN ADDRESS BOOK \(page 5-11\)](#)
 - [USING A SEARCH NUMBER TO RETRIEVE A DESTINATION \(page 5-14\)](#)
 - [RETRIEVING A DESTINATION FROM A GLOBAL ADDRESS BOOK \(page 5-15\)](#)
 - [RETRIEVING A DESTINATION FROM A MOBILE ADDRESS BOOK \(page 6-43\)](#)
 - [USING A TRANSMISSION LOG TO RESEND \(page 5-19\)](#)

4

Tap the [Others] key, and tap the [Slow Scan Mode] key.

A checkmark appears on the icon.
After the settings are completed, tap the [Back] key.



To cancel the slow scan Mode setting
Tap the [Slow Scan Mode] key to uncheck it.

5

Tap the [Start] key to start scanning of the original.

A beep will sound to indicate that scanning and transmission have ended.



Tap the [Preview] key to check the preview of an image before sending a fax. For more information, see "[CHECKING THE IMAGE TO BE TRANSMITTED \(page 6-93\)](#)" (When in fax mode, "[CHECKING THE IMAGE TO BE TRANSMITTED \(page 5-28\)](#)"). However, settings for this function cannot be changed in the preview screen.



SCANNING A HEAVY ORIGINAL (HEAVY PAPER SCAN)

Use this function when you wish to scan heavy originals using the automatic document feeder. This function helps prevent heavy originals from misfeeding.

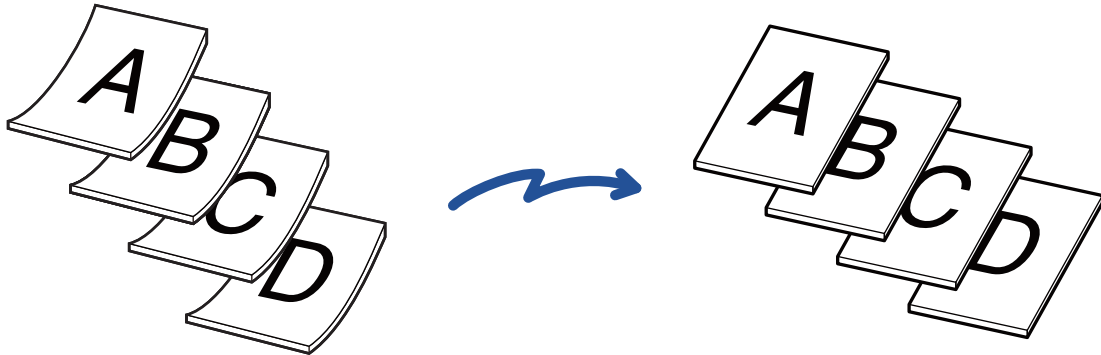

Heavy paper scan is not possible when "Settings (administrator)" - [System Settings] → [Common Settings] → [Device Control] → [Condition Settings] or [Enable/Disable Settings] → [Disabling of Document Feeder] is enabled.

1

Place the original in the document feeder tray of the automatic document feeder.

When in fax mode, then after completing this procedure, proceed to Step 3.
Adjust the original guides slowly.

[AUTOMATIC DOCUMENT FEEDER \(page 1-34\)](#)



If the originals are inserted with too much force, they may crumple and misfeed.

2

Tap the mode display to switch to the initial screen of each mode.

[CHANGING MODES \(page 2-10\)](#)



3

Specify the destination.

- [RETRIEVING A DESTINATION FROM AN ADDRESS BOOK \(page 6-33\)](#)
 - [VIEWING A LIST OF THE SELECTED DESTINATIONS \(page 6-36\)](#)
 - [USING A SEARCH NUMBER TO RETRIEVE A DESTINATION \(page 6-37\)](#)
 - [ENTERING AN ADDRESS MANUALLY \(page 6-38\)](#)
 - [SPECIFYING A NETWORK FOLDER \(page 6-39\)](#)
 - [RETRIEVING A DESTINATION FROM A GLOBAL ADDRESS BOOK \(page 6-41\)](#)
 - [RETRIEVING A DESTINATION FROM A MOBILE ADDRESS BOOK \(page 6-43\)](#)
 - [USING A TRANSMISSION LOG TO RESEND \(page 6-45\)](#)
- When in fax mode, enter the destination number.
- [ENTERING A DESTINATION NUMBER USING THE NUMERIC KEYS \(page 5-10\)](#)
 - [RETRIEVING A DESTINATION FROM AN ADDRESS BOOK \(page 5-11\)](#)
 - [USING A SEARCH NUMBER TO RETRIEVE A DESTINATION \(page 5-14\)](#)
 - [RETRIEVING A DESTINATION FROM A GLOBAL ADDRESS BOOK \(page 5-15\)](#)
 - [RETRIEVING A DESTINATION FROM A MOBILE ADDRESS BOOK \(page 6-43\)](#)
 - [USING A TRANSMISSION LOG TO RESEND \(page 5-19\)](#)

4

Tap the [Others] key, and tap the [Heavy Paper Scan] key.

A checkmark appears on the icon.
After the settings are completed, tap the [Back] key.



To cancel the Heavy Paper Scan setting
Tap the [Heavy Paper Scan] key to uncheck it.

5

Tap the [Start] key to start scanning of the original.

A beep will sound to indicate that scanning and transmission have ended.



Tap the [Preview] key to check the preview of an image before sending a fax. For more information, see "[CHECKING THE IMAGE TO BE TRANSMITTED \(page 6-93\)](#)" (When in fax mode, "[CHECKING THE IMAGE TO BE TRANSMITTED \(page 5-28\)](#)"). However, settings for this function cannot be changed in the preview screen.



ELIMINATING BLANK PAGES FROM A TRANSMISSION (BLANK PAGE SKIP)

If the scanned original contains blank pages, this function skips them to send only non-blank pages. The machine detects blank pages, enabling you to skip useless blank sheets without checking an original.

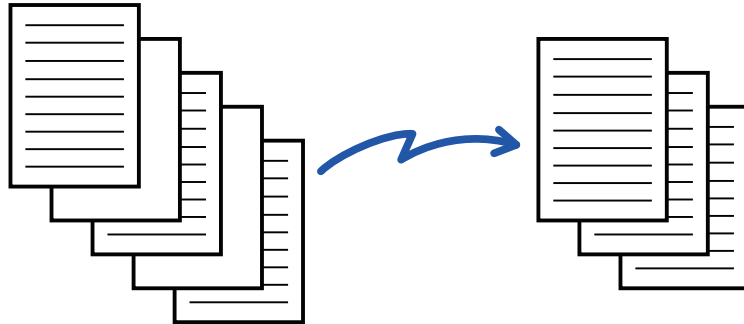

- If an original of which one side is blank is scanned, blank pages are skipped for 2-sided sending.
- In a broadcast transmission to destinations including fax and Internet fax destinations, this function is applied to scan mode destinations only.
- Depending on the original, some pages that are not blank may be detected as blank pages and thus not being sent, and some pages that are blank may not be detected as blank and thus sent.



- This function cannot be used in Internet fax mode.
- If the [Send Same Image as Fax Address] key is tapped, this function is canceled if a fax address is specified for the destination.



To display the blank page skip confirmation message:

Select [System Settings] → [Common Settings] → [Device Control] → [Condition Settings] → [Display Blank Page Skip Confirmation Message].

1

Place the original.

Place the original in the document feeder tray of the automatic document feeder, or on the document glass.

[AUTOMATIC DOCUMENT FEEDER \(page 1-34\)](#)

[DOCUMENT GLASS \(page 1-38\)](#)

2

Tap the mode display to switch to the initial screen of each mode.

[CHANGING MODES \(page 2-10\)](#)

3

Specify the destination.

[RETRIEVING A DESTINATION FROM AN ADDRESS BOOK \(page 6-33\)](#)

[VIEWING A LIST OF THE SELECTED DESTINATIONS \(page 6-36\)](#)

[USING A SEARCH NUMBER TO RETRIEVE A DESTINATION \(page 6-37\)](#)

[ENTERING AN ADDRESS MANUALLY \(page 6-38\)](#)

[SPECIFYING A NETWORK FOLDER \(page 6-39\)](#)

[RETRIEVING A DESTINATION FROM A GLOBAL ADDRESS BOOK \(page 6-41\)](#)

[RETRIEVING A DESTINATION FROM A MOBILE ADDRESS BOOK \(page 6-43\)](#)

[USING A TRANSMISSION LOG TO RESEND \(page 6-45\)](#)



4

Tap the [Others] key, and tap the [Blank Page Skip] key.

5

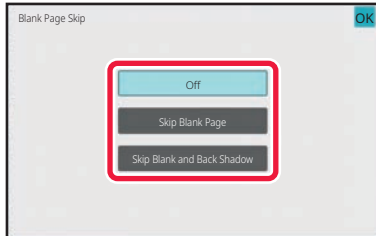

Tap the [Skip Blank Page] or [Skip Blank and Back Shadow] key.

After the settings are completed, tap **OK** and [Back] keys in sequence.



To cancel the Blank Page Skip setting:
Tap the [Off] key.

6

Tap the [Start] key to start scanning of the original.

A beep will sound to indicate that scanning has ended.



Tap the [Preview] key to check the preview of an image before sending a fax. For more information, see "[CHECKING THE IMAGE TO BE TRANSMITTED \(page 6-93\)](#)".

7

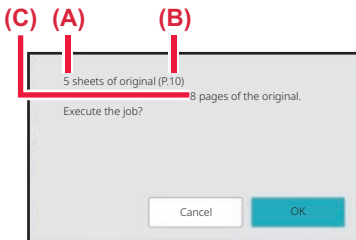

When scanning ends, check the number of original sheets and the number of sheets to be sent and tap the [OK] key to start transmission.

- When Job Build mode is used, the confirmation message will appear after the [Start] key is tapped.
- On the confirmation screen, the number of scanned original sheets appears in (A), the number of scanned sides in (B), and the number of sheets to be sent excluding blank pages in (C).

For example, if five original sheets that include two blank pages are scanned by duplex scanning, (A) will show "5", (B) will show "10", and (C) will show "8".



- If this step is not performed within one minute after the above confirmation screen appears, the scanned image and settings will be cleared and the base screen will reappear.
- Scanning will not be completed automatically and the image will not be reserved for transmission.



CHECKING THE NUMBER OF SCANNED ORIGINAL SHEETS BEFORE TRANSMISSION (ORIGINAL COUNT)

Count the number of scanned original sheets and display the count before transmission.

Checking the number of scanned original sheets before transmission helps prevent transmission mistakes.



- The count result is displayed with the number of scanned original sheets, not the number of scanned original pages. For example, when a 2-sided original is transmitted, the number "1" will appear to indicate that one original sheet is transmitted, not "2" to indicate the front-side page and the reverse side page.
- When a broadcast transmission is performed, if the original count function is selected in any of the modes, the function will operate for all destinations.
- The setting should be enabled separately for each mode.

1

Place originals in the automatic document feeder.

When in fax mode, then after completing this procedure, proceed to Step 3.

[AUTOMATIC DOCUMENT FEEDER \(page 1-34\)](#)

2

Tap the mode display to switch to the initial screen of each mode.

[CHANGING MODES \(page 2-10\)](#)

3

Specify the destination.

[RETRIEVING A DESTINATION FROM AN ADDRESS BOOK \(page 6-33\)](#)

[VIEWING A LIST OF THE SELECTED DESTINATIONS \(page 6-36\)](#)

[USING A SEARCH NUMBER TO RETRIEVE A DESTINATION \(page 6-37\)](#)

[ENTERING AN ADDRESS MANUALLY \(page 6-38\)](#)

[SPECIFYING A NETWORK FOLDER \(page 6-39\)](#)

[RETRIEVING A DESTINATION FROM A GLOBAL ADDRESS BOOK \(page 6-41\)](#)

[RETRIEVING A DESTINATION FROM A MOBILE ADDRESS BOOK \(page 6-43\)](#)

[USING A TRANSMISSION LOG TO RESEND \(page 6-45\)](#)

When in fax mode, enter the destination number.

[ENTERING A DESTINATION NUMBER USING THE NUMERIC KEYS \(page 5-10\)](#)

[RETRIEVING A DESTINATION FROM AN ADDRESS BOOK \(page 5-11\)](#)

[USING A SEARCH NUMBER TO RETRIEVE A DESTINATION \(page 5-14\)](#)

[RETRIEVING A DESTINATION FROM A GLOBAL ADDRESS BOOK \(page 5-15\)](#)

[RETRIEVING A DESTINATION FROM A MOBILE ADDRESS BOOK \(page 5-17\)](#)

[USING A TRANSMISSION LOG TO RESEND \(page 5-19\)](#)

4

Tap the [Others] key, and tap the [Original Count] key.

A checkmark appears on the icon.

After the settings are completed, tap the [Back] key.



To cancel the original count setting:

Tap the [Original Count] key to uncheck it.

5

Tap the [Start] key to start scanning of the original.

A beep will sound to indicate that scanning has ended.



Tap the [Preview] key to check the preview of an image before sending a fax. For more information, see "[CHECKING THE IMAGE TO BE TRANSMITTED \(page 6-93\)](#)" (When in fax mode, "[CHECKING THE IMAGE TO BE TRANSMITTED \(page 5-28\)](#)"). However, settings for this function cannot be changed in the preview screen.



6

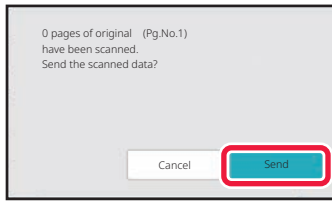

Check the number of original sheets.

The number that is displayed is the number of scanned original sheets, not the number of scanned original pages. For example, when 2-sided copying is performed using one original, the number "1" will appear to indicate that one original sheet was scanned, not "2" to indicate the front-side page and the reverse side page.

7

Tap the [Send] key to start transmission.



- If this function is combined with [Job Build], the count result is displayed after the [Read-End] key has been tapped.
- If this step is not performed within one minute after the above confirmation screen appears, the scanned image and settings will be cleared and the base screen will reappear. Scanning will not be completed automatically and the image will not be reserved for transmission.



If the displayed number of original sheets is different from the actual number of sheets:

Tap the [Cancel] key and then tap the [OK] key in the message screen to clear all scanned data. Scan settings and destination settings will not be cleared. Insert the original sheets in the document feeder tray again and tap the [Start] key to re-scan.



AUTOMATICALLY ADJUST SKEWED SCAN DATA (Original Skew Adjustment)

When the original is skewed, or when images within the original are skewed, this automatically corrects the skewing, and saves the document.

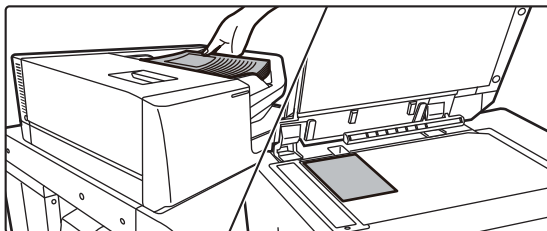

- The post-adjustment image is not shown in preview images, and is displayed as it was scanned.
- If adjustment is not required and text and images are on an angle for design reasons, adjustment may still occur automatically.
- If there is little text or image data in the original, this may not be adjusted regardless of the degree of skewing.
- If an Internet fax address is added as a destination, this function will be disabled.
- For card shot, this function cannot be used.
- If [Document Filing] → [Main Folder] → [Property] → [Create PDF for PC Browsing] in System Settings is enabled, this function cannot be used on the document filing function.
- Depending on the degree of skew, correction may not be possible.

1

Place the original.

Place the original in the document feeder tray of the automatic document feeder, or on the document glass.
[AUTOMATIC DOCUMENT FEEDER \(page 1-34\)](#)
[DOCUMENT GLASS \(page 1-38\)](#)

2

Tap the mode display to switch to the initial screen of each mode.

[CHANGING MODES \(page 2-10\)](#)

3

Specify the destination.

[RETRIEVING A DESTINATION FROM AN ADDRESS BOOK \(page 6-33\)](#)
[VIEWING A LIST OF THE SELECTED DESTINATIONS \(page 6-36\)](#)
[USING A SEARCH NUMBER TO RETRIEVE A DESTINATION \(page 6-37\)](#)
[ENTERING AN ADDRESS MANUALLY \(page 6-38\)](#)
[SPECIFYING A NETWORK FOLDER \(page 6-39\)](#)
[RETRIEVING A DESTINATION FROM A GLOBAL ADDRESS BOOK \(page 6-41\)](#)
[RETRIEVING A DESTINATION FROM A MOBILE ADDRESS BOOK \(page 6-43\)](#)
[USING A TRANSMISSION LOG TO RESEND \(page 6-45\)](#)



4

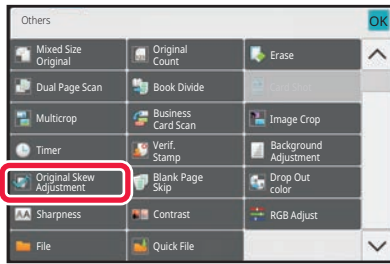

Tap the [Others] key, and tap the [Original Skew Adjustment] key.

A checkmark appears on the icon.

When you have completed the setting, tap the [Back] key.



To cancel the Original Skew Adjustment setting

Tap the [Original Skew Adjustment] key to remove the checkmark.

5

Tap the [Start] key to start scanning of the original.

When scanning finishes, place the next original and tap the [Start] key.

Repeat until all pages have been scanned and then tap the [Read-End] key.

A beep will sound to indicate that transmission has ended.



SPECIFIC FUNCTIONS

ADDING YOUR SENDER INFORMATION TO FAXES (I-FAX OWN ADDRESS SEND)

Your sender information (date, time, sender name, sender address, number of pages) is automatically added to the top of the file you transmit.



This function cannot be used in scan mode or data entry mode.

Example of the sender information printed

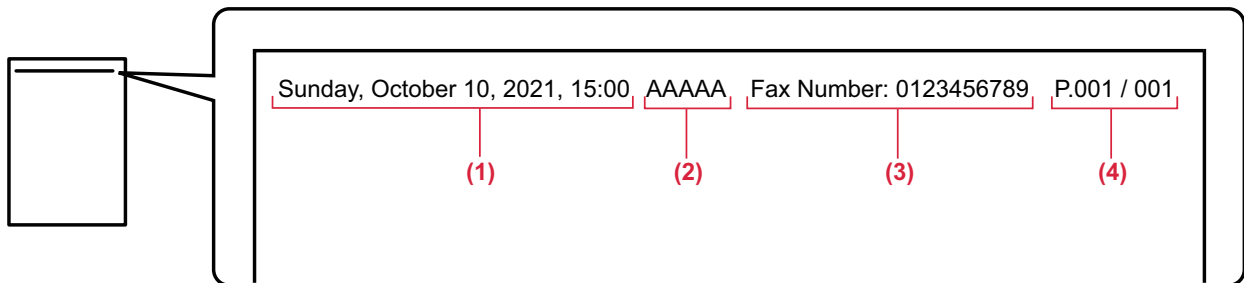

- (1) Date, time: The date and time of transmission.
- (2) Sender name: The sender name programmed in the machine.
- (3) Source Address.
- (4) Page numbers: Page number/total pages.



- Storing and setting sender information

Date, time: In "Settings", select [System Settings] → [Common Settings] → [Device Control] → [Clock Adjust].

Sender name, sender address: In "Settings (administrator)", select [System Settings] → [Image Send Settings] → [Common Settings] → [Own Number and Name Set] → [Sender Data Registration]. If you intend to use the I-Fax Own Address Send function, be sure to configure this information.

Page numbers: Select whether or not to include page numbers using [System Settings] → [Image Send Settings] → [Internet Fax Settings] → [Send Setting] → [Printing Page Number at Receiver] in "Settings (administrator)".

- Position of sender information

The sender information is printed at the top of the scanned image data. This makes the transmission data longer than the scan size, so it may be reduced or divided onto two pages when printed by the receiving machine.



CHANGING THE PRINT SETTINGS FOR THE TRANSACTION REPORT (TRANSACTION REPORT)

A transaction report is automatically printed out to alert you when an Internet fax transmission fails or when a broadcast transmission is performed.

The transaction report contains a description of the transmission (date, start time, name of destination, time required, number of pages, result, etc.).

► [INFORMATION APPEARING IN THE RESULT COLUMN \(page 6-155\)](#)

Transaction reports are printed based on conditions set in the setting mode. Select different conditions for a transmission as required.



This function cannot be used in scan mode or data entry mode.



For a broadcast transmission, changes to the transaction report print conditions apply to all destinations.

1

Place the original.

Place the original in the document feeder tray of the automatic document feeder, or on the document glass.

[AUTOMATIC DOCUMENT FEEDER \(page 1-34\)](#)

[DOCUMENT GLASS \(page 1-38\)](#)

2

Tap the mode display to switch to the initial screen of Internet Fax mode.

[CHANGING MODES \(page 2-10\)](#)

3

Specify the destination.

[RETRIEVING A DESTINATION FROM AN ADDRESS BOOK \(page 6-33\)](#)

[VIEWING A LIST OF THE SELECTED DESTINATIONS \(page 6-36\)](#)

[USING A SEARCH NUMBER TO RETRIEVE A DESTINATION \(page 6-37\)](#)

[ENTERING AN ADDRESS MANUALLY \(page 6-38\)](#)

[SPECIFYING A NETWORK FOLDER \(page 6-39\)](#)

[RETRIEVING A DESTINATION FROM A GLOBAL ADDRESS BOOK \(page 6-41\)](#)

[RETRIEVING A DESTINATION FROM A MOBILE ADDRESS BOOK \(page 6-43\)](#)

[USING A TRANSMISSION LOG TO RESEND \(page 6-45\)](#)

4

Tap the [Others] key, and tap the [Transaction Report] key.



5



Tap the key of the print settings.

After the settings are completed, tap **OK** and [Back] keys in sequence.



To cancel the transaction report settings:

Tap the [Do not Print] key.



- The print conditions for a transaction report are as follows:
 - "Always Print": A transaction report is printed no matter whether the transmission succeeds or fails.
 - "Print at Error": A transaction report is printed when transmission fails.
 - "Do not Print": Do not print a transaction report.
- Set the [Print Original Image] checkbox to to include part of the transmitted original in the transaction report.

6

Tap the [Start] key to start scanning of the original.

- If you inserted the original pages in the document feeder tray, all pages are scanned. A beep will sound to indicate that scanning and transmission have ended.
- When you place the original on the document glass, scan each page one at a time. When scanning finishes, place the next original and tap the [Start] key. Repeat the procedure until all pages have been scanned and then tap the [Read-End] key. A beep will sound to indicate that scanning and transmission have ended.



You can tap the [Preview] key to check a preview of the image before sending an image. For more information, see "[CHECKING THE IMAGE TO BE TRANSMITTED \(page 6-93\)](#)".

Original image in transaction report

When [Print Original Image] is enabled, the first page of the transmitted original is printed on the same sheet as the transaction report. The original image is reduced to allow it to fit on the sheet. If the vertical scanning length (X direction) of the original is longer than 17-1/64" (432 mm), the part that exceeds 17-1/64" (432 mm) may be cut off.



STARTING A TRANSMISSION AT A SPECIFIED TIME (TIMER TRANSMISSION)

Specify a time at which a transmission or broadcast transmission will automatically take place. Transmission begins automatically at the specified time.

This function is helpful when you wish to perform reserved, broadcast or other transmissions during your absence or at night or other times when telephone rates are low.

In fax mode, a timer setting can also be specified for polling reception to receive a fax when you are not present.

For example, if it is set to print data received during the day at 20:00, the received data will not be printed immediately, and printing will begin automatically at 20:00.

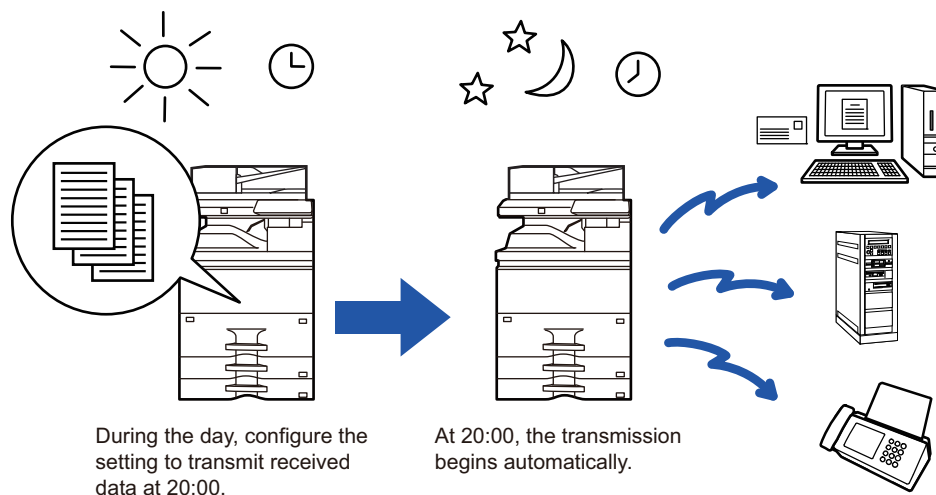

- When a timer transmission is set, keep the main power switch in the " | " position. If the main power switch is in the " ⏻ " position at the specified time, transmission will not take place.
- When performing a timer transmission, you must scan the original into memory when you set up the transmission. It is not possible to leave the document in the document feeder tray or on the document glass and have it scanned at the reserved time of transmission.
- Up to 100 timer transmissions can be stored at once.
- In fax mode, this function cannot be used in direct transmission mode or when the speaker is used to dial.



- Settings selected for a timer transmission (exposure, resolution, and other functions) are automatically cleared after the transmission is finished. (However, when the document filing function is used, the scanned original image and settings are stored in the built-in local drive.)
- If another transmission is in progress when the specified time arrives, the timer transmission will begin after that transmission is finished.
- If a job scheduled for timer transmission is given priority on the job status screen, the timer will be canceled. The transmission will begin as soon as the job in progress is completed.
[PRIORITY PROCESSING OF A RESERVED JOB \(page 2-55\)](#)
- The time can be specified up to a week in advance.
- After the timer transmission settings are specified, start the transmission in the same way as other functions.
- A timer transmission can be deleted in the job status screen.
- When in fax mode, only one timer polling operation can be stored at once. To receive data from multiple destinations by polling, specify Timer for serial polling.



1

Place the original.

When in fax mode, then after completing this procedure, proceed to Step 3.
Place the original in the document feeder tray of the automatic document feeder, or on the document glass.
[AUTOMATIC DOCUMENT FEEDER \(page 1-34\)](#)
[DOCUMENT GLASS \(page 1-38\)](#)

2

Tap the mode display to switch to the initial screen of each mode.

[CHANGING MODES \(page 2-10\)](#)

3

Specify the destination.

[RETRIEVING A DESTINATION FROM AN ADDRESS BOOK \(page 6-33\)](#)
[VIEWING A LIST OF THE SELECTED DESTINATIONS \(page 6-36\)](#)
[USING A SEARCH NUMBER TO RETRIEVE A DESTINATION \(page 6-37\)](#)
[ENTERING AN ADDRESS MANUALLY \(page 6-38\)](#)
[SPECIFYING A NETWORK FOLDER \(page 6-39\)](#)
[RETRIEVING A DESTINATION FROM A GLOBAL ADDRESS BOOK \(page 6-41\)](#)
[RETRIEVING A DESTINATION FROM A MOBILE ADDRESS BOOK \(page 6-43\)](#)
[USING A TRANSMISSION LOG TO RESEND \(page 6-45\)](#)
When in fax mode, enter the destination number.
[ENTERING A DESTINATION NUMBER USING THE NUMERIC KEYS \(page 5-10\)](#)
[RETRIEVING A DESTINATION FROM AN ADDRESS BOOK \(page 5-11\)](#)
[USING A SEARCH NUMBER TO RETRIEVE A DESTINATION \(page 5-14\)](#)
[RETRIEVING A DESTINATION FROM A GLOBAL ADDRESS BOOK \(page 5-15\)](#)
[RETRIEVING A DESTINATION FROM A MOBILE ADDRESS BOOK \(page 5-17\)](#)
[USING A TRANSMISSION LOG TO RESEND \(page 5-19\)](#)

4

Tap the [Others] key, and tap the [Timer] key.

5

Tap [On] key.

6

Specify the date.

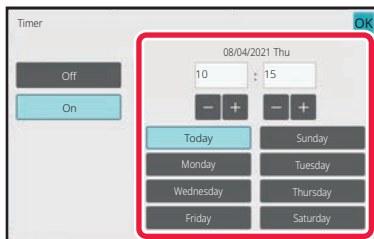



7

Specify the time (hour and minute) in 24-hour format.

After the settings are completed, tap **OK** and [Back] keys in sequence.



- Tap the areas displaying the hour and minute respectively, and enter the values using the numeric keys.
- It is convenient to use **- +** to finely adjust the time.
- The setting will show the current time. If the time is not correct, press the [CA] key to cancel the operation. Correct the time in setting mode and then perform the timer transmission procedure.
[BEFORE USING THE MACHINE AS A NETWORK SCANNER FUNCTION \(page 6-3\)](#)



To cancel the Timer Transmission settings:

Tap the [Off] key.



To set the date and time of the machine:

In "Settings", select [System Settings] → [Common Settings] → [Device Control] → [Clock Adjust].

8

Tap the [Start] key to start scanning of the original.

- If you inserted the original pages in the document feeder tray, all pages are scanned.
A beep will sound to indicate that scanning has ended, and the machine stands by for transmission.
- When you place the original on the document glass, scan each page one at a time.
When scanning finishes, place the next original and tap the [Start] key.
Repeat until all pages have been scanned and then tap the [Read-End] key.
A beep will sound to indicate that scanning has ended, and the machine stands by for transmission.



You can tap the [Preview] key to check a preview of the image before sending an image. For more information, see "[CHECKING THE IMAGE TO BE TRANSMITTED \(page 6-93\)](#)" (When in fax mode, "[CHECKING THE IMAGE TO BE TRANSMITTED \(page 5-28\)](#)").



The original is scanned into memory. The original cannot be scanned at a specified time.



ADDING A SIGNATURE WHEN SENDING AN IMAGE (ELECTRONIC SIGNATURE)

You can add a signature when sending a scanned image. This allows the recipient to check your sender information in the electronic signature.



This function is available for Scan to E-mail.



To add an electronic signature to a scanned image

- In "Settings (administrator)", select [System Settings] → [Security Settings] → [S/MIME Settings] → [Condition Settings].
- When [Select at Sending] is selected in "Sign E-mail" in "Settings (administrator)", you can specify whether or not an electronic signature is added each time you send an image. When [Always Enable] is selected, the setting cannot be changed.

1

Place the original.

Place the original in the document feeder tray of the automatic document feeder, or on the document glass.

[AUTOMATIC DOCUMENT FEEDER \(page 1-34\)](#)

[DOCUMENT GLASS \(page 1-38\)](#)

2

Tap the mode display to switch to the initial screen of E-mail mode.

[CHANGING MODES \(page 2-10\)](#)

3

Specify the destination.

[RETRIEVING A DESTINATION FROM AN ADDRESS BOOK \(page 6-33\)](#)

[VIEWING A LIST OF THE SELECTED DESTINATIONS \(page 6-36\)](#)

[USING A SEARCH NUMBER TO RETRIEVE A DESTINATION \(page 6-37\)](#)

[ENTERING AN ADDRESS MANUALLY \(page 6-38\)](#)

[SPECIFYING A NETWORK FOLDER \(page 6-39\)](#)

[RETRIEVING A DESTINATION FROM A GLOBAL ADDRESS BOOK \(page 6-41\)](#)

[RETRIEVING A DESTINATION FROM A MOBILE ADDRESS BOOK \(page 6-43\)](#)

[USING A TRANSMISSION LOG TO RESEND \(page 6-45\)](#)

4

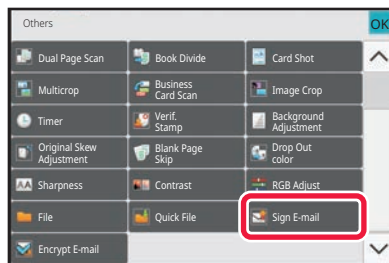

Tap the [Others] key, and tap the [Sign E-mail] key.

A checkmark appears on the icon.

After the settings are completed, tap the [Back] key.



To cancel the sign E-mail setting

Tap the [Sign E-mail] key to uncheck it.



5

Tap the [Start] key to start scanning of the original.

- If you inserted the original pages in the document feeder tray, all pages are scanned. A beep will sound to indicate that scanning and transmission have ended.
- When you place the original on the document glass, scan each page one at a time. When scanning finishes, place the next original and tap the [Start] key. Repeat the procedure until all pages have been scanned and then tap the [Read-End] key. A beep will sound to indicate that scanning and transmission have ended.



You can tap the [Preview] key to check a preview of the image before sending an image. For more information, see "[CHECKING THE IMAGE TO BE TRANSMITTED \(page 6-93\)](#)".



ENCRYPTING THE TRANSMITTED DATA (ENCRYPTION)

You can encrypt the transmitted data to strengthen security.



This function is available for Scan to E-mail.



To encrypt transmitted data

- In "Settings (administrator)", select [System Settings] → [Security Settings] → [S/MIME Settings] → [Condition Settings].
- When [Select at Sending] is selected in "Encrypt E-mail" in "Settings (administrator)", you can specify whether or not the data is encrypted each time you send an image. When [Always Enable] is selected, the setting cannot be changed.

1

Place the original.

Place the original in the document feeder tray of the automatic document feeder, or on the document glass.

[AUTOMATIC DOCUMENT FEEDER \(page 1-34\)](#)

[DOCUMENT GLASS \(page 1-38\)](#)

2

Tap the mode display to switch to the initial screen of E-mail mode.

[CHANGING MODES \(page 2-10\)](#)

3

Specify the destination.

[RETRIEVING A DESTINATION FROM AN ADDRESS BOOK \(page 6-33\)](#)

[VIEWING A LIST OF THE SELECTED DESTINATIONS \(page 6-36\)](#)

[USING A SEARCH NUMBER TO RETRIEVE A DESTINATION \(page 6-37\)](#)

[RETRIEVING A DESTINATION FROM A GLOBAL ADDRESS BOOK \(page 6-41\)](#)

[RETRIEVING A DESTINATION FROM A MOBILE ADDRESS BOOK \(page 6-43\)](#)



- Data encryption is not possible when the address is directly entered.
- Encrypted data can only be sent to an address for which you have registered a user certificate. Register a user certificate for the address in "Settings (Web version)" - [Address Book] → [E-mail] → "User Certificate". Only one E-mail address can be registered for an address that has a user certificate.
- If the "Disable sending to the addresses which cannot be encrypted." checkbox is () in "Settings (administrator)" - [System Settings] → [Security Settings] → [S/MIME Settings] → [Condition Settings] → [Encryption Settings], addresses without a user certificate cannot be selected. When the checkmark is removed () , the data is sent without encryption.

4

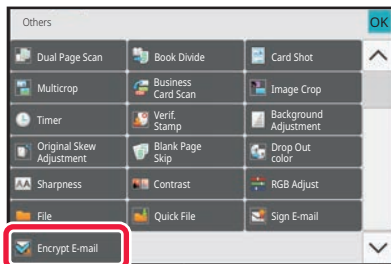

Tap the [Others] key, and tap the [Encrypt E-mail] key.

A checkmark appears on the icon.

After the settings are completed, tap the [Back] key.



To cancel the encryption setting

Tap the [Encrypt E-mail] key to remove the checkmark.



5

Tap the [Start] key to start scanning of the original.

- If you inserted the original pages in the document feeder tray, all pages are scanned. A beep will sound to indicate that scanning and transmission have ended.
- When you place the original on the document glass, scan each page one at a time. When scanning finishes, place the next original and tap the [Start] key. Repeat the procedure until all pages have been scanned and then tap the [Read-End] key. A beep will sound to indicate that scanning and transmission have ended.



You can tap the [Preview] key to check a preview of the image before sending an image. For more information, see "[CHECKING THE IMAGE TO BE TRANSMITTED \(page 6-93\)](#)".



INTERNET FAX RECEPTION FUNCTIONS

CHECKING THE INTERNET FAX ACTIVITY LOG

PRINTING IMAGE SENDING ACTIVITY REPORTS

Print a log of recent image sending activities (date, name of destination, time required, result, and other items).

The Image Sending Activity Report contains information that is useful in dealing with problems, such as the types of errors that occurred.

The most recent 200 transactions are included in the report.

You can have the machine print the Image Sending Activity Report each time the number of transactions reaches 201, or at a specified time (once a day only).



The contents of the Image Sending Activity Report are erased when the report is printed, and thus it cannot be reprinted.



To configure the image sending activity report:

In "Settings", select [System Settings] → [Image Send Settings] → [Internet Fax Settings] → [Condition Settings] → [Activity Report Print Select Setting].



INFORMATION APPEARING IN THE RESULT COLUMN

Error types and other information are printed in the result column of transaction and activity reports. When a transaction or activity report is printed, check the result of the transaction in the result column and take action as needed.

Examples of messages that are printed in the result column

Print Page	Description
OK	The transaction was completed normally.
Cancel	A transmission was stopped while in progress, or a reserved transmission job was canceled.
FULL	The memory became full during reception.
Rejected	An Internet fax was sent from a party that is blocked.
Report Wait	Transmission confirmation was enabled, but transmission confirmation was not received within the set time.
NG LIMIT	Transmission was not possible because the file size exceeded the machine's file size limit setting.
E-mail	An e-mail was received, however, the attached file was not a TIFF-F file or there was no attached file, and thus printing was not possible.
FAIL xx (xxxx)	The transaction failed due to a communication error. First 2 digits of communication error number: Error code from 00 to 99. Last 4 digits of communication error number: Code for use by service technicians.
displayed*	Displayed at the receiving machine when delivery confirmation is set.
dispatched*	Forwarded elsewhere before being displayed at the receiving machine when delivery confirmation is set.
processed*	Processed without being displayed at receiving machine when delivery confirmation is set.
deleted*	Message deleted at receiving machine when delivery confirmation is set.
denied*	Receiving machine refused to notify sending machine of message processing content when delivery confirmation is set.
failed*	An abnormal condition occurred when delivery confirmation is set.

* If the receiving machine is a SHARP machine, the receiving machine will return "dispatched" if the fax was received normally, or "processed" if reception failed.

When delivery confirmation is set for Internet Fax, the disposition feeld value indicated on the delivery confirmation return e-mail appears.



RECEIVING INTERNET FAXES

RECEIVING INTERNET FAXES AUTOMATICALLY

The Internet fax function periodically connects to the mail server (POP3 server) and checks whether or not Internet faxes have been received. When faxes have been received, the faxes are automatically retrieved and printed.

In the default setting, this function checks for reception once every five minutes.



- If faxes will be received at night, keep the main power switch of the machine in the " | " position.
- If the machine is out of paper or there is no paper that matches the size of the received fax, a message will appear in the touch panel. Follow the instructions in the message to load an appropriate size of paper.
- You can print the received Internet fax data at the specified time.
[PRINTING RECEIVED DATA AT A SPECIFIED TIME \(page 6-158\)](#)
- You can print the received Internet fax data when a password has been entered.
[PRINTING A PIN CODE-PROTECTED FAX \(Hold setting for received data print\) \(page 6-157\)](#)
- You can print, forward, or save the received Internet fax data after checking it.
[CHECKING THE IMAGE BEFORE PRINTING \(page 6-159\)](#)
[FORWARDING RECEIVED DATA MANUALLY \(page 6-167\)](#)
[SAVING RECEIVED DATA \(page 6-168\)](#)

1

The machine rings and fax reception begins automatically.

A beep sounds when reception ends.

2

The fax is automatically printed.

RECEIVING INTERNET FAXES MANUALLY

If the interval for checking for received faxes is somewhat long and you wish to check immediately, you can manually initiate reception.



The [Receive] key can be tapped only when POP3 server settings are configured in the Setting mode (administrator) .

Tap the [Receive] key to connect to the mail server and retrieve received faxes.

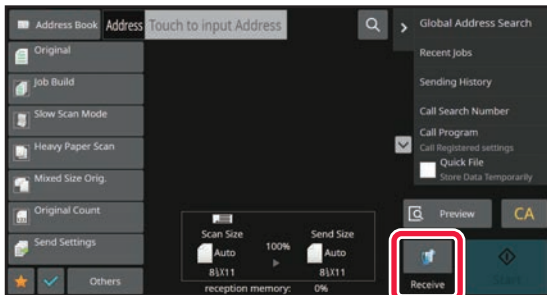



PRINTING RECEIVED DATA

PRINTING A PIN CODE-PROTECTED FAX (Hold setting for received data print)

Enable this setting to have faxes received and stored in memory without being printed. To print the faxes, a PIN Code must be entered.

When this function is used, a PIN Code entry screen appears in the touch panel when a fax is received.



To enable the hold setting for received data print:

In "Settings (administrator)", select [System Settings] → [Image Send Settings] → [Common Settings] → [Condition Settings] → [Hold Setting for Received Data Print].

When the previously programmed 4-digit PIN Code is entered using the numeric keys, printing begins.

When the [Cancel] key is tapped, the PIN Code entry screen closes; however, the data in memory key will blink in the touch panel. The PIN Code entry screen will reappear when you tap the blinking key or change modes.



- To display the received data list screen after entering the PIN Code:

In "Settings", select [**System Settings**] → [**Common Settings**] → [**Operation Settings**] → [**Condition Settings**] → [**Preview Setting**] → [**Received Data Image Check Setting**].

- To transfer received data to another machine:

In "Settings (administrator)", select [**System Settings**] → [**Image Send Settings**] → [**Inbound Routing (Forwarding/Storing) Settings**].



You can check the received data image on the touch panel before printing.

[CHECKING THE IMAGE BEFORE PRINTING \(page 6-159\)](#)



- The received faxes will be stored in memory regardless of whether they are received automatically or manually.
- When the received data is transferred to another machine, data stored in memory is also transferred. At that time, the same PIN Code entry screen will appear as for printing. Forwarding will not take place unless the PIN Code is entered.



PRINTING RECEIVED DATA AT A SPECIFIED TIME

Print received data at a specified time.

For stress-free printing, you should avoid printing large numbers of pages at peak times during the day, and when you do not urgently need to print.



- The printed data is automatically deleted from memory.
- If the power is turned off at the specified time, printing will start at the timing when the power is turned on.
- This function can be specified when the Received Data Image Check Setting is enabled.



If Hold Setting for Received Data Print is enabled, this function cannot be used.

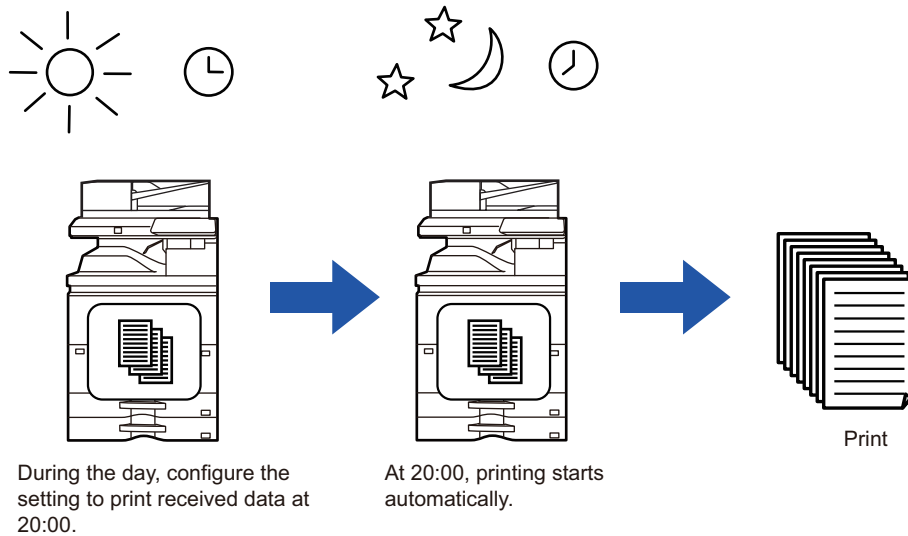

- **To print received data at the specified time:**
In "Settings", select [System Settings] → [Image Send Settings] → [Common Settings] → [Condition Settings] → [Time Specified Output of Received Data].
- **To disable the hold setting for received data print:**
In "Settings (administrator)", disable this function using [System Settings] → [Image Send Settings] → [Common Settings] → [Condition Settings] → [Hold Setting for Received Data Print].



CHECKING THE IMAGE BEFORE PRINTING

Check the image of received data on the touch panel before printing.

This function is available when [System Settings] → [Image Send Settings] → [Common Settings] → [Condition Settings] → [Preview Setting] → [Received Data Image Check Setting] is enabled* in "Settings (administrator)"

* The factory default setting is disabled.



Depending on the size of the received data, part of the check image on the touch panel may not appear.



The received data list can also be shown in the job status screen that appears when you tap the job status display. The received data can be forwarded, deleted, or saved from Received Data List.

[FORWARDING RECEIVED DATA MANUALLY \(page 6-167\)](#)

[SAVING RECEIVED DATA \(page 6-168\)](#)

When data is received,  is shown at the top of the screen.

1

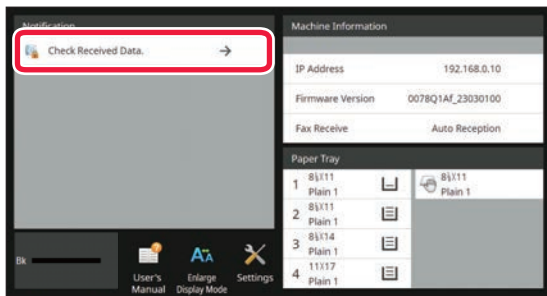

In the System Information, tap the [Check Received Data].

The received data is listed.



You can also display the received data list by tapping the job status display and tapping [Check Received Data] on the action panel of Job Status screen.

2

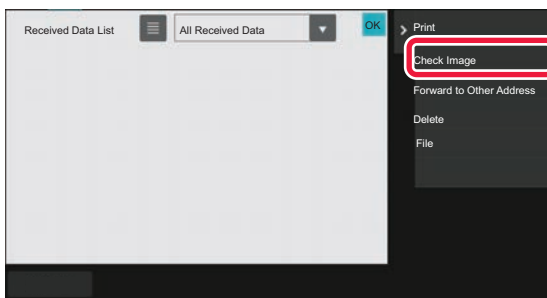

Tap the key of the received data you wish to check, and tap [Check Image] on the action panel.

Displays the received data image.



- Tap  to show thumbnails of received images (Thumbnail screen). The list view or thumbnails view can be changed depending on the setting mode.
- To delete a received image, tap [Delete] on the action panel.
- To transfer the selected received image, tap [Forward to Other Address] on the action panel.
[FORWARDING RECEIVED DATA MANUALLY \(page 6-167\)](#)
- To save the selected received image, tap the [File] key.
[SAVING RECEIVED DATA \(page 6-168\)](#)



3



Tap the image you wish to print, and tap [Print] on the action panel.

The machine starts printing the image.

- [Select All Page]: Selects all displayed images.
- [Release All Page]: Cancels all images that have been selected by "Select All Page".
- / : Use these keys to enlarge or reduce an image.
- / : Rotates image counterclockwise or clockwise.



- A preview image is an image for the touch panel. It will differ from the actual print result.
- Tap [Erase Specified Range] on the action panel to delete unwanted area of the image. Specify the image area you wish to delete in the Erase Specified Range screen.
- To forward the selected image, tap the [Forward to Other Address] on the action panel.
[FORWARDING RECEIVED DATA MANUALLY \(page 6-167\)](#)
- To save the selected image, tap the [File] key.
[SAVING RECEIVED DATA \(page 6-168\)](#)



FORWARDING RECEIVED DATA

FORWARDING RECEIVED INTERNET FAX DATA (FAX DATA FORWARD)

When the machine cannot print because it is out of paper or out of toner, received Internet faxes are forwarded to another previously registered Internet fax address (including direct SMTP).

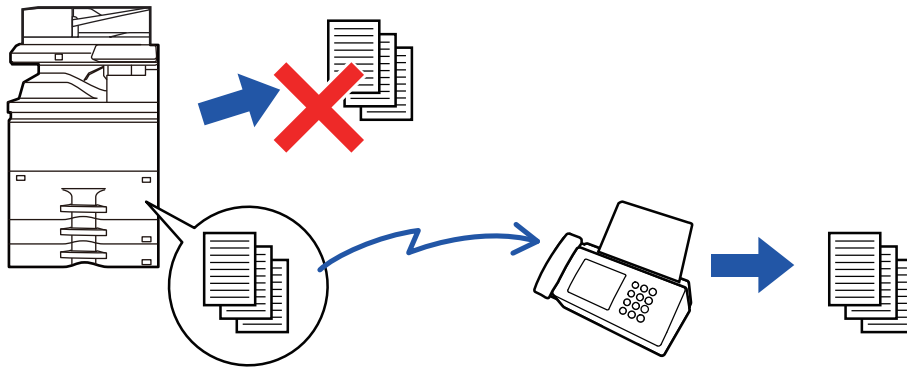

- Forwarding is not possible if no faxes were received or a forwarding fax number is not programmed.
- If some pages of a fax that is being forwarded were successfully printed, only those pages that were not printed will be forwarded.
- If forwarding was not successful because the transmission was canceled or a communication error occurred, the faxes that were to be forwarded will return to the print queue on the machine.
- If a PIN Code entry screen appears after tapping the [OK] key, "Hold Setting for Received Data Print" has been enabled. Enter the PIN Code using the numeric keys to begin forwarding.

[PRINTING A PIN CODE-PROTECTED FAX \(Hold setting for received data print\) \(page 6-157\)](#)

1

Tap the [Settings] key on the Home screen.

2

Select the [System Settings] key and tap the [Image Send Settings] key.

3

Tap the [Fax Data Receive/Forward (Manual)] key.

4

To start forwarding, tap the [Execute] key of "Forward Received Data" in "I-Fax Settings".



FORWARDING RECEIVED DATA TO PRESET DESTINATIONS (INBOUND ROUTING SETTINGS)

Received Internet faxes are automatically forwarded to a fax destination number, an Internet fax address, an e-mail address, a file server address, a desktop address, or a network folder address.

Received data can be forwarded to the specified destinations without being printed.

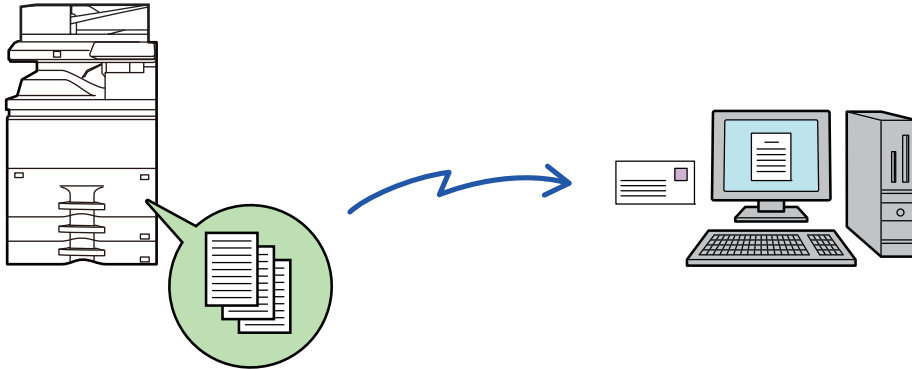

In setting mode (Web version), configure the inbound routing settings. For the procedure for accessing the setting mode (Web version), see Start Guide.

The following explanation assumes that the setting mode (Web version) has been accessed with administrator rights.



Whether or not to forward data for each forwarding table can be quickly set.

In "Settings (administrator)", select [Image Send Settings] → [Inbound Routing (Forwarding/Storing) Settings] → [Administration Settings] → [Inbound Routing], and tap [Enable]/[Disable] on the displayed forwarding table to switch the settings.



- When faxes forwarded using this function are printed at the forwarding destination, the date and time of reception cannot be printed on the faxes. ("Receiving Date & Time Print" is disabled.)
- The received data is not forwarded to a hyperlink destination that is registered in the specified address.
- A direct SMTP address cannot be specified as a forwarding destination.

1

In "Settings (Web version)", click [System Settings] → [Image Send Settings] → [Inbound Routing (Forwarding/Storing) Settings] → [Administration Settings].

2

In "Inbound Routing", select [Enable] and click the [Submit] button.



- Users without administrator rights can be prohibited from storing, editing, and deleting forwarding tables in this screen, and from specifying which table is used. To do so, set the checkboxes for the following items to .
- Disable Registration of Forward Table
- Disable Change/Delete of Forward Table
- Disabling of Forward Condition Change
- Specify in [Print Style Setting] whether or not to have the machine to print the faxes to forward when inbound routing is enabled. After the settings are completed, be sure to click the [Submit] button.
- [Always Print]: Always prints received data before forwarding the data.
- [Print at Error]: Prints received data only when an error prevents forwarding.
- [Save Only at Error]: Saves received data only when an error prevents forwarding. For the saved data, the error address can be confirmed and the data can be resent.



3

Click [Sender Address Registration] in the [Inbound Routing (Forwarding/Storing) Settings] menu in the "Settings (Web version)".

4

Enter the sender address or fax number in "Internet Fax Address" or "Fax Number" as appropriate, and click the [Add to List] button.

The sender address or number you entered will be added to the "Address to be Entered" list.

- Enter the address directly (maximum of 1500 characters) or select the address from a global address book by clicking the [Global Address Search] button.
- To store multiple sender addresses or fax numbers, repeat these steps.



- If you wish to have only faxes from specified addresses forwarded, store the desired sender addresses. Send addresses stored here can be selected from a list when you store a forwarding table.
- A maximum of 500 sender numbers/addresses can be stored.
- To delete an entered address, select the address in "Address to be Entered" and click the [Delete] button.

5

When you have finished adding addresses, click the [Submit] button.

6

Click [Inbound Routing Settings] in the "Inbound Routing (Forwarding/Storing) Settings" menu in the "Settings (Web version)" menu and click the [Add] button.

7

Enter a "Table Name".



A maximum of 50 forwarding tables can be stored.

8

Select the sender whose faxes will be forwarded.

- To forward all received data, select [Forward All Received Data].
- To forward only data received from specific senders, select [Forward received data from specified senders only.]. To forward all data except data from specific senders, select [Forward all received data except that from specified senders.]. Select the appropriate senders from the list and click the [Add] button.



When selecting senders from the "Sender Number/Address Setting" list, you can use the [Shift] key or the [Ctrl] key on your keyboard to select multiple senders.

9

Select the forwarding conditions.

- To always forward received data, select [Always Forward].
- To specify a day and time on which received data will be forwarded, select [Forward received data only on specified days.] and select the checkbox () of the desired day of the week. To specify a time, select the [Set Forwarding Time] checkbox () and specify the time.



Up to three forwarding day and time settings can be set for one forwarding table, and a forwarding destination can be set for each set time. To configure these settings, use the [Forward Condition] tabs to access each setting.



10

Select the file format.

The format can be set separately for each forwarding address (for each of forwarding addresses 1, 2, and 3 in the table).



- Images forwarded in TIFF format may not be displayed correctly in some recipient environments. In this event, change the file format to PDF.
- If the Internet fax address is selected as a recipient, data is forwarded in TIFF regardless of the specified format.
- If a fax number is selected as a recipient, the file format is ignored.

11

Select the recipient from the address book.

You can specify multiple registered addresses or telephone numbers from the address book of the machine. Up to 1,000 recipients can be registered for Recipients 1, 2, and 3 in total. When you select the recipients from the address book, up to 400 recipients can be registered for network folder, FTP/Desktop, Internet fax, and fax.



A direct SMTP address cannot be specified as a forwarding destination.

12

Enter a recipient directly and specify the recipient.

- Specify this information if necessary.
- Enter an E-mail address, an Internet fax address, or a fax number directly and tap the [Add to forwarding destinations] key.
- When you specify an E-mail address or a fax number, you can use the global address search.
- When you specify a fax number, also specify the sending line and international correspondence mode.
- When enter the recipients directly, up to 100 recipients can be registered for E-mail address, network folder, FTP/Desktop, Internet fax, and fax.

13

Click [Submit].

14

Click [Inbound Routing Settings] in the "Inbound Routing (Forwarding/Storing) Settings" menu in the "Settings (Web version)" menu.

15

From the forwarding table, select [Forward to All Forward Destinations] or [Forward based on Forward Condition].

16

Select [Always Forward] or [Forward received data only on specified days.] from the forwarding table.

The forwarding permission settings that appear here are linked to the forwarding conditions set in step 9. If you wish to use different forwarding conditions than those set in step 9, set the forwarding permission settings.



- To use the inbound routing function, enable the forwarding tables that you wish to use from among the stored tables.
- To delete a forwarding table, click the checkbox next to the table name so that it is selected () and click [Delete].

17

Click [Submit].



SAVING RECEIVED FAXES TO THE MACHINE'S LOCAL DRIVE (INBOUND ROUTING)

Received faxes can be saved to the machine's local drive. Saved faxes can be viewed on a computer.

Set PDF, TIFF (multi) or TIFF (signal) for the saved Internet faxes.

You can also receive notification of the storage result or storage folder by E-mail.

Received faxes are saved in the following directory:

\\MFP\faxreceive

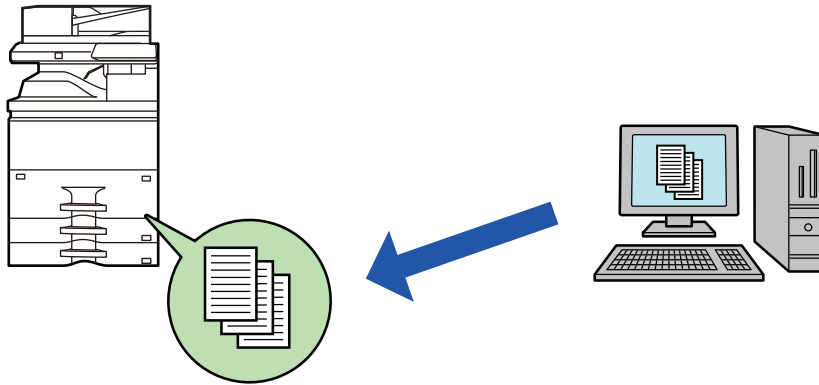

- Up to 500 files can be stored in one folder as received data.
- The "faxreceive" folder contains files of "Settings for Local Drive Storing of Received Data".
- The folder is automatically created.
- The folder name is automatically assigned based on the setting of "Settings for Local Drive Storing of Received Data" in the received data save settings.



How to save received faxes to the local drive

1

In "Settings (administrator)", click [System Settings] → [Network Settings] → [Public Folder / NAS Setting]. (Administrator rights required.)

2

Select [Allowed] in "faxreceive:Use of Storage" and click the [Submit] button.

Settings for saving received faxes to the local drive

1

In Setting mode (administrator), click [System Settings] → [Image Send Settings] → [Inbound Routing (Forwarding/Storing) Settings] → [Inbound Routing (Storage) Settings] → [Settings for Local Drive Storing of Received Data]. (Administrator rights required.)



- Data that can be saved are received faxes and received Internet faxes. Confidential reception and polling reception faxes cannot be saved.
- Depending on the setting, received faxes that cannot be saved because of the file number limit or other reason are either printed or saved in the inbound routing error box.



FORWARDING RECEIVED DATA MANUALLY

Received faxes can be forwarded manually after receipt.

This function is available when [System Settings] → [Image Send Settings] → [Common Settings] → [Condition Settings] → [Preview Setting] → [Received Data Image Check Setting] is enabled* in "Settings (administrator)".

* The factory default setting is disabled.

When data is received,  is shown at the top of the screen.

1

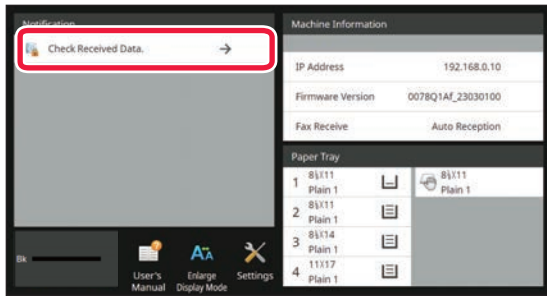

In the System Information, tap the [Check Received Data].

The received data is listed.



You can also display the received data list by tapping the job status display and tapping [Check Received Data] on the action panel of Job Status screen.

2

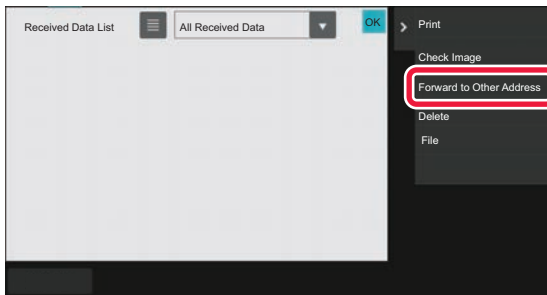

Tap the key of the received data you wish to forward, and tap [Forward to Other Address].

- Tap  to show thumbnails of received images (Thumbnail screen). The list view or thumbnails view can be changed depending on the setting mode.
- Multiple sets of received data can be selected.



When you select a single received data only, you can tap [Check Image] on the action panel and check the image on the preview screen.

3

Select the destination from the Address Book screen, and tap the [Start] key.





SAVING RECEIVED DATA

Save received faxes in the document filing folder.

This function is available when [System Settings] → [Image Send Settings] → [Common Settings] → [Condition Settings] → [Preview Setting] → [Received Data Image Check Setting] is enabled *in "Settings (administrator)".

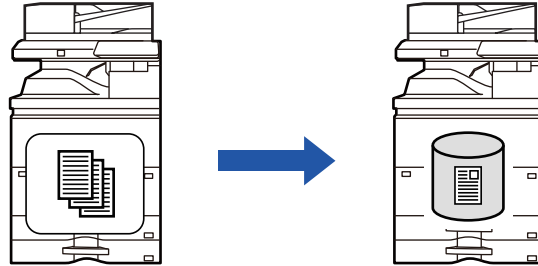
* The factory default setting is disabled.



When data is received,  is shown at the top of the screen.

1

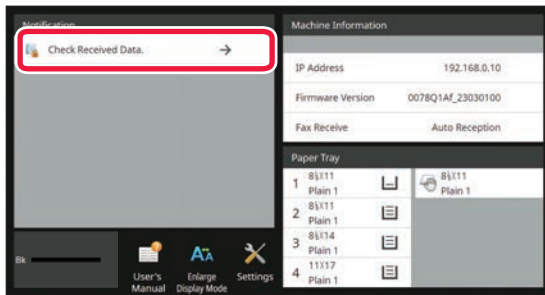

In the System Information, tap the [Check Received Data].

The received data is listed.



You can also display the received data list by tapping the job status display and tapping [Check Received Data] on the action panel of Job Status screen.

2

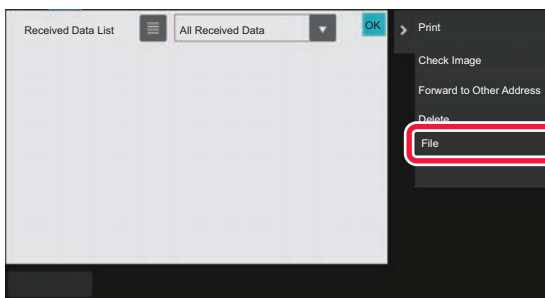

Tap the key of the received data you wish to save, and tap [File] on the action panel.

- Tap  to show thumbnails of received images (Thumbnail screen). The list view or thumbnails view can be changed depending on the setting mode.
- Multiple sets of received data can be selected.



When you select a single received data only, you can tap [Check Image] on the action panel and check the image on the preview screen.

3

Set the file information, and tap the [Save] key.



CHECKING THE STATUS OF TRANSMISSION/RECEPTION JOBS

IMAGE SEND JOBS

When you tap the job status display, jobs are displayed in a list. To check the status of a scanner mode job, select the [Scan] tab. To check the status of an Internet fax job, select the [Internet Fax] tab.

When you wish to stop or delete jobs or to perform priority processing, see the following items:

[STOPPING/DELETING A JOB IN PROGRESS OR RESERVED \(page 2-54\)](#)

[PRIORITY PROCESSING OF A RESERVED JOB \(page 2-55\)](#)

[CHECKING A RESERVED JOB OR THE JOB IN PROGRESS \(page 2-57\)](#)

[CHECKING COMPLETED JOBS \(page 2-58\)](#)

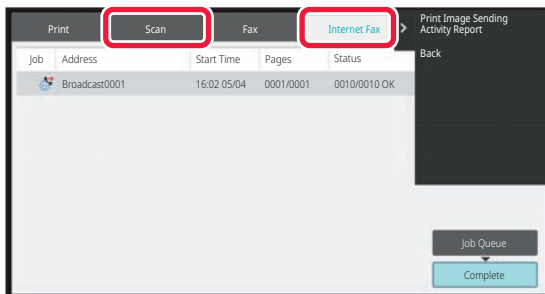

Image send jobs include reception, timer transmission, and data forwarding as well as usual transmission. For the Image Send job operations, see "[COMPLETED TRANSMISSION/RECEPTION JOBS \(page 6-170\)](#)".



COMPLETED TRANSMISSION/RECEPTION JOBS

A usual transmission job moves to the job list when transmission is completed. Then the status field displays "Send OK". However, Internet Fax jobs such as reception, timer transmission, retries, and forwarding are displayed in the job status screen as follows:

Reception job

During Internet Fax receiving, the status field displays "Receiving" in the job queue list. When reception is completed, the job moves to the completed job list and the status field displays "In Memory". After Internet Fax printing is completed, the status changes to "Received".

Timer transmission jobs

A timer transmission job appears at the end of the job queue list until the specified time is reached.

Transmission begins at the specified time. When transmission is completed, the job moves to the completed job list and the status field displays "Send OK".

Internet Fax transmission job with reception report request specified

An Internet Fax transmission job with a reception report request specified, excluding a direct SMTP transmission job, is placed into the standby state at the bottom of the Job Queue screen after a transmission has been completed. "Report Wait" appears in the status field.

The screen changes to the completion screen when a reception report e-mail has been received from the destination.

Reception jobs when the inbound routing settings are enabled

When the inbound routing settings are enabled, reception jobs are handled as follows depending on the print setting.

[FORWARDING RECEIVED DATA TO PRESET DESTINATIONS \(INBOUND ROUTING SETTINGS\) \(page 6-162\)](#)

Received data is not printed

When a data is being received, "Receiving" appears in the job queue list. When the reception is completed, the status changes to "Waiting".

Received Internet fax is printed

When reception is completed, the status field displays "In Memory" in the completed job list. After the fax is printed, the status changes to "Received". Then a job is added for which the status field displays "Waiting" in the job queue list.

When forwarding the received fax is completed, the field changes to "Forward OK".



SCANNING FROM A COMPUTER (PC Scan Mode)

BASIC SCANNING PROCEDURE

You can install the scanner driver on your computer and use a TWAIN* compliant application to scan an image using your computer.

Scanning from your computer is most useful for scanning a single original such as a photo, particularly when you want to adjust scan settings as you scan. By contrast, scanning at the machine is most useful for continuous scanning of multiple originals.

* An interface standard used for scanners and other image input devices. When the scanner driver is installed on your computer, you can use any TWAIN-compliant application to scan an image.



- For the procedures for installing the scanner driver and configuring settings, see the Software Setup Guide.
- This function cannot be used when it has been disabled using "Disable Scan Function" in the system settings (administrator).
- The procedures for selecting the scanner driver and starting scanning vary depending on the TWAIN-compliant application. For more information, see the manual for the application or Help.
- When a large image is scanned at high resolution, the amount of data will be very large and scanning will take a long time. Be sure to select appropriate scan settings for the original (text, photo, etc.).

As an example, the procedure for scanning from the "Sharpdesk" application is explained below.



Prohibit PC Scan:

- Prohibit sending when a fax number or address is manually entered To enable the hold setting for received data print
- In "Settings (administrator)", select [System Settings] → [Image Send Settings] → [Common Settings] → [Enable/Disable Settings] → [Settings to Disable Transmission] → [Disabling of PC Scan].
- Prohibit PC Scan.

[At the machine]

1

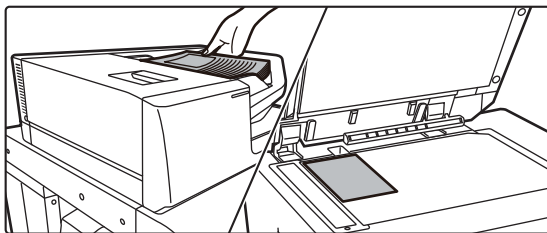

Place the original.

Place the original face up in the document feeder tray, or face down on the document glass.

2

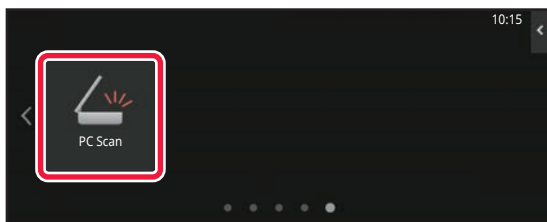

Tap the [PC Scan] mode icon to switch to PC Scan mode.

If the [PC Scan] mode icon does not appear, tap  to move the screen.



When PC scan mode is selected, only the [Exit] key displayed in the touch panel can be used on the machine; no other keys can be used.

[At your computer]

3

Start the TWAIN-compliant application on your computer and select [SHARP MFP TWAIN K] in the application's scanner selection.

4

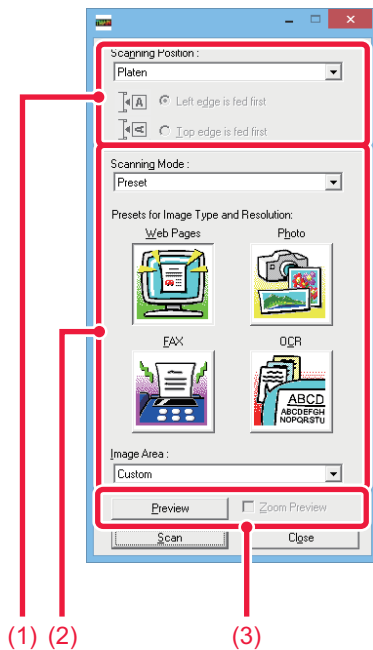

Preview the image.

(1) Select the location where the original is placed.

"Scanning Position" menu:

- If the original is a one-sided original and is placed in the document feeder tray, select [SPF(Simplex)].
- If the original is a 2-sided original and is placed in the document feeder tray, select [SPF(Duplex - Book)] or [SPF(Duplex - Tablet)] depending on whether the original is a book-style or tablet-style original. In addition, select [Left edge is fed first] or [Top edge is fed first] depending on the orientation of the original.

(2) Select scan settings.

"Scanning Mode" menu:

Switch between the "Preset" screen and the "Custom Settings" screen. In the "Preset" screen, select "Web Pages", "Photo", "FAX" or "OCR" depending on the original type and your scanning purpose. If you wish to change the initial settings of any of the four buttons or select the resolution or other advanced settings, change to the "Custom Settings" screen.

"Image Area" menu:

Select the scan area. If "Auto" is selected, the original size detected by the machine will be scanned. You can also set the scanning area in the preview window with your mouse.

(3) Click the [Preview] button.

The preview image will appear in the scanner driver. If you are not satisfied with the preview image, repeat (2) and (3).

If the [Zoom Preview] checkbox is selected before the [Preview] button is clicked, the selected area will be enlarged in the preview window. If the checkmark is removed, the preview image will return to normal. Note that if SPF is selected in the "Scanning Position" menu, the [Zoom Preview] function cannot be used.



- For further information on the scan settings, click the  button in the preview image screen of step 7 to open scanner driver Help.
- If the [Preview] button is clicked when scanning from the document feeder tray, only one original page will be scanned for the preview image. If you wish to include that original in the scan, return it to the document feeder tray.



5

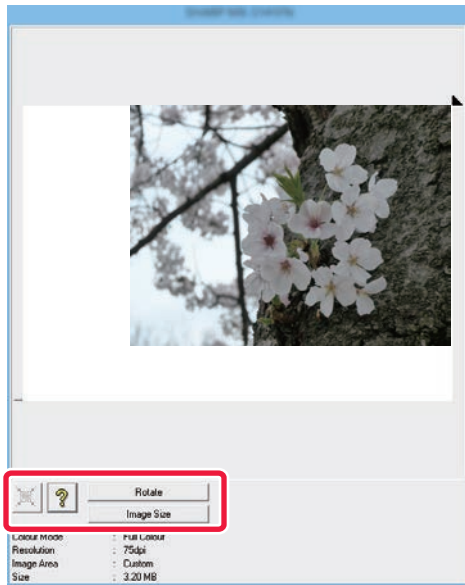

Select scanning settings while viewing the image.

[Rotate] button:

Each time this button is clicked, the preview image rotates 90 degrees. This lets you change the orientation of the image without picking up and placing the original again. The image file will be created using the orientation that appears in the preview window.

[Image Size] button:

Click this button to specify the scan area by entering numerical values. Pixels, mm, or inches can be selected for the units of the numerical values. If a scanning area has already been specified, the entered numbers will change the area relative to the top left corner of the specified area.

[?] button:

When a preview image is displayed and a scanning area is not specified, you can click the button to automatically set the scanning area to the entire preview image.



- For further information on the scan settings, click button to open scanner driver Help.
- If the originals are placed in the document feeder tray, only the top page will be previewed. The top page will be delivered to the original exit tray. Be sure to return the previewed page to the document feeder tray before previewing again or scanning.

6

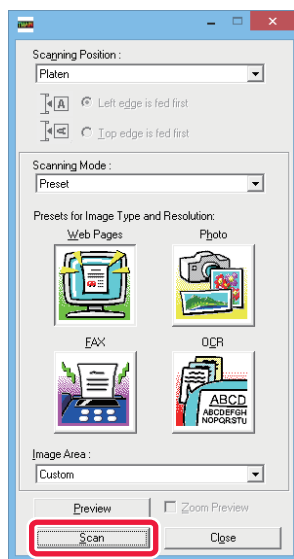

Click the [Scan] button.

Scanning begins. The image appears in your application. Assign a file name to the scanned image and save it as appropriate in the software application you are using.

[At the machine]

7

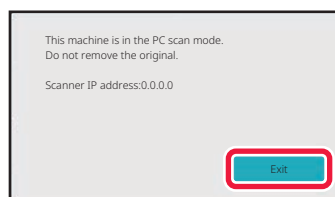

Tap the [Exit] key.



8

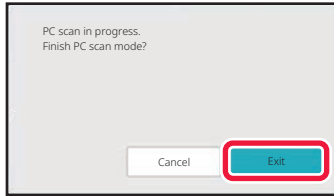

Tap the [Finish] key.



METADATA DELIVERY

PREPARATIONS FOR METADATA DELIVERY

METADATA DELIVERY (DATA ENTRY)

When the application integration module kit is installed, metadata (data indicating the attributes of the image file and how it is to be processed) is generated based on pre-stored information and transmitted separately from an image file that is generated for sending a scanned image. The metadata file is created in XML format. By linking the metadata with applications such as document management software, a workflow application, or an encryption server, a sophisticated document solution environment can be built. Using the application integration module kit, information on a generated image file can be entered at the touch panel and transmitted along with the image as an XML file.

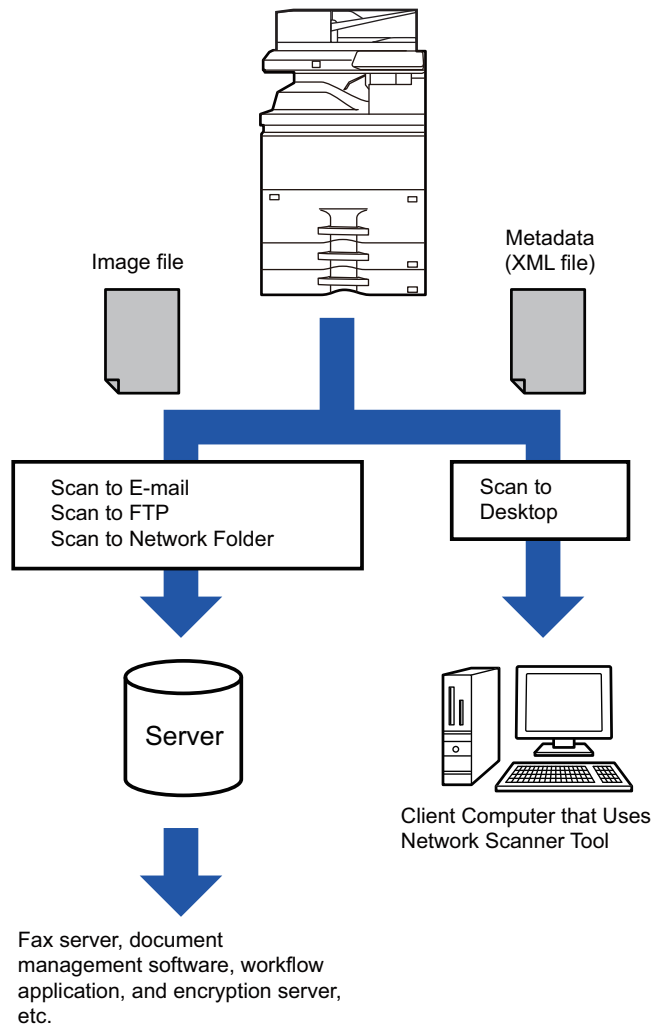



SETTINGS REQUIRED IN THE SETTING MODE (WEB VERSION)

To configure the settings related to metadata, select [System Settings] → [Image Send Settings] → [Metadata Settings] → [Metadata Entry] in "Settings (administrator)". (Administrator rights are required.)
Enable metadata delivery.

Storing Metadata Sets

Store the items (the metadata set) to write to the XML file that will be generated during scanning. Up to 10 metadata items can be configured in a metadata set. A stored metadata set can be selected at the time of transmission.

Addresses specified in "Address Type Allowing Metadata Entry" when a metadata set is stored can be selected as transmission destinations at the time of transmission using one-touch keys, manual entry, or a global address book search. (Addresses for which metadata entry is not allowed cannot be specified as transmission destinations.)

METADATA DELIVERY USING SCAN TO DESKTOP

When Network Scanner Tool Lite is used in its factory default configuration, a file will be generated with a new file name on the PC.

When Network Scanner Tool Lite is used as a means of sending a metadata file to a third party application, this setting must be disabled to allow cross referencing between the image file and XML file by means of the file name generated by the computer.

(When setting the file name in [Options ▼], to ensure that an existing file on the PC is not overwritten by a transmitted file of the same name, be sure to configure the file name so that name duplication will not occur; for example, by including a unique extension (the date, etc.) in the generated file name. If the file name setting is left blank, the machine will automatically generate a unique file name.)



It is recommended that you use Network Scanner Tool Lite to receive metadata.

Using third party applications

Various types of third party applications exist. Some applications can start automatically from Network Scanner Tool Lite and some cannot.

When the auto-run function of an application is enabled, Network Scanner Tool Lite will start the application with the ".exe" command using the image file name as a parameter. For example, when Network Scanner Tool Lite is set to start application "APP.EXE", the "APP.EXE IMG.TIF" command is applied. If a file was specified to receive metadata, the metadata file name cannot be specified at the same time using the command to start the application directly.

(However, the metadata file is stored in the same folder as IMG.TIF in the computer.)



TRANSMITTING METADATA

TRANSMITTING METADATA

Select a metadata set, enter each item, and perform metadata delivery.



- Metadata delivery is performed using the document filing function. The [Data Entry] tab appears in the transmission settings screen of document filing mode to allow metadata delivery.
- In addition, perform metadata delivery using document filing in [Metadata Entry] in "Settings (Web version)."



- **In data entry mode, configure metadata settings to perform metadata delivery.**
To perform transmission without sending metadata, switch the screen from data entry mode to a different mode and then perform transmission.
- When metadata settings have been configured or an address is specified in data entry mode, it will not be possible to switch to another mode.
- Before configuring metadata settings, specify addresses in all available modes. After metadata settings have been configured, specify only addresses in modes that are allowed in the selected metadata.

1

Tap the [Data Entry] icon on the [Home Screen], and tap [Metadata Set].



If a specific metadata set has been specified as the default set, go to step 3.



If no metadata sets have been stored, Metadata Entry is unavailable. Store metadata set in the setting mode (Web version) before performing transmission.

2

Tap the key for the desired metadata set.

3

The keys of the items stored in the metadata set will appear. Tap the key of the item that you wish to enter.

4

Tap the key of the value that you wish to enter, and tap the [OK] key.

To directly enter the metadata value, tap the [Direct Entry] key. On the soft keyboard screen that appears, tap the [OK] key. You will return to the screen shown in step 3.

After the settings are completed, tap **OK**.



To cancel the selection of the metadata value: Tap the [Clear] key.

5

Configure image or other settings, and perform the scan send procedure.

- Configure job detail settings and then start transmission using the same operations as in other modes.
- When directly entering an address, tap [Touch to input Address] to display the screen for selecting an address type. If the address type such as E-mail, Internet Fax, Fax, Network Folder, or Direct SMTP is selected, the address type entry screen appears.



METADATA FIELDS

The following three types of metadata are included in the XML file that is transmitted.

- Data automatically generated by the machine
These data are always included in the XML file and are automatically stored on your PC.
- Previously defined fields
These fields are automatically recognized by the machine and assigned to appropriate XML tags. These fields can be selected, and can only be included in the XML file if they are enabled in the setting mode (Web version).
- User defined fields
Custom fields are added to the XML file. These fields can be selected and are defined in the setting mode (Web version).
If a defined metadata field is one of the following fields, a message will appear informing you that the field cannot be filled in. Enter appropriate information in the related items of the send settings.

Name entered in metadata fields	Description	Where entered
formName	Name of the user who sent the job. If the name is not entered as metadata, the sender name determined by the usual rules for determining the sender name will be applied as metadata.	[Reply-To] (sender name of selected sender)
replyTo	E-mail address to which the transmission result will be sent.	[Reply-To] (E-mail address of selected sender)
documentSubject	Job name appearing in the E-mail "Subject" line, or job name on the fax cover sheet. When the user enters a [Subject] in the send settings screen in the touch panel, the entered value is applied as metadata.	[Subject] (Blank until a value is set in the send settings screen.)
fileName	Enter the file name of the image to be sent.	[File Name] (Only when the [Allow Custom Filenames] checkbox is selected in the metadata entry screen in the setting mode (Web version)) <input checked="" type="checkbox"/> (Blank until a value is set in the send settings screen.)



DOCUMENT FILING

DOCUMENT FILING

DOCUMENT FILING	7-2
USES OF DOCUMENT FILING	7-3
TYPES OF DOCUMENT FILING	7-3
BEFORE USING SCAN TO LOCAL DRIVE IN DOCUMENT FILING	7-3
USING DOCUMENT FILING IN EACH MODE	7-7
BASE SCREEN OF DOCUMENT FILING MODE	7-8

SAVING FILES WITH DOCUMENT FILING

FILING WHILE USING ANOTHER MODE	7-9
QUICK FILE	7-9
FILE	7-10
SAVING DOCUMENT DATA ONLY (SCAN TO LOCAL DRIVE)	7-15
SAVE ON LOCAL DRIVE	7-15
SAVE IN EXTERNAL MEMORY DEVICE	7-17

USING STORED FILES

SEQUENCE FOR USING A STORED FILE	7-20
FILE SELECTION SCREEN	7-21
LIST DISPLAY MODE	7-21
THUMBNAIL DISPLAY MODE	7-22
SELECTING A FILE TO RETRIEVE	7-23
FILE PRINTING	7-24
QUICK PRINTING	7-24
CHANGING SETTINGS BEFORE PRINTING	7-24
MULTI-FILE PRINTING	7-25
MULTI-FILE PRINTING	7-25
BATCH PRINTING	7-26
FILE TRANSMISSION	7-27
FILE MOVING	7-28
DELETE FILE	7-29
Automatic Deletion of File	7-30
FILE IMAGE CHECKING	7-31
FILE IMAGE	7-31
FILE MERGING	7-32
RETRIEVING AND USING A FILE FROM THE JOB STATUS SCREEN	7-33
FILE SEARCH AND RETRIEVAL	7-34
PRINTING AN EXTERNAL FILE	7-36
OPERATION IN THE WEB PAGE	7-36
Document Operations	7-36



DOCUMENT FILING

DOCUMENT FILING

This function saves the original scanned on the machine, transmitted fax image, or print data from a computer on the local drive of the machine or an external memory device as data.

The stored files can be printed or transmitted as required. Editing of the stored files, for example combining, is also possible.



A PDF file created for PC browsing can be displayed or printed on a computer.

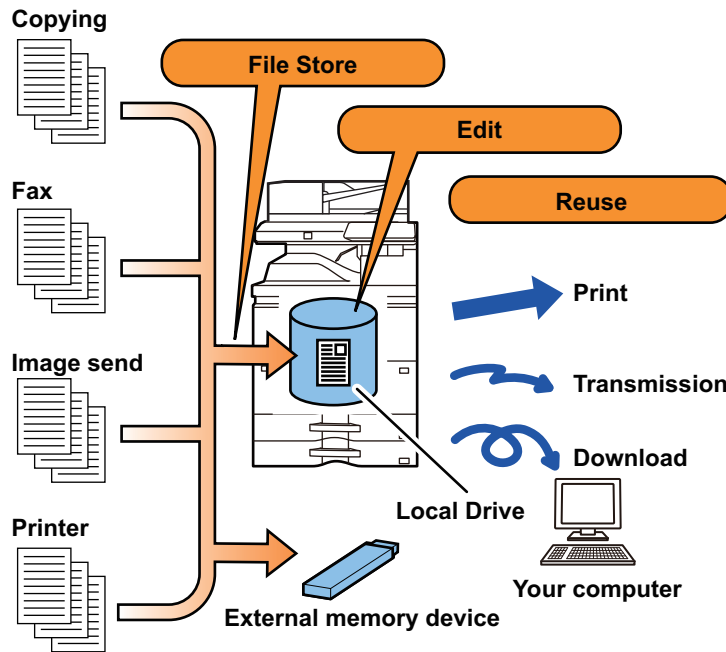



USES OF DOCUMENT FILING

Using the document filing function allows you to additionally print out conference material with the same settings, or print out ledger sheets used for routine tasks as required.

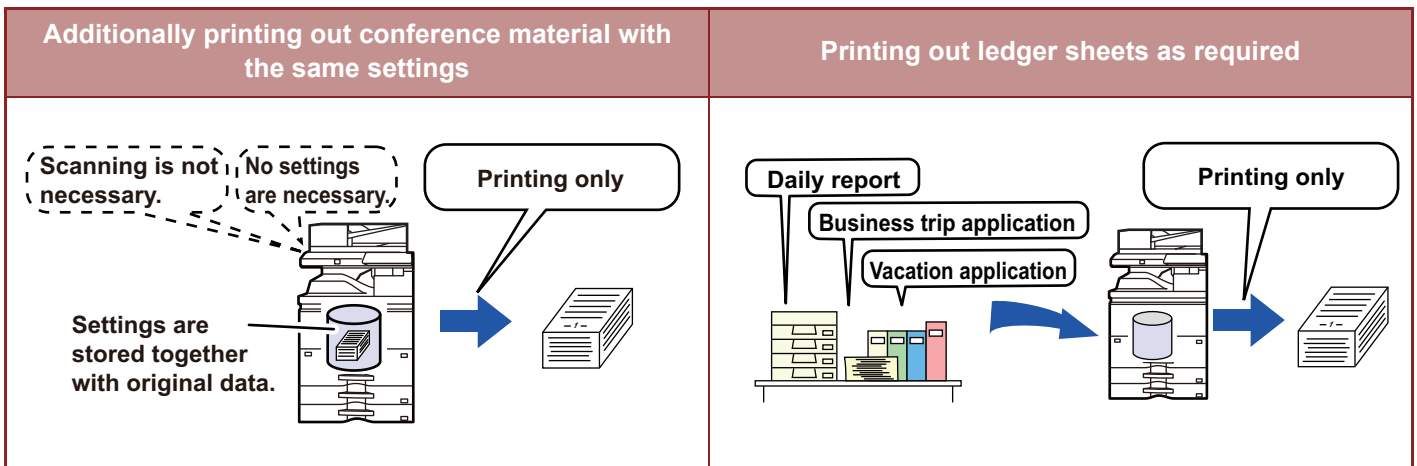

TYPES OF DOCUMENT FILING

There are the following ways to save a file using document filing: [Quick File] and [File] in copy mode or image send mode, and [Scan to Local Drive] and [Scan to External Memory Device] in document filing mode.

Quick File	As a copy, image send, or other job is performed, this function saves the document data to the local drive. Use this function when you want to quickly and easily store document data without specifying a file name or other information. The stored file can also be used by other people. Do not use this method to save files that you do not want others to use.
File	As a copy, image send, or other job is performed, this function saves the document data to the local drive. Unlike Quick File, various types of information can be appended to the file when the file is saved to enable efficient file management. A password can also be established.
Scan to Local Drive	This function scans an original and stores it to the local drive. Like File, various types of information can be appended.
Scan to External Memory Device	This function scans an original and stores it in an external memory device such as a USB memory device. Like File, various types of information can be appended.

BEFORE USING SCAN TO LOCAL DRIVE IN DOCUMENT FILING

Folder types

Three types of folders are used to store files on the local drive using the document filing function.

Folders on the local drive

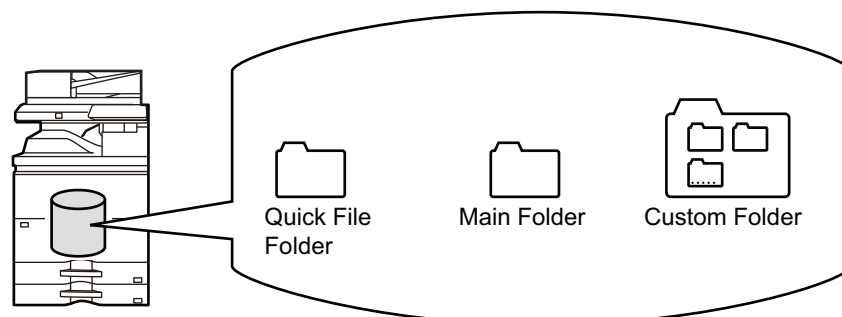



Quick File Folder

Documents scanned using [Quick File] on the action panel are stored in this folder. A user name and file name are automatically assigned to each job.

Main Folder

Scanned documents are stored in this folder.

When you store a job in the Main folder, you can specify a previously stored user name and assign a file name.

A password (4 to 32 characters) can also be set when storing a file ("Confidential" save) as required.

Custom Folder

Folders with custom names are stored inside this folder.

Scanned documents are stored in the stored folder.

Like the Main folder, a custom folder allows you to specify a previously stored user name and assign a file name when storing a job.

Passwords (PIN code: 4 to 8 digit number) can be established for custom folders and for files saved in custom folders.



A maximum of 1000 custom folders can be created on the local drive.

Convenient items to store

When storing a job using [File] in copy mode or image send mode, or [Scan to Local Drive] in document filing mode, it is convenient to store the items below. These settings are not required when storing a job using [Quick File].

User Name	This is necessary if you will be assigning a user name to stored files. A user name is also used as a search condition when searching for a file.
Custom Folder	The Main folder is initially available as a location for storing files by [File] and [File Store]. Store a custom folder and specify it as a location for storing files. Specify a password for the user folder as required. Enter the PIN Code to use the folder. When the folder is set a password, "🔒" appears in the folder that the password is set.
My Folder	A previously created custom folder can be selected as "My Folder", or a new folder created as "My Folder". When "My Folder" has been configured and user authentication is used, "My Folder" will always be selected as the destination of [File] and [File Store].



• **To store a custom folder for document filing:**

On the Web page, select "Settings (administrator)" → [Document Operations] → [Document Filing] → [Custom Folder].

On the machine, select "Settings (administrator)" → [System Settings] → [Document Filing Settings] → [Document Filing Control] → [Custom Folder].



• **To store a user name and specify a folder as "My Folder":**

In "Settings (administrator)", select [User Control] → [User Settings] → [User List].





Approximate number of pages and files that can be stored

Combined total number of pages and total number of files that can be stored in custom folders and in the Main folder

Examples of original types	Number of pages*	Number of files
Full color original (Text and photo example) Size: A4 	Max. 5700	Max. 3000
Black & white original (Text) Size: A4 	Max. 13000	

Number of pages and number of files that can be stored in the Quick File folder

Examples of original types	Number of pages*	Number of files
Full color original (Text and photo example) Size: A4 	Max. 700	Max. 1000
Black & white original (Text) Size: A4 	Max. 2000	

* The indicated numbers are guidelines for the number of pages that can be stored when all pages are full color, and when all pages are black & white.

Copying in sort mode uses the same memory area as the main folder and custom folder. For this reason, when too much data has been stored in the main folder and custom folder, it may not be possible to perform a large copy job using sort mode. Delete unnecessary files from the main folder and custom folder.

The original types above are examples to make the explanation easier to understand. The actual number of pages and number of files that can be stored will vary depending on the contents of the original images and the settings when the files are stored.



Information added to files

When saving a file using "File", add the following information to distinguish it from other files.

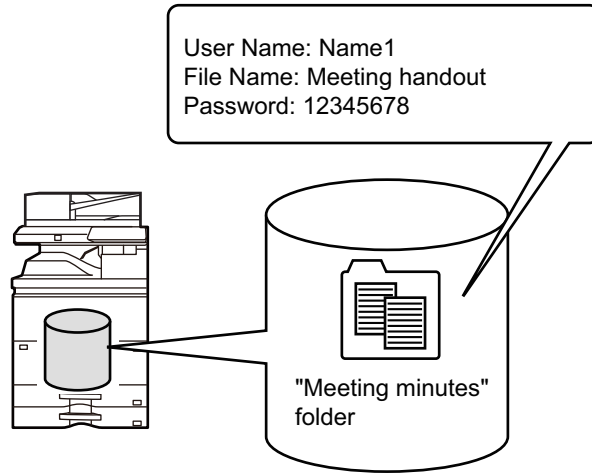

User Name	The user name is required to enter a file ownership and other information. The user name must be registered in advance.	
File Name	Names a file.	
Stored to	Specifies a folder to store files.	
Property	Sharing	Any user can display and operate files having the "Sharing" property.
	Protect	Once "Protect" is set, its file cannot be edited, moved, and deleted. No password setting is required.
	Confidential	You can set a password (4 to 32 characters) for file protection.



- The above information cannot be specified when a file is saved with Quick File.
- When you select [Create Downloadable File] in Scan to Local Drive and save as a confidential file, the properties cannot be changed.



To store a user name:

In "Settings (administrator)", select [User Control] → [User Settings] → [User List].

IMPORTANT POINTS WHEN USING DOCUMENT FILING

- Files stored using [Quick File] are provided with the "Sharing" property that can be accessed by any person for output and sending. Therefore, do not store sensitive documents or documents that you do not want to be used by others using the [Quick File] function.
- When saving a file with [File], you can save it with the "Confidential" property. Set a password for a "Confidential" file to prevent the file from being used by other people. Exercise care to prevent other people from obtaining the password.
- The property of a stored "Confidential" file can be changed to "Sharing" by "Property Change" as required. Do not store sensitive documents or documents that you do not want to be used by others.
- Except in cases provided for by law, SHARP Corporation bears no responsibility for any damages that result from the disclosure of sensitive information due to manipulation by a third party of any data saved using the Quick File function or File function, or incorrect operation of the Quick File function or File function by the operator who saves the data.



USING DOCUMENT FILING IN EACH MODE

To use Document Filing, select the action panel for each mode.

To save data simultaneously with a copy or fax, tap [File] or [Quick File] on the action panel in each mode.



To use Document Filing from the beginning, select the action panel in the Document Filing mode. Tap any one of the keys to scan and save the original.

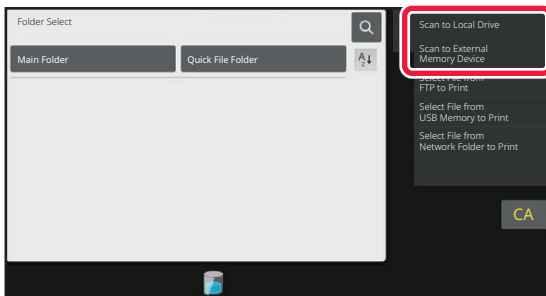

• **[File] and [Quick File]**

These keys may not appear on the action panel depending on the mode or settings. In this case, tap [Others] on the base screen in each mode, and then tap [Quick File] or [File].

• **Using document filing in print mode**

To use document filing in print mode, select document filing in the printer driver. For details on document filing, see "[SAVING AND USING PRINT FILES \(DOCUMENT FILING\) \(page 4-81\)](#)" in "PRINTER".

• **Using document filing in PC-Fax/PC-I-Fax mode**

To use document filing in PC-Fax or PC-I-Fax mode, select document filing settings in the PC-Fax driver. For more information, see Help in the PC-Fax driver.



BASE SCREEN OF DOCUMENT FILING MODE

SCREEN

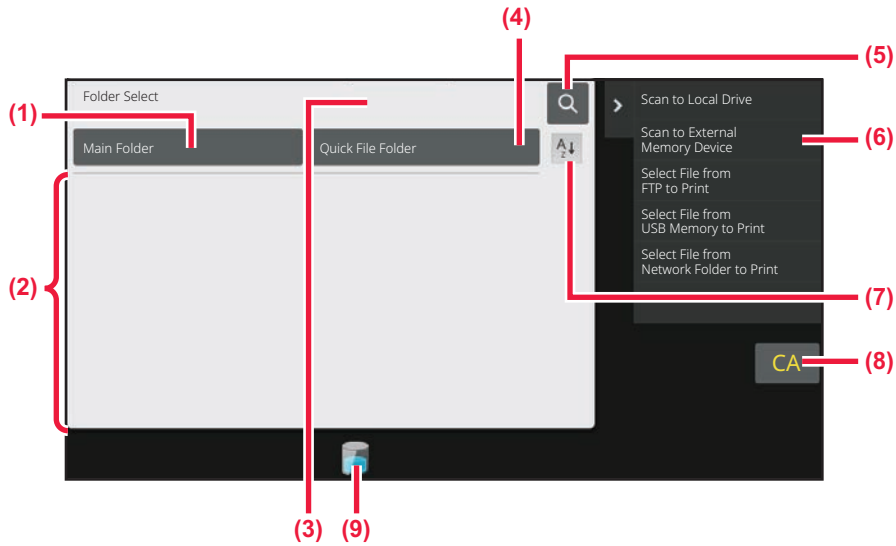

- (1) Use to save originals to be shared among users.
- (2) The folder for the registered user.
- (3) Displayed during user authentication. Tap this key to open the logged-in user's personal screen.
- (4) Displays the usage status of the machine's built-in storage. Tap the key to display details.
- (5) Use to save a file temporarily.
- (6) Use to search for a file in a folder.
- (7) Displays the functions available in document filing mode.
- (8) Switch the custom folder order between ascending and descending.



SAVING FILES WITH DOCUMENT FILING

FILING WHILE USING ANOTHER MODE

QUICK FILE

This function allows you to store an original in copy mode or image send mode as an image file in the Quick File folder of the machine.

The image file stored in quick file mode can be retrieved at a later time, allowing you to copy the document or transmit it in image send mode without having to locate the original.

As an example, the procedure for using "Quick File" in copy mode is explained below.



- Quick File can be used in normal mode.
- When a file is stored using Quick File, the following user name and file name are automatically assigned to the file.
User Name: User Unknown
File Name: Mode_Month-Day-Year_Hour-Minute-Second
(Example: Copy_10102021_112030AM)
Save location: Quick File Folder
When user authentication is used, the user name that was used for login is automatically selected.
Only the file name and location of a file stored in the Quick File folder can be changed.
- You can change the name of the sending file at scanner or resend transmission by system settings.



To delete all files in the Quick File folder with the exception of protected files:

In "Settings (administrator)", select [System Settings] → [Document Filing Settings] → [Condition Settings] → [Delete All Quick Files]. Configure settings to have all files deleted when the power is turned on as required.

1

Place the original.

Place the original in the document feeder tray of the automatic document feeder, or on the document glass.

[SELECTING A PROCEDURE FOR PLACING THE ORIGINAL DEPENDING ON THE TYPE AND STATUS OF THE ORIGINAL \(page 1-32\)](#)

2



Change to normal mode and tap [Quick File] on the action panel so that it is selected .



When a message relating to saving confidential information appears, tap the [OK] key.



3

Start a copy or image sending.

When the function is executed, the image data of the original is stored in the Quick File folder.



- To prevent accidental saving of the file, the message "The scanned data is stored in the quick file folder." appears for 6 seconds (default setting) after the [Start] key is tapped.
- To change the message display time, in "Settings (administrator)" → [System Settings] → [Common Settings] → [Operation Settings] → [Condition Settings] → [Message Time Setting].



To cancel Quick File:

Tap [Quick File] to enable .

FILE

Tapping the [File] key of the document filing function when printing or transmitting an original in each mode allows you to store the original in the Main folder or stored Custom folder as a file simultaneously with printing or transmission. The stored file can be retrieved at a later time, allowing you to recopy or resend the original without having to locate it. As an example, the procedure for using "File" in copy mode is explained below.



- File can be used in normal mode.
- When a file is stored using File without appending file information, the following user name and file name are automatically assigned to the file.
User Name: User Unknown
File Name: Mode_Month-Day-Year_Hour-Minute-Second
(Example: Copy_10102021_112030AM)
Save location: Main Folder
- You can change the name of the sending file at scanner or resend transmission by system settings.

1

Place the original.

Place the original in the document feeder tray of the automatic document feeder, or on the document glass.

[SELECTING A PROCEDURE FOR PLACING THE ORIGINAL DEPENDING ON THE TYPE AND STATUS OF THE ORIGINAL \(page 1-32\)](#)



There are also cases where settings are required to be made before a preview is carried out.



2

Change to normal mode and tap [File] on the action panel to specify the file information.

To select the user name, file name, folder, and property setting, see "[File Information \(page 7-12\)](#)".

To save on the local drive:

[Changing the property \(page 7-12\)](#)

[Specifying a user name \(page 7-12\)](#)

[Assigning a file name \(page 7-13\)](#)

[Specifying the folder \(page 7-13\)](#)

[Creating PDF for PC browsing \(page 7-14\)](#)

To save in an external memory device:

[Assigning a file name \(page 7-13\)](#)

[Specifying the folder \(page 7-13\)](#)

[Creating PDF for PC browsing \(page 7-14\)](#)

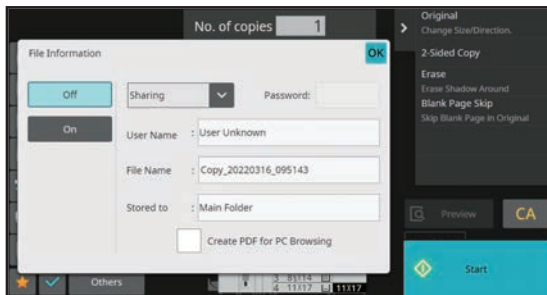

After configuring the above settings, you will return to this screen. Go to the next step.

If you do not wish to assign a user name or other information to the file, go to the next step.

3

Tap **OK**.

You will return to the base screen of copy mode.

4

Select copy settings and then tap the [Start] key.

- Simultaneously with starting copy, the original is stored as a file.
The selected copy settings are also saved.
- For the procedure for placing the original, see "[SELECTING A PROCEDURE FOR PLACING THE ORIGINAL DEPENDING ON THE TYPE AND STATUS OF THE ORIGINAL \(page 1-32\)](#)".



File Information

The procedure for detail settings is described below.

Specifying a property, user name, file name, and folder makes it easier to manage and search for a file. In addition, when [Confidential] is selected for Property and a password is established, other people will not be able to view the file without permission.

Changing the property

A protect setting can be selected for files saved with the document filing function. This prevents a file from being moved, or automatically or manually deleted.

Three properties are available for saved files: "Sharing", "Protect", and "Confidential". When saved with the "Sharing" property, a file is not protected. When saved with the "Protect" or "Confidential" property, a file is protected.

Files saved to the Quick File folder are all saved as "Sharing" files. When a file is saved to the Main folder or a custom folder, "Sharing", "Protect" or "Confidential" can be selected.

Sharing	A "Sharing" file can be changed to "Protect" or "Confidential" using "Property Change" in the Job Settings.
Protect	"Protect" does not require setting of a password, but prevents a file from being moved, deleted or edited. A password cannot be established.
Confidential	To protect a "Confidential" file, a password is set. (The password must be entered to retrieve the file.) When a file is saved in encrypted PDF format, the file property is automatically set to "Confidential".



Restrictions on changing the property

- A file that is set to "Sharing" can be changed to "Protect" or "Confidential" as required. However, a "Sharing" file that is saved in the Quick File folder can only be changed to "Protect".
- A file that is set to "Protect" can be changed to "Sharing" or "Confidential" as required. However, a "Protect" file that is saved in the Quick File folder can only be changed to "Sharing".
- A file that is saved in the Quick File folder cannot be changed to "Confidential". If the file is moved to the Main folder or a custom folder, the property can be changed to "Confidential".
- Two properties cannot be selected for a single file.

1

Select [Property] in the File Information screen.

2

When you have selected [Confidential], enter a password (4 to 32 characters).

Every time you enter one digit, "*" is displayed.

Specifying a user name

1

Tap the [User Name] text box.

When user authentication is used, the user name that was used for login is automatically selected. In this case, this step is not necessary.



- The user name must first be stored by selecting [User Control] in "Settings (administrator)" → [User Settings] → [User List].



2

Tap the key of the user name.

Alternatively, you can select a user name by tapping the [Call with Registration Number] key and entering the user number.

The user number must be first set by selecting [User Control] in "Settings (administrator)" → [User Settings] → [User List].

3

Tap **OK**.

The system goes back to the screen of step 1 to display the selected user name.

Assigning a file name

A file name can be assigned to the file.

1

Tap the [File Name] text box and enter the file name.

Enter a file name using up to 30 characters.



File Name

- If a file name that already exists is specified, a tilde and a serial number are added after the file name and this file is saved as a different file. The file name is not case-sensitive.
For example, if the "test.txt" file already exists and you specify the "TEST.TXT" file, the file will be saved as "TEST.TXT~1" file.
- If the length of the file name exceeds the limit, excess characters will be omitted and a serial number will be added to the end of the file name.

Specifying the folder

Specify the folder for storing the file.

1

Tap the [Stored to] text box.

If a user name with a "My Folder" setting is selected, "My Folder" of that user will automatically be selected.

2

Tap the key of the folder where you want to store the file, and tap **OK**.

If a password has been set for the folder, a password entry screen appears. Enter the password (5 to 8 digit number) using the numeric keys and tap the **OK**.



Creating PDF for PC browsing

Tap the [Create PDF for PC Browsing] checkbox to , and a public PDF for PC browsing will be created when the file is saved.



Data saved before using [Disabling of OCR] in the system settings can be downloaded with the OCR function even after [Disabling of OCR] is enabled.

Even if using the scanner function "[AUTOMATICALLY ADJUST SKEWED SCAN DATA \(Original Skew Adjustment\) \(page 6-142\)](#)", correction results will not be reflected.

Default Setting of PDF Format for PC Browsing

You can set the initial file format of public PDF or the file for download which is created during execution of each job. In "Settings (administrator)", select [System Settings] → [Document Filing Settings] → [Common Settings] → [Default Setting of PDF Format for PC Browsing].

B/W: Compression Mode

None, MH (G3), MMR (G4)

Color/Grayscale: Compression Ratio

Low, Middle, High



SAVING DOCUMENT DATA ONLY (SCAN TO LOCAL DRIVE)

SAVE ON LOCAL DRIVE

Storing from Easy Scan

1

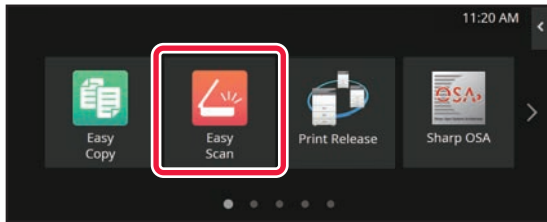

Tap the [Easy Scan] key on the Home screen.

2

Tap [Scan to USB/Local Drive] key.

3

Place the original.

Place the original in the document feeder tray of the automatic document feeder, or on the document glass.

[AUTOMATIC DOCUMENT FEEDER \(page 1-34\)](#)

[DOCUMENT GLASS \(page 1-38\)](#)

4

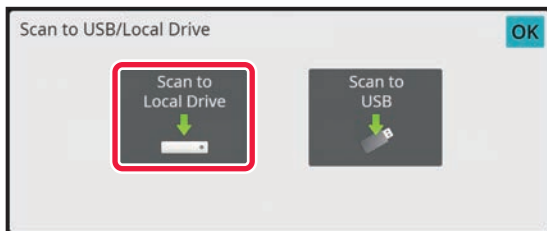

Tap [Scan to Local Drive] key.

5

To select settings, tap the key of each desired setting.

[IMAGE SEND SEQUENCE \(page 6-10\)](#)

6

Tap the [Color Start] or [B/W Start] key to start scanning.

A beep will sound to indicate that scanning and file store have ended.



Storing from Document Filing

1

Tap the [File retrieve] key on the Home screen.

2

Tap [Scan to Local Drive] on the action panel.

3

Place the original.

Place the original in the document feeder tray of the automatic document feeder, or on the document glass.

[AUTOMATIC DOCUMENT FEEDER \(page 1-34\)](#)

[DOCUMENT GLASS \(page 1-38\)](#)

4

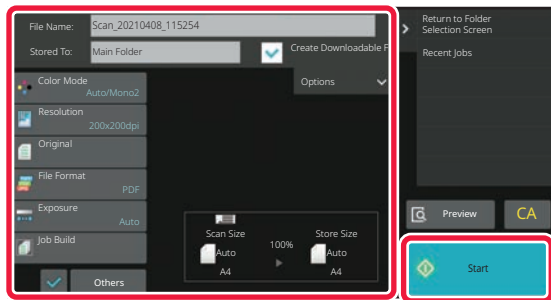

Check the file name and save location, and tap keys for any settings you want to select.



- When the [Create Downloadable File] checkbox is () , the [File Format] key is grayed out and cannot be used. You will not be able to download scan data in the specified format from the Web page.
- For original scan settings, see the explanation of the copy or image send mode.
- If the original is 2-sided, be sure to tap the [Original] key and then tap the [2-Sided Tablet] key or the [2-Sided Book] key as appropriate for the original.
- To set a user name, file attribute, or password, tap [Options].
- When a file is created with [Create Downloadable File] disabled, this setting cannot be enabled later.

5

Tap the [Start] key to start scanning.

A beep will sound to indicate that scanning and file store have ended.



SAVE IN EXTERNAL MEMORY DEVICE

Storing from Easy Scan

1

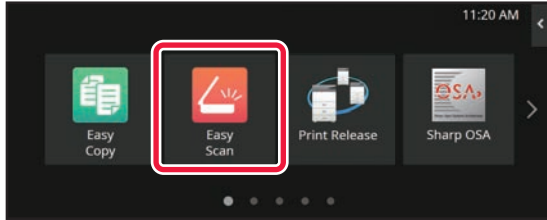

Tap the [Easy Scan] key on the Home screen.

2

Tap [Scan to USB/Local Drive] key.

3

Place the original.

Place the original in the document feeder tray of the automatic document feeder, or on the document glass.

[AUTOMATIC DOCUMENT FEEDER \(page 1-34\)](#)

[DOCUMENT GLASS \(page 1-38\)](#)

4

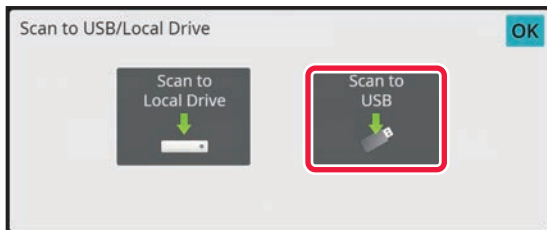

Tap [Scan to USB] key.



Tap the [Auto Set] key to automatically set the read settings to match the original. "Auto Set" cannot be used if [Disabling of OCR] is set in the system settings.

[SETTING SCAN SETTINGS AUTOMATICALLY \(Auto Set\) \(page 6-92\)](#)

5

To select settings, tap the key of each desired setting.

[IMAGE SEND SEQUENCE \(page 6-10\)](#)

6

Tap the [Color Start] or [B/W Start] key to start scanning.

A beep will sound to indicate that scanning and file store have ended.



Storing from Document Filing

1

Tap the [File retrieve] key on the Home screen.

2

Tap [Scan to External Memory Device] on the action panel.

3

Place the original.

Place the original in the document feeder tray of the automatic document feeder, or on the document glass.

[AUTOMATIC DOCUMENT FEEDER \(page 1-34\)](#)

[DOCUMENT GLASS \(page 1-38\)](#)

4



Check the file name and save location, and tap keys for any settings you want to select.



- For original scan settings, see the explanation of the copy or image send mode.
- If the original is 2-sided, be sure to tap the [Original] key and then tap the [2-Sided Tablet] key or the [2-Sided Book] key as appropriate for the original.

5

Tap the [Start] key to start scanning.

A beep will sound to indicate that scanning and file store have ended.



Scan to USB memory device

1

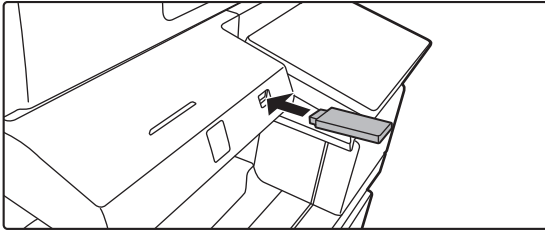

Connect the USB memory device to the machine.

- Use FAT32, NTFS or exFAT format for USB memory device.
- When the format of the USB memory device is FAT32, use a 32 GB or less USB memory device.

2

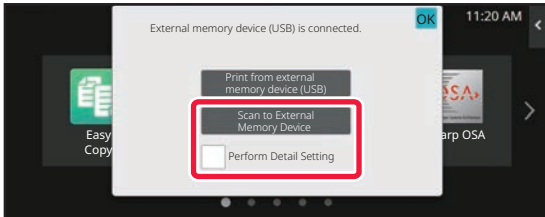

When a screen for selecting the action appears, tap [Scan to External Memory Device].

To select detailed settings in normal mode, select the [Perform Detail Setting] checkbox .

[NETWORK SCANNER MODE \(page 6-7\)](#)



- If the machine/device save screen is open, this screen will not appear.

3

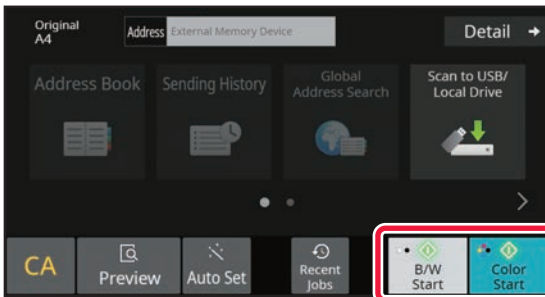

Tap the [Color Start] key or [B/W Start] key.

To check a preview of a document, tap the [Preview] key.

[PREVIEW SCREEN \(page 2-11\)](#)

4

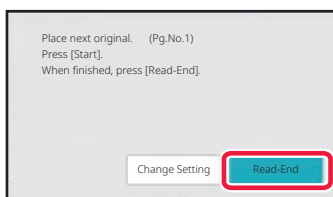

After scanning all originals, tap the [Read-End] key.



- When you scan the original using the automatic document feeder, this screen does not appear.

5

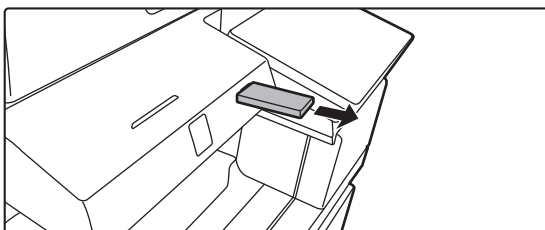

Check the [Sending data has been completed.] message, and remove the USB memory device from the machine.



USING STORED FILES

SEQUENCE FOR USING A STORED FILE

The screens and procedures differ depending on whether or not user authentication is enabled.

The sequence for using a stored file depending on the situation is explained.

For information on user authentication procedures, see "[USER AUTHENTICATION \(page 9-12\)](#)". For information on enabling user authentication and storing user names, see "[USER CONTROL \(page 9-20\)](#)".



Also in setting mode (Web version), you can use document filing. In setting mode (Web version), click [Document Operations] → [Document Filing], and then click the folder that contains the file you wish to use.

You can also check a preview of a stored file in setting mode (Web version).

1

Switch to document filing mode.

► [CHANGING MODES \(page 2-10\)](#)

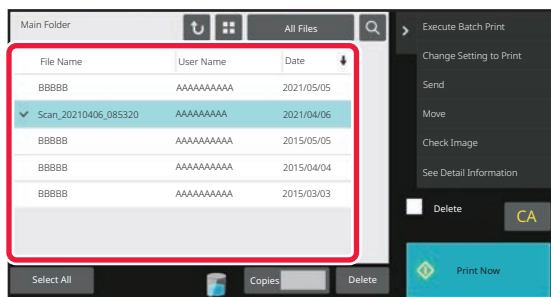
2

Select the file that you wish to retrieve.

When the folder is selected, the files in the folder will appear.

Select the file that you wish to retrieve.

Select a file from the thumbnail images of the stored files.

► [FILE SELECTION SCREEN \(page 7-21\)](#)

► [SELECTING A FILE TO RETRIEVE \(page 7-23\)](#)

Retrieve a file using the search function.

► [FILE SEARCH AND RETRIEVAL \(page 7-34\)](#)

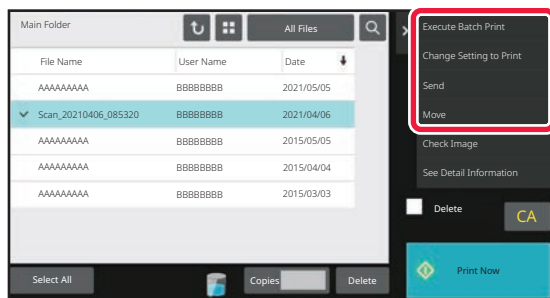
3

Select an operation item.

Select the desired operation and configure settings.

► [FILE SELECTION SCREEN \(page 7-21\)](#)

► [FILE PRINTING \(page 7-24\)](#)

► [FILE TRANSMISSION \(page 7-27\)](#)

► [FILE MOVING \(page 7-28\)](#)

► [DELETE FILE \(page 7-29\)](#)

► [FILE IMAGE CHECKING \(page 7-31\)](#)

► [FILE MERGING \(page 7-32\)](#)



When retention is selected on the printer, reset items that cannot be set for retention do not appear.



FILE SELECTION SCREEN

The file selection screen can be displayed in "List" format or "Thumbnail" format to display thumbnail images of files.

LIST DISPLAY MODE

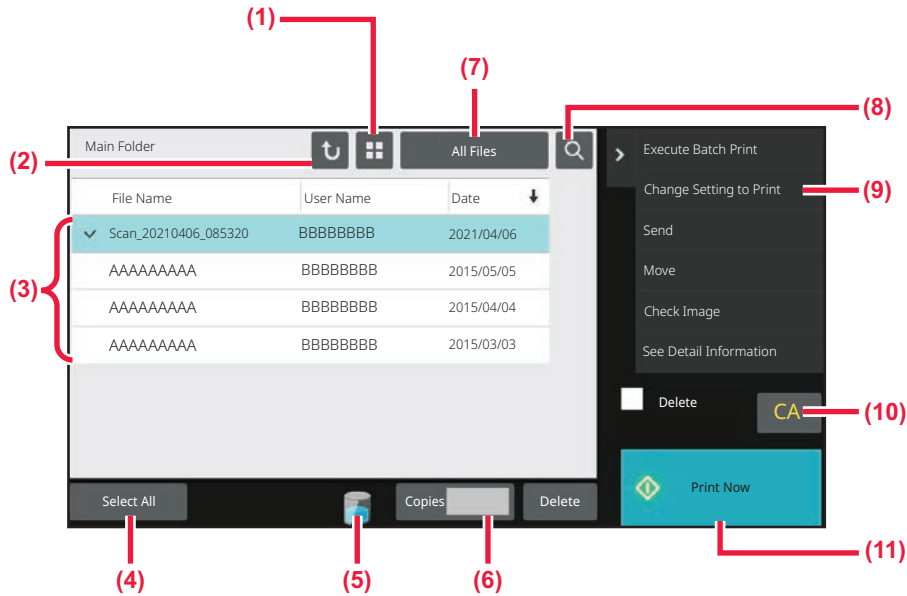

- (1) Switch the file display mode between list and thumbnail.
- (2) Return to the base screen of document filing mode.
- (3) Displays the saved files.
- (4) Select or clear all files. Tapping this key switches the key display mode between [Select All] and [Cancel All].
- (5) Tap this key to display the usage status of the machine's built-in storage.
- (6) The number of copies set in [Copies] is valid when tapping [Print Now].
- (7) Switch the file key displayed for each job type.
- (8) Search for a file saved in a folder.
- (9) Displays the functions that can be used.
- (10) Reset all settings.
- (11) Start printing immediately.



THUMBNAIL DISPLAY MODE

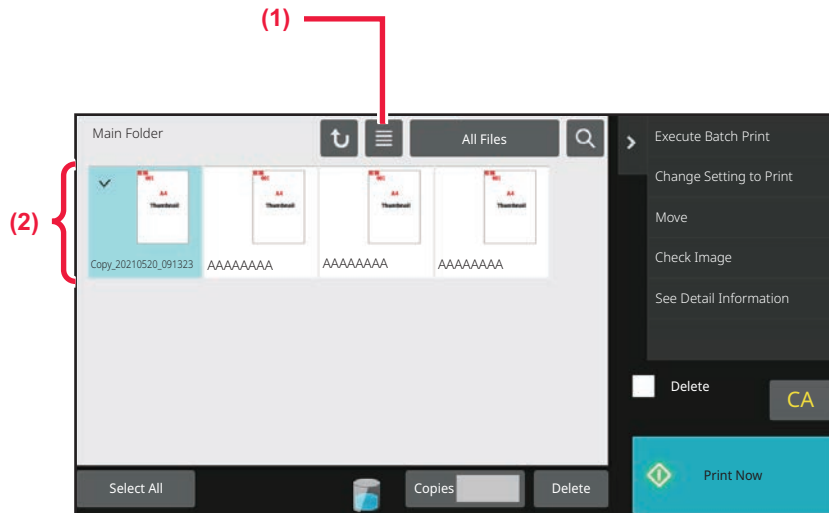

(1) Switch the file display mode between list and thumbnail.

(2) Displays thumbnails of the saved files.

Sorting order

In "Settings (administrator)", select [System Settings] → [Document Filing Settings] → [Condition Settings] → [Sort Method Setting].

Selects an order of display files stored in the Main Folder, Custom Folder, and Quick File Folder. Select one of the following settings:

- File Name
- User Name
- Date



SELECTING A FILE TO RETRIEVE

1

Tap the [File retrieve] key.

When user authentication is enabled and "My Folder" is configured by selecting [User Control] in "Settings (administrator)" → [User List], the custom folder specified as "My Folder" opens.

2

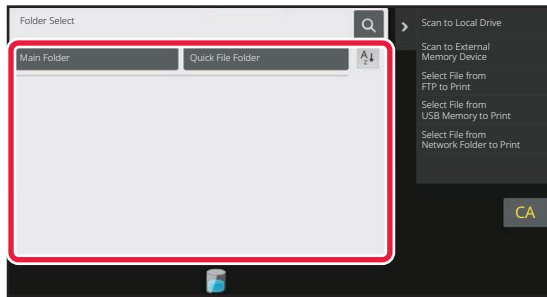

Tap the key of the folder that contains the desired file.

If the folder with a PIN Code is tapped, a PIN Code entry screen will appear.

Enter the PIN Code (4 to 8 digit number) using the numeric keys and tap the **OK**.

3

Tap the key of the desired file.

If the folder with a PIN Code is tapped, a PIN Code entry screen will appear. Enter the PIN Code (4 to 32 characters) and tap the **OK**.



- Tap the [Print Now] key to print out the file with the settings used for its storage.
- Tap the [Filter by Job] key to display the keys of a particular mode such as copy or scanner mode, enabling quick data search.
- Tap the [File Name] key, the [User Name] key, or the [Date] key to change the order of display of the files.
- Select [User Control] in "Settings (administrator)" → [User Settings] → [User List] → [User Registration] → [Authority Group]. Then, in authority group setting for the users who are currently logged in, select [Job Settings] → [Document Filing] and enable [Display only the Files of Logged-in Users] to display only files stored by the users who are currently logged in.



FILE PRINTING

A file stored using document filing can be retrieved and printed when needed. The settings used when the file was stored are also stored, and thus the file can be printed again using those settings. The file can also be modified before printing by changing the print settings.



- Print settings that are changed by re-manipulation of the file cannot be saved.
- The printing speed may be somewhat slow depending on the resolution and exposure mode settings of the stored file.
- When retention is selected on the printer, reset items that cannot be set for retention do not appear.

QUICK PRINTING

Prints a file with the various settings used when it was saved. Select a file and tap the [Print Now] key.

To delete data after printing, set the [Delete] checkbox to .

To change the number of sheets to print, tap the [Copies] key and then use the numeric keys to set the number to print.

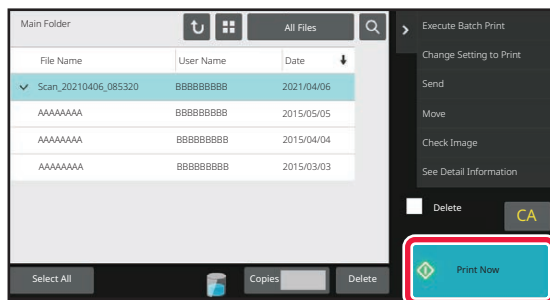

CHANGING SETTINGS BEFORE PRINTING

After selecting the desired file, follow the steps below.

- [SELECTING A FILE TO RETRIEVE \(page 7-23\)](#)

1

Tap [Choose Print Settings] on the action panel.

2

Change the print settings.

3

Select the [Delete] checkbox when needed.

4

Tap the [Start] key.

The file will be printed.



MULTI-FILE PRINTING

MULTI-FILE PRINTING

1

Select the keys of the multiple files that you wish to print.



- Confidential files cannot be printed simultaneously with other files.
- A file in the currently selected folder cannot be selected simultaneously with a file in a different folder.



- If the job type is changed with the By Job Display key or the screen is changed by  being tapped while a file is selected, the selection of the file will be canceled.

2

Tap [Print] on the action panel.

3

When not printing with the number of copies at data saving, tap the [Apply the Number from Stored Setting of Each Job.] checkbox to set to .

When printing with the number of copies at data saving without specifying copies, go to step 5.

4

Use   to specify the number of copies.

As required, directly tap the numeric value display key and change the value using the numeric keys.

5

To set the order of files to print, change with [Print Order].

6

To delete the file after printing, tap the [Delete] checkbox to set to .

7

Tap the [Start] key to start printing.



BATCH PRINTING

Batch Print Settings

In "Settings (administrator)", select [System Settings] → [Document Filing Settings] → [Condition Settings] → [Batch Print Settings].

Set whether or not the [All Users] key and the [User Unknown] key are prohibited in the user name selection screen when printing all files, whether files are sorted by date in newest or oldest order, and whether file names are sorted in ascending or descending order.

1

Tap the [Batch Print] key on the action panel.

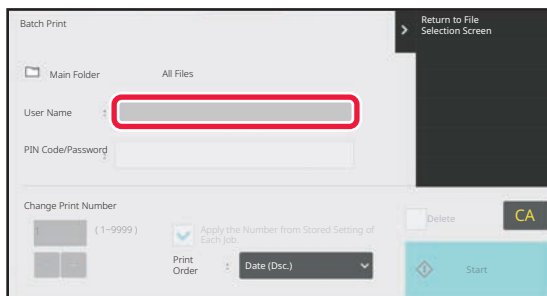
2

Tap the [User Name] text box.

3

Select the user name.

After selecting the user name, tap **OK**.



If you have selected [System Settings] in "Settings (administrator)" → [Document Filing Settings] → [Condition Settings] → [Batch Print Settings] and disabled the [Selection of [All Users] is not allowed.] checkbox and [Selection of [User Unknown] is not allowed.] checkbox, select the [All Users] key and [User Unknown] key. If you tap the [All Users] key, all files in the folder (the files of all users) are selected. If you tap the [User Unknown] key, all files in the folder with no user name specified are selected.

4

If a password has been established, tap the [Password] key.

Enter the password (4 to 32 characters) and tap **OK**. Only files that have the same password will be selected. If you do not wish to enter a password, go to the next step.

5

When not printing with the number of copies at data saving, tap the [Apply the Number from Stored Setting of Each Job.] checkbox to set to .

When printing with the number of copies at data saving, go to step 7.

6

Use **- +** to specify the number of copies.

As required, directly tap the numeric value display key and change the value using the numeric keys.

7

To automatically delete the file after printing, tap the [Delete] key.



8

Tap the [Start] key to start printing.

If there are no files that match the search conditions, you will return to the file list screen.



If [Delete the Data] on the action panel is tapped, all files that match the current search conditions will be deleted.

FILE TRANSMISSION

The settings used when the file was stored with document filing are stored, and thus the file can be transmitted using those settings. If needed, you can also change the transmission settings to modify the retrieved file.

After selecting the desired file, follow the steps below.

► [SELECTING A FILE TO RETRIEVE \(page 7-23\)](#)



- A file saved in black and white or grayscale cannot be transmitted in color.
- A stored print job cannot be transmitted. (However, if the job was filed in the printer driver, it can be transmitted if "Rip Style" is set to [RGB]. This settings is accessed by selecting the [Other Settings] button on the [Detailed Settings] tab.)



- These transmission methods require installation of the corresponding options.
- If any of the following other modes were included in the saved file, the file cannot be transmitted.
 - "Stamp", "Photo Repeat", "Multi-Page Enlargement" for copying.
- If any of the following other modes were included in the saved file, the file can be transmitted, but other functions cannot be executed.
"Margin Shift", "Transparency Inserts", "Book Copy", "Tab Copy", "Stamp", all "Color Adjust" menu items, "Centering"
- Depending on the reduction or enlargement ratio used when storing a file, it may not be possible to send the stored file using a selected resolution setting. In this event, try changing the resolution.
However, when sending a stored file by Internet fax, transmission may not be possible even if the resolution is changed.
- Files saved in other than Internet Fax mode cannot be sent to an Internet Fax address.
- When the original job is not a Print Jobs, Fax Receive Job, or Internet Fax Receive Job and the resend format is a PDF format, this function automatically corrects the skew and sends if the original is scanned while skewed. Since this functions is the same as the scanner function, see "[AUTOMATICALLY ADJUST SKEWED SCAN DATA \(Original Skew Adjustment\) \(page 6-142\)](#)".

1

Tap [Send] on the action panel.

2

Select settings for sending.

3

Tap the [Start] key.



FILE MOVING

Changes the file storage location. (The file is moved to another folder.)



A file whose property is "Protect" cannot be moved. To move a protected file, change its property to "Sharing" or "Confidential".

After selecting the desired file, follow the steps below.

[SELECTING A FILE TO RETRIEVE \(page 7-23\)](#)

1

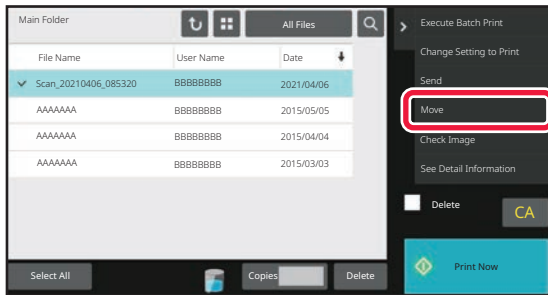

Tap [Move] on the action panel.

2

Tap the [Move to:] key.



- A file cannot be moved to the Quick File folder.
- To change the file name, tap the [File Name] key.

3

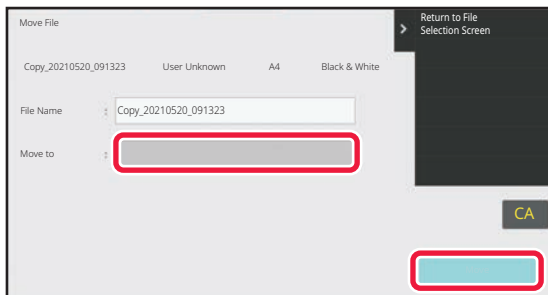

Tap the key of the folder to which you want to move the file.

If the folder with a password is tapped, a password entry screen will appear. Enter the password (5 to 8 digit number) using the numeric keys and tap the **OK**.



When multiple files are moved, file names cannot be changed.

4

Tap the [Move] key.



DELETE FILE

Stored files that are no longer required can be deleted.



A file whose property is "Protect" cannot be deleted. To delete a protected file, change its property to "Sharing" or "Confidential".

After selecting the desired file, follow the steps below.

► [SELECTING A FILE TO RETRIEVE \(page 7-23\)](#)

1

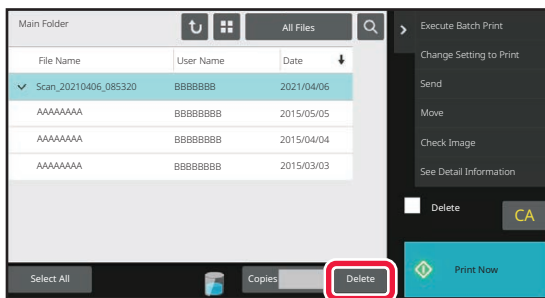

Tap the [Delete] key.

2

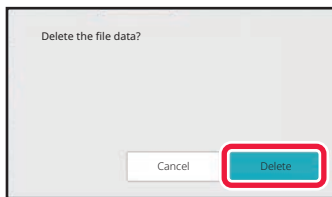

Check the file and then tap the [Delete] key.



Automatic Deletion of File

You can have document filing data in specified folders automatically deleted by specifying the folders and the time. Periodic deletion of files stored in the machine helps to prevent the disclosure of sensitive information and frees space on the local drive.

Automatic Deletion of File Settings

Document filing settings are described below. Tap the [Document Filing Settings] key to configure the settings. Time and folder settings can be configured to have files in specified folders (stored by document filing) automatically deleted at a specified time. Up to 3 settings can be stored to be automatically deleted.

The procedure for using this function is as follows:

- (1) Select [Setting 1], [Setting 2], or [Setting 3].
- (2) Set the time and date for automatic deletion.
- (3) Select the desired folder.
- (4) Specify whether or not protected files and confidential files are to be deleted.
- (5) Enable the stored settings.

Item	Settings
Schedule	<p>Select the cycle for automatic deletion. Select from [Delete by Schedule] or [Delete at Specified Time after Specified Days Have Elapsed].</p> <p>Delete by Schedule Select an automatic deletion cycle.</p> <ul style="list-style-type: none"> • Every Day: Auto deletion every day at the specified time. • Every Week: Auto deletion at the specified time on the specified day of the week. • Every Month: Auto deletion at the specified time on the specified day of the month. <p>Delete at Specified Time after Specified Days Have Elapsed Deletes the file automatically at the specified time after the specified number of days have passed from the day the file was saved.</p> <ul style="list-style-type: none"> • Days: Set the elapsed time and date. • Time of Deletion: Deletes the file automatically at the specified time.
Folders	To select the folder separately, select [Folder Select] and select the desired folder. To select all folders, including the folder currently being created, select [All Folders (Including folders registered hereafter)].
Delete Protected File	Enable this setting to include protected files in the deletion.
Delete Confidential File	Enable this setting to include confidential files in the deletion.

Delete Now

When this is executed with a folder selected, all files in the folder will be immediately deleted regardless of the date and time setting.

Executing automatic deletion during Auto Power Shut-Off

(If this is not selected, the files will be deleted after the machine wakes from auto power shutoff mode.)

Execute Auto Deletion even if Auto Power Shut-Off is enabled. When the checkbox is not selected () , the files will be deleted after the machine wakes from auto power shutoff mode.



FILE IMAGE CHECKING

FILE IMAGE

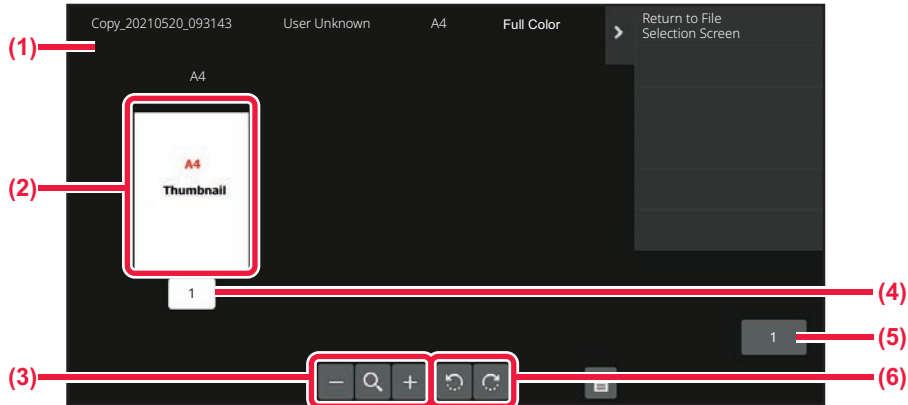

- (1) Displays file information.
- (2) Displays file preview images.
- (3) Enlarge or reduce the preview screen.
- (4) Displays the page number.
- (5) Displays the total page count.
- (6) Rotate the preview screen in increments of 90 degrees.



- Depending on the size of the image, part of the image may be clipped off in the image check screen on the touch panel.
- A preview image is an image for display on the touch panel. It will differ from the actual print result.
- The image check screen does not appear when multiple files are selected.

After selecting the desired file, follow the steps below.

► [SELECTING A FILE TO RETRIEVE \(page 7-23\)](#)

1

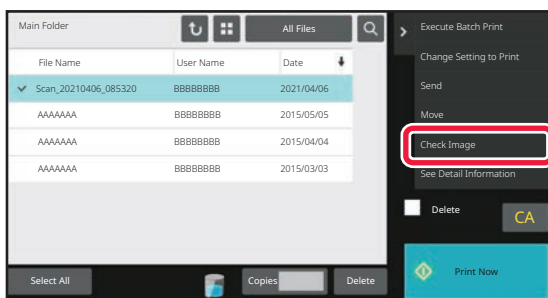

Tap [Check Image] on the action panel.

2

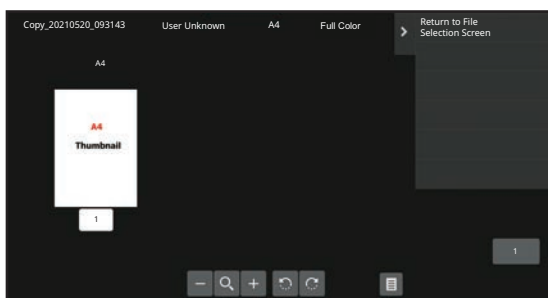

Check the image of the file.



FILE MERGING

You can combine files that have been saved by Document Filing.



- If you have only selected a single file, the [Combine File] key is not displayed.
- The file name is a combination of "the first file name", "a tilde (~)", and "Serial No.". As required, change the file name at a later time.
- The files are joined in the selected order.

After selecting two desired files, follow the steps below.

► [SELECTING A FILE TO RETRIEVE \(page 7-23\)](#)

1

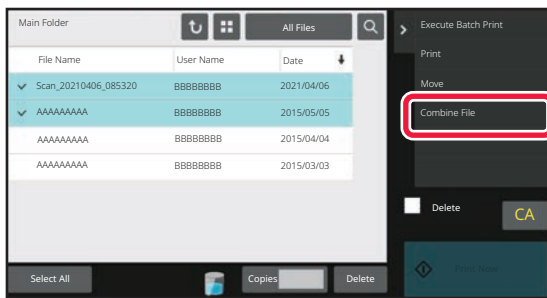

Tap [Combine File] on the action panel.

2

Append file information.

To select the user name, file name, folder, and property setting, see "[File Information \(page 7-12\)](#)".
To delete the original file, select the [Delete Original File] checkbox.

3

Tap the [Execute] key.

Combining of files starts, and after the processing is finished, the "Combining complete" message appears.



To cancel the operation

Tap the [CA] key. Note that the operation cannot be canceled when the original file is being deleted after the files are combined.



RETRIEVING AND USING A FILE FROM THE JOB STATUS SCREEN

Files stored using File and Quick File appear as keys in the job status complete screen.

This is convenient when you need to quickly print the saved data of a copy job or quickly send a saved fax to another destination.

1

Tap the job status display.

2

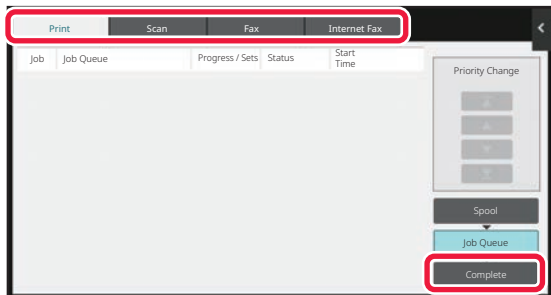

Tap the tab with a file to be retrieved, and tap the [Complete] key.

3

Tap the key of the desired file from the completed job.

A file that has been processed by Quick File or File can be selected for a job in the retrieve operation.

4

Tap [Send] or [Choose Print Settings] on the action panel.

- [FILE TRANSMISSION \(page 7-27\)](#)
- [FILE PRINTING \(page 7-24\)](#)



To view detailed information on a file, select the file, and then tap [Check Details of Selected Job] on the action panel.



FILE SEARCH AND RETRIEVAL

When there are many stored files, it may take some time to locate a file. The search function of document filing mode can be used to find a file quickly.

Searching is possible even when you only know part of the file name or folder name. As required, a folder can also be specified as a search range.

Example: Only part of a file name is known: "Conference"

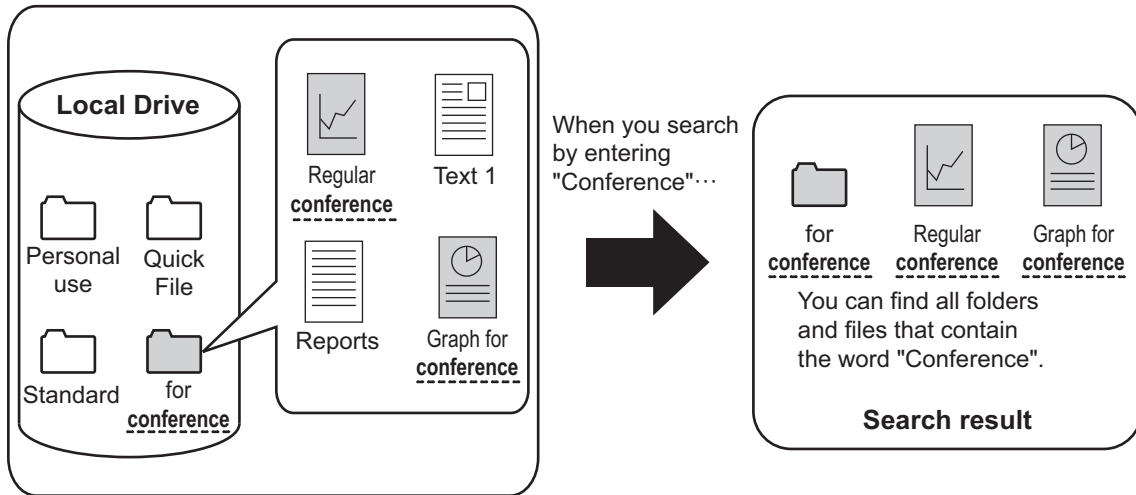

1

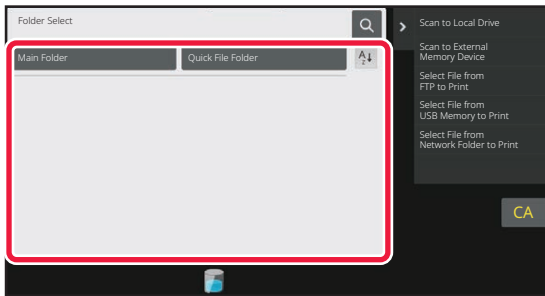

To search for a specific folder, tap its key.



If the folder with a password is tapped, a password entry screen will appear. Enter the password (4 to 8 digit number) using the numeric keys.

2

Tap .



3

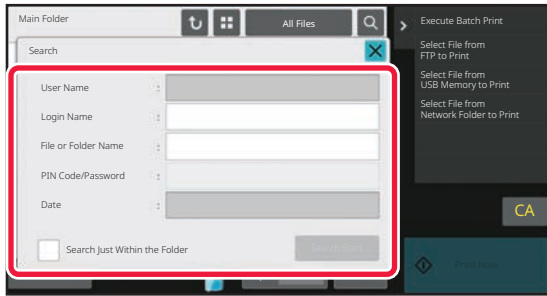

Select search conditions.

Tap each text box and set the search condition.

To search for the current folder, set the [Search Just Within the Folder] checkbox to .

[User Name]

Search using the user name.

Select a user on the user selection screen that appears, and then tap **OK**.

[Login Name]

Search using the login name.

Enter the login name on the soft keyboard that appears and tap the [OK] key.

[File or Folder Name]

Search using the file name or folder name.

Enter the file name or folder name on the soft keyboard that appears and tap the [OK] key.

[PIN Code/Password]

Search for files that have a password set. Enter the password with the soft keyboard that appears, and tap the [OK] key.

[Date]

Search using the date when the file was created.

When you have selected [Today] or [Date Set], set the time and date.

4

Tap the [Search Start] key.

A list of the files that match your search conditions will appear. Select the desired file from the list. The job settings screen will appear.

To return to the base screen of document filing mode, tap the [CA] key.

To return to the file search screen, tap the [Search Again] key.



- When you search using [File or Folder Name], custom folders that match the search characters will also appear in the list. When a folder key is tapped, a list of the files in the folder appears. Tap the desired file in the list.
- Also in setting mode (Web version), you can use the file search function. Click [Document Operations] in "Settings (Web version)" → [Document Filing] → [Search].



PRINTING AN EXTERNAL FILE

A file stored in the FTP server, USB memory device, or network folder of a PC can be printed. The file can also be modified before printing by changing the print settings.

On the action panel, tap [Select File from FTP to Print], [Select File from USB Memory to Print] or [Select File from Network Folder to Print].

For more information, see "[PRINTING WITHOUT THE PRINTER DRIVER \(page 4-86\)](#)".

OPERATION IN THE WEB PAGE

Document Operations

Document Filing operations can be performed from the Web page using "Settings (Web)" - [Document Operations] → [Document Filing].

Main Folder

The files that are in the Main Folder can be displayed. A specified file can be manipulated by clicking [Print], [Send], [Move], or [Delete]. If the file to be manipulated has a password, enter the password in "PIN Code/Password of File".

Item	Description
Display Style	Saved files can be displayed in list format or thumbnail format.
Job Classification	The saved files that are displayed can be filtered by job.
Display Items	Set the number of files that are displayed.

Quick File Folder

Files in the Quick File Folder can be displayed. A specified file can be manipulated by clicking [Print], [Send], [Move], or [Delete].

Item	Description
Display Style	Saved files can be displayed in list format or thumbnail format.
Job Classification	The saved files that are displayed can be filtered by job.
Display Items	Set the number of files that are displayed.

Custom Folder

The files that are in the Custom Folder can be displayed. A specified file can be manipulated by clicking [Print], [Send], [Move], or [Delete]. If the file to be manipulated has a password, enter the password in "PIN Code/Password of File".

Item	Description
Bold	The displayed Custom Folder names can be filtered by index.
Display Items	Set the number of files that are displayed.

Search

Use these settings to enter search conditions. A specified file can be manipulated by clicking [Print], [Send], [Move], or [Delete]. If the file to be manipulated has a password, enter the password in "PIN Code/Password of File".

Item	Description
User Name	Enter the user name. (Up to 32 characters)
Select from User List	Click the [Setup] button and search for users from the list.
Login Name	Set the number of files that are displayed.
Search Folder	Set the folder.



Item	Description
File Name	Enter a file name. (Up to 30 characters)
PIN Code/Password of File	Enter the password that is set for the file (4 to 32 digits).
Stored Date	Set the date and time the file was saved.

Search Result

Use these settings to enter search conditions. A specified file can be manipulated by clicking [Print], [Send], [Move], or [Delete]. If the file to be manipulated has a password, enter the password in “PIN Code/Password of File”.

Item	Description
Display Style	The files that were found can be displayed in list format or thumbnail format.
Job Classification	The found files can be filtered by job.
Display Items	Set the number of files that are displayed.

File Batch Print

Multiple files can be printed at once by batch printing. Search for the files using search conditions, and then select multiple files from the displayed search results.

If you want to use the number of copies set when each file was saved by Document Filing, select “Apply the Number of Copies Stored in Each File”. If you want to set a different number of copies, enter the desired number in “Enter the Number”. Click [Print] to print the file. To have the file deleted after printing, select the “Print and Delete the Data” checkbox.

Item	Description
Search Condition	
User Name	Enter the user name. (Up to 32 characters)
Select from User List	Click the [Setup] button and search for users from the list.
Search Folder	Set the folder.
File Name	Enter a file name. (Up to 30 characters)
PIN Code/Password of File	Enter the password that is set for the file. (4 to 32 digits)
Search Result	
Job Classification	The found files can be filtered by job.
Billing Code	
Main Code	Select this checkbox, and then enter the main code. (32 characters or less)
Sub Code	Select this checkbox, and then enter the sub code. (32 characters or less)



MANUAL FINISHING

MANUAL FINISHING

MANUAL FINISHING	8-2
SELECTING MANUAL FINISHING MODE	8-3
BASE SCREEN OF MANUAL FINISHING MODE	8-3

PAPERS

CHECKING TYPE AND SIZE OF PAPER	8-4
PAPER LOADING ORIENTATION	8-5
STAPLE	8-5
PUNCH	8-6
FOLD	8-6

OPERATION OF MANUAL FINISHING

USING MANUAL FINISHING	8-8
STAPLE FUNCTION	8-10
COPIES/PAGES FUNCTION	8-11
TRIMMER SETTING	8-12
PUNCH FUNCTION	8-13
PAPER FOLDING FUNCTION	8-14
MULTIPLE FOLD (WHEN SADDLE FOLD IS SELECTED)	8-16
TO CHANGE THE PAPER TRAY	8-17
TO CHANGE THE OUTPUT TRAY	8-17



MANUAL FINISHING

MANUAL FINISHING

In manual finishing mode, you can set for finish on copied or printed pages.

You can select the manual finishing mode if the inserter is installed. When the finisher (large stacker), saddle stitch finisher (large stacker), punch module, or folding unit is installed, finishing operations, such as stapling, punching or folding can be performed.

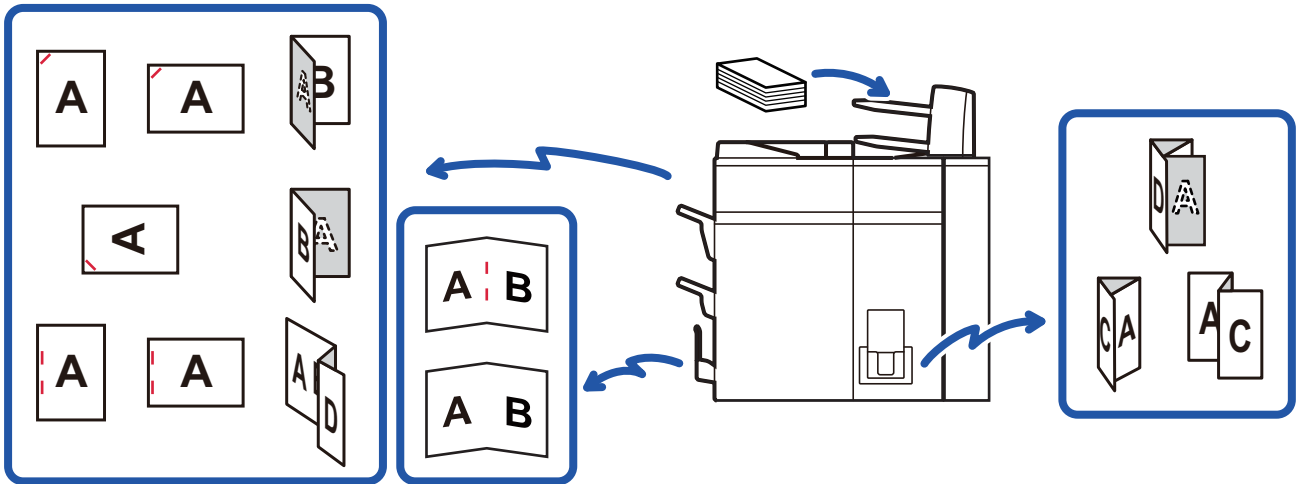

Manual finishing cannot be used if the use of manual finishing or inserter is prohibited in "Settings".



To specify whether or not to prohibit the use of manual finishing or inserter:

In "Settings (administrator)", select [System Settings] → [Common Settings] → [Operation Settings] → [Disable Manual Finishing] to set the use of manual finishing. Select [System Settings] → [Common Settings] → [Device Control] → [Disabling of Inserter] to set the use of the inserter.



SELECTING MANUAL FINISHING MODE

Change the manual finishing mode to simple mode or normal mode as explained in "[CHANGING MODES \(page 2-10\)](#)".

BASE SCREEN OF MANUAL FINISHING MODE

Shows the selected paper and output trays.

Selects an output tray for finished paper.

Shows the selected paper and output trays. Tap the [Type and Size] key to set the paper type and paper size.

Staples each set of output. Selects a staple position.

Staples the center of the booklet and folds the booklet along the center. Trims the excessive parts of booklet folded along the center.

Punches holes in paper.

Performs paper folding. Selects the type of folding.

Sets the number of copies for output and the number of sheets per set.

Resets all settings.

Starts finishing.



The display will vary depending on the devices installed.



PAPERS

CHECKING TYPE AND SIZE OF PAPER

You can check the type and size of paper loaded in the inserter on the display to the right of [Upper Tray] or [Lower Tray] key.

You can check the type and size of paper loaded in the inserter on the display to the right of [Upper Tray] or [Lower Tray] key.

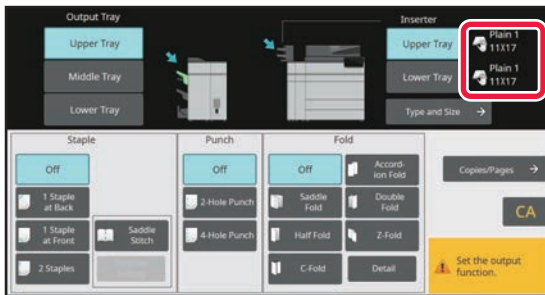

If the paper loaded is different from the type that is indicated on the right of the key, tap the [Type and Size] key or change the settings in "Settings".

Special media such as transparency film and tab paper cannot be used.



To change the paper settings for the paper you load in the inserter:

Tap the [Type and Size] key or in "Settings", select [System Settings] → [Common Settings] → [Paper Settings] → [Paper Tray Settings] → [Inserter(Upper)] or [Inserter(Lower)].











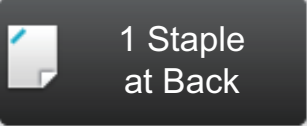
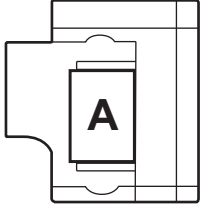

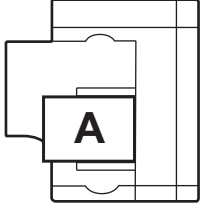
If the paper size is not correctly detected or paper of a non-standard size or type is loaded, specify this setting.

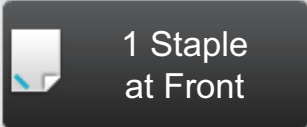
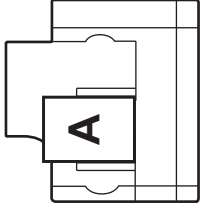

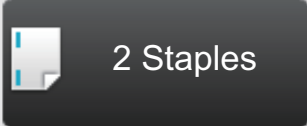
PAPER LOADING ORIENTATION

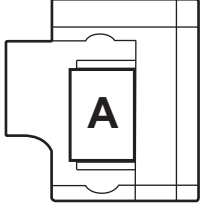
When using the staple, punch or the paper folding function, the original must be placed as shown below to enable stapling or punching in the desired position on the paper.

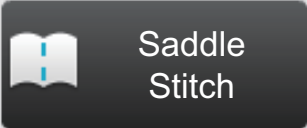



STAPLE

Touch panel key	Orientation	Result
		
		
		
		
		
		

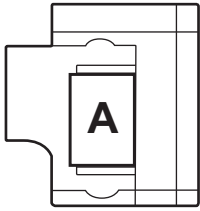

- To use the staple function, you need to mount a finisher (large stacker) or saddle stitch finisher (large stacker).
- To use the saddle stitch function, you need to mount a saddle stitch finisher (large stacker).

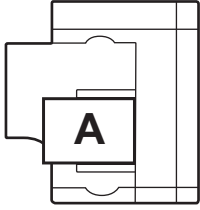



PUNCH

Touch panel key	Orientation	Result
		
		



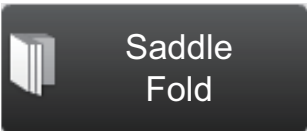
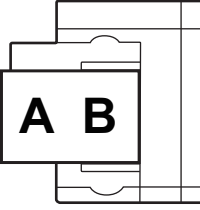

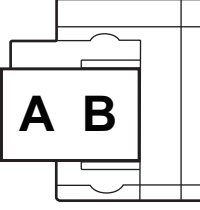

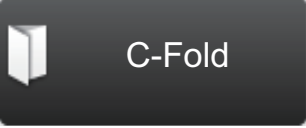
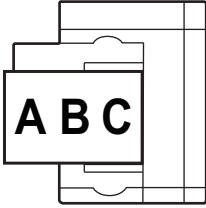

A punch module is required for paper punch.

FOLD

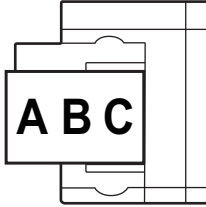
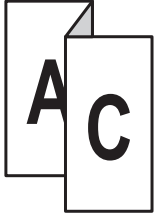
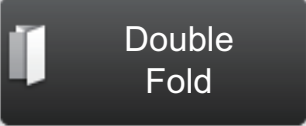
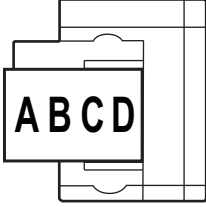
Touch panel key	Orientation	Result
		
		

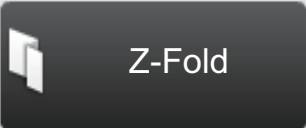
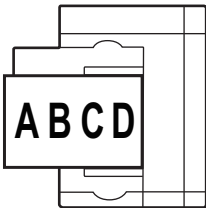

Touch panel key	Orientation	Result
 <p>C-Fold</p>		
 <p>Accord- ion Fold</p>		
 <p>Double Fold</p>		
 <p>Z-Fold</p>		



- A folding unit is required to be installed in order to use paper folding functions other than saddle folds.
- To use the saddle fold function, you need to mount a saddle stitch finisher (large stacker).



OPERATION OF MANUAL FINISHING

USING MANUAL FINISHING

Change from the Home Screen or each mode to manual finishing mode, and carry out the following procedure.

[SELECTING MANUAL FINISHING MODE \(page 8-3\)](#)

1

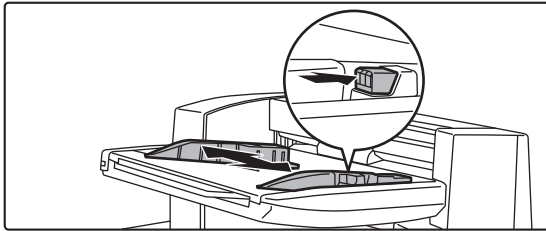

Set the guides to the size of the paper.

Grasp the guide lock lever to adjust the guide. When you have finished the adjustment, release the lock lever.



When loading paper larger than 8-1/2" × 11"R, or A4R, extend the bypass tray all the way out. If it is not pulled all the way out, the size of the loaded paper will not be detected correctly.

2

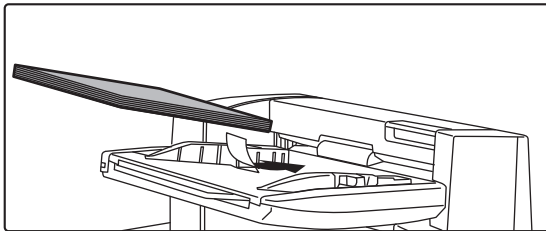

Load paper into the upper or lower tray.

The paper orientation varies depending on the manual finishing function.

[CHECKING TYPE AND SIZE OF PAPER \(page 8-4\)](#)

[PAPER LOADING ORIENTATION \(page 8-5\)](#)



- Up to 200 sheets of paper can be loaded into each of the upper and lower trays.
- Insert the paper along the guides all the way into the tray.
- If the guide width is not correctly adjusted to match the paper width, paper may be jammed, skewed, or crease. Adjust the paper guides to fit the width of the paper.

3

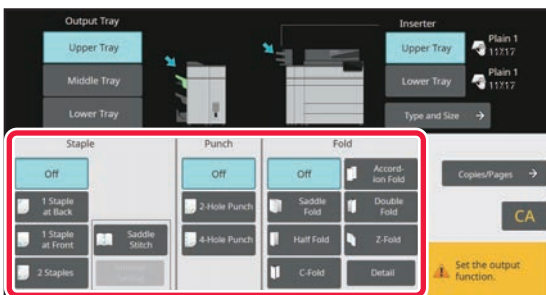

Select the appropriate finishing method.

[STAPLE FUNCTION \(page 8-10\)](#)

[PUNCH FUNCTION \(page 8-13\)](#)

[PAPER FOLDING FUNCTION \(page 8-14\)](#)



4

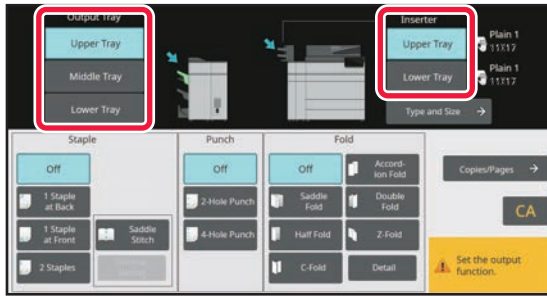

Change the paper tray or output tray as required.

[TO CHANGE THE PAPER TRAY \(page 8-17\)](#)

[TO CHANGE THE OUTPUT TRAY \(page 8-17\)](#)

5

Tap the [Start] key to begin manual finishing.



To stop manual finishing:
Tap the [Stop] key.



STAPLE FUNCTION

When a finisher (large stacker) is installed, you can staple loaded papers into a sheaf. (Staple function)

When a saddle stitch finisher (large stacker) is installed, you can staple papers in two places on the centerline and fold them before being output. (Saddle stitch function)

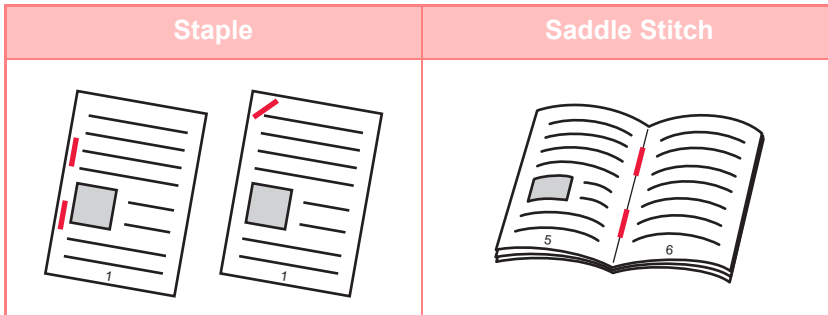

- You can use the saddle stitch function for size 8-1/2 " × 11"R to 12" × 18" (A4R to A3W) papers.
- The saddle stitch function cannot be used with other manual finishing functions.
- If you load only one sheet of paper while the staple function is ON, the staple function is temporarily turned OFF and the sheet is not stapled.

Selecting staple function

Tap your desired staple key in the [Staple].

The output tray is automatically selected based on the selected staple key.

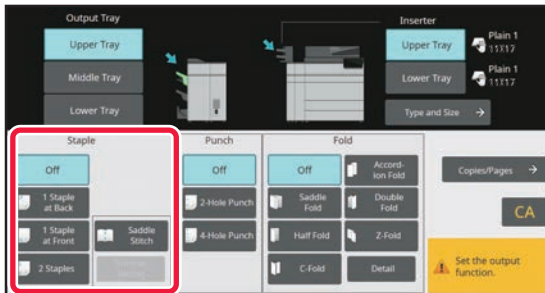

To cancel the staple function:
Tap the [Off] key.



COPIES/PAGES FUNCTION

If you wish to staple multiple sets at once, use the Copies/Pages.

Load sorted paper and tap the [Copies/Pages] key to enter the number of copies and the number of pages per set.

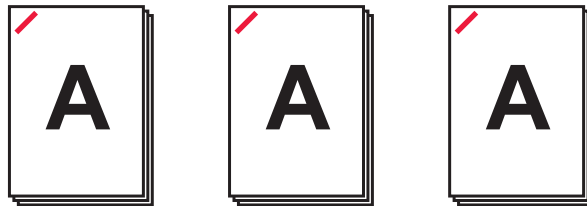
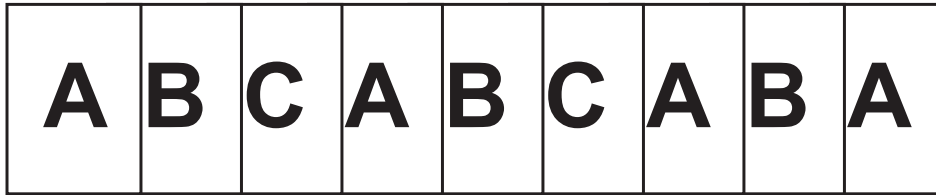

The settings on the Copies/Pages will not be effective for the paper folding and punch functions.

Setting the number of copies (number of pages)

1

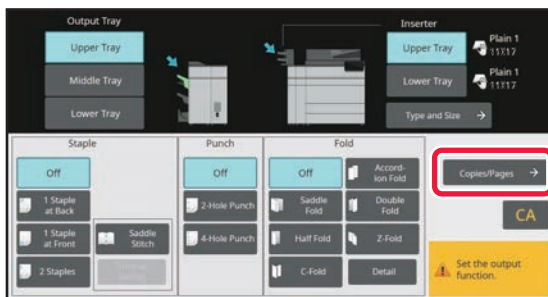

Tap the [Copies/Pages] key.

2

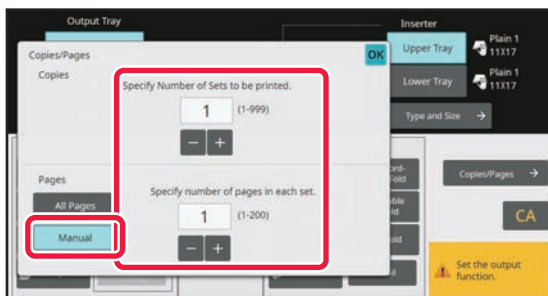

Tap the [Manual] key and specify the number of output copies and the number of pages per set.

Tap the Number of Copies display and the Number of Pages per Set display, and enter the values using the numeric keys. Otherwise, tap the **- +** key to enter the values. After the settings are completed, tap **OK**.



If you select [All Pages] for the number of copies/number of pages, specify "1" for the number of sets to be printed.



If you set more copies or pages than the number of copies or pages that can be stapled, a message is displayed and the [Start] key is disabled.

See "Specifications" in the "Start Guide" and specify the number of copies or pages that can be stapled.

TRIMMER SETTING

If a trimmer unit is installed, you can trim off excess edges of paper for a finer finish.

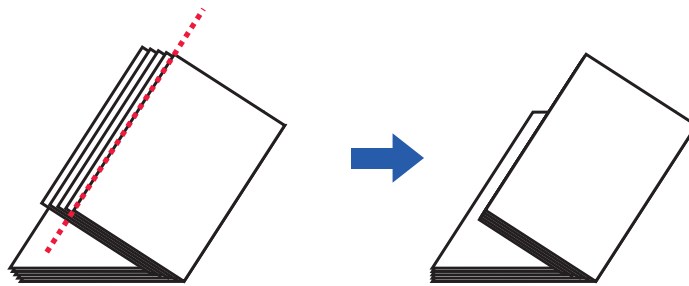

Trimmer Setting (when Saddle Stitch is selected)

To select the Trimmer Setting, a trimmer unit must be installed.

1

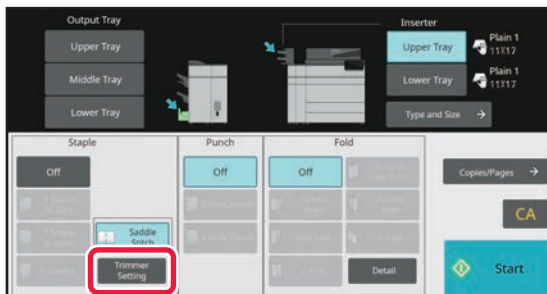

With Saddle Stitch selected, tap the [Trimmer Setting] key.

2

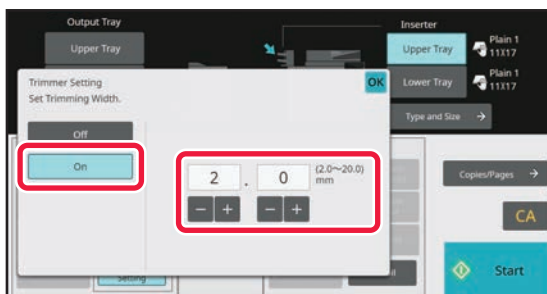

Tap the [On] key, and specify the trimming width.

Tap the numeric value display field of the trimming width, and enter the allowable range using the numeric keys.

Otherwise, tap the **- +** key to enter the values.

After the settings are completed, tap **OK**.



To cancel the trimmer setting:
Tap the [Off] key.



PUNCH FUNCTION

If a punch module is installed, holes can be punched in paper.

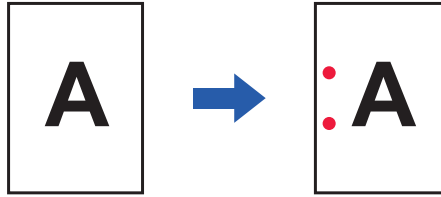

- Paper sizes that are available for the punch function are 8-1/2 " × 11"R to 11" × 17" (B5R to A3).
- You cannot use 12" × 18" (A3W) size papers, and special media such as transparency film.
- The punch function cannot be used with the saddle stitch or paper folding functions. However, it can be used with them if the paper size used is 11" × 17", A3 or B4 for Z-fold.

Tap the [2 Hole Punch] key under "Punch".

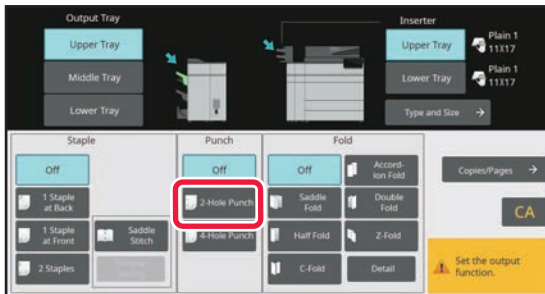

To cancel the punch function:
Tap the [Off] key.



PAPER FOLDING FUNCTION

When a paper folding unit is installed, you can fold papers in Z-fold and C-fold. When a saddle stitch finisher (large stacker) is installed, you can use saddle folds.

The paper sizes that can be selected vary depending on the type of paper fold.

Types of folds and paper sizes available

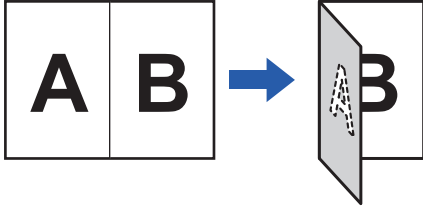
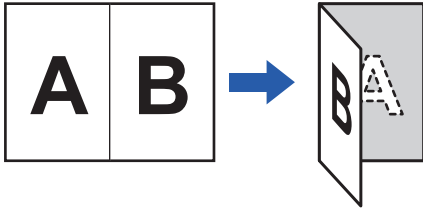
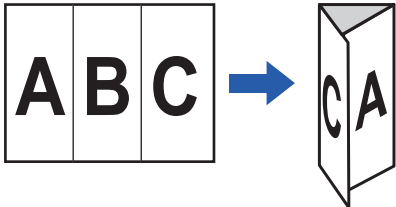
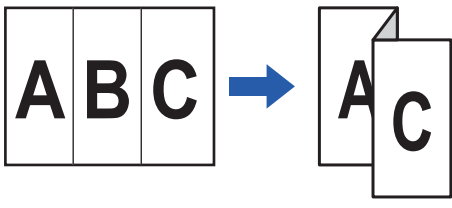
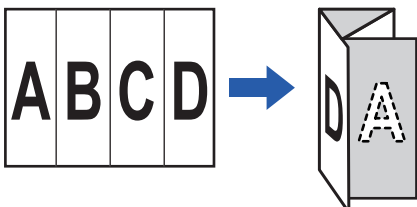
Types of Folds	Folding results	Paper Size
Saddle Fold		12" × 18", 11" × 17", 8-1/2" × 14", 8-1/2" × 13-1/2", 8-1/2" × 13-2/5", 8-1/2" × 13", 8-1/2" × 11"R, A3W, A3, B4, A4R, 8K
Half Fold		8-1/2" × 11"R, A4R
C-Fold		8-1/2" × 11"R, A4R
Accordion Fold		8-1/2" × 11"R, A4R
Double Fold		8-1/2" × 11"R, A4R

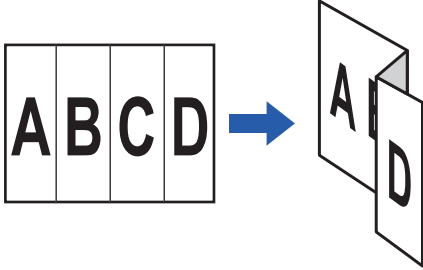

Types of Folds	Folding results	Paper Size
Z-Fold		11" × 17", 8-1/2" × 14", 8-1/2" × 11"R, A3, B4, A4R



- Special media such as transparency film and tab paper cannot be used.
- The paper folding function cannot be used with the staple and hole punch function. However, it can be used with them if the paper size for Z-fold is 11" × 17", A3 or B4.

Selecting the paper folding function

Tap your desired fold key in the "Fold".

The output tray is automatically selected based on the selected fold key.

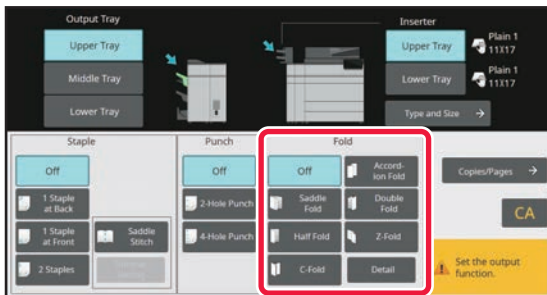

To cancel the paper folding function:
Tap the [Off] key.



MULTIPLE FOLD (WHEN SADDLE FOLD IS SELECTED)

If Saddle Fold is selected, multiple sheets can be folded together. Five sheets of paper are folded at a time.

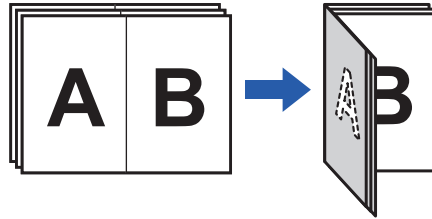

- When four or less papers are set, four or less papers are folded at a time.
- If five or more papers are set and if four or less papers remain, the remaining number of papers are folded at a time.
- Some types of paper reduces the number of sheets that are folded every set. For example, three sheets are folded at a time in the case of heavy paper.

Setting Multiple Fold (when Saddle Fold is selected)

1

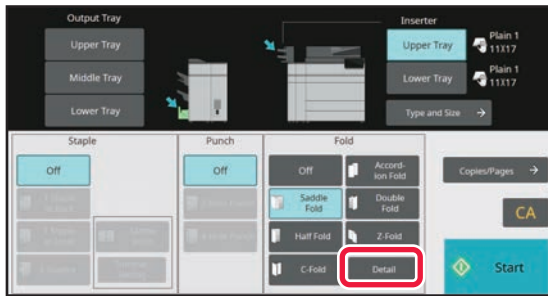

With Saddle Fold selected, tap the [Detail] key.

2

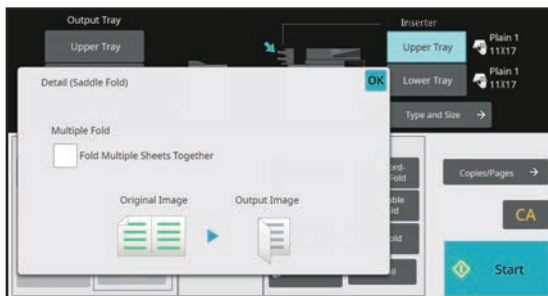

Set the [Fold Multiple Sheets Together] checkbox to .

After the settings are completed, tap **OK**.



To cancel the multiple fold function:
Set the [Fold Multiple Sheets Together] checkbox to .



TO CHANGE THE PAPER TRAY

The paper tray is automatically detected when paper is loaded in the inserter.

If you need to specify a paper tray when, for example, paper has been loaded into both the upper and lower trays on the inserter, tap the [Upper Tray] or [Lower Tray] key to specify the appropriate paper tray.

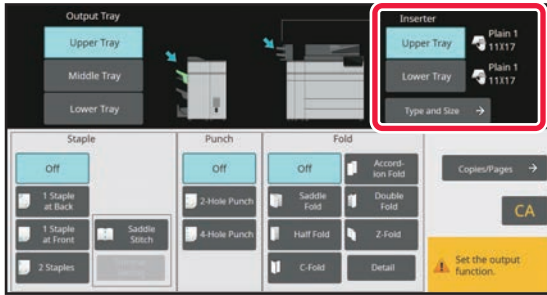

TO CHANGE THE OUTPUT TRAY

The output tray is automatically selected based on the output function you set. If Z-Fold, Half Fold, or Punch is selected, you can select the upper, middle or lower tray for the output tray.

Tap the [Upper Tray], [Middle Tray] or [Lower Tray] key in "Output Tray" and select the output tray you require.

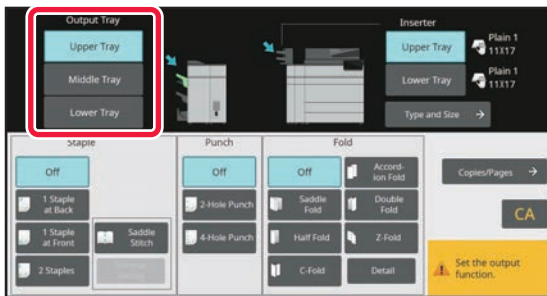

Relation between output function and output tray

An output tray is automatically selected as shown below based on the output function you set. Depending on the output function that is originally deselected, it may be deselected if you tap the [Upper Tray], [Middle Tray] or [Lower Tray] key to change the output tray.

For example, if you tap the [Upper Tray], [Middle Tray] or [Upper Tray] key with "Saddle Stitch" selected, the setting for "Saddle Stitch" is canceled.

Output function	Deliver to	
Staple	Upper Tray (A) or Lower Tray (C)	
Z-Fold/Half Fold/Punch	Upper Tray (A), Middle Tray (B) or Lower Tray (C)	
Saddle Stitch/Saddle Fold	Saddle Stitch Tray (D)	
C-Fold/Accordion Fold/Double Fold	Folding Unit Tray (E)	



CONVENIENT USE OF THE MACHINE

USE ENVIRONMENTALLY FRIENDLY

ECO	9-2
ECO FUNCTIONS OF THE MACHINE	9-2
AUTO POWER SHUT-OFF MODE	9-2
PREHEAT MODE.....	9-3
ECO RECOMMENDATION FUNCTION DISPLAY	9-3
AS SOON AS THE REMOTE JOB IS FINISHED, ENTER AUTO POWER SHUT OFF MODE.....	9-4
ECO SCAN.....	9-6
ECO SCAN SETTING	9-6
ENERGY SAVING PATTERN LIST	9-7
POWER ON/OFF SCHEDULE SETTING	9-8
SPECIFIC DATE OPERATION SETTINGS.....	9-9
DISPLAYING ECO RECOMMENDATION SETTINGS (ECO RECOMMENDATION FUNCTION DISPLAY) ...	9-10
TONER SAVE MODE.....	9-10
MOTION SENSOR.....	9-11

MANAGING THE USE OF THE MACHINE

USER AUTHENTICATION	9-12
AUTHENTICATION BY USER NUMBER.....	9-12
AUTHENTICATION BY LOGIN NAME/PASSWORD	9-14
QUICK AUTHENTICATION	9-17
USER CONTROL	9-20
ORGANIZATION /GROUP LIST	9-21
PAGE LIMIT GROUP LIST.....	9-22
AUTHORITY GROUP	9-23
FAVORITE OPERATION GROUP LIST.....	9-24
ACTIVE DIRECTORY LINKING FUNCTION	9-24
BILLING CODE	9-25
BILLING CODE	9-25
USE BILLING CODE	9-26
REGISTERING A NEW BILLING CODE	9-29
EDITING OR DELETING THE REGISTERED BILLING CODE.....	9-32

USING THIS MACHINE IN A NETWORK ENVIRONMENT

USING WI-FI	9-35
WI-FI	9-35
WPS	9-36
CONNECTING BY BLUETOOTH	9-36
EASILY CONNECT WITH AN NFC-COMPATIBLE MOBILE DEVICE (EASY CONNECT)	9-37
CONNECTING BY NFC	9-37
CONNECTING BY QR CODE.....	9-38
OAuth 2.0 AUTHENTICATION	9-39
GETTING A TOKEN	9-39
DELETE A TOKEN	9-41
CHECKING TOKEN STATUS.....	9-41
NAS	9-42
FOLDER STRUCTURE.....	9-42
REMOTE OPERATION OF THE MACHINE	9-43
Sharp OSA	9-45
APPLICATION COMMUNICATION	9-45
EXTERNAL ACCOUNT APPLICATION	9-46
VIRUS SCAN	9-47
VIRUS SCAN/VIRUS DEFINITION UPDATE TIMING AND TARGET DATA.....	9-47
WHEN A VIRUS IS DETECTED	9-49
UPDATING THE VIRUS DEFINITION FILE	9-51

UNIVERSAL DESIGN IN THE MACHINE

UNIVERSAL DESIGN IN THE MACHINE	9-52
UNIVERSAL DESIGN RELATED TO OPERATION	9-52
UNIVERSAL DESIGN RELATED TO VISION	9-53
UNIVERSAL DESIGN RELATED TO HEARING	9-53
UNIVERSAL DESIGN FEATURES.....	9-54

JOB LOG LIST

ITEMS RECORDED IN THE JOB LOG	9-56
--	-------------



USE ENVIRONMENTALLY FRIENDLY

ECO

ECO FUNCTIONS OF THE MACHINE

Mode Settings

The eco function settings are set in a batch. "Custom Mode" and "Eco Mode" are available. Setting values applied by each mode is as follows.

Function	Custom Mode	Eco Mode
Preheat Mode Setting	1min.	1min.
Turn off Panel Display during pre-heat mode	On	On
Auto Power Shut-Off Timer	Fix transition time.: 15min.	Fix transition time.: 1min.
As soon as the remote job is finished, enter Auto power shut off mode.	On	On
Sleep Mode Power Level	Low Power	Low Power
Eco Scan	On	On (All Modes Except Copy)

Each Energy Save settings in System Settings is not applied when Custom/Eco mode is used.

AUTO POWER SHUT-OFF MODE

This mode turns off the power to the operation panel and the fusing unit, and makes the machine wait in the lowest power consumption state.

Auto Power Shut-Off mode will activate when the set duration of time elapses in waiting status without executing a job. Compared to preheat mode, the power-saving rate is considerably higher but the wakeup time is longer.

The main power indicator blinks in yellow when the machine is in Auto Power Shut-Off mode.

This mode is cleared when print data is being received, fax data is being output, or when the [Power] button is pressed while it is blinking.

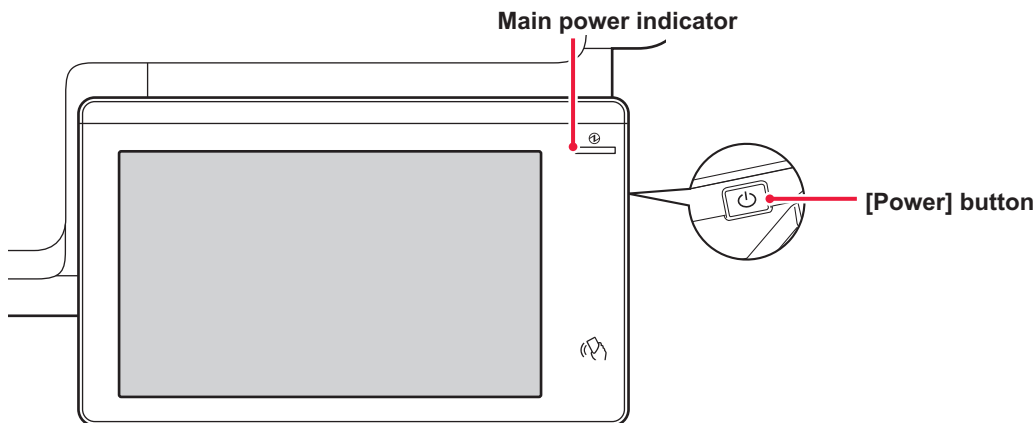



A message appears 15 seconds before Auto Power Shut-Off Mode is entered.
To close the message and continue normal operation, tap the [Continue] button.
The message appears again 15 seconds before the end of the extension of normal operation time.
If no action is taken within 15 seconds after the message appears, the machine enters auto power shut-off mode.



To set display of the message:

In "Settings (administrator)", select [System Settings] → [Energy Save] → [Eco Setting] → [Display Message When Extending Transition Time to Preheat/Auto Power Shut-Off Mode].



Pressing and holding the [Power] button during auto power shut-off will turn off the machine.

PREHEAT MODE

This mode lowers the temperature of the fusing unit and makes the machine wait in low power consumption state. Preheat mode will activate when the set duration of time elapses in waiting status without executing a job. Compared to Auto Power Shut-Off Mode, the amount of energy saved is less and the wakeup time is shorter. The touch panel goes off.
The main power indicator lights in blue when the machine is in preheat mode.
The touch panel is cleared when it is tapped or the [Home Screen] button is pressed.



To set preheat mode:

"Settings (administrator)" → select [System Settings] → [Energy Save] → [Eco Setting] → [Preheat Mode Setting].

A message appears 15 seconds before Preheat Mode is entered.
To close the message and continue normal operation, tap the [Continue] button.
If no action is taken within 15 seconds after the message appears, the machine enters preheat mode.



To set display of the message:

In "Settings (administrator)", select [System Settings] → [Energy Save] → [Eco Setting] → [Display Message When Extending Transition Time to Preheat/Auto Power Shut-Off Mode].

ECO RECOMMENDATION FUNCTION DISPLAY

Shows recommended copy/print settings for copy, document filing reprint, and direct print.

Copying

When you change to copy mode (normal mode), the settings recommended for copy mode appear.
Recommended settings: 2-Sided Copy, N-Up, and Image Orientation

Document filing print

When you tap the [Choose Print Settings] in the action panel on the file list screen of document filing, the settings recommended for this mode appear.
Recommended settings: 2-Sided Print and N-Up.

Direct print

When you tap the [Choose Print Settings] in the action panel on the file list screen of direct print, the settings recommended for this mode appear.
Recommended settings: 2-Sided Print and N-Up.



AS SOON AS THE REMOTE JOB IS FINISHED, ENTER AUTO POWER SHUT OFF MODE

Printing or outputting received fax data in Auto Power Shut-Off Timer turns on the power, and then the machine returns to Auto Power Shut-Off Mode immediately after completing the print job.

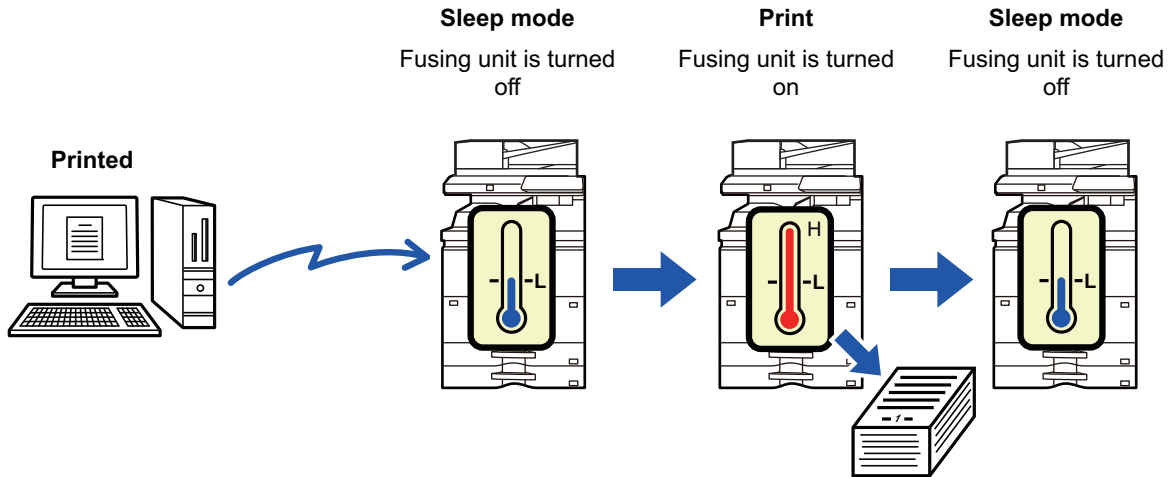

To set "As soon as the remote job is finished, enter Auto power shut off mode.":

In "Settings (administrator)", select [System Settings] → [Energy Save] → [Eco Setting] → [As soon as the remote job is finished, enter Auto power shut off mode.].

Fix transition time.

The Auto Power Shut-Off Timer is fixed. Select [Fix transition time.], and set the transition time in [Auto Power Shut-Off Timer].

When this setting is enabled, the [Change transition time by time of day.] option is disabled.

Change transition time by time of day.

This function controls the transition to Auto Power Shut-Off mode optimally for each time period by analyzing the use of the machine based on job logs obtained during a 4-week period.

When this setting is enabled, the [Fix transition time.] option is disabled.



- The image transfer control settings are not changed.
- This does not link to the Power On/Off Scheduling. If both of them are enabled, the Power On/Off Scheduling settings precede.
- Pages are counted for each paper size separately.
- When the power supply of the machine was off, there was no job during this time.



Transition to Energy Saving and Auto Power Shut-Off modes

Pattern	Transition time	Average outputs per hour*
Mode1 (Job Start Priority1)	After 1 hour	1000 or more
Mode2 (Job Start Priority2)	After 30 minutes	250 to 999
Mode3 (Energy Saving Priority1)	After 5 minutes	60 to 249
Mode4 (Energy Saving Priority2)	After the minimum time period	Up to 59

* Factory default setting

Automatic

This function controls the power optimally for each time period by analyzing the use of machine based on job logs obtained during a certain time period.



If the machine does not have the 4-week job log information, the machine enters the template2 (Mode3 (Energy Saving Priority1) between 8:00 and 18:00 hours). Then after that, it enters Mode4 (Energy Saving Priority2).

Manual

You can set a pattern for each time band.

The machine already has the 3-pattern template. The Energy Save pattern can be added to the "Original Eco Patterns 1 to 4".

Three-pattern template

Template	Pattern	Description of mode
Template 1	All Day "Energy Save Priority2"	The machine runs in the "Mode4 (Energy Saving Priority2)" all the time.
Template 2	8:00-18:00 "Energy Save Priority1"	The machine runs in "Mode3 (Energy Saving Priority1)" between 8:00 and 18:00, and in "Mode4 (Energy Saving Priority2)" at other times.
Template 3	8:00-18:00 "Job Start Priority1"	The machine runs in "Mode1 (Job Start Priority1)" between 8:00 and 18:00, and in "Mode4 (Energy Saving Priority2)" at other times.

Sleep Mode Power Level

Low Power: The machine switches to the power saving mode, but it takes some time to recover.

Fast Wake Up: Compared with Low Power, the power value rises by a certain degree, but it results in faster recovery.

Motion Sensor Mode: The motion sensor enables the machine to automatically wake from sleep mode.



ECO SCAN

Non-print jobs such as sending a scanned original are performed with the fusing unit turned off.

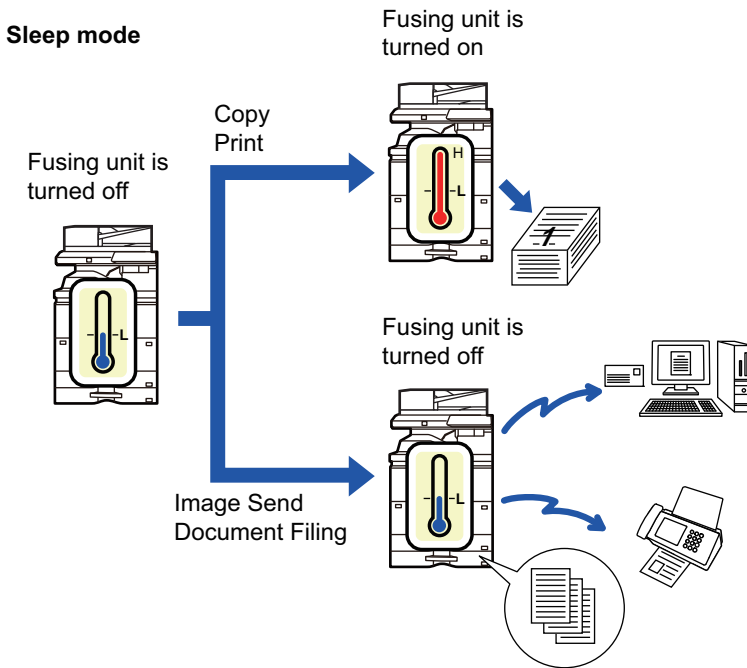

ECO SCAN SETTING

Set "Eco Scan Setting" to , and select a mode or screen in which to enable Eco Scan Setting. The following modes and screens can be set.

- Home Screen
- Copy
- Image Send
- Document Filing
- System Settings
- Sharp OSA



To set Eco scan:

"Settings (administrator)" → select [System Settings] → [Energy Save] → [Eco Scan Setting].



ENERGY SAVING PATTERN LIST

This function analyzes machine usage and controls entry into auto power shutoff mode based on frequency of use. If you want to manage machine power by using an energy saving pattern list, select [Manual] in "Settings (administrator)" - [Eco Setting] - [Energy Save] - [Change transition time by time of day.], and select an Automatic Update Pattern from the pull-down list or one of Original Eco Patterns 1 to 4.

To automatically analyze machine usage and update the pattern as needed, set Automatic Update Pattern.

Edit Pattern

Set the Original Eco Pattern.

Item	Description
Change Pattern Name	To change the pattern name, enter the desired name.
Pattern to Be Modeled	Select the stored pattern that you want to base the new pattern on. To copy the settings of a selected pattern, select [Copy the selected pattern.].
Energy Save Setting	Set time periods for machine modes. Select a mode from 1 to 4, and select a day of the week, start time, and end time.
Day of the Week	Set the day of week on which you want to enable the mode selected in the Energy Save Setting.
Start Time/Completing Time	Set the period of time during which you want to enable the mode selected in the Energy Save Setting.



POWER ON/OFF SCHEDULE SETTING

The machine operator panel can be turned On or Off at a preset time. Up to three (3) patterns can be set. The "Setting 1", "Setting 2" and "Setting 3" are executed in this sequence if set at the same day of week or at the same clock time.

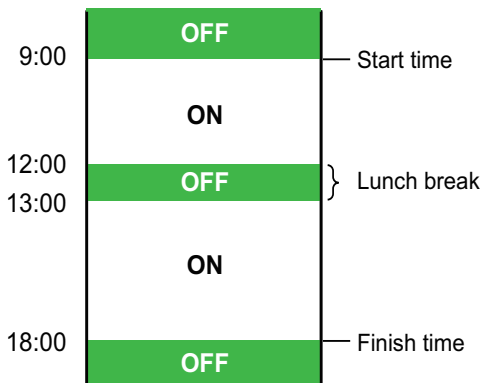

- The scheduling function does not support the power management settings in the Preheat Mode and Auto Power Shut-Off Mode.
- The preset power-off time is subject to the following restrictions:
 - If the machine is running due to the current job execution or other reasons, the machine is turned off only after the job has finished.
 - The machine cannot receive printer jobs.
 - The machine can receive output jobs, such as received fax data outputs.
 - If the Time Specified Output of Received Data setting is enabled, they are output next time the machine is turned on.
- If the power management setting is also enabled, the Power On/Off Scheduling settings precede.
- If the same time is specified, settings are applied in the order of "Setting 1", "Setting 2", and "Setting 3".
- The power is not turned off in the following cases:
 - "Power Up Auto Clear" is in progress.
 - The preset power on/off time is within one minute from when the setting is accepted.



Setting Power ON/OFF Scheduling Function

In "Settings", select [System Settings] → [Energy Save] → [Power ON/OFF Schedule Setting].



SPECIFIC DATE OPERATION SETTINGS

You can configure a day on which you have high-output printing or want to perform a special operation as the "specific date" and set a specific energy saving pattern only for that specific date.

"Specific Date" tab

A period of up to 7 days can be set for Specific Date. Set the specific date, energy saving pattern to be applied, and the operation that takes place if the specific date falls on a non-work day.



Regardless of whether the auto power shut-off transition time is enabled or disabled, the machine will operate on the Specific Date Operation Settings for the specific date.

Item	Description
Date Setting	Configure the date on which you want to operate the machine with a specific pattern. Select a day between 1 and 31 in Every Month or from End of Every Month.
Applied Energy Saving Operation	Select an energy saving pattern you want to apply. Use the ENERGY SAVING PATTERN LIST (page 9-7) to specify the details of the energy saving pattern.
Operation for Holiday	Configure how the machine operates if the preset specific date falls on a holiday. Use the ENERGY SAVING PATTERN LIST (page 9-7) to specify the day as the holiday.



- If a specific date that is initially specified coincides with the one that is moved because it falls on a holiday, the setting for the former takes precedence.
- If specific dates of the same dates are configured, they are used in ascending order between 1 and 7 (specific date numbers).

"Pattern" tab

This tab is used to configure the details of an energy saving pattern.

Item	Description
Energy Save Operation	Select a specific date pattern you want to specify.
Change Pattern Name	Enter a pattern name when you want to change the name of a specific date pattern.
Pattern to Be Modeled	Select a source pattern when you create a pattern using a stored or preset pattern.
Add new schedule.	Add a schedule.

"Holiday" tab

Specify a holiday. The day you specified as the holiday will not be a specific date.

Item	Description
Holiday List	When you tap this option, the dates and days of the week for the holidays you have set for two years.
Day of Week	Use this option to specify a holiday using a day of the week.
Set Period	Use this to specify a holiday using a date. "Final Registered Time" shows when the holiday that is stored with Set Period was stored.



DISPLAYING ECO RECOMMENDATION SETTINGS (ECO RECOMMENDATION FUNCTION DISPLAY)

When the base screen of normal mode is displayed, eco recommendation settings appear.



This function does not operate in easy mode.



To use the eco recommendation function display:

"Settings (administrator)" → [System Settings] → [Energy Save] → [Eco Setting] → [Eco Recommendation Function Display].

The displayed functions are as follows.

- 2-Sided Copy: [▶ page 3-17](#)
- N-Up: [▶ page 3-59](#)
- Image Orientation: [▶ page 3-28](#)

TONER SAVE MODE

This mode is used to reduce toner consumption.

Toner consumption can be set for each print job of "Copy", "Printer", and "Prints (Document Filing)".

Toner consumption can be selected from three levels.

- Toner Save1 (Toner Consumption: Much)
- Toner Save2 (Toner Consumption: Middle)
- Toner Save3 (Toner Consumption: Little)



MOTION SENSOR

This sensor detects the presence of a person that approaches the machine, and automatically wakes the machine from sleep mode. (Motion Sensor Mode Only)

Three settings are available for the detection range (I / II / III).

In addition, when the motion sensor responds during the time when the power of this machine is set to OFF in the Power ON/OFF Schedule Setting, you can be warned with a notification message.

When you register an e-mail address as an alert destination, detection information will be sent to inform you that the motion sensor has responded to the registered e-mail address.

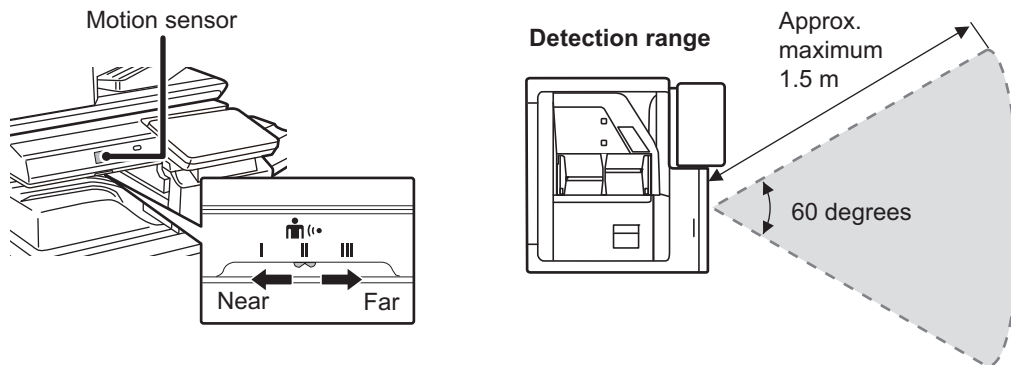

- The motion sensor detects the movement of sources of heat.
- The detection range may vary depending on the installation site and environment (ambient temperature, etc.).



The motion sensor may not operate correctly in the conditions below.

- An object is in front of the motion sensor
- There are scratches or dirt on the motion sensor cover
- The motion sensor is directly exposed to sunlight or air flow
- The motion sensor is damaged
- There is a source of heat such as a heater nearby
- An object is moving in the detection range



To enable the motion sensor

"Settings (administrator)" select [System Settings] → [Energy Save] → [Eco Setting] → [Sleep Mode Power Level].



MANAGING THE USE OF THE MACHINE

USER AUTHENTICATION

User authentication restricts the use of the machine to users that have been registered. The functions that each user is allowed to use can be specified, allowing the machine to be customized to meet the needs of your workplace.

When the administrator of the machine has enabled user authentication, each user must log in to use the machine.

There are different types of user authentication, and each type has a different login method.

For more information, see the explanations of the login methods.

[AUTHENTICATION BY USER NUMBER \(page 9-12\)](#)

[AUTHENTICATION BY LOGIN NAME/PASSWORD \(page 9-14\)](#)

[QUICK AUTHENTICATION \(page 9-17\)](#)

For the settings that are required for user authentication, refer to [USER CONTROL \(page 9-20\)](#).

AUTHENTICATION BY USER NUMBER

The following procedure is used to log in using a user number received from the administrator of the machine.

When starting the machine, the login screen appears.

When controlled by user number

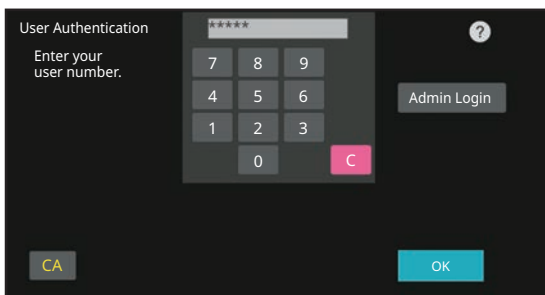

If "A Warning when Login Fails" is enabled in the system settings, the operation panel will be locked for five minutes if an incorrect user number is entered three times in a row.

Contact the machine administrator to check the user number assigned for you.

1

Enter your user number (5 to 8 digits) using the numeric keys.

Each entered digit will be displayed as "*".



2

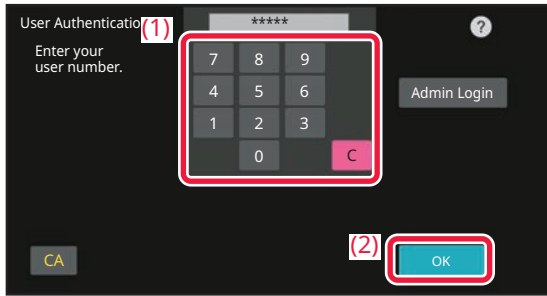

Tap the [OK] key.

If the entered user number is authenticated, the number of remaining pages that the user can copy or scan is displayed. When a limitation is set for the number of pages that a user can use, the use count for the user that has logged in is displayed.



- **To limit the number of pages that a user can use:**

In "Settings (administrator)", select [User Control] → [Access Control Settings] → [Pages Limit Group].

- **To hide the number of pages that can be used after login:**

In "Settings (administrator)", disable [System Settings] → [Authentication Settings] → [Default Settings] → [Display Usage Status after Login].

- **To change the message display time:**

In "Settings" (administrator)", select [System Settings] → [Common Settings] → [Operation Settings] → [Condition Settings] → [Message Time Setting].



When the user number is an 8-digit number, this step is not necessary. Login takes place automatically after the user number is entered.

3

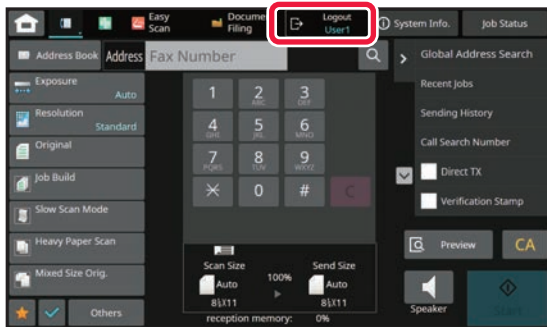

When you have finished using the machine and are ready to log out, tap [Logout].



AUTHENTICATION BY LOGIN NAME/PASSWORD

This method enables users to log in using a login name and password received from the administrator of the machine or the administrator of the LDAP server.

When starting the machine, the login screen appears.

When controlled by login name and password

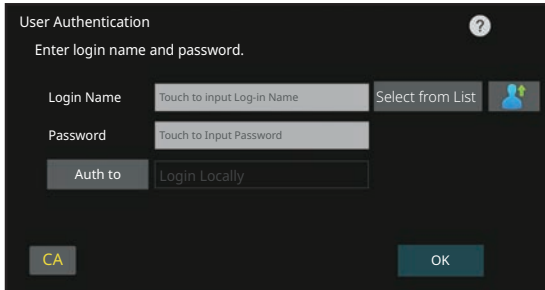

- Different items may appear in the screen when LDAP authentication is used.
- When LDAP authentication is used, the [E-mail Address] key may appear, depending on the authentication method. Tap the [E-mail Address] text box and enter your e-mail address.

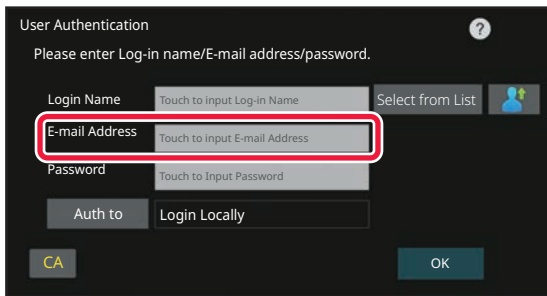

- If "A Warning when Login Fails" is enabled in the system settings, the operation panel will be locked for five minutes if an incorrect login name or password is entered three times in a row. Contact the machine administrator to check the login name/password assigned to you.



- **To set [A Warning when Login Fails]:**
In "Settings (administrator)", select [System Settings] → [Authentication Settings] → [A Warning when Login Fails].
- **To store a user name:**
In "Settings (administrator)", select [User Control] → [User Settings] → [User List]. Also register detailed information such as the login name, user number, and password. Ask the administrator of the machine for the information that you need to use the machine.

1

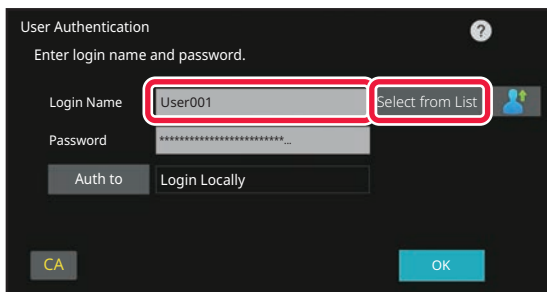

Enter the login name.

Entering using the soft keyboard

If user name registration has not been performed in setting mode, a user only using LDAP authentication should tap the [Login Name] text box and enter the login name using the soft keyboard.

Selecting from a list

Tap the [Select from List] key and select a user name from the User List screen.



LDAP authentication can be used when the administrator of the server provides LDAP service on the LAN (local area network).



2

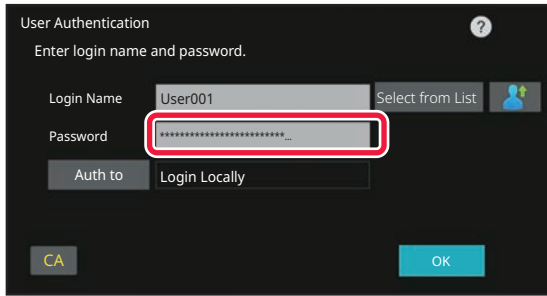

Enter the password.

Enter the from the soft keyboard.

If you are logging in to an LDAP server, enter the password that is stored with your LDAP server login name.

Each entered character will be displayed as “* “. After entering the , tap the [OK] key.

When authentication is by LDAP server and you have different passwords stored in "User List" and in the LDAP server, use the password stored in the LDAP server.



To have the user name and password registered:

- In "Settings (administrator)", select [User Control] → [User Settings] → [User List].



- When registering the LDAP server, change the information for [Auth to] as required.

• When selecting from the User List screen:

The LDAP server you are connecting to has been registered upon user registration, and so the target server to which authentication should be directed appears when the login name is selected. Go to step 3.

• When entering from the soft keyboard:

Tap [Auth to] and select the LDAP server to log in.

3

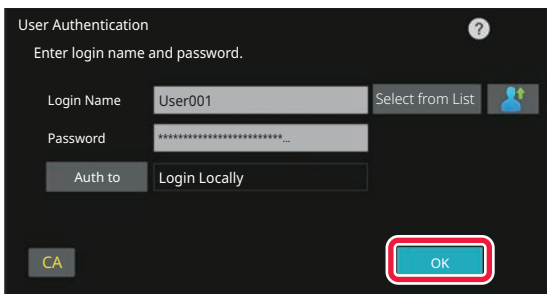

Tap the [OK] key.

If the entered login name and password are authenticated, the number of remaining pages that the user can copy or scan is displayed.

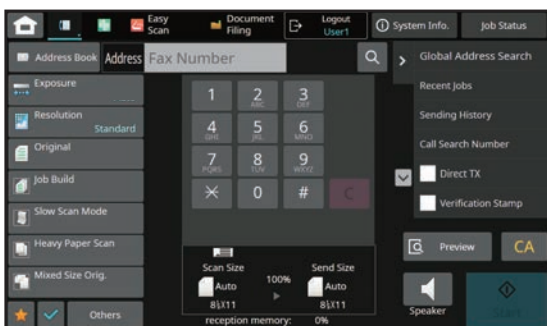

When a limitation is set for the number of pages that a user can use, the use count for the user that has logged in is displayed.



- **To limit the number of pages that a user can use:**
In "Settings (administrator)", select [User Control] → [Access Control Settings] → [Pages Limit Group].
- **To hide the number of pages that can be used after login:**
In "Settings (administrator)", disable [System Settings] → [Authentication Settings] → [Default Settings] → [Display Usage Status after Login].
- **To change the message display time:**
In "Settings" (administrator)", select [System Settings] → [Common Settings] → [Operation Settings] → [Condition Settings] → [Message Time Setting].

4

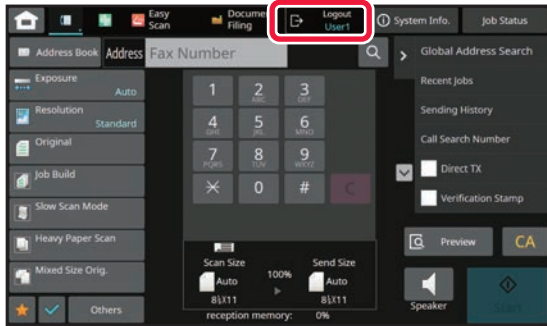

When you have finished using the machine and are ready to log out, tap [Logout].



QUICK AUTHENTICATION

When operating the machine, this enables easy authentication by tapping a preconfigured icon.



- Up to 20 users can be registered.
- Only the machine supports quick authentication. Web page authentication and authentication from a printer driver cannot be used. To use web page authentication and authentication from a printer driver, enter to authenticate.
- Quick authentication cannot use IC card authentication or device account mode.
- If [A Warning when Login Fails] is enabled in the system settings, the operation panel will be locked for five minutes if an incorrect password is entered three times in a row. Contact the machine administrator to check the password assigned to you.



To use quick authentication

In "Settings (administrator)", enable [System Settings] → [Authentication Settings] → [Default Settings] → [Enable Quick Login].

For the authentication server settings, set "Login Locally", and for the authentication method settings, set "Login Name/Password".

Register users with quick authentication

When registering users with quick authentication, the User Administration Settings and Web page settings used when registering normal users cannot be used. Registration is carried out on the quick authentication login screen.

1

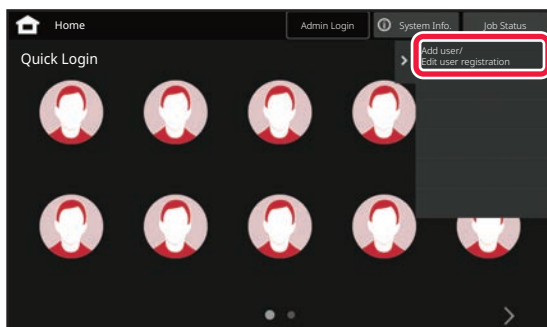

Tap [Add user/Edit user registration] on the action panel.

2

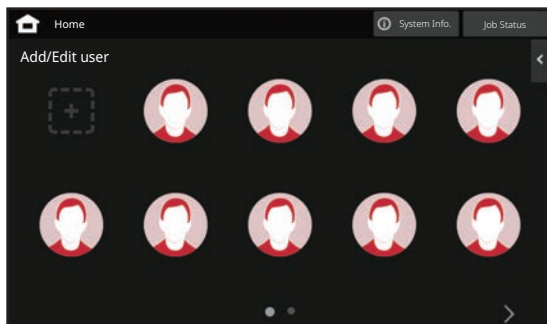

Tap the position you wish to register.

This switches to the user registration screen.

When tapping an icon that is already registered, this switches to the user information edit screen.

Details to edit are the same as the settings details in registering a new user screen. See step 3 when editing.



3

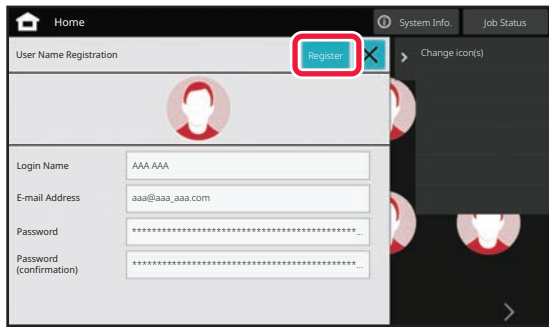

Enter user information, and tap the [Register] key.

Specify the user icon, Login Name, E-mail Address, Password, and Password (confirmation). Tap the items to register, and enter necessary details.

- Tap "Change icon(s)" on the action panel, and the icon selection screen appears. Select the desired icon to configure.
- Login Name is displayed together with the icon. Ensure this is entered.
- When editing user information, the Password cannot be changed. "Password" and "Password (confirmation)" will not be displayed on the edit screen.



To delete a registered user

Tap [Add user/Edit user registration] on the action panel, then tap the icon of the user to delete. Tap [Delete] on the action panel, and then tap the [Delete] key in the displayed confirmation message.



User editing and deleting from User Administration Settings and Web page

In "Settings (administrator)", select [User Control] → [User Settings] → [User List].

Authenticating the machine using quick authentication

1

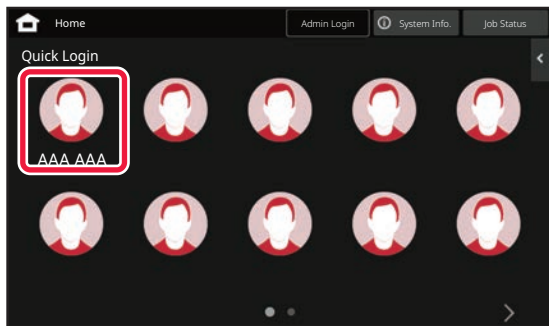

Tap the icon.

If a password is not set, then login will close at this time.

2

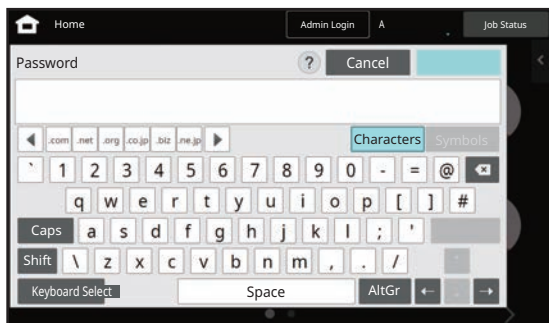

If setting a Password, enter the Password.

Enter the Password from the soft keyboard. Entered text is displayed with "*". After entering the Password, tap the [OK] key.



3



When you have finished using the machine and are ready to log out, tap [Logout].



USER CONTROL





You can perform user management such as registering login users and specifying the user authentication method. In [User Control] of "Settings (administrator)" and [System Settings] of [Authentication Settings].

User Control allows you to register and manage the users who use the machine.

By limiting the number of pages and functions that a user or a group of users can use, incorrect use of the machine can be prevented.

To prevent unauthorized use, persons who are not registered can be prohibited from using the machine or prohibited from using certain functions.

Example: Information stored in User Name Registration

	User Name : AAA Custom Index : Group A Pages Limit Group : "Limited" group	Authority Group: User Favourite Operation Group: Group a
	User Name : BBB Custom Index : Group B Pages Limit Group : "Limited" group	Authority Group: User Favourite Operation Group: Group a
	User Name : CCC Custom Index : Group A Pages Limit Group : "Unlimited" group	Authority Group: Administrator Favourite Operation Group: Group b
	User Name : None (Users not registered in the machine)	

Custom Index

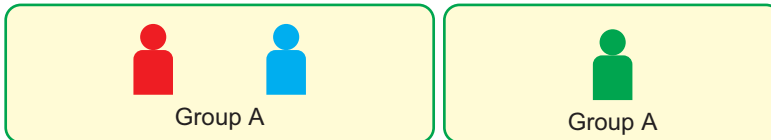

Using the machine

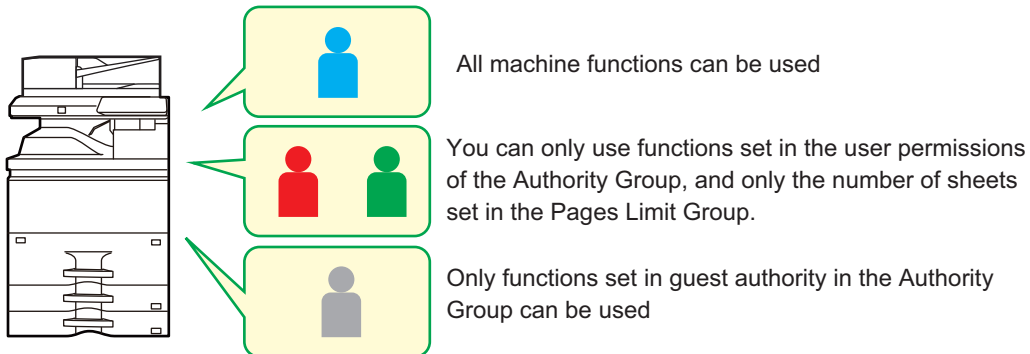

Favourite Operation Group



The machine can be operated using the screen displays and default settings set for each group.



ORGANIZATION /GROUP LIST

A user can be registered in an organization/group to enable sharing the contacts and group information registered in that group. When counting all used pages, you can check how many pages and what functions are used by each group. Multiple organizations/groups can be set for a user.

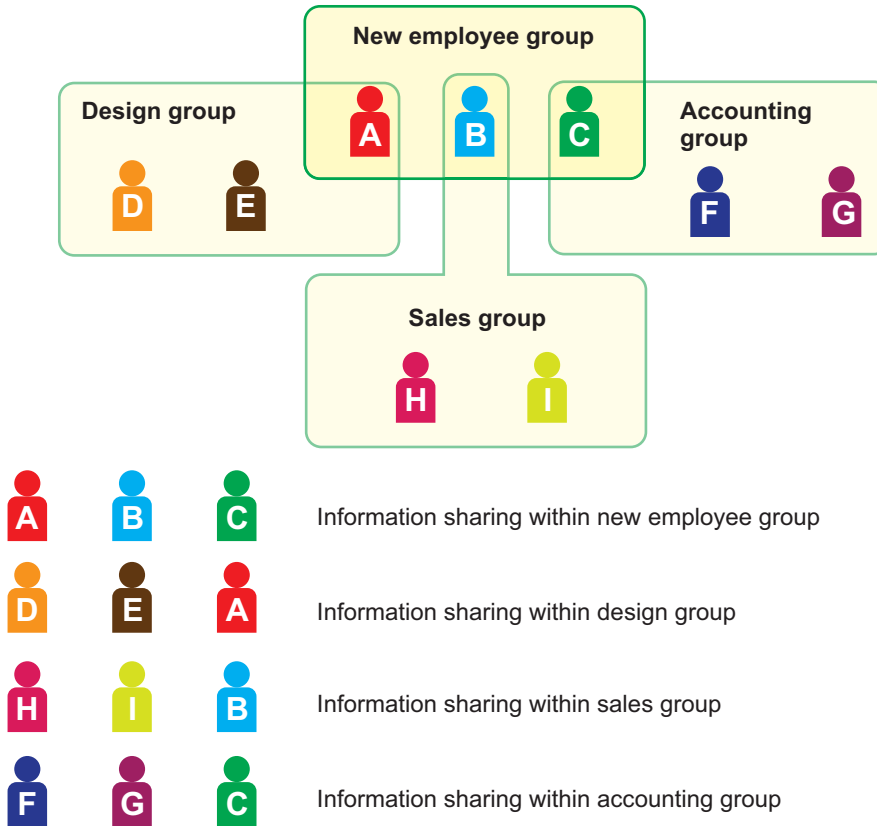



PAGE LIMIT GROUP LIST

A Page Limit Group List can be used to limit the number of sheets that users in a specific group can use for copies or print jobs, and limit the number of pages that can be scanned or faxed. The users can also be prohibited from using certain functions.

Page Limit Group List A

Copy :

Page Limit (10000)

Printer :

Unlimited

Document Filing Print :

Unlimited

List Prints :

Unlimited

Scanner :

Prohibited

Fax Send :

Prohibited

Scan to Local Drive :

Page Limit (50000)

This section explains how to set the Page Limit Group List.

- Users in this group can use up to 10,000 pages for copying.
- Printer, Document Filing Print and List Print can be used without restriction.
- Scanner and fax transmission cannot be used.
- Up to 50,000 pages can be used for scan save.



AUTHORITY GROUP

Authority Group is used to restrict the functions and settings that users who belong to a specific group can use. By setting restrictions on functions and settings, you can prevent inexperienced users from performing incorrect operations and settings, and thereby enable safe use of the machine.

Main authority types (Default Group List)

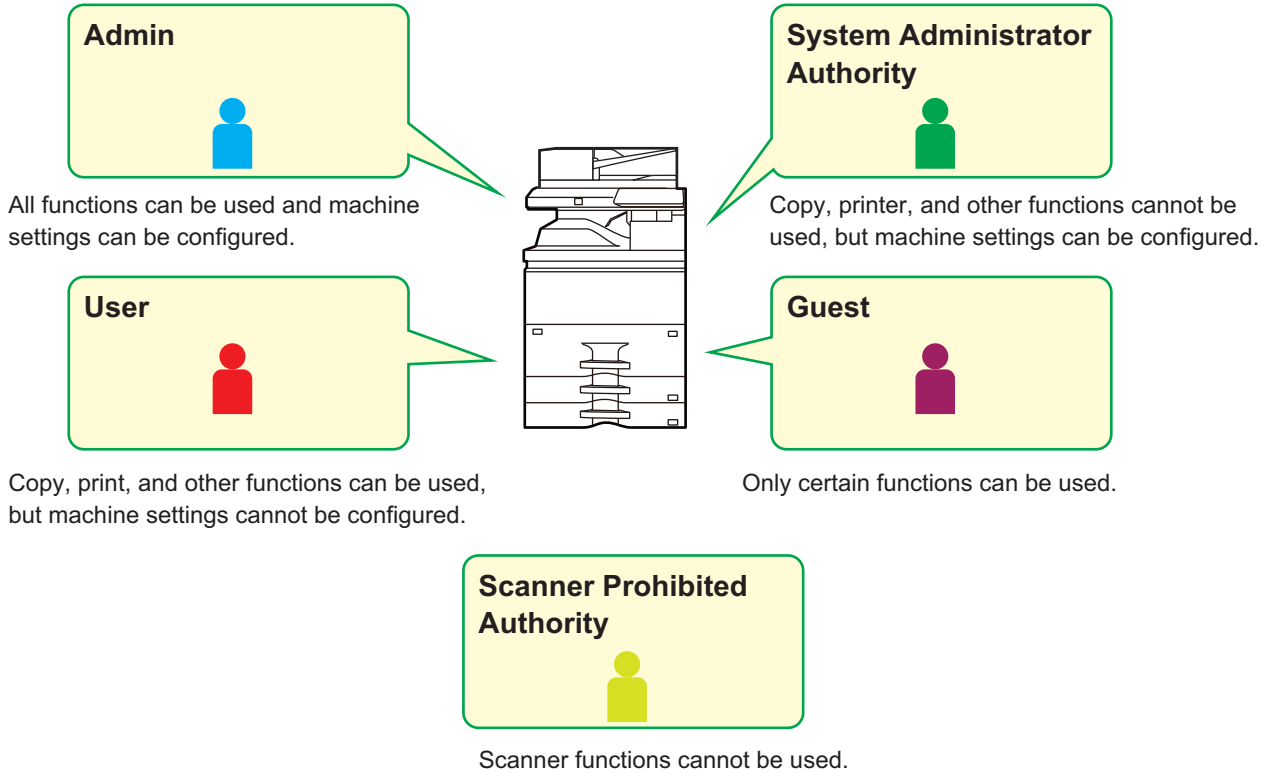



FAVORITE OPERATION GROUP LIST

For each group, you can register an environment with settings that are convenient for the group. For example, if the users speak different languages, a language can be set for each group, and this setting is applied automatically at login (normally the display language cannot be changed each time the machine is used).

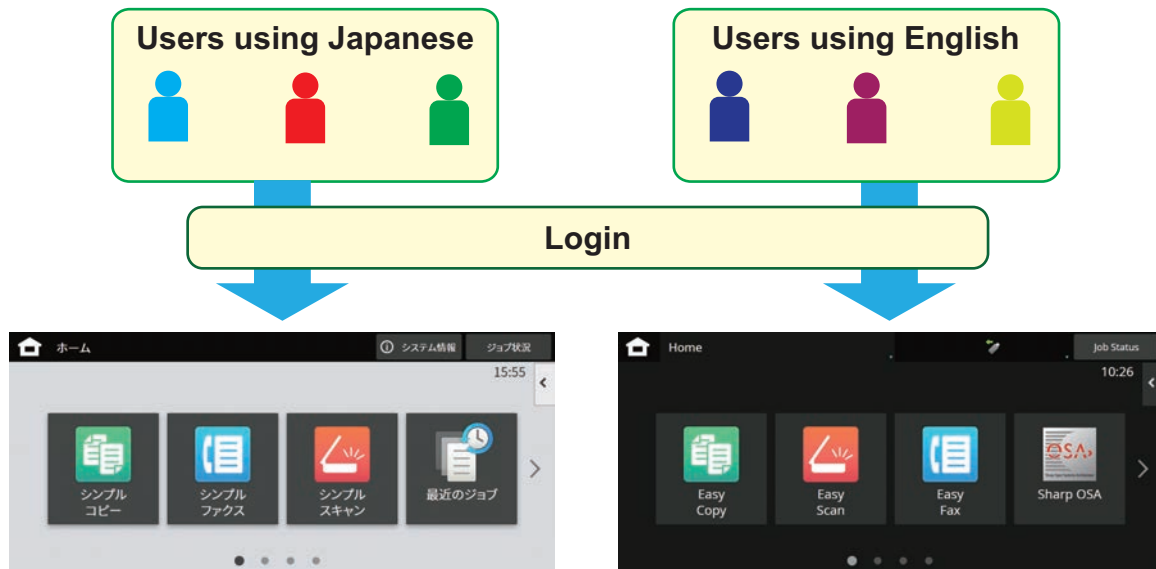

By setting English for users using English and Japanese for users using Japanese in the Favorite Operation Group List, the language will automatically switch between English and Japanese when a user logs in to the machine.

ACTIVE DIRECTORY LINKING FUNCTION

You can join the Active Directory domain (AD domain) of the machine, and easily perform user management on the network.

On a network that does not have Active Directory enabled, you must perform network device authentication for each device.

For this reason, one user must have multiple domain names and passwords.

When you join an AD domain, you only need to be authenticated once. After you are authenticated, the Active Directory server automatically authenticates network devices. You can log in to multiple devices on the network with a single domain name and password.



BILLING CODE

BILLING CODE

A billing code, which is added to a recorded job log when a printing or sending job has been executed, is used to perform billing processing.

Billing codes are classified into two types: main code and sub code. A billing code is recorded in the job log when it is entered and a print or send job is executed.

Summing up the amounts by Billing Code based on the job logs will facilitate the subsequent operations, for instance, when making combined billings.

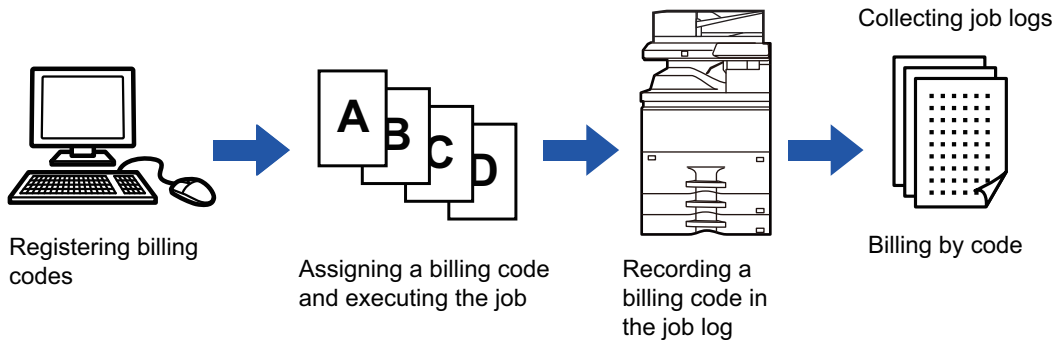

Types of billing codes

Type	Description
Main Code	Used to categorize the results of the executed print and send jobs to enable efficient management. For example, you can assign a code by customer and collect cost information by customer from job logs. Code example: Issue of company A
Sub Code	Available when the main code alone is not sufficient to enable management of billing codes. For example, you can assign monthly cost information to a sub code and collect the total monthly cost information of all customers when the customer name is assigned to the main code. Code example: Issue of October, 2020
Default Code	Automatically assigned when the main code or sub code has not been specified.

Enable use of billing code

To enable use of the billing code, select "Settings (administrator)" → [User Control] → [Billing Code Setting] → [Administration Settings], then set [Use Billing Code] to [Enable].

Collecting billing codes

In "Settings (administrator)", select [System Settings] → [System Control] → [Job Log] → [Job Log Operation], and click [Save] button to download the job logs. Then sum up the data by classifying and arranging the stored job logs.



USE BILLING CODE

If the use of billing code is enabled in "Settings (administrator)", the billing code entry window is displayed at the time of mode transition (at the time of printing/sending in document filing mode).

Enter the main code or sub code as required.



- **To enable use of the billing code**

Select "Settings (administrator)" → [User Control] → [Billing Code Setting] → [Administration Settings], then set [Use Billing Code] to [Enable].

- **To retain the specified billing code at the time of mode transition**

Select "Settings (administrator)" → [User Control] → [Billing Code Setting] → [Administration Settings], then set the [Remember Billing Code Between Modes] check box to . This eliminates the need to enter billing codes at each mode transition.



You can assign billing codes to reprinting/resending of target files and sending of print jobs from "Settings (administrator)" → [Document Operations].

Specifying a billing code again

To change the specified billing code to another one, tap [Switch Billing Code.] on the action panel.

When the billing code entry window is displayed, select a new billing code.

Select a billing code from the list

Select the desired billing code from the list of registered billing codes.

You need to register billing codes in advance.

[REGISTERING A NEW BILLING CODE \(page 9-29\)](#)

1

Billing Code

Please enter Billing Code.

Main Code: AAAA [Select from List]

Sub Code: AAAA [Select from List]

[CA] [Bypass Billing Code] [OK]

When the billing code entry window is displayed, tap the [Select from List] key of the main code.



- **When not specifying a billing code**

Tap the [Bypass Billing Code] key.



- **To select the previously used billing code (at the time of user authentication)**

Tap [Use Previously-Used Billing Code] on the action panel at the time of user authentication; this displays the main code and sub code the authenticated user has entered previously.



2

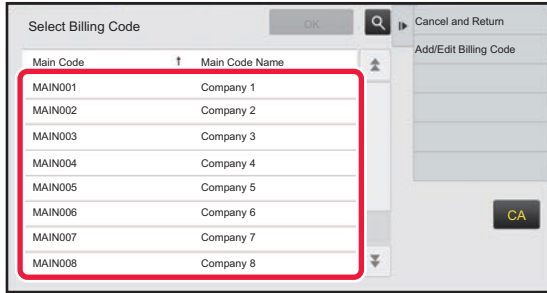

Tap and select the main code from the list.



To search for the main code or main code name

Tap . When the search window is displayed, enter the main code and main code name, then tap the [Search Start] key. The search result list is displayed.

3

Tap the [Execute] key.

Returns the screen to the billing code entry window.



To cancel the selection from the list

Tap [Cancel and Return] on the action panel. This cancels the selected main code and returns the screen to the billing code entry window.



To check the details of the main code

Tap [Display Details] on the action panel. The detail window is displayed. Check the details, then tap .

4

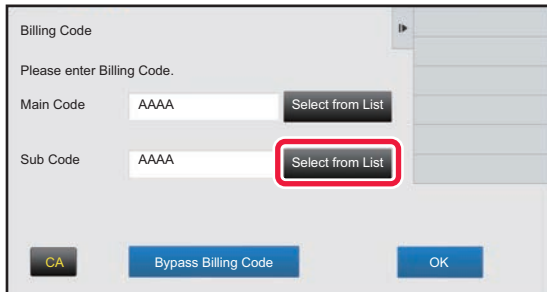

Tap the [Select from List] key of the sub code.

The sub code list is displayed. Perform the procedure shown in steps 2 and 3, then specify the sub code.

5

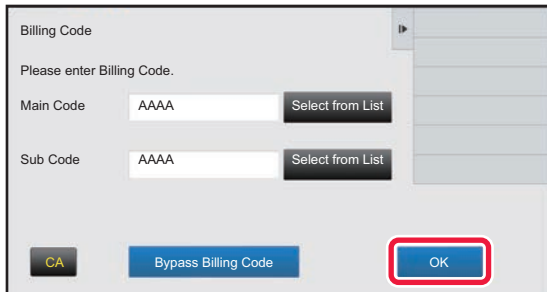

Tap the [OK] key.



To clear the value of the specified billing code

- Tap the [CA] key. Enter the billing code again.



Directly entering a billing code

1

When the billing code entry window is displayed, tap the box in [Main Code], then enter the main code.

Specify the code using up to 32 single-byte characters.



When not specifying a billing code

Tap the [Bypass Billing Code] key. The use code is set to the main code.

2

Tap the box of [Sub Code], then enter the sub code.

Specify the code using up to 32 single-byte characters.

3

Tap the [OK] key.



To clear the value of the specified billing code

Tap the [CA] key. Enter the billing code again.



REGISTERING A NEW BILLING CODE

Register a new billing code.

A billing code can be registered not only from the billing code entry window but also from "Settings".



A total of up to 2000 main and sub codes can be registered.

Shared range of billing code

The registered billing codes can only be shared in the specified group at the time of user authentication.

If the shared range is not specified, the registered billing codes are shared by all users.

1

When the billing code entry window is displayed, tap [Select from List] of the main code.

To register a new sub code, tap the [Select from List] key of the sub code.

The subsequent steps are the same as the main code.

2

Tap [Add/Edit Billing Code] on the action panel.

3

Tap [Add New] on the action panel.



To return to the billing code selection window

Tap **OK**.



4

Tap the box of [Main Code], then type in the main code.

Specify the code using up to 32 single-byte characters.

5

Tap the box of [Main Code Name], then type in the main code name.

Specify the code name using up to 32 double- or single-byte characters.

6

If necessary, select the share range of billing code.

Public to All: Registers the billing code as a public code for all users who use the machine.

Specify target public address: Limits the share range of billing code to be registered only to the specified group. Up to eight groups can be specified as a public destination.

For details on how to specify a public destination, refer to "[Shared range of billing code \(page 9-29\)](#)".



The public destination of a billing code is not displayed if user authentication is not performed. The mode is automatically set to [Public to All].

7

Tap and select a group as a public destination

Up to eight groups can be specified. After the settings are completed, tap **OK**.



To cancel the setting

Tap [Clear] on the action panel. This cancels the registered public destination and returns the screen to the previous window.



8

To continuously register other billing codes, tap [Register Next Billing Code].

Execute steps 4 to 7 to register the main code.



To cancel the registration

Tap [Cancel and Return] on the action panel. This cancels all the registered billing codes and returns the screen to the previous window.

9

Tap [End Registration] on the action panel.

This finalizes the registration and returns the screen to the previous window. Tap **OK** to finish the registration procedure.



To return to the billing code entry window

Tap the [CA] key.



EDITING OR DELETING THE REGISTERED BILLING CODE

You can change or delete the registered billing code.
The billing code can also be edited or deleted from "Settings".

Editing a billing code

1

Billing Code

Please enter Billing Code.

Main Code: AAAA [Select from List]

Sub Code: AAAA [Select from List]

[CA] [Bypass Billing Code] [OK]

When the billing code entry window is displayed, tap the [Select from List] key of the main code.

To register a new sub code, tap the [Select from List] key of the sub code.

The subsequent steps are the same as the main code.

2

Select Billing Code

Main Code	Main Code Name
MAIN001	Company 1
MAIN002	Company 2
MAIN003	Company 3
MAIN004	Company 4
MAIN005	Company 5
MAIN006	Company 6
MAIN007	Company 7
MAIN008	Company 8

[Add/Edit Billing Code] [OK] [Cancel and Return] [CA]

Tap [Add/Edit Billing Code] on the action panel.

3

Main Code Registration

Main Code	Main Code Name
MAIN001	Company 1
MAIN002	Company 2
MAIN003	Company 3
MAIN004	Company 4
MAIN005	Company 5
MAIN006	Company 6
MAIN007	Company 7
MAIN008	Company 8

[Edit] [Add New] [Delete] [OK] [CA]

Tap and select the main code to be edited, then tap [Edit] on the action panel.



To return to the billing code selection window
Tap **OK**.

4

Edit the main code as required.

For information on how to correct the code, refer to steps 4 to 7 in "[REGISTERING A NEW BILLING CODE \(page 9-29\)](#)".



5

Tap [End Registration] on the action panel.

This finalizes the registration and returns the screen to the previous window. Tap **OK** to finish the registration procedure.



To return to the billing code entry window
Tap the [CA] key.

Deleting a billing code

1

Billing Code

Please enter Billing Code.

Main Code AAAA **Select from List**

Sub Code AAAA Select from List

CA Bypass Billing Code **OK**

When the billing code entry window is displayed, tap the [Select from List] key of the main code.

To delete a sub code, tap the [Select from List] key of the sub code.

The subsequent steps are the same as the main code.

2

Select Billing Code

Main Code	Main Code Name
MAIN001	Company 1
MAIN002	Company 2
MAIN003	Company 3
MAIN004	Company 4
MAIN005	Company 5
MAIN006	Company 6
MAIN007	Company 7
MAIN008	Company 8

CA Add/Edit Billing Code

Tap [Add/Edit Billing Code] on the action panel.

3

Main Code Registration

Main Code	Main Code Name
✓ MAIN001	Company 1
MAIN002	Company 2
MAIN003	Company 3
MAIN004	Company 4
MAIN005	Company 5
MAIN006	Company 6
MAIN007	Company 7
MAIN008	Company 8

CA Delete

Tap and select the main code to be deleted, then tap [Delete] on the action panel.



To return to the billing code selection window
Tap **OK**.



4

When the confirmation message appears, tap the [Delete] key.



USING THIS MACHINE IN A NETWORK ENVIRONMENT

USING WI-FI

WI-FI

This machine can connect to mobile devices and others via Wi-Fi.

This machine can use three communication modes.

Wi-Fi environment can be configured from System Settings.

COMMUNICATION MODES OF WI-FI

Infrastructure Mode

The machine and mobile device can communicate via network with an access point installed.

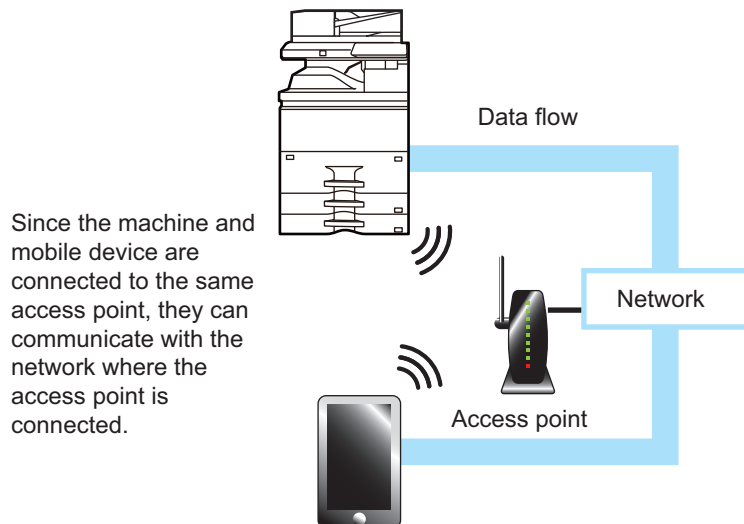

Access Point Mode

The machine can be set as an access point and communicate with a mobile device. In this mode, communication with the network to which the machine is connected is unavailable.

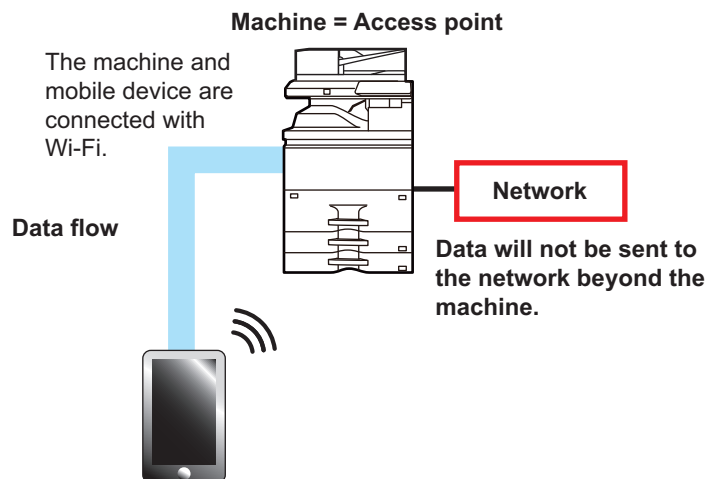



Wi-Fi Direct Mode

The machine and mobile device directly communicate via Wi-Fi. In this mode, communication with the network to which the machine is connected is unavailable.

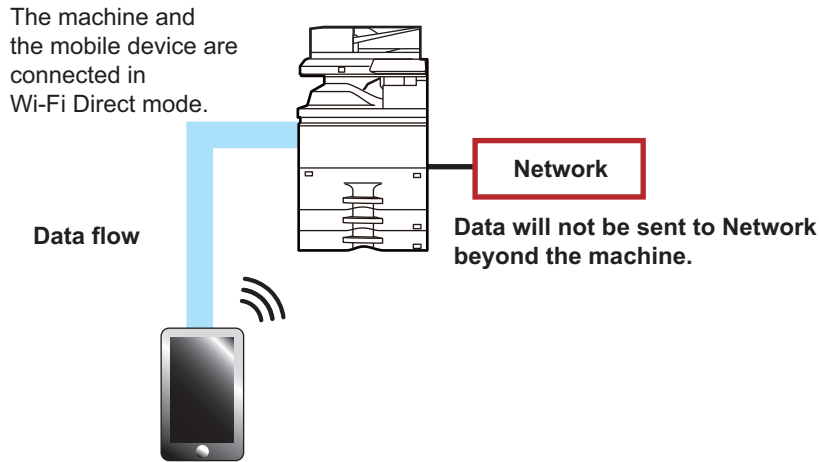

This function can be used on an Android device.

WPS

When connecting with Wi-Fi, connection to the network environment can be done simply with WPS, instead of manually configuring SSID and security setting.



WPS is available for the infrastructure mode only.

CONNECTING BY BLUETOOTH

This machine and mobile devices can be connected by Bluetooth.

When a mobile device is connected, its address book data can be displayed on the panel of the machine and used as destination addresses.

Fax numbers (telephone numbers) and e-mail addresses in the connected mobile device can be used as destination addresses.



EASILY CONNECT WITH AN NFC-COMPATIBLE MOBILE DEVICE (EASY CONNECT)

You can easily connect the machine to a smartphone or other NFC compatible mobile device.

- Touch the NFC touch point area in the lower right corner of the operation panel.

By installing the dedicated application in the mobile device in advance, the application will start automatically after the device connects to the machine, allowing you to print immediately.

You can also connect by displaying a QR code on the machine's touch panel and scanning the code with a mobile device that has a dedicated application installed.



Make sure that the mobile device's Wi-Fi function and NFC function are turned on in advance.

CONNECTING BY NFC

You can easily connect a mobile device to the machine by holding it to the NFC touch point area.

In addition, by installing the dedicated application on your mobile device, the application will automatically start when the device connects to the machine, allowing you to send data and print to the machine right away.

Configure settings on the machine in advance to enable use of an NFC and wireless LAN.



This function may not support depending on the Android version of your device.

1

Hold your mobile device to the NFC touch point area



If the machine is in the auto power shutoff state, holding your mobile device to the NFC touch point area will wake the machine. However, if [Sleep Mode] is set to [Energy Saving Priority], you must wake the machine manually.

2

Connecting to the Machine from a Mobile Device

The machine and mobile device automatically start the connection.

If the dedicated application is not installed, your mobile device will automatically connect to the Google Play™ site and download the dedicated application.

If the dedicated application is installed on your mobile device, it will start.

You can print and scan from the application.



If the connection is not successful, try the following:

- Move the mobile device slowly over the NFC touch point area.
- If a case is attached to the mobile device, remove the case.



CONNECTING BY QR CODE

You can connect by displaying the QR code on the machine's touch panel and then having your mobile device (with the dedicated application already installed) read the QR code.

The machine sends the information required for connection to the mobile device, and the information is saved. No settings are required on the mobile device, and setup is quickly accomplished.

Configure settings on the machine in advance to enable connection by QR code.



This function can be used on an Android device and on an iOS device.

1

Tap the [Easy Connect (QR code)] key in the home screen.

The QR code appears on the touch panel.

In advance, enable QR codes in [Easy Connection Setting] in Settings (administrator), and enable display of the [Easy Connect Setup] key in [Home Screen Settings].

2

Start the dedicated application on your mobile device

3

Read the QR code on the touch panel with your mobile device



The QR code is the machine's connection information. This information is saved on your mobile device. You can also set an external access point as the connection destination.



OAuth 2.0 AUTHENTICATION

When using Microsoft365, Exchange Online, etc. to send e-mails from this machine, it is recommended to use the OAuth 2.0 authentication method.

This section describes how to operate OAuth 2.0 authentication.

GETTING A TOKEN

With OAuth 2.0 authentication, the service provider provides an access token that can be obtained by the machine to send and receive e-mail.

This section describes how to obtain the token.

The settings should be configured by the administrator and executed at the machine. (The configuration cannot be completed on the Web page.)



When an error occurs during job execution, connect test the POP/SMTP authentication connection in the system settings. If [Token update failed. Please delete the token and obtain it again.] is displayed in the connection test result, delete the token and then obtain the token again.

SMTP Authentication Settings

The following settings are available for SMTP authentication, and the setting method is the same for all cases.

- System Settings → Network Settings → Service Settings (SMTP tab)
- System Settings → System Control → E-mail Alert and Status → SMTP Settings
- System Settings → Network Settings → Quick Settings
- System Settings → Initial Installation Settings → Network Quick Settings

This section describes how to obtain a token in System Settings → Network Settings → Service Settings (SMTP tab).

1 Tap **"Settings (Administrator)"** → **"System Settings"** → **"Network Settings"** → **"Service Settings"** → **"SMTP"** tab.

2 Configure necessary settings such as **"Primary Server"**, **"Port Number"**, **"Timeout"**, **"Sender Name"**, **"Sender Address"**, and **"Enable SSL/TLS"** in the **SMTP Settings**.

3 Select **"OAuth 2.0"** as the **Authentication Option**.

4 Select a provider.

5 Enter an account name.

**6****Tap the [Get Token] key.**

Tap the [Get Token] key, then tap the [OK] key when a confirmation message appears.

The login page of the selected provider will then be appeared.

Log in and follow the instructions to obtain the token.

When a token is acquired, the "Token" display changes from [Not Retrieved] to [Retrieved].

The following settings are common. When OAuth 2.0 authentication is received for any one of these settings, the settings are updated in concert with each other.

- System Settings → Network Settings → Service Settings (SMTP tab)
- System Settings → Network Settings → Quick Settings
- System Settings → Initial Installation Settings → Network Quick Settings

The following settings are independent. Even if you have OAuth 2.0 authentication in other SMTP authentication settings, OAuth 2.0 authentication must be obtained separately.

- System settings → System Control → E-mail Alert and Status → SMTP Settings

POP Authentication Settings

The following settings are available for POP authentication, and the setting method is the same for all cases.

- System Settings → Image Send Settings → Internet Fax Settings → Server Settings
- System Settings → Printer Settings → E-mail Print Settings
- System Settings → System Control → E-mail Alert and Status → E-mail Status (Advanced Tab)

This section describes how to obtain a token in System Settings → Image Send Settings → Internet Fax Settings → Server Settings.

1

Tap "Settings (Administrator)" → "System Settings" → "Image Send Settings" → "Internet Fax Settings" → "Server Settings".

2

Configure necessary settings such as "POP3 Server", "Port Number", "Check Interval", and "Enable SSL/TLS" in the settings.

3

Select "OAuth 2.0" as the Authentication Option.

4

Perform steps 4 to 6 in SMTP Authentication Settings.

All POP authentication settings are independent. Even if you have OAuth 2.0 authentication in other POP authentication settings, OAuth 2.0 authentication must be obtained separately.



DELETE A TOKEN

Delete the tokens that have been set up when using the machine with a new account in Exchange Online, etc. when the tokens have expired and can no longer be used. The settings should be configured by the administrator. Token deletion can also be configured from the web page.

Tap the [Delete] key on each SMTP or POP authentication setting screen to display a confirmation message. Tap the [OK] key to delete the token.

When the token is deleted, the "Token" display will change to [Not Retrieved].

CHECKING TOKEN STATUS

The token status can be checked under "Token" in any setting.

Display with "Token"	Description
Not Retrieved	A state in which the token has not been obtained.
Waiting for authorization	Permission to obtain a token has been obtained from the provider, but the machine has not completed obtaining the token.
Retrieved	The token has been obtained and is activated.
Invalid	The token has been obtained, however, the account is not available or the token is invalid because it has expired.



NAS

NAS (Network Attached Storage) is a storage device that is connected to the network. You can use part of the machine's local drive area as a simple file server to save files and browse saved files.

FOLDER STRUCTURE

The folder structure is as follows.

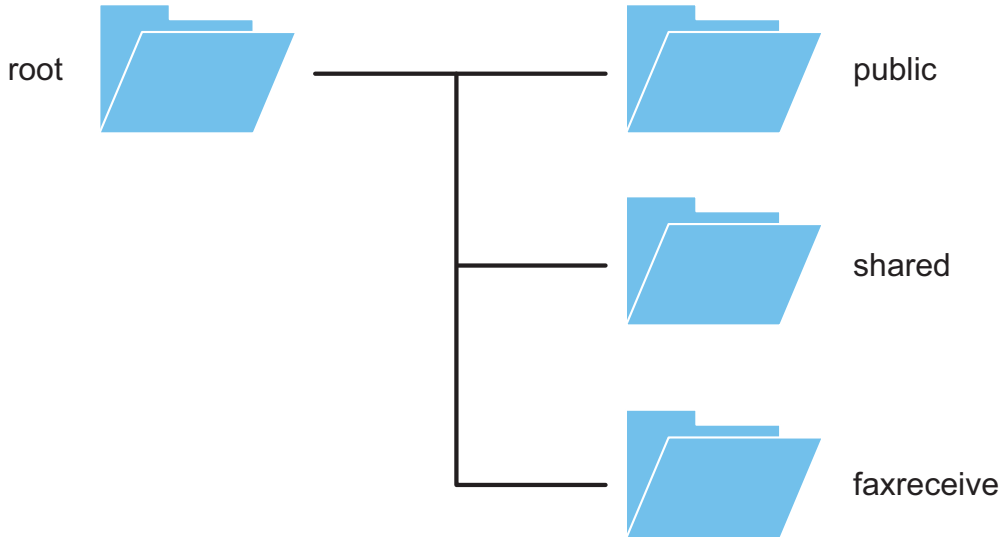

- root
- public: Area for storing PDF files for PC browsing that have been created using the document filing function.
- shared: Area where you can freely create folders.
- faxreceive: Area for storing received data using the received data local drive storage function.

Saving files in NAS / browsing NAS files

1

You can save data that you need to the machine's local drive, and view the data on your computer.

Document scanned on the machine

In document filing, tap the [Create PDF for PC Browsing] checkbox so that it is selected , and copy to the publicfolder to save the data.

▶ [File Information \(page 7-12\)](#)

Received fax data

Configure "Settings (administrator)" - [System Settings] → [Image Send Settings] → [Inbound Routing (Forwarding/Storing) Settings] → [Inbound Routing (Storage) Settings].

▶ [SAVING RECEIVED FAXES TO THE MACHINE'S STORAGE \(INBOUND ROUTING\) \(page 5-69\)](#)

2

Using as a file server / browsing saved files.

To use this, open any folder screen on your computer and enter the IP address of the machine after "\\" in the address bar (example: \\192.168.1.28).



- Access restrictions are set for each folder, so you must enter the login name and password of the administrator account or of a user account that has been registered in the machine.
- The maximum size per file is 2 GB.



REMOTE OPERATION OF THE MACHINE

Remotely operate the machine on your computer or mobile device such as smartphone.

You can operate the machine from the same panel as the machine's operation panel that is displayed on your PC, with the same feel as operating in front of the machine.

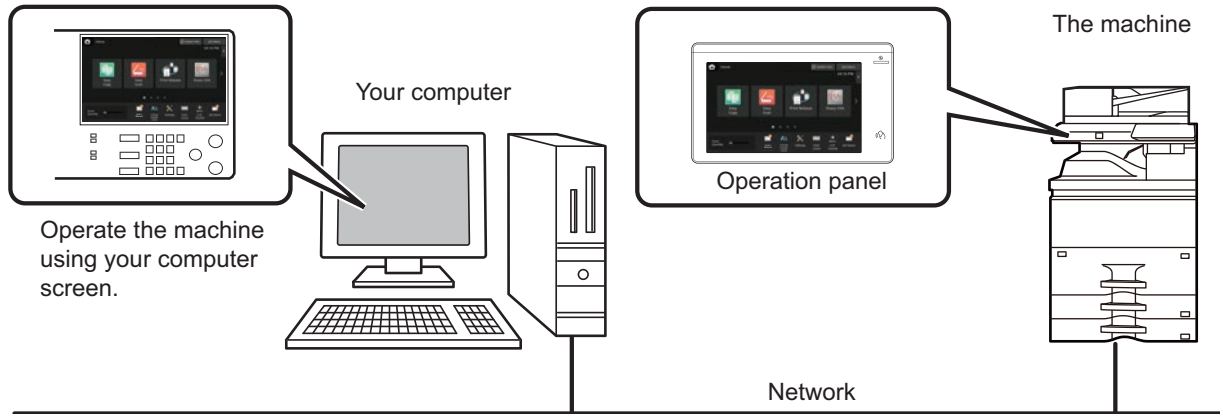

The remote operation function can only be used on one device at a time.

Before you can use the remote operation function, the following preparation is required.

- In "Settings (administrator)", select [System Settings] → [Common Settings] → [Operation Settings] → [Condition Settings] → [Remote Operation Settings] → [Remote Software Operation] and select [Allow] for [Operational Authority].
 - Connect the machine to the network.
 - Install a VNC application software (recommended VNC software: RealVNC) in your device.
- After the preparation is completed, follow the operation described below to set up the function.



Example: RealVNC®

1

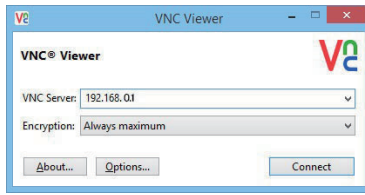

Start the VNC viewer, enter the IP address of the machine in the "VNC Server" entry box, and click the [Connect] button.



Check with the administrator of the machine for its IP address.

2

Follow the message on the operation panel of the machine to permit the connection.

When the machine is connected to a VNC application software,  appears on the system bar of the machine's touch panel.

If you wish to disconnect, exit the VNC application software or tap .



Use the operation panel in the same way as you would on the machine. However, you cannot enter values in series by continuously clicking the key.



Sharp OSA

Sharp OSA (Open Systems Architecture) is an architecture that directly links the machine to software applications for work (external applications) over a network.

When you use a machine that supports Sharp OSA, you can link controls on the operation panel and device functions such as scan send to external applications.

APPLICATION COMMUNICATION

This module enables you to link the machine with a scanner application and other standard applications. Set a standard application in "Settings (administrator)" and "Sharp OSA".

1

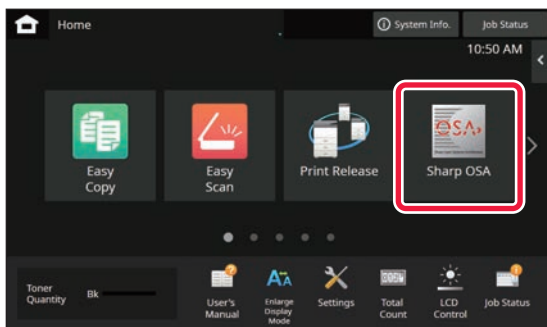

Tap the [Sharp OSA] key in the Home screen.

If no standard applications have been stored, the key cannot be tapped.

2

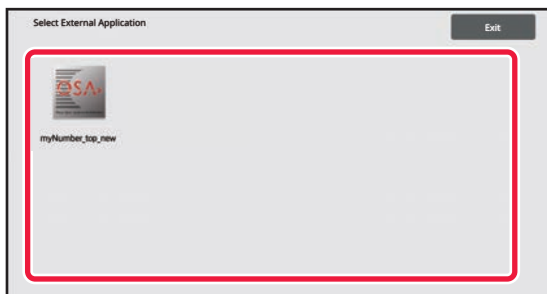

Select a standard application.

If two or more standard applications have been stored, the screen for selecting a standard application will appear. Tap the standard application that you wish to use.

If only one standard application has been stored, connection to the standard application will begin.

3

Connect the machine to the standard application.

The message "Connecting to the external application." appears while the machine communicates with the standard application.



EXTERNAL ACCOUNT APPLICATION

The external account module enables you to use an "external account application" for centralized account management of an MFP on a network.

An "external account application" can be used in "external authentication mode" or "external count mode".

When "external authentication mode" is used, the login screen is retrieved from the application when the machine is started. When a job ends, a job notification screen is sent to the application for counts by authenticated user. When "external count mode" is used, the login screen is not displayed when the machine is started. Only a job result notification is sent to the application. User authentication by the external account application cannot be used. However, the external account application can be used in combination with the internal account function.

External account application setup

After setting an external application in "Settings (administrator)", restart the machine to enable the setting.

To restart the machine, see "[TURNING ON THE POWER \(page 1-10\)](#)".

Operation in external account mode

The following describes operation in the two modes for using an external account application.

External authentication mode

When the machine is powered on in external authentication mode, the machine accesses the external account application and displays the login screen. The login screen also appears when the [Call] key is tapped to run a job in the job status complete screen. (The login screen does not appear if the user has already logged in by the normal method.) Tap the job status display while the login screen is displayed, and the Job Status screen appears. To return to the previous screen, tap a mode select key.



- The user control function of the machine cannot be used in external authentication mode. However, "User Registration", "User Count Display", "User Count Reset", "User Information Print", and "The Number of User Name Displayed Setting" can be used.
- The mode select key cannot be used while the login screen appears.

If login fails:

If the login screen fails to appear or the application does not operate correctly, the machine may also stop operating correctly. In that case, terminate external account mode forcibly.

External count mode

Unlike in external authentication mode, when the machine is started in "external count mode", the login screen of the external account application is not displayed after the machine has started up. Only the job result is sent to the external account application.

External count mode can be used together with the user control function of the machine. (External count mode can also be used when the user control function is disabled.)



VIRUS SCAN

When this machine is connected to a network environment, it may be exposed to viruses and other attacks from outside. It is also possible to be infected with a virus via a USB memory device. There is a concern that a virus infecting the device may spread to other devices. By installing a virus detection kit, viruses can be detected and dealt with at an early stage to prevent the spread of virus infection.



- The machine must be connected to a network and have access to the Internet. Connect to a LAN using the LAN connector of the machine or the wireless LAN function, and make the necessary settings by referring to "[Network Settings \(page 10-158\)](#)". Also, see "[Port Control \(page 10-185\)](#)", and the HTTPS client port must be set to "Enabled". In addition, if necessary, configure "[Proxy Setting \(page 10-175\)](#)".
- The virus scan settings are configured in [Virus Scan Setting] in [Security Settings]. The first time you enter [Virus Scan Setting], the software license agreement screen will appear. Read and agree to the terms of the agreement before using the virus detection kit.

VIRUS SCAN/VIRUS DEFINITION UPDATE TIMING AND TARGET DATA

This section describes the timing of virus scan and virus definition file updates and the target data for scanning.

Virus scan timing

The virus scan starts at the following timings.

During the virus scan,  icon will be displayed in the System Area and in the machine information of the System Information screen.

Scan during installation and update

Scans for viruses during firmware updates, embedded application installation and updates.



Real time scan

This function scans for viruses during the input and output of data from the machine. This function can be used when [Perform Virus Scan on Input-Output Data] is enabled in [Virus Scan Setting] of the system settings.

Regular scan

Scans for viruses at a fixed date and time. This function can be used when [Perform Virus Scan at Specified Time] is enabled in [Virus Scan Setting] of the system settings. The date and time can be set in [Time Schedule] under [Virus Scan Setting].

On-demand scan

You can run a virus scan immediately. When  is displayed in the virus scan of the machine information on the System Information screen, tap , and then tap [Scan Now] to execute the scan. You can also select [Perform Virus Scan Now] under [Virus Scan Setting] in the system settings to execute the scan.

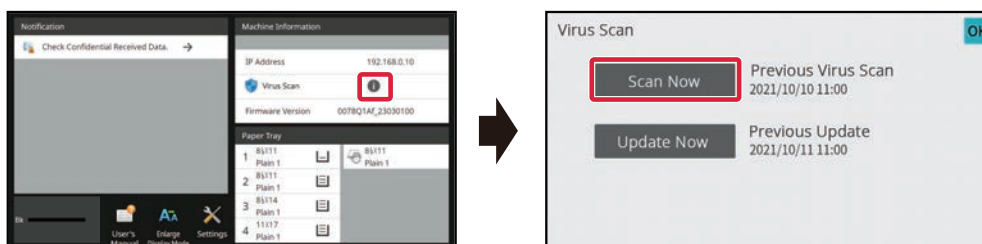



Update timing for virus definition files

You can update the virus definition file at the following time.

Regular update

Automatically updates and keeps virus definition files in the latest state.

On-demand update

You can update the virus definition file immediately. When **i** is displayed in the virus scan of the machine information on the System Information screen, tap **i** and then tap [Update Now] to update the virus definition file. You can also update the virus definition file by selecting [Perform Update Now] in [Virus Scan Setting] in the system settings.

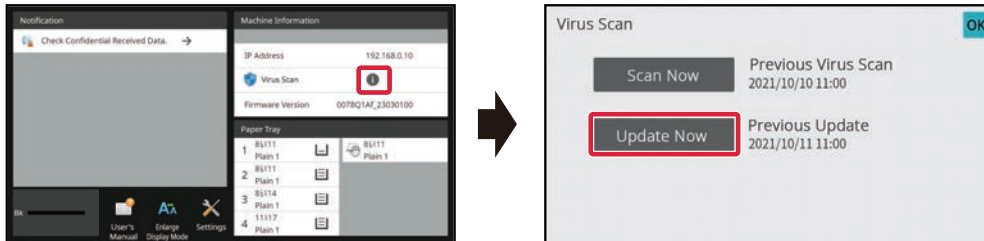

Target data for virus scan

The following data will be scanned for viruses.

- Firmware for the machine
- Embedded applications
- Input/output data of the machine (job data, configuration data of the machine, address book data, input/output data of document filing)
- Data stored in the machine's NAS folder (shared folder, faxreceive folder)

Combination of target data and virus scan

The combinations of target data and virus scan are as follows.

	Scan during installation and update	Real time scan	Regular scan	On-demand scan
Firmware for the machine	Yes	No	Yes	Yes
Embedded applications	Yes	No	Yes	Yes
Input/output data of the machine	No	Yes	Yes*	Yes*
Data stored in the NAS folder	No	No	Yes	Yes

* As for the input/output data of the machine, the data stored in the storage will be targeted for regular scan and on-demand scan.



WHEN A VIRUS IS DETECTED

Displayed in the System Information screen

When a virus is detected by the virus scan, the following screen will be displayed on the System Information screen.

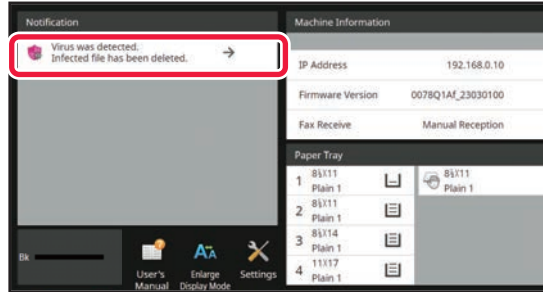

An icon  will also appear in the System Area to indicate that a virus has been detected.

If a virus is detected, stop using the machine and take anti-virus countermeasure.

When you tap on the list of "Notification" will display the deleted message and information about the virus, if deleted, the date and time of detection, the type of target data, and the target file name or the application name.

If the virus detection kit has already taken action against the virus, tap [Delete Notification] to clear the message from "Notification".

If administrative rights are required to remove the virus, a message will appear with information about the virus, the date and time of detection, the type of target data, and the target file name or the application name, along with a message to contact the administrator.

If you need confirmation from the administrator, tap [Delete Notification] to display the administrator's login screen, and after logging in, the message will be cleared.



Even if multiple viruses are detected, only one line will be displayed in "Notification". After the first message is deleted from "Notification", the contents of the next virus will be displayed on the same line in "Notification".

When a virus is detected, the machine will proceed as follows.

If the target data is the firmware of the machine

<p>Scan during installation and update</p>	<p>The update will be canceled and the touch panel will display that the updated file is damaged. After the user confirms the contents and closes the screen, the machine will operate with the firmware before the update.</p> <p>If the firmware was updated remotely, the update will be canceled and the virus detection information will be displayed in the "Notification" of the System Information screen. The machine will operate with the firmware before the update</p>
<p>Regular scan/On-demand scan</p>	<p>The message is displayed in the " Notification" of the System Information screen about the virus detection and the need to consult a service representative. The machine will continue to operate.</p>



If the target data is an embedded application

<p>Scan during installation and update</p>	<p>Installation and update via Application Portal/USB memory Cancel the installation/update, and the touch panel will display that a virus has been detected. When updating, the user confirms the contents, closes the screen and then the application operates as before the update.</p> <p>Installation and update via Web page Cancel the installation/update, and display the virus detection on the web page. When updating, the machine will operate with the application before the update.</p> <p>When updating the firmware Checks when the machine is started up after update of the firmware. The update is canceled and the virus detection message is displayed in the "Notification" of the System Information screen. The application that detected the virus will be deleted.</p>
<p>Regular scan/On-demand scan</p>	<p>The virus detection message is displayed in the "Notification" of the System Information screen.</p>

When the target data is the input/output data of the machine

<p>Real time scan</p>	<p>When a virus is detected with respect to the input data, the touch panel will display that a virus has been detected, the input data or the job to be input will be canceled, and the data or job data that was about to be output will be discarded. Data in the data input source (USB memory, external server, etc.) will not be deleted.</p> <p>When a virus is detected with the output data, the touch panel will display that a virus has been detected, the output data or the job to be output will be canceled, and the output data or job data will be deleted.</p> <p>The virus detection message will be displayed in the "Notification" of the System Information screen.</p>
<p>Regular scan/On-demand scan</p>	<p>The virus detection message is displayed in the "Notification" of the System Information screen.</p>

If the target data is data stored in a NAS folder

<p>Regular scan/On-demand scan</p>	<p>Delete the detected data. A message will be displayed in the "Notification" of the System Information screen with the contents of the infected data deleted because a virus was detected.</p>
------------------------------------	---



Any files on the NAS folder that are detected to have a virus will be deleted, so be sure to back up your files before you get infected with a virus. Also, do not save important files in the NAS folder.

If "Audit Log" and "E-mail Alert" are enabled, when a virus is detected, it will be logged and an e-mail alert will be sent.

"Audit Log" of virus scan

For more information about "Audit Log", see "[Audit Log \(page 10-196\)](#)" in system settings.

E-Mail Alert

The subject line of the detected virus and the virus information are reported in the body of the e-mail. For more information about e-mail alerts, see "[E-mail Alert and Status \(page 10-212\)](#)" in system settings.



UPDATING THE VIRUS DEFINITION FILE

Updates the virus definition file at the following timings.

- **When the machine starts up**
Updates the virus definition file when the machine starts up. If virus scan is performed at startup, the virus definition file is updated before scanning.
- **Regular update**
Update virus definition files automatically to keep the files in the latest state. It updates automatically, so no settings are required.
- **On-demand update**
The virus definition file is updated using the machine information on the System Information screen or [Perform Update Now] in the Virus Scan Setting.

When the virus definition file update fails

When the virus definition file update fails, the following screen appears on the System Information screen.

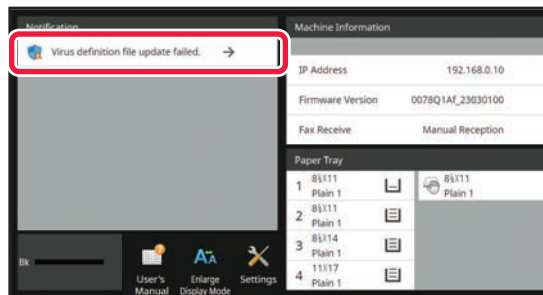

In addition, an icon  will be displayed in the System Area to indicate that the virus definition file update has failed. As for the status, the reason for the update failure will be displayed in the "Notification" section of the System Information screen, check the details.

- Server connection error (cannot connect to the Internet / server not found)
- Download failure (communication error / received data damaged, etc.)
- System time error (the time on the device and the time on the server side are off by more than 24 hours)
- Authentication failure (server authentication failure)



When "Audit Log" is enabled, failure to update virus definition files is logged.



UNIVERSAL DESIGN IN THE MACHINE

UNIVERSAL DESIGN IN THE MACHINE

The structure of the machine and the software are designed to allow all people to use the machine with ease.

UNIVERSAL DESIGN RELATED TO OPERATION

Adjustment of operation panel angle

The angle of the entire operation panel can be adjusted to enable use even when seated.

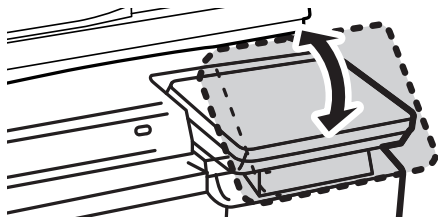

Grip handle on paper trays

The grip-type handles allow easy use from above or below. By simply placing your hand on a handle and pulling forward, the lock releases. The trays can be manipulated in a natural manner. (excluding a large capacity tray)

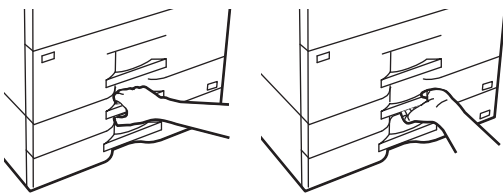

Changing of key response time

The response time of the keys can be changed as needed.

In "Settings" (administrator), select [System Settings] → [Common Settings] → [Operation Settings] → [Condition Settings] → [Key Operation Setting].

- **Time for Accepting Key Entry**

This setting determines how long a key in the touch panel must be tapped until the key input is registered. The time can be set from 0 to 2 seconds in increments of 0.5 seconds.

By lengthening the time setting, key input can be prevented when a key is tapped accidentally. Keep in mind, however, that when a longer setting is selected more care is required when tapping keys to ensure that key input is registered.

- **Disable Auto Key Repeat**

This is used to disable key repeat.

Key repeat causes a setting to change continuously not only each time the key is tapped but while a key is tapped.

- **Long-touch Detection Time**

Select a time when a long key touch is detected.

- **Double Tap Speed Interval**

Select an interval when a double tap is detected.



Confirmation of placement of original in document feeder

The original setting lamp lights up when the original is correctly set on the original setting table.

Even for users who have difficulty confirming that the original is set on the original setting table, the original setting lamp can be turned on to confirm that the original is set correctly.

UNIVERSAL DESIGN RELATED TO VISION

Changing of text size

The size of the text on the touch panel can be changed. When the text on the touch panel is small and difficult to read, the text can be enlarged.

In "Settings" (administrator), select [System Settings] → [Common Settings] → [Operation Settings] → [Condition Settings] → [Enlarge Display Mode].

- **Enlarge Display Mode**

Displays large characters on the screen.

 appears in the system area when Enlarge Display Mode is enabled.

UNIVERSAL DESIGN RELATED TO HEARING

Audible alert sounds when changing settings

When moving through copy ratio or exposure settings, the user is alerted by an audible sound at the default setting (copy ratio 100%, exposure 3).

In "Settings (administrator)", select [System Settings] → [Sound Settings] → [Beep Sound Settings (Common)] → [Keys Touch Sound] and [Reference Tone].

- **Keys Touch Sound**

Control the key touch sound level, or turns the sound off. You can also have two peeps sound at initial values when setting the ratio in copy mode or when adjusting the exposure in any mode.

Screen in which setting is effective	Initial value
Ratio setting screen in base screen of copy mode	Ratio 100%
Exposure setting screen in base screen of copy mode	Exposure level: 3 (medium)
Exposure adjustment screen in base screen of fax, Internet fax, and network scanner modes	
Exposure adjustment screen for Scan to local drive in document filing mode	

- **Make Key Touch Sound at Default Setting**

When you specify the exposure in the exposure adjustment screen of each mode, a bleep sounds two times when the reference value is reached.



UNIVERSAL DESIGN FEATURES

The machine has design features and settings that are compatible with universal design.

Easy-to-use user interface

- **Easy mode**

This mode shows only frequently used items. Buttons and text are enlarged to increase ease of operation. Almost all regular operations can be completed using the easy mode screen.

- ▶ [COPY MODE \(page 3-3\)](#)

- ▶ [FAX MODE \(page 5-6\)](#)

- ▶ [NETWORK SCANNER MODE \(page 6-7\)](#)

- **Customizing the home screen and adding icons**

You can add icons to the home screen. You can also change an icon image to a custom image.

Add an icon image in "Settings (administrator)" - [System Settings] → [Home Screen Settings] → [Icon].

To add an icon to the home screen, add a key in "Settings (administrator)" - [System Settings] → [Home Screen Settings] → [Condition Settings] → [Home Button]/[Fix Key].

- **Customizing the home screen - changing the display order**

You can change the order of the items in the home screen so that the items you use most frequently appear first.

To change the order of the items in the home screen, change in "Settings (administrator)" - [System Settings]

→ [Home Screen Settings] → [Condition Settings] → [Home Button].

- **Customizing the home screen - intuitive and easy-to-use design**

A flat icon design is used to make the screen intuitive and easy to view. The toner level is always shown, eliminating the need to perform an action to check the toner level.



For the procedures for editing the home screen, see "[EDITING THE HOME SCREEN \(page 2-17\)](#)".

- **High-contrast display (UD pattern)**

The touch panel image can be set to high contrast.

Select [Pattern 7] in "Settings (administrator)" - [System Settings] → [Common Settings] → [Operation Settings]

→ [Condition Settings] → [MFP Display Pattern Setting].

- **Multi-language display**

The language used in the touch panel can be changed to another language such as English or French.

Select the desired language in "Settings (administrator)" - [System Settings] → [Common Settings] → [Operation Settings] → [Condition Settings] → [Display Language Setting].



Intuitive operation

- **Use the QR code to view the User's Manual page.**

Tap the [User's Manual] key on the home screen of the touch panel to display a QR code that indicates the page containing the user's manual.

You can read the QR code with your mobile device to easily view the corresponding page.

- **Easy operation by storing programs**

The program function lets you store groups of settings for copying, fax, and other functions. By storing groups of settings that you frequently use, you can easily select those settings.

[PROGRAMS \(page 3-140\)](#)

[STORING FAX OPERATIONS \(PROGRAM\) \(page 5-74\)](#)

[STORING SCAN OPERATIONS \(PROGRAM\) \(page 6-94\)](#)

- **Remote operation**

You can display the machine's touch panel on a computer on the same network to operate the machine from the computer. You can show how to use the machine on a computer, and people who have difficulty using the touch panel can operate the machine from a computer.

[REMOTE OPERATION OF THE MACHINE \(page 9-43\)](#)

Easier operation at the machine

- **Darkened output tray color**

Output tray colors are darkened to make it easy to distinguish the tray to which a job has been output.

- **On right side of operation panel**

Located on the right side of the operation panel, this allows smooth removal of paper without interfering with the output tray.

Simple toner replacement

- **Toner box can be opened with one hand**

The box that contains a toner cartridge can be easily opened with one hand.



JOB LOG LIST

ITEMS RECORDED IN THE JOB LOG

The machine records the performed jobs in the job log.

The main information recorded in the job log is described below.



- To make it easy to total the usage counts of differently configured machines, the items recorded in the job log are fixed, regardless of what peripheral devices are installed or the objective of the recording.
 - In some cases, job information may not be correctly recorded, such as when a power failure occurs during a job.
-



No.	Item name	Description
1	Main items	Job ID The job ID is recorded. Job IDs appear in the log as consecutive numbers up to a maximum of 999999, after which the count resets to 1.
2		Account Job ID The job ID used in the Sharp OSA is recorded.
3		Job Mode The job mode type, such as copy or print is recorded.
4		Computer Name The name of the computer that sent a print job is recorded.*
5		User Name The user name when the user authentication function is used is recorded.
6		Login Name The login name when the user authentication function is used is recorded.
7		Card ID The card ID when it is used for an authentication process is recorded.
8		Number of Card Issuance The number of times the card has been issued is written in an SSFC IC card is recorded.
9		Main Code Main Code is recorded.
10		Sub Code Sub Code is recorded.
11		Starting Date & Time The date and time the job was started are recorded.
12		Completing Date & Time The date and time the job was completed are recorded.
13		Black & White Total Count For a print job, the total count is recorded. For a send job, the number of transmitted black & white pages is recorded. When a broadcast transmission is summarized, the total number of pages is recorded. For a scan to local drive job, the number of stored black & white pages is recorded.
14	Full Color Total Count For a send job, the number of transmitted full color pages is recorded. When a broadcast transmission is summarized, the total number of pages is recorded. For a scan to local drive job, the number of stored full color pages is recorded.	
15	Count according to size Counts by original/paper size in color mode and black & white mode are recorded.	
16	Number of sheets according to size The number of pages is logged by paper size.	
17	Main items	Invalid Paper Count The invalid sheet count is recorded.
18		Number of Reserved Sets Number of specified sets or reserved destinations is recorded.
19		Number of Completed Sets Number of completed sets or number of destinations to which transmission was successfully completed is recorded.



No.	Item name	Description
20	Main items	Number of Reserved Pages Number of reserved original pages of a copy, print, scan job, or other job is recorded.
21		Number of Completed Pages Number of completed pages of a set is recorded.
22		Result The result of a job is recorded.
23		Error Cause When an error occurs during a job, the cause of the error is recorded.
24	Print Job Related Item	Output The output mode of a printed job is recorded.
25		Staple The status of stapling is recorded.
26		Staple Count The staple count is recorded.
27		Punch The status of punching is recorded.
28		Punch Count The punch count is recorded.
29		Fold A job that uses the fold function is recorded.
30		Fold Count Number of folded pages is recorded.
31		Saddle Fold A job that uses the saddle fold function is recorded.
32		Saddle Fold Count Number of saddle folded pages is recorded.
33		Printer Tone The tone used for a print job is recorded.
34	Image Send Related Item	Address Address of an image send job is recorded.
35		Sender Name Sender name of an image send job is recorded.
36		Sender Address Sender address of an image send job is recorded.
37		Transmission Type Transmission type of an image send job is recorded.
38		Administrative Serial Number Administrative serial number of an image send job is recorded.
39		Broadcast number Broadcast number of an image send job is recorded.
40		Entry order Reservation order for broadcast transmission of an image send job is recorded. This is used to link communication and printing when recording multi polling jobs.
41		File Format File format of an image send job or scan to local drive job is recorded.
42		Sign Records whether or not an electronic signature is used in e-mail transmission.
43		Encry. Records whether or not encryption is used for e-mail transmission.
44		Compression Mode/Compression Ratio Compression mode and compression ratio of the file of an image send job or scan to local drive job is recorded.
45		Communication Time The communication time of image send jobs is recorded.
46		Fax No. The stored sender's number is recorded.



No.	Item name		Description
47	Document Filing Related Item	Document Filing	Status of document filing is recorded.
48		Storing Mode	Document filing storing mode is recorded.
49	Common Functionality	Color Setting	Color mode selected by user is recorded.
50		Special Modes	Special modes selected when the job was executed is recorded.
51		File Name	The stored file name is recorded.*
52		Data Size [KB]	The size of a file is recorded.
53	Detailed Items	Original Size	Size of scanned original is recorded. For a document filing print job, the paper size of the file is recorded.
54		Original Type	Original type (text, printed photo, etc.) set in the exposure settings screen is recorded.
55		Original Count	Number of scanned original sheets is recorded.
56		Paper Size	For a print job, the paper size is recorded. For a send job, the transmitted paper size is recorded. For a Scan to local drive job, the paper size of the stored file is recorded.
57		Paper Type	The paper type used for printing is recorded.
58		Paper Property	The paper property specified in "Paper Type" is recorded.
59		Duplex Setup	The duplex setting is recorded.
60		Resolution	The scanning resolution is recorded.
61		Machine Item	Model Name
62	Unit Serial Number		The serial number of the machine is recorded.
63	Name		The name of the machine that is set in the Web pages is recorded.
64	Machine Location		The installation location of the machine that is set in the Web pages is recorded.
65	Machine ID		Record the Machine ID entered by the service technician.

* In some environments this is not recorded.



SETTING MODE

SETTING MODE

SETTING MODE	10-3
DISPLAYING THE SETTING MODE ON THE MACHINE	10-3
DISPLAYING THE SETTING MODE (WEB VERSION)	10-4
SETTING MODE SCREEN	10-6
OVERVIEW OF SETTING MODE	10-6
SETTING METHOD	10-7

SETTING MODE LIST

SETTING MODE LIST	10-9
--------------------------------	-------------

STATUS

Status	10-29
Machine Identification	10-29
Total Count	10-30
Device Status	10-30
Network Status	10-30
Security Status	10-30
Firmware Version	10-31
Power Reset	10-31
Data List	10-31

ADDRESS BOOK

Address Book	10-34
Category Setting	10-38

DOCUMENT OPERATIONS

Document Operations	10-39
Document Filing	10-39
Submit Print Job	10-41

USER CONTROL

User Settings	10-43
User List	10-43
Custom Index	10-46
Organization /Group List	10-46
User Information Print	10-46
Access Control Settings	10-47
Pages Limit Group	10-47
Machine Page Limit Setting	10-47
Authority Group	10-48
Favorite Operation Group	10-52

User Count	10-54
View User Count	10-55
Save User Count	10-55
Billing Code Setting	10-56
Administration Settings	10-56
Main Code List	10-56
Sub Code List	10-57

SYSTEM SETTINGS

Home Screen Settings	10-59
Condition Settings	10-59
Icon	10-60
Background Image	10-60
Copy Settings	10-61
Condition Settings	10-61
Initial Status Settings	10-64
Text /Image Printing	10-65
Printer Settings	10-66
Condition Settings	10-66
Interface Settings	10-67
Initial Status Settings	10-69
PCL Settings	10-71
PostScript settings	10-71
OOXML Settings	10-72
Print Release Settings	10-72
E-mail Print Settings	10-74
Direct Print Settings (FTP)	10-76
Direct Print Settings (Network Folder)	10-77
Print Setting from PC/Mobile Terminal	10-77
Common Settings	10-78
Condition Settings	10-78
Enable/Disable Settings	10-81
Own Name and Destination Set	10-83
Category Setting	10-83
Scan Settings	10-84
Condition Settings	10-86
Initial Status Settings	10-84
Condition Settings	10-86
Default Address	10-89
Subject Name Settings	10-90
File Name Settings	10-90
Message Body Settings	10-91
Fax Settings	10-92
Condition Settings	10-92
Send Setting	10-94
Receive Settings	10-96
Fax Polling Security	10-98
F-Code Memory Box	10-99
Internet Fax Settings	10-101
Condition Settings	10-101
Send Setting	10-103
Receive Settings	10-105
Server Settings	10-107





Fax Data Receive/Forward (Manual)	10-109	Public Folder / NAS Setting	10-174
Internet Fax Settings	10-109	Proxy Setting	10-175
Reception Start	10-109	Wireless Settings	10-176
Manual Reception Key in Initial Screen	10-109	Easy Connection Setting	10-178
Forward Received Data	10-110	Bluetooth Setting	10-179
Inbound Routing (Forwarding/Storing) Settings ...	10-111	Device Web Page Setting	10-179
Inbound Routing Settings	10-111	Security Settings	10-181
Sender Address Registration	10-112	Password Setting	10-181
Administration Settings	10-112	Condition Settings	10-184
Inbound Routing (Storage) Settings	10-114	Port Control	10-185
Metadata Settings	10-115	Filter Setting	10-185
Metadata Delivery	10-115	Intrusion/Attack Detection	10-186
Metadata Set Registration	10-115	Virus Scan Setting	10-187
Edit or Delete Metadata Set	10-115	SSL/TLS Settings	10-189
Settings	10-115	S/MIME Settings	10-190
Document Filing Settings	10-116	IPsec Settings	10-191
Condition Settings	10-116	Document Administration Function	10-193
Custom Folder Registration	10-119	Hidden Pattern Print Setting	10-194
Automatic Deletion of File Settings	10-120	Tracking Information Print	10-195
Sharp OSA Settings	10-121	Audit Log	10-196
Condition Settings	10-121	Certificate Management	10-200
Standard Application Settings	10-122	Energy Save	10-202
Receiving Application Setting	10-123	Eco Setting	10-202
External Accounting Application Settings	10-123	Eco Scan Setting	10-205
Embedded Application Settings	10-124	Energy Saving Pattern List	10-206
Polling Setting	10-124	Specific Date Operation Settings	10-207
External Service Connect	10-125	Power ON/OFF Schedule Setting	10-208
Authentication Settings	10-126	Toner Save Mode	10-208
Default Settings	10-126	System Control	10-209
Administration Settings	10-131	Job Log	10-209
Actions when the user is authenticated	10-132	Data Import/Export (CSV Format)	10-209
Card Reader Settings	10-134	Storage Backup	10-210
Paper Settings	10-135	Device Cloning	10-210
Paper Tray Settings	10-135	Forward Address Book	10-210
Tray Registration	10-137	Filing Data Backup	10-211
Custom Size Registration (Bypass)	10-138	Reset Settings	10-211
Paper Type Registration	10-138	E-mail Alert and Status	10-212
Operation Settings	10-139	Enhanced FSS Settings	10-216
Condition Settings	10-139	Update of Firmware	10-216
Easy Mode Settings	10-143	Image Quality Adjustment	10-217
Favorite Key Setting	10-144	Collective Adjustment	10-217
Mode Key Display Setting	10-144	Copy Image Quality	10-218
Keyboard Settings	10-144	Print Image Quality	10-218
Custom Link Setting	10-144	Scan Image Quality	10-219
Device Control	10-145	Common Functions	10-220
Condition Settings	10-145	Initial Installation Settings	10-221
Status Indicator Setting	10-148		
Machine Identification Settings	10-148		
Clock Adjust	10-149		
Enable/Disable Settings	10-151		
Product Key/Application Number Input	10-156		
Sound Settings	10-156		
Beep Sound Settings (Common)	10-156		
Beep Sound Settings (Image Send)	10-157		
Network Settings	10-158		
Quick Settings	10-158		
Network Name Setting	10-162		
Interface Settings	10-162		
Services Settings	10-165		
Print Port Settings	10-169		
External Print Services Settings	10-171		
Universal Print Settings	10-171		
LDAP Settings	10-171		
Active Directory Settings	10-174		



SETTING MODE

SETTING MODE

"Settings" allows management of various functions that will make it easier to use the machine, such as default registration for each function, network connection setting, and log check of operation status.

Setting mode can also be selected using the Web browser by accessing the machine from a PC connected to the same network as the machine.



Administrator password

To maintain security, the machine administrator should promptly change the password after the machine is purchased. (For the default administrator password, see Start Guide.) To change the password, see "CHANGE PASSWORD".

DISPLAYING THE SETTING MODE ON THE MACHINE

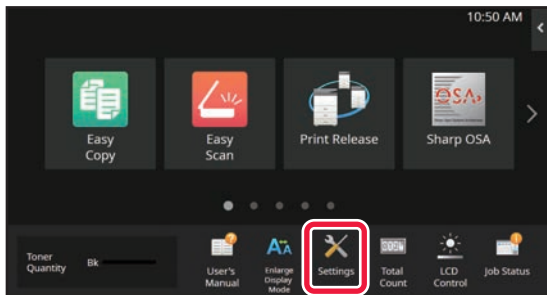
1

Tap the [Settings] key.

Tap the [Settings] key on the home screen.

The setting mode screen appears on the touch panel.

The setting menu appears at the top of the displayed screen.

Tap the setting in the menu that you want to configure.

For details of the settings, see the explanation for each item.

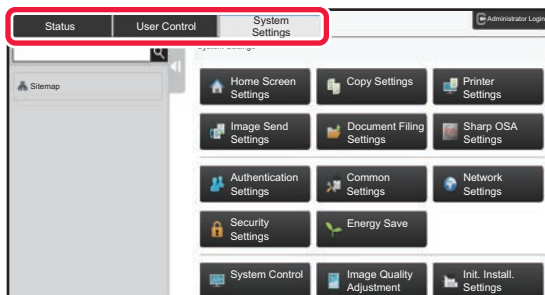
2

On the upper tab, tap the item that you want to set.

The setting menu appears on the left side of the displayed screen.

Tap the setting in the menu that you want to configure.

When you tap the [System Settings] tab, item keys appear on the screen.

When you tap the key of an item, a setting item menu appears.

(When you tap the [Image Send Settings] key, further item keys appear.)



- To quit the setting mode, tap the [Exit] key in the upper right corner of the screen.
- For details on login procedures when user authentication is enabled, see "[USER AUTHENTICATION \(page 9-12\)](#)".



DISPLAYING THE SETTING MODE (WEB VERSION)

When the machine is connected to the network, access the built-in Web server of the machine using the PC's Web browser.

From the setting mode of the machine, print the IP address of the machine and enter the address on the PC's Web browser.

1

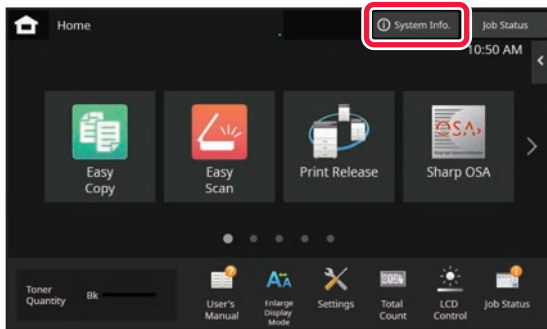

Tap the [System Info.] key

2

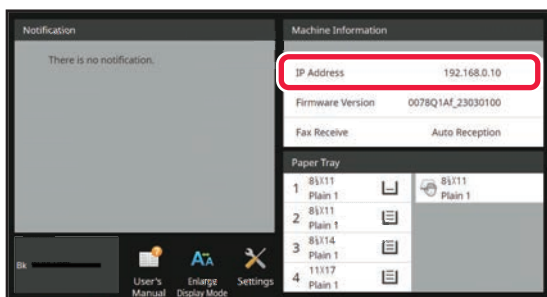

Check the IP address in the machine information.

3

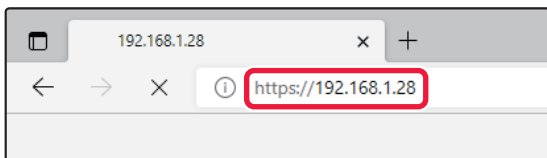

Start the Web browser on the PC, and enter the IP address of the machine.

Start a Web browser on a PC on the same network the machine is on, and enter the IP address of the machine.

Recommended Web browsers:

Microsoft Edge (Windows®),

Firefox (Windows®),

Safari (Mac OS®)

Chrome (Windows®)

Latest version and previous major release

Displays the setting mode (Web version).

In the factory default state, the user password must be entered.

Depending on the machine settings, user authentication may be required to display the setting mode (Web version).

For password and other information required for user authentication, contact the administrator of the machine.



4

Select a login name and enter your password.

Entering a password

- If you click an item that requires administrator rights, the password entry screen will appear regardless of the settings. Select a user that has administrator rights and enter the user password.
- If user authentication is not enabled, you can set the login name to "Administrator" and enter the administrator password to log in to the Web page. Once you have logged in to the Web page with administrator rights, the password entry screen will not appear when you click other items that require administrator rights (until you log out).



At the bottom of the login screen you will find links to download manuals, such as the User's Manual, and the latest printer drivers.



SETTING MODE SCREEN

This section describes typical items in the operation method in the setting mode.

OVERVIEW OF SETTING MODE

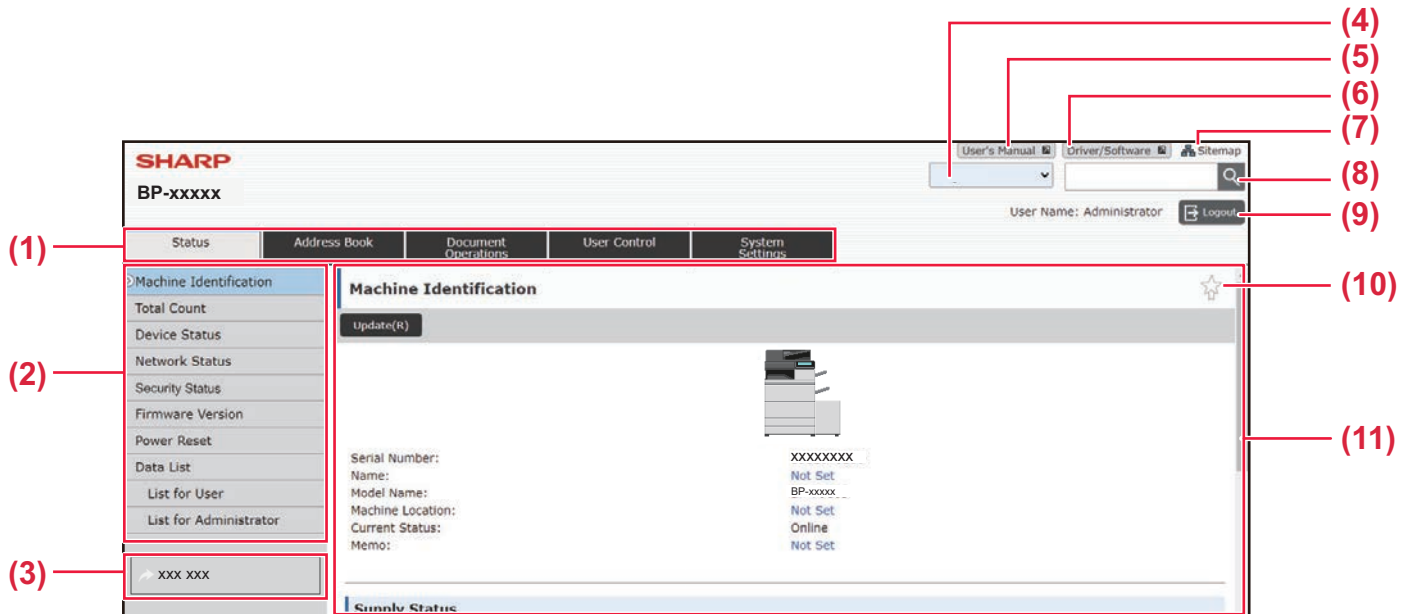

(1) Menu tab

This tab shows the first level of the setting menu. Click this tab to show the tab's setting items in the setting menu.

Some settings such as the system settings do not appear in the setting menu when the tab is clicked. Instead, further setting item buttons appear in the setting area.

(2) Setting menu

This shows the items that can be set on the web page. The items are in a tree structure.

When you click an item that requires machine administrator rights, the password entry screen appears. Select the previously registered login name and enter the password.

(3) Custom links

You can register custom links in advance to show the custom links in the setting menu.

► [Custom Link Setting \(page 10-144\)](#)

(4) Language

Set the language that appears on the web page.

(5) User's Manual

Go to the website of the instruction manual in PDF format such as the user's manual.

(6) Driver/Software

Go to the website where you can download the printer driver and software.

(7) Sitemap

This shows a sitemap of the website.

(8) Search

Use this to search for setting items and other information. Enter the item you want to find in the text box and click .

(9) [Login/Logout] button

[Login] button

Click to log in to the web page.

[Logout] button

When you have completed all settings in the web pages, click this button to log out and exit the web browser.

(10) Shortcut icon

Click this icon to register a page you want to show on the shortcut tab.

(11) Setting area

This shows the setting screen of the item selected in the setting menu at left.



SETTING METHOD

This section explains the basic procedure for configuring settings using "Home Screen Settings" as an example. This setting is used to change the background image of a home screen to an image provided by the user.

1

Connect to the web page as explained in "[DISPLAYING THE SETTING MODE \(WEB VERSION\) \(page 10-4\)](#)".

2

Display the "Home Screen Settings" setting screen.

(1) Click the [System Settings] tab ().

The setting items of the system settings appear in the setting area.

(2) Click the [Home Screen Settings] button ().

3

Click [Background Image] in the setting menu and set the background image.

(1) Click [Background Image] in the setting menu.

(2) Click the [Change] button in "Background Image".

The "Register Background Image" screen appears.

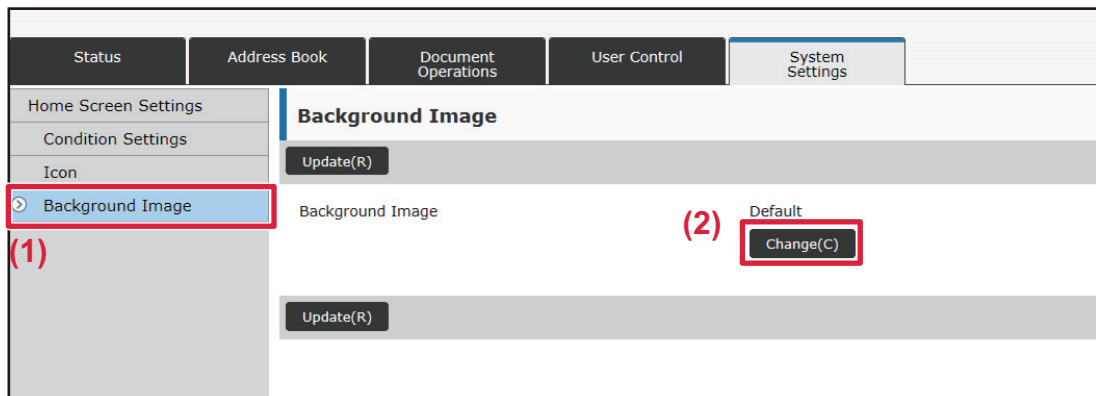



4

Select "Use Custom Image" and click the [Browse] button to select the desired image.

- (1) Check the "Use Custom Image" checkbox
- (2) Click the [Browse] button.

When you click the [Browse] button, the file selection screen appears. Select the file of the desired background image.

5

Click the [Submit] button.

Path

6

If you have another item you want to set, configure the setting from the setting menu or menu tab.



If you use the "Forward" or "Back" function of the web browser to move to a different item, the item that you set may not be saved. Use the setting menu or menu tab to move to a different item.

7

When you have finished configuring settings, click the [Logout] button and exit.

When you exit the settings, a message may appear on the touch panel of the machine. Read and then close the message.



SETTING MODE LIST

SETTING MODE LIST

Click the link file to see the details of each description.

In the setting mode, there are some that can be set only on the Web page and some that can be set only on this machine.

*1 Only web pages can be set.

*2 Items that can be set only in the setting mode of this machine.

*3 For more information on settings, consult a qualified service technician.



Depending on the machine specifications and peripheral devices installed, it may not be possible to use settings.

■ Status

● Status

- ▶ Machine Identification
- ▶ Total Count
- ▶ Device Status
- ▶ Network Status
- ▶ Security Status
- ▶ Firmware Version
- ▶ Power Reset
- ▶ Data List
 - ◆ List for User
 - ◆ List for Administrator

■ Address Book*1

● Address Book

- ▶ Category Setting

■ Document Operations*1

● Document Operations

- ▶ Document Filing
 - ◆ Main Folder
 - ◆ Quick File Folder
 - ◆ Custom Folder
 - ◆ My Folder
 - ◆ File Batch Print
- ▶ Submit Print Job
 - ◆ Print Settings



■ User Control-User Settings

● User Settings

- ▶ User List
- ▶ Custom Index
- ▶ Organization /Group List
- ▶ User Information Print

■ User Control-Access Control Settings

● Access Control Settings

- ▶ Pages Limit Group
- ▶ Machine Page Limit Setting
- ▶ Authority Group
- ▶ Favorite Operation Group*¹
 - ◆ Favorite Operation Group List
 - ◆ Favorite Key List
 - ◆ Home Screen List

■ User Control-User Count

● User Count

■ User Control-Billing Code Setting

● Billing Code Setting

- ▶ Administration Settings
 - ◆ Use Billing Code
 - ◆ Use Code Settings
 - ◆ Take Over Billing Code at Mode Transition
 - ◆ Disable Change of Billing Code.
 - ◆ Apply Use Code While Logged in with Device Account
 - ◆ Exception Setting for Billing Code Function
 - ◆ Billing Code Display Name Setting
- ▶ Main Code List
- ▶ Sub Code List



■ System Settings-Home Screen Settings

● Home Screen Settings

- ▶ Condition Settings
 - ◆ Home Screen Registration
- ▶ Icon
- ▶ Background Image

■ System Settings-Copy Settings

● Copy Settings

- ▶ Condition Settings
 - ◆ Rotation Copy Setting
 - ◆ Disable Copy in Different Size
 - ◆ Add or Change Extra Preset Ratios
 - ◆ Setting a Maximum Number of Copies
 - ◆ Stamp
 - ◆ Initial Margin Shift Setting
 - ◆ Erase Width Adjustment
 - ◆ Initial Multi Shot Setting
 - ◆ Card Shot Settings
 - ◆ Automatic Saddle Stitch
 - ◆ Initial Tab Copy Setting
 - ◆ Disabling of Registration/Deletion of Program
 - ◆ Disabling of Bypass-Tray in Duplex Copy
 - ◆ Disabling of Auto Paper Selection
 - ◆ Auto Selection Setting of Tray that is Supplied the Paper
 - ◆ Disabling Registration of Custom Image
 - ◆ Disabling sending while copying
 - ◆ High Quality Scan from Document Feeder
 - ◆ Quick Scan from Document Glass
 - ◆ Auto Clear Before Copy Execution Also
 - ◆ Display Warning Message when Original is not Detected
- ▶ Initial Status Settings
- ▶ Text /Image Printing
 - ◆ Text Settings (Stamp)
 - ◆ Custom Stamp
 - ◆ Custom Watermark



■ System Settings-Printer Settings

● Printer Settings

- ▶ Condition Settings
 - ◆ Prohibit Notice Page Printing
 - ◆ Prohibit Test Page Printing
 - ◆ A4/Letter Size Auto Change
 - ◆ A3/Ledger Size Auto Change
 - ◆ Bypass Tray Settings
 - ◆ Job Spool Queuing
 - ◆ Disabling of USB Memory Direct Print
 - ◆ Disabling of Network Folder Direct Print
 - ◆ Disabling sending while printing
- ▶ Interface Settings
 - ◆ Hexadecimal Dump Mode
 - ◆ I/O Timeout
 - ◆ Enable Network Port
 - ◆ Network Port Emulation Switching
 - ◆ Port Switching Method
- ▶ Initial Status Settings
- ▶ PCL Settings
- ▶ PostScript settings
- ▶ OOXML Settings
- ▶ Print Release Settings
 - ◆ Standard
 - ◆ Advanced Settings
- ▶ E-mail Print Settings
 - ◆ E-mail Print
 - ◆ POP3 Server
 - ◆ Port Number
 - ◆ Authentication Option
 - ◆ Provider
 - ◆ Account Name
 - ◆ Token
 - ◆ Get Token / Delete
 - ◆ User Name
 - ◆ Password
 - ◆ Check Interval
 - ◆ Enable SSL/TLS
- ▶ Direct Print Settings (FTP)
 - ◆ FTP Server Registration
- ▶ Direct Print Settings (Network Folder)
 - ◆ Registration of Network Folder



- ▶ Print Setting from PC/Mobile Terminal
 - ◆ FTP Print
 - ◆ Port Number
 - ◆ IPP Print (Driverless)
 - ◆ geo URI (RFC5870)



■ System Settings-Image Send Settings-Common Settings

● Common Settings

▶ Condition Settings

- ◆ Hold settings for a while after scanning has been completed.
- ◆ Job Auto Start Time During Scanning
- ◆ Default Display Settings
- ◆ Address Book Default Selection
- ◆ Image Orientation
- ◆ Preview Setting
- ◆ Default List/Thumbnail Display
- ◆ Default Exposure Settings
- ◆ Default Original Image Type
- ◆ Erase Width Adjustment
- ◆ Time Specified Output of Received Data

▶ Enable/Disable Settings

- ◆ Settings to Disable Registration
- ◆ Settings to Disable Transmission
- ◆ Disabling of PC Scan
- ◆ Disable Storing to External Memory Device
- ◆ Disable PC-I-Fax Transmission
- ◆ Disable PC-Fax Transmission
- ◆ Disabling of Find My Address
- ◆ Disabling of OCR

▶ Own Name and Destination Set

- ◆ Sender Data Registration
- ◆ Registration of Own Name Select
- ◆ Sender Name List

▶ Category Setting^{*2}



■ System Settings-Image Send Settings-Scan Settings

● Scan Settings

- ▶ Initial Status Settings
 - ◆ Default Color Mode Settings
 - ◆ Initial File Format Setting
 - ◆ Easy Scan Settings
 - ◆ Resolution Setting
 - ◆ Original Skew Adjustment
- ▶ Condition Settings
 - ◆ Default Reply.Address Set
 - ◆ Bcc Setting
 - ◆ Quick On Line Sending
 - ◆ PDF Compression Options
 - ◆ Highly compressed PDF resolution settings
 - ◆ Compression Mode at Broadcasting
 - ◆ Send Destination Link Settings
 - ◆ Maximum Size of Send Data (E-Mail)
 - ◆ Maximum Size of Send Data (FTP/Desktop/Network Folder)
 - ◆ Auto Scan Setting
 - ◆ Preset restriction of E-mail for direct input
- ▶ Default Address
 - ◆ Default Address Setting
 - ◆ Add Selected
- ▶ Subject Name Settings
 - ◆ Default Subject
 - ◆ Pre-Set Registration
- ▶ File Name Settings
 - ◆ Default Settings for File Names
 - ◆ Direct Entry/Pre-Set Text Selection Settings
 - ◆ Pre-Set Registration
- ▶ Message Body Settings
 - ◆ Add Job Information Automatically to the Mail Message Body
 - ◆ Add a Footer Automatically to the Mail Message Body
 - ◆ Mail Footer Registration
 - ◆ Message Body Settings



■ System Settings-Image Send Settings-Fax Settings

● Fax Settings

- ▶ Condition Settings
 - ◆ Resolution Setting
 - ◆ Dial Mode Setting
 - ◆ Auto Wake Up Print
 - ◆ Pause Time Setting
 - ◆ Fax Dest. Confirmation Mode
 - ◆ Remote Reception Number Setting
 - ◆ Display Fax Screen when External Telephone is Off-hook
 - ◆ Transaction Report Print Select Setting
 - ◆ Activity Report Print Select Setting
 - ◆ Super G3 Setting
 - ◆ ECM
 - ◆ Digital Line Network
 - ◆ Distinctive Ring Detection
- ▶ Send Setting
 - ◆ Auto Reduction Sending Setting
 - ◆ Rotation Sending Setting
 - ◆ Quick On Line Sending
 - ◆ Printing Page Number at Receiver
 - ◆ Sender Destination Name Switch
 - ◆ Date/Own Number Print Position Setting
 - ◆ Recall in Case of Line Busy
 - ◆ Recall in Case of Communication Error
 - ◆ Disable Fax Broadcasting
- ▶ Receive Settings
 - ◆ Number of Calls in Auto Reception
 - ◆ Switching to Automatic Reception
 - ◆ 2-Sided Printing of Received Data
 - ◆ Auto Receive Reduce Setting
 - ◆ Print Style Setting
 - ◆ Set the Telephone Number for Data Forwarding
 - ◆ Letter Size RX Reduce Print
 - ◆ Receiving Date & Time Print
 - ◆ A3 RX Reduce
 - ◆ Output tray
 - ◆ Number of Prints
 - ◆ Staple Settings
 - ◆ Paper Size
 - ◆ Fold Size Setting
 - ◆ Allow/Reject Number Setting
 - ◆ Reject Unknown Calls
- ▶ Fax Polling Security
- ▶ F-Code Memory Box



■ System Settings-Image Send Settings-Internet Fax Settings

● Internet Fax Settings

- ▶ Condition Settings
 - ◆ Resolution Setting
 - ◆ Initial File Format Setting
 - ◆ Auto Wake Up Print
 - ◆ Original Print on Transaction Report
 - ◆ Print Out Error Report Only
 - ◆ Activity Report Print Select Setting
- ▶ Send Setting
 - ◆ I-Fax Reception Report On/Off Setting
 - ◆ I-Fax Reception Report Request Timeout Setting
 - ◆ Number of Resend Times at Reception Error
 - ◆ Maximum Size of Send Data
 - ◆ Rotation Sending Setting
 - ◆ Default Own Number Sending
 - ◆ Printing Page Number at Receiver
 - ◆ Recall in Case of Line Busy
 - ◆ Recall in Case of Communication Error
- ▶ Receive Settings
 - ◆ Auto Receive Reduce Setting
 - ◆ 2-Sided Printing of Received Data
 - ◆ Set Address for Data Forwarding
 - ◆ Letter Size RX Reduce Print
 - ◆ Receiving Date & Time Print
 - ◆ A3 RX Reduce
 - ◆ POP3 Communication Timeout Setting
 - ◆ Reception Check Interval Setting
 - ◆ I-Fax Output Setting
 - ◆ Allow/Reject Mail or Domain Name Setting
- ▶ Server Settings
 - ◆ Receive Settings
 - ◆ Default Settings
 - ◆ Direct SMTP Settings

■ System Settings-Image Send Settings-Fax Data Receive/Forward (Manual)

● Fax Data Receive/Forward (Manual)

- ▶ Fax Settings
- ▶ Internet Fax Settings



■ System Settings-Image Send Settings-Inbound Routing (Forwarding/Storing) Settings

● Inbound Routing (Forwarding/Storing) Settings

- ▶ Inbound Routing Settings
- ▶ Sender Address Registration
- ▶ Administration Settings
- ▶ Inbound Routing (Storage) Settings

■ System Settings-Image Send Settings-Metadata Settings

● Metadata Settings

■ System Settings-Document Filing Settings

● Document Filing Settings

- ▶ Condition Settings
 - ◆ Default Mode Settings
 - ◆ Sort Method Setting
 - ◆ Administrator Authority Setting
 - ◆ Delete All Quick Files
 - ◆ Image Orientation
 - ◆ Default Color Mode Settings
 - ◆ Default Exposure Settings
 - ◆ Default Original Image Type
 - ◆ Initial Resolution Settings
 - ◆ Default Output Tray
 - ◆ Disabling Text/Stamp printing at Reprint
 - ◆ Batch Print Settings
 - ◆ Print Order Setting for the Batch Print/Multi-File Print
 - ◆ Erase Width Adjustment
 - ◆ Card Shot Settings
 - ◆ Setting of store/delete after file print
 - ◆ Default Setting of PDF Format for PC Browsing
 - ◆ Document Output Options
- ▶ Custom Folder Registration *2
- ▶ Automatic Deletion of File Settings
 - ◆ Delete Now
 - ◆ Executing automatic deletion during Auto Power Shut-Off.



■ System Settings-Sharp OSA Settings

● Sharp OSA Settings

- ▶ Condition Settings
 - ◆ Sharp OSA version
 - ◆ Cookie Settings*2
 - ◆ Delete Cookie*2
 - ◆ Automatically Start an Application at Power up and Wake up
 - ◆ Accept remote access request from application
 - ◆ Application allowed to access
 - ◆ Approve remote access request on operation panel
 - ◆ Accept UI operation request from application
 - ◆ Display the connecting dialog while in Sharp OSA mode
 - ◆ Accept secondary send request from Sharp OSA application
- ▶ Standard Application Settings
- ▶ Receiving Application Setting
- ▶ External Accounting Application Settings
- ▶ Embedded Application Settings
- ▶ Polling Setting
- ▶ External Service Connect



■ System Settings-Authentication Settings

● Authentication Settings

▶ Default Settings

- ◆ User Authentication
- ◆ Authentication Settings
- ◆ Default Network Authentication Server Setting
- ◆ Specify network server access control
- ◆ Authentication Method Setting
- ◆ Enable Quick Login
- ◆ Device Account Mode Setting
- ◆ Login User
- ◆ Settings for Using Authentication Information
- ◆ Cache Authentication Information for External Service Connect
- ◆ Card Setting
- ◆ Disable Printing by Invalid User
- ◆ Automatic Logout Setting
- ◆ A Warning when Login Fails
- ◆ Allow Remote Scanner Using Before Login.
- ◆ Include Job Status in user authentication
- ◆ Display System Information Screen Before Login
- ◆ Enable IPP Authentication Except for Printer Driver
- ◆ Actions when the Limit of Pages for Output Jobs
- ◆ Automatically print stored jobs after login
- ◆ Reset Counter After Sending E-mail Status
- ◆ Disable display/change of other users' information in the job status
- ◆ Set Email Address of Logged In User in the From/Sender Field of E-mail
- ◆ Apply login name to the user name of network folder
- ◆ Login Name Display
- ◆ Display Usage Status after Login
- ◆ Edit Help Display of Login Screen

▶ Card Reader Settings

- ◆ Condition Settings
- ◆ Card Reader Device Registration



■ System Settings-Common Settings-Paper Settings

● Paper Settings

- ▶ Paper Tray Settings
 - ◆ Auto Tray Switching
 - ◆ Display Paper Tray Settings when bypass tray detects paper.
 - ◆ Paper Weight
 - ◆ Tray Settings
- ▶ Tray Registration
 - ◆ Select Paper Sizes for Auto Detection
- ▶ Custom Size Registration (Bypass)
- ▶ Paper Type Registration

■ System Settings-Common Settings-Operation Settings

● Operation Settings

- ▶ Condition Settings
 - ◆ Enlarge Display Mode
 - ◆ Message Time Setting
 - ◆ Language Setting
 - ◆ Default Display Settings
 - ◆ Display System Information Screen as Default
 - ◆ Display IP Address on the System Information Screen
 - ◆ Display Favorite Menus as Default
 - ◆ Display Action Panel as default.
 - ◆ Icon is displayed when network cable is not connected.
 - ◆ Display Confirmation Dialog when job is canceled.
 - ◆ Display Status Notification Message
 - ◆ Restrict Total Count display
 - ◆ Switch the Number of Sets to be Displayed for Job Status
 - ◆ Display the estimated job start time
 - ◆ Alignment Order of 10-Key
 - ◆ Setting Display from Main Unit
 - ◆ MFP Display Pattern Setting
 - ◆ Key Operation Setting
 - ◆ Disabling of Bypass Printing
 - ◆ Priority of Print Jobs
 - ◆ Disabling of Covers/Inserts Mode
 - ◆ Disable Manual Finishing
 - ◆ Disabling Recent Jobs
 - ◆ Initial Original Count Setting
 - ◆ Preview Setting
 - ◆ Remote Operation Settings
 - ◆ Data List
 - ◆ Tandem Connection Setting
- ▶ Easy Mode Settings



- ▶ Favorite Key Setting
- ▶ Mode Key Display Setting
- ▶ Keyboard Settings
 - ◆ Default Keyboard Setting
 - ◆ Keyboard Select
 - ◆ Set Keyboard Priority
 - ◆ Soft Keyboard Template Setting
- ▶ Custom Link Setting^{*1}

■ System Settings-Common Settings-Device Control

● Device Control

- ▶ Condition Settings
 - ◆ Original Size Detector Setting
 - ◆ Cancel Detection at Document Glass
 - ◆ Original Feeding Mode
 - ◆ Double Feed Detection Setting
 - ◆ Actions When Maximum Number of Sheets that can be Stapled is Reached
 - ◆ Automatic Saddle Stitch
 - ◆ Saddle Fold/Stitch Position Adjust
 - ◆ Auto Switching of Finisher Trays
 - ◆ Paper Type for Auto Paper Selection
 - ◆ Plain Paper Compatibility Settings
 - ◆ Detect Standard in Auto Color Mode
 - ◆ Total Setting for Finish
 - ◆ Disabling of Duplex
 - ◆ Disabling of Offset
 - ◆ Disabling of Stapler
 - ◆ Disabling of Punch
 - ◆ Disabling of Document Feeder
 - ◆ Disabling of Large Capacity Cassette
 - ◆ Disabling of Tray Settings
 - ◆ Disabling of Inserter
 - ◆ Disabling of Finisher
 - ◆ Disabling of Folding Unit
 - ◆ Disabling of Trimming Module
- ▶ Status Indicator Setting
 - ◆ Information Indicator Setting
 - ◆ Document Feeder Indicator Setting
- ▶ Machine Identification Settings
- ▶ Clock Adjust
 - ◆ Daylight Saving Time Setting
 - ◆ Date Format



- ▶ Enable/Disable Settings
 - ◆ Authentication Settings
 - ◆ Copy Settings
 - ◆ Printer Settings
 - ◆ Image Send Settings
 - ◆ Document Filing Settings
 - ◆ Operation Settings
 - ◆ Device Control
 - ◆ Security Settings
- ▶ Product Key/Application Number Input

■ System Settings-Common Settings-Sound Settings

● Sound Settings

- ▶ Beep Sound Settings (Common)
 - ◆ Keys Touch Sound
 - ◆ Beep of Invalid Input
 - ◆ Reference Tone
 - ◆ Copy Complete Sound
 - ◆ Scan Complete Sound (Image Send)
 - ◆ Powering Off Sound
 - ◆ Caution Sound Settings
- ▶ Beep Sound Settings (Image Send)
 - ◆ Fax
 - ◆ Internet Fax



■ System Settings-Network Settings

● Network Settings

- ▶ Quick Settings
 - ◆ Wireless Settings
 - ◆ IPv4 Settings
 - ◆ Network Name Settings
 - ◆ DNS Settings
 - ◆ SMTP Settings
 - ◆ LDAP Settings
- ▶ Network Name Setting
 - ◆ Device Name
 - ◆ Domain Name
 - ◆ Comment
- ▶ Interface Settings
 - ◆ Connection Type
 - ◆ IPv4 Settings
 - ◆ IPv6 Settings
 - ◆ DNS Settings
 - ◆ IEEE802.1X Setting
- ▶ Services Settings
 - ◆ SMTP
 - ◆ Kerberos
 - ◆ Sntp
 - ◆ mDNS
 - ◆ SNMP
- ▶ Print Port Settings
 - ◆ LPD
 - ◆ RAW
 - ◆ WSD
- ▶ External Print Services Settings
- ▶ Universal Print Settings^{*1}
- ▶ LDAP Settings
- ▶ Active Directory Settings
- ▶ Public Folder / NAS Setting
- ▶ Proxy Setting
- ▶ Wireless Settings
 - ◆ Connection Type
 - ◆ Keep Wireless Access Point activated
 - ◆ Current Setting
 - ◆ Current Wireless Status
 - ◆ Show Wireless Setting Screen
 - ◆ Initialize Wireless Settings
 - ◆ Wireless Setting screen (Access Point Mode)
 - ◆ Wireless setting screen (infrastructure mode)



- ▶ Easy Connection Setting
 - ◆ NFC
 - ◆ NFC Signal
 - ◆ QR code
 - ◆ Destination
- ▶ Bluetooth Setting
 - ◆ Bluetooth
- ▶ Device Web Page Setting
 - ◆ HTTP Access Settings
 - ◆ View Login User
 - ◆ Current Login Users
 - ◆ Log Out All Users



■ System Settings-Security Settings

● Security Settings

- ▶ Password Setting
 - ◆ Password Policy Settings
 - ◆ Password Change
- ▶ Condition Settings
 - ◆ Restrict Print Jobs other than the current Print Hold Job
 - ◆ Automatic Deletion of Suspended Print Jobs
 - ◆ Time until Suspended Print Jobs are Automatically Deleted
 - ◆ Reject Requests from External Sites
 - ◆ If Firmware Corruption is Detected, Restore It
 - ◆ Apply Security Policy
 - ◆ Mandatory Access Control
 - ◆ Job Status Jobs Completed List Display Setting
 - ◆ Job Status Display Setting
- ▶ Port Control
- ▶ Filter Setting
 - ◆ IP Address Filter Settings
 - ◆ MAC Address Filter Settings
- ▶ Intrusion/Attack Detection
- ▶ Virus Scan Setting
 - ◆ Virus Scan
 - ◆ Virus Scan Settings
 - ◆ Virus Definition File Update Setting
- ▶ SSL/TLS Settings
- ▶ S/MIME Settings
- ▶ IPsec Settings
 - ◆ Condition Settings
 - ◆ IPsec Rules
- ▶ Document Administration Function
- ▶ Hidden Pattern Print Setting
 - ◆ Initial Status Settings
 - ◆ Contrast
 - ◆ Audit Log
- ▶ Tracking Information Print
- ▶ Initialize Private Data/Data in Machine*2, *3
- ▶ Security code input*2, *3
- ▶ Audit Log
 - ◆ Audit Log
 - ◆ Storage/Send Settings
 - ◆ Save/Delete Audit Log



- ▶ Certificate Management
 - ◆ Device Certificate Management
 - ◆ Certificate Signing Request (CSR) Management
 - ◆ CA Certificate Management

■ System Settings-Energy Save

● Energy Save

- ▶ Eco Setting
 - ◆ Eco Recommendation Function
 - ◆ Display a Message to Delay the Time of Entry into Preheat Mode / Auto Power Shut-Off Mode
 - ◆ Mode Setting
 - ◆ Preheat Mode Setting
 - ◆ As soon as the remote job is finished, enter Auto power shut off mode.
 - ◆ Fix transition time.
 - ◆ Change transition time by time of day.
 - ◆ Sleep Mode Power Level
- ▶ Eco Scan Setting
- ▶ Energy Saving Pattern List
- ▶ Specific Date Operation Settings
- ▶ Power ON/OFF Schedule Setting
- ▶ Toner Save Mode

■ System Settings-System Control

● System Control

- ▶ Job Log
 - ◆ View Job Log
 - ◆ Job log Operation
- ▶ Data Import/Export (CSV Format)
 - ◆ Export Settings
 - ◆ Import Settings
- ▶ Storage Backup
 - ◆ Export Settings
 - ◆ Import Settings
- ▶ Device Cloning
 - ◆ Export Settings
 - ◆ Import Settings
- ▶ Forward Address Book^{*2}
- ▶ Filing Data Backup^{*1}
 - ◆ Export Settings
 - ◆ Import Settings



- ▶ Reset Settings
 - ◆ Restore Factory Defaults
 - ◆ Reset the NIC
- ▶ E-mail Alert and Status
 - ◆ Status Message
 - ◆ Alerts Message
 - ◆ SMTP Settings
- ▶ Enhanced FSS Settings
- ▶ Update of Firmware

■ System Settings-Image Quality Adjustment

● Image Quality Adjustment

- ▶ Collective Adjustment
 - ◆ Fusing Cleaning Mode*2
 - ◆ MC Cleaning Mode*2
 - ◆ Black Letter/Black Line Width Adjustment
 - ◆ Dark Streak Reduction
 - ◆ Display warning message for dark streaks detection.
- ▶ Copy Image Quality
 - ◆ Quick Image Quality Adjustment
 - ◆ Gray Balance
 - ◆ Density Adjustment when [Auto] is selected for Exposure
 - ◆ Sharpness
 - ◆ Image Quality Priority
- ▶ Print Image Quality
 - ◆ Quick Image Quality Adjustment
 - ◆ Gray Balance
 - ◆ Exposure Adjustment
 - ◆ Line Thickness
- ▶ Scan Image Quality
 - ◆ RGB Adjust
 - ◆ Sharpness
 - ◆ Contrast
- ▶ Common Functions*2
 - ◆ Auto Gray Calibration (for Copy)/Auto Gray Calibration (for Print)/Copy Calibration by Screen/Printer Calibration by Screen
 - ◆ Density Smoothing Adjustment

■ System Settings-Initial Installation Settings

● Initial Installation Settings



STATUS

Status

Machine Identification

The Machine Identification displays the system information of the machine.

It displays the model name, current status, and machine location.

This setting can also be set by general users, except for some items.

Item	Description
Unit Serial Number	Indicates the serial number of the machine.
Name	When you tap the [Not Set] key, the [Machine Identification] screen appears. If [Name] is not set, [Not Set] appears.
Model Name	Displays the standard model name of the machine.
Machine Location	The information entered in the [Machine Location] item in [Machine Identification] appears. If no name has been set, [Not Set] appears.
Current Status	<p>Displays the current status of the machine. If two or more errors occur at the same time, only one status is displayed according to the priority order. The errors and machine conditions are displayed in the following priority order.</p> <ul style="list-style-type: none"> • Printer error • Account Limit • Incorrect Paper • Overdue Service Maintenance • Paper jam • Marker Supply Missing • Toner Empty • Replace toner collection container. • Cover Open • Paper Empty • Input Tray Empty • Specified Input Tray Open • Specified Output Tray Full • Offline • Printer Warning • Toner Low • Paper Low • Input Tray Open • Output Tray Full • Output Tray Nearly Full • Near to overdue service maintenance • Online • Auto Power Shut-Off • Warming Up • Busy
Memo	<p>Displays text that the administrator entered. If you have logged in as an administrator, you can enter a memo. If no name has been set, [Not Set] appears. When you tap the [Not Set] key, the Machine Identification screen appears.</p>



Item	Description
Supply Status	Displays the current status of supplies. If staples are installed, their status is displayed.
Paper Input Tray Status	Displays the current status of the paper trays installed in the machine.
Display Pattern Setting	Switches the display pattern of the home screen.
[Reboot the MFP] key	Displays the restart screen. (Administrator rights are required.)
[Enter the Power Save Mode] key	Displays the power save mode screen. (Administrator rights are required.)

Total Count

This function shows the page count in each mode.

This setting may require administrator privileges.



- Pages printed directly from the machine such as list prints are included in the "Other Prints" count.
- The items displayed (or printed) will vary depending on the machine specifications and peripheral devices installed.
- When "Restrict Total Count display" is set, only administrators can confirm this.

Device Status

This screen shows the device status.

This setting can also be made by general users.

Item	Description
Paper Input Tray Status	Displays the current status of the paper trays installed in the machine.
Output Tray Status	Displays the current status of the output tray installed in the machine.
Supply Status	Displays the current status of supplies. If staples are installed, their status is displayed.
Device Configuration	Displays the information of options installed in the machine.
Local Drive Status	Displays the usage status of the local drive.

Network Status

Displays general, TCP / IP, and DNS status information.

The contents displayed here are the items to be set in the network settings and their setting values.

For each setting, see the following "[Network Settings \(page 10-158\)](#)".

This setting can also be made by general users.

Security Status

Displays the security settings status of the machine.

The contents displayed here are the items to be set in the security settings and their setting values.

For each setting, see the following "[Security Settings \(page 10-181\)](#)".

This setting can also be made by general users.



Firmware Version

Shows the firmware version of the machine as a list.
This function requires administrator rights.

Power Reset

The Power Reset screen enables you to restart the machine or enter the power save mode.



This function requires administrator rights.

Item	Description
Reboot the machine	Reboots the machine. Tapping the [Execute] key opens the Restart screen, and then tapping the [Execute] key again restarts the machine.
Enter the Power Save Mode	Shifts the machine to power save mode. Tap the [Execute] key to open the power saving mode screen.

Data List

Lists showing the settings and information registered in the machine can be printed.



The two-sided or one-sided list printing setting is determined by Operation Settings - Data List - 1-Sided/2-Sided.

List for User

This setting can also be made by general users.

List name	Description
Machine Status List	This list shows information needed by regular users, such as hardware statuses, software statuses, printer environment settings, and paper tray settings.
Printer Test Page	This is used to print the PCL Symbol Set List, various font lists, and the NIC page (network interface settings, etc.). <ul style="list-style-type: none"> • PCL Symbol Set List • PCL Symbol Set List • PCL Internal Font List • PCL Extended Font List • PS Font List • PS Extended Font List • NIC Page
Destination List:	Lists can be printed of various addresses stored in the machine. <ul style="list-style-type: none"> • Individual List • Group List • Memory Box List
Document Filing Folder List	This shows the folder names for document filing.



Prohibit Test Page

You cannot print the test page when [Prohibit Test Page Printing] is enabled. In "Settings (administrator)", select [System Settings] → [Printer Settings] → [Condition Settings] → [Prohibit Test Page Printing].



List for Administrator

You can print out the lists and reports that only the administrator can refer to.

When using "Image Sending Activity Report (Internet Fax)" in Image Sending Activity Report (Auto), select "Setting mode" → [System Settings] → [Image Send Settings] → [Internet Fax Settings] → [Receive Settings] → [2-Sided Printing of Received Data], enabling you to specify 1-sided or 2-sided printing.

When using "Image Sending Activity Report (Fax)" in Image Sending Activity Report (Auto), select "Setting mode" → [System Settings] → [Image Send Settings] → [Fax Settings] → [Receive Settings] → [2-Sided Printing of Received Data], enabling you to specify 1-sided or 2-sided printing.



When [Print Only the Settings that have been Changed] is enabled, only the items in the selected list that have been changed from the factory default will be selected for printing.

Home Screen

- Home Screen List

Copy Settings

- Copy Settings List

Printer Settings

- Printer Settings List

Image Send Settings

- Metadata Set List
- Common Settings List
- Scan Settings List
- Fax Settings List
- I-Fax Settings List

Document Filing Settings

- Document Filing Settings List

Sharp OSA Settings

- Sharp OSA Settings List

Authentication Settings

- Authentication Settings List

Common

Lists of the administrator settings for the following modes can be printed.

- Paper Settings List
- Machine Identification Settings List
- Operation Settings List
- Keyboard Settings List
- Device Control List

Network Settings

- Network Settings List

Security Settings

- Security Settings List

Energy Save Setting

- Energy Save List

Image Quality Adjustment

- Image Quality Adjustment List

Image Sending Activity Report

The following Image Sending Activity Reports can each be separately printed.

- Image Sending Activity Report (Fax)
- Image Sending Activity Report (Scan)
- Image Sending Activity Report (Internet Fax)



Data Receive/Forward List

The following lists showing reception settings and forwarding settings can be printed.

- Allow/Reject Number List
- Allow/Reject Mail & Domain Name List
- Inbound Routing List
- Document Admin List



ADDRESS BOOK

Address Book

Transmission destinations (contacts) such as fax and Scan to E-mail addresses, and groups of transmission destinations, can be stored in the address book.

To edit a contact or group, select the name of the contact/group. To add a new contact or group, click the [Add] key. For the procedure for storing contacts and groups using the machine's touch panel, see "[ADDRESS BOOK SCREEN \(page 6-15\)](#)". In setting mode, a list of stored contact and group information is displayed.

This setting can also be made by general users.



This setting can only be set on web pages.

Item	Description
Type	Select the contact or group. Factory default settings: Contacts
Search Number	Store a number that can be used to search for a contact or group.
Address Name	Store a name for an address.
Group Name	Store a name of group.
Initial	Store an initial that can be used to search for a contact or group.
Category	Enter a category for a contact or group. Factory default settings: Category1
Register this Address to be added to the [Frequent Use] index.	Add a contact to the "Frequent Use" index. Factory default settings: Disabled
Address Public Setting	Set whether the address will be shared with all users or only selected users. If you select [Select user], click the user selection buttons to select the users with whom the address will be shared. Factory default settings: All.
Share also to the following group	When this function is enabled, you can select a previously stored group from the list below and share the address with that group. Factory default settings: Disabled
E-mail	
E-mail Address	To store a new address, select [New Address] and enter the address in the address entry field.
Global Address Search	To search for an address stored as a global address, click this key and select the address from the list.
File Type*	Select the file format used for a scanned image. When [OCR] is enabled, text in the scanned data is automatically recognized. If [Disabling of OCR] is set, OCR function cannot be used. Factory default settings: PDF
Black & White	Select the compression format used for saving black & white images. Factory default settings: MMR (G4)



Item	Description
Color/Grayscale	Color/Grayscale: Select the compression format used for saving color/grayscale images. If you select a PDF file format as the file format setting, you can select [Reduce Colors]. Factory default settings: Compression Ratio: Middle, Reduce Colors: Disabled
Set as Default used	Set an address as a default address. Factory default settings: Disabled
User Certificate	Displayed when S/MIME setting is enabled and one destination is selected when [Contacts] is set for the type. You can install and select the user certificate to be used.
Fax	
Fax Number	To store a new fax number, select [New Address] and enter the fax number in the fax number entry field.
Global Address Search	To search for a fax number stored as a global address, click this key and select the fax number from the list.
Transmission Mode	Select the communication speed and International Correspondence Mode. Factory default settings: Transmission Speed: 33.6kbps, Transmission Mode: None
Set as Default used	Set an address as a default address. Factory default settings: Disabled
Internet Fax	
Internet Fax Address	To store a new address, select [New Address] and enter the address in the address entry field.
Global Address Search	To search for an address stored as a global address, click this key and select the address from the list.
Compression Mode	Set the compression format used for transmitted images. Factory default settings: MH(G3)
Request Internet Fax Reception Report	Select whether or not you wish to receive a reception report by e-mail after transmission is completed. Factory default settings: Disabled
Set as Default used	Set an address as a default address. Factory default settings: Disabled
Direct SMTP	
Direct SMTP Address	To store a new address, select [New Address] and enter the address in the address entry field.
Add Hostname or IP Address.	When the receiving machine is set to only receive e-mail from specific addresses, enter the specified specific e-mail address in the [Direct SMTP Address] text box. Select the "Add Hostname or IP Address." checkbox and enter the host name or IP address of the receiving machine in the [Hostname or IP Address] text box. Example: When the e-mail address of the receiving machine is "user@sample_domain.com" and the IPv4 address is "192.168.123.45" "user@sample_domain.com" and the IPv4 address is "192.168.123.45" Enter "user@sample_domain.com" in the [Direct SMTP Address] text box and enter "192.168.123.45" in the [Hostname or IP Address] text box. 192,168,123. 45 Enter "user@sample_domain.com" in the [Direct SMTP Address] text box and enter "192.168.123.45" in the [Hostname or IP Address] text box. Factory default settings: Disabled



Item	Description
Compression Mode	Set the compression format used for transmitted images. Factory default settings: MH(G3)
Set as Default used	Set an address as a default address. Factory default settings: Disabled
FTP	
FTP Address	To add a new address, select [New Address] and enter the address in [Hostname or IP Address].
Port Number	Set the port number used by the FTP server. Factory default settings: 21
File Type*	Select the file format used for a scanned image. For PDF, the text information is embedded in the PDF. When [OCR] is enabled, text in the scanned data is automatically recognized. For PDF, RTF, TXT(UTF-8), DOCX, XLSX, or PPTX, the recognized text is saved in the corresponding format. If [Disabling of OCR] is set, OCR function cannot be used.
Black & White	Select the compression format used for saving black & white images. Factory default settings: MMR (G4)
Color/Grayscale	Color/Grayscale: Select the compression format used for saving color/grayscale images. If you select a PDF file format as the file format setting, you can select [Reduce Colors]. Factory default settings: Compression Ratio: Middle, Reduce Colors: Disabled
Directory	Specify a directory in the FTP server to be used for transmission.
User Name	Enter a user name in the FTP server to be used for transmission.
Password	Enter the password associated with the entered user name. Factory default settings: Change Password: Disabled
Enable SSL/TLS	Use SSL/TLS to encrypt data before transmission. Factory default settings: Disabled
Use PASV mode	Send data to an FTP server in PASV mode. Factory default settings: Disabled
Enable Hyperlink to FTP server to be e-mailed	When sending data to an FTP server, send the data to the e-mail address that is specified in the hyperlink to the FTP server. Factory default settings: Disabled
Set as Default used	Set an address as a default address. Factory default settings: Disabled
Desktop	
Desktop Destination	To add a new address, select [New Address] and enter the address in [Hostname or IP Address].
Port Number	Enter the port of the destination computer.
Process Directory	Specify the directory to which the data is be to sent.
File Type*	Select the file format used for a scanned image. For PDF, the text information is embedded in the PDF. When [OCR] is enabled, text in the scanned data is automatically recognized. For PDF, RTF, TXT(UTF-8), DOCX, XLSX, or PPTX, the recognized text is saved in the corresponding format. If [Disabling of OCR] is set, OCR function cannot be used.



Item	Description
Black & White	Select the compression format used for saving black & white images. Factory default settings: MMR (G4)
Color/Grayscale	Color/Grayscale: Select the compression format used for saving color/grayscale images. If you select a PDF file format as the file format setting, you can select [Reduce Colors]. Factory default settings: Compression Ratio: Middle, Reduce Colors: Disabled
User Name	Enter a user name in the computer to be used for transmission.
Password	Enter the password associated with the entered user name. Factory default settings: Change Password: Disabled
Enable SSL/TLS	Use SSL/TLS to encrypt data before transmission. Factory default settings: Disabled
Set as Default used	Set an address as a default address. Factory default settings: Disabled
Network Folder	
Network Folder Path	To store a new path, select [New Address] and enter the path in the path entry field.
User Name	Enter a user name in the computer to be used for transmission.
Password	Enter the password associated with the entered user name. Factory default settings: Change Password: Disabled
File Type*	Select the file format used for a scanned image. For PDF, the text information is embedded in the PDF. When [OCR] is enabled, text in the scanned data is automatically recognized. For PDF, RTF, TXT(UTF-8), DOCX, XLSX, or PPTX, the recognized text is saved in the corresponding format. If [Disabling of OCR] is set, OCR function cannot be used.
Black & White	Select the compression format used for saving black & white images. Factory default settings: MMR (G4)
Color/Grayscale	Color/Grayscale: Select the compression format used for saving color/grayscale images. If you select a PDF file format as the file format setting, you can select [Reduce Colors]. Factory default settings: Compression Ratio: Middle, Reduce Colors: Disabled
Enable Hyperlink to Network Folder to be e-mailed	When sending data to a shared folder, send the data to the e-mail address that is specified in the hyperlink to the shared folder. Factory default settings: Disabled
Set as Default used	Set an address as a default address. Factory default settings: Disabled

* Depending on the model and upon installation of peripheral devices, High Compression PDF may be selected. When [OCR] is enabled, text in the scanned data is automatically recognized. For PDF, the text information is embedded in the PDF. For PDF, RTF, TXT(UTF-8), DOCX, XLSX, or PPTX, the recognized text is saved in the corresponding format.



Category Setting

A “Category” can be set for an address. By setting a category for an address, the category can be used to filter addresses when searching for that address, making it easier to find the address.

Any name can be set for a category. By assigning distinctive names to categories, addresses can be easily sorted. The factory default names are "Category 1" to "Category 32".

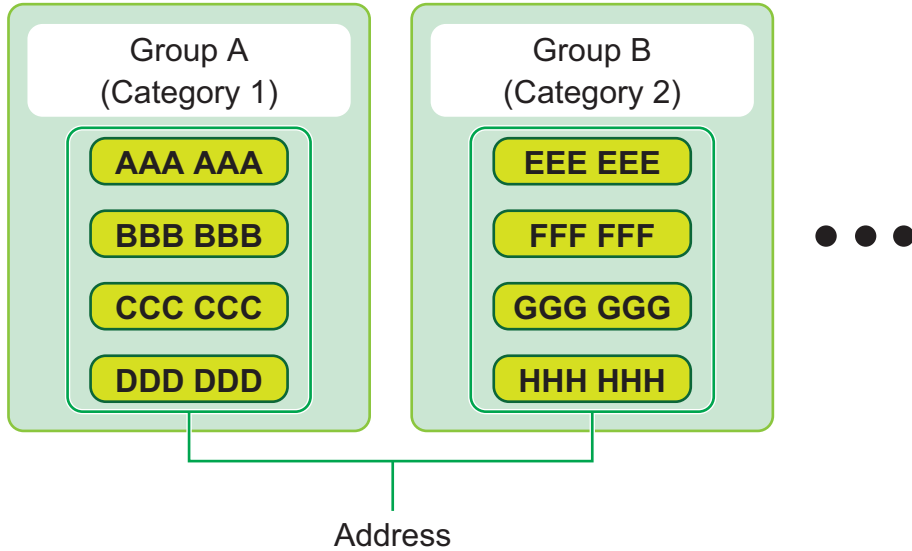

This setting can only be set on web pages.



DOCUMENT OPERATIONS

Document Operations

This setting can also be made by general users.

Document Filing

Data saved by Document Filing can be manipulated from the Web.

Main Folder

Files in the Main Folder can be displayed. A specified file can be manipulated by clicking [Print], [Send], [Move], or [Delete].

Item	Description
Display Style	Saved files can be displayed in list format or thumbnail format.
Job Classification	The saved files that are displayed can be filtered by job.
Download	When there is a PDF file for PC viewing or downloading, select it to download the file to your computer.
Display Items	Set the number of files that are displayed.

Quick File Folder

Files in the Quick File Folder can be displayed. You can re-operate the specified file. Clicking [Print], [Send], [Move], or [Delete].

Item	Description
Display Style	Saved files can be displayed in list format or thumbnail format.
Job Classification	The saved files that are displayed can be filtered by job.
Display Items	Set the number of files that are displayed.

Custom Folder

The files that are in the Custom Folder can be displayed. You can re-operate the specified file. Clicking [Print], [Send], [Move], or [Delete]. If the file to be manipulated has a password, enter the password in "Password of File".

Item	Description
Index	The displayed Custom Folder names can be filtered by index.
Download	When there is a PDF file for PC viewing or downloading, select it to download the file to your computer.
Display Items	Set the number of files that are displayed.



My Folder

Displayed when My Folder is set.

Displays the files in My Folder. Allows you to retrieve the specified file. A specified file can be manipulated by clicking [Print], [Send], [Move], or [Delete].

If the file to be manipulated has a password, enter the password in "Password of File".

Search

Item	Description
User Name	Enter the user name.
Select from User List	Click the [Setup] button and search for users from the list.
Login Name	Set the number of files that are displayed.
Search Folder	Set the folder.
File Name	Enter a file name.
Password of File	Enter the password that is set for the file.
Stored Date	Set the date and time the file was saved.

Search Result

Use these settings to enter search conditions. A specified file can be manipulated by clicking [Print], [Send], [Move], or [Delete]. If the file to be manipulated has a password, enter the password in "Password of File".

Item	Description
Display Style	The files that were found can be displayed in list format or thumbnail format.
Job Classification	The found files can be filtered by job.
Display Items	Set the number of files that are displayed.

File Batch Print

Multiple files can be printed at once by batch printing. Search for the files using search conditions, and then select multiple files from the displayed search results.

Click [Print] to print the file.

Item	Description
Search Condition	
User Name	Enter the user name.
Select from User List	Click the [Setup] button and search for users from the list.
Search Folder	Select the folder that contains the target file.
File Name	Enter a file name.
Password of File	Enter the password for the target file.
Search Result	
Job Classification	The found files can be filtered by job. Factory default settings: All Jobs
Number of Copies	Set the number of copies to be printed. Factory default settings: Apply the Number of Copies Stored in Each File
Print and Delete the Data	After printing, delete the file. Factory default settings: Disabled



Item	Description
Billing Code	Displayed when "Use Billing Code" is enabled.
Main Code	Select this checkbox, and then enter the main code. (32 characters or less)
Sub Code	Select this checkbox, and then enter the sub code. (32 characters or less)

Submit Print Job

In addition to a file on your PC, this procedure can be used to print any file that can be accessed from your PC, such as a file on another PC connected to the same network.

Files that can be printed are PDF*1, TIFF, JPEG, PCL, PS, XPS, DOCX, PPTX, and XLSX files with extensions pdf, tif, tiff, jpeg, jpg, jpe, jfif, pcl, ps, xps, docx, pptx, and xlsx. Available only if the MFP supports PostScript.

Enter the password for the encrypted PDF data on Spool Queue of the Job Status screen.

Enter the password for the encrypted PDF data on Spool Queue of the Job Status screen

For the procedure for accessing "Setting Mode (Web version)", refer to "SETTING MODE".

Print Settings

Select print settings. Select the file you want to print in "Select File", select settings, and then click [Print].

Item	Description
Copies	Set the number of copies to be printed.
Paper Size	Set the print size.
Orientation	Select portrait or landscape for the print orientation. Factory default settings: Portrait
Duplex printing	Select one-sided printing, two-sided printing (booklet), or two-sided printing (tablet). Factory default settings: 1-Sided
Output	If printing by set, select the "Print per Unit" checkbox. Factory default settings: Print per Unit: Enabled
Staple	It can be used by connecting a finisher, or saddle finisher. The settings differ depending on the connected finisher, and saddle finisher. Factory default settings: Off
Separator Page	Select to insert separator pages. Specify whether separator pages are to be added in front of or behind each set. Select the paper tray with the paper you want to use from the paper trays. Factory default settings: Insert Top of Sets:Disabled, Insert End of Sets:Disabled
Punch	It can be used when the punch unit is attached to the finisher.
Fold	It can be used when the saddle finisher is attached. Set the orientation of the paper fold.
Saddle Fold	It can be used when the saddle finisher is attached. Set the orientation of the paper fold in "Print side". If you want to fold the printed paper together in the saddle, set "Fold multiple sheets together".
Z-Fold Paper Size	It can be used when the paper folding unit is attached. Select the paper size to use for Z-fold.
C-Fold	It can be used when the paper folding unit is attached. Set the fold orientation in "Print side". In "Opening direction", select the opening orientation when unfolding the folded paper.



Item	Description
Accordion Fold	It can be used when the paper folding unit is attached. In "Opening direction", select the opening orientation when unfolding the folded paper.
Half Fold	It can be used when the paper folding unit is attached. Set the orientation of the paper fold in "Print side".
Double Fold	It can be used when the paper folding unit is attached. Set the fold orientation in "Print side". In "Opening direction", select the opening orientation when unfolding the folded paper.
Fit To Page	Print with the file expanded to the full paper size.
Trimmer	Available when the trimming module is installed. Sets the cutting width.
Print What	Select whether to print the sheet or the entire workbook when printing the Excel file.
Output Tray	Select the output tray for the print job.
Quick File	Save the print data in the Quick File Folder of the machine.
Print Glossy	Select this checkbox if the print job will be printed on glossy paper.
Billing Code	Select the checkbox of the Billing Code to assign, and then enter the billing code.

Qualcomm® DirectOffice™ is a product of Qualcomm Technologies, Inc. and/or its subsidiaries.

Qualcomm® is a trademark of Qualcomm Incorporated, registered in the United States and other countries.

DirectOffice™ is a trademark of CSR Imaging US, LP, registered in the United States and other countries.



USER CONTROL

User Settings

It manages users such as registration of users to log in and user authentication methods.

User List

Add, edit, and delete users for user authentication, and configure user authentication settings.

- **[Add] key**
Add a new user.
- **[Delete All Users] key**
Deletes all registered users. (Excluding users stored as factory default.) Only the administrator of the machine can use this function.
- **[Delete All Auto-registered users] key**
Deletes all auto-registered users.
- **[Delete Your Information for External Service Connect] key**
Deletes the external connect caches used by the logged in user. [Store user authentication information for External Connect] must be enabled to use this function.
- **[Delete All Information for External Service Connect] key**
Only the administrator of the machine can use this function. Delete all External Connect caches. [Store user authentication information for External Connect] must be enabled to use this function.
- **User List**
This shows the users stored as factory default and the currently stored users. An asterisk [*] appears in front of the user name of auto-registered users.
When you select a user name, the user edit or delete screen appears.



The [Vender] and [Vender2] options are displayed only when the vender is connected.

Storing a user

When you tap the [Add] key, the registration screen appears. Up to 1000 groups can be registered. For each setting, see the following "[Settings \(page 10-45\)](#)".



Editing and deleting a user

When you select a user from the list, the user edit/delete screen appears.

For each setting, see the following "[Settings \(page 10-45\)](#)".

A user can be deleted using the [Delete] key.



- If the login authentication with a Fixed User is set, the "Delete All Users" option cannot be used.
- Users stored as factory default cannot be deleted.

Users stored as factory default

The following users are stored in the machine at the factory.

Administrator:

The administrator account of the machine, stored as factory default.

User:

This is used when network authentication is used and a login name that is not stored in the machine is entered directly. (This cannot be selected from the login user screen.)

Device Account:

User*¹

Other User:

This is used when a print job is executed using invalid user information. (This cannot be selected from the login user screen.)

For settings related to each of the users, see the following table.

User Name	Administrator	User	Device Account	Other User
Login Name	admin	users	device account	Other
Password	(Refer to the Start Guide)* ¹	users* ¹	device account* ¹	-
My Folder	No	No	Main Folder	No
Authentication Settings	Login Locally			-
Pages Limit Group	Unlimited* ¹			
Authority Group* ²	Admin	User* ¹	User* ¹	Guest* ¹
Favorite Operation Group	Following the System Settings* ¹			
Default Billing Code	Not Set* ¹			

*¹ Items that can be changed

*² For detailed information about each of the settings, see "List of settings and factory default settings of template groups".



Settings

Item	Description
User Name	This user name is used as the key name in the authentication screen, the user name for document filing, and the sender name. If you want to use the " Automatically print stored jobs after login (page 10-132) " function, register up to 16 double-byte characters.
Apply User Name to Log-in Name* ¹	<input checked="" type="checkbox"/> Select this to enter the entered user name in the login name. Factory default settings: Disabled
Initial	This determines where the user name will appear in the user list. Enter a maximum of 10 characters for the initials.
Index	Select a custom index to be stored. The custom index names are the same as those used in the address book. Factory default settings: User1
Login Name* ¹	Login name/password Enter the login name to be used when setting authentication. Enter the password, consisting of 1 to 255 characters, that is used for user authentication by login name and password (the password is optional).
Password* ^{1, *3}	Enter the password used when setting the authentication by login name / password using 1 to 255 characters. (Optional) After entering the password, enter once again in "Password (for confirmation)".
Change PIN Code/Password	Check this when you want to change the set password. (Displayed when modifying/deleting.) Factory default settings: Disabled
Release Operation Lock Status	Displayed when login has failed, and subsequent login to the printer is not possible. Tap the [Execute] to clear this login lock, and allow the user to log in again.
User Number* ²	Enter a user number in 5 to 8 digits.
E-mail Address	Enter the e-mail address that is used in the sender list and for LDAP authentication.
Home Directory Path	Enter for the home directory path.
Use Login Name for User Authentication	Set whether or not the login name for user authentication will be the same as the user name for home directory path authentication. Factory default settings: Enabled
User Name	Enter for the user name for home directory path authentication.
Password	Enter a maximum of 255 numeric digits for the password for home directory path authentication.
Change PIN Code/Password	Check this when you want to change the set password. (Displayed when modifying/deleting.) Factory default settings: Disabled
Authentication Settings* ¹	Select either [Login Locally], [Network Authentication] (when LDAP is enabled) or [Active Directory] (when Active Directory is enabled) for authentication. Factory default settings: Login Locally
Authentication Server	When the [Network Authentication] is selected, select the server to be used for user authentication from the LDAP server list that is stored using Setting mode (Web version).
User Group	Set a group to which the user belongs. Up to 8 groups can be assigned.



Item	Description
Pages Limit Group	Specify the page limit for the user by selecting one of the stored page limit groups. For more information, see " Pages Limit Group (page 10-47) ". Factory default settings: Unlimited
Authority Group	Specify the user authority by selecting one of the stored authority groups. For more information, see " Authority Group (page 10-48) ". Factory default settings: User
Favorite Operation Group	The favorite operation group is displayed when the user logs in. To change the settings, select [User Control] in Setting mode (Web version). Factory default settings: Following the System Settings
Default Billing Code	Set the Main Code and Sub Code when the user logs in. Factory default settings: Not Set
My Folder	Store a folder to be used for document filing as the dedicate user folder (or My folder). A stored folder can be selected, or you can create and specify a new folder.

*1 It is not displayed when "User Number" is selected for the authentication method.

*2 It is displayed when "User Number" is selected for the authentication method.

*3 When using network authentication, the password registered in the LDAP server is used, so there is no need to set it.

Custom Index

You can change the custom index name.

Tap the custom index name on the list to edit it.

Delete the previously entered characters and enter a new name.

Organization /Group List

This is used to store user groups.

Tap each group name to enter them directly.

User Information Print

Prints the following item lists.

- User List
- List of Number of Pages Used
- Page Limit Group List*
- Authority Group
- Favorite Operation Group List*
- All User Information Print

Select each item and tap the [Print] key to print it out.

* Cannot be printed when no groups are stored.



In All User Information Print, the following items are handled by 2-sided printing on an item basis.

- User List
- List of Number of Pages Used
- Pages Limit Group
- Favorite Operation Group



Access Control Settings

Pages Limit Group

This is used to register the page limit settings in advance for each group.

The page limit for each user is specified by selecting one of these registered groups when the user is registered.

- **[Add] key**

Use this to add a new group.

- **List display**

This shows the currently stored groups. Selecting a group name displays the edit screen for that group.

Storing page limit groups

When you tap the [Add] key, the registration screen appears. Up to 20 groups can be registered.

For each setting, see the following "[Settings \(page 10-47\)](#)".

Editing a page limit group

Selecting a group from the list displays the edit screen for that group.

For each setting, see the following "[Settings \(page 10-47\)](#)".

To return a group to the factory default state, set "Select the Group Name to be the Registration Model" to "Unlimited" on the edit screen.

Settings

Item	Description
Group Name	Store a name of group (up to 32 characters).
Select the Home Screen to be the Registration Model	Select one of the previously stored groups for use as a template for the new group. When selected, the settings of this group are applied.
Function Names	The name of the functions that can be configured is displayed. Set a limit for each function.
Page Limit	When [Prohibited] is selected for a mode, input from the mode is prohibited. When [Unlimited] is selected for a mode, there is no limit to the number of pages that can be input/output in that mode. When [Limited] is selected, enter a page limit (1 to 99999999 pages).

Machine Page Limit Setting

Sets the page limit for the machine.

Settings

Item	Description
Function Names	The name of the functions that can be configured is displayed. Set a limit for each function.
Page Limit	When [Prohibited] is selected for a mode, input from the mode is prohibited. When [Unlimited] is selected for a mode, there is no limit to the number of pages that can be input/output in that mode. When [Limited] is selected, enter a page limit (1 to 99999999 pages).



Authority Group

This is used to store the settings relevant to user authorities in advance for each group. The authority of each user is specified by selecting one of these registered groups when the user is registered.

- **[Add] key**

Use this to add a new group.

- **List display**

This shows the currently stored groups. Selecting a group name displays the edit screen for that group.

Storing authority groups

When you tap the [Add] key, the registration screen appears. Up to 20 groups can be registered.

For detailed information about each of the settings, see "List of settings and factory default settings of template groups".

Editing an authority group

Selecting a group from the list displays the edit screen for that group. For detailed information about each of the settings, see "List of settings and factory default settings of template groups".

To return a group to the factory default state, select the group from the list and select any of options [Return to the Administrator Authority], [Return to the system administrator authority.], [Return to the User Authority], [Return to the Guest Authority] and [Return to the scanner prohibited authority.].

Tapping the [Execute] key resets the group status to the factory default.

Item	Description				
Group Name	Store a name of group (up to 32 characters).				
Select the Home Screen to be the Registration Model	Select one of the previously stored groups for use as a template for the new group. When selected, the settings of this group are applied. When selected, the settings of this group are applied. The factory default groups and their settings are shown below.				
	Admin	System Administrator	User	Guest	Scanner Prohibited Authority
Job Settings					
Copier					
Approval Setting	Allowed	Allowed	Allowed	Allowed	Allowed
Special Modes Usage	Allowed	Prohibited	Allowed	Prohibited	Allowed
Utilize sending function at copy	Allowed	Allowed	Allowed	Allowed	Allowed
PDF Creation for PC Browsing	Allowed	Prohibited	Allowed	Allowed	Allowed
Printer					
Approval Setting	Allowed	Prohibited	Allowed	Allowed	Allowed
FTP Pull Print	Allowed	Prohibited	Allowed	Prohibited	Allowed
USB Memory Direct Print	Allowed	Prohibited	Allowed	Prohibited	Allowed
Network Folder Pull Print	Allowed	Prohibited	Allowed	Prohibited	Allowed
Sending while printing	Allowed	Allowed	Allowed	Allowed	Allowed
PDF Creation for PC Browsing	Allowed	Prohibited	Allowed	Allowed	Allowed
Approval Setting to Use Toner Save Mode	No Toner Save	No Toner Save	No Toner Save	No Toner Save	No Toner Save
Image Send					
Approval Settings for Each Mode					



Item	Description				
<ul style="list-style-type: none"> E-mail FTP Desktop Network Folder Save in External Memory Device PC Scan Internet Fax Send PC-I-Fax Send Fax Send PC-Fax Send 	All allowed	All prohibited	All allowed	All allowed	All prohibited
Color Scan	Allowed	Prohibited	Allowed	Prohibited	Allowed
Special Modes Usage	Allowed	Prohibited	Allowed	Prohibited	Allowed
Registration/Deletion of Program	Allowed	Prohibited	Allowed	Prohibited	Allowed
PDF Creation for PC Browsing	Allowed	Prohibited	Allowed	Allowed	Allowed
Access to Fax Data	Allowed	Allowed	Allowed	Allowed	Allowed
Approval Setting for Addressing					
<ul style="list-style-type: none"> Approval Setting for Direct Entry Approval Setting to Use a Local Address Book Approval Settings to Use a Global Address Book 	All allowed	All allowed	All allowed	All allowed	All allowed
Document Filing					
Scan to Local Drive					
Color Scan	Allowed	Prohibited	Allowed	Only Black & White Allowed	Allowed
Special Modes Usage	Allowed	Prohibited	Allowed	Prohibited	Allowed
Creating Downloadable File	Allowed	Prohibited	Allowed	Allowed	Allowed
Prints (Document Filing)					
Color Mode Approval Setting	Allowed	Prohibited	Allowed	Allowed	Allowed
Special Modes Usage	Allowed	Prohibited	Allowed	Prohibited	Allowed
Document Filing Image Check					
Approval Setting	Allowed	Prohibited	Allowed	Prohibited	Allowed
Display only the Files of Logged-in Users	Prohibited	Prohibited	Allowed	Allowed	Allowed
Sharp OSA					
Approval Setting to Use a Sharp OSA	Allowed	Prohibited	Allowed	Allowed	Allowed
Common Functions					
Approval Settings for 2-Sided Print	All allowed	All allowed	All allowed	All allowed	All allowed
Changing Billing Code	Allowed	Allowed	Allowed	Allowed	Allowed
Output Approval Settings	All allowed	All prohibited	All allowed	All prohibited	All allowed
Security					
Document Filing Approval Setting:Quick File Mode/Sharing Mode	Prohibited	Prohibited	Prohibited	Prohibited	Prohibited



Item	Description				
Document Filing Approval Setting:Confidential Mode	Allowed	Prohibited	Allowed	Prohibited	Allowed
Print Jobs Other than Print Hold Job	Allowed	Allowed	Allowed	Allowed	Allowed
Pattern Print Input - Direct Entry	Allowed	Prohibited	Allowed	Prohibited	Allowed
Machine Settings					
Total Count	Allowed	Allowed	Allowed	Prohibited	Allowed
Device / Network Status	Allowed	Allowed	Allowed	Prohibited	Allowed
Power Reset	Allowed	Allowed	Prohibited	Prohibited	Prohibited
List for User	Allowed	Allowed	Allowed	Prohibited	Allowed
List for Administrator	Allowed	Allowed	Prohibited	Prohibited	Prohibited
Address Registration	Allowed	Allowed	Allowed	Prohibited	Allowed
Document Filing Folder Registration	Allowed	Allowed	Allowed	Prohibited	Allowed
User Control (Admin)	Allowed	Allowed	Prohibited	Prohibited	Prohibited
User Control (User)	Allowed	Allowed	Allowed	Prohibited	Allowed
Home Screen Settings	Allowed	Allowed	Prohibited	Prohibited	Prohibited
Copy Settings	Allowed	Allowed	Prohibited	Prohibited	Prohibited
Printer Settings (Admin)	Allowed	Allowed	Prohibited	Prohibited	Prohibited
Printer Settings (User)	Allowed	Allowed	Allowed	Prohibited	Allowed
Image Send Settings (Common Settings)	Allowed	Allowed	Prohibited	Prohibited	Prohibited
Scan Settings	Allowed	Allowed	Prohibited	Prohibited	Prohibited
Fax Settings	Allowed	Allowed	Prohibited	Prohibited	Prohibited
Internet Fax Settings	Allowed	Allowed	Prohibited	Prohibited	Prohibited
Fax Data Receive/Forward (Manual)	Allowed	Allowed	Allowed	Prohibited	Allowed
Inbound Routing (Forwarding/Storing) Settings (Admin)	Allowed	Allowed	Prohibited	Prohibited	Prohibited
Inbound Routing (Forwarding/Storing) Settings (User)	Allowed	Allowed	Allowed	Prohibited	Allowed
Metadata Settings	Allowed	Allowed	Prohibited	Prohibited	Prohibited
Document Filing Settings	Allowed*	Allowed*	Prohibited	Prohibited	Prohibited
Sharp OSA Settings	Allowed	Allowed	Prohibited	Prohibited	Prohibited
Paper Settings (Bypass Tray Excluded)	Allowed	Allowed	Allowed	Prohibited	Allowed
Paper Settings (Bypass Tray)	Allowed	Allowed	Allowed	Prohibited	Allowed
Operation Settings	Allowed	Allowed	Prohibited	Prohibited	Prohibited
Keyboard Settings	Allowed	Allowed	Prohibited	Prohibited	Prohibited
Device Control	Allowed	Allowed	Prohibited	Prohibited	Prohibited
Machine Identification Settings	Allowed	Allowed	Prohibited	Prohibited	Prohibited



Item	Description				
Clock Adjust	Allowed	Allowed	Prohibited	Prohibited	Prohibited
Product Key	Allowed	Allowed	Prohibited	Prohibited	Prohibited
Custom Link Setting	Allowed	Allowed	Prohibited	Prohibited	Prohibited
Network Settings	Allowed	Allowed	Prohibited	Prohibited	Prohibited
Security Settings	Allowed	Allowed	Prohibited	Prohibited	Prohibited
Energy Save	Allowed	Allowed	Prohibited	Prohibited	Prohibited
System Control	Allowed	Allowed	Prohibited	Prohibited	Prohibited
Image Quality Adjustment	Allowed	Allowed	Prohibited	Prohibited	Prohibited
Shortcut Page Setting	Allowed	Allowed	Prohibited	Prohibited	Prohibited

* For information on each setting, see the setting mode list.



Depending on the machine specifications and peripheral devices installed, it may not be possible to use some settings.



Favorite Operation Group

Favorite Operation Group List

For each group, you can register an environment with settings that are convenient for the group. For example, a user who speaks a different language would normally have to change the display language each time he or she uses the machine; however, by registering the language in a favorite operation group in advance, the language is automatically selected when the user logs in.



- This setting can only be configured in Setting mode (Web version). It cannot be configured in the touch panel of the machine.
- Depending on the machine specifications and peripheral devices installed, it may not be possible to use some settings.

Adding/editing a group

Tap the [Add] key to display the favorite operation group registration screen.

Tap a group name to display the registration screen for that favorite operation group. You can edit the group in this screen.

Settings

Item	Description
Group Name	Store a name of group.
Select the Home Screen to be the Registration Model	Select one of the previously stored groups for use as a template for the new group. When selected, the settings of this group are applied.
Copier	
Initial Status Settings	Select settings for Paper Tray, Exposure Type, Copy Ratio, 2-Sided, Output, Offset, Output Tray, Staple Position, Punch, Fold, Z-fold paper size C-Fold, Double Fold, Half Fold and Trimming Width Settings.
Image Send	
Initial Status Settings	Select settings for Image Orientation, Exposure, Resolution, Color Mode, File Format Original Image Type, and OCR Setting.
Document Filing	
Image Orientation	Specify the image orientation.
Initial Status Settings	Select settings for Color Mode, Exposure, Original Image Type, and Resolution.
Prints (Document Filing)	Set the default output tray for document filing print.
System Settings	
Enlarge Display Mode	Turn this option ON to display large characters on the Setting mode screen.
Original Size Detector Setting	Set the AB system and inch system for document detection.
Cancel Detection at Document Glass	Cancels the detection of the original on the platen (document glass).
Language Setting	Select the display language.
Switch the Number of Sets to be Displayed for Job Status	Select whether to display the number of progress sets or remaining sets as the job status.
Key Operation Setting	Set the key input time and Auto Key Repeat setting.



Item	Description
Time for Accepting Key Entry of Long Touch	Select a time when a long key touch is detected.
Double Tap Interval Setting	Select an interval when a double tap is detected.
Keys Touch Sound	Set the sound made when keys are touched.
Keyboard Select	Set the language that appears on the keyboard.
MFP Display Pattern Setting	Select the color pattern used in the touch panel.
Automatically print stored jobs after login	When retention is enabled in the printer driver and print data has been spooled to the machine, the spooled print data is automatically printed out when the user who enabled retention logs in.
Favorite Key Setting	Select whether to follow the system settings or the registered favorite key settings.
Home Screen Settings	Select to use System Settings or use the stored home screen settings for performing Home Screen Settings.
Preview Setting: Default List/Thumbnail Display	
Fax/I-Fax Reception Data	Select whether the default display format of the received fax/I-Fax list screen is list or thumbnails.
File Retrieve of Main Folder/Quick File Folder	Select whether the default display format of the document filing main folder and temporary folder screens is list or thumbnails.
File Retrieve of Custom Folder	Select whether the default display format of the document filing custom folder screen is list or thumbnails.
File Retrieve of Direct Print	Select whether the default state of the file list screen for direct print shows the folders as a list or as thumbnails.

Returning a favorite operation group to "Unlimited"

To return a selected favorite operation group to the factory default state, select the checkbox () to the left of "No." and tap the [Return to the Defaults] key.

Favorite Key List

Assign shortcut keys to frequently used functions.
They will be displayed in the base screen of each mode.



This setting can only be set on web pages.

Settings

Item	Description
Key Name	Enter a maximum of 20 characters for the favorite key name. (Up to 20 full-width characters can be entered, but only 10 will be shown on the key.)
Function Menu/Program/Other	Select the function that you wish to assign to the favorite key. The functions that can be selected vary by mode.
Hide	Enable this setting to not show favorite keys.



Home Screen List

Home screen settings must be previously stored.

Select a home screen when registering Favorite Operation Group List.

Item	Description
Name	Enter a maximum of 32 characters for the home screen name.
Select the Home Screen to be the Registration Model	Select one of the previously stored home screens as a template for the new home screen. When selected, the settings of this home screen are applied.
Key Layout of the Screen	The layout of the keys in the home screen is displayed.
Key Transparency Setting	Sets the transparency of the shortcut keys as a percentage.
Home button	Registers the function to use for the selected key number.
Display Toner Quantity	Select this to display the toner level in the fixed area.
Fixed button	Registers the function to use for the selected key number. This button is displayed on all pages of the home screen.
Rename Home Screen	Enter a home screen name to change the existing name.
Template	Select a layout pattern of the registered key.
Text Color	Select this to display the toner level in the fixed area.

User Count

This displays the total number of pages printed by each user.

- **[Select All] key**
This selects all users.
- **[Clear Checked] key**
This clears all selections.
- **[Show] key**
This shows the counts of the selected user.
- **[Clear Count] key**
Use this to reset the counts of the selected user.
- **User List**
This shows the users stored as factory default and the currently stored users. When you select a user name, the user is selected.



View User Count

When you select a user and tap the [Show] key, this user count is displayed.

Item	Description
Next	Displays the next user (in the order of the registration numbers).
Previous	Displays the previous user (in the order of the registration numbers).
Show Counts	Displays the counts and the number of pages remaining of the selected user for each function.
Page Limit	The page limit set for the user appears in parentheses below the count.



If peripheral devices are not mounted, their count is not displayed.

Resetting user counts

Select a user in the setting screen and tap the [Delete] key. A count reset screen for that user will appear.

The reset screen will vary depending on whether a single user or multiple users were selected. The items displayed in each case are described in the table below.

When a single user is selected

Item	Description
Next	Displays the next user (in the order of the registration numbers).
Previous	Displays the previous user (in the order of the registration numbers).
Show Counts	Displays the counts and the number of pages remaining of the selected user for each function.
Clear Count	Reset the count of the selected item to "0".
Clear All Count	Clears all counts of the selected user to zero (0).

When multiple users are selected

Item	Description
Show Counts	Displays the counts and the number of pages remaining of the selected user for each function.
Clear Count	Reset the count of the selected item to "0".
Clear All Count	Clears all counts of the selected user to zero (0).

Save User Count

Clicking the [Save] button saves the user count information as a data file.

To delete the user count information in the machine, click the checkbox next to the "Save and Delete the Data" so that it is selected and click the [Save] button.



This setting can only be configured in Setting mode (Web version). It cannot be configured in the touch panel of the machine.



Billing Code Setting

Select billing codes.

Administration Settings

Change the billing code setting.

Use Billing Code

Switch whether to enable or disable a billing code.

Factory default settings: Disabled

Use Code Settings

A use code is automatically assigned when no billing code is entered. Specify the code using up to 32 single-byte characters.

Take Over Billing Code at Mode Transition

If this function is enabled, the billing code entry window is not displayed at the time of mode transition.

Disable Change of Billing Code.

If this function is enabled, you cannot register, edit, or delete a billing code.

In addition, you cannot directly type in a billing code in the billing code entry window.

Apply Use Code While Logged in with Device Account

If this function is enabled, a use code is always set while you are logging in with device account.

Exception Setting for Billing Code Function

The billing code entry window is displayed when the external application that is set to enable is started.

The following settings can be configured.

- Application Name registered as Standard Application

Billing Code Display Name Setting

You can change the main code or sub code name displayed in the billing code entry window or billing code selection window.

Main Code List

You can display a list of main codes to search for, register, correct, or delete a main code.

- [Search] key
Searches for a main code.
- [Add] key
Adds a new main code.
- List display
Displays a list of registered main codes. Selecting each main code displays the window to correct the main code.
- [Delete] key
Set the check box on the left of each main code to , then tap the [Delete] key; the selected main code is deleted.



Register a main code

When you tap the [Add] key, the registration screen appears. A total of up to 2,000 main and sub codes can be registered.

After the setting has been completed, tap the [Submit and Register Next] key; you can continuously register the next main code. To end the registration process, tap the [Submit] key.

For each setting, see the following "[Settings \(page 10-57\)](#)".

Correct a main code

Selecting a main code from the list displays the window to correct the main code.

For each setting, see the following "[Settings \(page 10-57\)](#)".

After the setting has been completed, tap the [Submit] key; you can apply the corrected contents and complete processing.

Search for a main code

Enter the main code and main code name, then tap the [Search] key; the search result is displayed.

Settings

Item	Description
Main Code	Enter the main code. Specify the code using up to 32 single-byte characters.
Main Code Name	Enter the main code. Specify the code name using up to 32 double- or single-byte characters.
Public Group	The registered billing codes can only be shared in the specified group. When not specifying a public destination, select [Public to All]. When specifying a public destination, select [Designate Public Address.], then specify a group to share the billing code.



To register a group for specifying a public destination:

In "Settings (administrator)", select [User Control] → [User Settings] → [Organization /Group List].

Sub Code List

You can display a list of sub codes to search for, register, correct, or delete a sub code.

- [Search] key
Searches for a sub code.
- [Add] key
Adds a new sub code.
- List display
Displays a list of registered sub codes. Selecting each sub code displays the window to correct the sub code.
- [Delete] key
Set the check box on the left of each sub code to , then tap the [Delete] key; the selected sub code is deleted.

Register a sub code

When you tap the [Add] key, the registration screen appears. A total of up to 2,000 main and sub codes can be registered.

For information on the settings, see "[Settings \(page 10-58\)](#)".

After the setting has been completed, tap the [Submit and Register Next] key; you can continuously register the next sub code. To end the registration process, tap the [Submit] key.



Correct a sub code

Selecting a sub code from the list displays the window to correct the sub code.

After the setting has been completed, tap the [Submit] key; you can apply the corrected contents and complete processing.

For each setting, see the following "[Settings \(page 10-58\)](#)".

Search for a sub code

Enter the sub code and sub code name, then tap the [Search] key; the search result is displayed.

Settings

Item	Description
Sub Code	Enter the sub code. Specify the code using up to 32 single-byte characters.
Sub Code Name	Enter the sub code Specify the code name using up to 32 double- or single-byte characters.
Public Group	The registered billing codes can only be shared in the specified group. When not specifying a public destination, select [Public to All]. When specifying a public destination, select [Designate Public Address.], then specify a group to share the billing code.

**To register a group for specifying a public destination:**

In "Settings (administrator)", select [User Control] → [User Settings] → [Organization /Group List].



SYSTEM SETTINGS

Home Screen Settings

You can change the layout, icons, and background of the machine's home screen.
This setting requires administrator privileges.

Condition Settings

Item	Description
Home Button Position	You can select the position of the [Home Screen] key, left or right. Factory default settings: Left
Home Screen List	The order of arrangement of the shortcut keys in the home screen is indicated by the "No.", and the displayed keys appear in the home button column. To edit the home buttons, click the Home Button item.
Key Transparency Setting	Sets the transparency of the shortcut keys as a percentage.
Fixed area list	Set the keys (fixed keys) that appear in the fixed area below the home buttons. The order of arrangement of the keys is indicated by the "No.", and the keys appear in the fixed key column. To edit the fixed keys, click the Fix Key item.
Display Toner Quantity	Select this to display the toner level in the fixed area. Factory default settings: Enable
Template	You can change the layout of the keys by selecting a pattern saved in advance. The [Key Layout of the Screen] image changes as you make selections. Factory default settings: Pattern 1
Change Text Color On Home Screen	Select this to display the toner level in the fixed area. Scrolling Area Factory default settings: White Fixed Area Factory default settings: White Clock Factory default settings: White

Home Screen Registration

You can click a home button in the home screen list to change the settings of the home button. Select the function that you want to assign to the button. If you select [None], a home button will no longer appear in that location. To register a key name, select [Custom] and enter the name (maximum 28 characters). To change the image of a home button, register the desired icon in advance using [Icon], and then select the image with [Select File].



Icon

Use this setting to register a key icon.

Item	Description
Icon list	Use this setting to register icons for home screen shortcut keys. The image files of shortcut key icons are registered in a list. To register an image, click an image file registered in "Name" or "Not Set". Image formats that can be registered are JPEG, GIF, PNG (jpeg, jpg, jpe, jiff, gif, png). The maximum image file size that can be registered is 50 KB.



To configure this setting on the machine, insert the USB memory device that contains the image into the machine.

Background Image

Use this setting to register a background image.

Item	Description
Background image list	Image files such as a background images are registered in the registered image list. To register an image, click a name with a registered image or an unused name. The background image registration screen will appear. Register the desired image. The formats of images that can be registered are JPEG, GIF, and PNG (jpeg, jpg, jpe, jiff, gif, png). The maximum file size for a background image is 640 MB.



To configure this setting on the machine, insert the USB memory device that contains the image into the machine.



Copy Settings

Condition Settings

The following settings are related to copying.

Default settings selected with these settings apply to all functions of the machine (not just the copy function).

This setting requires administrator privileges.

Rotation Copy Setting

When the original and paper are placed in different orientations, this function automatically rotates the image 90 degrees to enable correct copying on the paper.

Factory default settings: Rotation Copy



When copying 5-1/2" x 8-1/2" (or A5 / A6) size documents to 5-1/2" x 8-1/2" R (or A5R / A6R) size paper, set the rotation copy.

Disable Copy in Different Size

Copying is prohibited when the orientation of the copy paper and the original are different, or when the optimum size copy paper is not loaded.

Factory default settings: Disable



It is valid when "[Rotation Copy Setting \(page 10-61\)](#)" is canceled.

Add or Change Extra Preset Ratios

Add two enlargement preset ratio values (101% to 400%) and two reduction preset ratio values (25% to 99%).

Also, you can change the preset ratio if necessary.



Preset ratios other than added preset ratios cannot be changed.

Setting a Maximum Number of Copies

This is used to set the maximum number that can be entered for the number of copies (number of continuous copies).

Any number from 1 to 9999 can be specified.

Factory default settings: 9999

Stamp

Set the font size of the print menu.

Factory default settings: Middle

Initial Margin Shift Setting

This is used to set the default margin shift amount. Specify a value from 0" (0 mm) to 2" (50 mm) in increments of 1/8" (3 mm) for both the front and reverse sides.

Factory default settings: Side 1:1/2" (10mm), Side 2:1/2" (10mm)



Erase Width Adjustment

This is used to set the default erase width for erase function. Specify a value from 0" (0 mm) to 1" (25 mm) in increments of 1/8" (3 mm) for both edge erase and center erase.

Factory default settings: Edge Clearance Width: 1/2" (10mm), Center Clearance Width 2: 1/2" (10mm)

Initial Multi Shot Setting

Set the default state for Multi Shot. Select the page layout for Multi Shot, whether or not borders are added, and if added, whether the borders are solid lines or dotted lines.

Factory default settings: Off, Layout: Left to Right/Right, and Down, Border: No Print

Card Shot Settings

This is used to set the default original size for the card shot function.

Specify a value from 1" (25 mm) to 8-1/2" (216 mm) in increments of 1/8" (3 mm) for both the X (horizontal) and Y (vertical) dimensions of the original.

Factory default settings: Original Size: X: 3-3/8" (86 mm), Y: 2-1/8" (54 mm)

Fit to Page

Enable this setting to have the [Fit to Page] key always appear in the card shot screen.

Factory default settings: Disable

Layout

Select an image layout.

Factory default settings: Set Vertically

Automatic Saddle Stitch

Set when saddle stitching is automatically stapled when binding is set.

Factory default settings: Enable

Initial Tab Copy Setting

This is used to set the default image shift width (tab width) for tab copying.

Specify a value from 0" (0 mm) to 1" (25 mm) in increments of 1/8" (3 mm).

Factory default settings: Image Shift: 1/2" (10 mm)

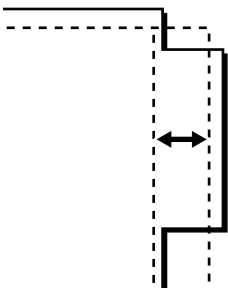

Disabling of Registration/Deletion of Program

This is used to prohibit the deletion and changing of copy settings stored in job programs.

Factory default settings: Disable



Disabling of Bypass-Tray in Duplex Copy

Disables the use of the bypass tray when making 2-sided copies.

The bypass tray is often used to feed label sheets, transparency film, and other special media for which 2-sided copying is prohibited. If a sheet of one of these special media enters the reversing unit, a misfeed or damage to the unit may result. If special media for which 2-sided copying is prohibited is often used, it is recommended that you enable this setting.

Factory default settings: Disable

Disabling of Auto Paper Selection

Disables the Auto Paper Selection function.

When this setting is enabled, automatic selection of paper that is the same size as the original on the document glass or in the automatic document feeder does not take place.

Factory default settings: Disable

Auto Selection Setting of Tray that is Supplied the Paper

When this setting is enabled and paper is loaded into a tray while the machine is on standby in copy mode, that tray is automatically selected.

Factory default settings: Disable

Disabling Registration of Custom Image

Disables storage of a custom image.

Factory default settings: Disable

Disabling sending while copying

Disables the Image Send function during copy.

Factory default settings: Disable

High Quality Scan from Document Feeder

The resolution for copying using the automatic document feeder can be changed from 600 x 400 dpi to 600 x 600 dpi (high quality mode).

When high quality mode is used, fine print and thin lines are reproduced with greater clarity, however, the scanning speed is slower.

Factory default settings: Disable



When high quality mode is not selected, the following conditions must be satisfied in order to scan at 600 x 400 dpi and attain the fastest speed.

- The copy ratio must be set to 100%.
 - Do not select a special mode that will change the ratio.
 - [Copy of Copy] must not be enabled.
-



Quick Scan from Document Glass

The resolution for copying using the document glass can be changed from 600 x 600 dpi to 600 x 400 dpi (high speed mode).

When high speed mode is selected, the first copy time is quicker, however, the copy image is not as clear.

Factory default settings: Disable



When high quality mode is not selected, the following conditions must be satisfied in order to scan at 600 x 400 dpi and attain the fastest speed.

- The copy ratio must be set to 100%.
- Do not select a special mode that will change the ratio.
- [Copy of Copy] must not be enabled.

Auto Clear Before Copy Execution Also

Enables the Auto Clear function during copy even when a copy job is not completed. This protects the machine from being held due to the incomplete copy job.

Factory default settings: Disable

Display Warning Message when Original is not Detected

A message is displayed when the original size cannot be detected when the original is set. You can prevent output with an unintended original size.

Factory default settings: Disable

Initial Status Settings

The following settings are related to copying.

Default settings selected with these settings apply to all functions of the machine (not just the copy function).

The copier settings are reset to the initial state when the [Power] button is turned on, when the [CA] key is tapped, or when the auto clear interval has elapsed. These settings are used to change the default settings for copy mode.

This setting requires administrator privileges.

The following settings can be changed:

Item	Description
Image Orientation	Specify the original orientation. Factory default settings: Portrait
Paper Tray	Specify the paper tray that is selected by default. Factory default settings: Varies depending on the machine configuration
Exposure Type	Configure default exposure mode settings. Factory default settings: Auto
Copy Ratio	Specify the copy ratio that is selected by default. Factory default settings: 100%
Select magnification automatically according to paper size, when paper tray is selected.	The copy magnification is automatically changed according to the paper size in the selected paper tray. Factory default settings: Disable
2-Sided Copy	Configure the 2-sided mode settings that are selected by default. If this setting is used to change the default setting for the duplex function to any setting other than "1-Side to 1-Side" and the duplex function or automatic document feeder fails or is disabled, the setting will revert to "1-Side to 1-Side". Factory default settings: 1-Sided→1-Sided
Original Binding	Set the original binding in 2-Sided copy. Factory default settings: Book



Item	Description
Output	Set the print output method and output tray that are selected by default. Factory default settings: Auto
Output Tray	Set the default delivery tray. Factory default settings: Varies depending on the machine configuration
Offset	Set whether or not offset is performed in the default settings. Factory default settings: Enable
Separator Page	Separator pages can be inserted before or after jobs. Set the paper tray used for the separator pages. Factory default settings: Insert Before Job:Disable, Insert After Job:Disable
Staple Sort	Select staple settings. Factory default settings: 1 Staple
Staple Position	Set the staple position. Factory default settings: Left
Punch	Set the punch. Factory default settings: 3-Hole Punch
Fold	Set the paper folding. Factory default settings: Disable
Saddle Fold	Set the saddle fold. Factory default settings: Print Side:Fold Inside
Paper Size for Z-Fold	Select the paper size to use for Z-Fold. Factory default settings: Valid for all paper sizes
C-Fold	Set the print surface and opening method for C-Fold. Factory default settings: Print Side:Inside, Fold Orientation:Open Right
Accordion Fold	Set how to open accordion fold. Factory default settings: Fold Orientation:Open Right
Double Fold	Set the print surface and opening method for Double Fold. Factory default settings: Print Side:Inside, Fold Orientation:Open Right
Half Fold	Set the print surface and opening method for half fold. Factory default settings: Print Side:Inside
Trimming Width Settings	Sets the cutting width.
Return to the Defaults	This returns all items to the factory default settings.

Text /Image Printing

Text Settings (Stamp)

You can add fixed text used in the [Stamp] of copying.

Custom Stamp

You can set an image to be used in [Custom Stamp] in [Custom Image] for copying.

Custom Watermark

You can set an image to be used in [Custom Watermark] in [Custom Image] for copying.



Printer Settings

Settings related to the printer function can be configured.

Condition Settings

Printer condition settings are described below.

Prohibit Notice Page Printing

Disables to print a notice page.

Factory default settings: Enable

Prohibit Test Page Printing

Disables to print the test page.

When this setting is enabled, [Status] → [Data List] → [List for User] → [Printer Test Page] in "Settings" cannot be used to print test pages.

Factory default settings: Disable

A4/Letter Size Auto Change

When printing an 8-1/2" x 11" (letter) size image, this setting allows A4 size paper to be used if 8-1/2" x 11" size paper is not loaded. In addition, when printing an A4 size image, this setting allows 8-1/2" x 11" (letter) size paper to be used if A4 size paper is not loaded.

Factory default settings: Disable

A3/Ledger Size Auto Change

When printing 11" x 17" (ledger) size, if 11" x 17" size paper is not loaded in the paper tray, it will be printed on A3 paper. In addition, when printing A3 size, if A3 size paper is not loaded in the paper tray, it will be printed on 11" x 17" (ledger) paper.

Factory default settings: Disable

Bypass Tray Settings

Enable Detected Paper Size in Bypass Tray

This is used to prohibit printing when the paper size specified for a print job is different from the paper size inserted in the bypass tray.

Factory default settings: Disable

Enable Selected Paper Type in Bypass Tray

This is used to prohibit printing when the paper type specified for a print job is different from the paper type inserted in the bypass tray.

Factory default settings: Enabled

Exclude Bypass-Tray from Auto Paper Select

When [Auto] is selected for paper type selection, the bypass tray is excluded from the trays that can be selected. This is recommended when special paper is often placed in the bypass tray.

Factory default settings: Disable

Job Spool Queuing

When this function is enabled, received print jobs are displayed in the spool queue of the job status screen. The jobs are moved to the job queue after they have been analyzed by the machine.

Multiple jobs that have not yet been analyzed appear in the spool queue.

When this function is disabled, received print jobs are displayed in the job queue instead of being displayed in the spool queue. However, when an encrypted PDF job is printed, the job appears in the spool queue.

Factory default settings: Enable



Network Port Emulation Switching

This setting is used to select the emulated printer language when the machine is connected by a network port. The following settings can be configured.

Auto

Post Script

PCL

Factory default settings: Auto



Unless printer errors occur frequently, it is recommended that you use the factory default setting "Auto".

Port Switching Method

Selects when port switching takes place.

- **Switch at End of Job**

The port changes to auto selection when printing ends.

- **Switch after I/O Timeout**

When the time set in "I/O Timeout" elapses, the port changes to Auto Selection.

Factory default settings: Switch at End of Job



Initial Status Settings

If you print data in an environment where the printer driver is not used (that is, if you print data using the MS-DOS system or if you print data using the PC that does not have the provided printer driver installed), set the detailed printing conditions. (However, the "Disable Blank Page Print" function will be effective even when the PCL printer driver is used.)

Settings

Setting item	Description
Copies	1 - 9999 sets
Orientation	Portrait Landscape Factory default settings: Portrait
Paper Size	Set the default paper size. Factory default settings: Varies depending on the machine configuration
Output tray	Set the default delivery tray. Factory default settings: Varies depending on the machine configuration
Paper Type	Set the default paper type. Factory default settings: Plain Paper 1
Resolution Setting	600dpi 600dpi (High Quality) 1200dpi Factory default settings: 600dpi (High Quality)
Disable Blank Page Print	<input checked="" type="checkbox"/> (Enabled) <input type="checkbox"/> (Disabled) Factory default settings: It does not prohibit
Duplex printing	1-Sided 2-Sided (Booklet) 2-Sided (Tablet) Factory default settings: Portrait
N-Up Printing* ¹	N-Up 1-Up 2-Up 4-Up 8-Up Factory default settings: 1-Up
	Layout Left To Right* ² Right To Left* ² Upper-Left To Right* ³ Upper-Left To Lower* ³ Upper-Right To Left* ³ Upper-Right To Lower* ³ Factory default settings: 1-Up/2-Up: Left to Right, 4-Up/8-Up: Right, and Down
Fit To Page* ⁴	<input checked="" type="checkbox"/> (Use Fit to Page) <input type="checkbox"/> (Do not use Fit to Page) Factory default settings: Use Fit to Page
Output	<input checked="" type="checkbox"/> (Use Print per Unit) <input type="checkbox"/> (Do not use Print per Unit) Factory default settings: Use Print per Unit



Setting item	Description
Separator Page	<input type="checkbox"/> Insert Before Job <input type="checkbox"/> Insert After Job Factory default settings: Disable
Staple Sort* ⁵	None, 1 Staple at Back, 2 Staples, 2 Staples (Top), Stapleless Staple* ⁶ Factory default settings: Off
Punch* ⁷	<input type="checkbox"/> (Punch) <input checked="" type="checkbox"/> (Do not use Punch) Factory default settings: No Punch
Fold* ⁸	<input checked="" type="checkbox"/> (Fold the paper) <input type="checkbox"/> (Do not fold paper) Factory default settings: Insert After Job
Fold* ⁹	Set the paper folding. Factory default settings: Disable
Saddle Fold* ⁹	Set the saddle fold. Factory default settings: Print Side: Fold Inside
Paper Size for Z-Fold* ⁹	Select the paper size to use for Z-Fold. Factory default settings: Valid for all paper sizes
C-Fold* ⁹	Set the print surface and opening method for C-Fold. Factory default settings: Print Side: Inside, Fold Orientation: Open Right
Accordion Fold* ⁹	Set how to open accordion fold. Factory default settings: Fold Orientation: Open Right
Double Fold* ⁹	Set the print surface and opening method for Double Fold. Factory default settings: Print Side: Inside, Fold Orientation: Open Right
Half Fold* ⁹	Set the print surface and opening method for half fold. Factory default settings: Print Side: Inside
Trimming Width Settings* ¹⁰	Sets the cutting width.
Quick File	<input type="checkbox"/> (Enabled) <input checked="" type="checkbox"/> (Disabled)

*1 Paper sizes that can be used with this function are 11" x 17", 8-1/2" x 14", 8-1/2" x 11", A3, B4, and A4. (This function may not take effect with some print methods.)

*2 Can be selected when 2-Up is selected.

*3 Can be selected when 4-Up/8-Up is selected.

*4 Only effective when printing PDF, JPEG, and TIFF files.

*5 It can be used by connecting a finisher or saddle finisher.

*6 When the saddle finisher (large stacker) or finisher (large stacker) is installed.

*7 When a punch module is installed.

*8 When the saddle finisher or saddle finisher (large stacker) is installed.

*9 When the folding unit is installed.

*10 When the trimming module is installed.



PCL Settings

This is used to set the symbol sets, fonts, and line feed code used in a PCL environment.

Settings

Setting item	Settings
PCL Symbol Set Setting	Specify the symbol set used for printing. Factory default settings: PC-8
PCL Font Setting	Select a font used for printing. Factory default settings: Internal Font: 0: Courier
PCL Line Feed Code	This setting is used to select how the printer responds when a line feed command is received. Factory default settings: 0.CR=CR; LF=LF; FF=FF
Wide A4	When this is enabled, 80 characters per line are printed on the 8-1/2" x 11" (A4) size paper using a 10-pitch font. (When this setting is disabled, up to 78 characters are printed per line.) Factory default settings: Disable

PostScript settings

When an error occurs during PostScript printing, these settings determine whether or not an error notice is printed and whether or not the PostScript data is received in binary format.

Setting item	Settings
Screen Settings	Configure image settings for PostScript. Factory default settings: Standard
Print PS Errors	When a PS (PostScript) error occurs during PostScript printing, this setting determines whether or not an error notice is printed. Factory default settings: Disable
Binary Processing	Receive PostScript data in binary format. Factory default settings: Disable



OOXML Settings

When you print an Excel file directly, select the sheet for which you want to print or the entire workbook of the file.

Print Release Settings

Standard

Print Release Settings

Sets the use of print releases.

Factory default settings: Disable

Initial Status Settings

Print and Delete the Data

When [Enable] is selected, [Print and Delete the Data] is enabled in the print screen of the print release job.

Factory default settings: Enable

Print Order

Set the print order from the oldest date, or from the data list number.

Factory default settings: Date (Asc.)

Communication Timeout

Sets the communication timeout used in the print release.

Factory default settings: 10 seconds

Primary Unit Settings

Primary Unit

Set the multifunction device that saves the print release job to [Primary Unit].

Factory default settings: Disable

Require Authentication when Storing

Select whether or not authentication is required to store a print release job in the machine that is functioning as the primary unit.

Factory default settings: Enable

Force to Enable the Print Release Function

When this is ON and the machine is functioning as the primary unit, print jobs that are not print release jobs are also forcibly save as print release jobs.

Factory default settings: Disable

Delete Stored Data after Specified Time

Select whether or not stored print release jobs are automatically deleted after a set time elapses.

If you select [Enable], jobs that have been stored the number of days set in "Days" will be automatically deleted.

Factory default settings: Enable

Days

When "Delete Stored Data after Specified Time" is enabled, set the number of days jobs are stored.

Factory default settings: 7 days

Local Drive Status

Displays the usage status of the local drive.

Connecting Code

Enter a code for authentication between the primary unit and secondary unit. Maximum of 32 alphanumeric characters.

**Port Number**

Set the port number used for print release in the primary unit and in the secondary unit. Be sure to set the same number in both the primary unit and the secondary unit. (The default port number is "53000", and there is no particular need to change this.)

Factory default settings: 53000

Delete All

When the machine functions as the primary unit, select this to delete all stored print release jobs.

Destination Settings**Primary Unit 1 to Primary Unit 3**

Enter the addresses of the Primary Unit 1 to the Primary Unit 3.

Connecting Code

Enter a code for authentication between the primary unit and secondary unit. Maximum of 32 alphanumeric characters.

Port Number

Set the port number used for print release in the primary unit and in the secondary unit. Be sure to set the same number in both the primary unit and the secondary unit. (The default port number is "53000", and there is no particular need to change this.)

Factory default settings:53000

Advanced Settings**Extend Destination Group**

You can increase the number of groups by using the extension.

Factory default settings: Disable

Default Group

Select the group to be used in groups 1-10.

You can set the selected group as the default group for use in print releases. It is convenient to set a frequently used group because it will always be set to the selected group.

Factory default settings: Group 1

Destination Group Setting

Set the group to connect to.

Groups 1-10**Use This Group**

When [Enable] is selected, [Use This Group] is set on the print screen of the print release job.

Factory default settings: Disable

Primary Unit 1 address to Primary Unit 3 address, connection code, port number

Set the address, connection code, and port number of the base unit 1 to base unit 3 used in the group.

Factory default settings: Port Number:53000



E-mail Print Settings

Select this option to use the E-mail printing.

E-mail Print

Set whether or not E-mail print is performed.

Factory default settings: Disable

POP3 Server

Set the POP3 server used for E-mail.

Port Number

Set the port number of the E-mail server.

Factory default settings: 110

Authentication Option

Specify the authentication method for POP.

Select "OAuth 2.0" when using Microsoft365, Exchange Online, etc.

For information on how to configure the settings when OAuth 2.0 is selected, see "[OAuth 2.0 AUTHENTICATION \(page 9-39\)](#)".

Factory default settings: Plain Text Authentication

Provider

This can be set when "OAuth 2.0" is selected as "Authentication Option".

Select a provider.

Factory default settings: Microsoft

Account Name

This can be set when "OAuth 2.0" is selected as "Authentication Option".

Enter an account name.

Token

This can be set when "OAuth 2.0" is selected as "Authentication Option".

Displays the current token status.

Get Token / Delete

The "Get Token" key is displayed if the token has not been obtained, and the "Delete" key is displayed if the token has been obtained.

The "Get Token" key is displayed in the System Settings of the machine and is not displayed on the Web page.

User Name

This setting is available when you select "Authentication Option" other than "OAuth 2.0".

Set the E-mail user name.

Password

This setting is available when you select "Authentication Option" other than "OAuth 2.0".

Set the password used for E-mail.



Check Interval

Set the automatic e-mail check frequency (polling interval).

Factory default settings: 5 minutes

Enable SSL/TLS

Use when SSL/TLS is used.

Factory default settings: Disable



Direct Print Settings (FTP)

Configure these settings if you will be printing files on an FTP server by direct print.

A list of available FTP servers is shown. To add an FTP server, click the [Add] button and configure the settings.

FTP Server Registration

Configure FTP server settings.

Name

Set the name to be used for direct print.

FTP Server

Set the name of the FTP server.

Port Number

Set the port number of the FTP server.

Factory default settings: 21

Directory

Set the directory of the FTP server that has the files.

User Name

Set the user name used to log in to the FTP server.

Password

Set the password used to log in to the FTP server.

Enable SSL/TLS

Enable SSL/TLS

Factory default settings: Disable

Use PASV mode

Set to use PASV mode.

Factory default settings: Disable



Direct Print Settings (Network Folder)

Configure these settings if you will be printing files on a network folder by direct print.

A list of available network folders is shown. To add a network folder, click the [Add] button and configure the settings.

Registration of Network Folder

Configure network folder settings.

Name

Set the name to be used for direct print.

Folder Path

Set the folder path that has the files.

User Name

Set the user name used to log in to the network folder.

Password

Set the password used to log in to the network folder.

Print Setting from PC/Mobile Terminal

Configure these settings to print files on a computer or mobile terminal by direct print.

FTP Print

Specify whether or not FTP print settings are used for direct print.

Factory default settings: Enable

Port Number

Enter the port number used for direct print.

Factory default settings: 21

IPP Print (Driverless)

Print from the network using the IPP protocol without using a printer driver.

Factory default settings: Enable

geo URI (RFC5870)

You can set the location information of this machine.

Factory default settings: geo



Common Settings

Settings related to the image send function (E-mail, Internet fax, etc.) can be configured. The operation settings below apply to all image send functions.

Condition Settings

Hold settings for a while after scanning has been completed.

Use this setting to hold the settings after scanning is completed (until Auto Clear Mode activates).

Factory default settings: Disable

Job Auto Start Time During Scanning

Set the time at which transmission is automatically started even if the original is still being scanned.

Factory default settings: 60 seconds

Default Display Settings

When resending by document filing or recalling by saved program settings that do not include an address, select from the following 6 types of base screens that appear.

- E-Mail
- Network Folder
- FTP/Desktop
- Internet Fax
- Fax
- Data Entry

Factory default settings: Fax

Address Book Default Selection

Higher priority is given to the display of address book

If image send mode is enabled, the Address Book is displayed in place of the initial screen of this mode.

Factory default settings: Disable



In "Setting mode", if a default address has been configured by selecting [System Settings] → [Image Send Settings] → [Scan Settings] → [Default Address] → [Default Address Setting], the [Higher priority is given to the display of address book.] function cannot be used.

Apply Addresses of Sending Modes Only

When an address is selected from the address book, only the addresses displayed in narrowing mode are applied.

Factory default settings: Enable

Category Displayed as Default

Select a category to be displayed with the default.

- None
- Frequent Use
- Categories 1 to 32

Factory default settings: None

Display all address type regardless of the mode being displayed currently.

Displays all destinations regardless of the displayed mode when this setting is enabled.

Factory default settings: Disable

Enlarging the Address Book

An enlarged address book list appears.

Factory default settings: Enable



Image Orientation

Sets the default image orientation.

Factory default settings: Portrait

Preview Setting

Received Data Image Check Setting

Select whether or not a preview of received faxes and Internet faxes is shown. This is displayed when a facsimile expansion kit or Internet fax expansion kit is installed.

Factory default settings: Disable

Default List/Thumbnail Display

Fax/I-Fax Reception Data:

Fax/I-Fax Reception Data: Select whether the default display format of the received fax/I-Fax list screen is list or thumbnails.

Factory default settings: Thumbnail

Default Exposure Settings

This is used to set the default exposure settings for scanning a document in image send mode. Select [Auto] or [Manual]. If you select [Manual], set the exposure to one of 5 levels.

Factory default settings: Auto



When the exposure is set to [Auto], a default original type cannot be selected.

Default Original Image Type

Select the original type beforehand to enable scanning at a resolution suitable for the original (only in scan mode and USB memory device scan mode).

The following settings can be configured.

- Text/Printed Photo
- Text/Photo
- Text
- Photo
- Printed Photo
- Map

Factory default settings: Text

Sending the same image sent in Fax mode

Enable this when sending by broadcast transmission in Fax and other modes and you want to send the same image in all modes. If this function is disabled, an image specified with each Scan Setting is sent to E-mail, FTP, Desktop, and Network Folder. When an Internet Fax address is included in the addresses, the same image is sent regardless of this setting.

Factory default settings: Disable

Be sure to press Next Address Key ([+]) before selecting the next address.

Set whether or not the Next Address ([+]) key must be pressed before an address is added for a multi-address job such as broadcast transmission.

Factory default settings: Disable



Disable Switching of Display Order

Disables to change the order of display (search number order, ascending, descending).

Once set, the display sequence is not changed. The display order will remain fixed at the order that is in effect when this setting is enabled.

Factory default settings: Disable

Hold Setting for Received Data Print

This function holds received faxes and Internet faxes in memory without printing them. The faxes can be printed by entering a password (factory default setting: 0000) with the numeric keys.

Factory default settings: Disable

Password

When [Hold Setting for Received Data Print] is enabled, enter the password (4-digit number).



- These settings can only be configured when there is no received data in the machine memory (excluding data in a confidential or relay broadcast memory box).

Erase Width Adjustment

This is used to set the default erase width for erase function. Specify a value from 0" (0 mm) to 1" (25 mm) in increments of 1/8" (3 mm) for both edge erase and center erase.

Factory default settings: Edge Clearance Width: 1/2" (10mm), Center Clearance Width: 1/2" (10mm)

Time Specified Output of Received Data

This function is available when the Received Data Image Check Setting is enabled. * This is displayed when a facsimile expansion kit or Internet fax expansion kit is installed.

If "Time Specified Output of Received Data" is set to , this setting is grayed out.

If "Change Password" or "Hold Setting for Received Data Print" is set to , the password entry field is grayed out.

Factory default settings: Disable



Enable/Disable Settings

Settings to Disable Registration

Storing from the machine, storing from Setting mode (Web version), and storing from the PC can each be separately prohibited.

Disable Registering Destination from Operation Panel

Disables address control from the machine.

Configure the setting for each of the following items:

- Group (Direct Entry)
- Group (Address Book)

Select All: Select all items.

Clear Checked: Deselect all items.

Factory default settings: All Invalid

Disable Registering Destination on Web Page

Disables to store the destination from Setting mode (Web version).

Configure the setting for each of the following items:

- Group (Direct Entry)
- Group (Address Book)

Contacts

Select All: Select all items.

Clear Checked: Deselect all items.

Factory default settings: All Invalid

Disable Registration/Deletion of All Program Items

This is used to prohibit the deletion and changing of image send settings stored in job programs.

Factory default settings: Disable

Disable Registration of Memory Box

Disables all types of memory box registration.

Configure the setting for each of the following items:

Polling Memory, Confidential, Relay Broadcast (Direct Entry), Relay Broadcast (Address Book)

Factory default settings: All Invalid

Disable Destination Registration Using Global Address Search

This disables address control from the global address search.

Configure the setting for each of the following items:

E-mail, Internet Fax, Fax

Factory default settings: All Invalid

Disable Registration Using Network Scanner Tools

This disables address control from the Network Scanner Tools.

Use this option to suppress to store data of another machine through Inbound Routing of address book.

Factory default settings: Disable

Disabling of Forwarding via Network

This prohibits inbound routing.

Factory default settings: Disable



Settings to Disable Transmission

These settings are used to disable the following transmission operations.

Disabling Sending History

Prohibits resending using the sending history.

Factory default settings: Disable

Disable Selection from Address Book

Disables the selection of destinations from the address book.

Configure the setting for each of the following items:

- E-mail
- FTP
- Desktop
- Network Folder
- Internet Fax (including Direct SMTP)
- Fax

Select All: Select all items.

Clear Checked: Deselect all items.

Factory default settings: All Invalid

Disable Direct Entry

Disables the direct entry of destination address and others.

Configure the setting for each of the following items:

- E-mail
- Network Folder
- Internet Fax (including Direct SMTP)
- Fax

Select All: Select all items.

Clear Checked: Deselect all items.

Factory default settings: All Invalid

Disabling of PC Scan

Prohibits remote PC scans.

Factory default settings: Disable

Disable Storing to External Memory Device

Prohibits saving scan data to an external memory device.

Factory default settings: Disable

Disable PC-I-Fax Transmission

This prohibits PC-I-Fax transmission.

Factory default settings: Disable

Disable PC-Fax Transmission

This prohibits PC-Fax transmission.

Factory default settings: Disable

Disabling of Find My Address

This prohibits Find My Address.

Factory default settings: Disable

Disabling of OCR

Prohibits the use of the OCR function when scanning.

Factory default settings: Disable



Own Name and Destination Set

Stores the Internet-Fax or Fax sender information.

Sender Data Registration

Use this to store the sender name for fax and Internet fax, the sender fax number, and the sender address for Internet fax. The stored sender name and sender fax number or Internet sender address will be printed at the top of the received fax.

Sender Name

Enter the default sender name.

Sender Fax Number

Sets the sender fax number.

To insert a pause between digits of the number, tap the [-] key.

To insert a space between digits of the number, tap the [Space] key.

I-Fax Own Address

Enter the default source address.

Registration of Own Name Select

Stores the sender name used in "Own Name Select " of another function. Up to 18 sender names can be stored.

Add New

Store a sender name. A maximum of 20 characters can be stored.

After entering a sender name, tap the [Store] key.

The lowest unused registration number from 01 to 18 will be automatically assigned to the sender name. This number cannot be changed.

Sender Name List

Displays a list of stored sender names.

When you select a sender name, it is deleted.

Category Setting

This setting can be set on this machine. This setting is the same as "[Category Setting \(page 10-38\)](#)".



Scan Settings

The following settings are related to the scanner.

Initial Status Settings

Default Color Mode Settings

Select a default color mode setting for both color and black & white in e-mail address, network folder, FTP and Desktop. Specify "Scanner Common" unless E-mail is specified.

Settings

Auto (Mono2, Grayscale*), Full Color, Grayscale, Mono2

* When scanning a black and white original with the color mode set to [Auto]

Factory default settings: Mono2

File Type

Disables black & white settings from the base screen when the color mode is set to Auto.

Factory default settings: Disable

Initial File Format Setting

Specify the initial file format for sending a file in E-mail, Network Folder, FTP, or Desktop mode. Specify "Scanner Common" unless E-mail is specified.

File Format

PDF, PDF/A-1a, PDF/A-1b, TIFF, JPEG, Compact PDF, Compact PDF (Ultra Fine), Compact PDF/A-1a, Compact PDF/A-1a (Ultra Fine), Compact PDF/A-1b, Compact PDF/A-1b (Ultra Fine), Encrypt PDF, Encrypt/Compact PDF, Encrypt/Compact PDF (Ultra Fine), XPS, RTF, TXT(UTF-8), DOCX, XLSX, PPTX



If [Disabling of OCR] is set, you cannot select above file format

PDF, PDF/A, TIFF, JPEG, Compact PDF, Compact PDF (Ultra Fine), Compact PDF/A, Compact PDF/A (Ultra Fine), Encrypt PDF, Encrypt/Compact PDF, Encrypt/Compact PDF (Ultra Fine), XPS

Factory default settings: PDF

OCR Setting*

If the file format is PDF, the characters in the scanned image are read and the character information is added to the PDF.

Factory default settings: Disable

Black & White

Compression Mode: None, MH (G3), MMR (G4)

Factory default settings: MMR(G4)

Color/Grayscale

Data compression ratio: Low, Medium, High.

Factory default settings: Medium

Reduce Colors

Factory default settings: Disable



Specified Pages per File

Generates a separate file for each scanned page when multiple pages are scanned.

If this setting is enabled, a number of pages per file can be specified.

Factory default settings: Disable

Number of Pages

Any number of pages can be specified as the number of pages per file. This setting can be used if [Specified Pages per File] is enabled.

Factory default settings: 1

OCR Settings*

Configure the settings that are required for OCR.

Font*

Set the font used for each recognized character language.

Factory default settings: Western Languages:Arial, Japanese:MS gothic, Simplified Chinese:SimSun, Traditional Chinese:MingLiU, Korean:Dotum

Detect Image Direction*

The orientation of the scanned original is automatically detected.

Factory default settings: Enable

File Name Extraction*

Extract the file name.

Factory default settings: Disable

* Not available when the OCR function is disabled.



When [JPEG] is selected for the file type, [Specified Pages per File] cannot be selected.

Easy Scan Settings

Set the default color mode for Easy Scan.

Set [Color] for when the Color Start key is tapped, and [Black & White] for when the B/W Start key is tapped.

Setting item	Settings
Color	Auto Full Color
Black & White	Grayscale Mono2

Factory default settings: Color:Auto, Black & White:Mono2

Resolution Setting

The following settings are available for the default resolutions of common scan, E-mail, Internet fax, and fax mode.

Scanner Common

100X100dpi, 150X150dpi, 200X200dpi, 300X300dpi, 400X400dpi, 600X600dpi

E-mail

100X100dpi, 150X150dpi, 200X200dpi, 300X300dpi, 400X400dpi, 600X600dpi

Apply the Resolution Set when Stored

When an image stored by document filing is used, this applies the resolution setting that was stored with the image.

Factory default settings: Apply the Resolution Set when Stored:All Invalid, Resolution:200×200dpi

Original Skew Adjustment

When the document is tilted or the image in the document is tilted, the tilted state is automatically corrected and the data is saved.

Factory default settings: Disable



Condition Settings

Default Reply Address Set

The information stored here is used if you do not specify [Reply to] in the send settings when performing Scan to E-mail.

Factory default settings: Disable

Bcc Setting

Enable Bcc

Enable this setting if you wish to use Bcc delivery. Displays the [Bcc] key on the image send address book screen.

Factory default settings: Disable

Display Bcc Address on the Job Status Screen

Displays Bcc addresses on the job status screen and address list tab.

Factory default settings: Disable

Quick On Line Sending

When this setting is enabled, the machine starts transmitting a fax as soon as the first page is scanned.

Transmission takes place at the same time as the remaining pages are being scanned.

PDF Compression Options

Flate Compression

When sending a PDF file, you can compress the file by Flate Compression to reduce the file size.

Factory default settings: Enable

Highly compressed PDF resolution settings

Set the resolution when saving as a highly compressed PDF.

Factory default settings: 300x300dpi

Compression Mode at Broadcasting

Selects the compression mode for broadcasting using Scan to E-mail or Internet fax. The compression mode set here is used for all destinations regardless of their individual compression mode settings.

Black & White

MH (G3), MMR (G4)

Color/Grayscale

Low, Medium, High

Reduce Colors

Reduce the file size by limiting the number of colors and shades used.

Factory default settings: B/W:MH(G3), Color/Grayscale:Middle, Reduce Colors:Disable

Send Destination Link Settings

Enable this to send only the URL of scanned data to the destination.

Factory default settings: Disable

Enable Send Destination Link as Default

Enable this to always send only the URL of scanned data to the destination. When this function is enabled and you are in simple mode, only the URL is sent to the e-mail address. When normal mode is used, the [Send Destination Link] checkbox is always in the action panel that appears in the home screen of Scan to E-mail.

Factory default settings: Disable



File Retention Period

Set the save period for scanned data saved in the machine when sending only the URL to the destination. When this period elapses, the files are automatically deleted.

Factory default settings: 4

Enable SSL/TLS

Use this to protect files using SSL/TLS transmission.

Factory default settings: Enable

Maximum Size of Send Data (E-Mail)

To prevent the transmission of excessively large image files by Scan to E-mail, a file size limit can be set from 1 MB to 99 MB in increments of 1 MB. If the total size of the image files created by scanning the original exceeds the limit, the image files are discarded.

If you do not wish to set a limit, select [Unlimited].

Factory default settings: Unlimited



This setting is linked to "[Maximum Size of Send Data \(page 10-103\)](#)" of the Internet fax settings.

If the E-mail attachment(s) exceed maximum size, it will be sent in multiple files.

If an E-mail attachment exceeds the maximum size, it will be sent in multiple files. If one of the divided files exceeds the maximum size, it will be sent with the resolution automatically lowered.

When sending files in JPEG format, only one file is attached to one e-mail, regardless of the file size.

If a file scanned in TXT(UTF-8), RTF, DOCX, XLSX, or PPTX format exceeds the file size limit, the file will be discarded without being sent even if this setting is selected.



- When a file scanned to a format other than TXT(UTF-8), RTF, DOCX, XLSX, or PPTX exceeds the size limit, this function reduces the data size below the limit by lowering the resolution or other means, and thereby enables sending without canceling the data.
- When multi-crop, Image Crop, Send Destination Link and card scan are used, the scanned data is not divided. If the e-mail exceeds the set size limit, a send error occurs.

Maximum Size of Send Data (FTP/Desktop/Network Folder)

A limit can be set for the size of files that can be sent by Scan to FTP, Scan to Desktop, and Scan to Network Folder. Limits that can be selected are 50 MB, 150 MB, and 300 MB. If the total size of the image files created by scanning the original exceeds the limit, the image files are discarded.

If you do not wish to set a limit, select [Unlimited].

Factory default settings: Unlimited



During broadcasting that includes both e-mail and Internet fax destinations, the limit set in "[Maximum Size of Send Data \(page 10-103\)](#)" precedes.



Auto Scan Setting

Configure auto scan setting.

Factory default settings: Disable

Set Image Orientation Automatically

The orientation of placed originals can be automatically detected. Set whether the original is scanned by one-sided scanning or two-sided scanning.

Factory default settings: Enable

Set Resolution Automatically

You can have the machine automatically set the resolution.

Factory default settings: Enable

Blank Page Skip

Set whether or not blank original pages are automatically skipped during scanning.

Factory default settings: Blank Page Skip

Automatically Detect Mono2/Grayscale

Originals Automatically Detect Mono2/Grayscale.

Factory default settings: Enable

Detection Standard

Automatically Detect Mono2/Grayscale.

Factory default settings: 3 (Normal)

Automatically Adjust Skewed Original

The tilt of the document is automatically corrected.

Factory default settings: Enable

When using the document feeder, the document size is automatically determined.

The original size is automatically determined when the original is read by the automatic original feeder.

Factory default settings: Enable

If it is determined to be a business card, a business card information file is also created.

If it is determined that the card is a business card based on the original size, the business card information is also saved using the OCR function.

Factory default settings: Enable

File Format of Card Info

Set the file format of business card information.

Factory default settings: vCard (*.vcf)

Use Full Name on Card as the File Name

The name of the business card is the name of the file that stores the business card information.

Factory default settings: Enable

Set Compression Ratio Automatically

Automatically selects the best compression ratio from the original document.

Factory default settings: Enable

Preset restriction of E-mail for direct input

Enable this setting to prohibit e-mail transmission to an address that has an unsuitable domain. A file will not be sent if the e-mail address is entered directly and the domain is one of the set domains.



Default Address

Default Address Setting

A default address can be stored that makes it possible to transmit by simply pressing the [Color Start] key or the [B/W Start] key without specifying an address.

If [Apply E-mail address of the user for login.] is selected, the E-mail address of the login user is set as the default destination. When [Apply Home Directory of The User for Login] is selected, the default address is the home directory of the user that logged in.

When the user logs in by internal authentication (authentication by the machine), the home directory setting of the user that logged in is configured in "User Registration" in "User List" in "User Control". When the user logs in by external authentication (network authentication), the home directory setting is configured in "Global Address Book Settings" in "LDAP Settings" in "Network Settings".

Factory default settings: Disable



Only a single default address can be set for Scan to E-mail, Scan to FTP, Scan to Desktop, and Scan to Network Folder.

Add Selected

Select an address that is to be used by default.

Apply E-mail address of the user for login.

The E-mail address of the login user is set as the default address.

Select [Allow cancel of the first entered address] based on your intended use.

Apply Home Directory of The User for Login

The home directory of the login user is set as the default address.

Select [Allow cancel of the first entered address] based on your intended use.

Select From Address Book

To display your desired address book, narrow the search by alphabet or category with the list of [Index]. You can select the number of addresses that are to be displayed at a time with [Display Items].

When you select the desired address name and tap the [Store] key, the selected address can be selected for the default address.

Allow cancel of the first entered address

You can cancel the E-mail address of the login user that is entered automatically. To cancel, tap the [x] button next to the address entry field.

When this setting is disabled, selection of an address other than the entered default address is prohibited.

Factory default settings: Disable



If an e-mail address is not set for the logged-in user, scanner transmission cannot be used.

Apply Login Name to the Path of Network Folder

Append the login name of the logged-in user to the path of the network folder.

Add a Subfolder Path to the End of the Home Directory Path

You can add more folders (subfolders) after the home directory path you have set, and make them the default address.

This setting is available only when [Default Address Setting] is [Enable] and [Apply Home Directory of The User for Login] is selected.

Factory default settings: Disable

Subfolder Path

Enter the path of the subfolder.

The entries here will be used as the subfolder name, and this folder will be set as the default address folder.

You can specify two or more levels of folders by entering "\". If the subfolder does not exist, a folder will be created.

For example, if you enter \AAA\BBB, the default address will be the subfolder AAA\BBB of the configured home directory.

**Disable selection of other address(es)**

It is prohibited to send to other than the default destination.

Factory default settings: Disable

Subject Name Settings

Default Subject

Set the title of the e-mail, such as sending an e-mail or sending an Internet fax.

Pre-Set Registration

You can save a preset subject for transmitted files. Click the [Add] key and set the subject.

File Name Settings

Default Settings for File Names

File Naming

You can select the information included in the name of scanned files.

Unit Serial Number

You can add the machine's serial number to the file name.

Factory default settings: Disable

Text

You can add any text to the file name.

Factory default settings: Disable

Sender Name

You can add the sender's name to the file name.

Factory default settings: Enable

Date & Time

You can add the date and time of transmission to the file name.

Factory default settings: Enable

Session Page Counter

You can add counter information to the file name.

Factory default settings: Disable

Unique Identifier

An ID number can be created for each file and added to the file name.

Factory default settings: Disable

Direct Entry/Pre-Set Text Selection Settings

Add Date & Time

Add the date and time to the end of the file name when the file name to be sent is set by direct input or fixed phrase selection.

Factory default settings: Disable

Pre-Set Registration

Add the date and time to the end of the file name when the file name to be sent is set by direct input or fixed phrase selection.



Message Body Settings

Add Job Information Automatically to the Mail Message Body

Add Job Information Automatically to the Mail Message Body

You can automatically add job information to the body message of e-mail.

Factory default settings: Enable

Add a Footer Automatically to the Mail Message Body

You can add any text as a footer to the body message of e-mail.

Factory default settings: Disable

Mail Footer Registration

Set any text to be added when [Add a Footer Automatically to the Mail Message Body] is enabled.

Message Body Settings

You can save a preset e-mail subject and body message (fixed text). Click the [Add] key.



Fax Settings

You can select the image send settings of fax functions.

Condition Settings

The fax settings can be enabled or disabled to suit the needs of your workplace.

Resolution Setting

You can select the resolution setting for faxes.

Apply the Resolution Set when Stored

Select this to use the resolution at which the fax was sent.

If you do not select [Apply the Resolution Set when Stored], the image will be stored at the resolution specified in the pull-down menu.

Factory default settings: Disable

Dial Mode Setting

Select the line type from the list.

Auto Select

Select this after the line has been connected to have the machine automatically detect whether your line is a pulse dial line or a tone dial line. (Set manually when using a 10 pps rotary dial.)

Factory default settings: Tone

Auto Wake Up Print

When the [Power] button is "Off" (but the main power switch is "On") and a fax is received, this function activates the machine and prints the fax.

When this function is disabled, received faxes are not printed until the [Power] button is switched "On".

Factory default settings: Enable

Pause Time Setting

Changes the length of pauses inserted in fax numbers.

If a hyphen (-) is entered when dialing or storing a fax number, a pause of 2 seconds is inserted.

It can be set between 1 and 15 seconds, in every second.

Factory default settings: 2 seconds

Fax Dest. Confirmation Mode

This setting specifies whether or not a destination verification message is displayed when sending a fax in order to prevent accidental transmission to the wrong destination.

Factory default settings: Disable

Remote Reception Number Setting

You can set the machine to the fax reception mode by entering a one-digit number from the connected extension telephone and by tapping the  key. This one-digit number is called the Remote Reception number, and it can be between 0 and 9.

Factory default settings: 5



Display Fax Screen when External Telephone is Off-hook

When an external phone is connected, the touch panel displays that the external phone is on-hook.

Factory default settings: Enable



Do not use this function when an external telephone is not connected. You may not be able to receive faxes properly.

Transaction Report Print Select Setting

Selects whether or not a transaction report will be printed, and if printed, the condition for being printed. Select a setting for each of the following operations:

Single Sending

- Print Out All Report
- Print Out Error Report Only
- No Printed Report

Broadcasting

- Print Out All Report
- Print Out Error Report Only
- No Printed Report

Receiving

- Print Out All Report
- Print Out Error Report Only
- No Printed Report

Confidential Reception

- Print Out All Report
- No Printed Report

When a transaction report is printed, this is used to print part of the first page of the transmitted original on the transaction report. For more information, see "[Original Print on Transaction Report \(page 10-102\)](#)".

Factory default settings: Single Sending: Print Out Error Report Only, Broadcasting: Print Out All Report, Receiving: No Printed Report, Confidential Reception: Print Out All Report



Even if a print setting is enabled for "Receiving", a transaction report will not be printed if you receive from a number that is rejected with the "[F-Code Memory Box \(page 10-99\)](#)".

Activity Report Print Select Setting

You can set the machine to periodically print the activity report that is stored in memory.

The Image Sending Activity Report can be set to print each time the number of transactions reaches 200, or at a specified time (once a day only). (The settings can be simultaneously enabled.)

Factory default settings: Auto Print at Memory Full: Disable, Print Daily at Designated Time: Disable



- If you only select the "Print Daily at Designated Time" setting and the number of recorded transactions reaches 200 before the specified time, each new transaction will delete the oldest transaction (the oldest transaction will not be printed).
 - The Transaction Report can be printed out manually as needed. For more information, see "[List for Administrator \(page 10-32\)](#)".
-

Super G3 Setting

This setting is set when the destination does not correspond to Super G3.

Factory default settings: Enable



ECM

When you send a fax, noise on the line may occasionally cause distortion of the image. You can enable ECM (Error Correction Mode) to automatically resend only the part of the image that was distorted.

Factory default settings: Enable



If the receiving machine is a Super G3 machine, ECM will always operate, regardless of this setting.

Digital Line Network

When this setting is enabled, the send level will be 15 dB or less when you connect to a digital line.

Factory default settings: Disable

Distinctive Ring Detection

If multiple telephone numbers have been assigned to your telephone line, the number called can be identified by its ringing pattern. By using one number for voice calls and another number for faxes, you can tell which type of call you are receiving by the ringing pattern. You can set your machine to automatically receive faxes when your fax number is called by setting the pattern that corresponds to your fax number.

Factory default settings: Disable

Send Setting

Make settings related to fax transmission.

Auto Reduction Sending Setting

Set to automatically reduce according to the chart paper size of the other party.

If you cancel the setting, the actual size will be sent without automatic reduction. In this case, part of the original may not be printed because it does not match the size of the chart paper of the other party.

Factory default settings: Enabled

Rotation Sending Setting

When transmitting an image that is one of the following sizes, this function rotates the image 90 degrees counterclockwise. (The setting can be configured separately for each size.)

8-1/2"x11", 5-1/2"x8-1/2"R, A4, B5R, A5R, 16K

Factory default settings: All enable



8-1/2" x 11"R and A4R size images are not rotated.

Quick On Line Sending

When this setting is enabled, the machine starts transmitting a fax as soon as the first page is scanned.

Transmission takes place at the same time as the remaining pages are being scanned.

Factory default settings: Enable

Printing Page Number at Receiver

When the transmitted image is printed by the receiving machine, the page number can be added to the top of each printed page.

Factory default settings: Enable



Sender Destination Name Switch

Allows you to change the destination name and sender fax number if necessary.

Factory default settings: Fax No.

Date/Own Number Print Position Setting

This setting determines the position of the date and sender information printed at the top of faxes by the receiving machine. To have the information printed outside the transmitted document image, tap the [Outside the Original Image] key. To have the information printed inside the document image, tap the [Inside the Original Image] key.

For more information on the print position, see "[ADDING YOUR SENDER INFORMATION TO FAXES \(FAX OWN NUMBER SENDING\) \(page 5-79\)](#)".

Factory default settings: Outside the Original Image

Recall in Case of Line Busy

This program is used to set the number of recall attempts and the interval between recall attempts when a transmission is not successful due to the line being busy or other reason.

Number of Times to Recall When Line is Busy

This setting specifies whether or not recalling is performed when the line is busy. During recalling, you can set the number of recall attempts. Any number from 1 to 15 can be selected.

Factory default settings: 2 Time(s)

Interval to Wait Between Recall Attempts (min.) When Line is Busy

The interval between recall attempts can be set. Any number of minutes from 1 to 15 can be selected.

Factory default settings: 3 minutes



When this setting is enabled, note that the machine will not attempt the call again when manual transmission or direct transmission is used.

Recall in Case of Communication Error

This determines how many times the machine will automatically attempt the call again if a fax transmission fails due to a communication error.

Number of Times to Recall in Case of Error

Specify how many times the machine will attempt the call again when a communication error occurs. During recalling, you can set the number of recall attempts. Any number from 1 to 15 can be selected.

Factory default settings: 2 Time(s)

Interval to Wait Between Recall Attempts (min.) in Case of Error

The interval between recall attempts can be set. Any number of minutes from 1 to 15 can be selected.

Factory default settings: 3 minutes



When this setting is enabled, note that the machine will not attempt the call again when manual transmission or direct transmission is used.

Disable Fax Broadcasting

Disables facsimile broadcasting.

Factory default settings: Disable



Receive Settings

Settings for fax transmission can be configured.

Number of Calls in Auto Reception

This setting is used to select the number of rings on which the machine automatically receives a call and begins fax reception in auto reception mode.

The "Number of Calls in Auto Reception" that can be set in each area are shown in the following table.

Factory default settings: 2 Time(s)



If you select "0" for the number of rings, the machine will immediately answer and begin fax reception without ringing in auto reception mode.

Switching to Automatic Reception

When there is an incoming fax in manual reception mode, it automatically switches to automatic reception. Also, set the number of times the ringer sounds before switching to automatic reception between 1 and 9 times.

Factory default settings: 9 times

2-Sided Printing of Received Data

This is used to have received faxes printed on both sides of the paper.

When this setting is enabled and a fax consisting of 2 or more pages is received (the pages must be the same size), the pages are printed on both sides of the paper.

Factory default settings: Disable

Auto Receive Reduce Setting

When a fax is received that includes printed information such as the sender's name and address, the received image is slightly larger than the standard size. This setting is used to automatically reduce the image to fit the standard size.

Factory default settings: Enable



- If Auto Receive Reduce is disabled, the edges of the image outside the standard size will be cut off. However, the image will be clearer because it will be printed at the same size as the original.
- Standard sizes are sizes such as 8-1/2" x 11" and 5-1/2" x 8-1/2" (A4 and B5).

Print Style Setting

This setting determines the paper selection condition when printing received faxes. Select one of the three conditions below.

Print Actual Size Cut off Disabled

The received fax image is printed at its actual size (without dividing it onto multiple sheets of paper). If the same size of paper or larger paper is not loaded, the fax will be received in memory and will not be printed until a suitable size of paper is loaded.

However, if the received fax is longer than 11" x 17" (A3) size, it will be automatically divided onto multiple sheets of paper.

Print Actual Size Cut off Enabled

Each received image is printed at full size. If necessary, the image is divided onto multiple sheets of paper.

Auto Size Select

Each received image is printed at actual size when possible. When not possible, the image is automatically reduced before printing.

Factory default settings: Auto Size Select



Print Received Data on the Paper Size Selected

Prints the received data in a size suitable for the received data.

Factory default settings: Disable

Set the Telephone Number for Data Forwarding

When a problem prevents the machine from printing a received fax, the received fax can be forwarded to another fax machine. This setting is used to program the fax number of the destination fax machine. Only one forwarding fax number can be programmed (maximum of 64 digits).

To insert a pause between digits of the number, tap the [-] key.

If you wish to specify an F-code confidential memory box in the destination machine, tap the [/] key after entering the fax number and enter the F-code (sub-address and passcode).

Letter Size RX Reduce Print

This program is available in Canada and Philippines

When a letter-R (8-1/2" x 11"R) size fax is received, this setting reduces the fax to A4R size.

When this setting is enabled, A4R size faxes are also reduced.

Factory default settings: Disable

Receiving Date & Time Print

Enable this setting to have the date and time of reception printed.

Select [Inside the Received Image] or [Outside the Received Image] for the position where the date and time is printed.

When [Inside the Received Image] is selected, the date and time of reception is printed on the received image.

When [Outside the Received Image] is selected, the received image is reduced and the date and time of reception is printed in the blank area that results.

Factory default settings: Disable



The [Outside the Received Image] cannot be selected for the reception date and time print setting if "[Auto Receive Reduce Setting \(page 10-96\)](#)" is not enabled.

A3 RX Reduce

This program is not available in Canada and Philippines

When an A3 size fax is received, this function reduces the fax to ledger (11" x 17") size.

When this setting is enabled, ledger (11" x 17") size faxes are also reduced.

Factory default settings: Disable

Output tray

Select the output tray for received faxes.

Number of Prints

Set the number of copies of received faxes that are printed to any number from 1 to 99.

Factory default settings: 1

Staple Settings

When a finisher is installed, set the position at which received faxes are stapled.

Factory default settings: 1 Staple at Back



- This setting can only be used when the [Multiple Set Print] and [Staple] checkboxes are selected in "Fax Settings".
- Up to 50 pages can be stapled. (When the paper is oriented horizontally, up to 30 sheets can be stapled.) The maximum number of staples is 5 for stapleless staples.



Paper Size

When a finisher is installed, select the paper used for printing of received faxes.

Factory default settings: 8-1/2" x 11" or 8-1/2" x 11"R (A4 or A4R)

Fold Size Setting

Set the paper size to be used when folding the received data when printing.

Factory default settings: Valid except for A4R and Letter-R(8 1/2x11R)

Allow/Reject Number Setting

Use this setting to specify whether reception from a stored number is to be allowed or rejected.

Item	Description
Reject Reception	Reject reception from the stored number.
Allow Reception	Allow reception from the stored number.
All Invalid	Even if numbers have been stored, disregard the numbers and allow reception from all numbers.
Add New	Adds a new address or domain (maximum of 50) from which reception is to be rejected or allowed. Enter the number (maximum of 20 digits) and tap the [Store] key.
Registration Number List	A list of the stored numbers can be displayed. When you select a number from this screen, it is deleted from the list.
Reject Unknown Calls	If checked, any call from the number of Reject Unknown Calls setting is rejected, regardless of the certain number receive settings.

Factory default settings: All Invalid

Reject Unknown Calls

Rejects a call if the caller has blocked the sending of caller identification information.

Factory default settings: Disable



When there are no stored anti junk mail addresses or domains, only the [Add New] key can be selected.

Fax Polling Security

The following settings are for regular polling memory using the Public Box.

Polling Security

When the memory polling function is used, this setting determines whether any machine will be allowed to poll your machine, or only machines that have been stored in your machine.

Factory default settings: Enable

Add New

When the Polling Security Setting is enabled, use this setting to store (or delete) the fax numbers of the machines that are allowed to poll your machine.

Up to 10 destination fax numbers can be stored. Each number must be within 20 digits in length.



Passcode Number Key List

This shows a list of the stored passcode numbers. Select a number from the list and delete it.



Please note that the contents set here do not apply to F-code bulletin board transmission.

F-Code Memory Box

This section explains how to store memory boxes for various types of F-code communication.

Storing a memory box

When you tap the [Add New] key, the registration screen appears. Up to 100 F-code memory boxes can be stored for all functions (polling memory, confidential, and relay broadcast).

Editing and deleting a memory box

When you select a memory box from the list, the edit screen appears for the box.

For information on the settings, see "Settings".

Tap the [Delete] key to delete the memory box.

Settings

Item	Description
Items common to all types	
Box Type	Select the type of box. Polling Memory: Store a memory box for F-code polling memory. The sub-address and passcode that you store in the memory box are necessary for the other machine to poll the machine (request transmission) using F-code communication. Confidential: Store a memory box for F-code confidential communication. In addition, store a "Print PIN" in the memory box to print faxes received by confidential reception. The sub-address and passcode that you program in the memory box are necessary for the other machine to send a fax to the machine by F-code confidential transmission. Relay Broadcast: Store a memory box for F-code relay broadcast transmission. Relay Broadcast: Store a memory box for F-code relay broadcast transmission. Up to 30 destinations can be stored to forward the received data. The sub-address and passcode that you program in the memory box are necessary for the other machine to send a fax to the machine by F-code relay request transmission. Factory default settings: Box Type:Polling Memory
Memory Box Name	Enter a name (maximum of 18 characters) for the memory box.
Sub Address/Passcode	Enter a sub-address and passcode. A maximum of 20 digits can be entered for each sub-address and passcode. Separate a sub-address and passcode by a slash ("/").
Items displayed when storing a confidential memory box	
Print PIN	Set a "Print PIN" for confidential reception. Enter a 4-digit number.
Items displayed when storing a relay broadcast memory box	



Item	Description
Recipients	Select the end recipients of the relay broadcast. Select the recipients from the address book. Select Forward Address from the Address Book: Select an address from the address book. Destination Entry: An address that is not stored in the address book can be directly entered. Enter the address in the same way as when storing an address for a mode.



- When programming a new memory box, a sub-address that is already programmed for another box cannot be used.
- However, the same passcode can be used for more than one memory box. [] and [#] cannot be used in a sub-address.
- A passcode can be omitted.
- Do not forget the Print PIN. In the event that you forget the Print PIN or need to verify the Print PIN, contact your dealer or nearest SHARP Service Department.



Internet Fax Settings

Settings related to the image send function (Internet fax, Direct SMTP, etc.) can be configured.

Condition Settings

Configures the default settings for Internet fax.

Resolution Setting

Apply the Resolution Set when Stored

You can apply the resolution setting that was set when the file was saved to transmission of the file.

Factory default settings: Disable

Resolution

Set the resolution used for file transmission.

Factory default settings: 200×100dpi

Half Tone

Enable half-tones.

Factory default settings: Disable

Initial File Format Setting

File Format

This is used to set the file type for Internet fax transmission.

The following settings can be configured.

- TIFF-S
- TIFF-F

If one of the following functions is set, the image will be sent in TIFF-F format even if TIFF-S is set.

- Mixed Size Orig.
- Dual Page Scan
- Book Divide
- Card shot
- 2in1

Compression Mode

This is used to set the compression mode for Internet fax transmission.

The following settings can be configured.

- MH (G3)
- MMR (G4)

Factory default settings: File Type:TIFF, Compression Mode:MH (G3)



[MMR (G4)] cannot be selected when [File Type] is set to [TIFF-S].

Auto Wake Up Print

When the [Power] button is "Off" (but the main power switch is "On") and an Internet fax is received, this function activates the machine and prints the fax.

When this function is disabled, received Internet faxes are not printed until the ([Power] button) is switched "On".

Factory default settings: Enable



Original Print on Transaction Report

When a transaction report is printed, this is used to print part of the first page of the transmitted original on the transaction report. Select one of the settings below.

- Always Prints
- Print at Error
- Do not Print

This setting will not be effective if the next "[Print Out Error Report Only \(page 10-102\)](#)" is set to "Do not Print".

Factory default settings: Print at Error

Print Out Error Report Only

Selects whether or not a transaction report will be printed, and if printed, the condition for being printed. Select a setting for each of the following operations:

Transmission

- Always Prints
- Print Out Error Report Only
- Do not Print

Broadcasting

- Always Prints
- Print Out Error Report Only
- Do not Print

Reception

- Always Prints
- Error Only
- Do not Print

When a transaction report is printed, this is used to print part of the first page of the transmitted original on the transaction report. For more information, see "[Original Print on Transaction Report \(page 10-102\)](#)".

Factory default settings: Single Sending:Print Out Error Report Only, Broadcasting:Always Print, Receiving:Do not Print

Activity Report Print Select Setting

Prints the Image Sending Activity Report stored in the machine memory periodically.

The Image Sending Activity Report can be set to print each time the number of transactions reaches 200, or at a specified time (once a day only). (The settings can be simultaneously enabled.)

Factory default settings: Auto Print at Memory Full:Disable, Print Daily at Designated Time:Disable, Body Text Print Select Setting:Disable



- If you only select the "Print Daily at Designated Time" setting and the number of recorded transactions reaches 200 before the specified time, each new transaction will delete the oldest transaction (the oldest transaction will not be printed).
- The Transaction Report can be printed out manually as needed.
See "[List for Administrator \(page 10-32\)](#)".

Body Text Print Select Setting

Image files attached to Internet faxes are normally printed. This setting can be enabled to also have the e-mail body text (subject and message) printed.

This setting also applies to printing of the body text of e-mail messages without file attachments.

Factory default settings: Disable



A maximum of 5 pages of body text can be printed.



Send Setting

These settings are used to configure the settings for Internet fax.

I-Fax Reception Report On/Off Setting

This setting is used to request a reception report when an Internet fax is sent.

Factory default settings: Disable

I-Fax Reception Report Request Timeout Setting

The duration of time that the machine will wait for a reception report from the destination machine can be set by any number from 1 hour to 240 hours in increments of 1 minute.

Factory default settings: 1 Hour



This setting is only effective when "[I-Fax Reception Report On/Off Setting \(page 10-103\)](#)" is enabled.

Number of Resend Times at Reception Error

The number of resend attempts when an error message is received from an I-Fax recipient can be set to any number from 0 to 15.

Factory default settings: 2 Time(s)



This setting is only effective when "[I-Fax Reception Report On/Off Setting \(page 10-103\)](#)" is enabled.

Maximum Size of Send Data

To prevent the transmission of excessively large image files by Internet fax, a file size limit can be set from 1 MB to 99 MB in increments of 1 MB. If the total size of the image files created by scanning the original exceeds the limit, the image files are discarded.

If you do not wish to set a limit, select [Unlimited].

Factory default settings: Unlimited



This setting is linked to "[Maximum Size of Send Data \(E-Mail\) \(page 10-87\)](#)" in Scan Settings.

Rotation Sending Setting

When transmitting an image that is one of the following sizes, this function rotates the image 90 degrees counterclockwise. (The setting can be configured separately for each size.)

5-1/2"x8-1/2"R, A4, B5R, A5R, 8-1/2"x11", 16K

Factory default settings: All Enabled



8-1/2" x 11"R and A4R size images are not rotated.



Default Own Number Sending

You can include the date and your sender information (sender name and address) at the top of the page when the receiving machine prints an image that you send.

Factory default settings: Enable

Printing Page Number at Receiver

When the transmitted image is printed by the receiving machine, the page number can be added to the top of each printed page.

Factory default settings: Enable

Recall in Case of Line Busy

(This setting is only effective for Direct SMTP transmission.)

This setting sets the number of recall attempts and the interval between recall attempts when a transmission is not successful due to the line being busy or other reason.

Number of Times to Recall When Line is Busy

This setting specifies whether or not recalling is performed when the line is busy.

During recalling, you can set the number of recall attempts.

Any number from 0 to 15 can be selected.

Factory default settings: 2 Time(s)

Interval to Wait Between Recall Attempts (min.) When Line is Busy

The interval between recall attempts can be set. Any number of minutes from 1 to 15 can be selected.

Factory default settings: 3 Minute(s)

Recall in Case of Communication Error

(This setting is only effective for Direct SMTP transmission.)

This determines how many times the machine will automatically attempt the call again if a fax transmission fails due to a communication error.

Number of Times to Recall in Case of Error

Specify how many times the machine will attempt the call again when a communication error occurs.

During recalling, you can set the number of recall attempts.

Any number from 0 to 15 can be selected.

Factory default settings: 2 Time(s)

Interval to Wait Between Recall Attempts (min.) in Case of Error

The interval between recall attempts can be set. Any number of minutes from 1 to 15 can be selected.

Factory default settings: 3 Minute



Receive Settings

Configures the settings for Internet fax.

Auto Receive Reduce Setting

When a fax is received that includes printed information such as the sender's name and address, the received image is slightly larger than the standard size. This setting is used to automatically reduce the image to fit the standard size.

Factory default settings: Enable



- If Auto Receive Reduce is disabled, the edges of the image outside the standard size will be cut off.
- However, the image will be clearer because it will be printed at the same size as the original.
- Standard sizes are sizes such as 8-1/2" x 11" and 5-1/2" x 8-1/2"(A4 and B5).

2-Sided Printing of Received Data

This is used to have received faxes printed on both sides of the paper.

When this setting is enabled and a fax consisting of 2 or more pages is received (the pages must be the same size), the pages are printed on both sides of the paper.

Factory default settings: Disable

Set Address for Data Forwarding

When the machine cannot print a received fax, the fax can be forwarded to another machine. This setting is used to configure the address of the other machine.

Forwarding to

Enter the forwarding address (maximum of 64 characters).

Direct SMTP

Select this to enable forwarding when direct SMTP is used.

Factory default settings: Disable

Add Hostname or IP Address.

Select this to separately enter a host name or IP address.

Factory default settings: Disable

Hostname or IP Address

Use this setting when "Add Hostname or IP Address." is enabled. Enter the host name or IP address (maximum of 64 characters).



Multiple forwarding addresses cannot be stored.

Letter Size RX Reduce Print

This program is available in Canada and Philippines.

When a letter-R (8-1/2" x 11"R) size fax is received, this setting reduces the fax to A4R size.

When this setting is enabled, A4R size faxes are also reduced.

Factory default settings: Disable



Receiving Date & Time Print

Enable this setting to have the date and time of reception printed.

Select [Inside the Received Image] or [Outside the Received Image] for the position where the date and time is printed.

When [Inside the Received Image] is selected, the date and time of reception is printed on the received image.

When [Outside the Received Image] is selected, the received image is reduced and the date and time of reception is printed in the blank area that results.

Factory default settings: Disable



The [Outside the Received Image] cannot be selected for the reception date and time print setting if "[Auto Receive Reduce Setting \(page 10-105\)](#)" is not enabled.

A3 RX Reduce

This program is not available in Canada and Philippines

When an A3 size fax is received, this function reduces the fax to ledger (11" x 17") size.

When this setting is enabled, ledger (11" x 17") size faxes are also reduced.

Factory default settings: Disable

POP3 Communication Timeout Setting

The duration of time the machine waits until stopping reception can be set from 30 to 300 seconds in increments of 30 seconds if no response is received from the mail server (POP3 server).

Factory default settings: 60sec.

Reception Check Interval Setting

Specifies an interval at which the machine automatically checks the mail server (POP3 server) for received Internet faxes. The interval can be set from 0 minutes to 8 hours in increments of 1 minute.

If 0 hours 0 minutes is specified, the machine does not automatically check the mail server for received Internet faxes.

Factory default settings: 0 hours 0 minutes



The machine also checks the mail server (POP3 server) for received Internet faxes when the main power is switched on. (Except when 0 hours 0 minutes is specified.)

I-Fax Output Setting

This sets the output tray for received Internet faxes.

The items that appear will vary depending the machine configuration.



Allow/Reject Mail or Domain Name Setting

Allows or refuses a reception from specified addresses/domains.

Item	Description
Item	Reception from the stored address/domain is not allowed.
Allow Reception	Reception from the stored address/domain is allowed.
All Invalid	All Invalid
Add New	Adds a new address or domain (maximum of 50) from which reception is to be rejected or allowed. Enter the address/domain (maximum of 64 characters) and tap the [Store] key. If the first character of the entry is not "@", the entry is identified as an address. If the first character is "@", the entry is identified as a domain. (xxx@xx.xxx.□□□ is treated as an address, and @xx.xxx.□□□ is treated as a domain.) Storing an address specifies only that address. Storing a domain specifies all addresses that include that domain.
Registered address or domain list	Displays a list of the stored addresses and domains. An address or domain can be deleted from the list when selected.

Factory default settings: All Invalid



When there are no stored anti junk mail addresses or domains, only the [Add New] key can be selected.

Server Settings

Receive Settings

Internet fax reception

Set whether or not Internet Fax reception is performed.

Factory default settings: Enable

POP3 Server

Enter the POP3 server name to use.

Port Number

Specify the port number of the POP3 server to be used.

Factory default settings: 110

Authentication Option

Specify the authentication method for POP.

Select "OAuth 2.0" when using Microsoft365, Exchange Online, etc.

For information on how to configure the settings when OAuth 2.0 is selected, see "[OAuth 2.0 AUTHENTICATION \(page 9-39\)](#)".

Factory default settings: Plain Text Authentication

Provider

This can be set when "OAuth 2.0" is selected as "Authentication Option".

Select a provider.

Factory default settings: Microsoft

Account Name

This can be set when "OAuth 2.0" is selected as "Authentication Option".

Enter an account name.

Factory default settings: 60sec.

Token

This can be set when "OAuth 2.0" is selected as "Authentication Option".

Displays the current token status.

**Get Token / Delete**

The "Get Token" key is displayed if the token has not been obtained, and the "Delete" key is displayed if the token has been obtained.

The "Get Token" key is displayed in the System Settings of the machine and is not displayed on the Web page.

User Name

This setting is available when you select "Authentication Option" other than "OAuth 2.0".

Enter a maximum of 64 characters for the user name used to access the server.

Password

This setting is available when you select "Authentication Option" other than "OAuth 2.0".

Enter a maximum of 32 characters for the password used to access the server.

POP3 Communication Timeout

Set a timeout for communication to the POP3 server.

Reception Check Interval Setting

Enter an acknowledge cycle to the POP3 server.

Factory default settings: 0 hours 0 minutes

Enable SSL/TLS

Allows the POP over SSL/TLS communication or the POP over TLS communication by STLS command. This requires the server to support the POP over SSL/TLS communication or the STLS command.

To allow the POP over SSL/TLS communication, set the "Port Number" to the POP over SSL/TLS communication port number.

To allow POP over TLS communication, set the "Port Number" to the same port number as for the normal POP3 communication.

Factory default settings: Disable

Connection Test

Tap the [Execute] button to test the connection to the POP3 server.

Default Settings

Own Number and Name Set**Set I-Fax Own Name**

Enter the name of the sender when sending an Internet fax.

Set I-Fax Own Address

Enter the source address when sending an Internet fax.

Direct SMTP Settings

Port Number (Receive), Port Number (Send)

Specify the port number used for transmission and reception by direct SMTP.

Factory default settings: 25

Timeout

Set the wait time until transmission or reception is canceled when a response is not received from the server during direct SMTP transmission/reception.

Factory default settings: 300 seconds



Fax Data Receive/Forward (Manual)

Fax Settings

Item	Description
Receive Settings	Set the fax reception method. Auto Reception: When a call comes in, the machine rings and then automatically begins fax reception. Auto Reception: When a call comes in, the machine rings and then automatically begins fax reception. Manual Reception: Used when an existing external telephone is connected to the machine. You can answer to a phone call first, and then receive a fax by manual operation. Factory default settings: Auto Reception
Multiple Set Print	Specify whether or not two or more copies of received faxes will be printed. The number of copies can be set with the " Number of Prints (page 10-97) " Factory default settings: Disable
Staple	Specify whether or not stapling is performed. Set the binding method with " Staple Settings (page 10-97) ". Factory default settings: Disable
Fold	Specify whether or not folding is performed. Factory default settings: Disable
Forward Received Data	When the machine cannot print because it is out of paper or out of toner, received faxes can be forwarded to another previously stored fax machine.



- If there is no forwarding data or if the destination is not registered, no data is forwarded.
- If "[Hold Setting for Received Data Print \(page 10-80\)](#)" is enabled, you will be prompted for a password. Enter the correct password using numeric keys.
- If some pages of a fax that is being forwarded were successfully printed, only those pages that were not printed will be forwarded.
- A forwarded fax becomes a fax transmission job. If transmission does not take place because the transmission was canceled or an error occurred, the fax will be held in memory until it can be printed.
- All faxes received are forwarded. Note that the received data stored in the F-code confidential memory box is not forwarded.
- For destination number registration, see "[Set the Telephone Number for Data Forwarding \(page 10-97\)](#)".

Internet Fax Settings

These settings can be configured when the Internet fax expansion kit is installed.

Reception Start

Tap this key to immediately connect to your mail server (POP3 server) and check for received Internet faxes. If you have received Internet faxes, the faxes will be retrieved and printed.

Manual Reception Key in Initial Screen

This displays the [Internet Fax Manual Reception] key in the base screen of Internet fax mode.

Factory default settings: Enable



Forward Received Data

When the machine cannot print because it is out of paper or out of toner, received faxes can be forwarded to another Internet fax machine.



- To cancel forwarding
- Tap the job status display and cancel fax forwarding in the similar way as for a transmission job.
- Forwarding is not possible if no faxes were received or a forwarding fax number is not programmed.



- To enable "Reception Start", the POP3 server settings must be configured. See [Application Settings] in "Settings" → [Internet Fax Settings].
- To register a forwarding address, see "[Set Address for Data Forwarding \(page 10-105\)](#)" in "Settings".
- If forwarding was not successful because the transmission was canceled or a communication error occurred, the faxes that were to be forwarded will return to the print queue on the machine.
- If the initial pages of a fax were successfully printed, only those pages that were not printed will be forwarded.
- If you select [System Settings] in "Settings" → [Image Send Settings] → [Operation Settings] → [Default Settings] and if "Hold Setting for Received Data Print" is enabled, you are prompted to enter a password. Enter the correct password using numeric keys.
- This setting can only be set on web pages.



Inbound Routing (Forwarding/Storing) Settings

Inbound Routing Settings

The fax and Internet fax received data can be forwarded according to the stored forwarding table.

When this function is enabled, you can also have the received Internet faxes forwarded to a specified e-mail address without printing them.

Registration of Forward Table

You can store or edit the data forwarding table that has the received data forward settings.

Up to 50 data forwarding tables can be stored.

A single forwarding table can store up to 500 sets of sender number and source address combinations.

Up to 1000 destinations can be stored in all data forwarding tables combined.

- When you select the recipients from the address book, up to 1,000 recipients can be registered for e-mail and up to 400 recipients can be registered for network folder, FTP/Desktop, Internet fax, and fax.
- When enter the recipients directly, up to 100 recipients can be registered for e-mail address, network folder, FTP/Desktop, Internet fax, and fax.

Item	Description
Table Name	Enter a forward table name.
Receive Line Select	Selects a data receive line. Factory default settings: All Enabled
Sender Address Setting	Select the sender facsimile number or the Internet fax address. Before you select a sender number or address, store the destination number or address. To forward all received data, select [Forward All Received Data]. Factory default settings: Forward All Received Data
Forward Condition 1/2/3	You can set the forwarding date and destination. <ul style="list-style-type: none"> • Forward Condition: Set the data forwarding conditions. • Day of week: Select a day of week to start data forwarding. • Start time: Set a time to start data forwarding. • End time: Set a time to end the data forwarding. • Format for Forwarding: Select a format of forwarding data. Factory default settings: Forward Condition:No Forwarding, Day of the Week:All Invalid, Set Forwarding Time:Disable, Start Time:00:00, Completing Time:0:00, Format for Forwarding:TIFF(Multi)
Forwarding Destination List	Lists the addresses that can be set as the destination. Select a destination by setting it to <input checked="" type="checkbox"/> .
Add (Selecting from Address Book)	Open the address book and enter a forwarding destination.
Add (Direct Entry)	Enter the destination name directly.
Delete	Deletes the selected address.



Sender Address Registration

Stores new sender number or address to be used for inbound routing.

List name	Settings
Address to be Entered	Displays the entered sender number or address.
Fax Number	Enter a facsimile number to be stored as the sender. When you enter multiple sender numbers, separate them by a semicolon (;) or a comma (.). When you tap the [Global Address Search] key, the global address search screen appears.
Internet Fax Address	Enter an Internet fax address to be stored as the sender. When you enter multiple sender numbers, separate them by a semicolon (;) or a comma (.). When you tap the [Global Address Search] key, the global address search screen appears.
Delete	Deletes the selected sender number or address.
Add to List	Adds the entered sender number to the list.

Administration Settings

Stores the administration settings to be used for inbound routing.

List name	Settings
Inbound Routing	Sets the inbound routing function. Factory default settings: Disable
Disable Registration of Forward Table	Disables the registration of forward table. Factory default settings: Disable
Disable Change/Delete of Forward Table	Disables a change of forward table. Factory default settings: Disable
Disable Change of Forward Condition	Disables a change of data forwarding conditions. Factory default settings: Disable
Received fax print settings	Sets a print style of received data. If you have selected the [Always Save] or [Save Only at Error] option, enter a file name. Factory default settings: Print at Error
Preset characters	Set the characters added to the file name when a file is saved. When "Character 1" and "Character 2" are set in "File Naming No. 1 to No. 7", the set characters are added to the file name. Enter up to 64 full-width/half-width characters.
File Naming No.1 to No.7	Set the information included in the file name when saving a file. Factory default settings: No.1:Sender Name, No.2:Date & Time, No.3~No.7:None
If received from a contact registered in the address book, sender's name is changed to contact's name.	When the sender of the data is stored in the address book, the sender information is changed to the name stored in the address book. Factory default settings: Disable



1

Enable the [Inbound Routing] function.

Tap the [Administration Settings] from the menu.
Enable the [Inbound Routing] function from the setting screen.

2

Store the sender number or address.

Tap the [Sender Number/Address Registration] from the menu.
Enter the destination number or address that you wish to store.



If you wish to forward all received data, you need not store the sender number and address separately.

3

Store a forwarding table.

Tap the [Inbound Routing Settings] from the menu.
Tap the [Add] key on the displayed screen.
When the [Table Registration] screen appears, store the forwarding table.

4

Enable the stored forwarding table.

Tap the [Inbound Routing Settings] from the menu.
Set the forwarding table name that you wish to enable to .

To specify forwarding conditions, select [Forward based on the Conditions of Forward Destination 1-3], and also select [Always Forward] or [Forward on Selected Day & Time]. If you have selected the [Forward on Selected Day & Time] option, you can set the forwarding date and time in advance.



Inbound Routing (Storage) Settings

Settings for Local Drive Storing of Received Data

An external account application can be added and controlled.

Configure settings for saving received faxes to the local drive.

Item	Description
Auto Storing of Received Data in Local Drive	Set whether received faxes are saved to the local drive. Factory default settings: Disable
Specifying Data to be Stored	Select which received faxes are saved. Select from line 1 and Internet Fax. Factory default settings: All Invalid
Specifying Stored Folder	Specify the folder in which received faxes are saved. Enter a folder name no longer than 32 full-width/half-width characters.
Sort Received Faxes by Date in Folders	Configure settings to have date folders created and received faxes saved to the folders by date. Factory default settings: Disable
Print Style Setting	Configure print settings for received faxes. Save and print: Save received faxes to local drive, and also print. Only print when save error occurs: Print received fax when save fails. Save in inbound routing error box when save fails: When save fails, save the fax in the inbound routing error box. Factory default settings: Print Only at Storage Error
File format	Select the file format for inbound routing. Factory default settings: PDF
Preset of Character	Set the characters added to the file name when a file is saved. When "Character 1" and "Character 2" are set in "File Naming No. 1 to No. 7", the set characters are added to the file name. Enter up to 64 full-width/half-width characters.
File Naming No.1 to No.7	Set the information included in the file name when saving a file. Factory default settings: No.1:Sender Name, No.2:Date & Time, No.3~No.7:Off
If received from a contact registered in the address book, sender's name is changed to contact's name.	When Sender name of "File Naming" is enabled, you can change the sender name to a name in the address book. Factory default settings: Disable
Reception notification settings	Set whether notification is sent by e-mail when a fax is received. Factory default settings: Disable
Address of Notification Destination	Shows the address to which the notification is sent.
Direct Entry	Enter the notification address. Enter a maximum of 1500 half-width characters for the address.
Global Address Search	Select the address from the global addresses.
Add to list	An address directly entered or found by global address search is saved as the notification address.



Metadata Settings

If the Application Integration Kit is installed, you can control the metadata to be used in other applications. The stored metadata is displayed on the metadata settings page. You can add a metadata, and edit or delete an existing metadata.

- **[Add] key**
Adds a new metadata set.
- **List display**
Lists the currently stored metadata sets.

Metadata Delivery

Enables or disables the metadata delivery function.

Factory default settings: Disable

Metadata Set Registration

When you tap the [Add] key, the registration screen appears. Up to 10 items can be stored. For each setting, see the following "[Settings \(page 10-115\)](#)".

Edit or Delete Metadata Set

When you tap a title on the list, the edit screen appears for that metadata set. Tap the [Delete] key to delete the metadata set.

Settings

Item	Description
Metadata Set Name	Enter a metadata name.
Metadata Destination	Select a destination where you wish to send the image and metadata.
Allow Custom Filenames	Enable or disable to edit the name of image file and XML file to be sent by the metadata send job. Factory default settings: Disable
Address Type Allowing Metadata Entry	Set the destination information to be used for metadata transmission. Factory default settings: All Invalid
Name	Enter a metadata name to be displayed on the touch panel.
XML Tag Name	XML Tag Name
Entry Type	Direct entry: Allows direct entry of each metadata from the soft keyboard or the numeric keypad. Metadata list: Allows a selection of metadata from the previously entered data list. You must enter optional values for metadata selection in the input area. Entries must be separated by semicolons or commas. Each option can be comprised of up to 70 characters. Initial entry by default: Uses a default value as the first value of the entered metadata list. Factory default settings: Direct Entry:Disable, Selection List:Disable
Include MFP Extended Scan Settings in XML File.	When the machine generates metadata automatically, the "metadataSetName", "userLoginId" (if user authentication is used), "pageSize", and "imageMode" are added to the metadata. Factory default settings: Enable
To Be Used as Default	The current metadata set is used as the default. Factory default settings: Disable



Document Filing Settings

Condition Settings

Document filing settings are described below.

Tap the [Document Filing Settings] key to configure the settings.

Default Mode Settings

Specifies which mode, Sharing or Confidential, is used as the default mode when storing a file.

When [Confidential Mode] is selected, the [Confidential] checkbox is set to on the information screen for filing.

Factory default settings: Sharing Mode

Sort Method Setting

Selects an order of display files stored in the Main Folder, Custom Folder, and Quick File Folder. Select one of the following settings:

- File Name
- User Name
- Date

Factory default settings: Date

Administrator Authority Setting

For files and user folders that have a password, this setting allows the administrator password to be entered instead of the password when accessing the file or folder.

Also, you can change the preset ratio if necessary.

Factory default settings: All Invalid

Delete All Quick Files

Deletes all files from the Quick File folder except for protected files.

Delete

Tap this key to start deletion of all files immediately.

Delete quick files at power up.(Protected files excluded)

This is used to automatically delete all files in the Quick File Folder (with the exception of protected files) when the [Power] button is turned "On".

Factory default settings: Enable



The condition of the machine may prevent deletion in some cases.

Image Orientation

Changes the image orientation.

Factory default settings: Portrait



Default Color Mode Settings

Selects the default settings for black & white and color when Scan to Local Drive is used. The following settings can be configured.

- Auto
- Full Color
- Grayscale
- Mono2

Factory default settings: Auto, Mono2

Disable Change of B/W Setting in Auto Mode

Disables black & white settings from the base screen when the color mode is set to Auto.

Factory default settings: Disable

Default Exposure Settings

Default exposure settings for document filing can be configured.

Select [Auto] or [Manual].

If you select [Manual], set the exposure to one of 5 levels.

Factory default settings: Auto

Default Original Image Type

Select the original type beforehand to enable scanning at a resolution suitable for the original.

The following settings can be configured.

- Text/Printed Photo
- Text/Photo
- Text
- Photo
- Printed Photo
- Map

Factory default settings: Text



When the exposure is set to [Auto], a default original type cannot be selected.

Initial Resolution Settings

One of the following resolutions can be selected for the default resolution for transmission.

- 100X100dpi
- 150X150dpi
- 200X200dpi
- 300X300dpi
- 400X400dpi
- 600X600dpi

Factory default settings: 200×200dpi

Default Output Tray

Selects the default output tray for printing a file stored by Scan to Local Drive.

The items that appear will vary depending the machine configuration.



Disabling Text/Stamp printing at Reprint

When a stored file is retrieved and printed, the printing functions are disabled.

This function prevents an inconsistency of the date between the original data and output data and others.

Factory default settings: Disable

Batch Print Settings

Set whether or not the [All Users] key and the [User Unknown] key are prohibited in the user name selection screen when printing all files.

Factory default settings: Selection of [All Users] is not allowed.:Enable, Selection of [User Unknown] is not allowed.:Enable

Print Order Setting for the Batch Print/Multi-File Print

Sets whether the files are ordered by date (newer/older) or by file name (ascending/descending).

Factory default settings: Date (Dsc.)

Erase Width Adjustment

This is used to set the default erase width for erase function.

Specify a value from 0" (0 mm) to 1" (25 mm) in increments of 1/8" (3 mm) for both edge erase and center erase.

Factory default settings: Edge Clearance Width:10mm (1/2"), Center Clearance Width:10mm (1/2")

Card Shot Settings

This is used to set the default original size for the card shot function.

Specify a value from 1" (25 mm) to 8-1/2" (216 mm) in increments of 1/8" (3 mm) for both the X (horizontal) and Y (vertical) dimensions of the original.

Factory default settings: Original Size:X: 86 mm (3-3/8"), Y: 54 mm (2-1/8")

Fit to Store Size

Always displays the [Fit to Store Size] key on the card shot screen.

Factory default settings: Disable

Setting of store/delete after file print

Select whether or not to save or delete a file after printing.

Factory default settings: Store

Default Setting of PDF Format for PC Browsing

You can set the initial file format of public PDF or the file for download which is created during execution of each job.

B/W, Color/Grayscale

Set the compression format for B/W, and the compression rate for Color/Grayscale.

For B/W, select from uncompressed, MH (G3), MMR (G4).

For Color/Grayscale, select the file compression ratio from Low, Medium, and High.

Settings during each job execution

When each of copy, printer, scanner, Internet fax, fax, or stored scan data is executed, you can specify to create a public PDF and to set the resolution of public PDF.

Factory default settings:B/W:Compression Mode:MMR(G4)

Color/Grayscale:Compression Ratio:Middle

Copy:Disable, Apply the resolution at job execution:Disable, Resolution:200dpi×200dpi

Printer:Disable, Apply the resolution at job execution:Disable, Resolution:200dpi×200dpi

Scanner:Disable, Apply the resolution at job execution:Disable, Resolution:200dpi×200dpi

Internet fax:Disable, Apply the resolution at job execution:Disable, Resolution:200dpi×200dpi

FAX:Disable, Apply the resolution at job execution:Disable, Standard

Scan to Local Drive:Disable, Apply the resolution at job execution:Disable, Resolution:200dpi×200dpi



Document Output Options

The use of a stored file can be allowed or prohibited by operation type and by the mode from which the file was stored.



The items that appear will vary depending on the functions that have been added to the machine.

Item	Description
Print	For each mode, select whether or not printing of stored files is allowed. Factory default settings: Copy:Enable, Printer:Enable, Scan Send:Disable, Internet Fax Send(Incl. PC-I-Fax):Disable, Fax Send(Incl. PC-Fax):Enable, Scan to Local Drive:Enable
Scan Send	For each mode, select whether or not fax transmission of stored files is allowed. Factory default settings: Copy:Disable, Printer:Disable, Scan Send:Enable, Internet Fax Send(Incl. PC-I-Fax):Disable, Fax Send(Incl. PC-Fax):Disable, Scan to Local Drive:Enable
Internet Fax Send (including PC-I-Fax)	For each mode, select whether or not fax transmission of stored files is allowed. Factory default settings: Internet Fax Send(Incl. PC-I-Fax):Enable
Fax Send (Including PC-Fax)	For each mode, select whether or not fax transmission of stored files is allowed. Factory default settings: Copy:Disable, Printer:Disable, Scan Send:Disable, Internet Fax Send(Incl. PC-I-Fax):Disable, Fax Send(Incl. PC-Fax):Enable, Scan to Local Drive:Disable

Custom Folder Registration

This setting can be set on this machine. This setting is the same as the registration method of "[Custom Folder \(page 10-39\)](#)".



Automatic Deletion of File Settings

Document filing settings are described below. Tap the [Document Filing Settings] key to configure the settings. Time and folder settings can be configured to have files in specified folders (stored by document filing) automatically deleted at a specified time. Up to 3 settings can be stored to be automatically deleted. The procedure for using this function is as follows:

- (1) Select [Setting 1], [Setting 2], or [Setting 3].
- (2) Set the time and date for automatic deletion.
- (3) Select the desired folder.
- (4) Specify whether or not protected files and confidential files are to be deleted.
- (5) Enable the stored settings.

Item	Description
Schedule	Select an automatic deletion cycle. Select from [Delete by Schedule] and [Delete at Specified Time after Specified Days Have Elapsed]. Delete by Schedule Every Day: Auto deletion every day at the specified time. Every Week: Auto deletion at the specified time on the specified day of the week. Every Month: Auto deletion at the specified time on the specified day of the month. Delete at Specified Time after Specified Days Have Elapsed The file is automatically deleted at the specified time after the specified number of days have passed since the file was saved. Elapsed date and time: Set the elapsed date and time. Delete time: Automatically deletes at the specified time. Factory default settings: Delete by Schedule, Every Day
Folders	To select individual folders, select [Select Folder] and select any folder. To select all folders, including the folder currently being created, select [All Folders (Including folders registered hereafter)]. Factory default settings: Select Folders from List Below
Delete Protected File	Enable this setting to include protected files in the deletion. Factory default settings: Enable
Delete Confidential File	Enable this setting to include confidential files in the deletion. Factory default settings: Enable

Delete Now

When this is executed with a folder selected, all files in the folder will be immediately deleted regardless of the date and time setting.

Executing automatic deletion during Auto Power Shut-Off.

(If this is not selected, the files will be deleted after the machine wakes from auto power shut-off mode.)

Execute Auto Deletion even if Auto Power Shut-Off is enabled. When the checkbox is not selected (), the files will be deleted after the machine wakes from auto power shut-off mode.

Factory default settings: Disable



Sharp OSA Settings

Condition Settings

Sharp OSA version

Displays the version of Sharp OSA Settings by this unit.

Cookie Settings

Specify how application cookies are handled when using an application in Sharp OSA.

When "Hold Cookie" is selected, the machine holds cookies that are used in an application.

When "Not hold Cookie" is selected, cookies are not held when an application is used.

Factory default settings: Not hold Cookie



- Only when user authentication is enabled, the machine holds cookies when [Hold Cookie] is enabled.
- When "Hold Cookie" is selected, the login information from the previous operation may be stored. Note that when the fixed user login setting is enabled, all users can use the login information stored in the machine.

Delete Cookie

Delete cookies held by the machine.

Automatically Start an Application at Power up and Wake up

After the machine has been turned on, or after it has recovered from an auto power shut-off, it will automatically start the registered applications.

Application

Set the applications to be launched automatically.

Accept remote access request from application

Check this when using a Sharp OSA application that is accessed remotely from the outside of this unit.

Application allowed to access

Register the application URL of the Sharp OSA application that allows remote access to this machine.

Approve remote access request on operation panel

When you start using the remote access function, the approval dialog is displayed on the operation panel of the main unit.

Accept UI operation request from application

Select this when using an application that operates the UI of this machine.

Display the connecting dialog while in Sharp OSA mode

During remote access, the connecting dialog is displayed on the operation panel of the main unit.

Accept secondary send request from Sharp OSA application

Accept secondary send request from Sharp OSA application



Standard Application Settings

The standard application settings can be added and controlled.

- [Add] key
When "Hold Cookie" is selected, the machine holds cookies that are used in an application.
- List display
When "Not hold Cookie" is selected, cookies are not held when an application is used.

Store Standard Application

When you tap the [Add] key, the registration screen appears. Up to 64 items can be stored. For information on the settings, see "Settings".

Edit or Delete Standard Application

When you tap an application name on the list, the edit screen appears for that standard application. Tap the [Delete] key to delete the standard application.

Settings

Item	Description
Application Name	Enter an application name.
Address for Application UI	Set an IP address of the application or a network name to control the UI of the machine.
Timeout	Enter a timeout. The default setting is 20 seconds.
Expansion Platform	Set this option to use the expansion platform.
Data Size	Set the screen size of application.
Use Custom Icon*	Select whether or not custom icon is used.
File Name*	Reports file name.
Select File*	Type the file name.

* These functions can be set only in the Web page.



Receiving Application Setting

The Fax or I-Fax Receive functions can be set in the Sharp OSA applications.

Settings

Item	Description
Forward to Application	The Fax or I-Fax message reception can be controlled by Sharp OSA applications.
Application Name	Enter the application name to receive.
Address for Web Service	Enter the Web service address.
Timeout	Enter a timeout. The default setting is 20 seconds.
E-mail Address	Enter the address to which a notification e-mail is sent when an application connection error occurs.
Body Text	Enter the body message that appears in the notification e-mail for connection errors.

External Accounting Application Settings

An external account application can be added and controlled.

Set the server name where you have installed the external accounting application.

Item	Description
Server 1-4	Set to enable each of the servers.
Application Name	Enter an application name.
Use Embedded Application	Set when using an embedded application.
Address for Application UI*	Enter the URL of the login screen to be accessed first when the machine is turned on.
Address for Web Service	Enter the URL of the server or computer which sends commands and events by XML/SOAP protocol.
Timeout	Enter a timeout. The default setting is 20 seconds.
Extended Platform	Set this option to use the expansion platform.
Data Size*	Set the screen size of application.
Find My Address	This Search Find My Address.

* This setting can be set in Server 1.



Embedded Application Settings

Store and manage "embedded applications" that are installed in the machine.

- [Add] key
Adds a new embedded application.
- List display
Lists the currently installed embedded applications.

Install Embedded Application

When you tap the [Add] key, the registration screen appears. You can install up to 64 in total.



- When installing from the operation panel of the machine, the files in the USB memory connected to the machine are installed. When installing from the Web page, the files in the computer are installed.
- The maximum storage space available to the application is 4GB. If previously installed applications are already using 4 GB of area, a new application cannot be installed.

Store Embedded Application

By storing an already installed embedded application in "standard application", the application can be used. Select the application name checkbox and tap the [Add Standard Applications] key.

Delete Embedded Application

Tap an application name in the list to display the information of that standard application. After checking the information, delete the standard application with the [Delete] key.

Polling Setting

When linked to an external application, you can store and manage addresses in order to use a service that uses a polling function.

Item	Description
Server 1 - Server 2	Set to enable each of the servers.
Polling Address	Enter the URL of the server or computer that the machine will poll.
Check Interval	Enter the check interval for the server. The default is 1 minute.
Timeout	Set the timeout time. The default setting is 20 seconds.



External Service Connect

Enable the cloud connector function you want to use.

The following cloud connector functions can be set.

- SharePoint Online Connector
- OneDrive Connector
- Google Drive Connector
- Gmail Connector
- Exchange Connector



Authentication Settings

Default Settings

This section describes the settings in [System Settings] → [Authentication Settings] → [Initial Settings] in "Settings (Administrator)".

User Authentication

This setting enables or disables user authentication and specifies the authentication method.

When the user authentication is enabled, each user of the machine is registered. When a user logs in, the separate authentication settings apply to the user. This function allows greater control of security and cost management than that on previous machines.

Even if user information is not stored on the machine, you can directly enter the user information stored in an LDAP server to log in the machine if necessary. For more information see "[Users stored as factory default \(page 10-44\)](#)".

Factory default settings: Disable



- For the procedure for storing users, see "[User List \(page 10-43\)](#)".
- For details on login procedures when user authentication is enabled, see "[USER AUTHENTICATION \(page 9-12\)](#)".

User Authentication

When [User Authentication] is enabled, the authentication screen appears before an operation is carried out in any mode except the job status screen*.

Log in as an already registered user.

After logging in, you can move freely through the modes.

* The login screen appears when a document filing file is used or when a broadcast transmission is reattempted from the job status screen.

Authentication Settings

Set the location where user authentication is to be enabled.

Login Locally: User authentication is performed on this machine.

LDAP: User authentication by LDAP server.

Active Directory: User authentication by Active Directory.

Sharp OSA: Authenticate the user using the Sharp OSA application.

Factory default settings: Login Locally

Default Network Authentication Server Setting

Use this to set the default network authentication server.

When you log into Setting mode (Web version) or send a print job to the machine using user information that is not registered in the machine, the authentication server is not known.

This setting is used to select one of the LDAP servers registered in the machine as the authentication server.



When login is performed by network authentication using user information that is not registered in the machine, the login user will be the "User" registered as factory default. For more information see "[Users stored as factory default \(page 10-44\)](#)".



Specify network server access control

Register the access control information for page count limits, authorities, and favorite operations can be registered on a network server in advance. By using this network server for network authentication, perform the user authentication based on the registered access control information.

Use this function when user authentication is performed by network authentication using an LDAP server or a directory service (Active Directory, etc.).

Before using this function, configure settings for authentication by network server, obtain control numbers for the "Pages Limit Group", "Authority Group", "Favorite Operation Group", and "My Folder" (including base settings for each group), and associate these with the control numbers registered in the machine.

To use this function, add the properties associated with "Pages Limit Group", "Authority Group", "Favorite Operation Group", and "My Folder" to the directory information of the network server used for user authentication.

The property information is indicated below. Settings previously stored in the machine cannot be changed.

Property	Name of property in factory default state	Settings
Pages Limit Group	pagelimit	Registration number of Pages Limit Group registered in the machine, or a group name previously registered in the machine. Registration number of Authority Group registered in the machine, or a group name previously registered in the machine. Unlimited: unlimited
Authority Group	authority	Registration number of Authority Group registered in the machine, or a group name previously registered in the machine. Registration number of Authority Group registered in the machine, or a group name previously registered in the machine. Admin: admin User: user Guest: guest
Favorite Operation Group	favorite	Registration number of Favorite Operation Group registered in the machine, or a group name previously registered in the machine. Following the System Settings: systemsettings
My Folder	myfolder	Folder name of user folder stored in the machine. Do not enter if the default folder is specified.

Rename the properties that the machine obtains from the LDAP server as follows. In "Settings", select [Network Settings] → [LDAP Settings]. From the Global Address Book setting screen that is displayed, select [Linkage with User Control Function] and then select [Pages Limit Group], [Authority Group], [Favorite Operation Group] and [My Folder].

The [Pages Limit Group], [Authority Group], and [Favorite Operation Group] information that is registered in each machine determines the authority and settings that the user is actually granted. To use this function to ensure that users are granted the same authority and settings on any machine, register the [Pages Limit Group], [Authority Group], and [Favorite Operation Group] information with the same authority so that they will be registered in each machine using the same registration numbers.

For [My Folder], register the folder having the same name in [Custom Folder] in each machine.

The directory information of the network server that is used cannot be changed from the machine. Consult the administrator of the network server.

If 1000 users have already been manually registered, login will not be possible. Consult the administrator of the machine.

Factory default settings: Disable



- If Access Control is enabled and the access control information cannot be acquired from the authentication server, user authentication will not be possible.
- If a user that is registered in the machine is authenticated by network authentication, the user registration settings in the machine will be given priority for the page count limit group, authority group, favorite operations group, and my folder.
- If the access control obtained from the LDAP server is not registered in the machine, the factory default user authority will be applied.
- When this function is not enabled and a user is authenticated by network authentication as a non-registered user, the factory default user authority will be applied.

Users auto-registered

When you log in by network authentication, your user information is automatically registered in the machine. The information stored is as follows:

Item	Description
User Name	This information is acquired from the authentication server.*
Initial	1
Index	User1
Card ID	-
PIN Code/Password	-
Authentication Settings	-
Authentication Server	Network Authentication
E-mail Address	When Access Control is enabled, this information is acquired from the authentication server.
My Folder	
Pages Limit Group	
Authority Group	
Favorite Operation Group	

* If the user name cannot be acquired by network authentication, the first 16 characters of the text string used as the login name for network authentication is applied.

Authentication Method Setting

This selects the authentication method. When using user authentication, be sure to configure this setting first. The items to be configured for users stored after setting the user authentication method vary depending on the selected authentication method.

Authenticate a User by Login Name and Password

Standard authentication method using a login name and password.

Authenticate a User by Login Name, Password and E-mail Address

This authentication also checks the e-mail address, in addition to the login name and password of the user.

Authenticate a User by User Number Only

Use this option for simple authentication if you skip the network authentication.

Factory default settings: Authenticate a User by Login Name and Password



- The login screen will vary depending on the authentication method that is selected. For more information see "[USER AUTHENTICATION \(page 9-12\)](#)".
- When "Authenticate a User by User Number Only" is selected for the authentication method, network authentication cannot be used.



Case sensitivity of login name is enabled.

Set whether or not to make login names used at the time of user authentication case sensitive. If the checkbox is set to , login names with identical spelling but different cases (upper and lower) will be identified as different login names. Therefore, login names with identical spelling but different cases will be authenticated as user names of different users.

If the checkbox is set to , case sensitivity for login names is disabled. Therefore, identically spelled user names with upper and lower case character differences will be authenticated as the user name of the same user.

Factory default settings: Enable



If the selected checkbox is changed to , and identical user names with only upper and lower case character differences exist, the user names that have already been registered are identified as user names of different users.

Enable Quick Login

Enable "[QUICK AUTHENTICATION \(page 9-17\)](#)".

Factory default settings: Disable

Device Account Mode Setting

A specific user can be registered as an auto login user. When this option is enabled, the registered user can log in the machine automatically.

This function can eliminate each login procedure on the authentication screen and apply the selected user settings (such as network authentication and favorite operations). As an example, this enables uses such as "authentication for copying only".

Also, you can temporarily log in as a user other than the auto login user, and operate the machine with the privileges of this user. To allow other users to log in temporarily when [Device Account Mode] is enabled, select [Allow Login by Different User].

Factory default settings: Device Account Mode:Disable, Allow Login by Different User:Disable, Disable Home Edit Mode when in Device Account Mode:Disable



- If you have logged in as the Auto Login user, and if you have failed automatic login due to some reasons or if you do not have the administrator's privileges, you cannot use the general setting modes or Setting mode. In that case, the administrator should tap the [Administrator Password] key on the Setting mode screen and log in again.
- To log in as a user other than a fixed user when [Allow Login by Different User] is enabled, tap the [Logout] key to cancel the fixed user login state. When the user authentication screen appears, log in as the desired user again. After you have used the machine, tap the [Logout] key to log out as the current user.

Login User

This setting is used to select the auto login user when auto user login is enabled.

Settings for Using Authentication Information

Store User Information

Set whether or not automatically registered users are created.

Externally authenticated users in Sharp OSA can also be automatically registered.

Factory default settings: Enable

Store Password

Set whether or not automatically registered users are created. Externally authenticated users in Sharp OSA can also be automatically registered.

Factory default settings: Enable

Cache Period

Set whether or not automatically registered users are created.

Externally authenticated users in Sharp OSA can also be automatically registered.

Factory default settings: Unlimited



Enable Offline Authentication with stored User Information

Allows the machine to be used in the event of a network failure, even when using network-based user authentication.

Factory default settings: Disable

Enable Personalization when external authentication is used

Even if you use external authentication such as LDAP authentication, you can customize it for each user.

The items that can be customized are as follows.

Home screen icon, home screen text color, custom display pattern, display language, large text mode, favorites

Factory default settings: Enable

Cache Authentication Information for External Service Connect

Set whether or not authentication information for connection to the cloud is retained as cache information.

When this setting is enabled, the authentication information of a successfully authenticated user is retained to enable smooth authentication when the user subsequently logs in.

When this setting is disabled, the previously retained cloud connection authentication information of all users is deleted and authentication information is no longer retained.

Factory default settings: Enable

Card Setting

Use IC Card for Authentication

Allows the IC card to be used when authenticating the user.

Factory default settings: Disable

Authentication Method Setting

Set the authentication method with the IC card.

Factory default settings: Only Card Authentication Approved

Item	Description
Only Card Authentication Approved	User authentication is only for IC cards.
Allow both use of IC card and input from the operation panel	User authentication is possible from both the IC card and the operation panel.

Request Password at IC Card Authentication

This can be set when "Authentication Settings" is "Active Directory" and "Use IC Card for Authentication" is enabled.

When enabled, enter the password each time you authenticate with the IC card. If disabled, the password will be entered when logging in with the IC card for the first time, and the password information will be sent to the Active Directory server. You can omit entering the password for the second and subsequent logins.

Factory default settings: Disable

Automatic Logout with a Card

Log out when you remove the IC card from the IC card reader/writer. (You can also log out by tapping the [Logout] key.)

Factory default settings: Disable



Administration Settings

Disable Printing by Invalid User

Print jobs by users who have not registered user information in this machine, such as jobs for which appropriate user information has not been entered in the printer driver or when "[DIRECTLY PRINTING A FILE ON AN FTP SERVER \(page 4-86\)](#)" is entered from the setting mode (administrator), are prohibited.

Factory default settings: Disable

Automatic Logout Setting

When user authentication is enabled, this setting specifies whether or not to enable automatic logout. The time until logout can be specified up to 240 seconds in increments of 10 seconds.

Factory default settings: Enable

A Warning when Login Fails

When entering passwords, including administrator passwords, during user authentication, the number of incorrect password attempts is counted, and if the number of attempts reaches the specified number (three), the user account is locked, and the user is blocked from making any more attempts at authenticating their account until a period of five minutes has elapsed. The number of incorrect entries made is counted separately for each user, and the count is reset when the correct password is entered.

This prevents an unauthorized person from attempting to guess a password. (The number of failed login attempts is retained even if the power is turned off.)

Factory default settings: Disable



- Lockout only applies to the user who failed to login, not all users. Even if one user is locked out, the other users can still log in.
- When LDAP or Active Directory network authentication is used, lockout is executed by the server, not the machine. Select appropriate lockout settings on the server.
- If the same user has been locked out, the [Release Operation Lock Status] key is displayed in the "User Registration" screen for that user. An administrator can tap this key to carry out a manual clear.

Allow Remote Scanner Using Before Login.

This setting specifies whether scanning can be performed by remote operation before a user has logged in.

Factory default settings: Disable

Include Job Status in user authentication

When user authentication is enabled, this setting specifies whether or not to include the job status in user authentication.

Factory default settings: Disable

Display System Information Screen Before Login

Set whether the system information screen can be displayed before logging in.

Factory default settings: Disable

Enable IPP Authentication Except for Printer Driver

Enable IPP authentication on a non-printer driver.

Factory default settings: Enable



Actions when the user is authenticated

Actions when the Limit of Pages for Output Jobs

This setting determines whether or not a job will be completed if the page limit is reached while the job is in progress. The following settings can be configured.

- Print through the end of the job
- Stop the job
- Cancel and delete the job during receiving

Factory default settings: Switch at End of Job

Automatically print stored jobs after login

When retention is enabled in the printer driver and print data has been spooled to the machine, you can have the spooled print data automatically print out when the user who enabled retention logs in.

Factory default settings: Disable

Reset Counter After Sending E-mail Status

After E-mail Status has been sent, the counter is reset.
Displayed only when E-mail Alert and Status is enabled.

Factory default settings: Disable

Disable display/change of other users' information in the job status

This can be set when the job status is subject to user authentication.

When this setting is enabled, only the logged-in user's job is displayed on the job status screen.

Factory default settings: Disable

Set Email Address of Logged In User in the From/Sender Field of E-mail

When scanning E-mail transmissions (including resending) during user authentication, when [System Settings] → [Authentication Settings] → [Default Settings] → [Set Email Address of Logged In User in the From/Sender Field of E-mail] is enabled in "Settings (Administrator)", the user name and E-mail address of the logged-in user will be set as the From/Sender field of E-mail.

When the logged-in user has not registered an e-mail address or a job is configured to use digital signatures for sending e-mail in the S/MIME function, the settings in [System Settings] → [Network Settings] → [Service Settings] → [SMTP] (tab) → [Sender Name] and [Sender Address] will be entered.

Factory default settings: Disable



When this function is enabled, sending may fail depending on the mail server environment. Contact your email provider in advance to check if this function is available.

Apply login name to the user name of network folder

Applies the login name to the user name in the shared folder.

Login Name Display

When user authentication is enabled, select whether the login name is shown or asterisks are shown.

Factory default settings: Display login name

Item	Description
Display login name	Show the login name.
Display login name with "**"	Hide the login name with asterisks.



Display Usage Status after Login

When user authentication is enabled, this setting specifies whether or not to display the page counts of a user when the user logs in.

Factory default settings: Disable

Edit Help Display of Login Screen

Settings you have created here is displayed on the login screen.



Card Reader Settings

Condition Settings

Card Scan Test

Perform a read test of the card to be used.

Card ID Registration/Change Authority

Set whether the logged-in user can register/change/delete his/her card ID information in this machine.

Factory default settings: Disable

Check System Code only in FeliCa User Area mode

Check the System Code only in FeliCa User Area mode.

Factory default settings: Disable

Check Facility Code in HID Mode

Set whether to check the facility code when using a HID card.

When this setting is enabled, the facility code (up to 128 single-byte characters) is registered.

Factory default settings: Disable

Import from Configuration file

When you enter the configuration file name and tap the [Execute] key, the card area settings are read from the configuration file. If you tap the [Clear] key, all files that match the current search conditions are deleted.

Facility Code

Enters the facility code of a HID card. When you tap the [Store] key, the facility code is stored.

Card Reader Device Registration

Set when connecting a card reader/writer.



This setting can be set in the setting mode of this machine.



Paper Settings

Paper Tray Settings

Paper tray and paper type settings are explained in this section.

These settings specify the paper type, paper size, and functions allowed for each paper tray.

When the [Tray Settings] key is tapped, a list appears showing the trays and the current settings.

Auto Tray Switching

When a tray runs out of paper during printing, this determines whether or not another tray with the same size and type of paper is automatically selected and printing continues.

Factory default settings: Disable

Display Paper Tray Settings when bypass tray detects paper.

You can have the paper tray settings appear automatically when paper is detected in the bypass tray.

Factory default settings: Disable

Paper Weight

These are used to control the toner fusing temperature according to the weight of the paper.

These settings apply to recycled paper, punched paper, pre-printed paper, letterhead paper, colored paper, and user type paper.

You can select "16 to 23 lbs." or "23+ to 28 lbs." ("60g/m² to 89g/m²" or "90g/m² to 105g/m²").

Factory default settings: 16 to 23 lbs (60 to 89g/m²)

Settings of each tray

When the [Change] key is tapped, the corresponding setting screen appears.

The following settings can be configured.

List name	Description
Type	Select a type of paper to be loaded into the tray. The paper types that can be selected vary by paper tray. For more information see " Tray Settings (page 10-136) ". To user type setup, see " Paper Type Registration (page 10-138) ".
Size	Select the paper size from the list. The paper sizes that can be selected vary by tray. The sizes that can be selected may also be restricted by the paper type selected above. For more information see " Tray Settings (page 10-136) ". If the desired size does not appear in the list, select [Custom Size] and directly enter the size (only for the bypass tray). For more information see " Tray Settings (page 10-136) ".
Feeding Approved Job	Select the modes that can be used. If there is a function that you do not wish to be used with the selected tray, disable the function. When the "Type" is other than plain paper, recycled paper, colored paper, or a user type, [Fax] and [Internet Fax] cannot be selected.



- If the paper size specified here is different from the size of paper that is loaded into a tray, a problem or misfeed may occur when printing.
- To change the paper size in a tray, see "[IMPORTANT POINTS ABOUT PAPER \(page 1-11\)](#)".
- Paper properties such as "Fixed Paper Side" are automatically set when the paper type is selected. The paper tray properties cannot be changed in this screen.
- [Settings]-> [System Settings]-> [Common Settings]-> [Device Settings]-> [Basic Settings]-> [Prohibit Paper Tray Settings], [Prohibit Use of Large Capacity Tray], When it is set, the paper feed tray (excluding the bypass tray) cannot be set.



Tray Settings

Paper Tray	Paper Type	Size
Tray 1	Plain 1/2, Pre-Printed, Recycled, Letter Head, Pre-Punched, Color, User Type 1 to 8	8-1/2" × 11", A4
Tray 2		
Tray 3	Plain 1/2, Pre-Printed, Recycled, Letter Head, Pre-Punched, Color, Heavy Paper 1 to 2*1, User Type 1 to 8	Auto-Inch (11" × 17", 8-1/2" × 14", 8-1/2" × 11", 8-1/2" × 11"R, 7-1/4" × 10-1/2"R), Auto-AB (A3, B4, A4, A4R, B5, B5R, 216 mm × 330 mm (8-1/2" × 13")), 8-1/2" × 13-2/5" (216 mm × 340 mm), 8-1/2" × 13-1/2" (216 mm × 343 mm), 8K, 16K, 16KR
Tray 4	Plain 1/2, Pre-Printed, Recycled, Letter Head, Pre-Punched, Color, Heavy Paper 1 to 2*1, User Type 1 to 8	Auto-Inch (11" × 17", 8-1/2" × 14", 8-1/2" × 11", 8-1/2" × 11"R, 7-1/4" × 10-1/2"R, 5-1/2" × 8-1/2R), Auto-AB (A3, B4, A4, A4R, B5, B5R, A5R, 216 mm × 330 mm (8-1/2" × 13")), Size Input-Inch, Size Input-AB, 8-1/2" × 13-2/5", 8-1/2" × 13-1/2", 8K, 16K, 16KR
	Labels	Auto-Inch (8-1/2" × 11", 8-1/2" × 11"R), Auto-AB (A4, A4R, B5, B5R)
	Transparency	Auto-Inch (8-1/2" × 11", 8-1/2" × 11"R), Auto-AB (A4, A4R)
	Tab Paper	Auto-Inch (8-1/2" × 11"), Auto-AB (A4)
Tray 5 (BP-LC11)	Plain 1/2, Pre-Printed, Recycled, Letter Head, Pre-Punched, Color, Heavy Paper 1 to 2*1, User Type 1 to 8	8-1/2" × 11", A4
Tray 5 (MX-LC19)		12" × 18" (A3W), 11" × 17", 8-1/2" × 14", 8-1/2" × 13" (216 mm × 330 mm), 8-1/2" × 11", 8-1/2" × 11"R, A3, B4, A4, A4R, B5, 8K, 16K
Bypass Tray	Plain 1/2, Pre-Printed, Recycled, Letter Head, Pre-Punched, Color, Heavy Paper 1 to 4*1, Thin Paper, Glossy Paper, User Type 1 to 8	Auto-Inch (12" × 18" (A3W), 11" × 17", 8-1/2" × 14"*2, 8-1/2" × 13-2/5"*2, 8-1/2" × 13-1/2"*2, 8-1/2" × 11", 8-1/2" × 11"R, 7-1/4" × 10-1/2"R, 5-1/2" × 8-1/2"R, A3, B4, A4, B5R), Auto-AB (A3W (12" × 18"), A3, B4, A4, A4R, B5, B5R, A5R, A6R*3,4, 11" × 17", 216 mm × 330 mm (8-1/2" × 13")*2, 216 mm × 340 mm (8-1/2" × 13-2/5")*2, 216 mm × 343 mm (8-1/2" × 13-1/2")*2, 8-1/2" × 11"), Size Input-Inch, Size Input-AB, 8K, 16K, 16KR
	Transparency, Tab paper, Labels	Same as for Tray 4



Paper Tray	Paper Type	Size
Inserter (Upper)	Plain, Pre-Printed, Recycled, Letter Head, Pre-Punched, Color, Heavy Paper 1 to 2 ^{*1} , User Type 1 to 8	Auto-Inch (12" × 18" (A3W), 11" × 17", 8-1/2" × 14", 8-1/2" × 11", 8-1/2" × 11"R ^{*2} , 8-1/2" × 14" ^{*2} , 8-1/2" × 13-1/2" ^{*2} , 8-1/2" × 13-2/5" ^{*2} , 7-1/4" × 10-1/2"R, 5-1/2" × 8-1/2R, A3, B4, A4) Auto-AB (A3W (12" × 18"), 11" × 17", 8-1/2" × 11", A3, B4, A4, A4R ^{*2} , 216 mm × 330 mm (8-1/2" × 13") ^{*2} , 216 mm × 340 mm (8-1/2" × 13-2/5") ^{*2} , 216 mm × 343 mm (8-1/2" × 13-1/2") ^{*2} , B5, B5R, A5R) Size Input-Inch, Size Input-AB
Inserter (Lower)		

*1 Heavy paper 1: 28 lbs bond to 65 lbs Cover (106 g/m² to 176 g/m²)
 Heavy paper 2: 65 lbs Cover to 80 lbs Cover (177 g/m² to 220 g/m²)
 Heavy paper 3: 80 lbs Cover to 140 lbs Index (221 g/m² to 256 g/m²)
 Heavy paper 4: 140 lbs Index to 110 lbs Cover (257 g/m² to 300 g/m²)
 Thin paper: 13 lbs bond to 16 lbs. bond (55 g/m² to 59 g/m²)

*2 The size that is automatically detected is set in "Select Paper Sizes for Auto Detection" in the bypass tray settings screen.

*3 A6R cannot be used without the right tray.

*4 Thin paper of A6R size cannot be used.

Tray Registration

Select Paper Sizes for Auto Detection

"Select Paper Sizes for Auto Detection" in the bypass tray settings screen is used to select the paper size that is automatically detected from similar sizes when the automatic paper size detection takes place.

When paper that is the same size as one of the paper sizes in the settings is placed in the bypass tray, the size that is selected in the settings will be automatically detected.

List name	Description
Auto-AB	216mm x 330mm (8-1/2" x 13"), 216mm x 340mm (8-1/2" x 13-2/5"), 216mm x 343mm (8-1/2" x 13-1/2")
Auto-Inch	8-1/2" x 14", 8-1/2" x 13-2/5" (216 mm x 340 mm), 8-1/2" x 13-1/2" (216 mm x 343 mm)



Custom Size Registration (Bypass)

If you frequently use a non-standard size paper in the bypass tray, register that paper size in advance.

Registering the paper size saves you the trouble of setting the size each time you need to use it.

Up to Seven paper sizes can be registered.

Tap the key ([Custom 1] to [Custom 7]) in which you wish to register or change a paper size, and the registration screen appears.

Select whether you wish to enter the size in mm ("Size Input-AB") or inches ("Size Input-Inch"), and then set the X and Y dimensions of the paper.

"Size Input-AB"

The X direction can be set between 140mm and 457mm.

The Y direction can be set between 90mm and 305mm.

Factory default settings:X:420 mm, Y:297 mm

"Size Input-Inch"

The X direction can be set between 5-1/2" and 18".

The Y direction can be set between 3-5/8" and 12".

Factory default settings:X: 17" Y: 11"

Paper Type Registration

Store a paper type when the desired paper type does not appear as a selection or when you wish to create a new set of paper properties.

Up to 8 paper types can be registered.

List name	Description
Type Name	Register any name. The factory default names are "User Type 1" to "User Type 8".
Fixed Paper Side	Use this setting when paper with a front and reverse side is used. Factory default settings: Disable
Disable Duplex	Use this setting when paper loaded cannot be used for 2-sided printing. Factory default settings: Disable
Disable Staple	Use this setting when paper used cannot be stapled. Factory default settings: Disable
Disable Stapleless Staple	Use this settings when paper used cannot be stapleless stapled. Factory default settings: Disable
Disable Punch	Use this setting when paper used cannot be punched. Factory default settings: Disable
Disable Fold	Use this setting when using paper that cannot be disable fold. Factory default settings: Disable



The settings that can be selected vary depending on the peripheral devices installed.



Operation Settings

Condition Settings

Enlarge Display Mode

Displays large characters on the screen.

 appears in the system area when Large Character Mode is enabled.

Factory default settings: Disable

Message Time Setting

The duration of time that messages appear in the touch panel (the time until a message is automatically cleared) can be set to any number of seconds from 1 to 12.

Factory default settings: 6 seconds

Language Setting

The language that appears in the touch panel can be changed to any language.

Factory default settings: American English



When user authentication is enabled and a display language is specified in the favorite operation group, that setting is given priority.

Default Display Settings

Set the screen that appears after auto clear and login.

Easy Copy, Easy Scan, Easy Fax, Copy, Print Release, E-mail, Network Folder/FTP/Desktop, Internet Fax, Fax, Address Book, Address Book (Easy Scan), Address Book (Easy Fax), Document Filing, Select from the Home Screen, Sharp OSA screen, Exchange (E-Mail), and Gmail.

Factory default settings: Home Screen

Display System Information Screen as Default

When switching between modes, first set whether to display the "System Information Screen".

Factory default settings: Disable

Display IP Address on the System Information Screen

This setting specifies whether or not to display the IP address of the machine on the "System Information" screen.

Factory default settings: Enable

Display Favorite Menus as Default

You can specify to display the "Favorite" first during mode selection.

Factory default settings: Disable

Display Action Panel as default.

Specify whether or not to display with the action panel on the screen.

Factory default settings: Enable

Icon is displayed when network cable is not connected.

Show an icon when a LAN cable is not connected.

Factory default settings: Enable



Display Confirmation Dialog when job is canceled.

Set whether to display a notification message when a job is completed.

Factory default settings: Disable

Display Status Notification Message

Show a confirmation dialog box when a job is canceled.

Factory default settings: Enable

Restrict Total Count display

When this setting is enabled, the total count is hidden when checking the total count from the home screen.

Factory default settings: Disable

Switch the Number of Sets to be Displayed for Job Status

Set whether the remaining number of sets or the final number of sets is shown in the job status.

Factory default settings: Progress

Display the estimated job start time

Specify whether or not to display the estimated start time of the job in the job status.

Factory default settings: Enable

Alignment Order of 10-Key

Set whether the numeric keys are arranged in ascending order with "1" in the upper left corner, or "1" in the lower left corner.

Factory default settings: Ascending order from upper left

Setting Display from Main Unit

Select settings for the path information of the setting destination displayed when setting mode is set on the machine.

Display Current Path

Set whether or not the current setting items are shown in the path information.

Factory default settings: Enable

Enable link of current path

Set whether the link at the top is enabled.

Factory default settings: Enable

MFP Display Pattern Setting

Set the background color of the touch panel. Each time you change patterns, the touch panel image at the bottom of the screen changes.

Factory default settings: Pattern 2



Key Operation Setting

Auto Clear Setting

The time until Auto Clear activates can be set to any number of seconds from 10 to 240 in increments of 10 seconds. If the machine is not used for the duration of time set here, the auto clear function will clear any settings that have been selected and return the screen to the base screen of copy mode or the job status screen.

Factory default settings: 60 seconds

Cancel Timer

This is used to disable the auto clear function.

Factory default settings: Disable

Key Operation Setting

Time for Accepting Key Entry

This setting determines how long a key in the touch panel must be tapped until the key input is registered. The time can be set from 0 to 2 seconds in increments of 0.5 seconds.

By lengthening the time setting, key input can be prevented when a key is tapped accidentally. Keep in mind, however, that when a longer setting is selected more care is required when tapping keys to ensure that key input is registered.

Factory default settings: 0.0 seconds

Disable Auto Key Repeat

This is used to disable key repeat.

Factory default settings: Disable

Key repeat causes a setting to change continuously not only each time the key is tapped but while a key is tapped.

Time for Accepting Key Entry of Long Touch

Select a time when a long key touch is detected.

Factory default settings: 0.5 seconds

Double Tap Interval Setting

Select an interval when a double tap is detected.

Factory default settings: 0.5 seconds

Disabling of Bypass Printing

This setting is used to disable bypass printing (printing other jobs ahead of a job that has been stopped *because the paper required for the job is not available in any of the trays).

* This does not include cases where the paper ran out during the job.

Factory default settings: Disable

Priority of Print Jobs

Set the priority for each job and start printing from the job with the highest priority.

Factory default settings: All Low

Disabling of Covers/Inserts Mode

Disables the use of the covers and inserts function.

Disable Manual Finishing

Disables the use of manual finishing.

Factory default settings: Disable

Disabling Recent Jobs

Prohibit the use of [Recent Jobs].

Factory default settings: Disable



Initial Original Count Setting

Specifies whether or not "Original Count" in Others is enabled for each function.

Copier

- Copier

Image Send

- Scan
- Internet Fax
- Fax
- Data Entry

Document Filing

- Scan to Local Drive

Factory default settings: All Invalid

Preview Setting

Received Data Image Check Setting

Select whether or not a preview of received faxes and Internet faxes is shown. This is displayed when a facsimile expansion kit or Internet fax expansion kit is installed.

Factory default settings: Disable

Received Data Image Check Setting:

- Fax/I-Fax Reception Data:

Select whether the default display format of the received fax/I-Fax list screen is list or thumbnails.

Factory default settings: Thumbnail

- File Retrieve of Main Folder/Quick File Folder:

Select whether the default display format of the document filing main folder and temporary folder screens is list or thumbnails.

Factory default settings: List

- File Retrieve of Custom Folder:

Select whether the default display format of the document filing custom folder screen is list or thumbnails.

Factory default settings: List

- File Retrieve of Direct Print:

Select whether the default state of the folder screen for direct print shows the folders as a list or as thumbnails.

Factory default settings: List

Remote Operation Settings

Configure settings required for remote operation of the machine from a PC connected to the same network.

Remote Software Operation

- Operational Authority:

This is used when remote software is used to operate the machine remotely.

- View Password Entry Screen:

When operating the machine by remote control using the remote software, the password entry screen will appear on both the computer and the machine, or on only the computer.

Factory default settings: Operational Authority: Prohibited, View Password Entry Screen: Display in Both PC and MFP

Operation from Specified PC

- Operational Authority:

This is used to allow remote operation of the machine using the specified PC.

- View Password Entry Screen:

When operating the machine by remote control using the remote software, the password entry screen will appear on both the computer and the machine, or on only the computer.

Factory default settings: Operational Authority: Prohibited, View Password Entry Screen: Display in Both PC and MFP



Operation by User Who Has Password

- **Operational Authority:**

This is used to allow a user who has a password to operate the machine remotely. For information on the password, consult your service technician.

- **View Password Entry Screen:**

When operating the machine by remote control using the remote software, the password entry screen will appear on both the computer and the machine, or on only the computer.

Factory default settings: Operational Authority: Prohibited, View Password Entry Screen: Display in Both PC and MFP

Data List

Set whether to print the data list with 1-sided print or 2-sided print.

Factory default settings: 1-sided print

Tandem Connection Setting

When two machines are used as network printers using TCP/IP protocol, use this setting to configure the port number and IP address of the machine used as the tandem secondary unit.

Factory default settings: Port Number: 50001

Disabling of Primary Unit Mode

To prohibit tandem transmission, enable this setting. (Normally this setting is not necessary.)

Factory default settings: Disable

Disabling of Secondary Unit Mode

To prohibit tandem reception, enable this setting. (Normally this setting is not necessary.)

Factory default settings: Disable



- To use the tandem function when user authentication is enabled, the same login name and password must be used on both the primary unit and secondary unit. If the same login name and password are not used, the page count may not be added to the appropriate user count or only the primary unit may print.
- Use the same port number as long as it does not cause any inconvenience.

Easy Mode Settings

Set the items that can be selected in Easy Copy and other Easy modes.

The items appear will appear in order on the screen starting from the item that is set in No. 1.

Items that can be set in Easy Copy

Paper Select, 2-Sided Copy, Copy Ratio Staple / Punch, Original, Exposure, N-Up, Card Shot

Job Build, Blank Page Skip, Dual Page Copy

Factory default settings: No.1: Paper Select, No.2: 2-Sided Copy, No.3: Copy Ratio, No.4: Staple / Punch, Staple (For models without punch function), No.5: Image Orientation, No.6: Exposure, No.7: Card Shot

Items that can be set in Easy Scan

Address Book, History, Global Address Search, Scan to USB/Local Drive, Original, Resolution, File Format, Blank Page Skip and Card Shot., Job Build, Dual Page Scan, File Name, Mobile Address Book

Factory default settings: No.1: Address Book, No.2: History, No.3: Global Address Search, No.4: Scan to USB/Local Drive, No.5: Original, No.6: Resolution, No.7: File Format, No.8: Blank Page Skip

Items that can be set in Easy Fax

Address Book, History, Direct Entry, Original, Exposure and Resolution., Sending Line, Job Build, Mobile Address Book

Factory default settings: No.1: Address Book, No.2: History, No.3: Direct Entry, No.4: None, No.5: Original, No.6: Exposure, No.7: Resolution, No.8: Sending Line



The items that can be set vary depending on the peripheral devices that are installed.



Favorite Key Setting

Set the information that appears when favorite keys are tapped in normal mode.

Click the Copy, Scan, Internet Fax, Fax, and Data Entry tabs to configure settings for the favorite key screens shown in each of the normal modes.

Favorite Key Number

Sets the favorite key number.

The items appear will appear in order on the screen starting from the item that is set in No. 1.

Key Name

Enter a maximum of 20 characters for the favorite key name.

Function Menu

To set functions such as "Other Functions", select the functions from the pull-down menu.

Job Programs

To set a program, select one of the preset programs from the program list.

Not Display

You can hide a set key in the favorite key screen.

Mode Key Display Setting

Configure settings for the display of mode keys at the top of the screen.

Modes to Display

Select the mode keys that you want to display.

Factory default setting: Easy Copy: Enabled, Copy: Disabled, Easy Scan: Enabled, Easy Fax: Enabled, Image Send: Disabled, Document Filing: Disabled, Sharp OS: Enabled

Display Mode Keys on Home

You can enable display of the mode keys in the home screen as well.

Factory default settings: Enable

Keyboard Settings

Default Keyboard Setting

Configure settings for the keyboard used for entry on the text.

Keyboard Select

Change the key layout and display according to the set language.

Factory default settings: Japanese JIS

Set Keyboard Priority

When an external keyboard is connected, set whether the external keyboard or the keyboard shown on the touch panel (soft keyboard) is given priority.

Factory default settings: Soft Keyboard

Soft Keyboard Template Setting

Register a text that you frequently use when entering an address or domain name in advance.

Custom Link Setting

You can display registered web addresses in the display field of the setting menu.

By clicking on a custom link, you can jump to the web site of the registered address.



Device Control

Various devices mounted on the machine can be set.

Condition Settings

Original Size Detector Setting

One of the 8 groups of standard original sizes shown below can be selected for detection by the original size detection function.

Selections	Detectable original sizes	
	Document Glass	Document feeder tray (automatic document feeder)
AB-1	A3, A4, A4R, A5, B4, B5, B5R	A3, A4, A4R, A5, A5R, A6R, B4, B5, B5R, 11"x17", 8-1/2"x14", 8-1/2"x11"
AB-2	A3, A4, A4R, A5, B5, B5R, 216 mm x 330 mm (8-1/2" x 13")	A3, A4, A4R, A5, A5R, A6R, B4, B5, B5R, 11" x 17", 8-1/2" x 11", 216 mm x 330 mm (8-1/2"x13")
AB-3	A4, A4R, A5, B4, 8K, 16K, 16KR	A3, A4, A4R, A5, A5R, A6R, B4, 11" x 17", 8-1/2" x 11", 216 mm x 330 mm (8-1/2" x 13"), 8K, 16K, 16KR
AB-4	216 mm x 340 mm (8-1/2" x 13-2/5"), A3, A4, A4R, A5, B5, B5R	A3, A4, A4R, A5, A5R, A6R, B4, B5, B5R, 11"x17", 8-1/2"x11", 216mm x 340mm (8-1/2" x 13-2/5")
AB-5	216 mm x 343 mm (8-1/2" x 13-1/2"), A3, A4, A4R, A5, B5, B5R	A3, A4, A4R, A5, A5R, A6R, B4, B5, B5R, 11" x 17", 8-1/2" x 11", 216 mm x 343 mm (8-1/2" x 13-1/2")
Inch-1	11" x 17", 8-1/2" x 14", 8-1/2" x 11", 8-1/2" x 11"R, 5-1/2" x 8-1/2"	11"x17", 8-1/2"x14", 8-1/2"x11", 8-1/2"x11"R, 5-1/2"x8-1/2", 5-1/2"x8-1/2"R, A3, A4
Inch-2	11" x 17", 216 mm x 330 mm (8-1/2" x 13"), 8-1/2" x 11", 8-1/2" x 11"R, 5-1/2" x 8-1/2"	11"x17", 216 mm x 330 mm (8-1/2"x13"), 8-1/2"x11", 8-1/2"x11"R, 5-1/2"x8-1/2", 5-1/2"x8-1/2"R, A3, A4
Inch-3	11"x17", 216 mm x 340 mm (8-1/2" x 13-2/5"), 8-1/2"x11", 8-1/2"x11"R, 5-1/2"x8-1/2"	11"x17", 216 mmx340 mm (8-1/2" x 13-2/5), 8-1/2"x11", 8-1/2"x11"R, 5-1/2"x8-1/2", 5-1/2" x 8-1/2"R, A3, A4

Factory default settings: Inch-1

Cancel Detection at Document Glass

Original size detection on the document glass can be disabled. When this is done, all originals placed on the document glass are treated as special size originals.

Factory default settings: Disable

Original Feeding Mode

The following original feeding modes can be set to operate by default in copy, image send, and scan to local drive.

When a mode is frequently used, this saves you from having to select the mode in another mode each time you need to use it.

- Mixed Size Doc. Same Width
- Mixed Size Doc. Different Width
- Slow Scan Mode*
- Skip blank paper

If you select Skip blank paper, select [Blank Page Skip] or [Skip Blank and Back Shadow].

* Excluding fax mode and Internet fax mode.

Factory default settings: None



Display Blank Page Skip Confirmation Message

Set whether to display a message when a blank page is detected by the automatic document feeder.

Factory default settings: Enable

Double Feed Detection Setting

This setting is available when the Double feed detection kit is installed.

If a original overlaps with another original and you try to load it at the same time, the original will be considered misfed and loading will be stopped.

Factory default settings: Enable

Actions When Maximum Number of Sheets that can be Stapled is Reached

Set whether to display a message to select a remedy when the maximum number of staples is reached.

Factory default settings: Stop the Job and Display Confirmation Message

Automatic Saddle Stitch

When the bookbinding function is set, the saddle stitch staple setting is automatically enabled.

Factory default settings: Enable

Saddle Fold/Stitch Position Adjust

Adjust the position of the folds and staples when saddle stitching.

Factory default settings: All 0 mm

Auto Switching of Finisher Trays

When the top tray of a finisher or saddle finisher becomes full of paper, the output destination is automatically switched to the lower tray.

Factory default settings: Enable

Paper Type for Auto Paper Selection

The paper types* that the Auto Paper Selection function will select can be specified. Select one of the following settings:

- Plain Paper 1
- Plain Paper 2
- Plain and Recycle Paper
- Recycled

The Auto Paper Selection function will not select any paper types other than the paper types specified with this setting.

* The paper type set for each paper tray by selecting [System Settings] in "Settings" → [Paper Tray Settings].

Factory default settings: Plain1, Plain2

Plain Paper Compatibility Settings

Set the basis weight of plain paper that is normally used.

Select from Plain1 and Plain2.

The weight of Plain Paper 1 is 60 to 89 g/m² (16 to 24 lbs bond). The weight of Plain Paper 2 is 90 to 105 g/m² (24 to 28 lbs bond).

Factory default settings: Plain1



Detect Standard in Auto Color Mode

When the color mode is set to auto in send mode, the discrimination point for detecting whether originals are color or black and white can be set to one of 5 levels. When set to [(Closer B/W)], the originals are easier to recognize as black and white. When set to [Closer color], the originals are easier to recognize as color.

Factory default settings: 3 (Normal)

Total Setting for Finish

Select the finish setting. Set whether finishing positions are specified on the specified paper or on the original.

Factory default settings: Specify Finishing Position Based on Paper Selected.

Disabling of Duplex

This is used to disable 2-sided printing, such as when the duplex module malfunctions.

Factory default settings: Disable

Disabling of Offset

Disable offset output.

Factory default settings: Disable

Disabling of Stapler

This setting is used to prohibit the use of staple, such as when the staple of finisher or saddle finisher malfunctions.

Factory default settings: Disable

Disabling of Punch

This setting is used to prohibit the use of punch, such as when the punch module of finisher or saddle finisher malfunctions.

Disabling of Document Feeder

Use this setting to prohibit the use of the automatic document feeder, such as when the feeder malfunctions. (When the setting is enabled, scanning is still possible using the document glass.)

Factory default settings: Disable

Disabling of Large Capacity Cassette

This setting is used to prohibit the use of the large capacity tray, such as when it malfunctions.

Factory default settings: Disable

Disabling of Tray Settings

This setting is used to prohibit tray settings (except for the bypass tray).

Factory default settings: Disable

Disabling of Inserter

This setting is used to prohibit tray settings (except for the bypass tray).

Factory default settings: Disable

Disabling of Finisher

Disables use of the inserter.

Factory default settings: Disable

Disabling of Folding Unit

It is used when the use of the paper folding unit is prohibited or when it breaks down.

Factory default settings: Disable



Disabling of Trimming Module

Disables use of the trimming module.

Factory default settings: Disable

Status Indicator Setting

Information Indicator Setting

Set the operation of the information indicator. For each setting, see the following "[INFORMATION INDICATOR \(page 1-8\)](#)".

Factory default settings: Pattern 1

Data Indicator Setting

- Information Indicator will blink if data is received
Set whether to blink the information lamp when there is received fax data.

Factory default settings: Enable

- Prioritize the indicator display of received data over the error indicator display
If there is received fax data, give priority to lighting the error display.

Factory default settings: Disable

Error Light Setting

Sets the operation of the error lamp. For each setting, see the following "[INFORMATION INDICATOR \(page 1-8\)](#)".

Factory default settings: Light & Blink

Use Communication Indicator

Set whether to use the information lamp. Even if this setting is disabled, faxes will be received and errors will be lit / blinked.

Factory default settings: Enable

Document Feeder Indicator Setting

Use Original Detection Light for Document Feeder

Set whether to use the document set lamp on the automatic document feeder.

Factory default settings: Enable

Use Preventive Light to Indicate Original Left Behind

Set whether to use the document removal prevention lamp on the automatic document feeder.

Factory default settings: Enable

Machine Identification Settings

Enter a name or code to identify the machine.



Clock Adjust

Use this to set the date and time in the machine's built-in clock.

Item	Description
Specify Time Zone	If your region is ahead of GMT (Greenwich Mean Time), select [+]. If your region is behind GMT, select [-]. Next, specify the time difference between your region and GMT in hours and minutes. (Example: If your region is Japan, + 9 hours 00 minutes.)
Date&Time Settings	Select and set the year, month, day, hour, and minute.

Daylight Saving Time Setting

Enable daylight saving time.

Item	Description
Daylight Saving Time Setting	Select whether or not the Daylight Saving Time Setting is enabled. If disabled, the following settings will not be possible. Factory default settings: Disabled
Select Setting Type	Specify whether the starting and ending day of daylight saving time are to be set using the day of the week or the date.
Start Time	Set the starting time of daylight saving time. If you selected "Day of the Week" in "Select Setting Type", set the starting week of daylight saving time and then the starting day. If you selected "Date" in "Select Setting Type", set the starting date. Set the hour and minute and the UTC (Coordinated Universal Time) setting.
Completing Time	Set the ending time of daylight saving time in the same way as you set the starting time.
Adjustment Time	Set the time to be adjusted when daylight saving time begins.



Date Format

The format used to print the date on lists and other output can be changed.

Item	Description
Current Setting	The current time appears in the format set in Date Format.
Format	Set the order of display of the year, month, and day (YYYY/MM/DD). Factory default settings: MM/DD/YYYY
Separator	Select one of three symbols or a blank space for the separator used in the date. Factory default settings: /
Day-Name Position	Select whether the day name appears before or after the date. Factory default settings: 12-Hour Display
Time Display	Select 12-hour format or 24-hour format for the time. <ul style="list-style-type: none">• 24-Hour Display: 00:00 to 24:00• 12-Hour Display: 00:00 AM to 11:59 AM/00:00 PM to 11:59 PM Factory default settings: 12 Hour



Enable/Disable Settings

The following settings enables or disables certain functions.

The prohibited setting items in the settings of each function such as copy settings and the items in this prohibited setting are linked.

Authentication Settings

Disable Home Edit Mode when in Device Account Mode

Disable Home Edit Mode when in Device Account Mode.

Factory default settings: Disable

Disabling of Printing by Invalid User

Printing by users whose information is not stored in the machine, such as printing without entering valid user information in the printer driver or printing of a file on an FTP server in Setting mode (Web version), can be prohibited.

Factory default settings: Disable

Copy Settings

Disabling of Registration/Deletion of Program

Copying is prohibited when the orientation of the copy paper and the original are different, or when the optimum size copy paper is not loaded.

Factory default settings: Disable



It is valid when "[Rotation Copy Setting \(page 10-61\)](#)" is canceled.

Disabling of Registration/Deletion of Program

This is used to prohibit the deletion and changing of copy settings stored in job programs.

Factory default settings: Disable

Disabling of Bypass-Tray in Duplex Copy

Disables the use of the bypass tray when making 2-sided copies.

The bypass tray is often used to feed label sheets, transparency film, and other special media for which 2-sided copying is prohibited. If a sheet of one of these special media enters the reversing unit, a misfeed or damage to the unit may result. If special media for which 2-sided copying is prohibited is often used, it is recommended that you enable this setting.

Factory default settings: Disable

Disabling of Auto Paper Selection

Disables the Auto Paper Selection function.

When this setting is enabled, automatic selection of paper that is the same size as the original on the document glass or in the automatic document feeder does not take place.

Factory default settings: Disable

Disabling Registration of Custom Image

Disables storage of a custom image.

Factory default settings: Disable

Disabling sending while copying

Disables the Image Send function during copy.

Factory default settings: Disable



Printer Settings

Prohibit Notice Page Printing

Disables to print a notice page.

Factory default settings: Enable

Prohibit Test Page Printing

Disables to print the test page.

When this setting is enabled, [Status] → [Data List] → [List for User] → [Printer Test Page] in "Settings" cannot be used to print test pages.

Factory default settings: Disable

Exclude Bypass-Tray from Auto Paper Select

When [Auto] is selected for paper type selection, the bypass tray is excluded from the trays that can be selected. This is recommended when special paper is often placed in the bypass tray.

Factory default settings: Disable

Disabling of USB Memory Direct Print

Disables the function for directly printing of a file in a USB memory device.

Factory default settings: Disable

Disabling of Network Folder Direct Print

Disables the direct printing from a network folder.

Factory default settings: Disable

Disabling sending while printing

Disables the Image Send function during printing.

Factory default settings: Disable

Disable Blank Page Print

Disables to print a blank page.

Factory default settings: Disable

Image Send Settings

Disable Switching of Display Order

Disables a change of display sequence (search number order, ascending, descending) in the address book and others. If set, the display is not sorted even when you tap the tab on the address book screen.

The currently selected display order will be the order that is used after the setting is selected.

Factory default settings: Disable

Prohibit Fax Broadcasting

Disables the facsimile broadcasting.

Factory default settings: Disable

Disable Scan Function

PC Scan

Specify this to disable remote PC scanning.

Factory default settings: Disable

Disable Storing to External Memory Device

Set this when you want to prohibit data saving to an external memory such as a USB memory.

Factory default settings: Disable

Disable Registering Destination from Operation Panel

Disables address control from the machine.

Configure the setting for each of the following items:

- Group (Direct Entry)
- Group (Address Book)
- Contacts

Select All: Selects all items.

Clear Checked: Clears all selections.

Factory default settings: All Invalid

Settings to Disable Registration



Disable Registering Destination on Web Page

Disables to store the destination from Setting mode (Web version).

Configure the setting for each of the following items:

- Group (Direct Entry)
- Group (Address Book)
- Contacts

Select All: Selects all items.

Clear Checked: Clears all selections.

Factory default settings: All Invalid

Disable Registration/Delection of All Program Items

Disables the use of address book when a program is stored.

Factory default settings: Disable

Disable Registration of Memory Box

Disables all types of memory box registration.

Configure the setting for each of the following items:

Polling Memory, Confidential, Relay Broadcast (Direct Entry), Relay Broadcast (Address Book)

Factory default settings: All Invalid

Disable Destination Registration Using Global Address Search

This disables address control from the global address search.

Configure the setting for each of the following items:

E-mail, Internet Fax, Fax

Factory default settings: All Invalid

Disable Registration Using Network Scanner Tools

This disables address control from the Network Scanner Tools.

Factory default settings: Disable

Disabling of Forwarding via Network

This prohibits inbound routing.

Factory default settings: Disable

Settings to Disable Transmission

These settings are used to disable the following transmission operations.

Disabling Sending History

This disables the use of [Sending History].

Factory default settings: Disable

Disable Selection from Address Book

Disables the selection of destinations from the address book.

Configure the setting for each of the following items:

- E-mail
- FTP
- Internet Fax (including Direct SMTP)
- Fax
- Desktop
- Network Folder

Select All: Select all items.

Clear Checked: Deselect all items.

Factory default settings: All Invalid



Disable Direct Entry

Disables the direct entry of destination address and others.

Configure the setting for each of the following items:

- E-mail
- Network Folder
- Internet Fax (including Direct SMTP)
- Fax

Select All: Selects all items.

Clear Checked: Clears all selections.

Factory default settings: All Invalid

Disable PC-I-Fax Transmission

This prohibits PC-I-Fax transmission.

Factory default settings: Disable

Disable PC-Fax Transmission

This prohibits PC-Fax transmission.

Factory default settings: Disable

Disabling of Find My Address

This prohibits Find My Address.

Factory default settings: Disable

Disabling of OCR

Prohibits the use of the OCR function when scanning.

Factory default settings: Disable

Document Filing Settings

Disabling Text/Stamp printing at Reprint

When a stored file is retrieved and printed, the printing functions are disabled.

This function prevents an inconsistency of the date between the original data and output data and others.

Factory default settings: Disable

Batch Print Settings

Set whether or not the [All Users] key and the [User Unknown] key are prohibited in the user name selection screen when printing all files, whether files are sorted by date in newest or oldest order, and whether file names are sorted in ascending or descending order.

Factory default settings: Disable



The Enable/Disable Settings control the same parameters as the enable/disable settings in other settings. The settings are linked together (changing one setting changes the other).

Operation Settings

Cancel Auto Clear Timer

Disables the Auto Clear mode.

Factory default settings: Disable

Disabling of Job Priority Operation

Disables bypass printing (printing other jobs ahead of a job that has been stopped *because the paper required for the job is not in any of the trays).

* This option is ignored when paper runs out during the job.

Factory default settings: Disable

Disable Auto Key Repeat

Disables the Auto Key Repeat function.

Factory default settings: Disable

Disabling of Covers/Inserts Mode

Disables the use of the covers and inserts function.

Factory default settings: Disable

Disable Manual Finishing

Disables the use of manual finishing.

Factory default settings: Disable



Disabling Recent Jobs

Prohibit the use of [Recent Jobs].

Factory default settings: Disable

Device Control

Disabling of Document Feeder

Use this setting to prohibit the use of the automatic document feeder, such as when the feeder malfunctions. (When the setting is enabled, scanning is still possible using the document glass.)

Factory default settings: Disable

Disabling of Duplex

This is used to disable 2-sided printing, such as when the duplex module malfunctions.

Factory default settings: Disable

Disabling of Large Capacity Cassette

This setting is used to prohibit the use of the large capacity tray, such as when it malfunctions.

Factory default settings: Disable

Disabling of Tray Setting

This setting is used to prohibit tray settings (except for the bypass tray).

Factory default settings: Disable

Disabling of Finisher

This setting is used to prohibit the use of finisher or saddle finisher, such as when it malfunctions.

Factory default settings: Disable

Disabling of Inserter

Disables use of the inserter.

Factory default settings: Disable

Disabling of Offset

Disable offset output.

Factory default settings: Disable

Disabling of Stapler

This setting is used to prohibit the use of staple, such as when the staple of finisher or saddle finisher malfunctions.

Factory default settings: Disable

Disabling of Punch

Disabling of Folding Unit.

Factory default settings: Disable

Disabling of Folding Unit

It is used when the use of the paper folding unit is prohibited or when it breaks down.

Factory default settings: Disable

Disabling of Trimming Module

This setting is used to disable the trimming module.

Factory default settings: Disable

Disabling of Primary Unit Mode

Disables the primary unit mode for tandem printing.

(Normally this setting is not necessary.)

Factory default settings: Disable

Disabling of Secondary Unit Mode

Disables the secondary unit mode for tandem printing.

(Normally this setting is not necessary.)

Factory default settings: Disable

Security Settings

This setting is used to set the security enhancement functions.

Hidden Pattern Print Setting

Disables the direct entry of background pattern and others.

Factory default settings: Disable



Product Key/Application Number Input

Enter the product key and application number to use the extensions below.

Serial Number

Barcode Font Kit

Internet Fax Expansion Kit

E-mail Alert and Status

Application Integration Module

Virus Detection Kit

Enter the product key and application number for the above functions.



Depending on the activation status of the extended function of the machine, the items displayed will change.
For the product key to be entered, contact your dealer.

Sound Settings

Configure machine notification sounds and their volume.

Beep Sound Settings (Common)

Keys Touch Sound

Controls the key touch sound level, or turns the sound off.

Factory default settings: Middle

Beep of Invalid Input

Control the volume of the sound, or turn the sound off at an invalid setting, such as when a number that cannot be specified is entered.

Factory default settings: Middle

Reference Tone

This turns the sound on when changing the copy ratio or exposure, and the setting reaches the standard value (copy ratio 100%, exposure 3). Control the reference tone sound level, or turns the sound off.

Factory default settings:No Sound

Copy Complete Sound

Control the copy completed notification sound level, or turns the sound off.

Factory default settings:No Sound

Scan Complete Sound (Image Send)

Control the fax or scanner scanning completed notification sound level, or turns the sound off.

Factory default settings: Middle



Powering Off Sound

Control the machine power off notification sound level, or turns the sound off.

Factory default settings: Middle

Caution Sound Settings

Set whether to play a notification sound when the machine is in the following status.

Paper Empty, No Original, Jam, Toner Empty (Black), Waste Toner Full, Output Tray Full, Stapler Empty, Maximum Number of Sheets that can be Stapled is Reached

Factory default settings: Warning Beep:Medium, Paper Empty:Enable, Invalid except Paper Empty

Beep Sound Settings (Image Send)

Adjust the sound volume of functions used in fax and scan operations.



You can check the setting sound in the setting mode of this machine.

Fax

Set the sound for the Speaker, Ringer Volume, Line Monitor, Fax Receive Complete Signal, Fax Send Complete Signal, and Fax Communication Error Signal.

Factory default settings:Speaker:Speaker Volume Setting:5, Ringer Volume:Speaker Volume Setting:3, Line Monitor:Speaker Volume Setting:None, Fax Receive Complete Signal:Speaker Volume Setting:3, Tone Pattern:Pattern 3, Transmission Complete Sound Time Setting:3.0sec, Fax Send Complete Signal:Speaker Volume Setting:3, Tone Pattern:Pattern 3, Transmission Complete Sound Time Setting:3.0sec

Fax Communication Error Signal:Speaker Volume Setting:3, Tone Pattern:Pattern 3, Transmission Complete Sound Time Setting:Every 0.3 seconds

Internet Fax

Adjust the Fax Communication Error Signal and Fax Receive Complete Signal speaker volume setting.

Factory default settings: Communication Error Signal:Middle, Fax Receive Complete Signal:Middle



Network Settings

Quick Settings

Select the minimum required settings for the machine connection to the network.

Wireless Settings

Connection Type

Switch between [Wired Only], [Wired + wireless (access point)], [Wireless (Infrastructure Mode)] or [Wired+Wireless (Wi-Fi Direct Mode)] according to the network connection status.

Factory default settings: Wired + wireless (access point)

Keep Wireless Access Point activated

This can be set only when "Connection Type" is "Wired+Wireless (Access Point Mode)".

If enabled, the machine can normally use a wireless LAN network.

If disabled, wireless LAN will be enabled when the NFC touchpoint area is touched on a mobile device or when the [Easy Connect Setup (QR code)] key is tapped on the home screen.

When one of the conditions below occurs, the wireless LAN connection is automatically canceled.

- When there is no connection to the access point for a certain period of time.

Factory default settings: Disable

When "Wireless (Infrastructure Mode)" is selected in "Connection Type"

Access Point Search

Click this to search access points. When the search results are displayed, select the access point to use and click [OK]. [SSID], [Security Type], and [Encry.] are automatically applied.

SSID

Enter the SSID.

Security Type

Select a security type.

Factory default settings:No Sound

Encry.

Select an encryption type.

Factory default settings:No Sound

Security Key

Enter a security key.

Security Type	Security Key
None	WEP64bit: 5 characters or 10-digit hexadecimal number
WEP	WEP128bit: 13 characters or 26-digit hexadecimal number
WPA/WPA2-mixed Personal	WPA/WPA2/WPA3: 8 to 63 characters or 64-digit hexadecimal number
WPA/WPA2-mixed Enterprise	
WPA2 Personal	
WPA2 Enterprise	
WPA2/WPA3-mixed Personal	
WPA3 Personal	
WPA2/WPA3-mixed Enterprise	
WPA3 Enterprise	

**Show Security Key**

If it is set to ON, the security key appears.

Factory default settings:No Sound

IPv4 Settings

When using the machine on a TCP/IP (IPv4) network, use this setting to configure the IP address of the machine. The settings are shown below.

DHCP

Use this setting to have the IP address obtained automatically using DHCP (Dynamic Host Configuration Protocol)/BOOTP (Bootstrap Protocol). When this setting is enabled, it is not necessary to manually enter an IP address.

Factory default settings: Enable



If DHCP/BOOTP is used, the IP address assigned to the machine may change automatically. If the IP address changes, printing will not be possible.

IPv4 Address

Enter the IP address of the machine.

Subnet Mask

Enter the IP subnet mask.

Default Gateway

Enter the default gateway address.

Network Name Settings**Device Name**

Enter a device name.

Domain Name

Enter the domain name.

Factory default settings: Sharp-Printer

DNS Settings**Primary Server**

Enter the IP address of primary DNS server.

Secondary Server

Enter the IP address of secondary DNS server.

Domain Name

Enter the domain name where the selected DNS server exists.



SMTP Settings

Primary Server

Enter the IP address or the host name of the primary SMTP server.

Sender Name

Enter the sender name.

Sender Address

If data transmission has failed, the undelivered e-mail may be returned from the server. Enter an e-mail address (a single address only) to receive such undelivered mails. Usually, enter the e-mail address of system administrator.

Enable SSL/TLS

If is selected, the SMTP-over-TLS encryption communication can be used by STARTTLS command.

This requires the server to support the STARTTLS command.

To allow SSL/TLS communication, set the "Port Number" to the same port number as the normal SMTP.

Factory default settings: Disable

Authentication Option

Specify the authentication method for SMTP.

Select "OAuth 2.0" when using Microsoft365, Exchange Online, etc.

For information on how to configure the settings when OAuth 2.0 is selected, see "[OAuth 2.0 AUTHENTICATION \(page 9-39\)](#)".

Factory default settings: No Authentication

Provider

This can be set when "OAuth 2.0" is selected as "Authentication Option".

Select a provider.

Factory default settings: Microsoft

Account Name

This can be set when "OAuth 2.0" is selected as "Authentication Option".

Enter an account name.

Token

This can be set when "OAuth 2.0" is selected as "Authentication Option".

Displays the current token status.

Get Token / Delete

The "Get Token" key is displayed if the token has not been obtained, and the "Delete" key is displayed if the token has been obtained.

The "Get Token" key is displayed in the System Settings of the machine and is not displayed on the Web page.

User Name

This setting is available when "SMTP Authentication" is selected as "Authentication Option".

Enter the user name.

Password

This setting is available when "SMTP Authentication" is selected as "Authentication Option".

Enter the password.

To change the password, set [Change Password] to .



POP before SMTP

This setting is available when you select "Authentication Option" other than "OAuth 2.0".

If is set, you are authenticated to the POP server before using the SMTP communication.

- POP3 Server: Enter the IP address or the host name of the secondary SMTP server.

Factory default settings: Disable

- Port Number: Enter the POP3 port number for POP before SMTP communication. The default setting is port 110.

Factory default settings: 110

- POP Authentication: If is set, the authentication protocol (including APOP) is used for authentication to the POP3 server.

Factory default settings: Disable

- User Name: Enter the user name for POP before SMTP communication.
- Password: Enter the password required for POP before SMTP communication. To change the password, set [Change Password] to .
- Enable SSL/TLS: If set to , the POP over SSL/TLS communication or the POP over TLS communication by STLS command is enabled. This requires the server to support the POP over SSL/TLS communication or the STLS command. To allow SSL/TLS communication, set the "Port Number" to the POP over SSL communication port number. To allow POP over TLS communication, set the "Port Number" to the same port number as for the normal POP3 communication.

Factory default settings: Disable

Connection Test

Tap the [Execute] button to test the connection to the SMTP server.

LDAP Settings

Name

Enter the address book name.

Default Address Setting

Enters the search defaults to search for a specific area of the LDAP directory information tree.

Example: o = ABC, ou = NY, cn = Everyone

Entries must be separated by semicolons or commas.

LDAP server:

Enter the IP address or host name of the LDAP server.

User Name

Enter the account name for LDAP setting.

Password

Enter the password.

Change PIN Code/Password

To change the password, set .

Authentication

Select the authentication server from the drop-down list.

Factory default settings: Anonymous

KDC Server

Enter the IP address or host name of the Kerberos authentication server.

Realm

Enter the Kerberos realm.



Enable SSL/TLS

If is set, the SSL/TLS encryption communication is enabled.

Connection Test

Tap the [Execute] button to test the connection to the LDAP server.

Network Name Setting

Device Name

Enter a device name.

Domain Name

Enter the domain name.

Factory default settings: Sharp-Printer

Comment

Enter a comment.

Interface Settings

Mainly set items related to TCP/IP.

Connection Type

Switch between [Wired Only], [Wired + wireless (access point)], [Wireless (Infrastructure Mode)] or [Wired+Wireless (Wi-Fi Direct Mode)] according to the network connection status.

Factory default settings: Wired + wireless (access point)

Keep Wireless Access Point activated

This can be set only when "Connection Type" is "Wired+Wireless (Access Point Mode)".

If enabled, the machine can normally use a wireless LAN network.

If disabled, wireless LAN will be enabled when the NFC touchpoint area is touched on a mobile device or when the [Easy Connect Setup (QR code)] key is tapped on the home screen.

When one of the conditions below occurs, the wireless LAN connection is automatically canceled.

- When there is no connection to the access point for a certain period of time.

Factory default settings: Disable



IPv4 Settings

When using the machine on a TCP/IP (IPv4) network, use this setting to configure the IP address of the machine. The settings are shown below.

DHCP

Use this setting to have the IP address obtained automatically using DHCP (Dynamic Host Configuration Protocol). When this setting is enabled, it is not necessary to manually enter an IP address.

Factory default settings: Enable



If DHCP/BOOTP is used, the IP address assigned to the machine may change automatically. If the IP address changes, printing will not be possible.

IPv4 Address

Enter the IP address of the machine.

Subnet Mask

Enter the IP subnet mask.

Default Gateway

Enter the default gateway address.

IPv6 Settings

When using the machine on a TCP/IP (IPv6) network, use this setting to configure the IP address of the machine.

IPv6

Enable this setting.

Factory default settings: Enable

DHCPv6

Use this setting to have the IP address obtained automatically using DHCP (Dynamic Host Configuration Protocol) v6. When this setting is enabled, it is not necessary to manually enter an IP address.

Factory default settings: Enable

Manual Address/Prefix Length

Enter the IP address and the prefix length (0 to 128) of the machine.

Factory default settings: 0

Default Gateway

Enter the default gateway.



If DHCPv6 is used, the IP address assigned to the machine may change automatically. If the IP address changes, printing will not be possible.

MTU Settings

Set the maximum data size that can be forwarded.

Factory default settings: 1500

Ping Command

Checks if the machine can communicate with the PC of the network.

Specify the IP address of the desired PC and tap the [Execute] key. A message indicating a response by the PC or not is displayed.



DNS Settings

IPv4 Settings

Primary Server

Enter the IP address of primary DNS server.

Secondary Server

Enter the IP address of secondary DNS server.

IPv6 Settings

Primary Server

Enter the IP address of primary DNS server.

Secondary Server

Enter the IP address of secondary DNS server.

Domain Name

Enter the domain name where the selected DNS server exists.

Dynamic DNS Updating

Set this option to use the dynamic updating of DNS server.

Factory default settings: Disable

IEEE802.1X Setting

IEEE802.1X can be used to authenticate a user to allow use of the machine.

IEEE802.1X protocol defines port-based authentication for both wired and wireless networks.

Use IEEE802.1X authentication to allow only authenticated devices to use network, and protect against network abuse by third parties.

Depending on the Web page settings, connection to the machine may not be allowed, or the settings may not allow printing, scanning, or Setting mode (Web version) display. In this case, deselect this setting and change the Setting mode (Web version) settings.

IEEE802.1X Authentication/IEEE802.1X Authentication (Wired)

Set whether to use authentication using IEEE802.1X.

Factory default settings: Disable

EAP Authentication Method

Set the EAP authentication method in IEEE802.1X.

Factory default settings: EAP-TLS

EAP User Name

Enter the EAP user name when authenticating.

Password

Enter the EAP password for authentication.

Server Authentication

Set whether to use server authentication.

Factory default settings: Enable

EAP Timeout

Set the EAP timeout.

Factory default settings: 10 seconds



Number of EAP Retries

Set the number of times to re-access the EAP when communication fails.

Factory default settings: 3 Time(s)

Certificate Status

Shows the status of the certificate required for transmission using IEEE802.1X. To install a certificate, click [Install].

CA Certificate Status

Shows the status of the CA certificate required for transmission using IEEE802.1X. To install a certificate, click [Install].

Services Settings

Make settings for SMTP, Kerberos Authentication Settings, SNMP, mDNS, SNMP, and SMB.



When settings are changed, the changes will take effect after the machine is restarted. For details on restarting this machine, see "[TURNING ON THE POWER \(page 1-10\)](#)".

SMTP

SMTP Settings

Primary Server

Enter the IP address or the host name of the primary SMTP server.

Secondary Server

This setting is available when you select "Authentication Option" other than "OAuth 2.0".

Enter the IP address or the host name of the secondary SMTP server.

Port Number

Enter a port number.

Factory default settings: 25

Timeout

Enter a timeout. This value is used for connection to the SMTP server and for data transmission according to the e-mail system specifications.

Factory default settings: 20 seconds

Sender Name

Enter the sender name.

Sender Address

Enter the sender's address

Enable SSL/TLS

If the SSL is enabled, the SMTP-over-TLS encryption communication can be used by STARTTLS command.

This requires the server to support the STARTTLS command.

To allow SSL/TLS communication, set the "Port Number" to the same port number as the normal SMTP.

Factory default settings: Disable

Authentication Option

Specify the authentication method for SMTP.

Select "OAuth 2.0" when using Microsoft365, Exchange Online, etc.

For information on how to configure the settings when OAuth 2.0 is selected, see "[OAuth 2.0 AUTHENTICATION \(page 9-39\)](#)".

Factory default settings: No Authentication

Provider

This can be set when "OAuth 2.0" is selected as "Authentication Option".

Select a provider.

Factory default settings: Microsoft

**Account Name**

This can be set when "OAuth 2.0" is selected as "Authentication Option".
Enter an account name.

Token

This can be set when "OAuth 2.0" is selected as "Authentication Option".
Displays the current token status.

Get Token / Delete

The "Get Token" key is displayed if the token has not been obtained, and the "Delete" key is displayed if the token has been obtained.

The "Get Token" key is displayed in the System Settings of the machine and is not displayed on the Web page.

User Name

This setting is available when "SMTP Authentication" is selected as "Authentication Option".
Enter the user name.

Password

This setting is available when "SMTP Authentication" is selected as "Authentication Option".
Enter the password.

To change the password, set [Change Password] to .

POP before SMTP

This setting is available when you select "Authentication Option" other than "OAuth 2.0".

If is set, you are authenticated to the POP server before using the SMTP communication.

- POP3 Server: Enter the IP address or the host name of the secondary SMTP server.

Factory default settings: Disable

- Port Number: Enter the POP3 port number for POP before SMTP communication. The default setting is port 110.

Factory default settings: 110

- POP Authentication: If is set, the authentication protocol (including APOP) is used for authentication to the POP3 server.

Factory default settings: Disable

- User Name: Enter the user name for POP before SMTP communication.
- Password: Enter the password required for POP before SMTP communication. To change the password, set [Change Password] to .
- Enable SSL/TLS: If set to , the POP over SSL/TLS communication or the POP over TLS communication by STLS command is enabled. This requires the server to support the POP over SSL/TLS communication or the STLS command. To allow SSL/TLS communication, set the "Port Number" to the POP over SSL communication port number. To allow POP over TLS communication, set the "Port Number" to the same port number as for the normal POP3 communication.

Factory default settings: Disable

Connection Test

Tap the [Execute] button to test the connection to the SMTP server.

Kerberos

Kerberos Authentication Settings

KDC Server

Enter the IP address or host name of the Kerberos authentication server.

Port Number

Enter the port number of the Kerberos authentication server.

Factory default settings: 88

Realm

Enter the Kerberos realm.

SNTP



SNTP Settings

SNTP

Set this option to use the SNTP protocol.

Factory default settings: Disable

SNTP Server

Enter the IP address or host name of the SNTP server.

Port Number

Enter a port number.

Factory default settings: 123

Timeout

Enter a timeout.

Factory default settings: 5 seconds

Synchronous Interval

Enter an interval to synchronize to the SNTP server.

Factory default settings: 6 Hour

Synchronize Upon Start

To establish synchronization during machine startup, set to .

Factory default settings: Disable

Synchronize Now

When tapped, the machine is synchronized with the SNTP server time.

mDNS

mDNS Settings

mDNS

Set this option to use the mDNS settings.

Factory default settings: Enable

Service Name

Enter a service name.

Domain Name

Display the domain name.

Priority Service

Select a service you use with the priority.

Factory default settings: LPD

SNMP

SNMP v1 Settings

SNMP v1 Settings

Set this option to use the SNMPv1 settings.

Factory default settings: Enable

Access Method

Set an access method.

Factory default settings: Read-write Access

GET Community

Enter the GET community name to fetch the device information using SNMP.

Factory default settings: public

SET Community

Enter the SET community name required for SNMP setting.

Factory default settings: private



Change SET Community

To change the SET community, set .

Factory default settings: Disable

TRAP Community

Enter the community name to be used for the SNMP TRAP sent from the device.

Factory default settings: public

**TRAP Target Address**

Enter the IP address of the destination computer for SNMP TRAP communication.

SNMP v3 Settings**SNMP v3 Settings**

Set this option to use the SNMPv3 settings.

Factory default settings: Disable

User Name

Enter the user name.

Authentication Key

Enter the authentication key.

Factory default settings: Algorithm:MD5

Privacy Key

Enter the privacy key.

Factory default settings: Algorithm

Context Name

Display the context name.

SMB**SMB Settings (Server)**

Set the version of SMB protocol that is used for functions such as public folder/NAS.

Use this setting to connect to a device that cannot automatically change the SMB protocol version, or when there is a problem in the connection with another device due to different versions.

Set the version to SMBv1, SMBv2, or SMBv3.

Factory default settings: All Enabled

Use encrypted communication

When the checkbox is checked, encrypted communication is used when sending files from the connected terminal to the public folder/NAS of the machine.

Factory default settings: Disable

SMB Settings (Client)

Set the version of SMB protocol that is used for functions such as Scan to Network Folder.

Use this setting to connect to a device that cannot automatically change the SMB protocol version, or when there is a problem in the connection with another device due to different versions.

Set the version to SMBv1, SMBv2, or SMBv3.

Factory default settings: All Enabled

Print Port Settings**LPD****LPD Settings****LPD**

Set this option to use LPD.

Factory default settings: Enable

Timeout

Enter a timeout.

Factory default settings: 90 seconds

Use Banner

Set this option to use the banner.

Factory default settings: Disable



RAW

Raw Print Settings

Raw Print

Set this option to use RAW printing.

Factory default settings: Enable

Port Number

Enter a port number.

Factory default settings: 9100

Timeout

Enter a timeout.

Factory default settings: 90 seconds

Use Bidirectional

To use bidirectional communication, set to .

Factory default settings: Disable

WSD

WSD Settings

WSD Print

Set this option to use WSD printing.

Factory default settings: Disable

Use Multicast Discovery

Set this option to use multicast discovery.

Factory default settings: Enable



External Print Services Settings

For AirPrint Settings, see the "AirPrint Guide".

Universal Print Settings

Universal Print

Sets whether the Universal Print service is used.

Factory default settings: Enable



Enabling this setting will automatically enable IPP INFRA on the Client Port in the Port Control.

Status

Displays the current status of the Universal Print service.

Printer Name

Set the print name for use with the machine's Universal Print service.

This setting is available when the machine is not registered for Universal Print service.

Register with Universal Print

This option is available when the Universal Print service is not yet registered.

Registration Code

You will see a code to register for the Universal Print service.

URL for code registration

Clicking on the URL will take you to a separate window where you can enter your code for registration.

Delete from Universal Print

This is used to unregister the machine from the Universal Print service.

LDAP Settings

The following explains the LDAP settings.

When you tap the [Store] key, the LDAP settings are updated with your entries.

The default address book is set to .

Add

To add a global address book, tap the Add key.

Delete

To delete the global address book, select the item and tap the [Delete] key.



Settings

Setting item	Settings
Name	Enter the address book name.
Default Address Setting	Enters the search defaults to search for a specific area of the LDAP directory information tree. Example: o = ABC, ou = NY, cn = Everyone Entries must be separated from each other by semicolons or commas.
LDAP server:	Enter the IP address or host name of the LDAP server.
Server Type	Select the Default or Custom from the service type list. Factory default settings: Default
User ID Property	Set the user ID property. Factory default settings: uid
LDAP Search Property	Set the LDAP search property. Factory default settings: cn
E-mail Address Search	Set the e-mail address search. Factory default settings: mail
I-Fax Address Search	Set the Internet Fax address search. Factory default settings: mail
Fax Number Search	Set the fax number search. Factory default settings: facsimileTelephoneNumber
Search Open Key	Sets the open key search. Factory default settings: userCertificate
Pages Limit Group	Set the Storing Page Limit Group Search. Factory default settings: pagelimit
Authority Group	Set the Storing Authority Group Search. Factory default settings: authority
Favorite Operation Group	Set the Favorite Operation Group Search. Factory default settings: favorite
My Folder	Set the My Folder Search. Factory default settings: myfolder
Card ID	Sets the card ID search. Factory default settings: cardid
Home Directory	Enter the path to your home directory. Factory default settings: homeDirectory
User Name	Enter the user name for authentication against your home directory path.
Password	Enter a maximum of 255 numeric digits for the password for home directory path authentication.
Custom Property 1-10	Enter each custom property.
Port Number	Enter a port number. Factory default settings: 389
Timeout	Enter a timeout. Factory default settings: 5 seconds
User Name	Enter the account name for LDAP setting. Factory default settings: Anonymous



Setting item	Settings
Password	Enter the password. To change the password, set [Change Password] to <input checked="" type="checkbox"/> .
Authentication	Select the authentication server from the drop-down list.
Bind Prefix	Set the Bind prefix. Factory default settings: uid
Server Usage	Set the server application. Set the address book and user authentication. Factory default settings: All EnabledLPD
Applicable Destination Type	Select the applicable destination type from E-mail Address, Fax Number, and Internet Fax. Factory default settings: E-mail Address
Allow selection on operation panel	Specify whether or not enable the global address to be selected on the operation panel of the machine. Factory default settings: Disable
To Be Used as Default	Specify whether or not to use the selected global address as default. Factory default settings: Disable
Authenticate a User in Global Address Search	Select whether or not authenticate a user when a global address is searched for. Factory default settings: Disable
Enable SSL/TLS	Encrypted communication by SSL/TLS is performed. Factory default settings: Disable
Connection Test	Tap the [Execute] button, and the connection test is executed and its result is displayed.



When settings are changed, the changes will take effect after the machine is restarted. To restart the machine, see "[TURNING ON THE POWER \(page 1-10\)](#)".



Active Directory Settings

This section describes the items to be set in the Active Directory settings of the system settings among the settings to be made when using Active Directory on this machine.

Search Attribute

Set search attributes.

Factory default settings: cn

Linkage with User Control Function

Pages Limit Group

Enter when setting the usage restriction group.

Factory default settings: pagelimit

Authority Group

Enter when setting the permission group.

Factory default settings: authority

Favorite Operation Group

Enter when setting the preferred operation group.

Factory default settings: favorite

My Folder

Enter when setting My Folder.

Factory default settings: myfolde

Device Registration Account

User Name

Enter the user name to use.

Password

Enter the password.

Public Folder / NAS Setting

Set each option to [Prohibited] if the storage is not used.

Factory default settings: Use of Storage:All Allow



When settings are changed, the changes will take effect after the machine is restarted. For details on restarting this machine, see "[TURNING ON THE POWER \(page 1-10\)](#)".



Proxy Setting

Access the network through a proxy server.

Settings

Item	Description
Proxy Setting	Access the network through a proxy server. Factory default settings: Disable
Proxy Server Address	Enter the proxy server address.
User Name	Enter a user name to access the proxy server.
Password	Enter a password to allow access to the proxy server.
Port Number	Enter the proxy server port number. Factory default settings: 8080
Address without using proxy	Specify the exception address of the proxy used by the external linkage function or Sharp OSA. [Entry method] 1) Can be set using a host name or an IP address. 2) When using a host name, you can use a wildcard (*) at the beginning of the domain name. (Example: "**example.ooo" (equivalent to "example.ooo", "sub.example.ooo", "subexample.ooo", etc.) 3) When using an IP address, you can use a wildcard (*) at the end of the address. (Example: "10*" (equivalent to 100.nnn.nnn.nnn to 109.nnn.nnn.nnn) If the Sharp OSA application using "HTML Browser 3.5" is set to an exception address, rule (3) cannot be used. 4) You can use a separator (semicolon (;)) to enter multiple addresses. (Example: "99.99.99.99;example.ooo")



Wireless Settings

Used to enable or disable the wireless LAN and show the status of wireless LAN.

Connection Type

Switch between [Wired Only], [Wired + wireless (access point)], [Wireless (Infrastructure Mode)] or [Wired+Wireless (Wi-Fi Direct Mode)] according to the network connection status.

Factory default settings: Wired + wireless (access point)

Keep Wireless Access Point activated

This can be set only when "Connection Type" is "Wired+Wireless (Access Point Mode)".

If enabled, the machine can normally use a wireless LAN network.

If disabled, wireless LAN will be enabled when the NFC touchpoint area is touched on a mobile device or when the [Easy Connect Setup (QR code)] key is tapped on the home screen.

When one of the conditions below occurs, the wireless LAN connection is automatically canceled.

- When there is no connection to the access point for a certain period of time.

Factory default settings: Disable

Current Setting

Shows settings, such as the SSID of a wireless LAN and security type. If the wireless LAN is disabled, "--" appears.

Current Wireless Status

This shows reception levels (Max. 100) of the wireless LAN and IP addresses.

Show Wireless Setting Screen

Click the [Setup] button.

In the Wireless Setting screen, you can configure the SSID of a wireless LAN, Security Type, Encry., and Security Key.

Initialize Wireless Settings

Click the [Initialize] button.

The settings for SSID, Security Type, Encry., and Security Key are initialized.

Wireless Setting screen (Access Point Mode)

If the [Settings] button is clicked while [Connection Type Switching] is set to [Wired+Wireless (Access Point Mode)] or [Wired Only], the Wireless Settings (Access Point Mode) screen is displayed.

Configure the SSID of a wireless LAN, Security Type, Encry., and Security Key.

Clicking the [Submit] button stores the settings.

Frequency Band

Set the frequency band used for a wireless LAN.

Factory default settings:No Sound

SSID

Enter the SSID.



Security Type

Select a security type.

Factory default settings: WPA/WPA2-mixed Personal

Encry.

Select an encryption type.

Factory default settings: AES

Security Key

Enter a security key.

Security Type	Security Key
WEP	WEP64bit: 5 characters or 10-digit hexadecimal number
WPA/WPA2-mixed Personal	WEP128bit: 13 characters or 26-digit hexadecimal number
WPA2 Personal	WPA/WPA2/WPA3: 8 to 63 characters or 64-digit hexadecimal number
WPA2/WPA3-mixed Personal	
WPA3 Personal	
WPA2/WPA3-mixed Enterprise	
WPA3 Enterprise	

Show Security Key

When enabled, the security key will be displayed.

Factory default settings: Disable

Device IP Address

Enter the IP address.

Channel to Be Used

Select the channel to be used in wireless LAN.

Factory default settings: When the frequency band is 2.4GHz: 1, when the frequency band is 5GHz: 36

IP Address Distribution Range Setting

Configure the range to be used the IP address.

Factory default settings: Start IP Address:11, End IP Address:15

Lease Period

Set the validity period of the IP address assigned by DHCP.

Factory default settings: 15 minutes

Wireless setting screen (infrastructure mode)

If you click the [Set] button when [Switch Connection Type] is set to [Wireless (Infrastructure Mode)], the Infrastructure Mode Wireless Setting screen is displayed.

Configure the SSID of a wireless LAN, Security Type, Encry., and Security Key. Clicking the [Submit] button stores the settings.

Access Point Search

Search for an access point. When the search results are displayed, select the access point to use and click [OK]. [SSID], [Security Type], and [Encry.] are automatically applied.

WPS: Push Button Method

Use WPS to connect to the access point. Put the signal on standby at the access point, then click the button to connect.

WPS: PIN Code Method

Enter the access point PIN code to connect.



SSID

Enter the SSID.

Security Type

Select a security type.

Factory default settings:None

Encry.

Select an encryption type.

Factory default settings:None

Security Key

Enter a security key.

Security Type	Security Key
WEP	WEP64bit: 5 characters or 10-digit hexadecimal number
WPA/WPA2-mixed Personal	WEP128bit: 13 characters or 26-digit hexadecimal number
WPA/WPA2-mixed Enterprise	WPA/WPA2/WPA3: 8 to 63 characters or 64-digit hexadecimal number
WPA2 Personal	
WPA2 Enterprise	
WPA2/WPA3-mixed Personal	
WPA3 Personal	
WPA2/WPA3-mixed Enterprise	
WPA3 Enterprise	

Show Security Key

If it is set to ON, the security key appears.

Factory default settings: Disable

Easy Connection Setting

Set when using Easy Connection.

NFC

Set when connecting a mobile device to this unit using the NFC touch point area.

Factory default settings: Disable

NFC Signal

Switches the mode of the NFC outgoing signal.

Factory default settings: In United States and Europe: Mode2, others: Mode1

QR code

You can install the dedicated application on the mobile device in advance, scan the displayed QR code, send the connection settings to the mobile device, and register it.

Factory default settings: Enable

Destination

Set the connection destination to connect to and the connection destination to be registered in the QR code.

To connect to this machine, select [Connect with the machine]. The information required when connecting to this machine is registered in the application.

To select a connection destination other than this machine, select [Connect with the following access point].

When setting manually, obtain the network information of the connection destination in advance.

If you select [Connect with the following access point], make the following settings.

Factory default settings: Connect with the machine



Access Point Search

Click this to search access points. When the search results are displayed, select the access point to use and click [OK]. [SSID], [Security Type], and [Encry.] are automatically applied.

Name

Enter the name of the connection destination.

SSID

Enter the SSID.

Security Type

Select a security type.

Factory default settings: WPA2 Personal

Encry.

Select an encryption type.

Factory default settings: AES

Security Key

Enter a security key.

Security Type	Security Key
WEP	WEP64bit: WEP64bit: 5 characters or 10-digit hexadecimal number
WPA/WPA2-mixed Personal	WEP128bit: 13 characters or 26-digit hexadecimal number
WPA2 Personal	WPA/WPA2/WPA3: 8 to 63 characters or 64-digit hexadecimal number
WPA2/WPA3-mixed Personal	
WPA3 Personal	
WPA2/WPA3-mixed Enterprise	
WPA3 Enterprise	

Show Security Key

When enabled, the security key will be displayed.

Factory default settings: Disable

Bluetooth Setting

Set when connecting this unit to a mobile device using Bluetooth.

Bluetooth

You can use the Bluetooth function with this unit.

Factory default settings: Disable

Device Web Page Setting

The following explains the access settings to Setting mode (Web version).

HTTP Access Settings

Number of Users who can log in at the Same Time

Enter a number of users who can access Setting mode (Web version) simultaneously.

Factory default settings: 32

Auto Logout Time

Enter a time to automatically log out when no communication continues with the machine.

Factory default settings: 60 minutes



When settings are changed, the changes will take effect after the machine is restarted. For details on restarting this machine, see "[TURNING ON THE POWER \(page 1-10\)](#)".



View Login User

The user or users who have logged in this machine are displayed.

Current Login Users

Shows the currently logged in user and IP address.

Log Out All Users

The current login users are logged out.



When settings are changed, the changes will take effect after the machine is restarted. For details on restarting this machine, see "[TURNING ON THE POWER \(page 1-10\)](#)".



Security Settings



When settings are changed, the changes will take effect after the machine is restarted. For details on restarting this machine, see "[TURNING ON THE POWER \(page 1-10\)](#)".

Password Setting

Password Policy Settings

This setting is used when you want to set a more strict password or when users who have not logged in for a specified period of time are to be deleted.

Password Policy Settings

Enables this option when you want to make your existing password settings more strict.

Factory default settings: Disable

Admin Password

Changes the setting of the administrator password.

Minimum Password Length

Specifies the number of characters for the password to be entered.

Factory default settings:5

Enable Password Creation Rules

When setting a password, make sure that it contains at least one or more numbers, uppercase and lowercase letters of the alphabet, and symbols.

The characters that can be entered are as follows.

- Numbers: 0 to 9
- Upper case alphabet: A to Z
- Lower case alphabet: a to z
- Symbols: ! @ # \$ % ^ & * () " ' + , - . / : ; < = > ? [\] _ ` { | } ~ and spaces



If you enable this setting, you will need to enter at least four characters: one each for numbers, uppercase alphabet, lowercase alphabet, and symbols. Even if you set "Minimum Password Length" to 3 or less, you will still need to enter 4 characters.

Factory default settings: Disable

Prohibit Reuse of Current Password

Check if the password you set before the change is the same as the password after the change, and if it is the same, you will not be able to register it. (However, if "Minimum Password Length" is 0, this setting cannot be used.)

Factory default settings: Disable

User Password

Changes the setting of the user password.

Minimum Password Length

Specifies the number of characters for the password to be entered.

Factory default settings:5



Enable Password Creation Rules

When setting a password, make sure that it contains at least one or more numbers, uppercase and lowercase letters of the alphabet, and symbols.

The characters that can be entered are as follows.

- Numbers: 0 to 9
- Upper case alphabet: A to Z
- Lower case alphabet: a to z
- Symbols: ! @ # \$ % ^ & * () ' + , - . / : ; < = > ? [\] _ ` { | } ~ and spaces



If you enable this setting, you will need to enter at least four characters: one each for numbers, uppercase alphabet, lowercase alphabet, and symbols. Even if you set "Minimum Password Length" to 3 or less, you will still need to enter 4 characters.

Factory default settings: Disable

Prohibit Reuse of Current Password

Check if the password you set before the change is the same as the password after the change, and if it is the same, you will not be able to register it. (However, if "Minimum Password Length" is 0, this setting cannot be used.)

Factory default settings: Disable

Delete Users who Have not Logged in for a Specified Period of Time

Deletes users who have not logged in to the machine for the specified period from the machine's user list.

Counting the days

- If the user logs in before this setting is enabled, the number of days will be counted from the day after the setting is registered.
- If the user logs in after this setting is enabled, the number of days will be counted from the day after the last login.
- If a new user is registered after this setting is enabled, the number of days will be counted from the day after the user's registration date.
- Users imported via storage backup will be counted from the day after import.

Factory default settings: Disable

Delete timing

- Users will be deleted at the time the date changes (0:00) after the specified period has passed.
- If the machine is in energy saving mode or turned off, the user will be deleted when the machine is restored or turned on.
- If the number of days for this setting is shortened, the corresponding user will be deleted after the setting is registered.



- Users who are set as fixed users are excluded from this setting.
- If you enable this setting and then change the setting to disable it, the days count will be reset.

Factory default settings: Disable, Period:365



Prohibit Reuse of Deleted User's Account Name

Prohibits the reregistration of user accounts (login names) once they have been deleted. This setting can be used to prohibit reregistration for a certain period of time or for no period of time.

After enabling the setting, set the period of time to prohibit reregistration. If you select "Undefined", you can prohibit reregistration without setting a period.

If [Case sensitivity of login name is enabled.] is enabled in the authentication settings, it will be judged case sensitive. If it is disabled, it will be judged without distinguishing case.

Example: Deleted login name: ABC, login name to be registered: Abc

If [Case sensitivity of login name is enabled.] is enabled in the authentication settings, the login name Abc can be registered because bc is in lower case. If it is disabled, Abc cannot be registered.

Factory default settings: Disable, Period:365



- The login names of user accounts that have been deleted since the time this setting was enabled are recorded in the list, up to a maximum of 2000. When the number of user accounts exceeds 2000, the login names of the oldest user accounts will be deleted.
- When this setting is enabled and then disabled, the login name record of the deleted user account will be erased.
- The login names of user accounts that are deleted when this setting is disabled will not be recorded.
- The day of deletion is the first day, and the login names of user accounts that have exceeded the set period will be removed from the list.
- The login names of user accounts deleted by [Delete All Users] in the user list will not be recorded in the list and will not be subject to this setting.

Password Change

Restrict Device Web Page Access Via Password

Use this setting to display the login screen and require login in order to access the Web server.

Change Password

The administrator password can be changed.

When you change the password, be sure to remember the new password.

(It is recommended that you periodically change the administrator password.)

- Enter a password consisting of 5 to 255 characters, and tap the [Store] key. Your setting is made valid only when the machine is turned On again.

The user-level authentication password is required to add, edit or delete the destination. When you log on, enter "users" as the user name. Then, enter the user password that you have registered with this option.

The administrator-level authentication password is required to select all settings and the same functions as those available with the user-level password. When you log on, enter "admin" as the user name. Then, enter the administrator password that you have registered with this option.

- If you tap the [Store] key without entering a password, the previously set value is assumed. Password protection is enabled by default.



In the factory default state, the user password must be entered.
(For the default administrator password, see Start Guide.)



Condition Settings

Restrict Print Jobs other than the current Print Hold Job

You can select settings to cancel print jobs that are not print hold jobs, or force all print jobs to be held. When [Restrict Print Jobs other than the current Print Hold Job] is turned ON, the settings below can be selected.

Item	Description
Force Retention	This setting forcibly sets all print jobs as print hold jobs, even jobs for which print hold is not selected.
Disable Job	Prohibit all print jobs other than print hold jobs.

Factory default settings: Force Retention

Automatic Deletion of Suspended Print Jobs

If the job is interrupted due to a paper jam, etc., the job is automatically deleted after the time set in "Time until automatic deletion" has elapsed.

Factory default settings: Disable

Time until Suspended Print Jobs are Automatically Deleted

Set the time after stopping a job to automatically deleting the job.

Factory default settings: 5 minutes

Reject Requests from External Sites

You can reject the request from external sites.

Factory default settings: Enabled

If Firmware Corruption is Detected, Restore It

When the machine starts up, the firmware is inspected, and if any damage is found, it automatically recovers to the state before the damage.

Factory default settings: Disable

Apply Security Policy

The default administrator is displayed at login. Set whether to apply the security policy on this machine.

Factory default settings: Disable

Mandatory Access Control

Set whether to perform forced access control. Once set, access to all files inside the machine will be forcibly controlled.

Factory default settings: Disable

Job Status Jobs Completed List Display Setting

Set to show/hide the completion screen of the job status screen.

Factory default settings: All disable

Job Status Display Setting

Sets the contents to be displayed in the job status. For printing, you can choose to show or hide the file name. For image send, the destination can be shown or hidden.

Factory default settings: All disable



Port Control

For the various major ports used in the system, set the prohibition/permission and port number, and tap the [Register] key.

The ports that can be set are as follows.

Server Port	Factory default settings		Client Port	Factory default settings	
	Port Control	Enable/Disable		Port Control	Enable/Disable
HTTP	80	Enabled	HTTP		Enabled
HTTPS	443	Enabled	HTTPS		Enabled
FTP Print	21	Enabled	FTP		Enabled
Raw Print	9100	Enabled	FTPS		Enabled
LPD	515	Enabled	SMTP		Enabled
IPP	631	Enabled	SMTP-SSL/TLS		Enabled
IPP-SSL/TLS	443	Disabled	POP3		Enabled
Tandem Output Receive	50001	Enabled	POP3-SSL/TLS		Enabled
PC Scan	52000	Enabled	SNMP-TRAP	162	Enabled
Remote Operation Panel	5900	Enabled	Notify Job End		Enabled
SNMPD	161	Enabled	LDAP		Enabled
SMB		Disable	LDAP-SSL/TLS		Enabled
SMTP		Enabled	SMB		Enabled
WSD		Enabled	SNTP		Enabled
Print Release	53000	Enabled	mDNS		Enabled
Sharp OSA (Expansion Platform)			Tandem Output Send		Enabled
• HTTP	10080	Enabled	Data Backup (Send)		Enabled
• HTTPS	1443	Enabled	Print Release		Enabled
			IPP INFRA		Enabled
			syslog	514	Enabled
			syslog-SSL/TLS	6514	Enabled

Filter Setting

You can set the filter by an IP or MAC address to prevent an unauthorised access to the machine via a network.

Set the IP or MAC address filter and tap the [Store] key.

Factory default settings: Disable

IP Address Filter Settings

This option sets an IP address.

You can specify whether to allow or prohibit access to the machine from the IP address you set.

Factory default settings: Enable



MAC Address Filter Settings

This option sets a MAC address.
It allows access to the machine from the MAC address you set.

Intrusion/Attack Detection

This section explains how to protect the machine by partially blocking communications with an attempt to attack the machine via network.
If the multifunction device receives more than the set number of communications from the same IP address within the set period, communication from that IP address is prohibited.
IP addresses whose communication is prohibited are recorded in the audit log and registered as a reception refusal list. In addition, those IP addresses are notified by e-mail to the addresses in the e-mail alert message list 1/2 and dealer e-mail alert message list.
The removal of the IP address from the rejection list is also recorded in the audit log.
The maximum number of IP addresses that can be registered in the reception rejection list is 100, and when the number reaches 100, external connection requests for multifunction devices will not be accepted.

Factory default settings: Disable



- Even if the power is turned on/off, the intrusion/attack detection settings and reception refusal list are retained. When you execute [Reset the NIC] or [Factory Reset], the intrusion / attack detection settings and reception rejection list are initialized.
- When you want to send e-mail to the E-mail alert address list or E-mail alert dealer address list, enable [Security Alert] in [E-mail Alert].

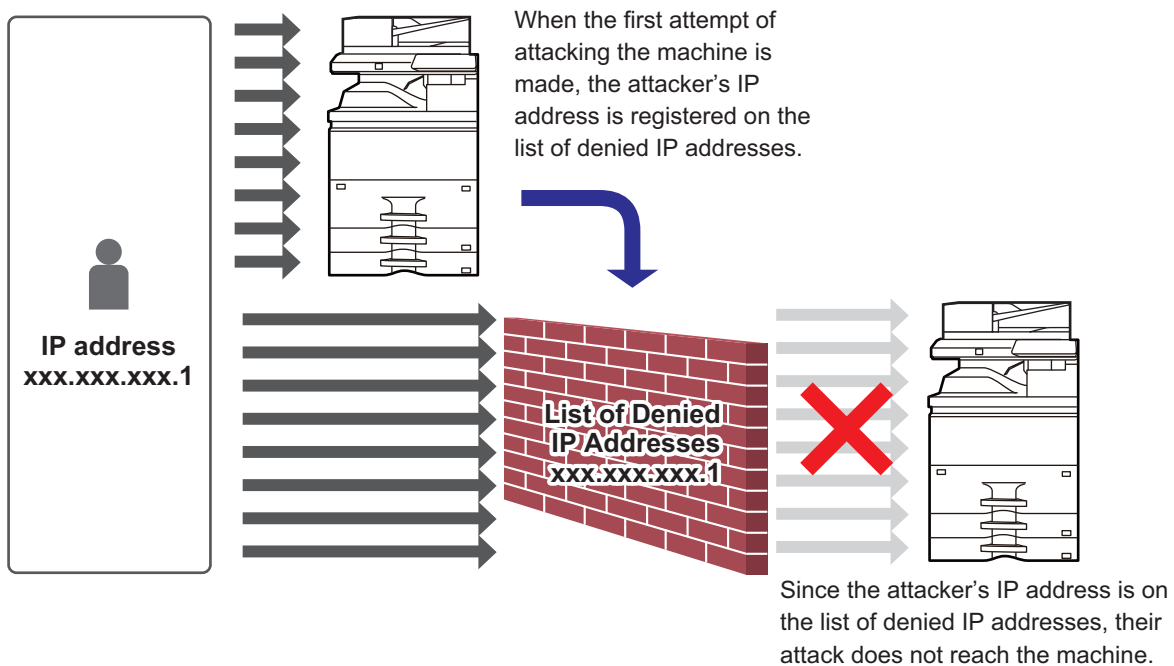



List of Denied IP Addresses

Item	Description
IP Address	Displays the IP address that is rejected. The default setting is "OFF".
Start Time of Incoming Packet Denials	Displays the date and time when reception refusal started.
Total	Displays the number registered in the reception rejection list. Factory default settings: Allow

Virus Scan Setting

This setting is available when the virus detection kit is installed. Specifies the settings for virus detection.



When you open the Virus Scan Setting for the first time, or when you go to the Virus Scan Setting if you have not agreed to the software license agreement when you opened it before, the software license agreement screen will appear. Check the contents, and if you have no problems using the software, select [Agree].

Virus Scan

Specifies whether to use the virus scan function.

Factory default settings: Disable

Virus Scan Settings

Perform Virus Scan on Input-Output Data

When the input/output data of the machine is generated, the corresponding data is scanned for viruses.

Factory default settings: Disable

Perform Virus Scan at Specified Time

Scans for viruses at the specified date and time.

Factory default settings: Disable

Perform Virus Scan Now

Perform this setting when you want to scan for viruses immediately.

Time Schedule

Specifies the schedule for virus scan.

Every Day

When this setting is enabled, a daily virus scan will be performed.

(Start time)

Sets the time to start scanning.

Factory default settings: 12:00

Every Week

When this setting is enabled, a virus scan will be performed every week on the specified day and time.

(Days of the week)

Sets the day of the week to start scanning.

Factory default settings: Monday

(Start time)

Sets the time to start scanning.

Factory default settings: 12:00



Every Month

When this setting is enabled, virus scan will be performed on the specified day and time.

(Date)

Sets the date when the scan will start.

For months that have days that do not exist (for example, February and April when 31 is set), run at the end of the month.

Factory default settings: 1

(Start time)

Sets the time to start scanning.

Factory default settings: 12:00



When the machine is not turned on at the date and time specified in the "Time Schedule", the following operation is performed.

- Even when the Audit Log is enabled, virus scan failures are not recorded.
- When you set "Every Day", the virus scan will not be performed until the same time the next day.
- When you set "Every Week" or "Every Month", the virus scan is performed after the first start up of the machine after the time when the virus scan was not performed. Even if there are multiple times the opportunity to perform the virus scan during a period of time when the machine is not turned on, the virus scan will only be performed once after the machine is started up.

Virus Scan Target

Select the data to be scanned for viruses.

- System File (Firmware)
- Embedded Application
- NAS Stored Data

Factory default settings: All enabled

Virus Definition File Update Setting

Perform Update Now

Perform this setting when you want to update the virus scan definition files immediately



SSL/TLS Settings

SSL/TLS can be used for data transmission over a network.

SSL is a protocol that enables the encryption of information communicated over a network. Encrypting data makes it possible to transmit and receive sensitive information safely.

Data encryption can be set by the following protocols.

Setting of SSL/TLS

Server Port

- HTTPS: Apply SSL encryption to HTTP communication.

Factory default settings: Enable

- IPP-SSL: Apply SSL encryption to IPP communication.

Factory default settings: Disable

- Redirect HTTP to HTTPS in Device Web Page Access: When this setting is enabled, all communication that attempts to access the machine by HTTP is redirected to HTTPS.

Factory default settings: Disable

Client Port

- HTTPS: Apply SSL encryption to HTTP communication.

Factory default settings: Enable

- FTPS: Apply FTP encryption to HTTP communication.

Factory default settings: Enable

- SMTP-SSL/TLS: Apply SMTP encryption to HTTP communication.

Factory default settings: Enable

- POP3-SSL/TLS: Apply SSL/TLS encryption to communication using POP3.

Factory default settings: Enable

- LDAP-SSL/TLS: Apply SSL/TLS encryption to communication using LDAP.

Factory default settings: Enable

- syslog-SSL/TLS: Apply SSL/TLS encryption when sending audit logs.

Factory default settings: Enable

- Verify Signature of Server Certificate of the Other Party: Validate the certificate of the server you are communicating with.

Factory default settings: Disable

- Use only TLS1.2: Use only TLS1.2.

Factory default settings: Enable

- Use only TLS1.3: Use only TLS1.3.

Factory default settings: Enable

Level of Encryption

The encryption strength can be set to one of three levels.

Factory default settings: Low



Device Certificate

Certificate Status

Displays the status of the certificate required for SSL/TLS communication. Click the [Select] key to install the certificate.

Certificate Information

If the device certificate is installed, click the [Show] key to display the certificate information.

Select Device Certificate

Click the [Select] key to display the device certificates that have already been registered. Select from them.

S/MIME Settings

S/MIME Settings

Sets whether or not to use S/MIME for scan to E-mail.

Factory default settings: Disable

Device Certificate

Certificate Status

Shows the status of the certificate required for sending using S/MIME. If you want to install the certificate, click the [Select] key.

Sign Settings

Sign E-mail

Enable "Sign E-mail" to use a signature.

Factory default settings: Always Enable

Signature Algorithm

Set the algorithm for the signature.

Factory default settings: SHA-1

Setting of Encrypt

Encry.

Sets the use of encryption.

Factory default settings: Always Enable

Encrypt

Select the method to be used for encryption.

Factory default settings: AES-128

Disable sending to the addresses which cannot be encrypted.

Prohibit transmission to addresses that cannot be encrypted.

Factory default settings: Enable

Certificate Information

If the device certificate is installed, click the [Show] key to display the certificate information.

Select Device Certificate

Click the [Select] key to display the device certificates that have already been registered. Select from them.



This setting can only be set on web pages.



IPsec Settings

IPsec can be used for data transmission/reception on a network.

When IPsec is used, data can be sent and received safely without the need to configure settings for IP packet encryption in a Web browser or other higher-level application.

When enabling this settings, take the following notes.

- It may take some time to reflect on the machine settings, and you cannot connect to the machine during this time.
- If the Setting mode (Web version) settings are not correctly selected, connection to the machine may not be allowed, or the settings may not allow printing, scanning, or Setting mode (Web version) display. In this case, deselect this setting and change the System Settings (on Web pages).

Condition Settings

IPsec Settings

Sets whether to use IPsec for transmission.

Factory default settings: Disable

IKEv1 Settings

Pre-Shared Key

Enter the Pre-Shared Key to be used for IKEv1.

SA Lifetime (time)

Set the SA lifetime.

Factory default settings: 28800 seconds

SA Lifetime (size)

Set the SA lifetime size.

Factory default settings: 28800 KB

IKE Lifetime

Set the IKE lifetime.

Factory default settings: 30 seconds

IPsec Rules

The registered IPsec rules are displayed.

To add a new rule, click the [Add] key.

To delete a rule, select the rule you want to delete and click the [Delete] key.

IPsec Rule Registration

Rule Name

Enter a name for the IPsec rule.

Priority

Set the priority level.

Factory default settings: 1

Select the Rule Name to be the Registration Model

If there is a previously registered rule that is similar to the rule you want to create, you can create the new rule based on the registered rule.

Device Address

Set the type of IP address to be used on the machine and the port number (for IPv6, set the port number / prefix length).

Client Address

Set the destination IP address type and port number (for IPv6, set the port number / prefix length).



Protocol

Set the protocol to be used.

Factory default settings: TCP

Filter Mode

Configure settings for the authentication method used for IPsec.

Factory default settings: IPsec

IPsec Encryption

Configure settings for the authentication method used for IPsec.

ESP

Select to use ESP authentication.

Factory default settings: Enable

Allow Communication not using ESP

Specify whether or not communication that does not use ESP is allowed.

Factory default settings: Enable

AH

Select to use AH authentication.

Factory default settings: Disable

Allow Communication not using AH

Specify whether or not communication that does not use AH is allowed.

Factory default settings: Disable



Document Administration Function

All of the transmitted image data (sent or received by facsimile or e-mail transfer) can be forwarded to any destination.

List name	Settings
Forwarding Destination Settings (Send Data)	
Forward Send Data	Set a destination to forward the send data. Factory default settings: Disable
E-mail/Network Folder/FTP/Desktop	Select a forwarding type of the send or received image data. When determined, select the destination from the address book. You can enter an e-mail directly. • Format: Select the file format for inbound routing.
Release Settings	Releases the destination settings.
File format	Select the file format for inbound routing.
Forwarding Destination Settings (Received Data)	
Forward Received Data	Set a destination to forward the received data. Factory default settings: Disable
E-mail/Network Folder/FTP/Desktop	Select a forwarding type of the send or received image data. When determined, select the destination from the address book. You can enter an e-mail directly. • File Format: Select the file format for inbound routing.
Release Settings	Releases the destination settings.
File format	Select the file format for inbound routing. Factory default settings: TIFF(Multi)



Even if using the scanner function "[AUTOMATICALLY ADJUST SKEWED SCAN DATA \(Original Skew Adjustment\)](#) (page [6-142](#))", correction results will not be reflected.



Hidden Pattern Print Setting

Select Hidden Pattern Print Setting.

The hidden pattern print function is effective at preventing unauthorized copying as the specified text emerges in the background on output sheets.

Initial Status Settings

Default Settings

Item	Description
Hidden Pattern Print Setting	A pattern print can be printed with this settings. Factory default settings: All Invalid
Exposure	Select an exposure. Factory default settings: Standard
Font Size	Select a font size. Factory default settings: 48point
Angle	Select a character angle. Factory default settings: 0°
Font Style	Select the standard or italic character settings. Factory default settings: Standard
Camouflage Pattern	Set a camouflage pattern. Factory default settings: Pattern 1
Print Method	Select a character display pattern. <ul style="list-style-type: none"> • Character stand out. • The background stands out. Factory default settings: Positive

Print Contents Setting

Item	Description
Standard Characters	Allows you to select a preset character string. The following character strings can be selected. <ul style="list-style-type: none"> • DO NOT COPY, Copy Ban, Internal Use Only, Handle With Care, CONFIDENTIAL, Copy Invalid, IMPORTANT, COPY Factory default settings: Enable, Copier
Pre-set Text	Select a stored preset character string. This setting is ignored if [Direct Entry] is enabled. <ul style="list-style-type: none"> • DO NOT COPY, Copy Ban, Internal Use Only, Handle With Care, CONFIDENTIAL, Copy Invalid, IMPORTANT, COPY
Information Printing	Enables simultaneous printing of the following information sets. <ul style="list-style-type: none"> • Serial number, account job ID, login name/user number, number of copy control, date and time Factory default settings: All Invalid
Disable Direct Entry	Set whether to enable direct input of print characters for tint block printing in each mode. Factory default settings: Disable

Contrast

Set a character contrast.

The black can be set in any of 9 levels.

Factory default settings: 5



Custom Text Registration

Stores the user-created print characters. Up to 30 characters can be stored.

Tracking Information Print

Prints the tracking information at the top or bottom of output pages when copy or print job is executed. This function forcibly prints the pre-specified traceable information to prevent an unauthorized copy.

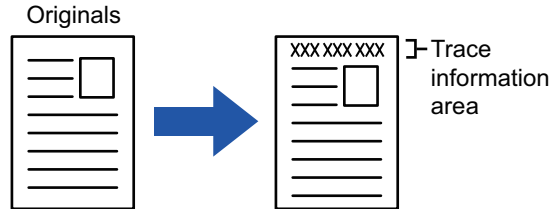

Item	Description
Print tracking information settings	Set this option to print the tracking information. Factory default settings: Disable
Print Data	The following information can be printed. • Serial number, characters, account job ID, login name/user number, date and time Factory default settings: Serial number:Enable, Text:Disable, Account Job ID:Enable, Login Name/User Number:Enable, Date/Time:Enable
Print Position	Set a print position on each page. Factory default settings: Print Upper Side of Paper:Disable, Print Lower Side of Paper:Enable, Print Left Side of Paper:Enable, Print Right Side of Paper:Disable, Position Adjustment:1(Outer)
Font Size	Set the size of the characters to be printed. Factory default settings: Middle
Select the Job to Print	Set a job to print the tracking information. Factory default settings: All Enabled



- If this function is specified together with another image compositing function, tracking information is printed at the top.
- The information added at printing or the preview image of the account job ID and date/time are displayed as shown below.
Account job ID: 00000
Date/time: MM/DD/YYYY hh:mm



Audit Log

Logs are created and saved for various events relating to security functions and settings.

Audit logs are created and saved in English. However, setting values such as filenames which are input from external sources are saved as-is.

Audit logs which have been saved in the internal storage can be exported by an administrator to a PC as TSV files.

You can select either the internal storage or an external server as the destination for saving audit logs.



When the space for saving audit logs internally becomes full, the logs are overwritten starting from the oldest ones.

Audit Log

"Audit Log" can be carried out as follows.

In "Settings (administrator)", select [System Settings] → [Security Settings] → [Audit Log]

Select "Security Control", "Storage/Send Settings" or "Save/Delete Audit Log".

Factory default settings: Disable

Storage/Send Settings

"Storage/Send Settings" can be carried as follows.

In "Settings (administrator)", select [System Settings] → [Security Settings] → [Audit Log] → [Storage/Send Settings]

Then make the storage and transmission settings.

Factory default settings: Local Drive Store:Enable, Server Send:Disable, Enable SSL/TLS:Disable, Port Number:514, Port Number (Use SSL/TLS):6514

Save/Delete Audit Log

"Save/Delete Audit Log" can be carried out as follows.

In "Settings (administrator)", select [System Settings] → [Security Settings] → [Audit Log] → [Save/Delete Audit Log]

Select "Save Audit Log" or "Delete Audit Log".



- "Save Audit Log" can only be carried out from the web page.
- If you have set a high level of security, it will not be displayed if audit logging is disabled or storage storage is disabled.

Audit Log specifications

If the audit log is saved to an external server, the audit log is temporarily saved in the buffer area reserved in the internal storage until the transmission to the external server is successful.

- Audit logs that are successfully sent to the external server are cleared from the buffer area.
- If the transmission to the external server fails, a warning message will be displayed on the operation panel and the screen of the web page, and the transmission will be periodically retransmitted to the external server until the transmission is successful.

The audit events and information stored in the audit log are as shown in the following table.



If the power of this machine is turned off by a method other than the procedure described in the user's manual or due to a power failure, the [End Audit] event may not be recorded. Make sure to turn off the power of this machine according to the correct procedure. We also recommend using an uninterruptible power supply (UPS) in the event of an unforeseen event such as a power outage.



Event name	Date & Time* ¹	Operation I/F* ²	Login Name	Result* ³	Additional Information
Audit Start	Yes	N/A	N/A	Yes	Reasons for starting Normal start-up: main power on, panel SW pressed, reboot, timer, fax, network, waste paper tray fax paper removal, other Other: security erase
Audit End	Yes	N/A	N/A	Yes	N/A
Job Completion	Yes	Yes	Job owner (SYSTEM)	Yes	Finished job name
I&A Success	Yes	Yes	The string entered as your login name	N/A	IP address of the login source 127.0.0.1 for the operation panel
I&A Failure	Yes	Yes	The string entered as the login name	N/A	IP address of the login source 127.0.0.1 for the operation panel
Add User	Yes	Yes	User who added	Yes	Added login name
Login Terminated	Yes	Yes	The string entered as your login name	N/A	Active termination/ Timeout
Change Password	Yes	Yes	The user who made the change	Yes	Login name of the user whose password has been changed
Change Login Name	Yes	Yes	The user who made the change	Yes	Login name after change
Delete user	Yes	Yes	User who deleted	Yes	Deleted login name (ALL if all users are deleted)
Add Auth Group	Yes	Yes	User who added	Yes	Added authority group name
Change Role	Yes	Yes	The user who made the change	Yes	<ul style="list-style-type: none"> • Login name of the user whose authority group has been changed • Changed authority group name
Change Auth Group Setting	Yes	Yes	The user who made the change	Yes	Privilege changed settings Group Name
Add Page Limit Group	Yes	Yes	Users with additional functions	Yes	Name of the additional page limit group
Delete Page Limit Group	Yes	Yes	Users whose functions are deleted	Yes	Name of the deleted page limit group
Change Page Limit Group Setting	Yes	Yes	Users who have changed the settings	Yes	Name of the changed page limit group
Change Time Setting	Yes	Yes	The user who made the change	Yes	N/A
Change Setting	Yes	Yes	User who made the change ("ByPolicy" when applying AD policy)	Yes	<ul style="list-style-type: none"> • Setting items whose setting values have been changed • Set value after change
Firm Recovery	Yes	N/A	N/A	Yes	<ul style="list-style-type: none"> • Firmware name • Firmware version after recovery



Event name	Date & Time* ¹	Operation I/F* ²	Login Name	Result* ³	Additional Information
Exec Rejection	Yes	N/A	N/A	Yes	Distinguished name of firmware or embedded OSA app
TLS, IPsec communication failure (Comm Failure) * Communication partner is other than the audit server	Yes	N/A	Users who are communicating	N/A	<ul style="list-style-type: none"> • IP address of the communication starter • IP address of the communication partner • Communication direction • Reason for failure
Modify AddrBook	Yes	Yes	User who updated	Yes	<ul style="list-style-type: none"> • At the time of addition: Internal management ID and destination name of the added entry • When deleting / changing: Internal management ID of deleted / changed entry
Firm Update	Yes	Yes	User who updated	Yes	<ul style="list-style-type: none"> • Firmware name • Firmware version before update • Firmware version after update
Intrusion/Attack Detected	Yes	N/A	N/A	Yes	<ul style="list-style-type: none"> • IP addresses that have been blocked • When the maximum number of detections is reached, "reaches limit" is added.
Release Denied Addr	Yes	Yes	Users who have been released	Yes	Released IP address
Invoke EAM App	Yes	N/A	N/A	Yes	Starting Sharp OSA External Accounts Application Additional Information: IP Address and Application Name of Sharp OSA External Account Server
CSRF Trial	Yes	Net	N/A	N/A	Attacking IP address
Enabling Embedded OSA Applications	Yes	Yes (N/A for firmware updates)	Users who have activated the function (default administrator for installation and update via Application Portal, system for firmware update) for installation and update from Application Portal, "system" for firmware update)	Yes	<ul style="list-style-type: none"> • Application name • Connection details (IP address where the activation operation was performed) (127.0.0.1 for the operation panel))
Send External Dest	Yes	Yes	Users who sent	Yes	Destination e-mail address/IP address/SMB folder path
Web Push Print	Yes	Yes	Users of the function	Yes	IP address from which the file was downloaded
Change Service Setting	Yes	Yes	Users who have changed the settings	Yes	Changed settings and their values



Event name	Date & Time* ¹	Operation I/F* ²	Login Name	Result* ³	Additional Information
Switch to service mode	Yes	Yes	Service	Yes	N/A
Running in service mode	Yes	Yes	Service	Yes	Changed setting values
Sharp OSA external account user authentication	Yes	Yes	The string entered as your login name	Yes	N/A
Scheduled Virus Scan	Yes	N/A	N/A	Success / Failure	In case of failure, the reason <ul style="list-style-type: none"> • Interruption of running scan due to power off Interruption of the scan • Any other reason Interruption of a running scan due to other than the above • Scan failure due to errors other than the above
On-demand Virus Scan	Yes	Ope/Web	Users who requested the scan to be performed	Success / Failure	In case of failure, the reason <ul style="list-style-type: none"> • Interruption of running scan due to power off Interruption of the scan • Any other reason Interruption of a running scan due to other than the above • Scan failure due to errors other than the above
Virus Detection	Yes	N/A	N/A	Always "Success"	One of the following <ul style="list-style-type: none"> • Firmware • Inbound data • Outbound data • Stored data • OSA app Data identification name (file name, etc., if obtainable. N/A if not possible) Identification name of the virus
Auto Pattern Update	Yes	N/A	N/A	Success / Failure	In case of failure, the reason <ul style="list-style-type: none"> • Connection error to the server • Failed to download the pattern file • Incorrect system setting time • Scan failure due to errors other than the above
On-demand Pattern Update	Yes	Ope/Web	Users who requested the implementation of the update	Success / Failure	In case of failure, the reason <ul style="list-style-type: none"> • Connection error to the server • Failed to download the pattern file • Incorrect system setting time • Scan failure due to errors other than the above
Change Setting	Yes	Yes	Users who have changed the setting values	Success / Failure	Setting items and values for Web page (Virus Scan Setting)

* 1 The date and time when the event occurred is displayed in the extended format of ISO 8601.

* 2 Either Ope/Web/sNet is displayed as the operation interface. However, if it is "N / A" in the table, it will be written as "N / A".

* 3 Either Success / Failure will be displayed as the result of the event.



Certificate Management

Device Certificate Management

Import

Import the certificate/private key.



This setting can only be set on web pages.

Export

Export the certificate/private key.



This setting can only be set on web pages.

Certificate Information

Shows the status of the certificate.

Creation of Certificate and Private Key



This setting can only be set on web pages.

Common Name (Required)

Enter the name to be used.

Organization

Enter the name of the organization.

Organizational Unit

Enter the name of the unit within the organization.

City/Locality

Enter the city or locality.

State/Province

Enter the state or province.

Country/Region (Required)

Enter the country code.

Sender Address

Enter the sender's E-mail address.

Certificate Start Date

Enter the start date and time for the certificate.

Certificate Validity Period

Enter the expiration date of the certificate.

Certificate Information

Enter the Certificate Information.



Certificate Signing Request (CSR) Management

Install

Install the certificate.

Certificate Information

Shows the status of the certificate.

Make of Certificate Signing Request(CSR)

Common Name (Required)

Enter the name to be used.

Organization

Enter the name of the organization.

Organizational Unit

Enter the name of the unit within the organization.

City/Locality

Enter the city or locality.

State/Province

Enter the state or province.

Country/Region (Required)

Enter the country code.

Sender Address

Enter the sender's E-mail address.

Certificate Start Date

Enter the start date and time for the certificate.

Certificate Validity Period

Enter the expiration date of the certificate.

Certificate Information

Enter the Certificate Information.

CA Certificate Management

Import

Import the certificate.

Certificate Information

Shows the status of the certificate.



Energy Save

Eco Setting

The machine's power consumption can be reduced by Eco Mode setting. Although each function setting can be changed separately, the machine has the "Custom" and "Eco Mode" to allow simultaneous changing of settings.

Eco Recommendation Function

You can display eco-recommended functions such as two-sided printing and N-Up during copying, document filing print, and direct print.

Setting values applied by each mode is as follows.

Energy Save	Custom Mode	Eco Mode
Preheat Mode Setting	1 minutes	1 minutes
Turn off Panel Display during pre-heat mode	On	On
Auto Power Shut-Off Timer	Fix transition time.: 15min.	Fix transition time.: 1min.
As soon as the remote job is finished, enter Auto power shut off mode.	On	On
Sleep Mode Power Level	Low Power	Low Power
Eco Scan Setting	On	On (All Modes Except Copy)

Factory default settings: Disable



Each Energy Save settings in System Settings is not applied when Custom/Eco mode is used.

Display a Message to Delay the Time of Entry into Preheat Mode / Auto Power Shut-Off Mode

Set whether a message is displayed 15 seconds before Preheat Mode or Auto Power Shut-off Mode is entered.

Factory default settings: Disable

Mode Setting

This function allows you to set the Eco function at once. There are "Custom Mode" and "Eco Mode".

Item	Description
Custom Mode	Allows easy machine operation with reduced power consumption.
Eco Mode	Minimizes the machine's power consumption.



Preheat Mode Setting

The time until the preheating mode works is 1 to 120 minutes in 1-minute units.

Preheat Mode will activate when the set duration of time elapses after printing ends and no further operations are performed. This function reduces your power costs, and at the same time helps conserve natural resources and reduce pollution.

Select the time that best suits the needs of your workplace.

The panel display can be turned Off in the Preheat mode.

Factory default settings: 1 minutes



Preheat mode cannot be disabled.

Turn off Panel Display during pre-heat mode

Set whether the lights on the operation panel turn off in preheat mode.

Factory default settings: Enable

As soon as the remote job is finished, enter Auto power shut off mode.

This function works in Auto Power Shut-Off mode. When the machine completes a print job received from the PC or outputs received fax data, the machine immediately returns to the Auto Power Shut-Off mode.

Factory default settings: Enable

Fix transition time.

The Auto Power-Off transition time is fixed. Select [Fix transition time.], and set the transition time in [Auto Power Shut-Off Timer].

When this setting is enabled, the [Change transition time by time of day.] option is disabled.

Factory default settings: Enable, Auto Power Shut-Off Timer: 15minutes



Change transition time by time of day.

This function controls the transition to Auto Power Shut-Off mode optimally for each time period by analyzing the use of the machine based on job logs obtained during a 4-week period.

When this setting is enabled, the [Fix transition time.] option is disabled.

Factory default settings: Disable



- The image transfer control settings are not changed.
- This does not link to the Power On/Off Scheduling. If both of them are enabled, the Power On/Off Scheduling settings precede.
- Pages are counted for each paper size separately.
- When the power supply of the machine was off, there was no job during this time.

Transition to Energy Saving and Auto Power Shut-Off modes

Pattern	Transition time	Average outputs per hour*
Mode1 (Job Start Priority1)	After 1 hour	1000 or more
Mode2 (Job Start Priority2)	After 30 minutes	250 to 999
Mode3 (Energy Saving Priority1)	After 5 minutes	60 to 249
Mode4 (Energy Saving Priority2)	After the minimum time period	0 to 59

* Factory default setting

Auto

This function controls the power optimally for each time period by analyzing the use of machine based on job logs obtained during a certain time period.



If the machine does not have the 4-week job log information, the machine enters the template2 (Mode3 (Energy Saving Priority1) between 8:00 and 18:00 hours). Then after that, it enters Mode4 (Energy Saving Priority2).



Manual

You can set a pattern for each time band.

The machine already has the 3-pattern template. The Energy Save pattern can be added to the "Original Eco Patterns 1 to 4".

Three-pattern template

Template	Pattern	Description of mode
Template 1	All "Energy Save Priority 2"	The machine runs in the "Mode4 (Energy Saving Priority2)" all the time.
Template 2	8:00-18:00 "Energy Save Priority 1"	The machine runs in "Mode3 (Energy Saving Priority1)" between 8:00 and 18:00, and in "Mode4 (Energy Saving Priority2)" at other times.
Template 3	8:00-18:00 "Job Start Priority 1"	The machine runs in "Mode1 (Job Start Priority1)" between 8:00 and 18:00, and in "Mode4 (Energy Saving Priority2)" at other times.

Sleep Mode Power Level

Low Power :The machine switches to the power saving mode, but it takes some time to recover.

Fast Wake Up :Compared with Low Power, the power value rises by a certain degree, but it results in faster recovery.

Motion Sensor Mode: This enables switching of power saving modes by the motion sensor.

Factory default settings: Low Power

Eco Scan Setting

This setting keeps the fusing unit off when you perform an operation that does not involve printing, such as sending a scanned document.

Set "Eco Scan Setting" to , and select a mode or screen in which to enable Eco Scan Setting.

The following modes and screens can be set.

- Home Screen
- Copier
- Image Send
- Document Filing
- System Settings
- SharpOSA

Factory default settings: Enable, Home Screen:Disable, Copy:Disable, Image Send:All Enabled, Document Filing:All Enabled, System Settings:Enable, Sharp OSA:All Enabled



Energy Saving Pattern List

This function analyzes machine usage and controls entry into auto power shut-off mode based on frequency of use. If you want to manage machine power by using an energy saving pattern list, select [Manual] in [System Settings] - [Eco Setting] - [Change transition time by time of day.], and select an Automatic Update Pattern from the pull-down list or one of Original Eco Patterns 1 to 4.

To automatically analyze machine usage and update the pattern as needed, set Automatic Update Pattern.

Edit Pattern

Set the Original Eco Pattern.

Item	Description
Change Pattern Name	To change the pattern name, enter the desired name.
Pattern to Be Modeled	Select the stored pattern that you want to base the new pattern on. To copy the settings of a selected pattern, select [Copy the selected pattern.].
Energy Save	Set time periods for machine modes. Select a mode from 1 to 4, and select a day of the week, start time, and end time.
Day of the Week	Set the day of week on which you want to enable the mode selected in the Energy Save Setting.
Start Time/Completing Time	Set the period of time during which you want to enable the mode selected in the Energy Save Setting.



Specific Date Operation Settings

You can configure a day on which you have high-output printing or want to perform a special operation as the "specific date" and set a specific energy saving pattern only for that specific date.



The specific date operation is performed on the day configured as the specific date regardless of the setting on Auto Power-Off transition time (enabled or disabled).

"Specific Date" tab

A period of up to 7 days can be set for Specific Date. Set the specific date, energy saving pattern to be applied, and the operation that takes place if the specific date falls on a non-work day.

Item	Description
Date	Configure the date on which you want to operate the machine with a specific pattern. Select a day between 1 and 31 in Every Month or from End of Every Month.
Applied Energy Saving Operation	Select an energy saving pattern you want to apply. Use the "Pattern" tab (page 10-207) to specify the details of the energy saving pattern.
Operation for Holiday	Configure how the machine operates if the preset specific date falls on a holiday. Use the "Holiday" tab (page 10-207) to specify the day as the holiday.



- If a specific date that is initially specified coincides with the one that is moved because it falls on a holiday, the setting for the former takes precedence.
- If specific dates of the same dates are configured, they are used in ascending order between 1 and 7 (specific date numbers).

"Pattern" tab

This tab is used to configure the details of an energy saving pattern.

Item	Description
Energy Save Operation	Select a specific date pattern you want to specify.
Change Pattern Name	Enter a pattern name when you want to change the name of a specific date pattern.
Pattern to Be Modeled	Select a source pattern when you create a pattern using a stored or preset pattern.
Add new schedule.	Add a schedule.

"Holiday" tab

Specify a holiday. The day you specified as the holiday will not be a specific date.

Item	Description
Holiday List	When you tap this option, the dates and days of the week for the holidays you have set for two years.
Day of Week	Use this option to specify a holiday using a day of the week.
Set Period	Use this to specify a holiday using a date. "Final Registered Time" shows when the holiday that is stored with Set Period was stored.



Power ON/OFF Schedule Setting

The machine operator panel can be turned On or Off at a preset time. Up to three (3) patterns can be set. The "Setting 1", "Setting 2" and "Setting 3" are executed in this sequence if set at the same day of week or at the same clock time.



- The scheduling function does not support the power management settings in the Preheat Mode and Auto Power Shut-Off Mode.
- The preset power-off time is subject to the following restrictions:
 - If the machine is running due to the current job execution or other reasons, the machine is turned off only after the job has finished.
 - The machine cannot receive printer jobs.
 - The machine can receive output jobs, such as received fax data outputs.
 - If the Time Specified Output of Received Data setting is enabled, they are output next time the machine is turned on.
- If the power management setting is also enabled, the Power On/Off Scheduling settings precede.
- If the same time is specified, settings are applied in the order of "Setting 1", "Setting 2", and "Setting 3".
- The power is not turned off in the following cases:
 - "Automatic deletion when power is turned on" is in progress.
 - While the optimization of the local drive is in progress or while a restart is in progress after the setting mode has been changed.
- The preset power on/off time is within one minute from when the setting is accepted.

Toner Save Mode

This mode is used to reduce toner consumption.

Toner consumption can be set for each print job of "Copy", "Printer", and "Prints (Document Filing)".

Toner consumption can be selected from three levels.

- Toner save1 (Toner Consumption: Much)
- Toner save2 (Toner Consumption: Middle)
- Toner save3 (Toner Consumption: Little)

Factory default settings: All Invalid



System Control

Job Log

View Job Log

Views log of a job executed on the machine.

Select a view item and period, and tap the [Show] key.

Factory default settings: Job Log:All Enabled

Job log Operation

Deletes or stores log of a job executed on the machine.

Set the number of jobs for [The Number of Job Log to Notify by E-mail] and click [Store].

Tap the [Delete] key to delete the job log.

Factory default settings: The Number of Job Log to Notify by E-mail:50000



You can save the job log by selecting the [Job Log] in Setting mode (Web version).

Data Import/Export (CSV Format)

You can import or export data.

Export Settings

Type

Select the data to be exported from the address book or registered user information. Once you have selected the data, click the [Execute] key. The data will be exported in CSV format.

Factory default settings: Address Book:Enabled, User Register Information:Disabled

Import Settings

Import settings from file

You can import data that was exported in CSV format into the machine.



Storage Backup

Address book information and user information stored in the machine can be saved to and retrieved from a USB memory device.

To use the machine to manipulate a file, first insert the USB memory device in the machine. If you need to select settings on the Web page, use your computer to manipulate the file.

Export Settings

Exports data.

Factory default settings: All Invalid

Import Settings

Imports data into the machine.



When [Password Policy Settings] is enabled, the following user accounts are not targeted for import.

- User accounts that do not have a minimum password length.
- When [Enable Password Creation Rules] is enabled, user accounts that do not fully match this setting.
- User accounts that have been determined to be reregistration when [Prohibit Reuse of Deleted User's Account Name] is enabled.

Device Cloning

Saves the machine setting information in XML format and copies the information to another machine.

This function saves you the trouble of repeatedly configuring the same settings in multiple machines.

To use the machine to manipulate a file, first insert the USB memory device in the machine. If you need to select settings on the Web page, use your computer to manipulate the file.

Export Settings

Exports data.

Factory default settings: All Invalid

Import Settings

Imports data into the machine.



- For models that can be imported, please contact the store where you purchased the product.
- The following data is not copied when device cloning is performed:
 - List print and fax forwarding items.
 - Count and device status display items.
 - IP address of the machine, device name, administrator password, sender names for image send, and other information that is specific to the machine.
 - Adjustment values unique to each hardware, such as screen contrast/saddle stitch staple position adjustment

Forward Address Book

Forward the data stored in the address book of the machine to another machine.

To forward the address book contents, enter the IP address of the destination machine and the password of the administrator of that machine, and tap the [Execute] key.



Filing Data Backup

You can back up a file saved with Document Filing, and restore a backed up file to the machine.



Backup of filing data is operated in the setting mode (Web version).

Export Settings

Select the folder you want to back up and click [Execute]. The files are saved to your computer.

Item	Description
Index	The displayed Folder names can be filtered by index.
Display Items	Set the number of files that are displayed.

Import Settings

You can restore a file to the machine that was saved with "Export Settings". Enter a maximum of 200 characters for the path of the saved file in "Import settings from file", and click [Execute].

Reset Settings

Restore Factory Defaults

Restores the current settings (you have selected in Setting mode) to the factory default settings. If you wish to create a record of the current settings before restoring, print the current settings by selecting [Status] in "Settings (administrator)" → [Data List] → [List for Administrator].



When settings are changed, the changes will take effect after the machine is restarted. For details on restarting this machine, see "[TURNING ON THE POWER \(page 1-10\)](#)".

Reset the NIC

This returns all "Network Settings" to the factory default settings.



E-mail Alert and Status

Status Message

Selects the Standard E-mail Status function or Advanced E-mail Status function settings.

The E-mail Status function can periodically transmit the machine status information to the stored address.

Standard

Sets the E-mail status address list 1, E-mail status address list 2, and E-mail status dealer address list separately.

Item	Description
E-mail Address	Enter the destination e-mail address for transmission of machine status information. When you enter multiple addresses, separate them by a semicolon (;) or a comma (,).
Send Now	When tapped, the status message is sent to the destination of the e-mail address list.
Send on Schedule 1	If checked as <input checked="" type="checkbox"/> , an E-mail is sent periodically according to the preset schedule.
Send on Schedule 2	If checked as <input checked="" type="checkbox"/> , an E-mail is sent periodically according to the preset schedule.
Scheduling	Select a schedule to send E-mails.

Advanced Settings

Status Message by E-mail Request Setup

Item	Description
POP3 Server	Enter the IP address or host name of the POP3 server.
Port Number	Enter the port number of the POP3 server. Factory default settings: 110
Authentication Option	Specify the authentication method for POP. Select "OAuth 2.0" when using Microsoft365, Exchange Online, etc. For information on how to configure the settings when OAuth 2.0 is selected, see " OAuth 2.0 AUTHENTICATION (page 9-39) ". Factory default settings: Plain Text Authentication
Provider	This can be set when "OAuth 2.0" is selected as "Authentication Option". Select a provider. Factory default settings: Microsoft
Account Name	This can be set when "OAuth 2.0" is selected as "Authentication Option". Enter an account name.
Token	This can be set when "OAuth 2.0" is selected as "Authentication Option". Displays the current token status.
Get Token / Delete	The "Get Token" key is displayed if the token has not been obtained, and the "Delete" key is displayed if the token has been obtained. The "Get Token" key is displayed in the System Settings of the machine and is not displayed on the Web page.
User Name	This setting is available when you select "Authentication Option" other than "OAuth 2.0". Enter the user name. The special user account is required for bi-directional e-mail status transmission.
Password	This setting is available when you select "Authentication Option" other than "OAuth 2.0". Enter the password. To change the password, set [Change Password] to <input checked="" type="checkbox"/> .
Check Interval	Enter the polling interval for the POP3 server. The default setting is five minutes.



Item	Description
	When SSL/TLS is enabled <input checked="" type="checkbox"/> , encrypted communication is performed as POP over SSL/TLS or POP over TLS by STLS command. Therefore, the server must support POP over SSL/TLS or STLS commands. For POP over SSL / TLS, set the POP over SSL / TLS port number in "Port Number". To allow POP over TLS communication, set the "Port Number" to the same port number as for the normal POP3 communication. Factory default settings: Disable
Connection Test	Tap the [Execute] button to test the connection to the POP3 server.

Alerts Message

Selects the E-mail Alert function settings.

The E-mail Alert function can report a trouble of the machine to the administrator or dealer using e-mail.

Sets the E-mail Alert Message List 1, E-mail Alert Message List 2, and Dealer E-mail Alert Message List separately.

E-mail Address

Enter the destination E-mail address for alert message transmission. You can enter multiple addresses by separating them by a semicolon or comma.

Example: aaa@xxxxx.□□□; bbb@xxxxx.□□□

A report will be sent by e-mail in the following situations. You can individually set the status for sending alerts for each address list. When the unit becomes the target of the alert, an email will be sent to the set address.

Jam, Toner Low, Toner Empty, Paper Empty, Service Request, PM Request, Waste Toner Almost Full, Waste Toner Full, Job Log Full, Security Alert

Factory default settings: All enable except security alerts



SMTP Settings

Use SMTP Server in [Network Settings].

Set the SMTP server settings used for e-mail status and E-mail alert to the same settings as [SMTP Settings \(page 10-160\)](#) of network setting.

SMTP Settings

Use this setting when not using "Use SMTP Server in [Network Settings].".

Primary Server

Enter the IP address or the host name of the primary SMTP server.

Secondary Server

This setting is available when you select "Authentication Option" other than "OAuth 2.0".

Enter the IP address or the host name of the secondary SMTP server.

Port Number

Enter a port number.

Factory default settings: 25

Timeout

Enter a timeout. This value is used for connection to the SMTP server and for data transmission according to the e-mail system specifications.

Factory default settings: 20 seconds

Sender Name

Enter the sender name.

Sender Address

Enter the sender's address

Enable SSL/TLS

If the SSL is enabled, the SMTP-over-TLS encryption communication can be used by STARTTLS command.

This requires the server to support the STARTTLS command.

To allow SSL/TLS communication, set the "Port Number" to the same port number as the normal SMTP.

Factory default settings: Disable

Authentication Option

Specify the authentication method for SMTP.

Select "OAuth 2.0" when using Microsoft365, Exchange Online, etc.

For information on how to configure the settings when OAuth 2.0 is selected, see "[OAuth 2.0 AUTHENTICATION \(page 9-39\)](#)".

Factory default settings: No Authentication

Provider

This can be set when "OAuth 2.0" is selected as "Authentication Option".

Select a provider.

Factory default settings: Microsoft

Account Name

This can be set when "OAuth 2.0" is selected as "Authentication Option".

Enter an account name.

Token

This can be set when "OAuth 2.0" is selected as "Authentication Option".

Displays the current token status.

Get Token / Delete

The "Get Token" key is displayed if the token has not been obtained, and the "Delete" key is displayed if the token has been obtained.

The "Get Token" key is displayed in the System Settings of the machine and is not displayed on the Web page.

**User Name**

This setting is available when "SMTP Authentication" is selected as "Authentication Option".
Enter the user name.

Password

This setting is available when "SMTP Authentication" is selected as "Authentication Option".
Enter the password.

To change the password, set [Change Password] to .

POP before SMTP

This setting is available when you select "Authentication Option" other than "OAuth 2.0".

If is set, you are authenticated to the POP server before using the SMTP communication.

- POP3 Server: Enter the IP address or the host name of the secondary SMTP server.

Factory default settings: Disable

- Port Number: Enter the POP3 port number for POP before SMTP communication. The default setting is port 110.

Factory default settings: 110

- POP Authentication: If is set, the authentication protocol (including APOP) is used for authentication to the POP3 server.

Factory default settings: Disable

- User Name: Enter the user name for POP before SMTP communication.
- Password: Enter the password required for POP before SMTP communication. To change the password, set [Change Password] to .
- Enable SSL/TLS: If set to , the POP over SSL/TLS communication or the POP over TLS communication by STLS command is enabled. This requires the server to support the POP over SSL/TLS communication or the STLS command. To allow SSL/TLS communication, set the "Port Number" to the POP over SSL communication port number. To allow POP over TLS communication, set the "Port Number" to the same port number as for the normal POP3 communication.

Factory default settings: Disable

Connection Test

Tap the [Execute] button to test the connection to the SMTP server.



Enhanced FSS Settings

This function is for connection to Synappx Manage, a cloud service for device management.



- Use of this function requires the use of this cloud service.
- This setting may not be available in all countries and regions.

Enhanced FSS

Sets whether to enable the Enhanced FSS feature.
Switching this function requires a reboot of the machine.

Factory default settings: Disable

URL

Enter the initial connection URL provided by the tenant of the cloud service.
After the connection is completed, if the URL is registered as blank, the previous connection information will be initialized.

Check Now

Checks for requests to retrieve information from the cloud service or to change the control of the machine.

Update of Firmware

This setting is available when a data security kit is installed in the machine and "Advanced Security Settings" are configured.

The firmware of the machine can be updated via LAN without using a USB memory.

See the data security kit manual for details on settings with the data security kit.

For more information on "Advanced Security Settings", contact your dealer or nearest SHARP Service Department.

Select File

Select the firmware file to be updated.

Display the Firmware Update Status on the Device Web Page

Set whether to display the firmware update status on the web page.

Execute

Tap this key to start updating the selected firmware.



- This setting can be configured on the web page.
- Do not turn off the power while updating the firmware.



Image Quality Adjustment



Fusing Cleaning Mode in [Collective Adjustment], and all Common Functions can only be executed in setting mode on the machine.

Collective Adjustment

Various devices mounted on the machine can be set.

Fusing Cleaning Mode

Use this function to clean the machine's fusing unit when dots or other dirt appear on the printed side of the paper. When this function is executed, "V" printed paper is output and the fusing unit is cleaned.



If improvement is not noticed after the first time you use the function, try executing the function again.

MC Cleaning Mode

This machine periodically executes automatic cleaning and normally it is not necessary to execute this mode. Only in case, however, that black lines appear on the printed paper, execute this mode.



Do not use this function when no black lines appear. Using this function under the normal condition may cause deterioration of the cleaner.

Black Letter/Black Line Width Adjustment

Adjust black text and the width of black lines. After using this function to perform adjustment, perform [System Settings] - [Common Functions] - [Auto Gray Calibration (for Copy)], [Auto Gray Calibration (for Print)].

Factory default settings: 0

Dark Streak Reduction

Specify to use the dark streak reduction or not.

The dark streak reduction can be used for Scan Original, Copy, Image Send, and Scan to local drive functions.

If the dark streak reduction is enabled, select any of the following options.

Treat Thin Dark Streaks: Use this setting to make thin dark streaks less apparent. (Low level)

Normal: Use this setting to make dark streaks less apparent. (Medium level)

Treat Up to Thick Dark Streaks: Use this setting to make thick dark streaks less apparent. (High level)

Factory default settings: Disable



Increasing the level of dark streak treatment may result in faint text and poor reproduction of lines.

Display warning message for dark streaks detection.

Set this option to display a warning message when dark streaks are detected by the document feeder.

Factory default settings: Disable



Copy Image Quality

Quick Image Quality Adjustment

You can easily perform copy quality adjustment in the default state.
You can change the default setting ([2]) to [1 (Smooth)] or [3 (Sharp)].

Factory default settings:2

Gray Balance

You can adjust the gradation, and density of copies.
The density is divided into 3 ranges and you can adjust the level.

Factory default settings: All 0

Density Adjustment when [Auto] is selected for Exposure

Configure settings for black & white copying when [Auto] is selected for the copy exposure. The exposure can be adjusted separately for copying using the document glass and copying using the auto document feeder.

Factory default settings: Document Glass, Document Feeder:5 (Normal)

Sharpness

You can make copy images in the default state sharper or softer.

Factory default settings:2

Image Quality Priority

Specify image quality priority. Set this for the auto copy exposure and text / printed photo settings.

Factory default settings:All 0

Print Image Quality

Quick Image Quality Adjustment

Perform quick adjustment of print quality.
You can change the default setting ([2]) to [1 (Smooth)] or [3 (Sharp)].

Factory default settings: 2

Gray Balance

You can adjust the gradation, and density of printing.
The density is divided into 3 ranges and you can adjust the level.

Factory default settings: All 0



Exposure Adjustment

Set the density of printing.

Factory default settings:3 (Normal)

Line Thickness

When lines do not print correctly in special applications such as CAD, you can make lines thicker.

Factory default settings:5

Scan Image Quality

RGB Adjust

Set the color tone (RGB) for scanning.

Factory default settings: All 0

Sharpness

Use this setting to obtain a sharp image when scanning an original.

Factory default settings: 3 (Normal)

Contrast

You can adjust the contrast of scanned images.

Factory default settings:3 (Normal)



Common Functions

Auto Gray Calibration (for Copy)/Auto Gray Calibration (for Print)/Copy Calibration by Screen/Printer Calibration by Screen

Performs automatic grayscale correction.

For copying, adjust with [Auto Gray Calibration (for Copy)]. For printing, adjust with [Auto Gray Calibration (for Print)]. You can use [Copy Calibration by Screen] and [Printer Calibration by Screen] to perform even higher precision adjustment of each mode.

The machine prints a test patch, the test patch is scanned, and the grayscale is automatically corrected.

After the [Execute] key is tapped and a test patch is printed, a message appears prompting you to begin automatic calibration.

Follow the instructions in the message to perform gray adjustment.



If the grayscale is still off after performing Auto Gray Calibration, repeating Auto Gray Calibration once again may improve the grayscale.

Density Smoothing Adjustment

If uneven density occurs in a copy and others, use this function to smooth the density.

The uneven density is automatically corrected by scanning a test patch that you print.

After the [Execute] key is tapped and a test patch is printed, a message appears prompting you to begin automatic calibration.

Follow the instructions in the message to perform density smoothing.

If there are no problems after adjustment, perform "Auto Gray Calibration (for Copy)" and "Auto Gray Calibration (for Print)".

To return the adjusted values to their factory default state, tap [Return Density Smoothing Adjustment Value to Defaults].

If you tapped [Return to the Defaults], perform adjustment of the density that you want to readjust (medium density in the default mode).

Factory default settings: Middle



If the intensity deviation correction does not resolve the intensity deviations, repeat the correction. This may suppress the deviations. To repeat the correction, start over the procedure from the first step, or tap the [Back] key after going through the correction procedure.



Initial Installation Settings

This is a group of settings that are required when you initially install the machine. The initial installation setting items are the same as the regular setting items that have the same name. For information on a setting item, see the explanation of the regular item.

Item	Description
Condition Settings	
Name	System Settings - Common Settings - Machine Identification Settings (page 10-148)
Machine Code	
Machine Location	
Memo	
Clock Adjust	
Daylight Saving Time Setting	
Preheat Mode Setting	System Settings - Energy Save - Eco Setting (page 10-202)
Auto Power Shut-Off	
Display a Message to Delay the Time of Entry into Preheat Mode / Auto Power Shut-Off Mode	
Sleep Mode Power Level	
Network Quick Settings	System Settings - Network Settings - Quick Settings (page 10-158)
Tray Settings	System Settings - Common Settings - Paper Settings- Paper Tray Settings (page 10-135)
Product Key	System Settings - Common Settings - Product Key/Application Number Input (page 10-156)



TROUBLESHOOTING

Q&A

GENERAL PROBLEMS	11-2
CHECK LIST	11-2
COPYING PROBLEMS	11-21
CHECK LIST	11-21
PRINTING PROBLEMS	11-26
CHECK LIST	11-26
FAX PROBLEMS	11-35
CHECK LIST	11-35
IMAGE SEND PROBLEMS	11-45
CHECK LIST	11-45
DOCUMENT FILING PROBLEMS	11-53
CHECK LIST	11-53

REMOVING MISFEEDS

REMOVING MISFEEDS	11-57
--------------------------------	--------------





Q&A

GENERAL PROBLEMS

Have functions been disabled by the administrator?

Some functions may have been disabled in the setting mode. When user authentication is enabled, the functions that you can use may be restricted in your user settings. Check with your administrator.

CHECK LIST

 Problem	 Check	Page
I CAN'T USE A PARTICULAR FUNCTION OR PERIPHERAL DEVICE	Have functions been disabled by the administrator?	11-5
I DON'T KNOW HOW TO CHECK THE TOTAL NUMBER OF PAGES USED	Hold down the [Home Screen] key.	11-5
	You can check in the status of setting mode.	11-5
THE OPERATION PANEL CANNOT BE USED	Is the main power indicator lit?	11-6
	Did you just power on the machine?	11-6
	Is the main power indicator blinking?	11-6
	Is a cover open or a device separated from the machine?	11-6
	Did login fail three times in a row?	11-6
	Does a message appear indicating that Auto Login failed?	11-6
	Does the message "Call for service. Code:xx-xx*." appear in the touch panel?	11-6
THE MOTION SENSOR DOES NOT RESPOND CORRECTLY	Is the motion sensor disabled?	11-7
	Is there are problem in the installation location or installation environment?	11-7
	Is the detection range set correctly?	11-7
PRINTING IS NOT POSSIBLE OR STOPS DURING A JOB	Is a tray out of paper?	11-8
	Is the machine out of toner?	11-8
	Has a paper misfeed occurred?	11-8
	Is the output tray full?	11-8
	Is the toner collection container full?	11-8
	Are restrictions placed on the trays that can be used in each mode (copy, print, image send, and document filing)?	11-8
	Is the original curled or folded?	11-8
THE ORIGINAL SIZE IS NOT AUTOMATICALLY SELECTED OR THE WRONG SIZE IS SELECTED	Did you place an original smaller than 5-1/2" x 8-1/2" (A5 for AB settings) size on the document glass?	11-8
	Did you place an original smaller than 5-1/2" x 8-1/2" (A6R for AB setting) size in the document feeder?	11-8
	Is an original of the 5-1/2" x 8-1/2" (A5 for AB setting) size set to landscape (5-1/2" x 8-1/2"R (A5R)) on the document glass?	11-8
	Is an original of the A6 size set to portrait (A6 size) in the document feeder?	11-8
	Is the document feeder sensor dirty?	11-8
THE DISPLAYED BYPASS TRAY PAPER SIZE IS NOT CORRECT	Do the bypass tray guides match the width of the loaded paper?	11-9





? Problem	✓ Check	Page
THE ORIGINAL MISFEEDS (AUTOMATIC DOCUMENT FEEDER)	Is too much paper loaded into the document feeder tray?	11-9
	Is the original a long original?	11-9
	Is the original on thin paper?	11-9
	Is the original on heavy paper?	11-9
	Is the feed roller dirty?	11-9
MULTIPLE ORIGINALS ARE FED AT THE SAME TIME AND CANNOT BE LOADED CORRECTLY (AUTOMATIC DOCUMENT FEEDER)	Are your originals warped or folded? Are you using a pasted originals?	11-10
THE EJECTED MANUSCRIPTS ARE NOT ALIGNED NEATLY (AUTOMATIC DOCUMENT FEEDER)	Is the manuscript set correctly? Depending on the condition of the original, the type of paper, the temperature at the time of use, and the humidity environment, the ejected originals may not be aligned neatly.	11-10
THE PAPER MISFEEDS	Is a torn piece of paper remaining in the machine?	11-10
	Is too much paper loaded in the tray?	11-10
	Are multiple sheets feeding at once?	11-10
	Are you using paper that is not within the specifications?	11-11
	Are the bypass tray guides adjusted to the width of the paper?	11-11
	Is the bypass tray extension guide pulled out?	11-11
	Is the bypass feed roller dirty?	11-11
	Is A5/A6 (5-1/2" x 8-1/2") size paper loaded?	11-11
	Is the paper size specified?	11-11
	Did you add paper to the tray?	11-11
	Are you using punched paper?	11-11
	Are you using label sheets that cannot be used?	11-11
	Remove the paper, turn it over, and reload it. Using a different paper type may solve the problem.	11-11
PAPER DOES NOT FEED FROM THE PAPER TRAY	Is the paper loaded correctly into the paper tray?	11-11
	Has the tray been prohibited in some modes (copy, print, fax, image send, document filing)?	11-11
I DON'T KNOW HOW TO CHANGE THE PAPER SIZE	Set the paper size used in each tray in the tray settings.	11-12
THE OUTPUT IS NOTICEABLY CURLED AND UNEVEN	Remove the paper, turn it over, and reload it. Using a different paper type may solve the problem.	11-12
THE IMAGE IS SKEWED ON THE PAPER	Is too much paper loaded into the bypass tray?	11-12
	Are the bypass tray guides adjusted to the width of the paper?	11-12
	Are the original guides adjusted to the width of the paper?	11-12
	The original is scanned skewed.	11-12
LINES APPEAR IN THE IMAGE	Are the scanning areas of the document glass or automatic document feeder dirty?	11-12
	Is the bypass feed roller dirty?	11-12
	Did you execute Dark Streak Reduction of system setting?	11-13
SMUDGES APPEAR ON PRINTED OUTPUT	Are you using paper that is not within the specifications?	11-13
	Are you printing on pre-punched paper?	11-13
	Does a message appear indicating the need for maintenance?	11-13
	Remove the paper, turn it over, and reload it. Using a different paper type may solve the problem.	11-13



? Problem	✓ Check	Page
WHEN PRINTING ON THICK PAPER, THE PRINT RESULT IS DIRTY FROM THE 2ND PAGE ON	Has the paper type been set correctly?	11-13
I DON'T KNOW HOW TO CHANGE THE OUTPUT TRAY	Did you change the output tray?	11-14
PART OF THE IMAGE IS CUT OFF	Has the correct paper size been set?	11-14
	Was the original placed in the correct position?	11-14
PRINTING TAKES PLACE ON THE WRONG SIDE OF THE PAPER	Is the paper loaded with the print side facing in the correct direction?	11-14
A COVER OR INSERT IS NOT PRINTED ON THE SPECIFIED PAPER	Has the paper type been set correctly?	11-15
THE CONNECTED USB DEVICE CANNOT BE USED	Is the USB device compatible with the machine?	11-15
	Is the connected USB device recognized correctly?	11-15
	Is the USB memory formatted as FAT32 or NTFS?	11-15
	Are you using a USB memory device with a capacity of more than 32 GB?	11-15
THE FINISHER/SADDLE FINISHER DOES NOT OPERATE	Does a message appear indicating that you need to remove paper from the stapler compiler?	11-15
	Have functions been disabled by the administrator?	11-15
STAPLING DOES NOT TAKE PLACE (INCLUDING SADDLE STITCH)	Does a message appear instructing you to check the staple unit?	11-16
	Does a message appear instructing you to add staples?	11-16
	Is a different width of paper mixed in?	11-16
	Are there more sheets than can be stapled at once?	11-16
	Is a paper size that cannot be stapled included in the print job?	11-16
	Is the paper type setting of the tray selected in the printer driver set to a paper type that cannot be stapled?	11-16
PUNCHING DOES NOT TAKE PLACE	Does a message appear instructing you to check the punch module?	11-16
	Is a different size of paper mixed in?	11-16
	Is a paper size that cannot be punched included in the print job?	11-16
	Is the tray selected in the printer driver set to a paper type that cannot be punched?	11-16
THE STAPLING POSITION OR PUNCH POSITION IS NOT CORRECT	Is the stapling position setting correctly?	11-17
	Are the punching positions setting correctly?	11-17
FOLDING DOES NOT TAKE PLACE	Is it a paper size that can be folded?	11-17
	Did the administrator enable the [Disabling of Duplex] setting?	11-17
	Are you using a paper type that has a specific front and reverse side?	11-17
THE FOLD POSITION IS NOT CORRECT	Is the original placed face up or face down correctly?	11-17
PREVIEW IMAGES OR THUMBNAIL IMAGES DO NOT APPEAR	Are there a number of jobs waiting to be executed?	11-17
THE TOUCH PANEL DISPLAY IS DIFFICULT TO VIEW	Is the brightness properly adjusted?	11-18
YOU WERE LOGGED OUT WITHOUT LOGGING OUT YOURSELF	Did Auto Clear activate?	11-18
I DON'T KNOW WHERE THE IP ADDRESS SETTING IS	The IP address is set in the Network Settings of Setting mode.	11-18
I DON'T KNOW HOW TO CHANGE THE BACKGROUND COLOR OF THE HOME SCREEN	You can change the background color in "MFP Display Pattern Setting".	11-18



 Problem	 Check	Page
I DON'T KNOW HOW TO ADD A SHORTCUT TO OR DELETE A SHORTCUT FROM THE HOME SCREEN	You can change a shortcut in "Edit Home".	11-19
I DON'T KNOW HOW TO RESTORE THE LARGE TEXT SETTING TO ITS ORIGINAL STATE	Is large text mode enabled in the home screen?	11-19
I DON'T KNOW HOW TO ADJUST THE TIME THE MACHINE ENTERS ENERGY SAVE MODE	Set the time the machine enters energy save mode in the Energy Save settings of setting mode.	11-19
I FORGOT THE ADMINISTRATOR PASSWORD	Was the administrator password changed from the factory default setting?	11-19
I DON'T KNOW WHOM TO CONTACT FOR MAINTENANCE AND SERVICE	Please check the customer support information.	11-20

I CAN'T USE A PARTICULAR FUNCTION OR PERIPHERAL DEVICE



Check

Have functions been disabled by the administrator?



Solution

- Check with your administrator.
Some functions may have been disabled in the setting mode. When user authentication is enabled, the functions that you can use may be restricted in your user settings.

I DON'T KNOW HOW TO CHECK THE TOTAL NUMBER OF PAGES USED



Check

Hold down the [Home Screen] key.

You can check in the status of setting mode.



Solution

- When you hold down the [Home Screen] key, a message showing the total page usage and toner level will appear.
- [Total Count] appears in the [Status] of setting mode. You can check the total pages used from this item.



THE OPERATION PANEL CANNOT BE USED



Check

Is the main power indicator lit?

Did you just power on the machine?

Is the main power indicator blinking?

Is a cover open or a device separated from the machine?

Did login fail three times in a row?

Does a message appear indicating that Auto Login failed?

Does the message "Call for service. Code:xx-xx*" appear in the touch panel?

*Letters and numbers appear in xx-xx.



Solution

■ If the main power indicator is not lit up, turn the machine's power on. Make sure that the power plug is firmly inserted in the power outlet, switch the main power switch to the " I " position.

■ After the [Power] button is turned on, the machine requires some time to complete warmup operation. During warmup operation, functions can be selected, but a job cannot be run.

■ Auto Power Shut-Off mode has activated. To return the machine to normal operation, press the [Power] button. For more information, see [ECO \(page 9-2\)](#).

■ Read the message and take appropriate actions. A warning message will appear when a cover is open or a device is separated from the machine.

■ After operation unlocks, log in using the correct user information. When [A Warning when Login Fails] is enabled in the setting mode and login fails 3 times in a row, a warning will be displayed and user authentication operation will lock for 5 minutes.
(If you do not know your user information, contact your administrator.)
⇒ "Settings (administrator)" → [System Settings] → [Authentication Settings] → [Default Settings] → [A Warning when Login Fails]

■ Check with your administrator. Auto Login failed due to network or other problems. If you are the administrator, tap the [Administrator Password] key, log in as an administrator, and temporarily change the auto login settings in the setting mode. (Restore the changed settings to their original state after the problems have been solved.)

■ Turn on the machine power again.
■ Make sure that the background color of the job status display at the upper right corner of the touch panel is gray, and press the [Power] button and then turn the main power switch to the " ⏻ " position. Waiting at least 10 seconds and then turn the main power switch to the " I " position.
■ If the message still appears after switching the [Power] button and the main power switch off and on several times, it is likely that a failure has occurred that requires service. In this event, stop using the machine, unplug the power plug, and contact your dealer or nearest authorised service representative. (When contacting your dealer or nearest authorised service representative, inform them of the displayed error code.)



THE MOTION SENSOR DOES NOT RESPOND CORRECTLY

✓ Check

Is the motion sensor disabled?

Is there are problem in the installation location or installation environment?

Is the detection range set correctly?

! Solution

■ Select [Motion Sensor Mode] in "Settings (administrator)" - [System Settings]→[Energy Save]→[Eco Setting]→[Sleep Mode Power Level] or "Settings (administrator)" - [Initial Installation Settings]→[Sleep Mode Power Level].

■ Check the installation location and installation environment.
The motion sensor may not operate correctly in the conditions below.

- An object is in front of the motion sensor
- There are scratches or dirt on the motion sensor cover
- The motion sensor is directly exposed to sunlight or air flow
- The motion sensor is damaged
- There is a source of heat such as a heater nearby
- An object is moving in the detection range

■ Adjust the detection range.

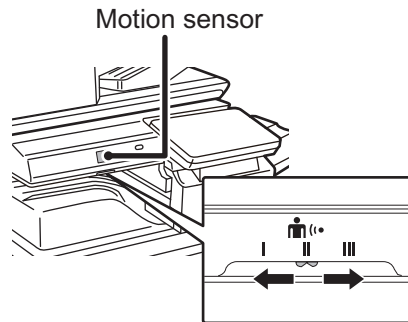



PRINTING IS NOT POSSIBLE OR STOPS DURING A JOB



Check

Is a tray out of paper?

Is the machine out of toner?

Has a paper misfeed occurred?

Is the output tray full?

Is the toner collection container full?

Are restrictions placed on the trays that can be used in each mode (copy, print, image send, and document filing)?



Solution

■ Add paper as instructed by the message in the touch panel.

■ Replace the toner cartridge. [REPLACEMENT OF TONER CARTRIDGE \(page 1-77\)](#)

■ Remove the misfeed as instructed by the message in the touch panel.

■ Remove the output from the tray and resume printing.
When the output tray becomes full, a detector activates and stops printing.

■ Replace the toner collection container as instructed by the message in the touch panel.

■ Check the settings in [Paper Tray Settings] and see if checkmarks appear in the checkboxes of each mode ([Feeding Approved Job]).
Functions without a checkmark cannot be used for printing using that tray.
⇒ "Settings" → [System Settings] → [Common Settings] → [Paper Settings] → [Paper Tray Settings] → [Tray Registration] → [Feeding Approved Job]

THE ORIGINAL SIZE IS NOT AUTOMATICALLY SELECTED OR THE WRONG SIZE IS SELECTED



Check

Is the original curled or folded?

Did you place an original smaller than 5-1/2" x 8-1/2" (A5 for AB settings) size on the document glass?

Did you place an original smaller than 5-1/2" x 8-1/2" (A6R for AB setting) size in the document feeder?

Is an original of the 5-1/2" x 8-1/2" (A5 for AB setting) size set to landscape (5-1/2" x 8-1/2"R (A5R)) on the document glass?

Is an original of the A6 size set to portrait (A6 size) in the document feeder?

Is the document feeder sensor dirty?



Solution

■ Straighten the original.
The correct original size cannot be detected if the original is curled or folded.

■ Select the original size manually.
Original sizes smaller than 5-1/2" x 8-1/2" (A5) cannot be detected automatically. When scanning a small original on the document glass, it is convenient to place a blank sheet of paper on top of the original which is the same size (such as 8-1/2" x 11" and 5-1/2" x 8-1/2" (A4 and B5)) as the paper at you wish to use for printing.

■ Select the original size manually.
Original sizes smaller than 5-1/2" x 8-1/2" (A6R for AB setting) cannot be detected automatically.

■ If an original of the 5-1/2" x 8-1/2" (A5) size is set to landscape (5-1/2" x 8-1/2"R (A5R)) size, it is not detected automatically.
Set the 5-1/2" x 8-1/2" (A5) size document in portrait orientation (5-1/2" x 8-1/2" (A5)).

■ If an original of the A6 size is set to portrait (A6 size), it is not detected automatically.
Set the A6 size document in landscape orientation (A6R).

■ Wipe the sensor clean using a damp cloth or a wet tissue.



THE DISPLAYED BYPASS TRAY PAPER SIZE IS NOT CORRECT



Check

Do the bypass tray guides match the width of the loaded paper?



Solution

- Set the bypass tray guides to the width of the paper.
When loading paper in the bypass tray, be sure to pull out the extension guide to enable the paper size to be detected correctly.

THE ORIGINAL MISFEEDS (AUTOMATIC DOCUMENT FEEDER)



Check

Is too much paper loaded into the document feeder tray?

Is the original a long original?

Is the original on thin paper?

Is the original on heavy paper?

Is the feed roller dirty?



Solution

- Make sure that the stack of paper in the tray is not higher than the indicator line.
[AUTOMATIC DOCUMENT FEEDER \(page 1-34\)](#)
- When using the automatic document feeder to scan a long original, set the scan size to [Long Size].
(Note that long originals cannot be copied using the copy function.)
- Use the document glass to scan the original.
If you need to use the automatic document feeder, use [Slow Scan Mode] in [Others] to scan the original.
- Use the document glass to scan the original.
If you need to use the automatic document feeder, use [Heavy Paper Scan] in [Others] to scan the original.
- Clean the surface of the paper feed roller.
[CLEANING THE PAPER FEED ROLLER \(page 1-76\)](#)



MULTIPLE ORIGINALS ARE FED AT THE SAME TIME AND CANNOT BE LOADED CORRECTLY (AUTOMATIC DOCUMENT FEEDER)



Check

Are your originals warped or folded?
Are you using a pasted originals?



Solution

- Fix any warps or folds in the originals. Fan the originals well and load them in automatic document feeder. Align the edges of the original and set the original size.
Depending on the condition of the original, the type of paper, and the temperature and humidity of the environment in which the machine is used, multiple sheets of paper may be fed at the same time and may not be loaded correctly, or the ejected originals may not be neatly aligned.
It may be improved by the following settings.
 - For copying: Set the resolution to 600x600dpi
 - For scan transmission: use "Preview"[AUTOMATIC DOCUMENT FEEDER \(page 1-34\)](#)

THE EJECTED MANUSCRIPTS ARE NOT ALIGNED NEATLY (AUTOMATIC DOCUMENT FEEDER)



Check

Is the manuscript set correctly?
Depending on the condition of the original, the type of paper, the temperature at the time of use, and the humidity environment, the ejected originals may not be aligned neatly.



Solution

- Depending on the condition of the original, the type of paper, the temperature at the time of use, and the humidity environment, the ejected originals may not be aligned neatly.
It may be improved by the following settings.
 - For copying: Set the resolution to 600x600dpi
 - For scan transmission: use "Preview"[AUTOMATIC DOCUMENT FEEDER \(page 1-34\)](#)

THE PAPER MISFEEDS



Check

Is a torn piece of paper remaining in the machine?

Is too much paper loaded in the tray?

Are multiple sheets feeding at once?



Solution

- Follow the instructions in the touch panel to remove all paper.
- Reload the paper. Load no more than the maximum number of sheets and do not exceed the indicator line.
[LOADING PAPER \(page 1-11\)](#)
- Fan the paper well before loading it.



Check



Solution

Are you using paper that is not within the specifications?

- Use SHARP-recommended paper. Using paper that is for other models or special paper that is not supported may result in misfeeds, creases, or smudges.
⇒ - "SUPPLIES" in Start Guide
For paper that is prohibited or not recommended, see [IMPORTANT POINTS ABOUT PAPER \(page 1-11\)](#).

Are the bypass tray guides adjusted to the width of the paper?

- Adjust the bypass tray guides to the width of the paper so that they slightly contact the sides of the paper.
[LOADING PAPER INTO THE BYPASS TRAY \(page 1-28\)](#)

Is the bypass tray extension guide pulled out?

- When loading large-size paper, pull out the extension guide.
[LOADING PAPER INTO THE BYPASS TRAY \(page 1-28\)](#)

Is the bypass feed roller dirty?

- Clean the surface of the bypass feed roller.
[CLEANING THE BYPASS FEED ROLLER \(page 1-75\)](#)

Is A5/A6 (5-1/2" x 8-1/2") size paper loaded?

- When loading A5/A6 (5-1/2" x 8-1/2") size paper, place the paper in the horizontal (A5R/A6R (5-1/2" x 8-1/2"R)) orientation*
* A6R cannot be used without the right tray.

Is the paper size specified?

- If you are using a non-standard size, be sure to specify the paper size. If the size of paper loaded into a tray was changed, be sure to check the paper size setting.
⇒ "Settings" → [System Settings] → [Common Settings] → [Paper Settings] → [Paper Tray Settings] → [Tray Registration]

Did you add paper to the tray?

- When adding paper, remove any paper remaining in the bypass tray, combine it with the paper to be added, and reload as a single stack. If paper is added without removing the remaining paper, a misfeed may occur. Do not add paper other than the bypass tray.

Are you using punched paper?

- When using punched paper, set the paper type to punched.
⇒ "Settings" → [System Settings] → [Common Settings] → [Paper Settings] → [Paper Tray Settings] → [Tray Registration]

Are you using label sheets that cannot be used?

- Labels without a carrier sheet may stick to the transfer surface and cause a misfeed.

Remove the paper, turn it over, and reload it. Using a different paper type may solve the problem.

- This may improve some states of paper curling. [LOADING PAPER \(page 1-11\)](#)

PAPER DOES NOT FEED FROM THE PAPER TRAY



Check



Solution

Is the paper loaded correctly into the paper tray?

- Set the guides to the size of the paper. Reload the paper. Load no more than the maximum number of sheets and do not exceed the indicator line.
[LOADING PAPER \(page 1-11\)](#)

Has the tray been prohibited in some modes (copy, print, fax, image send, document filing)?

- Check the settings in [Paper Tray Settings] and see if checkmarks appear in the checkboxes of each mode ([Feeding Approved Job]). Functions without a checkmark cannot be used for printing using that tray.
⇒ "Settings" → [System Settings] → [Common Settings] → [Paper Settings] → [Paper Tray Settings] → [Tray Registration] → [Feeding Approved Job]



I DON'T KNOW HOW TO CHANGE THE PAPER SIZE

✓ Check

Set the paper size used in each tray in the tray settings.

! Solution

- The "Tray Settings" key can be found in the home screen. Tap this key to display the tray settings screen. Tap the tray whose paper size you want to change, select the paper type, and then tap the [Size] tab. Select the paper size and tap the [OK] key. If you loaded a special size of paper in the bypass tray, tap the [Direct Entry] key after tapping the [Size] tab, enter the paper size manually, and tap the [Execute] key.

THE OUTPUT IS NOTICEABLY CURLED AND UNEVEN

✓ Check

Remove the paper, turn it over, and reload it. Using a different paper type may solve the problem.

! Solution

- This may improve some states of paper curling.
▶ [LOADING PAPER \(page 1-11\)](#)

THE IMAGE IS SKEWED ON THE PAPER

✓ Check

Is too much paper loaded into the bypass tray?

! Solution

- Reload the paper. Load no more than the maximum number of sheets and do not exceed the indicator line.
The maximum number of sheets varies depending on the paper type setting.

Are the bypass tray guides adjusted to the width of the paper?

- Adjust the bypass tray guides to the width of the paper so that they slightly contact the sides of the paper.

Are the original guides adjusted to the width of the paper?

- Adjust the original guides to the width of the paper.

The original is scanned skewed.

- Setting up a Easy Scan with automatic settings may solve the problem.

LINES APPEAR IN THE IMAGE

✓ Check

Are the scanning areas of the document glass or automatic document feeder dirty?

! Solution

- Clean the scanning areas of the document glass or automatic document feeder.
[CLEANING THE DOCUMENT GLASS AND AUTOMATIC DOCUMENT FEEDER \(page 1-73\)](#)

Is the bypass feed roller dirty?

- Clean the surface of the bypass feed roller.
[CLEANING THE BYPASS FEED ROLLER \(page 1-75\)](#)



Check

Did you execute Dark Streak Reduction of system setting?



Solution

- Execute in "Settings (administrator)" → [System Settings] → [Image Quality Adjustment] → [Collective Adjustment] → [Dark Streak Reduction]. To detect dark streaks, enable [Display Warning When Streak is Detected]. For more information on the setting, refer to the User's Manual.

[Dark Streak Reduction \(page 10-217\)](#)

SMUDGES APPEAR ON PRINTED OUTPUT



Check

Are you using paper that is not within the specifications?



Solution

- Use SHARP-recommended paper.
Using paper that is for other models or special paper that is not supported may result in misfeeds, creases, or smudges.
⇒ - "SUPPLIES" in Start Guide
- Try setting the paper type to a type that is slightly heavier or slightly lighter than normal. (For plain paper, switch plain paper 1 to plain paper 2 or plain paper 2 to plain paper 1.) Depending on the paper type, print quality may be improved. For details, contact your dealer or nearest authorised service representative.

Are you printing on pre-punched paper?

- Take care that the image does not overlap the punch holes.
If the printed image overlaps the punch holes, smudges may appear on the reverse side of the paper following 1-sided printing, or on both sides following 2-sided printing.

Does a message appear indicating the need for maintenance?

- Contact your dealer or nearest authorised service representative as soon as possible.

Remove the paper, turn it over, and reload it. Using a different paper type may solve the problem.

- This may improve some states of paper curling.
[LOADING PAPER \(page 1-11\)](#), [HOW TO PLACE THE ORIGINAL \(page 1-32\)](#)

WHEN PRINTING ON THICK PAPER, THE PRINT RESULT IS DIRTY FROM THE 2ND PAGE ON



Check

Has the paper type been set correctly?



Solution

- Set the correct paper type in the tray settings. Make sure that the following did not occur:
 - When using heavy paper, change the paper type in the tray settings to Heavy. (The image may disappear if rubbed.)
 - Paper other than heavy paper is being used, but heavy paper is selected in the tray settings. (This may cause creases and misfeeds.)
⇒ "Settings" → [System Settings] → [Common Settings] → [Paper Settings] → [Paper Tray Settings] → [Tray Registration]



I DON'T KNOW HOW TO CHANGE THE OUTPUT TRAY

Check

Did you change the output tray?

Solution

- When copying, you can select the output tray in normal mode. Tap [Output] in the base screen of normal mode. You can set the output tray in the screens. When printing, you can select the output tray in the printer driver. Click the [Finishing] tab in the printer driver, and select the output tray in [Output Tray]. The output tray is fixed and cannot be changed when some copy or print settings are selected. Some copy or print settings may be canceled when you change the output tray.

PART OF THE IMAGE IS CUT OFF

Check

Has the correct paper size been set?

Solution

- If you are using a non-standard size, be sure to specify the paper size. If the size of paper loaded into a tray was changed, be sure to check the paper size setting.
⇒ "Settings" → [System Settings] → [Common Settings] → [Paper Settings] → [Paper Tray Settings] → [Tray Registration]

Was the original placed in the correct position?

- If you are using the document glass, be sure to place the original in the far left corner of the document glass.
[LOADING PAPER \(page 1-11\)](#), [HOW TO PLACE THE ORIGINAL \(page 1-32\)](#)

PRINTING TAKES PLACE ON THE WRONG SIDE OF THE PAPER

Check

Is the paper loaded with the print side facing in the correct direction?

Solution

- Make sure that the print side of paper is facing in the correct direction.
 - Trays 1 to 4:
Place the paper with the print side face up.*
 - Bypass Tray, Tray 5:
Place the paper with the print side face down.*
- * When the paper type is "Pre-Printed" or "Letter Head", load the paper in the opposite way.
(Except when [Disabling of Duplex] is enabled in the setting mode (administrator). For information about the setting mode, consult your administrator.)



A COVER OR INSERT IS NOT PRINTED ON THE SPECIFIED PAPER



Check

Has the paper type been set correctly?



Solution

- Set the correct paper type for the tray that contains the paper specified for the cover or insert.
If the paper type set for the cover or insert is not the same as the paper type set for the tray, paper will be fed from a different tray.
⇒ "Settings" → [System Settings] → [Common Settings] → [Paper Settings] → [Paper Tray Settings] → [Tray Registration]

THE CONNECTED USB DEVICE CANNOT BE USED



Check

Is the USB device compatible with the machine?



Solution

- Ask your dealer if the device is compatible with the machine.
USB devices that are not compatible with the machine cannot be used.
 - When a USB device is connected to the machine and correctly recognized, an icon () will appear at the top of the touch panel. If it is not recognized, connect it once again.
 - Check the file format of the USB memory device.
If the USB memory is formatted as other than FAT32, NTFS or exFAT, use a computer to change the format to FAT32, NTFS, or exFAT.
 - Use a 32 GB or less USB memory device.
- Is the connected USB device recognized correctly?
- Is the USB memory formatted as FAT32 or NTFS?
- Are you using a USB memory device with a capacity of more than 32 GB?

THE FINISHER/SADDLE FINISHER DOES NOT OPERATE



Check

Does a message appear indicating that you need to remove paper from the stapler compiler?



Solution

- Remove all remaining paper from the stapler compiler.
 - Check with your administrator.
Some functions may have been disabled in the setting mode.
- Have functions been disabled by the administrator?



STAPLING DOES NOT TAKE PLACE (INCLUDING SADDLE STITCH)



Check

Does a message appear instructing you to check the staple unit?

Does a message appear instructing you to add staples?

Is a different width of paper mixed in?

Are there more sheets than can be stapled at once?

Is a paper size that cannot be stapled included in the print job?

Is the paper type setting of the tray selected in the printer driver set to a paper type that cannot be stapled?



Solution

- Remove jammed staples.
[PERIPHERAL DEVICES \(page 1-40\)](#)
- Replace the staple cartridge.
Do not forget to replace the staple case.
[PERIPHERAL DEVICES \(page 1-40\)](#)
- To perform mixed size stapling, using paper of the same width and select the [Same Width] setting.
Stapling is not possible when paper of different widths are mixed together. When copying, select [Same Width] for [Mixed Size Original] in [Others].
- For the maximum number of sheets that can be stapled, see "[SPECIFICATIONS \(page 12-2\)](#)".
- For paper sizes that can be stapled, see "[SPECIFICATIONS \(page 12-2\)](#)".
- You must check the paper types that are set on the machine, and select a paper tray that is set to paper* that can be used for staple printing.
Click the [Tray Status] button in [Paper Source] tab of the printer properties window and check the paper type setting of each tray.
*Stapling is not possible on labels, tab paper, glossy paper or transparency film. In addition, if "Disable Staple" is selected in the user type, stapling will not be possible.

PUNCHING DOES NOT TAKE PLACE



Check

Does a message appear instructing you to check the punch module?

Is a different size of paper mixed in?

Is a paper size that cannot be punched included in the print job?

Is the tray selected in the printer driver set to a paper type that cannot be punched?



Solution

- Dispose of punch scraps.
[PUNCH MODULE \(MX-PN16B\) \(page 1-69\)](#)
[PUNCH MODULE \(MX-PN13B\) \(page 1-71\)](#)
- Punching is not possible when different widths of paper are mixed together. To perform mixed size punching, use paper of the same width and select the [Same Width] setting. When copying, select [Same Width] for [Mixed Size Original] in [Others].clear image, select
- For the paper sizes that can be punched, see "SPECIFICATIONS" in Start Guide.
- Check the paper type settings in the machine and select a tray that has paper that can be used for punching*. Click the [Tray Status] button in [Paper Source] tab of the printer properties window and check the paper type setting of each tray.
*Punching is not possible on labels, tab paper, glossy paper or transparency film. In addition, if "Disable Punch" is selected in the user type, punching will not be possible.



THE STAPLING POSITION OR PUNCH POSITION IS NOT CORRECT



Check

Is the stapling position setting correctly?

Are the punching positions setting correctly?



Solution

■ Check the stapling position in "PREVIEW SCREEN".

■ Check the punch position in "PREVIEW SCREEN".

FOLDING DOES NOT TAKE PLACE



Check

Is it a paper size that can be folded?

Did the administrator enable the [Disabling of Duplex] setting?

Are you using a paper type that has a specific front and reverse side?



Solution

■ Check the paper size that can be folded.
[APPLICABLE PAPER TYPES \(page 1-12\)](#)

■ The paper folding function cannot be used when [Disabling of Duplex] is enabled in the setting mode. Check with your administrator.
⇒ In "Settings (administrator)", [System Settings] → [Common Settings] → [Condition Settings] → [Device Control] → [Disabling of Duplex].

■ The folding function cannot be used with pre-printed paper, letterhead paper, or other paper that has specific front or reverse sides.
When folding paper, use a paper type such as plain paper that does not have specific front or reverse sides.

THE FOLD POSITION IS NOT CORRECT



Check

Is the original placed face up or face down correctly?



Solution

■ Check the orientation for loading the original or the orientation of the paper to be folded, and take appropriate actions. For more information, see the [FOLD SETTING \(page 3-45\)](#) or [FOLDING PAPER FOR PRINTING \(FOLD\) \(page 4-68\)](#).

PREVIEW IMAGES OR THUMBNAIL IMAGES DO NOT APPEAR



Check

Are there a number of jobs waiting to be executed?



Solution

■ Wait until several of the jobs have been executed.



THE TOUCH PANEL DISPLAY IS DIFFICULT TO VIEW

Check

Is the brightness properly adjusted?

Solution

- Tap the [LCD Control] key () on the home screen to adjust the brightness.

YOU WERE LOGGED OUT WITHOUT LOGGING OUT YOURSELF

Check

Did Auto Clear activate?

Solution

- When user authentication is used, the currently logged in user will be automatically logged out if Auto Clear activates. Log in again.
If you are the administrator, change the time setting of Auto Clear or disable Auto Clear in [Auto Clear Setting].
- "Settings (administrator)" → [System Settings] → [Common Settings] → [Operation Settings] → [Condition Settings] → [Auto Clear Setting]

I DON'T KNOW WHERE THE IP ADDRESS SETTING IS

Check

The IP address is set in the Network Settings of Setting mode.

Solution

- To set a permanent IP address, ask your network administrator for the IP address assigned to the machine and other information necessary for the Network Settings.
⇒ "Settings (administrator)" → [System Settings] → [Network Settings] → [Interface Settings]

I DON'T KNOW HOW TO CHANGE THE BACKGROUND COLOR OF THE HOME SCREEN

Check

You can change the background color in "MFP Display Pattern Setting".

Solution

- Open the action panel on the home screen and tap [MFP Display Pattern Setting]. Enter the administrator password, and select the desired color from patterns 1 to 5. For more information, see [EDITING THE HOME SCREEN \(page 2-17\)](#).



I DON'T KNOW HOW TO ADD A SHORTCUT TO OR DELETE A SHORTCUT FROM THE HOME SCREEN

Check

You can change a shortcut in "Edit Home".

Solution



- Open the action panel on the home screen and tap [Edit Home]. Enter the administrator password, tap the desired location and add a shortcut, or tap a shortcut and delete. For more information, see [EDITING THE HOME SCREEN \(page 2-17\)](#).

I DON'T KNOW HOW TO RESTORE THE LARGE TEXT SETTING TO ITS ORIGINAL STATE

Check

Is large text mode enabled in the home screen?

Solution

- If the large text mode icon is  , large text mode is enabled. Tap the large text mode icon to change it to  and cancel large text mode.

I DON'T KNOW HOW TO ADJUST THE TIME THE MACHINE ENTERS ENERGY SAVE MODE

Check

Set the time the machine enters energy save mode in the Energy Save settings of setting mode.

Solution

- Set the time the machine enters energy save mode in the Energy Save settings of setting mode.
Set the time the machine enters Preheat Mode.
→ "Settings (administrator)" → [System Settings] → [Energy Save] → [Eco Setting] → [Preheat Mode Setting]
- Set the time that Auto Power Shut-Off takes place
- "Settings (administrator)" → [System Settings] → [Energy Save] → [Eco Setting] → [Auto Power Shut-Off Timer]

I FORGOT THE ADMINISTRATOR PASSWORD

Check

Was the administrator password changed from the factory default setting?

Solution

- Contact your dealer or nearest authorised service representative.
For the factory default administrator password, see "FOR THE ADMINISTRATOR" in Start Guide. After changing the password, take special care to remember it.



I DON'T KNOW WHOM TO CONTACT FOR MAINTENANCE AND SERVICE



Check

Please check the customer support information.



Solution

- Contact your dealer or nearest authorised service representative.





COPYING PROBLEMS

Have functions been disabled by the administrator?

Some functions may have been disabled in the setting mode. When user authentication is enabled, the functions that you can use may be restricted in your user settings. Check with your administrator.

CHECK LIST

 Problem	 Check	Page
2-SIDED COPYING DOES NOT TAKE PLACE	Does the paper type setting of the selected tray specify a type of paper that cannot be used for 2-sided copying?	11-22
	Are you using a special size or type of paper?	11-22
	Are you copying using settings that do not allow 2-sided copying?	11-22
ROTATE COPY DOES NOT WORK	Did you select the copy ratio manually?	11-22
	Are you copying using settings that do not allow rotate copying?	11-22
	Is "Rotation Copy Setting" disabled in the setting mode?	11-22
ENLARGE/REDUCE DOES NOT WORK	Are the original, paper, and ratio settings correct?	11-22
THE IMAGE IS TOO LIGHT OR TOO DARK	Is the image too light?	11-23
	Is the image too dark?	11-23
	Has an appropriate exposure mode for the original type been selected?	11-23
	Is the overall copy density too light?	11-23
PART OF THE IMAGE IS CUT OFF	Has an appropriate ratio been selected for the original size and paper size?	11-24
	Are you using an AB (inch) size original?	11-24
COPIES COME OUT BLANK	Is the original placed face up or face down correctly?	11-24
I WANT TO COPY MULTIPLE A4 PAGES ONTO ONE A4 SHEET OF PAPER	Use N-Up.	11-24
MIXED SIZE ORIGINALS CANNOT BE SCANNED	Is Mixed Size Original setting performed?	11-24
	Is unsupported combination of sizes used?	11-24
	Is the original orientation correct?	11-24
THIN PAPER CANNOT BE SCANNED	Is the paper thickness applicable?	11-25
THICK PAPER CANNOT BE SCANNED	Is the paper thickness applicable?	11-25



2-SIDED COPYING DOES NOT TAKE PLACE

✓ Check

Does the paper type setting of the selected tray specify a type of paper that cannot be used for 2-sided copying?

Are you using a special size or type of paper?

Are you copying using settings that do not allow 2-sided copying?

! Solution

■ Check "Paper Tray Settings" in the setting mode.
⇒ "Settings" → [System Settings] → [Common Settings] → [Paper Settings] → [Paper Tray Settings] → [Tray Registration] → [Feeding Approved Job]
Check the [Tray Settings] in the home screen.
Tap the selected tray, and in the screen that appears, tap the [Paper Property] key.
If the [Disable Duplex] checkbox in the paper properties screen is , the tray cannot be used for duplex printing. Change the paper type to a type that can be used for duplex printing.

■ For the paper types and sizes that can be used for two-sided copying, read "SPECIFICATIONS" in Start Guide.

■ 2-Sided Copy can generally be combined with other modes as required, however, some combinations are not possible. If a prohibited combination is selected, a message will appear in the touch panel.

ROTATE COPY DOES NOT WORK

✓ Check

Did you select the copy ratio manually?

Are you copying using settings that do not allow rotate copying?

Is "Rotation Copy Setting" disabled in the setting mode?

! Solution

■ Use automatic ratio selection when copying.

■ Rotate copying can generally be combined with other modes as required, however, some combinations are not possible. If a prohibited combination is selected, a message will appear in the touch panel.

■ Check with your administrator.
If you are the administrator, enable [Rotation Copy Setting].
⇒ Select [System Settings] → [Copy Settings] → [Condition Settings] → [Rotation Copy Setting] → [Rotation Copy] in "Settings".

ENLARGE/REDUCE DOES NOT WORK

✓ Check

Are the original, paper, and ratio settings correct?

! Solution

■ Check if the original size that appears on the screen is correct. After that, check if the correct paper is selected. Tap the [Ratio] key and then tap the [Auto Image] key. The appropriate ratio for the original and paper will appear.



THE IMAGE IS TOO LIGHT OR TOO DARK



Check

Is the image too light?

Is the image too dark?

Has an appropriate exposure mode for the original type been selected?



Solution

■ Select an appropriate exposure mode for the original being copied and adjust the exposure level manually.

- Select one of the following modes depending on the original type. (This can be set in normal mode.)
- **Text**
Use this mode for regular text documents.
 - **Text/Printed Photo**
This mode provides the best balance for copying an original which contains both text and printed photographs, such as a magazine or catalogue.
 - **Text/Photo**
This mode provides the best balance for copying an original which contains both text and photographs, such as a text document with a photo pasted on.
 - **Printed Photo**
This mode is best for copying printed photographs, such as photos in a magazine or catalogue.
 - **Photo**
Use this mode to copy photos.
 - **Map**
This mode is best for copying the light color shading and fine text found on most maps.
 - **Light Original**
Use this mode for originals with light pencil writing.

Is the overall copy density too light?

- Change the overall copy density with either method below.
- **Changing the default setting**
Select "Settings (administrator)" - [System Settings] → [Image Quality Adjustment] → [Copy Image Quality] → [Quick Image Quality Adjustment]. Set default setting [2] to [3 (Sharp)] to increase the overall density, or [1 (Smooth)] to decrease the overall density.
 - **Temporarily changing the setting**
Select Normal Mode (the setting cannot be changed in Easy Mode). In [Others] → [Quick Image Quality Adjustment], set default setting [2] to [3 (Sharp)] to increase the overall density, or [1 (Smooth)] to decrease the overall density. The setting is automatically reset when you return to the home screen.



PART OF THE IMAGE IS CUT OFF

Check

Has an appropriate ratio been selected for the original size and paper size?

Are you using an AB (inch) size original?

Solution

■ Select an appropriate ratio setting.

■ When copying an AB (inch) size original, specify the original size manually.

COPIES COME OUT BLANK

Check

Is the original placed face up or face down correctly?

Solution

■ When using the document glass, the original must be placed face down. When using the automatic document feeder, the original must be placed face up.

I WANT TO COPY MULTIPLE A4 PAGES ONTO ONE A4 SHEET OF PAPER

Check

Use N-Up.

Solution

■ N-Up lets you reduce and copy the images of up to eight A4 pages on one sheet. Tap the [N-Up] key. In normal mode, you can also add borders to N-Up copies.

MIXED SIZE ORIGINALS CANNOT BE SCANNED

Check

Is Mixed Size Original setting performed?

Is unsupported combination of sizes used?

Is the original orientation correct?

Solution

■ Perform the Mixed Size Original setting.

■ Check the supported combinations.

■ Place the original according to the instruction diagram in the Mixed Size Original screen.



THIN PAPER CANNOT BE SCANNED



Check

Is the paper thickness applicable?



Solution

■ Check the applicable paper thickness.

THICK PAPER CANNOT BE SCANNED



Check

Is the paper thickness applicable?



Solution

■ Check the applicable paper thickness.



PRINTING PROBLEMS



Have functions been disabled by the administrator?

Some functions may have been disabled in the setting mode. When user authentication is enabled, the functions that you can use may be restricted in your user settings. Check with your administrator.

CHECK LIST

Problem	Check	Page
PRINTING DOES NOT TAKE PLACE	Is your PC connected correctly to the machine?	11-27
	Is the machine connected to the same network (LAN, etc.) as your PC?	11-27
	Have you changed your network environment by replacing a computer or adding a new router?	11-27
	Is the IP address selected correctly? (Windows)	11-27
	Are you using a printer port created using Standard TCP/IP Port? (Windows)	11-27
	Is your computer in an unstable state?	11-27
	Is the machine specified correctly in the application that you are using for printing?	11-27
	Are the network connection devices operating normally?	11-28
	Is the I/O timeout setting too short?	11-28
	Was a Notice Page printed?	11-28
	Have functions been disabled by the administrator?	11-28
	Did you save settings in the Condition Settings that cannot be used with your current option configuration?	11-28
	I DON'T KNOW WHICH PRINTER DRIVER TO INSTALL	Check the features of each printer driver before installing.
I DON'T KNOW HOW TO CANCEL PRINTING	Follow the steps below to cancel printing	11-29
I DON'T KNOW HOW TO PRINT ON SPECIAL MEDIA	For special papers such as thin paper, use the bypass tray.	11-29
2-SIDED PRINTING DOES NOT TAKE PLACE	Does the paper type setting of the selected tray specify a type of paper that cannot be used for 2-sided printing?	11-30
	Are you using a special size or type of paper?	11-30
	Have functions been disabled by the administrator?	11-30
DIRECT PRINTING OF A FILE IN A SHARED FOLDER ON A COMPUTER IS NOT POSSIBLE	Is [IPsec Settings] enabled on the machine?	11-30
A TRAY, FINISHER, OR OTHER PERIPHERAL DEVICE INSTALLED ON THE MACHINE CANNOT BE USED	Have the peripheral devices that are installed on the machine been configured with the printer driver?	11-31
THE IMAGE IS GRAINY	Are the printer driver settings appropriate for the print job?	11-31
THE IMAGE IS TOO LIGHT OR TOO DARK	Is the overall print density too light?	11-31
	Does the image (particularly a photo) need correction? (Windows)	11-31
TEXT AND LINES ARE FAINT AND DIFFICULT TO SEE	Is the overall print density too light?	11-32
	Are there fine lines in the original data?	11-32
PART OF THE IMAGE IS CUT OFF	Does the paper size specified by the job match the size of paper loaded into the tray?	11-32
	Is the print orientation setting (portrait or landscape) correct?	11-32
	Are the margins set correctly in the layout settings of the application?	11-32



 Problem	 Check	Page
THE IMAGE IS UPSIDE DOWN	Are you using a type of paper (punch paper, etc.) that can only be loaded in a fixed orientation?	11-33
	Is the correct binding position selected for 2-sided printing?	11-33
MANY GARBLED CHARACTERS ARE PRINTED	Is your computer or the machine in an unstable state?	11-33
AFTER THE ROUTER WAS REPLACED, I CAN NO LONGER PRINT TO THE MACHINE	Does your computer connect to the machine?	11-34

PRINTING DOES NOT TAKE PLACE



Check

Is your PC connected correctly to the machine?

Is the machine connected to the same network (LAN, etc.) as your PC?

Have you changed your network environment by replacing a computer or adding a new router?

Is the IP address selected correctly? (Windows)

Are you using a printer port created using Standard TCP/IP Port? (Windows)

Is your computer in an unstable state?

Is the machine specified correctly in the application that you are using for printing?



Solution

■ Make sure that the cable is connected securely to the LAN connector of your PC and that of the machine.
If you are connecting to a network, make sure that the LAN cable is securely connected to the hub as well.
[SIDE AND BACK \(page 1-6\)](#)

■ The machine must be connected to the same network as your PC.
If you do not know which network the machine is connected to, ask the network administrator.

■ The connection to the computer may not be correct due to a change in IP address caused by replacing your computer or by a change in the network environment. Contact your network administrator to confirm that the settings between the machine and your computer or network environment are correct.

■ Check the IP address setting.
If the machine does not have a permanent IP address (the machine receives an IP address from a DHCP server), printing will not be possible if the IP address changes.
You can check the machine's IP address in [Network Status] of setting mode. If the IP address has changed, change the port setting in the printer driver.
⇒ "Settings" → [Status] → [Network Status]
See: Software Setup Guide
If the IP address changes frequently, it is recommended that a permanent IP address be assigned to the machine.
⇒ "Settings (administrator)" → [System Settings] → [Network Settings]

■ Check the PC settings.
When a port created with Standard TCP/IP Port in Windows is used and the [SNMP Status Enabled] checkbox is , it may not be possible to print correctly. Change the [SNMP Status Enabled] checkbox to .
See: Software Setup Guide

■ Restart your computer.
Printing is sometimes not possible when you run multiple applications at once or there is insufficient memory or local drive space. Restart your computer.

■ Check whether the machine's printer driver has been selected from the print window of the application.
If the machine's printer driver does not appear in the list of available printer drivers, it may not be installed correctly. Remove the printer driver and then install it once again.
See: Software Setup Guide



Check



Solution

Are the network connection devices operating normally?

- Make sure that the routers and other network connection devices are operating correctly.
If a device is not powered on or is in an error state, see the manual of the device to correct the problem.

Is the I/O timeout setting too short?

- Check with your administrator.
If the I/O timeout setting is too short, errors may occur while writing to the printer. Ask the administrator of the machine to configure an appropriate time in "I/O Timeout".
⇒ "Settings (administrator)" → [System Settings] → [Printer Settings] → [Condition Settings] → [I/O Timeout].

Was a Notice Page printed?

- Check the Notice Page.
A Notice Page will be printed to indicate the cause of the problem if a print job cannot be performed as specified and the cause is not shown in the display. Read the printed page and take appropriate actions.
For example, a Notice Page will be printed in the following situations.
 - The print job is too large to fit in memory.
 - A function that has been prohibited by the administrator is specified.By factory default, Notice Pages are not printed.

Have functions been disabled by the administrator?

- Check with your administrator.
When user authentication is enabled, the functions that you can use may be restricted in your user settings. Check with your administrator.

Did you save settings in the Condition Settings that cannot be used with your current option configuration?

- Initialize the Condition Settings.
If you change your option configuration after changing the Condition Settings, the Print Settings screen may not appear. Return to your original option configuration, or initialize the Condition Settings.
-



I DON'T KNOW WHICH PRINTER DRIVER TO INSTALL

Check

Check the features of each printer driver before installing.

Solution

- Each printer driver has specific features. Install and use the printer drivers that match your needs.
 - PCL6 printer driver
The machine supports the Hewlett-Packard PCL6 printer control languages. Prints fast and is good for regular print jobs.
 - PS printer driver
The PS printer driver supports the PostScript 3 page description language developed by Adobe Inc. Excellent reproduction of images that include fine graphics.
 - PPD driver
The PPD driver enables the machine to use the standard Windows PS printer driver.

I DON'T KNOW HOW TO CANCEL PRINTING

Check

Follow the steps below to cancel printing

Solution

- If the print data has not been spooled to the machine, refer to the manual for your operating system or application.
If the print data has been spooled to the machine, tap the [Job Status] key, the [Spool] key, or the [Job Queue] key, and select the job you want to delete from the list. Open the action panel and tap [Stop/Delete]. A message will appear to confirm the cancelation. Tap the [Cancel] key.

I DON'T KNOW HOW TO PRINT ON SPECIAL MEDIA

Check

For special papers such as thin paper, use the bypass tray.

Solution

- For special papers such as thin paper, set the paper in the bypass tray. After loading the media, set the paper size and paper in [Tray Settings] in the home screen. When you have completed the settings on the machine, set the "Original Size" and "Paper Size" appropriately on the [Main] tab of the printer driver.



2-SIDED PRINTING DOES NOT TAKE PLACE



Check

Does the paper type setting of the selected tray specify a type of paper that cannot be used for 2-sided printing?

Are you using a special size or type of paper?

Have functions been disabled by the administrator?



Solution

- Check "Paper Tray Settings" in the setting mode.
⇒ "Settings" → [System Settings] → [Common Settings] → [Paper Settings] → [Paper Tray Settings] → [Tray Registration] → [Feeding Approved Job]
Check the [Tray Settings] in the home screen.
Tap the selected tray, and in the screen that appears, tap the [Paper Property] key.
If the [Disable Duplex] checkbox in the paper properties screen is , the tray cannot be used for duplex printing. Change the paper type to a type that can be used for duplex printing.

- Check the paper types and sizes that can be used for two-sided copying.

- Check with your administrator.
Some functions may have been disabled in the setting mode. Check with your administrator.
When user authentication is enabled, the functions that you can use may be restricted in your user settings. Check with your administrator.

DIRECT PRINTING OF A FILE IN A SHARED FOLDER ON A COMPUTER IS NOT POSSIBLE



Check

Is [IPsec Settings] enabled on the machine?



Solution

- Check with your administrator.
When [IPsec Settings] is enabled in the setting mode, direct printing of a file in a shared folder may not be possible in your PC environment. For information about [IPsec Settings], consult your administrator.
⇒ "Settings" → [Security Settings] → [IPsec Settings]



A TRAY, FINISHER, OR OTHER PERIPHERAL DEVICE INSTALLED ON THE MACHINE CANNOT BE USED



Check

Have the peripheral devices that are installed on the machine been configured with the printer driver?



Solution

- Open the printer properties dialog box and click [Auto Configuration] on the [Options] tab. (Windows)
If auto configuration cannot be executed, see the Software Setup Guide.

THE IMAGE IS GRAINY



Check

Are the printer driver settings appropriate for the print job?



Solution

- Check the settings of the printer driver.
When selecting print settings, select a print mode from [600dpi], [600dpi (High Quality)], or [1200dpi]. When you need a very clear image, select [1200dpi].
Windows: The resolution setting is selected in the [Image Quality] tab of the printer driver properties window.
macOS: The resolution setting is configured in the [Printer Features] menu of the print window.

THE IMAGE IS TOO LIGHT OR TOO DARK



Check

Is the overall print density too light?



Solution

- Use the setting below to change the overall print density.
Select "Settings (administrator)" - [System Settings] → [Image Quality Adjustment] → [Print Image Quality] → [Quick Image Quality Adjustment]. Set default setting [2] to [3 (Sharp)] to increase the overall density, or [1 (Smooth)] to decrease the overall density.

Does the image (particularly a photo) need correction?
(Windows)

- Check the settings of the printer driver.
Correct brightness and contrast with [Image Adjustment] on the [Image Quality] tab of the printer driver. Use these settings to make simple corrections in a case such as when image editing software is not installed on your computer.



TEXT AND LINES ARE FAINT AND DIFFICULT TO SEE



Check

Is the overall print density too light?

Are there fine lines in the original data?



Solution

- Use the setting below to change the overall print density.
Select "Settings (Web version)" - [System Settings] → [Image Quality Adjustment] → [Print Image Quality] → [Quick Image Quality Adjustment]. Set default setting [2] to [3 (Sharp)] to increase the overall density, or [1 (Smooth)] to decrease the overall density.
- Change the width of specific printed lines.
Select "Settings (administrator)" - [System Settings] → [Image Quality Adjustment] → [Print Image Quality] → [Line Thickness]. Increase the value of default setting [5] to make the lines thicker, or decrease the value to make the lines thinner. (Text and raster data such as bitmap images cannot be changed.)

PART OF THE IMAGE IS CUT OFF



Check

Does the paper size specified by the job match the size of paper loaded into the tray?

Is the print orientation setting (portrait or landscape) correct?

Are the margins set correctly in the layout settings of the application?



Solution

- Make sure that the paper size setting matches the size of paper loaded into the tray.
Windows: The setting is selected in the [Paper Source] tab of the printer driver. If [Paper Tray] is selected, check the loaded paper and the paper size setting.
macOS: The setting is selected in the [Page Setup] menu.
- Set the print orientation to match the image.
Windows: The setting is selected in the [Main] tab of the printer driver.
macOS: The setting is selected in the [Page Setup] menu.
- Select an appropriate paper size and margins in the layout settings of the application.
If the edge of the image extends outside the printable area of the machine, the edge will be cut off.



THE IMAGE IS UPSIDE DOWN

Check

Are you using a type of paper (punch paper, etc.) that can only be loaded in a fixed orientation?

Is the correct binding position selected for 2-sided printing?

Solution

- Rotate the image 180 degrees before printing.
When the image size and paper size are the same but the orientations are different, the orientation of the image is automatically rotated to match the paper. However, when the paper can only be loaded in a fixed orientation, the image may be printed upside down. In this event, rotate the image 180 degrees before printing.
Windows: The setting is selected in "Orientation" on the [Main] tab of the printer driver.
macOS: The setting is selected in the [Layout] menu of the print window.
- Be sure to set the appropriate binding position.
When 2-sided printing is performed, every other page is printed upside down when tablet binding is selected for the binding position.
Windows: The setting is selected in the [Main] tab of the printer driver.
macOS: The setting is selected in the [Layout] menu of the print window.

MANY GARBLED CHARACTERS ARE PRINTED

Check

Is your computer or the machine in an unstable state?

Solution

- Cancel printing, restart your PC and the machine, and try printing again.
If there is only a small amount of free space remaining in the memory or local drive of your PC, or if a large number of jobs have been spooled on the machine and only a small amount of free space remains, text may be printed as garbled characters.
To cancel printing:
 - Windows:
Double-click the printer icon that appears at the lower right of the task bar and click "Cancel All Documents" (or "Purge Print Documents") in the [Printer] menu.
 - macOS:
Double-click the name of the machine in the printer list, select the job that you wish to delete, and delete it.
 - At the machine:
Tap the job status display on the operation panel, tap the [Print] tab to change the screen, tap the key of the print job that you wish to delete, and tap the [Stop/Delete] key. A message will appear to confirm the cancelation. Tap the [Cancel] key.If some printed characters are still garbled after restarting, ask your administrator to lengthen the timeout setting of [I/O Timeout] in the setting mode.
⇒ "Settings (administrator)" → [System Settings] → [Printer Settings] → [Condition Settings] → [I/O Timeout].
If garbled characters are being still printed after the above measures are taken, remove and then reinstall the printer driver.



AFTER THE ROUTER WAS REPLACED, I CAN NO LONGER PRINT TO THE MACHINE



Check

Does your computer connect to the machine?



Solution

- The network connection between the machine and your computer may not be working correctly. Check the machine's IP address and your computer's IP address, and make sure that your computer can connect to the machine. Also check if the correct "Print Port" is specified in your computer's driver settings.
- Check the IP address setting.

If the machine does not have a permanent IP address (the machine receives an IP address from a DHCP server), printing will not be possible if the IP address changes.

You can check the machine's IP address in [Network Status] of setting mode. If the IP address has changed, change the port setting in the printer driver.

⇒ "Settings" → [Status] → [Network Status]

See: Software Setup Guide

If the IP address changes frequently, it is recommended that a permanent IP address be assigned to the machine.

⇒ "Settings (administrator)" → [System Settings] → [Network Settings]
- Check if the correct print port is set on the computer.

Windows:
Click the [Start] button, select [Settings] → [Device] → [Devices and Printers]. (In Windows 11, click the [Start] button, select [Bluetooth & devices] → [Printers & scanners].) (In Windows 8.1/Windows Server 2012, right-click the [Start] button, select [Control Panel] → [View devices and printers] (or [Devices and Printers]).) (In Windows 7/Windows Server 2008, click the [Start] button, select [Devices and Printers].)

Select and then right-click the printer → [Printer properties] → [Port]

macOS:
Delete and then reinstall the printer.



FAX PROBLEMS

Have functions been disabled by the administrator?

Some functions may have been disabled in the setting mode. When user authentication is enabled, the functions that you can use may be restricted in your user settings. Check with your administrator.

CHECK LIST

 Problem	 Check	Page
TRANSMISSION DOES NOT TAKE PLACE	Is the telephone line connected securely?	11-36
	Is the correct dial mode set for your line?	11-36
	Is a busy signal received?	11-36
	Did a communication error occur?	11-36
	Does a message appear indicating that the memory is full?	11-37
	Does a message appear notifying you that the original size was not detected?	11-37
	Does the job status screen (completed jobs) or a transaction report indicate that the transmission was not successful?	11-37
	Did you place an original that is folded?	11-37
THE TRANSMITTED FAX PRINTS OUT BLANK AT THE RECEIVING SIDE	Are the sub-address and passcode correct? (When using F-code communication)	11-37
	Is the original placed face up or face down correctly?	11-37
THE TRANSMITTED FAX IS REDUCED BY THE RECEIVING FAX MACHINE	If the receiving machine is using thermal paper, was the thermal paper loaded with the wrong side out?	11-37
	Has the rotation sending been set?	11-38
TRANSMISSION DOES NOT BEGIN AT THE SPECIFIED TIME	Is the machine's clock set to the correct time?	11-38
	Is a transmission in progress?	11-38
PRINTING DOES NOT TAKE PLACE AFTER RECEPTION	Does a password entry screen appear?	11-39
	Has cut-off printing been disabled in the setting mode (administrator)?	11-39
	Is forwarding (Inbound Routing function) enabled for a received fax?	11-39
	Is the paper other than the size that can be printed by fax reception loaded?	11-39
MANUAL RECEPTION/POLLING RECEPTION ARE NOT POSSIBLE	Is little free memory remaining?	11-39
THE RECEIVED IMAGE IS FAINT	Is the original that was faxed also faint?	11-40
THE MACHINE DOES NOT BEGIN FAX RECEPTION	Has the reception mode been set to [Manual Reception] in the setting mode?	11-40
	Is little free memory remaining?	11-40
DIALING IS NOT POSSIBLE	Is the external telephone connected?	11-41
	Is the line busy?	11-41
YOU CANNOT TALK TO THE OTHER PARTY	Did you dial using the speaker?	11-41
AN ADDRESS (A ONE-TOUCH INDIVIDUAL KEY OR GROUP KEY) CANNOT BE STORED	Has the maximum number of keys been stored?	11-41
AN ADDRESS (A ONE-TOUCH INDIVIDUAL KEY OR GROUP KEY) CANNOT BE EDITED OR DELETED	Is the key being used in a reserved transmission or a transmission in progress?	11-42
	Have functions been disabled by the administrator?	11-42
	Has your administrator enabled a function that prevents editing/deleting?	11-42



Problem	Check	Page
I WANT TO CHECK THE SEND/RECEIVE HISTORY	Press the [Sending History] key. (Send history only)	11-42
	Check with the [Job Status] key.	11-42
I DON'T KNOW HOW TO FORWARD RECEIVED FAXES	Use the received fax forwarding settings in setting mode.	11-42
I DON'T KNOW HOW TO PREVIEW RECEIVED FAXES	Enable the image preview setting for received faxes in setting mode.	11-43
NOTIFICATION SOUNDS ARE TOO LOUD OR TOO SOFT, OR ARE NOT AUDIBLE (VOLUME ADJUSTMENT)	Have you adjusted the volume in the speaker settings of setting mode?	11-43
	You can adjust the volume of the original scan complete sound in the scan complete sound setting of setting mode.	11-43
I DON'T KNOW HOW TO STORE OR PRINT SENDER INFORMATION	You can store sender information in "Own Name and Destination Set" in setting mode.	11-43
BROADCAST TRANSMISSION DOES NOT WORK	Has broadcast setting been disabled in the setting mode (administrator)?	11-44
THE INFORMATION INDICATOR DOES NOT TURN OFF	Did you retrieve a received fax that was printed?	11-44
	Is an error preventing received faxes from being printed?	11-44
I DON'T KNOW HOW TO CHECK AN ADDRESS WHEN SENDING A FAX	Tap the [Address Review] key.	11-44
	Is "Fax Dest. Confirmation Mode" enabled in setting mode?	11-44

TRANSMISSION DOES NOT TAKE PLACE



Check

Is the telephone line connected securely?

Is the correct dial mode set for your line?

Is a busy signal received?

Did a communication error occur?



Solution

■ Check the telephone line socket, the wall socket, and any extension adapters to make sure that all connections are secure.

[SIDE AND BACK \(page 1-6\)](#)

■ Ask your administrator to verify that "Dial Mode Setting" is set correctly for the line you are using.

Select the telephone line type in "Dial Mode Setting" in the setting mode (administrator).

⇒ "Settings" → [System Settings] → [Image Send Settings]

→ [Fax Settings] → [Condition Settings] → [Dial Mode Setting]

■ If a busy signal is received, the transmission is temporarily canceled and then automatically attempted again after a brief interval. The factory default setting : Two attempts at 3-minute intervals.

⇒ "Settings" → [System Settings] → [Image Send Settings]

→ [Fax Settings] → [Send Setting] → [Recall in Case of Line Busy]

To cancel transmission, tap the job status display on the operation panel, tap the key of the job you want to delete, and tap [Stop/Delete] on the action panel. A message will appear to confirm the cancelation. Tap the [Cancel] key.

■ If an error occurs preventing transmission, the transmission is temporarily canceled and then automatically re-attempted after a brief interval.

⇒ "Settings (administrator)" → [System Settings] → [Image Send Settings] → [Fax Settings] → [Send Setting] → [Recall in Case of Communication Error]

To cancel transmission, tap the job status display on the operation panel, tap the key of the job you want to delete, and tap [Stop/Delete] on the action panel. A message will appear to confirm the cancelation. Tap the [Cancel] key.

The machine supports error correction mode (ECM) and is configured to automatically resend any part of a fax that is distorted due to noise on the line.

⇒ "Settings" → [System Settings] → [Image Send Settings] → [Fax Settings] → [Condition Settings] → [ECM]



Check

Does a message appear indicating that the memory is full?

Does a message appear notifying you that the original size was not detected?

Does the job status screen (completed jobs) or a transaction report indicate that the transmission was not successful?

Did you place an original that is folded?

Are the sub-address and passcode correct? (When using F-code communication)



Solution

■ Divide the originals into sets and fax each set separately, or use direct transmission.
If the memory becomes full, the transmission will be canceled.

■ Place the original again.
If the original size is still not detected correctly, specify the original size manually.

■ Perform the transmission again.
If the transmission is still not successful after recalling is performed as set in [Recall in Case of Line Busy] or [Recall in Case of Communication Error], the transmission failure will be indicated in the job status screen and the transaction report.

■ Following the instructions in the display, unfold the original, place it in the automatic document feeder again, and re-scan it.
If a folded original is placed in the automatic document feeder, an error will occur and scanning will be canceled when the actual original size is detected during scanning.

■ Check with the operator of the other machine to make sure that the sub-address and passcode are correct.

THE TRANSMITTED FAX PRINTS OUT BLANK AT THE RECEIVING SIDE



Check

Is the original placed face up or face down correctly?

If the receiving machine is using thermal paper, was the thermal paper loaded with the wrong side out?



Solution

■ Place the original again in the correct orientation, and resend.
When using the document glass, the original must be placed face down. When using the automatic document feeder, the original must be placed face up. Place the original correctly and send the fax again.

■ Check with the operator of the other machine.



THE TRANSMITTED FAX IS REDUCED BY THE RECEIVING FAX MACHINE



Check

Has the rotation sending been set?



Solution

- Enable "Rotation Sending Setting" before transmission.
When [Rotation Sending Setting] is not enabled (the image is not rotated), an original placed in the vertical orientation may be reduced by the receiving machine.
⇒ "Settings" → [System Settings] → [Image Send Settings] → [Fax Settings] → [Send Setting] → [Rotation Sending Setting] → If "Mixed Size Original" is enabled in Others and an original with a different width is sent, rotate transmission will be disabled.

TRANSMISSION DOES NOT BEGIN AT THE SPECIFIED TIME



Check

Is the machine's clock set to the correct time?



Solution

- Set the clock to the correct time.
⇒ "Settings" → [System Settings] → [Common Settings] → [Device Control] → [Clock]
- If another transmission is in progress when the specified time arrives, the timer operation will begin after that transmission is finished.



PRINTING DOES NOT TAKE PLACE AFTER RECEPTION



Check

Does a password entry screen appear?

Has cut-off printing been disabled in the setting mode (administrator)?

Is forwarding (Inbound Routing function) enabled for a received fax?

Is the paper other than the size that can be printed by fax reception loaded?



Solution

- Enter the correct password using the numeric keys.
[Hold Setting for Received Data Print] is enabled. If you do not know the password, check with your administrator.
⇒ "Settings (administrator)" → [System Settings] → [Image Send Settings] → [Common Settings] → [Condition Settings] → [Hold Setting for Received Data Print]
- Load the same size of paper as the received fax.
If [Print Actual Size Cut off Disabled] is enabled in [Print Style Setting] in the setting mode (administrator) and a fax is received that is larger than any paper that is loaded, the fax will be received and stored in memory without being printed. (However, when a fax longer than A3 (11" x 17") size is received, it will be printed using multiple sheets of paper.)
⇒ "Settings" → [System Settings] → [Image Send Settings] → [Fax Settings] → [Receive Settings] → [Print Style Setting]
- If you need to print a received fax, ask your administrator.
When the Inbound Routing function is enabled, received faxes are automatically forwarded to a specified address. If [Print at Error] is selected when Inbound Routing is enabled, received faxes will only be printed when an error occurs.
⇒ "Settings (administrator)" → [Image Send Settings] → [Inbound Routing (Forwarding/Storing) Settings] → [Administration Settings] → [Inbound Routing Settings]
- If the paper other than the size with 5-1/2" x 8-1/2"R, 8-1/2" x 11", 8-1/2" x 11"R, 8-1/2" x 13", 8-1/2" x 13-2/5", 8-1/2" x 14", 11" x 17", A4, A4R is loaded in the machine, printing does not take place even if a fax is received. Load the papers of the above size.

MANUAL RECEPTION/POLLING RECEPTION ARE NOT POSSIBLE



Check

Is little free memory remaining?



Solution

- If any of the following applies, print or delete received faxes to increase available memory space for receiving faxes.
 - The memory contains data that has been received with the received image check setting enabled.
 - The memory contains data that has been received with confidential reception or that is protected by a password.
 - A fax is stored in the memory box.



THE RECEIVED IMAGE IS FAINT



Check

Is the original that was faxed also faint?



Solution

- Ask the other party to send the fax again using a suitable (darker) exposure setting.

THE MACHINE DOES NOT BEGIN FAX RECEPTION



Check

Has the reception mode been set to [Manual Reception] in the setting mode?



Solution

- Set the reception mode to [Auto Reception].
When the reception mode is set to [Manual Reception], the machine will not receive faxes automatically.
- "Settings (administrator)" → [System Settings] → [Image Send Settings] → [Fax Data Receive/Forward (Manual)] → [Receive Settings]
When [Switching from Manual to Automatic Reception] is selected in setting mode and a fax is received in manual reception mode, the machine will automatically switch to automatic reception after the specified number of rings and receive the fax.
Ask your administrator to enable this setting.
- Increase the amount of free memory.
 - The memory contains data that has been received with the received image check setting enabled.
 - The memory contains data that has been received with confidential reception or that is protected by a password.
 - A fax is stored in the memory box.

Is little free memory remaining?



DIALING IS NOT POSSIBLE

Check

Is the external telephone connected?

Solution

■ Check the connections.
Check the telephone line socket, the wall socket, and any extension adapters to make sure that all connections are secure.

Is the line busy?

■ Wait until the communication is completed.

YOU CANNOT TALK TO THE OTHER PARTY

Check

Did you dial using the speaker?

Solution

■ Use the external telephone.
When you dial using the speaker, you will be able to hear the voice of the other party, but he or she will not hear your voice. Use the external telephone. (When the external telephone is not installed, you cannot talk to the other party.)

AN ADDRESS (A ONE-TOUCH INDIVIDUAL KEY OR GROUP KEY) CANNOT BE STORED

Check

Has the maximum number of keys been stored?

Solution

■ Adjust the number of stored keys.
Delete addresses (one-touch keys and group keys) that are not being used.



AN ADDRESS (A ONE-TOUCH INDIVIDUAL KEY OR GROUP KEY) CANNOT BE EDITED OR DELETED



Check

Is the key being used in a reserved transmission or a transmission in progress?

Have functions been disabled by the administrator?

Has your administrator enabled a function that prevents editing/deleting?



Solution

■ Wait until the transmission is finished or cancel the reserved transmission and then edit or delete the key.

■ Check with your administrator.
Some functions may have been disabled in the setting mode.

■ Check with your administrator.
If your administrator has enabled settings such as [Inbound Routing Settings], keys cannot be edited or removed.
⇒ "Settings (administrator)" → [Image Send Settings]
→ [Inbound Routing (Forwarding/Storing) Settings] → [Inbound Routing Settings]

I WANT TO CHECK THE SEND/RECEIVE HISTORY



Check

Press the [Sending History] key.
(Send history only)

Check with the [Job Status] key.



Solution

■ Tap the [Sending History] key (Easy Fax mode) to show the send history. In normal mode, tap the [Sending History] key on the action panel.

■ Tap the [Job Status] key and tap the [Fax] tab to check the status of fax jobs. To check previous send or receive histories, tap the [Complete] key. To print communication results, open the action panel and tap [Print Image Sending Activity Report].

I DON'T KNOW HOW TO FORWARD RECEIVED FAXES



Check

Use the received fax forwarding settings in setting mode.



Solution

■ You can forward received faxes to a forwarding destination set in advance. Enable [Inbound Routing Settings] in "Settings (administrator)"
- [System Settings] → [Image Send Settings]
→ [Inbound Routing (Forwarding/Storing) Settings] → [Administration Settings].
Tap [Add] and set the forwarding destination and forwarding conditions. When the settings are completed, received faxes will be forwarded according to the set conditions.



I DON'T KNOW HOW TO PREVIEW RECEIVED FAXES

Check

Enable the image preview setting for received faxes in setting mode.

Solution

- You can forward received faxes to a forwarding destination set in advance. Enable [Received Data Image Check Setting] in "Settings (administrator)" - [System Settings] → [Image Send Settings] → [Common Settings] → [Condition Settings].
When a fax is received, tap the icon that appears next to the [Job Status] key at the top of the screen. In the system information screen that appears, tap the [Event Information] tab and tap the [Check Fax Reception Image] key. Tap the key of the received fax that you want to check, and tap [Check Image] on the action panel to show a preview of the fax.

NOTIFICATION SOUNDS ARE TOO LOUD OR TOO SOFT, OR ARE NOT AUDIBLE (VOLUME ADJUSTMENT)

Check

Have you adjusted the volume in the speaker settings of setting mode?

Solution

- Adjust the on-hook volume, ringing volume, line monitor volume, send/receive completion volume, and send/receive error volume in "Settings (administrator)".
⇒ "Settings (administrator)" → [System Settings] → [Common Settings] → [Sound Settings] → [Beep Sound Settings (Image Send)]
- A complete sound is heard when scanning of the original is completed. In "Settings (administrator)", select [System Settings] → [Common Settings] → [Sound Settings] → [Beep Sound Settings (Common)] → [Scan Complete Sound (Image Send)] to adjust the volume.

I DON'T KNOW HOW TO STORE OR PRINT SENDER INFORMATION

Check

You can store sender information in "Own Name and Destination Set" in setting mode.

Solution

- To store sender information, select "Settings (administrator)" - [System Settings] → [Image Send Settings] → [Common Settings] → [Own Name and Destination Set].



BROADCAST TRANSMISSION DOES NOT WORK

Check

Has broadcast setting been disabled in the setting mode (administrator)?

Solution

- Broadcast transmission cannot be performed when "Settings (administrator)" - [System Settings] → [Image Send Settings] → [Fax Settings] → [Send Setting] → [Disable Fax Broadcasting] is disabled.

THE INFORMATION INDICATOR DOES NOT TURN OFF

Check

Did you retrieve a received fax that was printed?

Solution

- The data notification indicator blinks until received faxes are retrieved.

Is an error preventing received faxes from being printed?

- The information indicator blinks in white until the received fax print is removed. Clear the error that is preventing printing.

I DON'T KNOW HOW TO CHECK AN ADDRESS WHEN SENDING A FAX

Check

Tap the [Address Review] key.

Solution

- Tap the [Address Review] key to view a list of the addresses.

Is "Fax Dest. Confirmation Mode" enabled in setting mode?

- Enable "Settings (administrator)" - [System Settings] → [Image Send Settings] → [Fax Settings] → [Condition Settings] → [Fax Dest. Confirmation Mode]. When this setting is enabled, an address confirmation message will appear when you send a fax to prevent erroneous transmission.





IMAGE SEND PROBLEMS

Have functions been disabled by the administrator?

Some functions may have been disabled in the setting mode. When user authentication is enabled, the functions that you can use may be restricted in your user settings. Check with your administrator.

CHECK LIST

 Problem	 Check	Page
TRANSMISSION DOES NOT TAKE PLACE	Did you select the correct destination (destination information)? Is the correct information (e-mail address or FTP server information) stored for that destination?	11-46
	Does the image file exceed the e-mail attachment limit set in the setting mode (administrator)?	11-46
	Did the image file exceed the file attachment size limit of your mail server?	11-46
	Has the folder on the destination computer been set as a shared folder so that files can be sent to it?	11-46
	Is [IPsec Settings] enabled on the machine?	11-46
	Did you place an original that is folded?	11-46
	Are both direct SMTP addresses and other addresses set as destinations?	11-47
AUTO SELECTION OF THE COLOR MODE DOES NOT TAKE PLACE CORRECTLY	Are you scanning one of the following types of originals?	11-47
THE RECEIVED IMAGE FILE CANNOT BE OPENED	Does the viewer program used by the recipient support the format of the received image data?	11-47
	Does a message appear prompting you to enter your password?	11-47
I DON'T KNOW HOW TO SPECIFY THE ORIGINAL/SEND SIZE	Are you using Easy mode?	11-47
TRANSMISSION TAKES A LONG TIME	Is the resolution setting appropriate at the time of scanning?	11-48
A DESTINATION IS PRE-SELECTED	Is [Default Address Setting] enabled in the setting mode?	11-48
THE SCANNED IMAGE IS CLIPPED	Is the original scan size setting smaller than the actual original size?	11-49
THE QUALITY OF THE SCANNED IMAGE IS POOR	Is the original printed matter such as a book or magazine?	11-49
	When scanning a color or grayscale original, is the color mode set to [Mono2]?	11-49
	Are Internet fax addresses included in the transmission?	11-49
	Is the resolution setting too low?	11-49
	Is the compression ratio too high?	11-49
THE SCANNED IMAGE IS BLANK	Is the original placed face up or face down correctly?	11-50
THE SCANNED IMAGE IS UPSIDE DOWN OR ON ITS SIDE	Are Internet fax addresses included in the transmission?	11-50
JPEG WAS SELECTED FOR THE FILE TYPE BUT THE FILE WAS CREATED AS A TIFF FILE	Did you select [Mono2] in color mode?	11-50
THE FILE SIZE IS LARGE	Was the color mode set to [Grayscale] when you scanned a monochrome original?	11-51
	Is the resolution setting too high?	11-51
	Is the compression ratio too low?	11-51
AN ADDRESS (A ONE-TOUCH INDIVIDUAL KEY OR GROUP KEY) CANNOT BE STORED	Has the maximum number of keys been stored?	11-51



Problem	Check	Page
AN ADDRESS (A ONE-TOUCH INDIVIDUAL KEY OR GROUP KEY) CANNOT BE EDITED OR DELETED	Is the key being used in a reserved transmission or a transmission in progress?	11-51
	Has your administrator enabled a function that prevents editing/deleting?	11-51
I WANT TO CHANGE THE FORMAT OR COMPRESSION OF A SCANNED IMAGE	Use the [Format] key.	11-52
I DON'T KNOW HOW TO CHECK AN ADDRESS WHEN SENDING AN IMAGE	Tap the [Address Review] key.	11-52
AFTER THE ROUTER WAS REPLACED, I CAN'T USE SCAN TO NETWORK FOLDER OR SCAN	Has the machine's IP address been changed?	11-52

TRANSMISSION DOES NOT TAKE PLACE

Check	Solution
Did you select the correct destination (destination information)? Is the correct information (e-mail address or FTP server information) stored for that destination?	<ul style="list-style-type: none"> ■ Make sure that the correct information is stored for the destination and that the destination is correctly selected. If delivery by e-mail (Scan to E-mail) is unsuccessful, an error message such as "Undelivered Message" may be sent to the designated administrator's e-mail address. This information may help you determine the cause of the problem.
Does the image file exceed the e-mail attachment limit set in the setting mode (administrator)?	<ul style="list-style-type: none"> ■ Check with your administrator. If your administrator has set a limit on the size of transmitted files, a file that exceeds the limit cannot be transmitted.
Did the image file exceed the file attachment size limit of your mail server? (When Scan to E-mail is used)	<ul style="list-style-type: none"> ■ Reduce the size of the file attachment (reduce the number of pages to scan) for one e-mail transmission. The size of the file can also be reduced by scanning using a lower resolution setting. Ask your mail server administrator (or Internet service provider, etc.) what the file size limit is for one e-mail transmission. ■ When [Send Destination Link] is selected, the data is saved to the machine's local drive, and a URL link to the saved data is sent by e-mail to the destination. The recipient uses the link to download the file. Because this method is not affected by mail server restrictions, you can use it in instances such as when you cannot reduce the size of the file.
Has the folder on the destination computer been set as a shared folder so that files can be sent to it? (When using Scan to Network Folder)	<ul style="list-style-type: none"> ■ If the destination folder is not configured as a shared folder, select "Sharing" in the folder properties. If the folder was moved or otherwise changed, the "Sharing" setting may have been canceled.
Is [IPsec Settings] enabled on the machine? (When using Scan to Network Folder)	<ul style="list-style-type: none"> ■ Check with your administrator. When [IPsec Settings] is enabled in setting mode, it may not be possible to scan to a shared folder in some computer environments. ⇒ "Settings (administrator)" → [System Settings] → [Security Settings] → [IPsec Settings]
Did you place an original that is folded?	<ul style="list-style-type: none"> ■ Following the instructions in the display, unfold the original, place it in the automatic document feeder again, and re-scan it. If a folded original is placed in the automatic document feeder, an error will occur and scanning will be canceled when the actual original size is detected during scanning.



Check

Are both direct SMTP addresses and other addresses set as destinations?



Solution

- Broadcast transmission to both direct SMTP addresses and other addresses is not possible.
Send to direct SMTP addresses and other addresses separately.

AUTO SELECTION OF THE COLOR MODE DOES NOT TAKE PLACE CORRECTLY



Check

Are you scanning one of the following types of originals?

When Black & White is not selected:

- Are there colors or coloring in the paper?

When Color is not selected:

- Is the color in the original very light?
- Is the color in the original very dark, almost black?
- Is only a very small area of the original colored?



Solution

- Specify the color mode manually.
When the color mode is set to [Auto], the machine detects whether the original is black and white or color when the [Color Start] key is tapped; however, in the cases as shown on the left, automatic detection may not give the correct result.

THE RECEIVED IMAGE FILE CANNOT BE OPENED



Check

Does the viewer program used by the recipient support the format of the received image data?



Solution

- Use a software program that is capable of opening the selected file type and compression mode.
The recipient may be able to open the file if you change the file type and compression mode selected at the time of transmission.
- Ask the sender for the password, or have the image sent again in a non-encrypted format.
The received file is an encrypted PDF file.

Does a message appear prompting you to enter your password?

I DON'T KNOW HOW TO SPECIFY THE ORIGINAL/SEND SIZE



Check

Are you using Easy mode?



Solution

- Use normal mode to set the original size and send size. Tap the [Original] key in the base screen of normal mode. Specify the scan size (original size), and specify the send size that will be received at the destination.



TRANSMISSION TAKES A LONG TIME

Check

Is the resolution setting appropriate at the time of scanning?

Solution

■ Select resolution and data compression settings that are suited to the purpose of transmission.

To create image data that is balanced in terms of resolution and file size, pay attention to the following points:

Resolution modes:

The default resolution setting is [200x200dpi] in "E-Mail", "FTP/Desktop", "Network Folder", and "Scan to External Memory Device", and [200x100dpi] in Internet fax mode. If the original does not contain a halftone image such as a photo or illustration, scanning at the default resolution will create a more practical and useful image. A higher resolution setting or the "Half Tone" setting (in Internet fax mode only) should only be selected if the original contains a photo and you wish to give priority to the quality of the photo image. Exercise caution in this case as a larger file will be created than when the default setting is used.

A DESTINATION IS PRE-SELECTED

Check

Is [Default Address Setting] enabled in the setting mode?

Solution

■ If you wish to send to a destination other than the default destination, tap the [Cancel] key.

If you are the administrator and wish to change or disable the default destination, change the settings as appropriate in [Default Address Setting].

⇒ "Settings (administrator)" → [System Settings] → [Image Send Settings] → [Scan Settings] → [Default Address] → [Default Address Setting]



THE SCANNED IMAGE IS CLIPPED



Check

Is the original scan size setting smaller than the actual original size?



Solution

- Set the scan size to the actual original size.
If you have intentionally set a smaller size than the actual original size, place the original considering the reference placement position for the selected scan size. For example, when scanning an A4 (8-1/2" x 11") original using a B5 (5-1/2" x 8-1/2") setting on the document glass, align the original using the document glass scale at the left edge to fit the area you wish to scan into the B5 (5-1/2" x 8-1/2") scanning area.

THE QUALITY OF THE SCANNED IMAGE IS POOR



Check

Is the original printed matter such as a book or magazine?



Solution

- To reduce the moire effect, take the following procedure:
When the original is printed matter, vertical patterns (moire) may occur. Select [Others] → [Sharpness] in the Base Screen of normal mode and soften the edges of image to reduce the moire effect (only in "E-Mail", "FTP/Desktop", "Network Folder", and "Scan to External Memory Device"). It may also be possible to reduce the moire effect by changing the resolution setting or shifting the original (or changing its angle) slightly on the document glass.
- Setting the color mode to [Mono2] replaces the colors in the original with either black or white. This is suitable for text-only originals; however, for originals that contain illustrations, it is best to use the [B/W Start] key with the color mode set to [Grayscale], or set the color mode of the [Color Start] key to [Full Color] or [Grayscale] and then scan.
- If you wish to send an image scanned at high resolution to destinations for "E-Mail", "FTP/Desktop", and "Network Folder", send the image to scanner and Internet fax destinations separately.
- A low resolution setting results in a coarser image.
Increasing the resolution setting produces a smoother image. (The higher the resolution, the larger the file size.)
- If the compression ratio is set to a high value when "Color Mode" transmission is set to full color or grayscale, noise may be noticeable and colors may appear dull. Set [File Format] → "Compression Ratio" to a lower value to reduce noise and dulling of color. (The lower the compression ratio, the larger the file size.)
This is set in Normal Mode.

When scanning a color or grayscale original, is the color mode set to [Mono2]?

Are Internet fax addresses included in the transmission?

Is the resolution setting too low?

Is the compression ratio too high?



THE SCANNED IMAGE IS BLANK

Check

Is the original placed face up or face down correctly?

Solution

- Place the original again in the correct orientation, and resend. When using the document glass, the original must be placed face down. When using the automatic document feeder, the original must be placed face up.

THE SCANNED IMAGE IS UPSIDE DOWN OR ON ITS SIDE

Check

Are Internet fax addresses included in the transmission?

Solution

- Send the image to the scan mode and Internet fax mode destinations separately. When destinations for "E-Mail", "FTP/Desktop", and "Network Folder" and Internet fax destinations are included in a broadcast transmission, the original transmission orientation of Internet fax takes precedence, and thus the file may not appear in the correct orientation when viewed on a PC.

JPEG WAS SELECTED FOR THE FILE TYPE BUT THE FILE WAS CREATED AS A TIFF FILE

Check

Did you select [Mono2] in color mode?

Solution

- Change the color mode to [Full Color] or [Grayscale], and then tap the [Start] key. When [JPEG] is selected for the file type and the image is scanned in Mono2, the file will be created as a TIFF file.



THE FILE SIZE IS LARGE

Check

Was the color mode set to [Grayscale] when you scanned a monochrome original?

Is the resolution setting too high?

Is the compression ratio too low?

Solution

■ [Grayscale] is suitable when you want a high-quality image of text or a photo, but the file size will be larger. Using [Mono2] for a text-only original will significantly reduce the file size. This is set in Normal Mode.

■ The higher the resolution setting, the larger the file size. Lowering the resolution results in a coarser image, but produces a smaller file size.

■ If the compression ratio is set to a low value when Color Mode is set to [Full Color] or [Grayscale], the file size will be large. If [File Format] → [Compression Ratio] is set to a higher value, noise may become noticeable and colors may appear duller, but the file size will be smaller. This is set in Normal Mode.

AN ADDRESS (A ONE-TOUCH INDIVIDUAL KEY OR GROUP KEY) CANNOT BE STORED

Check

Has the maximum number of keys been stored?

Solution

■ Adjust the number of stored keys.
Delete addresses (one-touch keys and group keys) that are not being used.

AN ADDRESS (A ONE-TOUCH INDIVIDUAL KEY OR GROUP KEY) CANNOT BE EDITED OR DELETED

Check

Is the key being used in a reserved transmission or a transmission in progress?

Has your administrator enabled a function that prevents editing/deleting?

Solution

■ Wait until the transmission is finished or cancel the reserved transmission and then edit or delete the key.

■ Check with your administrator.
If your administrator has enabled settings such as [Default Address Setting] and [Inbound Routing Settings], keys cannot be edited or removed.



I WANT TO CHANGE THE FORMAT OR COMPRESSION OF A SCANNED IMAGE

Check

Use the [Format] key.

Solution

- You can use the [Format] key to set the format and compression percentage of a file to be saved or sent. In normal mode, you can create a file of a number of original pages
[Specified Pages per File] can be used.

I DON'T KNOW HOW TO CHECK AN ADDRESS WHEN SENDING AN IMAGE

Check

Tap the [Address Review] key.

Solution

- Tap the [Address Review] key to view a list of the addresses.

AFTER THE ROUTER WAS REPLACED, I CAN'T USE SCAN TO NETWORK FOLDER OR SCAN

Check

Has the machine's IP address been changed?

Solution

- Check the IP address setting.
If the machine does not have a permanent IP address (the machine receives an IP address from a DHCP server), scanning to network folder or scanning will not be possible if the IP address changes.
You can check the machine's IP address in [Network Status] of setting mode. If the IP address has changed, change the port setting in the printer driver.
⇒ "Settings" → [Status] → [Network Status]
See: Software Setup Guide
If the IP address changes frequently, it is recommended that a permanent IP address be assigned to the machine.
⇒ "Settings (administrator)" → [System Settings] → [Network Settings]



DOCUMENT FILING PROBLEMS

Have functions been disabled by the administrator?

Some functions may have been disabled in the setting mode. When user authentication is enabled, the functions that you can use may be restricted in your user settings. Check with your administrator.

CHECK LIST

Problem	Check	Page
DOCUMENT FILING DOES NOT TAKE PLACE	Did you enable document filing in the printer driver?	11-53
A JOB CANNOT BE STORED IN A CUSTOM FOLDER	Do the custom folders created with the machine appear in "Folder Information"? (When printing)	11-54
	Does the custom folder have a PIN Code?	11-54
A STORED FILE HAS DISAPPEARED	Did you enable the [Delete] checkbox to print a stored file?	11-54
	Has automatic deletion of document filing files been enabled?	11-54
A FILE CANNOT BE DELETED	Is the property of the file set to [Protect]?	11-54
THE PROPERTY OF A FILE CANNOT BE SET TO [Confidential]	Is the file in the Quick File folder?	11-55
A CONFIDENTIAL FILE OR CONFIDENTIAL FOLDER CANNOT BE OPENED	Did you enter the wrong password/PIN Code?	11-55
I CAN'T STORE OR CHANGE A FILE NAME OR CUSTOM FOLDER NAME	Does the name include characters that cannot be used in a file or folder name?	11-55
A FILE NAME IS CUT OFF	Was the file name stored in the advanced transmission settings during a scan or Internet fax transmission?	11-55
I DON'T KNOW HOW TO SCAN TO USB MEMORY	Did you insert the USB memory device?	11-56
	Did you select [Scan to USB] in [Scan to USB/Local Drive] of Easy Scan mode?	11-56
	Did you select [Scan to External Memory Device] in Document Filing mode?	11-56
I DON'T KNOW TO PRINT BY USB DIRECT PRINT	Did you insert the USB memory device?	11-56
	Did you select [Select File from USB Memory to Print] in Document Filing mode?	11-56

DOCUMENT FILING DOES NOT TAKE PLACE



Check

Did you enable document filing in the printer driver?



Solution

- Enable document filing.
In print mode, enable document filing on the [Job Handling] tab of the printer driver.
In other than print mode, specify Document Filing settings from Quick File or File.



A JOB CANNOT BE STORED IN A CUSTOM FOLDER

Check

Do the custom folders created with the machine appear in "Folder Information"?
(When printing)

Does the custom folder have a PIN Code?

Solution

■ Click the [Get Folder Name] button in the document filing save screen of the printer driver to call up the custom folders that have been created on the machine.

■ Enter the PIN Code configured in the machine in the document filing save screen.

A STORED FILE HAS DISAPPEARED

Check

Did you enable the [Delete] checkbox to print a stored file?

Has automatic deletion of document filing files been enabled?

Solution

■ If you print the file by enabling the [Delete] checkbox, the file is automatically deleted after being printed.
The file property can be set to [Protect] to prevent the file from being easily deleted.

■ If files that you need have been deleted, consult the administrator of the machine. When [Automatic Deletion of File Settings] is enabled in the setting mode, the files in the specified folders are periodically deleted. (Even when the file property is [Confidential] or [Protect], the file may be deleted.)
⇒ "Settings (administrator)" → [System Settings] → [Document Filing Settings] → [Automatic Deletion of File Settings]

A FILE CANNOT BE DELETED

Check

Is the property of the file set to [Protect]?

Solution

■ A file cannot be deleted when its property is set to [Protect].
Change the file property from [Protect] to [Sharing] and then delete the file.



THE PROPERTY OF A FILE CANNOT BE SET TO [Confidential]



Check

Is the file in the Quick File folder?



Solution

- Move the file to a different folder and then set its property to "Confidential". [Confidential] cannot be specified for a file in the Quick File folder. (Note that [Protect] can be specified for a file in the Quick File folder to prevent it from being easily deleted.)

A CONFIDENTIAL FILE OR CONFIDENTIAL FOLDER CANNOT BE OPENED



Check

Did you enter the wrong password/PIN Code?



Solution

- Check with your administrator.

I CAN'T STORE OR CHANGE A FILE NAME OR CUSTOM FOLDER NAME



Check

Does the name include characters that cannot be used in a file or folder name?



Solution

- The following characters cannot be used in a file or folder name:
? / " : < > * \ |

A FILE NAME IS CUT OFF



Check

Was the file name stored in the advanced transmission settings during a scan or Internet fax transmission?



Solution

- If the name was stored in the advanced transmission settings before Quick File or File settings were configured, that name will be used for the stored file. If the number of characters in the name exceeds the maximum number of characters allowed for a Quick File name (30 characters), characters after the 30th character will be discarded.



I DON'T KNOW HOW TO SCAN TO USB MEMORY



Check

Did you insert the USB memory device?

Did you select [Scan to USB] in [Scan to USB/Local Drive] of Easy Scan mode?

Did you select [Scan to External Memory Device] in Document Filing mode?



Solution

■ When you insert a USB memory device in the machine, a message will appear. To scan to USB memory, tap the [Scan to External Memory Device] key. The external memory device screen set in Easy Scan mode appears. Place the original and tap the [Start] key to scan the document into the USB memory device. You can select the [Perform Detail Setting] checkbox to select detailed save settings.

■ When [Scan to USB] is selected in [Scan to USB/Local Drive] of Easy Scan mode, the scanned document will be saved to the connected USB memory device.

■ When [Scan to External Memory Device] is selected on the action panel of Document Filing mode, the scanned document will be saved to the connected USB memory device.

I DON'T KNOW TO PRINT BY USB DIRECT PRINT



Check

Did you insert the USB memory device?

Did you select [Select File from USB Memory to Print] in Document Filing mode?



Solution

■ When you insert a USB memory device in the machine, a message will appear. To perform USB Direct Print, tap the [Print from external memory device (USB)] key.

■ Tap [Select File from USB Memory to Print] on the action panel of Document Filing mode.



REMOVING MISFEEDS

REMOVING MISFEEDS

If a paper misfeed occurs, the "Paper Jam" message will appear in the touch panel and printing and scanning will stop. In this event, tap the [Check how to remove misfeeds] key in the touch panel.

When the key is tapped, instructions for removing the misfeed will appear. Follow the instructions. When the misfeed is cleared, the message will automatically disappear.

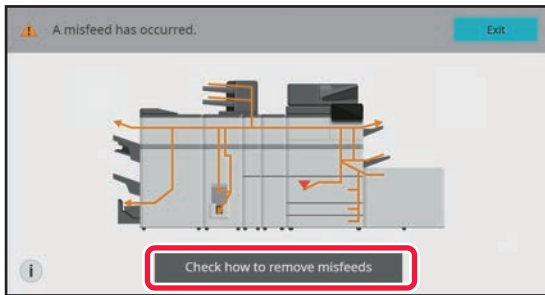

- The fusing unit and paper output area are hot.
- When removing a misfeed, do not touch the fusing unit. You may burn yourself.

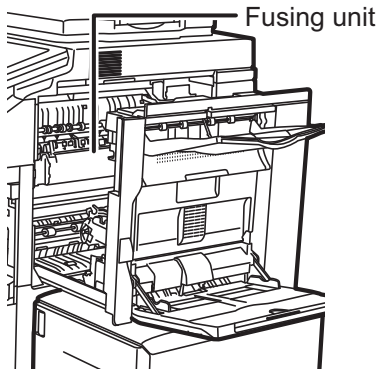



APPENDIX

SPECIFICATIONS

SPECIFICATIONS 12-2



SPECIFICATIONS

SPECIFICATIONS

Basic Specifications / Copier Specifications

Name	BP-70M75/BP-70M90
Type	Console
Color	Monochrome
Copier system	Laser electrostatic copier
Scanning resolution	Scan: 600 × 600 dpi, 600 × 400 dpi, 600 × 300 dpi* Print: 1200 × 1200 dpi, 600 × 600 dpi, equivalent to 9600 dpi × 600dpi * Only when using an automatic document feeder
Gradation	Scan: equivalent to 256 levels Print: equivalent to 256 levels
Original paper sizes	Max. 11" x 17" (A3) for sheets and bound documents
Copy sizes	12" x 18" to 5-1/2" x 8-1/2"R (A3W to A6R), Main tray 1/2: 8-1/2" x 11", A4 Main tray 3: 12" x 18", 11" x 17", 8-1/2" x 14", 8-1/2" x 13-1/2", 8-1/2" x 13-2/5", 8-1/2" x 13", 8-1/2" x 11", 8-1/2" x 11"R, 7-1/4 x 10-1/2"R, A3 wide, A3, B4, A4, A4R, B5, B5R, 8K, 16K, 16KR Main tray 4: 12" x 18", 11" x 17", 8-1/2" x 14", 8-1/2" x 13-1/2", 8-1/2" x 13-2/5", 8-1/2" x 13", 8-1/2" x 11", 8-1/2" x 11"R, 5-1/2" x 8-1/2"R, 7-1/4 x 10-1/2"R, A3 wide, A3, B4, A4, A4R, B5, B5R, A5R, Custom (11-5/8-5/8" to 17" x 4" to 5-7/8" (297 to 432 mm x 100 to 148 mm)) Bypass tray: 12" x 18" to 5-1/2" x 8-1/2"R (A3W to A6R) • A6R cannot be used without the right tray. Lost margin Leading edge: 11/64" ± 3/64" (4 mm ± 1 mm) Trailing edge: 3/32" to 13/64" (2 mm to 5 mm) Left edge / Right edge: total 11/64" ± 3/32" (4 mm ± 2 mm)
Paper type	Main tray 1/2: Plain, Recycled, Color, Letter Head, Pre-Printed, Pre-Punched Main tray 3: Plain, Heavy paper, Recycled, Color, Letter Head, Pre-Printed, Pre-Punched Main tray 4: Plain, Heavy paper, Special media, Recycled, Color, Letter Head, Pre-Printed, Pre-Punched Bypass tray: Plain, Heavy paper, Thin paper, Special media, Recycled, Color, Letter Head, Pre-Printed, Pre-Punched Paper weight: Main tray 1/2: 16 lbs. bond to 28 lbs. bond (60 g/m ² to 105 g/m ²) Main tray 3/4: 16 lbs. bond to 80 lbs. Cover (60 g/m ² to 220 g/m ²) Bypass tray: 13 lbs. bond to 110 lbs. Cover (55 g/m ² to 300 g/m ²) • Some usage conditions or paper types may prevent correct printing. To use special media (labels, glossy paper, tab paper, transparencies, etc.), or paper from 28 lbs. bond to 110 lbs. Cover (106 g/m ² to 300 g/m ²), contact your dealer or nearest authorised service representative.
Warm-up time	BP-70M75: 25 seconds* ¹ , 38 seconds* ² BP-70M90: 35 seconds* ¹ , 48 seconds* ² This may vary depending on the ambient conditions. * ¹ From the power button. * ² From the main power switch.

First-copy time* ¹	Document glass* ² Document glass* ³ DSPF* ² DSPF* ³	3.5 seconds 3.1 seconds 5.2 seconds 5.4 seconds
This may vary depending on the state of the machine. * ¹ Portrait feeding of A4 (8-1/2" x 11") sheets. * ² BP-70M75 * ³ BP-70M90		
Continuous copying speeds* (when shifter is not in operation)	A4, B5, A5, 8-1/2" x 11" A4R, B5R, A5R, 8-1/2" x 11"R, 7-1/4" x 10-1/2"R, 5-1/2" x 8-1/2"R B4, 8-1/2" x 14", 8-1/2" x 13", 8-1/2" x 13-2/5", 8-1/2" x 13-1/2" A3, A4R, B5R, A5R, 11" x 17", 8-1/2" x 11"R, 7-1/4" x 10-1/2"R, 5-1/2" x 8-1/2"R A3W, 12" x 18"	BP-70M75 75 copies/min. 48 copies/min. 42 copies/min. 37 copies/min. 34 copies/min. BP-70M90 90 copies/min. 58 copies/min. 50 copies/min. 44 copies/min. 42 copies/min.
*Continuous speed for same original source. Output may be temporarily interrupted to stabilize image quality. The speed may drop in some environments.		
Copy ratios	Same size: 1: 1 ± 0.8 % Enlarge (AB size): 115 %, 122 %, 141 %, 200 %, 400 % (Inch size: 121 %, 129 %, 200 %, 400 %) Reduce (AB size): 25 %, 50 %, 70 %, 81 %, 86 % (Inch size: 25 %, 50 %, 64 %, 77 %) Zoom range: 25 to 400 % in 1 % increments, total 376 increments. Can calculate zoom rate when mm is specified. (25 - 200 % using automatic document feeder)	
Paper feed / capacity	3200 sheets in 4 trays (1250 + 850 + 500 x 2) plus 100-sheet multi-bypass tray • Using 20 lbs. bond (80 g/m ²) weight paper	
Max. paper feed / max. capacity	6700 sheets in 4 trays (1250 + 850 + 500 x 2) plus large capacity trays (3500) plus 100-sheet multi-bypass tray • Using 20 lbs. bond (80 g/m ²) weight paper	
Continuous copy	Max. 9999 copies	
Memory	Memory 5 GB Storage 256GB • 1 GB = One billion bytes when referring to storage capacity. Actual format capacity is less.	
Required power supply	AC 120V, 60Hz, 16A Power consumption Max. 1.92 kW (including options)	
Ambient environment	Operating environment 50 °F to 91 °F (10 °C to 35 °C) (20 % to 85 % RH) 800 - 1,013 hPa Standard environment 69.5 °F to 77 °F (21 °C to 25 °C) (50 ± 10 % RH)	
Dimensions	26-7/64" (W) x 30-3/64" (D) x 48-53/64" (H) (663 mm (W) x 763 mm (D) x 1240 mm (H))	
Weight	Approx. 359.4 lbs. (163 kg)	
Overall dimensions	39-1/2" (W) x 32-1/64" (D) (1003 mm (W) x 813 mm (D))* * With bypass tray extended	



Automatic Document Feeder

Document feeder types	Duplex Single Pass Feeder (DSPF)
Original paper sizes	11" x 17" to 5-1/2" x 8-1/2" (A3 to A6R), business card
Paper weight of original	One-sided: 9 lbs. Bond to 80 lbs. Cover (35 to 220 g/m ²) Two-sided: 13 lbs. Bond to 80 lbs. Cover (50 to 220 g/m ²)
Paper storage capacity	300 sheets (20 lbs. (80 g/m ²)) (or maximum stack height of 1-1/2" (38 mm)) Business card: 150 sheets (or maximum stack height of 1-1/2" (38 mm))
Scan speed (copy)	105 sheets/minute: B/W (600 x 400 dpi)

* 9 to 13 lbs. (35 to 49 g/m²) is by thin paper scanning.
40 lbs to 80 lbs. Cover (158 to 220 g/m²) is by heavy paper scanning.

Large capacity tray (Tray 5)

Name	Large capacity tray (BP-LC11) Large capacity tray (MX-LC19)
Paper sizes	BP-LC11: 8-1/2" x 11", A4 MX-LC19: 12" x 18" to 8-1/2" x 11"R (A3 wide to B5)
Useable paper	16 lbs. bond to 80 lbs. Cover (60 g/m ² to 220 g/m ²)
Paper capacity	BP-LC11: 3500 MX-LC19: 3000
Required power supply	Supplied from main machine
Dimensions	BP-LC11: 14-39/64" (W) x 22-41/64" (D) x 20-43/64" (H) (371 mm (W) x 575 mm (D) x 525 mm (H)) MX-LC19: 27-21/64" (W) x 23-13/64" (D) x 20-7/16" (H) (694 mm (W) x 589 mm (D) x 519 mm (H))
Weight	BP-LC11: Approx. 61.8 lbs. (28 kg) MX-LC19: Approx. 110.2 lbs. (50 kg)

Finisher / Saddle Stitch Finisher

Name	Finisher (MX-FN34) Saddle Stitch Finisher (MX-FN35)
Paper sizes	Depends on feeder specifications
Useable paper	Paper weight 13 lbs. to 110 lbs. Cover (55 g/m ² to 300 g/m ²)
No. of trays	MX-FN34: 2 (Upper tray / Lower tray) MX-FN35: 2 (Upper tray / Lower tray) + Saddle stitch tray
Tray capacity (13-20 lbs. bond (60-80g/m ²))	Upper tray Non-stapled 12" x 18", 11" x 17", 8-1/2" x 14", 8-1/2" x 13", 8-1/2" x 13-1/2", 8-1/2" x 13-2/5", 8-1/2" x 11"R, 7-1/4" x 10-1/2"R, (A3W, A3, B4, A4R, B5R, 8K, 16KR): 125 sheets 8-1/2" x 11", 5-1/2" x 8-1/2", 5-1/2" x 8-1/2"R (A4, B5, A5R, 16K): 250 sheets Lower tray Non-stapled 12" x 18", 11" x 17", 8-1/2" x 14", 8-1/2" x 13", 8-1/2" x 13-1/2", 8-1/2" x 13-2/5", 8-1/2" x 11"R, 7-1/4" x 10-1/2"R, 5-1/2" x 8-1/2", 5-1/2" x 8-1/2"R, 7-1/4" x 10-1/2"R (A3W, A3, B4, A4R, B5R, A5R, 8K): 1500 sheets 8-1/2" x 11" (A4, B5): 3000 sheets Staple function 11" x 17", 8-1/2" x 14", 8-1/2" x 13", 8-1/2" x 13-1/2", 8-1/2" x 13-2/5", 8-1/2" x 11"R (A3, B4, A4R): 100 units or 1500 sheets 8-1/2" x 11" (A4, B5, 16K): 200 units or 3000 sheets Stapleless staple 11" x 17" (A3, 8K): 100 units 8-1/2" x 11" (A4, 16K): 200 units Saddle stitch tray (MX-FN35) 1 to 5 sheets: 25 units 6 to 10 sheets: 15 units 11 to 20 sheets: 10 units
Max. no. of stapled sheets	Staple function Max. no. of 65 sheets (8-1/2" x 11" (A4, B5, 16K)) Max. no. of 2 sheets (110 lbs. Cover (300 g/m ²)) + 63 sheets (24 lbs. (90 g/m ²)) Max. no. of 30 sheets (11" x 17", 8-1/2" x 14", 8-1/2" x 13", 8-1/2" x 13-1/2", 8-1/2" x 13-2/5", 8-1/2" x 11"R (A3, B4, A4R, 8K)) Stapleless staple Max. no. of 5 sheets (17 lbs. (64 g/m ²) or less) (11" x 17", 8-1/2" x 11" (A3, A4, 8K, 16K))
Staple position	1 bottom (slant), 1 top (slant), 2 middle
Manual staple	Staple position: 1 top Max. no. of stapled sheets: 23/64" (9 mm) or less
Saddle Stitch (MX-FN35)	Staple method Centered fold with stapling in 2 center places Saddle stitch fold position Centered fold Saddle usable sizes 12" x 18", 11" x 17", 8-1/2" x 14", 8-1/2" x 11"R, 8-1/2" x 13-1/2", 8-1/2" x 13-2/5", 8-1/2" x 13", 8-1/2" x 11"R (A3W, A3, B4, A4R, 8K, 16KR) Saddle usable paper weight 13 lbs. to 140 lbs. Cover (55 g/m ² to 256 g/m ²) Paper weighting 28 lbs. to 140 lbs. Cover (106 g/m ² to 256 g/m ²) is only able to be used in cover mode and for single sheet fold. Max. no. of saddle-stitched sheets Max. no. of 20 sheets (20 lbs. (80g/m ²)) 19 sheets (20 lbs. (80g/m ²)) + 1 sheet (110 lbs. Index (209 g/m ²))
Required power supply	Supplied from main machine
Weight	MX-FN34: Approx. 72.8 lbs. (33 kg) MX-FN35: Approx. 125.7 lbs. (57 kg)
Dimensions	When output paper tray is stored 20-63/64" (W) x 25-23/32" (D) x 43-7/16" (H) (533 mm (W) x 653 mm (D) x 1103 mm (H)) When output paper tray is extended 25" (W) x 25-23/32" (D) x 45-61/64" (H) (635 mm (W) x 653 mm (D) x 1167 mm (H))

* Output capacity may vary depending on environmental conditions at the installation location, the type of paper used, and the storage condition of the paper.



Finisher (Large stacker) / Saddle Stitch Finisher (Large stacker)

Name	Finisher (MX-FN21) Saddle Stitch Finisher (MX-FN22)
Paper sizes	Depends on feeder specifications
Useable paper	Paper weight 13 lbs. to 110 lbs. Cover (52 g/m ² to 300 g/m ²)
No. of trays	MX-FN21:3 (Upper tray / Middle tray / Lower tray) MX-FN22:4 (Upper tray / Middle tray / Lower tray) + Saddle stitch tray
Tray capacity (20 lbs. bond (80g/m ²))*1	Upper tray Non-stapled 12" x 18", 9" x 12", 11" x 17", 8-1/2" x 14", 8-1/2" x 11"R, 7-1/4" x 10-1/2" (A3 wide, A3, B4, A4R, B5R): 750 sheets 8-1/2" x 11", 5-1/2" x 8-1/2"R (A4, B5, A5R): 1500 sheets Staple function 11" x 17", 8-1/2" x 14" (A3, B4): 50 units or 750 sheets 8-1/2" x 11", 8-1/2" x 11"R (A4, A4R, B5): 100 units or 1500 sheets Middle tray Non-stapled 12" x 18", 9" x 12", 11" x 17", 8-1/2" x 14", 8-1/2" x 11"R, 7-1/4" x 10-1/2" (A3 wide, A3, B4, A4R, B5R): 125 sheets 8-1/2" x 11", 5-1/2" x 8-1/2"R (A4, B5, A5R): 250 sheets (Offset output is not available) Lower tray Non-stapled 12" x 18", 9" x 12", 11" x 17", 8-1/2" x 14", 8-1/2" x 11"R, 7-1/4" x 10-1/2" (A3 wide, A3, B4, A4R, B5R): 750 sheets 8-1/2" x 11", 5-1/2" x 8-1/2"R (A4, B5, A5R): 1500 sheets Staple function 11" x 17" / 8-1/2" x 14" (B4 / A3): 50 units or 750 sheets 8-1/2" x 11" / 8-1/2" x 11"R (A4 / A4R / B5): 100 units or 1,500 sheets Offset output is not available for 7-1/4" x 10-1/2"R, 5-1/2" x 8-1/2"R, A3 wide, B5R, A5R. Saddle stitch tray (MX-FN22) 1 to 5 sheets: 25 units 6 to 10 sheets: 15 units 11 to 20 sheets: 10 units
Max. no. of stapled sheets (20 lbs. bond (80g/m ²))	Max. no. of 100 sheets (8-1/2" x 11" (A4, B5)) Max. no. of 2 sheets (110 lbs. Cover (300 g/m ²)) + 98 sheets (20 lbs. (80 g/m ²)) Max. no. of 50 sheets (11" x 17", 8-1/2" x 14", 8-1/2" x 11"R (A3, B4, A4R))
Staple position	Front: 1 position (slant), Back: 1 position (slant), Center: 2 positions
Saddle Stitch (MX-FN22)	Staple method (for saddle stitch) Centered fold with stapling in 2 center places Saddle stitch fold position Centered fold Saddle usable sizes 12" x 18", 11" x 17", 8-1/2" x 14", 8-1/2" x 11"R (A3 wide, A3, B4, A4R) Saddle usable paper weight 16 lbs bond (60 g/m ²) to 110 lbs cover (300 g/m ²) Paper weighting 28 lbs bond (106 g/m ²) to 110 lbs cover (300 g/m ²) is only able to be used in cover mode and for single sheet fold. Max. no. of saddle-stitched sheets Max. no. of 20 sheets (24 lbs (90 g/m ²)): 19 sheets (24 lbs bond (90 g/m ²)) + 1 sheet (140 lbs index (256 g/m ²))
Required power supply	AC 120 V/15 A, 60 Hz
Weight	MX-FN21: Approx. 134.5 lbs (61 kg) MX-FN22: Approx. 238.1 lbs (108 kg)
Dimensions	MX-FN21:When output paper tray is stored 25-3/4" (W) x 30-1/8" (D) x 40-15/16" (H) (654 mm (W) x 765 mm (D) x 1040 mm (H)) When output paper tray is extended 30-51/64" (W) x 30-1/8" (D) x 40-15/16" (H) (782 mm (W) x 765 mm (D) x 1040 mm (H)) MX-FN22:When output paper tray is stored 30-13/64" (W) x 30-1/8" (D) x 40-15/16" (H) (767 mm (W) x 765 mm (D) x 1040 mm (H)) When output paper tray is extended 35-9/32" (W) x 30-1/8" (D) x 40-15/16" (H) (896 mm (W) x 765 mm (D) x 1040 mm (H))

* Output capacity may vary depending on environmental conditions at the installation location, the type of paper used, and the storage condition of the paper.

Punch Module

Name	Punch module for MX-FN34/35 MX-PN16B	Punch module for MX-FN21/22 MX-PN13B
Paper size for punch module	11" x 17" to 7-1/4" x 10-1/2"R (A3 to B5R)	
Holes	2/3 holes	
Required power supply	Supplied from finisher/saddle stitch finisher	
Dimensions	- (Built into the Finisher and Saddle Stitch Finisher)	
Weight	Approx. 5.6 lbs. (2.5 kg)	Approx. 8.6 lbs. (3.7 kg)

Paper Pass Unit / Relay Unit

Name	Paper Pass Unit (stored in the machine): MX-RB26 Relay Unit: MX-RB13
Dimensions	MX-RB26:19-21/32" (W) x 28-9/32" (D) x 8-9/32" (H) (499 mm (W) x 718 mm (D) x 210 mm (H)) MX-RB13:8-7/16" (W) x 29-59/64" (D) x 38-53/64" (H) (214 mm (W) x 760 mm (D) x 986 mm (H))
Weight	MX-RB26:Approx. 11.1 lbs (5 kg) MX-RB13:Approx. 33.1 lbs (15 kg)

Curl Correction Unit

Name	Curl Correction Unit (MX-RB27)
Paper sizes	Depends on feeder specifications
Useable paper	Depends on feeder specifications
Required power supply	Supplied from the machine
Dimensions	8-7/16" (W) x 30" (D) x 38-13/16" (H) (214 mm (W) x 762 mm (D) x 986 mm (H))
Weight	Approx. 41.9 lbs (19 kg)

Trimming Module

Name	Trimming module (MX-TM10)
Useable size for trimming module	12" x 18" (A3 wide), 11" x 17", 8-1/2" x 14", 8-1/2" x 13-1/2", 8-1/2" x 13-2/5", 8-1/2" x 13", 8-1/2" x 11"R, A3, B4, A4R
Max. no. of sheets to be trimmed	2 to 20 sheets (16 lbs bond to 21 lbs bond (60 g/m ² to 81.4 g/m ²)) 2 to 10 sheets (21 lbs bond over to 28 lbs bond (81.4 g/m ² over to 105 g/m ²)) 2 to 3 sheets (28 lbs bond over to 80 lbs cover (105 g/m ² over to 220 g/m ²)) When plain paper trimmed. Including one front cover of 110 lbs cover (300 g/m ²) or less.
Required power supply	Supplied from saddle stitch finisher
Dimensions	9-7/8" (W) x 24-15/32" (D) x 15-7/8" (H) (251 mm (W) x 625 mm (D) x 403 mm (H))
Weight	Approx. 70.6 lbs (32 kg)

Folding Unit

Name	Folding unit (MX-FD10)
Folding types	Z-Fold, C-Fold, Accordion Fold, Double Fold, Half Fold.
Useable size for folding unit	Z-Fold: 11" x 17", 8-1/2" x 14", 8-1/2" x 11"R, A3, B4, A4R C-Fold, Accordion Fold, Double Fold, Half Fold: 8-1/2" x 11"R, A4R
Useable paper	13 lbs bond to 28 lbs bond (52 g/m ² to 105 g/m ²)
Tray capacity (20 lbs (80 g/m ²))*	C-Fold/Accordion Fold/Double Fold 2-23/64" (60 mm) (Equivalent to 40 sheets. (Equivalent to 25 sheets for Double Fold)) Copies made in Z-Fold or Half Fold are output to the tray of the finisher (100-sheet stapling) or saddle stitch finisher (100-sheet stapling).
Required power supply	Supplied from finisher/saddle stitch finisher
Dimensions	13-15/64" (W) x 31-15/64" (D) x 41-11/32" (H) (336 mm (W) x 793 mm (D) x 1050 mm (H))
Weight	Approx. 145.5 lbs (66 kg)



Inserter

Name	Inserter (MX-CF11)
Useable size for inserter	12" x 18", 9" x 12", 11" x 17", 8-1/2" x 14", 8-1/2" x 13-1/2", 8-1/2" x 13-2/5", 8-1/2" x 13", 8-1/2" x 11", 8-1/2" x 11"R, 7-1/4 x 10-1/2"R, 5-1/2" x 8-1/2"R, A3 wide, A4 wide, A3, B4, A4, A4R, B5, B5R, A5R
Useable paper	16 lbs bond to 80 lbs cover (60 g/m ² to 220 g/m ²)
No. of trays	2
Tray capacity (20 lbs (80 g/m ²))	Upper tray: 200 sheets Lower tray: 200 sheets
Required power supply	Supplied from the machine
Dimensions	21-1/4" (W) x 29-7/8" (D) x 50-1/4" (H) (540 mm (W) x 760 mm (D) x 1276 mm (H))
Weight	Approx. 99.2 lbs (45 kg)

Network Printer Specifications

Type	Built-in type
Continuous print speed	Same as continuous copy speed
Resolution	Data processing: 600 × 600 dpi, 1200 × 1200 dpi Print: 600 × 600 dpi, 1200 × 1200 dpi, equivalent to 9600 dpi × 600 dpi
Page description language	PCL6 emulation, Adobe PostScript 3
Compatible protocols	TCP/IP (LPD, Port9100, IPP, SMB, FTP, WSD, POP3<E-mail Print>, HTTP)
Compatible OS	Windows 8.1, Windows Server 2012, Windows 10, Windows 11, Windows Server 2016, Windows Server 2019, Windows Server 2022 macOS (10.10, 10.11, 10.12, 10.13, 10.14, 10.15, 11, 12)
Internal fonts	80 fonts for PCL, 139 fonts for Adobe PostScript 3
Memory	Machine system memory and local drive
Interface	10BASE-T/100BASE-TX/1000BASE-T USB 2.0 (Host, Hi speed mode) USB 3.0 (Host, Super speed mode)

Network Scanner Specifications

Type	Color scanner
Scan resolution (main × vertical)	100 × 100 dpi, 150 × 150 dpi, 200 × 200 dpi, 300 × 300 dpi, 400 × 400 dpi, 600 × 600 dpi (push scan) 50 to 9600 dpi *1 (pull scan)
Scan speed (A4 (8-1/2" × 11"))	140 sheets/minute (200 × 200 dpi/300 × 300 dpi) (one-sided), 280 pages/minute (200 × 200 dpi/300 × 300 dpi) (two-sided) When in standard mode using Sharp standard paper (A4 (8-1/2" × 11") size with 6% coverage) and the auto color detector is turned off. The speed varies depending on the data volume of the original.
Interface	10BASE-T/100BASE-TX/1000BASE-T, USB 2.0, USB3.0 (when an external memory device is used)
Compatible protocols	TCP/IP
Compatible OS (Pull scan (TWAIN)) *2	Windows 8.1, Windows Server 2012, Windows 10, Windows 11, Windows Server 2016, Windows Server 2019, Windows Server 2022
Output format	(B/W) TIFF, PDF, PDF/A-1a*3, PDF/A-1b, PDF/A*4, Encrypted PDF, XPS*5, Searchable PDF*3, Office file (pptx, xlsx, docx)*3, TXT (UTF-8)*3, RTF*4 Compression method: decompression, G3 (MH), G4 (MMR) (Gray scale/color) TIFF, JPEG, PDF, PDF/A-1a*3, PDF/A-1b, PDF/A*4, Encrypted PDF, High compression, Compact PDF (Ultra Fine), Compact PDF/A-1a *3, Compact PDF/A-1b, Compact PDF/A *4, Compact PDF/A-1a (Ultra Fine)*3, Compact PDF/A-1b (Ultra Fine), Compact PDF/A (Ultra Fine), XPS*5, Searchable PDF*3, Office file (pptx, xlsx, docx)*3, TXT(UTF-8)*3, RTF*3 Compression method: JPEG (high, mid, and low compression), high compression PDF, Reduce Colors*6
Driver	TWAIN compliant

*1: You must decrease the scan size when increasing the resolution.

*2: There are cases when a connection cannot be established. Please contact your local dealer for more information.

*3: Appears when the OCR function is enabled in the system settings.

*4: Appears when the OCR function is disabled in the system settings.

*5: XPS stands for XML Paper Specification.

*6: When PDF, PDF/A, PDF/A-1a/1b, or encrypt PDF is selected.

Fax Specifications

Name	Facsimile expansion kit (BP-FX11)
Useable lines	General phone lines (PSTN), private branch exchange (PBX)
Resolution	Standard: 8 dot/mm x 3.85 line/mm Fine: 8 dot/mm x 7.7 line/mm Super Fine: 8 dot/mm x 15.4 line/mm Ultra Fine: 16 dot/mm x 15.4 line/mm
Connection speed	Super G3: 33.6 kbps, G3: 14.4 kbps
Coding method	MH, MR, MMR, JBIG
Connection mode	Super G3 / G3
Original paper sizes for transmission	11" × 17" to 5-1/2" × 8-1/2" (A3 to A5) (Paper with a max. length of 1000 mm can be transmitted (one-sided / B/W only).)
Registered paper size	5-1/2" × 8-1/2"R, 8-1/2" × 11", 8-1/2" × 11"R, A4, A4R, 8-1/2" × 13", 8-1/2" × 13-2/5", 8-1/2" × 14", and 11" × 17"
Transmission time	Approx. 2 seconds * (A4 (8-1/2" × 11") Sharp standard paper, normal characters, Super G3 (JBIG)) Approx. 6 seconds (G3 ECM)
Memory	4 GB
Notes	AddressMax. of 2000 entries (Including group dialing for fax, scanner, and Internet fax) Entries per groupMax. of 500 entries Mass transmissionsMax. of 500 recipients

* Complies with the 33.6 kbps transmission method for Super G3 facsimiles standardized by the International Telecommunications Union (ITU-T). This is the speed for when sending an 8-1/2" × 11" (A4) size piece of paper of around 700 characters at standard image quality (8 × 3.85 chars/mm) in Hi-speed mode (33.6 kbps). This is the transmission speed for image information only and does not include time for transmission control. The actual time needed for a transmission depends on the content of the text, type of receiving fax machine, and telephone line conditions.



Wireless LAN Specifications

Type	Standard (Built-in type)
Compliance standards	IEEE802.11a/b/g/n/ac
Transmission method	OFDM (IEEE802.11a/g/n/ac), DS-SS (IEEE 802.11b)
Frequency range	2400 to 2483.5 MHz/5150 to 5350 MHz/5470 to 5725 MHz/ 5725 to 5850 MHz
Channel number	See "Channels that can be used in wireless LAN" in the start guide.
Transmission speed (value of standard) *1	IEEE802.11b max. 11 Mbps IEEE802.11a/g max. 54 Mbps IEEE802.11n max. 150 Mbps IEEE802.11ac max. 433 Mbps
Compatible protocols	TCP/IP (IPv4)
Security	WEP, WPA/WPA2-mixed PSK, WPA/WPA2-mixed EAP*2, WPA2 PSK, WPA2 EAP*2, WPA2/WPA3-mixed PSK/SAE, WPA3 SAE, WPA2/WPA3-mixed EAP*2, WPA3 EAP*2

*1: The indicated values are maximum theoretical values for the Wireless LAN Standard. The values do not indicate actual data transmission speeds.

*2: Cannot be used in Access Point mode.

Bluetooth® Specifications

Bluetooth® Specification	Bluetooth® standard specification Ver.5.0
Frequency range	2.4 GHz (2402 to 2480 MHz)
Modulation method	FH-SS
Maximum transmission output	Power Class1
Supported profile	PBAP



TRADEMARK ACKNOWLEDGEMENTS

The following trademarks and registered trademarks are used in conjunction with the machine and its peripheral devices and accessories.

- Microsoft® Windows®, Windows® 8.1, Windows Server® 2012, Windows® 10, Windows® 11, Windows Server® 2016, Windows Server® 2019, Windows Server® 2022, Internet Explorer®, Active Directory, Excel, Microsoft 365, SharePoint and OneDrive are registered trademarks or trademarks of Microsoft Corporation in the U.S.A. and other countries.
- Intel® is a trademark of Intel Corporation in the U.S. and/or other countries.
- PostScript and PostScript3 are a registered trademark of Adobe.
- Adobe, the Adobe logo, Acrobat, the Adobe PDF logo, and Reader are registered trademarks or trademarks of Adobe in the United States and other countries.
- Apple, macOS, AppleTalk and EtherTalk are trademarks of Apple Inc., registered in the U.S. and other countries.
- Mozilla® and Firefox® are registered trademarks or trademarks of the Mozilla Foundation in the U.S.A. and other countries.
- Sharpdesk is a trademark of Sharp Corporation.
- Sharp OSA is a trademark of Sharp Corporation.
- © 2021 ACCESS CO., LTD.

ACCESS™

- Qualcomm® DirectOffice™ is a product of Qualcomm® Technologies, Inc. and/or its subsidiaries. Qualcomm is a trademark of Qualcomm Incorporated, registered in the United States and other countries. DirectOffice™ is a trademark of CSR Imaging US, LP, registered in the United States and other countries.
 - Android, Google Play, Gmail and Google Drive are trademarks of Google LLC. Use of this trademark requires a license from Google.
 - Bluetooth is a registered trademark of Bluetooth SIG, Inc. in the United States.
 - Wi-Fi and Wi-Fi Direct is a registered trademark of Wi-Fi Alliance.
 - WPA/WPA2/WPA3 are trademarks of Wi-Fi Alliance.
 - QR Code is a registered trademark of DENSO WAVE INCORPORATED in Japan and other countries.
 - All other trademarks and copyrights are the property of their respective owners.
- The built-in fonts of this printer use MicroType® font compression technology of Monotype Imaging, and also use the scalable font rendering subsystem of UFST® (Universal Font Scaling Technology) of Monotype Imaging. MicroType and UFST® are trademarks of Monotype Imaging, Inc. registered in the United States Patent and Trademark Office and may be registered in certain jurisdictions.
- Candid, Gold, and Taffy are trademarks of Monotype Imaging, Inc. registered in the United States Patent and Trademark Office and may be registered in certain jurisdictions.
- CG Omega, CG Times, Garamond Antiqua, Garamond Halbfett, Garamond Kursiv, Garamond and Halbfett Kursiv are trademarks of Monotype Imaging, Inc. and may be registered in certain jurisdictions.
- Albertus, Arial, Ashley Script, Coronet, Gill Sans, Joanna and Times New Roman are trademarks of The Monotype Corporation registered in the United States Patent and Trademark Office and may be registered in certain jurisdictions.
- Avant Garde, ITC Bookman, Lubalin Graph, Mona Lisa, Zapf Chancery and Zapf Dingbats are trademarks of International Typeface Corporation registered in the United States Patent and Trademark Office and may be registered in certain jurisdictions.
- Clarendon, Eurostile, Helvetica, Optima, Palatino, Stempel Garamond, Times and Univers are trademarks of Heidelberger Druckmaschinen AG, which may be registered in certain jurisdictions, exclusively licensed through Linotype Library GmbH, a wholly owned subsidiary of Heidelberger Druckmaschinen AG.
- Apple Chancery, Chicago, Geneva, Monaco and New York are trademarks of Apple Inc. and may be registered in certain jurisdictions.
- Wingdings is a registered trademark of Microsoft Corporation in the United States and other countries.
- Marigold and Oxford are trademarks of Arthur Baker and may be registered in some jurisdictions.
- Antique Olive is a trademark of Marcel Olive and may be registered in certain jurisdictions.
- Hoefer Text is a trademark of Johnathan Hoefler and may be registered in some jurisdictions.
- HGGothicB, HGMinchoL, HGP GothicB and HGPMinchoL are trademarks of Ricoh Company, Ltd. and may be registered in some jurisdictions. ITC is a trademark of International Typeface Corporation registered in the United States Patent and Trademark Office and may be registered in certain jurisdictions.
- Agfa is a trademark of the Agfa-Gevaert Group and may be registered in certain jurisdictions.
- Intellifont, MicroType and UFST are trademarks of Monotype Imaging, Inc. registered in the United States Patent and Trademark Office and may be registered in certain jurisdictions.
- TrueType is trademark of Apple Inc. registered in the United States Patent and Trademark Office and other countries.
- PostScript is a trademark of Adobe and may be registered in some jurisdictions.
- HP, PCL, FontSmart and LaserJet are trademarks of Hewlett-Packard Company and may be registered in some jurisdictions.
- The Type 1 processor resident in Monotype Imaging's UFST product is under license from Electronics For Imaging, Inc. All other trademarks are the property of their respective owners.

LICENSE INFORMATION

Information on the Software License for This Product

Software composition

The software included in this product is comprised of various software components whose individual copyrights are held by SHARP or by third parties.

Software developed by SHARP and open source software

The copyrights for the software components and various relevant documents included with this product that were developed or written by SHARP are owned by SHARP and are protected by the Copyright Act, international treaties, and other relevant laws. This product also makes use of freely distributed software and software components whose copyrights are held by third parties. These include software components covered by a GNU General Public License (hereafter GPL), a GNU Lesser General Public License (hereafter LGPL) or other license agreement.

Obtaining source code

Some of the open source software licensors require the distributor to provide the source code with the executable software components. GPL and LGPL include similar requirements. For information on obtaining the source code for the open source software and for obtaining the GPL, LGPL, and other license agreement information, visit the following website:

<http://sharp-world.com/products/copier/source/download/index.html>

We are unable to answer any questions about the source code for the open source software. The source code for the software components whose copyrights are held by SHARP is not distributed.

Software Copyrights

Copyright (c) 2000 Carnegie Mellon University. All rights reserved.

Redistribution and use in source and binary forms, with or without modification, are permitted provided that the following conditions are met:

- 1.Redistributions of source code must retain the above copyright notice, this list of conditions and the following disclaimer.
- 2.Redistributions in binary form must reproduce the above copyright notice, this list of conditions and the following disclaimer in the documentation and/or other materials provided with the distribution.
- 3.The name "Carnegie Mellon University" must not be used to endorse or promote products derived from this software without prior written permission. For permission or any other legal details, please contact
Office of Technology Transfer Carnegie Mellon University 5000 Forbes Avenue Pittsburgh, PA 15213-3890
(412) 268-4387, fax: (412) 268-7395
tech-transfer@andrew.cmu.edu
- 4.Redistributions of any form whatsoever must retain the following acknowledgment:
"This product includes software developed by Computing Services at Carnegie Mellon University
(<http://www.cmu.edu/computing/>)."

CARNEGIE MELLON UNIVERSITY DISCLAIMS ALL WARRANTIES WITH REGARD TO THIS SOFTWARE, INCLUDING ALL IMPLIED WARRANTIES OF MERCHANTABILITY AND FITNESS, IN NO EVENT SHALL CARNEGIE MELLON UNIVERSITY BE LIABLE FOR ANY SPECIAL, INDIRECT OR CONSEQUENTIAL DAMAGES OR ANY DAMAGES WHATSOEVER RESULTING FROM LOSS OF USE, DATA OR PROFITS, WHETHER IN AN ACTION OF CONTRACT, NEGLIGENCE OR OTHER TORTIOUS ACTION, ARISING OUT OF OR IN CONNECTION WITH THE USE OR PERFORMANCE OF THIS SOFTWARE.

Copyright (c) 1995 - 2008 Kungliga Tekniska Högskolan (Royal Institute of Technology, Stockholm, Sweden). All rights reserved.

All rights reserved. Export of this software from the United States of America may require a specific license from the United States Government. It is the responsibility of any person or organization contemplating export to obtain such a license before exporting.

WITHIN THAT CONSTRAINT, permission to use, copy, modify, and distribute this software and its documentation for any purpose and without fee is hereby granted, provided that the above copyright notice appear in all copies and that both that copyright notice and this permission notice appear in supporting documentation, and that the name of M.I.T. not be used in advertising or publicity pertaining to distribution of the software without specific, written prior permission. Furthermore if you modify this software you must label your software as modified software and not distribute it in such a fashion that it might be confused with the original MIT software. M.I.T. makes no representations about the suitability of this software for any purpose. It is provided "as is" without express or implied warranty.

THIS SOFTWARE IS PROVIDED "**AS IS**" AND WITHOUT ANY EXPRESS OR IMPLIED WARRANTIES, INCLUDING, WITHOUT LIMITATION, THE IMPLIED WARRANTIES OF MERCHANTABILITY AND FITNESS FOR A PARTICULAR PURPOSE.

Individual source code files are copyright MIT, Cygnus Support, OpenVision, Oracle, Sun Soft, FundsXpress, and others.

Project Athena, Athena, Athena MUSE, Discuss, Hesiod, Kerberos, Moira, and Zephyr are trademarks of the Massachusetts Institute of Technology (MIT). No commercial use of these trademarks may be made without prior written permission of MIT.

"Commercial use" means use of a name in a product or other for-profit manner. It does NOT prevent a commercial firm from referring to the MIT trademarks in order to convey information (although in doing so, recognition of their trademark status should be given).

OpenSSL License

Copyright (c) 1998-2004 The OpenSSL Project. All rights reserved.

Redistribution and use in source and binary forms, with or without modification, are permitted provided that the following conditions are met:

- 1.Redistributions of source code must retain the above copyright notice, this list of conditions and the following disclaimer.
- 2.Redistributions in binary form must reproduce the above copyright notice, this list of conditions and the following disclaimer in the documentation and/or other materials provided with the distribution.
- 3.All advertising materials mentioning features or use of this software must display the following acknowledgment: "This product includes software developed by the OpenSSL Project for use in the OpenSSL Toolkit. (<http://www.openssl.org/>)"
- 4.The names "OpenSSL Toolkit" and "OpenSSL Project" must not be used to endorse or promote products derived from this software without prior written permission. For written permission, please contact openssl-core@openssl.org.
- 5.Products derived from this software may not be called "OpenSSL" nor may "OpenSSL" appear in their names without prior written permission of the OpenSSL Project.
- 6.Redistributions of any form whatsoever must retain the following acknowledgment: "This product includes software developed by the OpenSSL Project for use in the OpenSSL Toolkit. (<http://www.openssl.org/>)"

THIS SOFTWARE IS PROVIDED BY THE OpenSSL PROJECT "AS IS" AND ANY EXPRESSED OR IMPLIED WARRANTIES, INCLUDING, BUT NOT LIMITED TO, THE IMPLIED WARRANTIES OF MERCHANTABILITY AND FITNESS FOR A PARTICULAR PURPOSE ARE DISCLAIMED. IN NO EVENT SHALL THE OpenSSL PROJECT OR ITS CONTRIBUTORS BE LIABLE FOR ANY DIRECT, INDIRECT, INCIDENTAL, SPECIAL, EXEMPLARY, OR CONSEQUENTIAL DAMAGES (INCLUDING, BUT NOT LIMITED TO, PROCUREMENT OF SUBSTITUTE GOODS OR SERVICES; LOSS OF USE, DATA, OR PROFITS; OR BUSINESS INTERRUPTION) HOWEVER CAUSED AND ON ANY THEORY OF LIABILITY, WHETHER IN CONTRACT, STRICT LIABILITY, OR TORT (INCLUDING NEGLIGENCE OR OTHERWISE) ARISING IN ANY WAY OUT OF THE USE OF THIS SOFTWARE, EVEN IF ADVISED OF THE POSSIBILITY OF SUCH DAMAGE.

This product includes cryptographic software written by Eric Young (eay@cryptsoft.com). This product includes software written by Tim Hudson (tjh@cryptsoft.com).

Original SSLeay License

Copyright (C) 1995-1998 Eric Young (eay@cryptsoft.com) All rights reserved.

This package is an SSL implementation written by Eric Young (eay@cryptsoft.com). The implementation was written so as to conform with Netscape's SSL.

This library is free for commercial and non-commercial use as long as the following conditions are adhered to. The following conditions apply to all code found in this distribution, be it the RC4, RSA, lhash, DES, etc., code; not just the SSL code. The SSL documentation included with this distribution is covered by the same copyright terms except that the holder is Tim Hudson (tjh@cryptsoft.com).

Copyright remains Eric Young's, and as such any Copyright notices in the code are not to be removed. If this package is used in a product, Eric Young should be given attribution as the author of the parts of the library used. This can be in the form of a textual message at program startup or in documentation (online or textual) provided with the package.

Redistribution and use in source and binary forms, with or without modification, are permitted provided that the following conditions are met:

1. Redistributions of source code must retain the copyright notice, this list of conditions and the following disclaimer.
2. Redistributions in binary form must reproduce the above copyright notice, this list of conditions and the following disclaimer in the documentation and/or other materials provided with the distribution.
3. All advertising materials mentioning features or use of this software must display the following acknowledgement:
"This product includes cryptographic software written by Eric Young (eay@cryptsoft.com)" The word 'cryptographic' can be left out if the routines from the library being used are not cryptographic related :-).
4. If you include any Windows specific code (or a derivative thereof) from the apps directory (application code) you must include an acknowledgement: "This product includes software written by Tim Hudson (tjh@cryptsoft.com)"

THIS SOFTWARE IS PROVIDED BY ERIC YOUNG "AS IS" AND ANY EXPRESS OR IMPLIED WARRANTIES, INCLUDING, BUT NOT LIMITED TO, THE IMPLIED WARRANTIES OF MERCHANTABILITY AND FITNESS FOR A PARTICULAR PURPOSE ARE DISCLAIMED. IN NO EVENT SHALL THE AUTHOR OR CONTRIBUTORS BE LIABLE FOR ANY DIRECT, INDIRECT, INCIDENTAL, SPECIAL, EXEMPLARY, OR CONSEQUENTIAL DAMAGES (INCLUDING, BUT NOT LIMITED TO, PROCUREMENT OF SUBSTITUTE GOODS OR SERVICES; LOSS OF USE, DATA, OR PROFITS; OR BUSINESS INTERRUPTION) HOWEVER CAUSED AND ON ANY THEORY OF LIABILITY, WHETHER IN CONTRACT, STRICT LIABILITY, OR TORT (INCLUDING NEGLIGENCE OR OTHERWISE) ARISING IN ANY WAY OUT OF THE USE OF THIS SOFTWARE, EVEN IF ADVISED OF THE POSSIBILITY OF SUCH DAMAGE.

The licence and distribution terms for any publically available version orderivative of this code cannot be changed. i.e. this code cannot simply becoped and put under another distribution licence [including the GNU Public Licence.]

D3DES License

Copyright (c) 1988,1989,1990,1991,1992 by Richard Outerbridge. (GENie : OUTER; CIS : [71755,204]) Graven Imagery, 1992.

GNU GENERAL PUBLIC LICENSE Version 2, June 1991

Copyright (C) 1989, 1991 Free Software Foundation, Inc., 51 Franklin Street, Fifth Floor, Boston, MA 02110-1301 USA Everyone is permitted to copy and distribute verbatim copies of this license document, but changing it is not allowed.

Preamble

The licenses for most software are designed to take away your freedom to share and change it. By contrast, the GNU General Public License is intended to guarantee your freedom to share and change free software--to make sure the software is free for all its users. This General Public License applies to most of the Free Software Foundation's software and to any other program whose authors commit to using it. (Some other Free Software Foundation software is covered by the GNU Lesser General Public License instead.) You can apply it to your programs, too.

When we speak of free software, we are referring to freedom, not price. Our General Public Licenses are designed to make sure that you have the freedom to distribute copies of free software (and charge for this service if you wish), that you receive source code or can get it if you want it, that you can change the software or use pieces of it in new free programs; and that you know you can do these things.

To protect your rights, we need to make restrictions that forbid anyone to deny you these rights or to ask you to surrender the rights. These restrictions translate to certain responsibilities for you if you distribute copies of the software, or if you modify it.

For example, if you distribute copies of such a program, whether gratis or for a fee, you must give the recipients all the rights that you have. You must make sure that they, too, receive or can get the source code. And you must show them these terms so they know their rights.

We protect your rights with two steps: (1) copyright the software, and (2) offer you this license which gives you legal permission to copy, distribute and/or modify the software.

Also, for each author's protection and ours, we want to make certain that everyone understands that there is no warranty for this free software. If the software is modified by someone else and passed on, we want its recipients to know that what they have is not the original, so that any problems introduced by others will not reflect on the original authors' reputations.

Finally, any free program is threatened constantly by software patents. We wish to avoid the danger that redistributors of a free program will individually obtain patent licenses, in effect making the program proprietary. To prevent this, we have made it clear that any patent must be licensed for everyone's free use or not licensed at all.

The precise terms and conditions for copying, distribution and modification follow.

GNU GENERAL PUBLIC LICENSE TERMS AND CONDITIONS FOR COPYING, DISTRIBUTION AND MODIFICATION

0. This License applies to any program or other work which contains a notice placed by the copyright holder saying it may be distributed under the terms of this General Public License. The "Program", below, refers to any such program or work, and a "work based on the Program" means either the Program or any derivative work under copyright law: that is to say, a work containing the Program or a portion of it, either verbatim or with modifications and/or translated into another language. (Hereinafter, translation is included without limitation in the term "modification".) Each licensee is addressed as "you".

Activities other than copying, distribution and modification are not covered by this License; they are outside its scope. The act of running the Program is not restricted, and the output from the Program is covered only if its contents constitute a work based on the Program (independent of having been made by running the Program). Whether that is true depends on what the Program does.

1. You may copy and distribute verbatim copies of the Program's source code as you receive it, in any medium, provided that you conspicuously and appropriately publish on each copy an appropriate copyright notice and disclaimer of warranty; keep intact all the notices that refer to this License and to the absence of any warranty; and give any other recipients of the Program a copy of this License along with the Program.

You may charge a fee for the physical act of transferring a copy, and you may at your option offer warranty protection in exchange for a fee.

2. You may modify your copy or copies of the Program or any portion of it, thus forming a work based on the Program, and copy and distribute such modifications or work under the terms of Section 1 above, provided that you also meet all of these conditions:

- a) You must cause the modified files to carry prominent notices stating that you changed the files and the date of any change.
- b) You must cause any work that you distribute or publish, that in whole or in part contains or is derived from the Program or any part thereof, to be licensed as a whole at no charge to all third parties under the terms of this License.
- c) If the modified program normally reads commands interactively when run, you must cause it, when started running for such interactive use in the most ordinary way, to print or display an announcement including an appropriate copyright notice and a notice that there is no warranty (or else, saying that you provide a warranty) and that users may redistribute the program under these conditions, and telling the user how to view a copy of this License. (Exception: if the Program itself is interactive but does not normally print such an announcement, your work based on the Program is not required to print an announcement.)

These requirements apply to the modified work as a whole. If identifiable sections of that work are not derived from the Program, and can be reasonably considered independent and separate works in themselves, then this License, and its terms, do not apply to those sections when you distribute them as separate works. But when you distribute the same

sections as part of a whole which is a work based on the Program, the distribution of the whole must be on the terms of this License, whose permissions for other licensees extend to the entire whole, and thus to each and every part regardless of who wrote it.

Thus, it is not the intent of this section to claim rights or contest your rights to work written entirely by you; rather, the intent is to exercise the right to control the distribution of derivative or collective works based on the Program.

In addition, mere aggregation of another work not based on the Program with the Program (or with a work based on the Program) on a volume of a storage or distribution medium does not bring the other work under the scope of this License.

3. You may copy and distribute the Program (or a work based on it, under Section 2) in object code or executable form under the terms of Sections 1 and 2 above provided that you also do one of the following:

- a) Accompany it with the complete corresponding machine-readable source code, which must be distributed under the terms of Sections 1 and 2 above on a medium customarily used for software interchange; or,
- b) Accompany it with a written offer, valid for at least three years, to give any third party, for a charge no more than your cost of physically performing source distribution, a complete machine-readable copy of the corresponding source code, to be distributed under the terms of Sections 1 and 2 above on a medium customarily used for software interchange; or,
- c) Accompany it with the information you received as to the offer to distribute corresponding source code. (This alternative is allowed only for noncommercial distribution and only if you received the program in object code or executable form with such an offer, in accord with Subsection b above.)

The source code for a work means the preferred form of the work for making modifications to it. For an executable work, complete source code means all the source code for all modules it contains, plus any associated interface definition files, plus the scripts used to control compilation and installation of the executable. However, as a special exception, the source code distributed need not include anything that is normally distributed (in either source or binary form) with the major components (compiler, kernel, and so on) of the operating system on which the executable runs, unless that component itself accompanies the executable.

If distribution of executable or object code is made by offering access to copy from a designated place, then offering equivalent access to copy the source code from the same place counts as distribution of the source code, even though third parties are not compelled to copy the source along with the object code.

4. You may not copy, modify, sublicense, or distribute the Program except as expressly provided under this License. Any attempt otherwise to copy, modify, sublicense or distribute the Program is void, and will automatically terminate your rights under this License. However, parties who have received copies, or rights, from you under this License will not have their licenses terminated so long as such parties remain in full compliance.

5. You are not required to accept this License, since you have not signed it. However, nothing else grants you permission to modify or distribute the Program or its derivative works. These actions are prohibited by law if you do not accept this License. Therefore, by modifying or distributing the Program (or any work based on the Program), you indicate your acceptance of this License to do so, and all its terms and conditions for copying, distributing or modifying the Program or works based on it.

6. Each time you redistribute the Program (or any work based on the Program), the recipient automatically receives a license from the original licensor to copy, distribute or modify the Program subject to these terms and conditions. You

may not impose any further restrictions on the recipients' exercise of the rights granted herein. You are not responsible for enforcing compliance by third parties to this License.

7. If, as a consequence of a court judgment or allegation of patent infringement or for any other reason (not limited to patent issues), conditions are imposed on you (whether by court order, agreement or otherwise) that contradict the conditions of this License, they do not excuse you from the conditions of this License. If you cannot distribute so as to satisfy simultaneously your obligations under this License and any other pertinent obligations, then as a consequence you may not distribute the Program at all. For example, if a patent license would not permit royalty-free redistribution of the Program by all those who receive copies directly or indirectly through you, then the only way you could satisfy both it and this License would be to refrain entirely from distribution of the Program.

If any portion of this section is held invalid or unenforceable under any particular circumstance, the balance of the section is intended to apply and the section as a whole is intended to apply in other circumstances.

It is not the purpose of this section to induce you to infringe any patents or other property right claims or to contest validity of any such claims; this section has the sole purpose of protecting the integrity of the free software distribution system, which is implemented by public license practices. Many people have made generous contributions to the wide range of software distributed through that system in reliance on consistent application of that system; it is up to the author/donor to decide if he or she is willing to distribute software through any other system and a licensee cannot impose that choice.

This section is intended to make thoroughly clear what is believed to be a consequence of the rest of this License.

8. If the distribution and/or use of the Program is restricted in certain countries either by patents or by copyrighted interfaces, the original copyright holder who places the Program under this License may add an explicit geographical distribution limitation excluding those countries, so that distribution is permitted only in or among countries not thus excluded. In such case, this License incorporates the limitation as if written in the body of this License.

9. The Free Software Foundation may publish revised and/or new versions of the General Public License from time to time. Such new versions will be similar in spirit to the present version, but may differ in detail to address new problems or concerns.

Each version is given a distinguishing version number. If the Program specifies a version number of this License which applies to it and "any later version", you have the option of following the terms and conditions either of that version or of any later version published by the Free Software Foundation. If the Program does not specify a version number of this License, you may choose any version ever published by the Free Software Foundation.

10. If you wish to incorporate parts of the Program into other free programs whose distribution conditions are different, write to the author to ask for permission. For software which is copyrighted by the Free Software Foundation, write to the Free Software Foundation; we sometimes make exceptions for this. Our decision will be guided by the two goals of preserving the free status of all derivatives of our free software and of promoting the sharing and reuse of software generally.

NO WARRANTY

11. BECAUSE THE PROGRAM IS LICENSED FREE OF CHARGE, THERE IS NO WARRANTY FOR THE PROGRAM, TO THE EXTENT PERMITTED BY APPLICABLE LAW. EXCEPT WHEN OTHERWISE STATED IN WRITING THE COPYRIGHT HOLDERS AND/OR OTHER PARTIES PROVIDE THE PROGRAM "AS IS" WITHOUT WARRANTY OF ANY KIND, EITHER EXPRESSED OR IMPLIED, INCLUDING, BUT NOT LIMITED TO, THE IMPLIED WARRANTIES OF MERCHANTABILITY AND FITNESS FOR A PARTICULAR PURPOSE. THE ENTIRE RISK AS TO

THE QUALITY AND PERFORMANCE OF THE PROGRAM IS WITH YOU. SHOULD THE PROGRAM PROVE DEFECTIVE, YOU ASSUME THE COST OF ALL NECESSARY SERVICING, REPAIR OR CORRECTION.

12. IN NO EVENT UNLESS REQUIRED BY APPLICABLE LAW OR AGREED TO IN WRITING WILL ANY COPYRIGHT HOLDER, OR ANY OTHER PARTY WHO MAY MODIFY AND/OR REDISTRIBUTE THE PROGRAM AS PERMITTED ABOVE, BE LIABLE TO YOU FOR DAMAGES, INCLUDING ANY GENERAL, SPECIAL, INCIDENTAL OR CONSEQUENTIAL DAMAGES ARISING OUT OF THE USE OR INABILITY TO USE THE PROGRAM (INCLUDING BUT NOT LIMITED TO LOSS OF DATA OR DATA BEING RENDERED INACCURATE OR LOSSES SUSTAINED BY YOU OR THIRD PARTIES OR A FAILURE OF THE PROGRAM TO OPERATE WITH ANY OTHER PROGRAMS), EVEN IF SUCH HOLDER OR OTHER PARTY HAS BEEN ADVISED OF THE POSSIBILITY OF SUCH DAMAGES.

END OF TERMS AND CONDITIONS

How to Apply These Terms to Your New Programs

If you develop a new program, and you want it to be of the greatest possible use to the public, the best way to achieve this is to make it free software which everyone can redistribute and change under these terms.

To do so, attach the following notices to the program. It is safest to attach them to the start of each source file to most effectively convey the exclusion of warranty; and each file should have at least the "copyright" line and a pointer to where the full notice is found.

<one line to give the program's name and a brief idea of what it does.> Copyright (C) <year> <name of author>

This program is free software; you can redistribute it and/or modify it under the terms of the GNU General Public License as published by the Free Software Foundation; either version 2 of the License, or (at your option) any later version.

This program is distributed in the hope that it will be useful, but WITHOUT ANY WARRANTY; without even the implied warranty of MERCHANTABILITY or FITNESS FOR A PARTICULAR PURPOSE. See the GNU General Public License for more details.

You should have received a copy of the GNU General Public License along with this program; if not, write to the Free Software Foundation, Inc., 51 Franklin Street, Fifth Floor, Boston, MA 02110-1301 USA.

Also add information on how to contact you by electronic and paper mail.

If the program is interactive, make it output a short notice like this when it starts in an interactive mode:

Gnomovision version 69, Copyright (C) year name of author Gnomovision comes with ABSOLUTELY NO WARRANTY; for details type `show w'. This is free software, and you are welcome to redistribute it under certain conditions; type `show c' for details.

The hypothetical commands `show w' and `show c' should show the appropriate parts of the General Public License. Of course, the commands you use may be called something other than `show w' and `show c'; they could even be mouse-clicks or menu items--whatever suits your program.

You should also get your employer (if you work as a programmer) or your school, if any, to sign a "copyright disclaimer" for the program, if necessary. Here is a sample; alter the names:

Yoyodyne, Inc., hereby disclaims all copyright interest in the program `Gnomovision' (which makes passes at compilers) written by James Hacker.

<signature of Ty Coon>, 1 April 1989
Ty Coon, President of Vice

This General Public License does not permit incorporating your program into proprietary programs. If your program is a subroutine library, you may consider it more useful to permit linking proprietary applications with the library. If this is what you want to do, use the GNU Lesser General Public License instead of this License.

GNU LESSER GENERAL PUBLIC LICENSE

Version 2.1, February 1999

Copyright (C) 1991, 1999 Free Software Foundation, Inc. 51 Franklin Street, Fifth Floor, Boston, MA 02110-1301 USA Everyone is permitted to copy and distribute verbatim copies of this license document, but changing it is not allowed.

[This is the first released version of the Lesser GPL. It also counts as the successor of the GNU Library Public License, version 2, hence the version number 2.1.]

Preamble

The licenses for most software are designed to take away your freedom to share and change it. By contrast, the GNU General Public Licenses are intended to guarantee your freedom to share and change free software--to make sure the software is free for all its users.

This license, the Lesser General Public License, applies to some specially designated software packages--typically libraries--of the Free Software Foundation and other authors who decide to use it. You can use it too, but we suggest you first think carefully about whether this license or the ordinary General Public License is the better strategy to use in any particular case, based on the explanations below.

When we speak of free software, we are referring to freedom of use, not price. Our General Public Licenses are designed to make sure that you have the freedom to distribute copies of free software (and charge for this service if you wish); that you receive source code or can get it if you want it; that you can change the software and use pieces of it in new free programs; and that you are informed that you can do these things.

To protect your rights, we need to make restrictions that forbid distributors to deny you these rights or to ask you to surrender these rights. These restrictions translate to certain responsibilities for you if you distribute copies of the library or if you modify it.

For example, if you distribute copies of the library, whether gratis or for a fee, you must give the recipients all the rights that we gave you. You must make sure that they, too, receive or can get the source code. If you link other code with the

library, you must provide complete object files to the recipients, so that they can relink them with the library after making changes to the library and recompiling it. And you must show them these terms so they know their rights.

We protect your rights with a two-step method: (1) we copyright the library, and (2) we offer you this license, which gives you legal permission to copy, distribute and/or modify the library.

To protect each distributor, we want to make it very clear that there is no warranty for the free library. Also, if the library is modified by someone else and passed on, the recipients should know that what they have is not the original version, so that the original author's reputation will not be affected by problems that might be introduced by others.

Finally, software patents pose a constant threat to the existence of any free program. We wish to make sure that a company cannot effectively restrict the users of a free program by obtaining a restrictive license from a patent holder. Therefore, we insist that any patent license obtained for a version of the library must be consistent with the full freedom of use specified in this license.

Most GNU software, including some libraries, is covered by the ordinary GNU General Public License. This license, the GNU Lesser General Public License, applies to certain designated libraries, and is quite different from the ordinary General Public License. We use this license for certain libraries in order to permit linking those libraries into non-free programs.

When a program is linked with a library, whether statically or using a shared library, the combination of the two is legally speaking a combined work, a derivative of the original library. The ordinary General Public License therefore permits such linking only if the entire combination fits its criteria of freedom. The Lesser General Public License permits more lax criteria for linking other code with the library.

We call this license the "Lesser" General Public License because it does Less to protect the user's freedom than the ordinary General Public License. It also provides other free software developers Less of an advantage over competing non-free programs. These disadvantages are the reason we use the ordinary General Public License for many libraries. However, the Lesser license provides advantages in certain special circumstances.

For example, on rare occasions, there may be a special need to encourage the widest possible use of a certain library, so that it becomes a de-facto standard. To achieve this, non-free programs must be allowed to use the library. A more frequent case is that a free library does the same job as widely used non-free libraries. In this case, there is little to gain by limiting the free library to free software only, so we use the Lesser General Public License.

In other cases, permission to use a particular library in non-free programs enables a greater number of people to use a large body of free software. For example, permission to use the GNU C Library in non-free programs enables many more people to use the whole GNU operating system, as well as its variant, the GNU/Linux operating system.

Although the Lesser General Public License is Less protective of the users' freedom, it does ensure that the user of a program that is linked with the Library has the freedom and the wherewithal to run that program using a modified version of the Library.

The precise terms and conditions for copying, distribution and modification follow. Pay close attention to the difference between a "work based on the library" and a "work that uses the library". The former contains code derived from the library, whereas the latter must be combined with the library in order to run.

GNU LESSER GENERAL PUBLIC LICENSE TERMS AND CONDITIONS FOR COPYING, DISTRIBUTION AND MODIFICATION

0. This License Agreement applies to any software library or other program which contains a notice placed by the copyright holder or other authorized party saying it may be distributed under the terms of this Lesser General Public License (also called "this License"). Each licensee is addressed as "you".

A "library" means a collection of software functions and/or data prepared so as to be conveniently linked with application programs (which use some of those functions and data) to form executables.

The "Library", below, refers to any such software library or work which has been distributed under these terms. A "work based on the Library" means either the Library or any derivative work under copyright law: that is to say, a work containing the Library or a portion of it, either verbatim or with modifications and/or translated straightforwardly into another language. (Hereinafter, translation is included without limitation in the term "modification".)

"Source code" for a work means the preferred form of the work for making modifications to it. For a library, complete source code means all the source code for all modules it contains, plus any associated interface definition files, plus the scripts used to control compilation and installation of the library.

Activities other than copying, distribution and modification are not covered by this License; they are outside its scope. The act of running a program using the Library is not restricted, and output from such a program is covered only if its contents constitute a work based on the Library (independent of the use of the Library in a tool for writing it). Whether that is true depends on what the Library does and what the program that uses the Library does.

1. You may copy and distribute verbatim copies of the Library's complete source code as you receive it, in any medium, provided that you conspicuously and appropriately publish on each copy an appropriate copyright notice and disclaimer of warranty; keep intact all the notices that refer to this License and to the absence of any warranty; and distribute a copy of this License along with the Library.

You may charge a fee for the physical act of transferring a copy, and you may at your option offer warranty protection in exchange for a fee.

2. You may modify your copy or copies of the Library or any portion of it, thus forming a work based on the Library, and copy and distribute such modifications or work under the terms of Section 1 above, provided that you also meet all of these conditions:

a) The modified work must itself be a software library.

b) You must cause the files modified to carry prominent notices stating that you changed the files and the date of any change.

c) You must cause the whole of the work to be licensed at no charge to all third parties under the terms of this License.

d) If a facility in the modified Library refers to a function or a table of data to be supplied by an application program that uses the facility, other than as an argument passed when the facility is invoked, then you must make a good faith effort to ensure that, in the event an application does not supply such function or table, the facility still operates, and performs whatever part of its purpose remains meaningful.

(For example, a function in a library to compute square roots has a purpose that is entirely well-defined independent of the application. Therefore, Subsection 2d requires that any application-supplied function or table used by this function must be optional: if the application does not supply it, the square root function must still compute square roots.)

These requirements apply to the modified work as a whole. If identifiable sections of that work are not derived from the Library, and can be reasonably considered independent and separate works in themselves, then this License, and its terms, do not apply to those sections when you distribute them as separate works. But when you distribute the same sections as part of a whole which is a work based on the Library, the distribution of the whole must be on the terms of this License, whose permissions for other licensees extend to the entire whole, and thus to each and every part regardless of who wrote it.

Thus, it is not the intent of this section to claim rights or contest your rights to work written entirely by you; rather, the intent is to exercise the right to control the distribution of derivative or collective works based on the Library.

In addition, mere aggregation of another work not based on the Library with the Library (or with a work based on the Library) on a volume of a storage or distribution medium does not bring the other work under the scope of this License.

3. You may opt to apply the terms of the ordinary GNU General Public License instead of this License to a given copy of the Library. To do this, you must alter all the notices that refer to this License, so that they refer to the ordinary GNU General Public License, version 2, instead of to this License. (If a newer version than version 2 of the ordinary GNU General Public License has appeared, then you can specify that version instead if you wish.) Do not make any other change in these notices.

Once this change is made in a given copy, it is irreversible for that copy, so the ordinary GNU General Public License applies to all subsequent copies and derivative works made from that copy.

This option is useful when you wish to copy part of the code of the Library into a program that is not a library.

4. You may copy and distribute the Library (or a portion or derivative of it, under Section 2) in object code or executable form under the terms of Sections 1 and 2 above provided that you accompany it with the complete corresponding machine-readable source code, which must be distributed under the terms of Sections 1 and 2 above on a medium customarily used for software interchange.

If distribution of object code is made by offering access to copy from a designated place, then offering equivalent access to copy the source code from the same place satisfies the requirement to distribute the source code, even though third parties are not compelled to copy the source along with the object code.

5. A program that contains no derivative of any portion of the Library, but is designed to work with the Library by being compiled or linked with it, is called a "work that uses the Library". Such a work, in isolation, is not a derivative work of the Library, and therefore falls outside the scope of this License.

However, linking a "work that uses the Library" with the Library creates an executable that is a derivative of the Library (because it contains portions of the Library), rather than a "work that uses the library". The executable is therefore covered by this License. Section 6 states terms for distribution of such executables.

When a "work that uses the Library" uses material from a header file that is part of the Library, the object code for the work may be a derivative work of the Library even though the source code is not. Whether this is true is especially significant if the work can be linked without the Library, or if the work is itself a library. The threshold for this to be true is not precisely defined by law.

If such an object file uses only numerical parameters, data structure layouts and accessors, and small macros and small inline functions (ten lines or less in length), then the use of the object file is unrestricted, regardless of whether it is legally a derivative work. (Executables containing this object code plus portions of the Library will still fall under Section 6.)

Otherwise, if the work is a derivative of the Library, you may distribute the object code for the work under the terms of Section 6. Any executables containing that work also fall under Section 6, whether or not they are linked directly with the Library itself.

6. As an exception to the Sections above, you may also combine or link a "work that uses the Library" with the Library to produce a work containing portions of the Library, and distribute that work under terms of your choice, provided that the terms permit modification of the work for the customer's own use and reverse engineering for debugging such modifications.

You must give prominent notice with each copy of the work that the Library is used in it and that the Library and its use are covered by this License. You must supply a copy of this License. If the work during execution displays copyright notices, you must include the copyright notice for the Library among them, as well as a reference directing the user to the copy of this License. Also, you must do one of these things:

- a) Accompany the work with the complete corresponding machine-readable source code for the Library including whatever changes were used in the work (which must be distributed under Sections 1 and 2 above); and, if the work is an executable linked with the Library, with the complete machine-readable "work that uses the Library", as object code and/or source code, so that the user can modify the Library and then relink to produce a modified executable containing the modified Library. (It is understood that the user who changes the contents of definitions files in the Library will not necessarily be able to recompile the application to use the modified definitions.)
- b) Use a suitable shared library mechanism for linking with the Library. A suitable mechanism is one that (1) uses at run time a copy of the library already present on the user's computer system, rather than copying library functions into the executable, and (2) will operate properly with a modified version of the library, if the user installs one, as long as the modified version is interface-compatible with the version that the work was made with.
- c) Accompany the work with a written offer, valid for at least three years, to give the same user the materials specified in Subsection 6a, above, for a charge no more than the cost of performing this distribution.
- d) If distribution of the work is made by offering access to copy from a designated place, offer equivalent access to copy the above specified materials from the same place.
- e) Verify that the user has already received a copy of these materials or that you have already sent this user a copy.

For an executable, the required form of the "work that uses the Library" must include any data and utility programs needed for reproducing the executable from it. However, as a special exception, the materials to be distributed need not include anything that is normally distributed (in either source or binary form) with the major components (compiler, kernel, and so on) of the operating system on which the executable runs, unless that component itself accompanies the executable.

It may happen that this requirement contradicts the license restrictions of other proprietary libraries that do not normally accompany the operating system. Such a contradiction means you cannot use both them and the Library together in an executable that you distribute.

7. You may place library facilities that are a work based on the Library side-by-side in a single library together with other library facilities not covered by this License, and distribute such a combined library, provided that the separate distribution of the work based on the Library and of the other library facilities is otherwise permitted, and provided that you do these two things:

a) Accompany the combined library with a copy of the same work based on the Library, uncombined with any other library facilities. This must be distributed under the terms of the Sections above.

b) Give prominent notice with the combined library of the fact that part of it is a work based on the Library, and explaining where to find the accompanying uncombined form of the same work.

8. You may not copy, modify, sublicense, link with, or distribute the Library except as expressly provided under this License. Any attempt otherwise to copy, modify, sublicense, link with, or distribute the Library is void, and will automatically terminate your rights under this License. However, parties who have received copies, or rights, from you under this License will not have their licenses terminated so long as such parties remain in full compliance.

9. You are not required to accept this License, since you have not signed it. However, nothing else grants you permission to modify or distribute the Library or its derivative works. These actions are prohibited by law if you do not accept this License. Therefore, by modifying or distributing the Library (or any work based on the Library), you indicate your acceptance of this License to do so, and all its terms and conditions for copying, distributing or modifying the Library or works based on it.

10. Each time you redistribute the Library (or any work based on the Library), the recipient automatically receives a license from the original licensor to copy, distribute, link with or modify the Library subject to these terms and conditions. You may not impose any further restrictions on the recipients' exercise of the rights granted herein. You are not responsible for enforcing compliance by third parties with this License.

11. If, as a consequence of a court judgment or allegation of patent infringement or for any other reason (not limited to patent issues), conditions are imposed on you (whether by court order, agreement or otherwise) that contradict the conditions of this License, they do not excuse you from the conditions of this License. If you cannot distribute so as to satisfy simultaneously your obligations under this License and any other pertinent obligations, then as a consequence you may not distribute the Library at all. For example, if a patent license would not permit royalty-free redistribution of the Library by all those who receive copies directly or indirectly through you, then the only way you could satisfy both it and this License would be to refrain entirely from distribution of the Library.

If any portion of this section is held invalid or unenforceable under any particular circumstance, the balance of the section is intended to apply, and the section as a whole is intended to apply in other circumstances.

It is not the purpose of this section to induce you to infringe any patents or other property right claims or to contest validity of any such claims; this section has the sole purpose of protecting the integrity of the free software distribution system which is implemented by public license practices. Many people have made generous contributions to the wide range of software distributed through that system in reliance on consistent application of that system; it is up to the author/donor to decide if he or she is willing to distribute software through any other system and a licensee cannot impose that choice.

This section is intended to make thoroughly clear what is believed to be a consequence of the rest of this License.

12. If the distribution and/or use of the Library is restricted in certain countries either by patents or by copyrighted interfaces, the original copyright holder who places the Library under this License may add an explicit geographical distribution limitation excluding those countries, so that distribution is permitted only in or among countries not thus excluded. In such case, this License incorporates the limitation as if written in the body of this License.

13. The Free Software Foundation may publish revised and/or new versions of the Lesser General Public License from time to time. Such new versions will be similar in spirit to the present version, but may differ in detail to address new problems or concerns.

Each version is given a distinguishing version number. If the Library specifies a version number of this License which applies to it and "any later version", you have the option of following the terms and conditions either of that version or of any later version published by the Free Software Foundation. If the Library does not specify a license version number, you may choose any version ever published by the Free Software Foundation.

14. If you wish to incorporate parts of the Library into other free programs whose distribution conditions are incompatible with these, write to the author to ask for permission. For software which is copyrighted by the Free Software Foundation, write to the Free Software Foundation; we sometimes make exceptions for this. Our decision will be guided by the two goals of preserving the free status of all derivatives of our free software and of promoting the sharing and reuse of software generally.

NO WARRANTY

15. BECAUSE THE LIBRARY IS LICENSED FREE OF CHARGE, THERE IS NO WARRANTY FOR THE LIBRARY, TO THE EXTENT PERMITTED BY APPLICABLE LAW. EXCEPT WHEN OTHERWISE STATED IN WRITING THE COPYRIGHT HOLDERS AND/OR OTHER PARTIES PROVIDE THE LIBRARY "AS IS" WITHOUT WARRANTY OF ANY KIND, EITHER EXPRESSED OR IMPLIED, INCLUDING, BUT NOT LIMITED TO, THE IMPLIED WARRANTIES OF MERCHANTABILITY AND FITNESS FOR A PARTICULAR PURPOSE. THE ENTIRE RISK AS TO THE QUALITY AND PERFORMANCE OF THE LIBRARY IS WITH YOU. SHOULD THE LIBRARY PROVE DEFECTIVE, YOU ASSUME THE COST OF ALL NECESSARY SERVICING, REPAIR OR CORRECTION.

16. IN NO EVENT UNLESS REQUIRED BY APPLICABLE LAW OR AGREED TO IN WRITING WILL ANY COPYRIGHT HOLDER, OR ANY OTHER PARTY WHO MAY MODIFY AND/OR REDISTRIBUTE THE LIBRARY AS PERMITTED ABOVE, BE LIABLE TO YOU FOR DAMAGES, INCLUDING ANY GENERAL, SPECIAL, INCIDENTAL OR CONSEQUENTIAL DAMAGES ARISING OUT OF THE USE OR INABILITY TO USE THE LIBRARY (INCLUDING BUT NOT LIMITED TO LOSS OF DATA OR DATA BEING RENDERED INACCURATE OR LOSSES SUSTAINED BY

YOU OR THIRD PARTIES OR A FAILURE OF THE LIBRARY TO OPERATE WITH ANY OTHER SOFTWARE), EVEN IF SUCH HOLDER OR OTHER PARTY HAS BEEN ADVISED OF THE POSSIBILITY OF SUCH DAMAGES.

END OF TERMS AND CONDITIONS

How to Apply These Terms to Your New Libraries

If you develop a new library, and you want it to be of the greatest possible use to the public, we recommend making it free software that everyone can redistribute and change. You can do so by permitting redistribution under these terms (or, alternatively, under the terms of the ordinary General Public License).

To apply these terms, attach the following notices to the library. It is safest to attach them to the start of each source file to most effectively convey the exclusion of warranty; and each file should have at least the "copyright" line and a pointer to where the full notice is found.

<one line to give the library's name and a brief idea of what it does.> Copyright (C) <year> <name of author>

This library is free software; you can redistribute it and/or modify it under the terms of the GNU Lesser General Public License as published by the Free Software Foundation; either version 2.1 of the License, or (at your option) any later version.

This library is distributed in the hope that it will be useful, but WITHOUT ANY WARRANTY; without even the implied warranty of MERCHANTABILITY or FITNESS FOR A PARTICULAR PURPOSE. See the GNU Lesser General Public License for more details.

You should have received a copy of the GNU Lesser General Public License along with this library; if not, write to the Free Software Foundation, Inc., 51 Franklin Street, Fifth Floor, Boston, MA 02110-1301 USA

Also add information on how to contact you by electronic and paper mail.

You should also get your employer (if you work as a programmer) or your school, if any, to sign a "copyright disclaimer" for the library, if necessary. Here is a sample; alter the names:

Yoyodyne, Inc., hereby disclaims all copyright interest in the library `Frob' (a library for tweaking knobs) written by James Random Hacker.

<signature of Ty Coon>, 1 April 1990
Ty Coon, President of Vice

That's all there is to it!

GNU GENERAL PUBLIC LICENSE

Version 3, 29 June 2007

Copyright (C) 2007 Free Software Foundation, Inc. <<http://fsf.org/>>

Everyone is permitted to copy and distribute verbatim copies of this license document, but changing it is not allowed.

Preamble

The GNU General Public License is a free, copyleft license for software and other kinds of works.

The licenses for most software and other practical works are designed to take away your freedom to share and change the works. By contrast, the GNU General Public License is intended to guarantee your freedom to share and change all versions of a program--to make sure it remains free software for all its users. We, the Free Software Foundation, use the GNU General Public License for most of our software; it applies also to any other work released this way by its authors. You can apply it to your programs, too.

When we speak of free software, we are referring to freedom, not price. Our General Public Licenses are designed to make sure that you have the freedom to distribute copies of free software (and charge for them if you wish), that you receive source code or can get it if you want it, that you can change the software or use pieces of it in new free programs, and that you know you can do these things.

To protect your rights, we need to prevent others from denying you these rights or asking you to surrender the rights. Therefore, you have certain responsibilities if you distribute copies of the software, or if you modify it: responsibilities to respect the freedom of others.

For example, if you distribute copies of such a program, whether gratis or for a fee, you must pass on to the recipients the same freedoms that you received. You must make sure that they, too, receive or can get the source code. And you must show them these terms so they know their rights.

Developers that use the GNU GPL protect your rights with two steps:

(1) assert copyright on the software, and (2) offer you this License giving you legal permission to copy, distribute and/or modify it.

For the developers' and authors' protection, the GPL clearly explains that there is no warranty for this free software. For both users' and authors' sake, the GPL requires that modified versions be marked as changed, so that their problems will not be attributed erroneously to authors of previous versions.

Some devices are designed to deny users access to install or run modified versions of the software inside them, although the manufacturer can do so. This is fundamentally incompatible with the aim of protecting users' freedom to change the software. The systematic pattern of such abuse occurs in the area of products for individuals to use, which is precisely where it is most unacceptable. Therefore, we have designed this version of the GPL to prohibit the practice for those products. If such problems arise substantially in other domains, we stand ready to extend this provision to those domains in future versions of the GPL, as needed to protect the freedom of users.

Finally, every program is threatened constantly by software patents. States should not allow patents to restrict development and use of software on general-purpose computers, but in those that do, we wish to avoid the special danger that patents applied to a free program could make it effectively proprietary. To prevent this, the GPL assures that patents cannot be used to render the program non-free.

The precise terms and conditions for copying, distribution and modification follow.

TERMS AND CONDITIONS

0. Definitions.

"This License" refers to version 3 of the GNU General Public License.

"Copyright" also means copyright-like laws that apply to other kinds of works, such as semiconductor masks.

"The Program" refers to any copyrightable work licensed under this License. Each licensee is addressed as "you". "Licensees" and "recipients" may be individuals or organizations.

To "modify" a work means to copy from or adapt all or part of the work in a fashion requiring copyright permission, other than the making of an exact copy. The resulting work is called a "modified version" of the earlier work or a work "based on" the earlier work.

A "covered work" means either the unmodified Program or a work based on the Program.

To "propagate" a work means to do anything with it that, without permission, would make you directly or secondarily liable for infringement under applicable copyright law, except executing it on a computer or modifying a private copy. Propagation includes copying, distribution (with or without modification), making available to the public, and in some countries other activities as well.

To "convey" a work means any kind of propagation that enables other parties to make or receive copies. Mere interaction with a user through a computer network, with no transfer of a copy, is not conveying.

An interactive user interface displays "Appropriate Legal Notices" to the extent that it includes a convenient and prominently visible feature that (1) displays an appropriate copyright notice, and (2) tells the user that there is no warranty for the work (except to the extent that warranties are provided), that licensees may convey the work under this License, and how to view a copy of this License. If the interface presents a list of user commands or options, such as a menu, a prominent item in the list meets this criterion.

1. Source Code.

The "source code" for a work means the preferred form of the work for making modifications to it. "Object code" means any non-source form of a work.

A "Standard Interface" means an interface that either is an official standard defined by a recognized standards body, or, in the case of interfaces specified for a particular programming language, one that is widely used among developers working in that language.

The "System Libraries" of an executable work include anything, other than the work as a whole, that (a) is included in the normal form of packaging a Major Component, but which is not part of that Major Component, and (b) serves only to enable use of the work with that Major Component, or to implement a Standard Interface for which an implementation is available to the public in source code form. A "Major Component", in this context, means a major essential component (kernel, window system, and so on) of the specific operating system (if any) on which the executable work runs, or a compiler used to produce the work, or an object code interpreter used to run it.

The "Corresponding Source" for a work in object code form means all the source code needed to generate, install, and (for an executable work) run the object code and to modify the work, including scripts to control those activities. However, it does not include the work's System Libraries, or general-purpose tools or generally available free programs which are used unmodified in performing those activities but which are not part of the work. For example, Corresponding Source includes interface definition files associated with source files for the work, and the source code for shared libraries and dynamically linked subprograms that the work is specifically designed to require, such as by intimate data communication or control flow between those subprograms and other parts of the work.

The Corresponding Source need not include anything that users can regenerate automatically from other parts of the Corresponding Source.

The Corresponding Source for a work in source code form is that same work.

2. Basic Permissions.

All rights granted under this License are granted for the term of copyright on the Program, and are irrevocable provided the stated conditions are met. This License explicitly affirms your unlimited permission to run the unmodified Program. The output from running a covered work is covered by this License only if the output, given its content, constitutes a covered work. This License acknowledges your rights of fair use or other equivalent, as provided by copyright law.

You may make, run and propagate covered works that you do not convey, without conditions so long as your license otherwise remains in force. You may convey covered works to others for the sole purpose of having them make modifications exclusively for you, or provide you with facilities for running those works, provided that you comply with the terms of this License in conveying all material for which you do not control copyright. Those thus making or running the covered works for you must do so exclusively on your behalf, under your direction and control, on terms that prohibit them from making any copies of your copyrighted material outside their relationship with you.

Conveying under any other circumstances is permitted solely under the conditions stated below. Sublicensing is not allowed; section 10 makes it unnecessary.

3. Protecting Users' Legal Rights From Anti-Circumvention Law.

No covered work shall be deemed part of an effective technological measure under any applicable law fulfilling obligations under article 11 of the WIPO copyright treaty adopted on 20 December 1996, or similar laws prohibiting or restricting circumvention of such measures.

When you convey a covered work, you waive any legal power to forbid circumvention of technological measures to the extent such circumvention is effected by exercising rights under this License with respect to the covered work, and you disclaim any intention to limit operation or modification of the work as a means of enforcing, against the work's users, your or third parties' legal rights to forbid circumvention of technological measures.

4. Conveying Verbatim Copies.

You may convey verbatim copies of the Program's source code as you receive it, in any medium, provided that you conspicuously and appropriately publish on each copy an appropriate copyright notice; keep intact all notices stating that this License and any non-permissive terms added in accord with section 7 apply to the code; keep intact all notices of the absence of any warranty; and give all recipients a copy of this License along with the Program.

You may charge any price or no price for each copy that you convey, and you may offer support or warranty protection for a fee.

5. Conveying Modified Source Versions.

You may convey a work based on the Program, or the modifications to produce it from the Program, in the form of source code under the terms of section 4, provided that you also meet all of these conditions:

a) The work must carry prominent notices stating that you modified it, and giving a relevant date.

b) The work must carry prominent notices stating that it is released under this License and any conditions added under section

7. This requirement modifies the requirement in section 4 to "keep intact all notices".

c) You must license the entire work, as a whole, under this License to anyone who comes into possession of a copy. This License will therefore apply, along with any applicable section 7 additional terms, to the whole of the work, and all its parts, regardless of how they are packaged. This License gives no permission to license the work in any other way, but it does not invalidate such permission if you have separately received it.

d) If the work has interactive user interfaces, each must display Appropriate Legal Notices; however, if the Program has interactive interfaces that do not display Appropriate Legal Notices, your work need not make them do so.

A compilation of a covered work with other separate and independent works, which are not by their nature extensions of the covered work, and which are not combined with it such as to form a larger program, in or on a volume of a storage or distribution medium, is called an "aggregate" if the compilation and its resulting copyright are not used to limit the access or legal rights of the compilation's users beyond what the individual works permit. Inclusion of a covered work in an aggregate does not cause this License to apply to the other parts of the aggregate.

6. Conveying Non-Source Forms.

You may convey a covered work in object code form under the terms of sections 4 and 5, provided that you also convey the machine-readable Corresponding Source under the terms of this License, in one of these ways:

a) Convey the object code in, or embodied in, a physical product (including a physical distribution medium), accompanied by the Corresponding Source fixed on a durable physical medium customarily used for software interchange.

b) Convey the object code in, or embodied in, a physical product (including a physical distribution medium), accompanied by a written offer, valid for at least three years and valid for as long as you offer spare parts or customer support for that product model, to give anyone who possesses the object code either (1) a copy of the Corresponding Source for all the software in the product that is covered by this License, on a durable physical medium customarily used for software interchange, for a price no more than your reasonable cost of physically performing this conveying of source, or (2) access to copy the Corresponding Source from a network server at no charge.

c) Convey individual copies of the object code with a copy of the written offer to provide the Corresponding Source. This alternative is allowed only occasionally and noncommercially, and only if you received the object code with such an offer, in accord with subsection 6b.

d) Convey the object code by offering access from a designated place (gratis or for a charge), and offer equivalent access to the Corresponding Source in the same way through the same place at no further charge. You need not require recipients to copy the Corresponding Source along with the object code. If the place to copy the object code is a network server, the Corresponding Source may be on a different server (operated by you or a third party) that supports equivalent copying facilities, provided you maintain clear directions next to the object code saying where to find the Corresponding Source. Regardless of what server hosts the Corresponding Source, you remain obligated to ensure that it is available for as long as needed to satisfy these requirements.

e) Convey the object code using peer-to-peer transmission, provided you inform other peers where the object code and Corresponding Source of the work are being offered to the general public at no charge under subsection 6d.

A separable portion of the object code, whose source code is excluded from the Corresponding Source as a System Library, need not be included in conveying the object code work.

A "User Product" is either (1) a "consumer product", which means any tangible personal property which is normally used for personal, family, or household purposes, or (2) anything designed or sold for incorporation into a dwelling. In determining whether a product is a consumer product, doubtful cases shall be resolved in favor of coverage. For a particular product received by a particular user, "normally used" refers to a typical or common use of that class of product, regardless of the status of the particular user or of the way in which the particular user actually uses, or expects or is expected to use, the product. A product is a consumer product regardless of whether the product has substantial commercial, industrial or non-consumer uses, unless such uses represent the only significant mode of use of the product.

"Installation Information" for a User Product means any methods, procedures, authorization keys, or other information required to install and execute modified versions of a covered work in that User Product from a modified version of its

Corresponding Source. The information must suffice to ensure that the continued functioning of the modified object code is in no case prevented or interfered with solely because modification has been made.

If you convey an object code work under this section in, or with, or specifically for use in, a User Product, and the conveying occurs as part of a transaction in which the right of possession and use of the User Product is transferred to the recipient in perpetuity or for a fixed term (regardless of how the transaction is characterized), the Corresponding Source conveyed under this section must be accompanied by the Installation Information. But this requirement does not apply if neither you nor any third party retains the ability to install modified object code on the User Product (for example, the work has been installed in ROM).

The requirement to provide Installation Information does not include a requirement to continue to provide support service, warranty, or updates for a work that has been modified or installed by the recipient, or for the User Product in which it has been modified or installed. Access to a network may be denied when the modification itself materially and adversely affects the operation of the network or violates the rules and protocols for communication across the network.

Corresponding Source conveyed, and Installation Information provided, in accord with this section must be in a format that is publicly documented (and with an implementation available to the public in source code form), and must require no special password or key for unpacking, reading or copying.

7. Additional Terms.

"Additional permissions" are terms that supplement the terms of this License by making exceptions from one or more of its conditions. Additional permissions that are applicable to the entire Program shall be treated as though they were included in this License, to the extent that they are valid under applicable law. If additional permissions apply only to part of the Program, that part may be used separately under those permissions, but the entire Program remains governed by this License without regard to the additional permissions.

When you convey a copy of a covered work, you may at your option remove any additional permissions from that copy, or from any part of it. (Additional permissions may be written to require their own removal in certain cases when you modify the work.) You may place additional permissions on material, added by you to a covered work, for which you have or can give appropriate copyright permission.

Notwithstanding any other provision of this License, for material you add to a covered work, you may (if authorized by the copyright holders of that material) supplement the terms of this License with terms:

- a) Disclaiming warranty or limiting liability differently from the terms of sections 15 and 16 of this License; or
- b) Requiring preservation of specified reasonable legal notices or author attributions in that material or in the Appropriate Legal Notices displayed by works containing it; or
- c) Prohibiting misrepresentation of the origin of that material, or requiring that modified versions of such material be marked in reasonable ways as different from the original version; or
- d) Limiting the use for publicity purposes of names of licensors or authors of the material; or
- e) Declining to grant rights under trademark law for use of some trade names, trademarks, or service marks; or
- f) Requiring indemnification of licensors and authors of that material by anyone who conveys the material (or modified versions of it) with contractual assumptions of liability to the recipient, for any liability that these contractual assumptions directly impose on those licensors and authors.

All other non-permissive additional terms are considered "further restrictions" within the meaning of section 10. If the Program as you received it, or any part of it, contains a notice stating that it is governed by this License along with a term that is a further restriction, you may remove that term. If a license document contains a further restriction but permits

relicensing or conveying under this License, you may add to a covered work material governed by the terms of that license document, provided that the further restriction does not survive such relicensing or conveying.

If you add terms to a covered work in accord with this section, you must place, in the relevant source files, a statement of the additional terms that apply to those files, or a notice indicating where to find the applicable terms.

Additional terms, permissive or non-permissive, may be stated in the form of a separately written license, or stated as exceptions; the above requirements apply either way.

8. Termination.

You may not propagate or modify a covered work except as expressly provided under this License. Any attempt otherwise to propagate or modify it is void, and will automatically terminate your rights under this License (including any patent licenses granted under the third paragraph of section 11).

However, if you cease all violation of this License, then your license from a particular copyright holder is reinstated (a) provisionally, unless and until the copyright holder explicitly and finally terminates your license, and (b) permanently, if the copyright holder fails to notify you of the violation by some reasonable means prior to 60 days after the cessation.

Moreover, your license from a particular copyright holder is reinstated permanently if the copyright holder notifies you of the violation by some reasonable means, this is the first time you have received notice of violation of this License (for any work) from that copyright holder, and you cure the violation prior to 30 days after your receipt of the notice.

Termination of your rights under this section does not terminate the licenses of parties who have received copies or rights from you under this License. If your rights have been terminated and not permanently reinstated, you do not qualify to receive new licenses for the same material under section 10.

9. Acceptance Not Required for Having Copies.

You are not required to accept this License in order to receive or run a copy of the Program. Ancillary propagation of a covered work occurring solely as a consequence of using peer-to-peer transmission to receive a copy likewise does not require acceptance. However, nothing other than this License grants you permission to propagate or modify any covered work. These actions infringe copyright if you do not accept this License. Therefore, by modifying or propagating a covered work, you indicate your acceptance of this License to do so.

10. Automatic Licensing of Downstream Recipients.

Each time you convey a covered work, the recipient automatically receives a license from the original licensors, to run, modify and propagate that work, subject to this License. You are not responsible for enforcing compliance by third parties with this License.

An "entity transaction" is a transaction transferring control of an organization, or substantially all assets of one, or subdividing an organization, or merging organizations. If propagation of a covered work results from an entity transaction, each party to that transaction who receives a copy of the work also receives whatever licenses to the work the party's predecessor in interest had or could give under the previous paragraph, plus a right to possession of the Corresponding Source of the work from the predecessor in interest, if the predecessor has it or can get it with reasonable efforts.

You may not impose any further restrictions on the exercise of the rights granted or affirmed under this License. For example, you may not impose a license fee, royalty, or other charge for exercise of rights granted under this License, and you may not initiate litigation (including a cross-claim or counterclaim in a lawsuit) alleging that any patent claim is infringed by making, using, selling, offering for sale, or importing the Program or any portion of it.

11. Patents.

A "contributor" is a copyright holder who authorizes use under this License of the Program or a work on which the Program is based. The work thus licensed is called the contributor's "contributor version".

A contributor's "essential patent claims" are all patent claims owned or controlled by the contributor, whether already acquired or hereafter acquired, that would be infringed by some manner, permitted by this License, of making, using, or selling its contributor version, but do not include claims that would be infringed only as a consequence of further modification of the contributor version. For purposes of this definition, "control" includes the right to grant patent sublicenses in a manner consistent with the requirements of this License.

Each contributor grants you a non-exclusive, worldwide, royalty-free patent license under the contributor's essential patent claims, to make, use, sell, offer for sale, import and otherwise run, modify and propagate the contents of its contributor version.

In the following three paragraphs, a "patent license" is any express agreement or commitment, however denominated, not to enforce a patent (such as an express permission to practice a patent or covenant not to sue for patent infringement). To "grant" such a patent license to a party means to make such an agreement or commitment not to enforce a patent against the party.

If you convey a covered work, knowingly relying on a patent license, and the Corresponding Source of the work is not available for anyone to copy, free of charge and under the terms of this License, through a publicly available network server or other readily accessible means, then you must either (1) cause the Corresponding Source to be so available, or (2) arrange to deprive yourself of the benefit of the patent license for this particular work, or (3) arrange, in a manner consistent with the requirements of this License, to extend the patent license to downstream recipients. "Knowingly relying" means you have actual knowledge that, but for the patent license, your conveying the covered work in a country, or your recipient's use of the covered work in a country, would infringe one or more identifiable patents in that country that you have reason to believe are valid.

If, pursuant to or in connection with a single transaction or arrangement, you convey, or propagate by procuring conveyance of, a covered work, and grant a patent license to some of the parties receiving the covered work authorizing them to use, propagate, modify or convey a specific copy of the covered work, then the patent license you grant is automatically extended to all recipients of the covered work and works based on it.

A patent license is "discriminatory" if it does not include within the scope of its coverage, prohibits the exercise of, or is conditioned on the non-exercise of one or more of the rights that are specifically granted under this License. You may not convey a covered work if you are a party to an arrangement with a third party that is in the business of distributing software, under which you make payment to the third party based on the extent of your activity of conveying the work, and under which the third party grants, to any of the parties who would receive the covered work from you, a discriminatory patent license (a) in connection with copies of the covered work conveyed by you (or copies made from those copies), or (b) primarily for and in connection with specific products or compilations that contain the covered work, unless you entered into that arrangement, or that patent license was granted, prior to 28 March 2007.

Nothing in this License shall be construed as excluding or limiting any implied license or other defenses to infringement that may otherwise be available to you under applicable patent law.

12. No Surrender of Others' Freedom.

If conditions are imposed on you (whether by court order, agreement or otherwise) that contradict the conditions of this License, they do not excuse you from the conditions of this License. If you cannot convey a covered work so as to satisfy simultaneously your obligations under this License and any other pertinent obligations, then as a consequence you may not convey it at all. For example, if you agree to terms that obligate you to collect a royalty for further conveying from those to whom you convey the Program, the only way you could satisfy both those terms and this License would be to refrain entirely from conveying the Program.

13. Use with the GNU Affero General Public License.

Notwithstanding any other provision of this License, you have permission to link or combine any covered work with a work licensed under version 3 of the GNU Affero General Public License into a single combined work, and to convey the resulting work. The terms of this License will continue to apply to the part which is the covered work, but the special requirements of the GNU Affero General Public License, section 13, concerning interaction through a network will apply to the combination as such.

14. Revised Versions of this License.

The Free Software Foundation may publish revised and/or new versions of the GNU General Public License from time to time. Such new versions will be similar in spirit to the present version, but may differ in detail to address new problems or concerns.

Each version is given a distinguishing version number. If the Program specifies that a certain numbered version of the GNU General Public License "or any later version" applies to it, you have the option of following the terms and conditions either of that numbered version or of any later version published by the Free Software Foundation. If the Program does not specify a version number of the GNU General Public License, you may choose any version ever published by the Free Software Foundation.

If the Program specifies that a proxy can decide which future versions of the GNU General Public License can be used, that proxy's public statement of acceptance of a version permanently authorizes you to choose that version for the Program.

Later license versions may give you additional or different permissions. However, no additional obligations are imposed on any author or copyright holder as a result of your choosing to follow a later version.

15. Disclaimer of Warranty.

THERE IS NO WARRANTY FOR THE PROGRAM, TO THE EXTENT PERMITTED BY APPLICABLE LAW. EXCEPT WHEN OTHERWISE STATED IN WRITING THE COPYRIGHT HOLDERS AND/OR OTHER PARTIES PROVIDE THE PROGRAM "AS IS" WITHOUT WARRANTY OF ANY KIND, EITHER EXPRESSED OR IMPLIED, INCLUDING, BUT NOT LIMITED TO, THE IMPLIED WARRANTIES OF MERCHANTABILITY AND FITNESS FOR A PARTICULAR PURPOSE. THE ENTIRE RISK AS TO THE QUALITY AND PERFORMANCE OF THE PROGRAM IS WITH YOU. SHOULD THE PROGRAM PROVE DEFECTIVE, YOU ASSUME THE COST OF ALL NECESSARY SERVICING, REPAIR OR CORRECTION.

16. Limitation of Liability.

IN NO EVENT UNLESS REQUIRED BY APPLICABLE LAW OR AGREED TO IN WRITING WILL ANY COPYRIGHT HOLDER, OR ANY OTHER PARTY WHO MODIFIES AND/OR CONVEYS THE PROGRAM AS PERMITTED ABOVE, BE LIABLE TO YOU FOR DAMAGES, INCLUDING ANY GENERAL, SPECIAL, INCIDENTAL OR CONSEQUENTIAL DAMAGES ARISING OUT OF THE USE OR INABILITY TO USE THE PROGRAM (INCLUDING BUT NOT LIMITED TO LOSS OF DATA OR DATA BEING RENDERED INACCURATE OR LOSSES SUSTAINED BY YOU OR THIRD PARTIES OR A FAILURE OF THE PROGRAM TO OPERATE WITH ANY OTHER PROGRAMS), EVEN IF SUCH HOLDER OR OTHER PARTY HAS BEEN ADVISED OF THE POSSIBILITY OF SUCH DAMAGES.

17. Interpretation of Sections 15 and 16.

If the disclaimer of warranty and limitation of liability provided above cannot be given local legal effect according to their terms, reviewing courts shall apply local law that most closely approximates an absolute waiver of all civil liability in connection with the Program, unless a warranty or assumption of liability accompanies a copy of the Program in return for a fee.

END OF TERMS AND CONDITIONS

How to Apply These Terms to Your New Programs

If you develop a new program, and you want it to be of the greatest possible use to the public, the best way to achieve this is to make it free software which everyone can redistribute and change under these terms.

To do so, attach the following notices to the program. It is safest to attach them to the start of each source file to most effectively state the exclusion of warranty; and each file should have at least the "copyright" line and a pointer to where the full notice is found.

```
<one line to give the program's name and a brief idea of what it does.>  
Copyright (C) <year> <name of author>
```

This program is free software: you can redistribute it and/or modify it under the terms of the GNU General Public License as published by the Free Software Foundation, either version 3 of the License, or (at your option) any later version.

This program is distributed in the hope that it will be useful, but WITHOUT ANY WARRANTY; without even the implied warranty of MERCHANTABILITY or FITNESS FOR A PARTICULAR PURPOSE. See the GNU General Public License for more details.

You should have received a copy of the GNU General Public License along with this program. If not, see <http://www.gnu.org/licenses/>.

Also add information on how to contact you by electronic and paper mail.

If the program does terminal interaction, make it output a short notice like this when it starts in an interactive mode:

```
<program> Copyright (C) <year> <name of author>  
This program comes with ABSOLUTELY NO WARRANTY; for details type `show w'.  
This is free software, and you are welcome to redistribute it under certain conditions; type `show c' for details.
```

The hypothetical commands `show w' and `show c' should show the appropriate parts of the General Public License. Of course, your program's commands might be different; for a GUI interface, you would use an "about box".

You should also get your employer (if you work as a programmer) or school, if any, to sign a "copyright disclaimer" for the program, if necessary.

For more information on this, and how to apply and follow the GNU GPL, see <http://www.gnu.org/licenses/>.

The GNU General Public License does not permit incorporating your program into proprietary programs. If your program is a subroutine library, you may consider it more useful to permit linking proprietary applications with the library. If this is what you want to do, use the GNU Lesser General Public License instead of this License. But first, please read <http://www.gnu.org/philosophy/why-not-lgpl.html>.

-----libtiff-----

Copyright (c) 1988-1997 Sam Leffler
Copyright (c) 1991-1997 Silicon Graphics, Inc.

Permission to use, copy, modify, distribute, and sell this software and its documentation for any purpose is hereby granted without fee, provided that (i) the above copyright notices and this permission notice appear in all copies of the software and related documentation, and (ii) the names of Sam Leffler and Silicon Graphics may not be used in any advertising or publicity relating to the software without the specific, prior written permission of Sam Leffler and Silicon Graphics.

THE SOFTWARE IS PROVIDED "AS-IS" AND WITHOUT WARRANTY OF ANY KIND, EXPRESS, IMPLIED OR OTHERWISE, INCLUDING WITHOUT LIMITATION, ANY WARRANTY OF MERCHANTABILITY OR FITNESS FOR A PARTICULAR PURPOSE.

IN NO EVENT SHALL SAM LEFFLER OR SILICON GRAPHICS BE LIABLE FOR ANY SPECIAL, INCIDENTAL, INDIRECT OR CONSEQUENTIAL DAMAGES OF ANY KIND, OR ANY DAMAGES WHATSOEVER RESULTING FROM LOSS OF USE, DATA OR PROFITS, WHETHER OR NOT ADVISED OF THE POSSIBILITY OF DAMAGE, AND ON ANY THEORY OF LIABILITY, ARISING OUT OF OR IN CONNECTION WITH THE USE OR PERFORMANCE OF THIS SOFTWARE.

-----libjpeg-----

This software is based in part on the work of the Independent JPEG Group.

SOFTWARE LICENSE

PLEASE READ THIS LICENSE CAREFULLY BEFORE USING THE SOFTWARE. BY USING THE SOFTWARE, YOU ARE AGREEING TO BE BOUND BY THE TERMS OF THIS LICENSE.

1. License

The application, demonstration, system and other software accompanying this License, whether on disk, in read only memory, or on any other media (the "Software") and related documentation are licensed to you by SHARP. You own the disk on which the Software is recorded but SHARP and/or SHARP's Licensors retain title to the Software and related documentation. This License allows you to use the Software on one or more computers connected to a single printer and make one copy of the Software in machine-readable form for backup purposes only. You must reproduce on such copy the SHARP copyright notice, the copyright notice of SHARP's Licensors and any other proprietary legends of SHARP and/or its Licensors that were on the original copy of the Software. You may also transfer all your license rights in the Software, the backup copy of the Software, the related documentation and a copy of this License to another party, provided the other party reads and agrees to the terms and conditions of this License.

2. Restrictions

The Software contains copyrighted material, trade secrets and other proprietary material which is owned by SHARP and/or its Licensors and in order to protect them you may not decompile, reverse engineer, disassemble or otherwise reduce the Software to a human-perceivable form. You may not modify, network, rent, lease, loan, distribute or create derivative works based upon the Software in whole or in part. You may not electronically transmit the Software from one computer to another or over a network.

3. Termination

This license is effective until terminated. You may terminate this License at any time by destroying the Software and related documentation and all copies thereof. This License will terminate immediately without notice from SHARP and/or SHARP's Licensors if you fail to comply with any provision of this License. Upon termination you must destroy the Software and related documentation and all copies thereof.

4. Export Law Assurances

You agree and certify that neither the Software nor any other technical data received from SHARP, nor the direct product thereof, will be exported outside the United States except as authorized and as permitted by the laws and regulations of the United States. If the Software has been rightfully obtained by you outside of the United States, you agree that you will not re-export the Software nor any other technical data received from SHARP, nor the direct product thereof, except as permitted by the laws and regulations of the United States and the laws and the regulation of the jurisdiction in which you obtained the Software.

5. Government End Users

If you are acquiring the Software on behalf of any unit or agency of the United States Government, the following provisions apply. The Government agrees:

- (i) if the Software is supplied to the Department of Defense (DoD), the Software is classified as "Commercial Computer Software" and the Government is acquiring only "restricted rights" in the Software and its documentation as that term is defined in Clause 252.227-7013 (c)(1) (Oct., 1988) of the DFARS; and
- (ii) if the Software is supplied to any unit or agency of the United States Government other than DoD, the Software is classified as "Commercial" that term is defined at 48 C.F.R. 2.101 and as "Commercial Computer Software" that term is defined in 48 C.F.R. 12.212, and the Government's rights in the Software and its documentation will be as defined in Clause 52.227-19 (c)(2) of the FAR or, in the case of NASA, in Clause 18-52.227-86 (d) of the NASA Supplement to the FAR.

6. Limited Warranty on Media.

SHARP warrants the disks on which the Software is recorded to be free from defects in materials and workmanship under normal use for a period of ninety (90) days from the date of purchase as evidenced by a copy of the receipt. The entire liability of SHARP and/or its Licensors and your exclusive remedy will be replacement of the disk which fails to meet the limited warranty provided by this Clause 6. A disk will be replaced when it is returned to SHARP or a SHARP authorized representative with a copy of the receipt. SHARP will have no responsibility to replace a disk damaged by accident, abuse or misapplication.

ANY IMPLIED WARRANTIES ON THE DISKS, INCLUDING THE IMPLIED WARRANTIES OF MERCHANTABILITY AND FITNESS FOR A PARTICULAR PURPOSE, ARE LIMITED IN DURATION TO NINETY (90) DAYS FROM THE DATE OF DELIVERY. THIS WARRANTY GIVES YOU SPECIFIC LEGAL RIGHTS, AND YOU MAY ALSO HAVE OTHER RIGHTS WHICH VARY FROM JURISDICTION TO JURISDICTION.

7. Disclaimer of Warranty on Software

You expressly acknowledge and agree that use of the Software is at your sole risk. The Software and related documentation are provided "AS IS" and without warranty of any kind and SHARP and SHARP's Licensor(s) (for the purpose of provisions 6 and 7, SHARP and SHARP's Licensor(s) shall be collectively referred to as "SHARP") EXPRESSLY DISCLAIM ALL WARRANTIES, EXPRESS OR IMPLIED, INCLUDING, BUT NOT LIMITED TO, THE IMPLIED WARRANTIES OF MERCHANTABILITY AND FITNESS FOR A PARTICULAR PURPOSE. SHARP DOES NOT WARRANT THAT THE FUNCTIONS CONTAINED IN THE SOFTWARE WILL MEET YOUR REQUIREMENTS, OR THAT THE OPERATION OF THE SOFTWARE WILL BE UNINTERRUPTED OR ERROR-FREE, OR THAT DEFECTS IN THE SOFTWARE WILL BE CORRECTED. FURTHERMORE, SHARP DOES NOT WARRANT OR MAKE ANY REPRESENTATIONS REGARDING THE USE OR THE RESULTS OF THE USE OF THE SOFTWARE OR RELATED DOCUMENTATION IN TERMS OF THEIR CORRECTNESS, ACCURACY, RELIABILITY, OR OTHERWISE. NO ORAL OR WRITTEN INFORMATION OR ADVICE GIVEN BY SHARP OR A SHARP AUTHORIZED REPRESENTATIVE SHALL CREATE A WARRANTY OR IN ANY WAY INCREASE THE SCOPE OF THIS WARRANTY. SHOULD THE SOFTWARE PROVE DEFECTIVE, YOU (AND NOT SHARP OR A SHARP AUTHORIZED REPRESENTATIVE) ASSUME THE ENTIRE COST OF ALL NECESSARY SERVICING, REPAIR OR CORRECTION, SOME JURISDICTIONS DO NOT ALLOW THE EXCLUSION OF IMPLIED WARRANTIES, SO THE ABOVE EXCLUSION MAY NOT APPLY TO YOU.

8. Limitation of Liability

UNDER NO CIRCUMSTANCES INCLUDING NEGLIGENCE, SHALL SHARP BE LIABLE FOR ANY INCIDENTAL, SPECIAL OR CONSEQUENTIAL DAMAGES THAT RESULT FROM THE USE OR INABILITY TO USE THE SOFTWARE OR RELATED DOCUMENTATION, EVEN IF SHARP OR A SHARP AUTHORIZED REPRESENTATIVE HAS BEEN ADVISED OF THE POSSIBILITY OF SUCH DAMAGES. SOME JURISDICTIONS DO NOT ALLOW THE LIMITATION OR EXCLUSION OF LIABILITY FOR INCIDENTAL OR CONSEQUENTIAL DAMAGES SO THE ABOVE LIMITATION OR EXCLUSION MAY NOT APPLY TO YOU.

In no event shall SHARP's total liability to you for all damages, losses, and causes of action (whether in contract, tort (including negligence) or otherwise) exceed the amount paid by you for the Software.

9. Controlling Law and Severability

For a portion of the Software related with Apple Macintosh and Microsoft Windows, this license shall be governed by and construed in accordance with the laws of the state of California and Washington, respectively. If for any reason a court of competent jurisdiction finds any provision of this License, or portion thereof, to be unenforceable, that provision of the License shall be enforced to the maximum extent permissible so as to effect the intent of the parties, and the remainder of this License shall continue in full force and effect.

10. Complete Agreement

This License constitutes the entire agreement between the parties with respect to the use of the Software and related documentation, and supersedes all prior or contemporaneous understandings or agreements, written or oral, regarding such subject matter. No amendment to or modification of this License will be binding unless in writing and signed by a duly authorized representative of SHARP.

SHARP
SHARP CORPORATION