

DIGITAL FULL COLOR MULTIFUNCTIONAL SYSTEM MX-C557F/MX-C607F

User's Guide

October 2021

Machine type:

7564

Models:

5H6, 5H8

Contents

- Safety information.....7**
 - Conventions.....7
 - Product statements.....7

- Learning about the printer..... 10**
 - Selecting a location for the printer..... 10
 - Printer configurations..... 11
 - Attaching cables..... 13
 - Using the control panel..... 15
 - Understanding the status of the power button and indicator light..... 16
 - Using the home screen.....16
 - Printing the Menu Settings Page..... 17

- Setting up and using the home screen applications..... 18**
 - Customizing the home screen..... 18
 - Setting up Forms and Favorites..... 18
 - Setting up Card Copy.....18
 - Using Shortcut Center.....19
 - Setting up Scan Center.....19
 - Managing bookmarks..... 19
 - Managing contacts..... 20

- Loading paper and specialty media..... 23**
 - Setting the size and type of the specialty media..... 23
 - Configuring Universal paper settings..... 23
 - Loading trays..... 23
 - Loading the multipurpose feeder..... 25
 - Linking trays..... 27

- Paper support.....28**
 - Supported paper sizes.....28
 - Supported paper types..... 31
 - Supported paper weights.....33

Printing.....35

- Printing from a computer.....35
- Printing forms..... 35
- Printing from a mobile device..... 35
- Printing from a flash drive..... 36
- Supported flash drives and file types.....37
- Configuring confidential jobs..... 38
- Printing confidential and other held jobs..... 38
- Printing a font sample list..... 39
- Printing a directory list..... 39
- Canceling a print job..... 40

Copying.....41

- Using the automatic document feeder and scanner glass..... 41
- Making copies..... 41
- Copying photos.....41
- Copying on letterhead..... 42
- Copying on both sides of the paper.....42
- Reducing or enlarging copies..... 42
- Collating copies..... 42
- Placing separator sheets between copies..... 42
- Copying multiple pages onto a single sheet.....43
- Creating a copy shortcut..... 43

E-mailing..... 44

- Using the automatic document feeder and scanner glass..... 44
- Configuring the e-mail SMTP settings..... 44
- Sending an e-mail..... 52
- Creating an e-mail shortcut..... 52

Faxing.....53

- Using the automatic document feeder and scanner glass..... 53
- Setting up the printer to fax.....53
- Sending a fax.....60
- Scheduling a fax..... 61
- Creating a fax destination shortcut.....61

Changing the fax resolution..... 61
Adjusting the fax darkness..... 61
Printing a fax log..... 62
Blocking junk faxes..... 62
Holding faxes..... 62
Forwarding a fax..... 62

Scanning..... 64

Using the automatic document feeder and scanner glass..... 64
Scanning to a computer..... 64
Scanning to an FTP server..... 65
Creating an FTP shortcut..... 65
Creating a network folder shortcut..... 65
Scanning to a flash drive..... 66
Scanning to a fax server..... 67
Scanning to a network folder..... 67

Understanding the printer menus..... 68

Menu map..... 68
Device..... 69
Print..... 81
Paper..... 90
Copy..... 93
Fax..... 96
E-mail..... 101
FTP..... 107
USB Drive..... 111
Network/Ports..... 116
Security..... 128
Reports..... 135
Help..... 136
Troubleshooting..... 137

Securing the printer..... 138

Locating the security slot..... 138
Erasing printer memory..... 138
Erasing printer hard disk memory..... 138

Encrypting the printer hard disk.....	139
Restoring factory default settings.....	139
Statement of Volatility.....	139
Maintaining the printer.....	141
Adjusting the speaker volume.....	141
Networking.....	141
Cleaning printer parts.....	145
Ordering parts and supplies.....	147
Replacing parts and supplies.....	148
Storing supplies.....	190
Moving the printer.....	190
Saving energy and paper.....	191
Clearing jams.....	193
Avoiding jams.....	193
Identifying jam locations.....	194
Paper jam in trays.....	195
Paper jam in the multipurpose feeder.....	197
Paper jam in the automatic document feeder.....	198
Paper jam in the standard bin.....	200
Paper jam in door B.....	201
Paper jam in the finisher bin.....	204
Staple jam in door G.....	206
Paper jam in door K.....	209
Paper jam in door J.....	210
Paper jam in door N.....	212
Paper jam in door L.....	213
Paper jam in the staple finisher bin.....	214
Staple jam in door J.....	214
Troubleshooting.....	217
Network connection problems.....	217
Hardware options problems.....	219
Issues with supplies.....	219
Paper feed problems.....	220
Printing problems.....	223

Color quality problems..... 242
Faxing problems.....245
Scanning problems.....248
Contacting your dealer.....252

Upgrading and migrating.....253

Hardware..... 253
Software.....274
Firmware..... 277

Notices..... 279

Index.....292

Safety information

Conventions

Note: A *note* identifies information that could help you.

Warning: A *warning* identifies something that could damage the product hardware or software.

CAUTION: A *caution* indicates a potentially hazardous situation that could injure you.

Different types of caution statements include:



CAUTION—POTENTIAL INJURY: Indicates a risk of injury.



CAUTION—SHOCK HAZARD: Indicates a risk of electrical shock.



CAUTION—HOT SURFACE: Indicates a risk of burn if touched.



CAUTION—TIPPING HAZARD: Indicates a crush hazard.



CAUTION—PINCH HAZARD: Indicates a risk of being caught between moving parts.

Product statements



CAUTION—POTENTIAL INJURY: To avoid the risk of fire or electrical shock, connect the power cord to an appropriately rated and properly grounded electrical outlet that is near the product and easily accessible.



CAUTION—POTENTIAL INJURY: To avoid the risk of fire or electrical shock, use only the power cord provided with this product or the manufacturer's authorized replacement.



CAUTION—POTENTIAL INJURY: Do not use this product with extension cords, multioutlet power strips, multioutlet extenders, or UPS devices. The power capacity of these types of accessories can be easily overloaded by a laser printer and may result in a risk of fire, property damage, or poor printer performance.



CAUTION—POTENTIAL INJURY: Do not use this product with an inline surge protector. The use of a surge protection device may result in a risk of fire, property damage, or poor printer performance.



CAUTION—POTENTIAL INJURY: To reduce the risk of fire, use only a 26 AWG or larger telecommunications (RJ-11) cord when connecting this product to the public switched telephone network. For users in Australia, the cord must be approved by the Australian Communications and Media Authority.





CAUTION—SHOCK HAZARD: To avoid the risk of electrical shock, do not place or use this product near water or wet locations.





CAUTION—SHOCK HAZARD: To avoid the risk of electrical shock, do not set up this product or make any electrical or cabling connections, such as the power cord, fax feature, or telephone, during a lightning storm.

 **CAUTION—POTENTIAL INJURY:** Do not cut, twist, bind, crush, or place heavy objects on the power cord. Do not subject the power cord to abrasion or stress. Do not pinch the power cord between objects such as furniture and walls. If any of these things happen, a risk of fire or electrical shock results. Inspect the power cord regularly for signs of such problems. Remove the power cord from the electrical outlet before inspecting it.

 **CAUTION—SHOCK HAZARD:** To avoid the risk of electrical shock, make sure that all external connections (such as Ethernet and telephone system connections) are properly installed in their marked plug-in ports.

 **CAUTION—SHOCK HAZARD:** To avoid the risk of electrical shock, if you are accessing the controller board or installing optional hardware or memory devices sometime after setting up the printer, then turn the printer off, and unplug the power cord from the electrical outlet before continuing. If you have any other devices attached to the printer, then turn them off as well, and unplug any cables going into the printer.

 **CAUTION—SHOCK HAZARD:** To avoid the risk of electrical shock, do not use the fax feature during a lightning storm.





 **CAUTION—SHOCK HAZARD:** To avoid the risk of electrical shock when cleaning the exterior of the printer, unplug the power cord from the electrical outlet and disconnect all cables from the printer before proceeding.

 **CAUTION—POTENTIAL INJURY:** If the printer weight is greater than 20 kg (44 lb), then it may require two or more people to lift it safely.

 **CAUTION—POTENTIAL INJURY:** When moving the printer, follow these guidelines to avoid personal injury or printer damage:

- Make sure that all doors and trays are closed.
- Turn off the printer, and then unplug the power cord from the electrical outlet.
- Disconnect all cords and cables from the printer.
- If the printer has separate floor-standing optional trays or output options attached to it, then disconnect them before moving the printer.
- If the printer has a caster base, then carefully roll it to the new location. Use caution when passing over thresholds and breaks in flooring.
- If the printer does not have a caster base but is configured with optional trays or output options, then remove the output options and lift the printer off the trays. Do not try to lift the printer and any options at the same time.
- Always use the handholds on the printer to lift it.
- Any cart used to move the printer must have a surface able to support the full footprint of the printer.
- Any cart used to move the hardware options must have a surface able to support the dimensions of the options.
- Keep the printer in an upright position.
- Avoid severe jarring movements.
- Make sure that your fingers are not under the printer when you set it down.
- Make sure that there is adequate clearance around the printer.

 **CAUTION—TIPPING HAZARD:** Installing one or more options on your printer or MFP may require a caster base, furniture, or other feature to prevent instability causing possible injury. For more information on supported configurations, contact the place where you purchased the printer.

-  **CAUTION—TIPPING HAZARD:** To reduce the risk of equipment instability, load each tray separately. Keep all other trays closed until needed.
-  **CAUTION—HOT SURFACE:** The inside of the printer might be hot. To reduce the risk of injury from a hot component, allow the surface to cool before touching it.
-  **CAUTION—PINCH HAZARD:** To avoid the risk of a pinch injury, use caution in areas marked with this label. Pinch injuries may occur around moving parts, such as gears, doors, trays, and covers.
-  **CAUTION—POTENTIAL INJURY:** This product uses a laser. Use of controls or adjustments or performance of procedures other than those specified in the *User's Guide* may result in hazardous radiation exposure.
-  **CAUTION—POTENTIAL INJURY:** The lithium battery in this product is not intended to be replaced. There is a danger of explosion if a lithium battery is incorrectly replaced. Do not recharge, disassemble, or incinerate a lithium battery. Discard used lithium batteries according to the manufacturer's instructions and local regulations.

This product is designed, tested, and approved to meet strict global safety standards with the use of specific manufacturer's components. The safety features of some parts may not always be obvious. The manufacturer is not responsible for the use of other replacement parts.

Refer service or repairs, other than those described in the user documentation, to a service representative.

SAVE THESE INSTRUCTIONS.

Learning about the printer

Selecting a location for the printer

When selecting a location for the printer, leave enough room to open trays, covers, and doors and to install hardware options.

- Set up the printer near an electrical outlet.

 **CAUTION—POTENTIAL INJURY:** To avoid the risk of fire or electrical shock, connect the power cord to an appropriately rated and properly grounded electrical outlet that is near the product and easily accessible.

 **CAUTION—SHOCK HAZARD:** To avoid the risk of electrical shock, do not place or use this product near water or wet locations.

- Make sure that airflow in the room meets the latest revision of the ASHRAE 62 standard or the CEN Technical Committee 156 standard.
- Provide a flat, sturdy, and stable surface.
- Keep the printer:
 - Clean, dry, and free of dust.
 - Away from stray staples and paper clips.
 - Away from the direct airflow of air conditioners, heaters, or ventilators.
 - Free from direct sunlight and humidity extremes.
- Observe the recommended temperatures and avoid fluctuations:

Ambient temperature	10 to 32.2°C (50 to 90°F)
Storage temperature	-40 to 43.3°C (-40 to 110°F)

- Allow the following recommended amount of space around the printer for proper ventilation:



1	Top	330 mm (13 in.)
2	Right side	152 mm (6 in.)
3	Front	381 mm (15 in.)
4	Left side	457 mm (18 in.)
5	Rear	203 mm (8 in.)

Printer configurations

Note: Make sure to configure the printer on a flat, sturdy, and stable surface.

Basic model

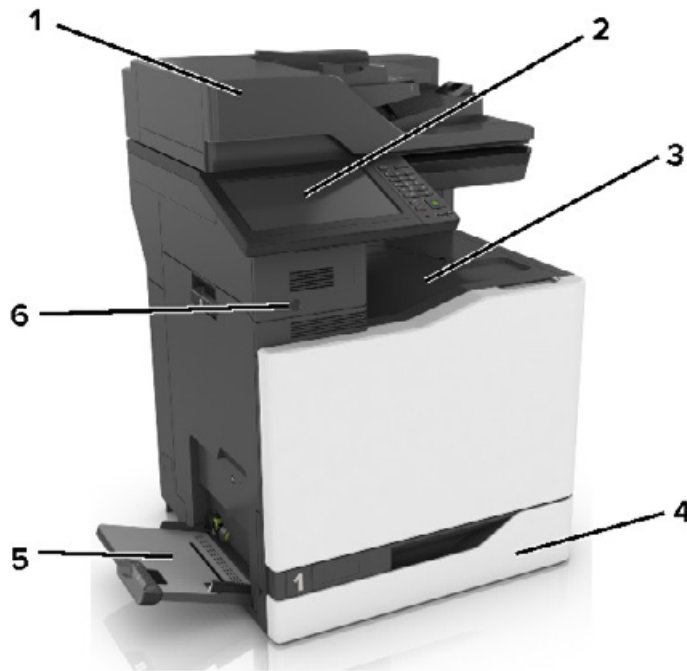

1	Automatic document feeder (ADF)
2	Control panel
3	Standard bin
4	Standard 550-sheet tray
5	Multipurpose feeder
6	Proximity sensor Note: Available only in some printer units.

Configured model

CAUTION—TIPPING HAZARD: Installing one or more options on your printer or MFP may require a caster base, furniture, or other feature to prevent instability causing possible injury. For more information on supported configurations, contact the place where you purchased the printer.

CAUTION—TIPPING HAZARD: To reduce the risk of equipment instability, load each tray separately. Keep all other trays closed until needed.

You can configure your printer by adding an optional 2200-sheet tray or a combination of up to three optional 550-sheet trays or envelope trays.

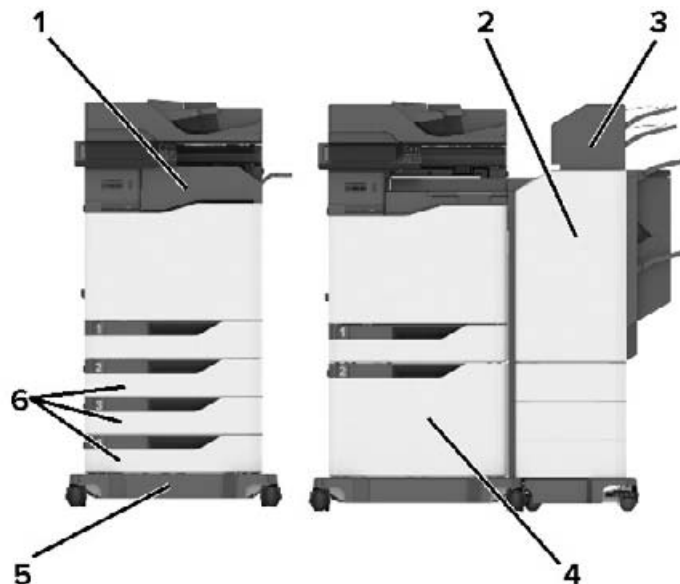

1	Staple finisher Note: Not supported if another finisher is installed.
2	Multiposition staple, hole punch finisher Note: Not supported if another finisher is installed.
3	Mailbox
4	Optional 2200-sheet tray
5	Caster base
6	Optional 550-sheet trays or envelope trays

Note: Some options may not be available. For more information, contact the place where you purchased the printer.

Attaching cables

- ⚠ CAUTION—SHOCK HAZARD:** To avoid the risk of electrical shock, do not set up this product or make any electrical or cabling connections, such as the power cord, fax feature, or telephone, during a lightning storm.
- ⚠ CAUTION—POTENTIAL INJURY:** To avoid the risk of fire or electrical shock, connect the power cord to an appropriately rated and properly grounded electrical outlet that is near the product and easily accessible.
- ⚠ CAUTION—POTENTIAL INJURY:** To avoid the risk of fire or electrical shock, use only the power cord provided with this product or the manufacturer's authorized replacement.

⚠ CAUTION—POTENTIAL INJURY: To reduce the risk of fire, use only a 26 AWG or larger telecommunications (RJ-11) cord when connecting this product to the public switched telephone network. For users in Australia, the cord must be approved by the Australian Communications and Media Authority.

Warning—Potential Damage: To avoid loss of data or printer malfunction, do not touch the USB cable, any wireless network adapter, or the printer in the areas shown while actively printing.

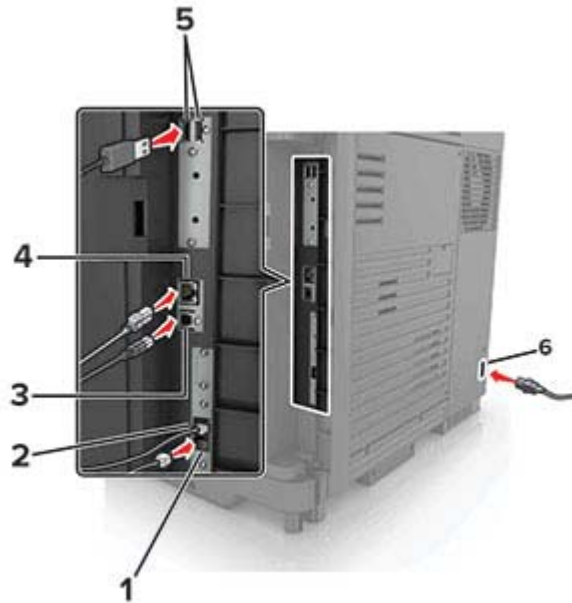

	Printer port	Function
1	EXT port	Connect more devices (telephone or answering machine) to the printer and the telephone line. Use this port if you do not have a dedicated fax line for the printer and if this connection method is supported in your country or region. Note: Remove the plug to access the port.
2	LINE port	Connect the printer to an active telephone line through a standard wall jack (RJ-11), DSL filter, or VoIP adapter, or any other adapter that allows you to access the telephone line to send and receive faxes.
3	USB printer port	Connect the printer to a computer.
4	Ethernet port	Connect the printer to a network.
5	USB ports	Attach a keyboard or any compatible option.
6	Power cord socket	Connect the printer to a properly grounded electrical outlet.

Using the control panel

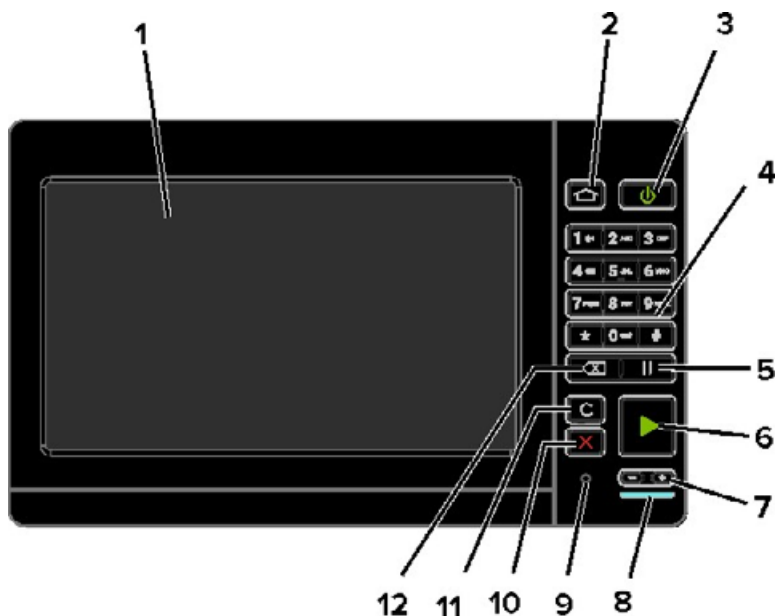

	Use the	To
1	Display	<ul style="list-style-type: none"> View the printer messages and supply status. Set up and operate the printer.
2	Home button	Go to the home screen.
3	Power button	<ul style="list-style-type: none"> Turn on or turn off the printer. Note: To turn off the printer, press and hold the power button for five seconds. Set the printer to Sleep or Hibernate mode. Wake the printer from Sleep or Hibernate mode.
4	Keypad	Enter numbers or symbols in an input field.
5	Pause button	Place a dial pause in a fax number.
6	Start button	Start a job, depending on which mode is selected.
7	Volume buttons	Adjust the volume of the headset or speaker.
8	Indicator light	Check the status of the printer.
9	Headset or speaker port	Attach a headset or speaker.
10	Stop or Cancel button	Stop the current job.
11	Clear all or Reset button	Reset the default settings of a function such as copying, faxing, or scanning.
12	Backspace button	Move the cursor backward and delete a character in an input field.

Understanding the status of the power button and indicator light

Indicator light	Printer status
Off	The printer is off or in Hibernate mode.
Blue	The printer is ready or processing data.
Red	The printer requires user intervention.

Power button light	Printer status
Off	The printer is off, ready, or processing data.
Solid amber	The printer is in Sleep mode.
Blinking amber	The printer is in Hibernate mode.

Using the home screen

Note: Your home screen may vary depending on your home screen customization settings, administrative setup, and active embedded solutions.



Touch	To
1	Copy Make copies.
2	E-mail Send e-mails.
3	Settings Access the printer menus.
4	Fax Send fax.
5	Address Book Manage a contact list that other applications on the printer can access.

Touch		To
6	Status/Supplies	<ul style="list-style-type: none"> • Show a printer warning or error message whenever the printer requires intervention to continue processing. • View more information on the printer warning or message, and on how to clear it. <p>Note: You can also access this setting by touching the top section of the home screen.</p>
7	USB Drive	<ul style="list-style-type: none"> • Print photos and documents from a flash drive. • Scan photos and documents to a flash drive
8	Job Queue	Show all the current print jobs. Note: You can also access this setting by touching the top section of the home screen.
9	Held Jobs	Show the print jobs that are held in the printer memory.
10	Shortcut Center	Organize all shortcuts.
11	App Profiles	Access application profiles.
12	Scan Profiles	Scan and save documents directly to the computer.
13	FTP	Scan and save documents directly to an FTP server.
14	Bookmarks	Organize all bookmarks.
15	Change Language	Change the language on the display.

Printing the Menu Settings Page

From the home screen, touch **Settings > Reports > Menu Settings Page**.

Setting up and using the home screen applications

Customizing the home screen

- 1 From the control panel, touch **Settings** > **Device** > **Visible Home Screen Icons**.
- 2 Select the icons that you want to appear on the home screen.
- 3 Apply the changes.

Setting up Forms and Favorites

- 1 Open a Web browser, and then type the printer IP address in the address field.

Notes:

- View the printer IP address on the printer home screen. The IP address appears as four sets of numbers separated by periods, such as 123.123.123.123.
- If you are using a proxy server, then temporarily disable it to load the Web page correctly.

- 2 Click **Apps** > **Forms and Favorites** > **Configure**.

- 3 Click **Add**, and then customize the settings.

Notes:

- To make sure that the location settings of the bookmark are correct, type the IP address of the host computer where the bookmark is located.
- Make sure that the printer has access rights to the folder where the bookmark is located.

- 4 Apply the changes.

Setting up Card Copy

- 1 Open a web browser, and then type the printer IP address in the address field.

Notes:

- View the printer IP address on the printer home screen. The IP address appears as four sets of numbers separated by periods, such as 123.123.123.123.
- If you are using a proxy server, then temporarily disable it to load the web page correctly.

- 2 Click **Apps** > **Card Copy** > **Configure**.

Notes:

- Make sure that Display Icon is enabled.
- Make sure that E-mail Settings and Network Share Settings are configured.
- When scanning a card, make sure that the scan resolution does not exceed 200 dpi for color and 400 dpi for black and white.

- When scanning multiple cards, make sure that the scan resolution does not exceed 150 dpi for color and 300 dpi for black and white.

3 Apply the changes.

Note: You need a printer hard disk to scan multiple cards.

Using Shortcut Center

- 1** From the home screen, touch **Shortcut Center**, and then select a printer function.
- 2** Touch **Create Shortcut**, and then configure the settings.
- 3** Touch **Save**, and then type a unique shortcut name.
- 4** Apply the changes.

Setting up Scan Center

- 1** From the home screen, touch **Scan Center**.
- 2** Select and create a destination, and then configure the settings.

Notes:

- When creating a network destination, make sure to validate and adjust the settings until no errors occur.
- Only destinations created from the Embedded Web Server are saved. For more information, see the documentation that came with the solution.

3 Apply the changes.

Managing bookmarks

Creating bookmarks

Use bookmarks to print frequently accessed documents that are stored in servers or on the web.

- 1** Open a web browser, and then type the printer IP address in the address field.

Notes:

- View the printer IP address on the printer home screen. The IP address appears as four sets of numbers separated by periods, such as 123.123.123.123.
- If you are using a proxy server, then temporarily disable it to load the web page correctly.

2 Click **Bookmarks > Add Bookmark**, and then type a bookmark name.

3 Select an Address protocol type, and then do one of the following:

- For HTTP and HTTPS, type the URL that you want to bookmark.
- For HTTPS, make sure to use the host name instead of the IP address. For example, type **myWebsite.com/sample.pdf** instead of typing **123.123.123.123/sample.pdf**. Make sure that the host name also matches the Common Name (CN) value in the server certificate. For more information on obtaining the CN value in the server certificate, see the help information for your web browser.
- For FTP, type the FTP address. For example, **myServer/myDirectory**. Enter the FTP port. Port 21 is the default port for sending commands.
- For SMB, type the network folder address. For example, **myServer/myShare/myFile.pdf**. Type the network domain name.
- If necessary, select the Authentication type for FTP and SMB.

To limit access to the bookmark, enter a PIN.

Note: The application supports the following file types: PDF, JPEG, TIFF, and HTML-based web pages. Other file types such as DOCX and XLXS are supported in some printer models.

4 Click **Save**.

Creating folders

1 Open a web browser, and then type the printer IP address in the address field.

Notes:

- View the printer IP address on the printer home screen. The IP address appears as four sets of numbers separated by periods, such as 123.123.123.123.
- If you are using a proxy server, then temporarily disable it to load the web page correctly.

2 Click **Bookmarks > Add Folder**, and then type a folder name.

Note: To limit access to the folder, enter a PIN.

3 Click **Save**.

Note: You can create folders or bookmarks inside a folder. To create a bookmark, see [“Creating bookmarks” on page 19](#).

Managing contacts

Adding contacts

1 Open a web browser, and then type the printer IP address in the address field.

Notes:

- View the printer IP address on the printer home screen. The IP address appears as four sets of numbers separated by periods, such as 123.123.123.123.
- If you are using a proxy server, then temporarily disable it to load the web page correctly.

2 Click **Address Book**.

3 From the Contacts section, add a contact.

Note: You can assign the contact to one or more groups.

4 If necessary, specify a login method to allow application access.

5 Apply the changes.

Adding groups

1 Open a web browser, and then type the printer IP address in the address field.

Notes:

- View the printer IP address on the printer home screen. The IP address appears as four sets of numbers separated by periods, such as 123.123.123.123.
- If you are using a proxy server, then temporarily disable it to load the web page correctly.

2 Click **Address Book**.

3 From the Contact Groups section, add a group name.

Note: You can assign one or more contacts to the group.

4 Apply the changes.

Editing contacts or groups

1 Open a web browser, and then type the printer IP address in the address field.

Notes:

- View the printer IP address on the printer home screen. The IP address appears as four sets of numbers separated by periods, such as 123.123.123.123.
- If you are using a proxy server, then temporarily disable it to load the web page correctly.

2 Click **Address Book**.

3 Do either of the following:

- From the Contacts section, click a contact name, and then edit the information.
- From the Contact Groups section, click a group name, and then edit the information.

4 Apply the changes.

Deleting contacts or groups

1 Open a web browser, and then type the printer IP address in the address field.

Notes:

- View the printer IP address on the printer home screen. The IP address appears as four sets of numbers separated by periods, such as 123.123.123.123.
- If you are using a proxy server, then temporarily disable it to load the web page correctly.

2 Click **Address Book**.

3 Do either of the following:

- From the Contacts section, select a contact that you want to delete.
- From the Contact Groups section, select a group name that you want to delete.

Loading paper and specialty media

Setting the size and type of the specialty media

The trays automatically detect the size of plain paper. For specialty media like labels, card stock, or envelopes, do the following:

- 1 From the home screen, navigate to:
Settings > Paper > Tray Configuration > Paper Size/Type > select a paper source
- 2 Set the size and type of the specialty media.

Configuring Universal paper settings

- 1 From the home screen, touch **Settings > Paper > Media Configuration > Universal Setup**.
- 2 Configure the settings.

Loading trays



CAUTION—TIPPING HAZARD: To reduce the risk of equipment instability, load each tray separately. Keep all other trays closed until needed.

- 1 Pull out the tray.

Note: To avoid paper jams, do not remove trays while the printer is busy.



- 2 Adjust the guides to match the size of the paper that you are loading.

Note: Use the indicators on the bottom of the tray to position the guides.

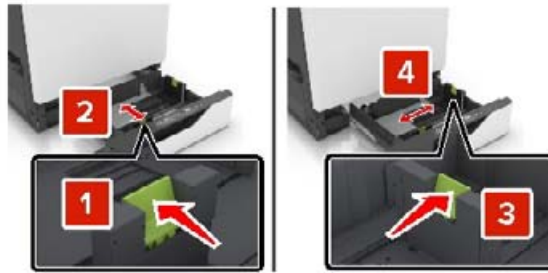

3 Flex, fan, and align the paper edges before loading.

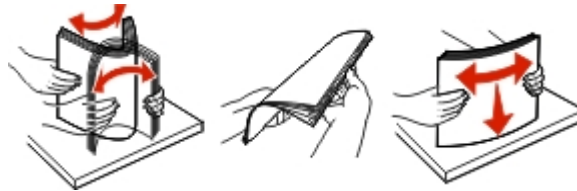

4 Load the paper with the printable side faceup.

Note: Load envelopes only in the optional envelope tray.

Warning—Potential Damage: Do not use envelopes with stamps, clasps, snaps, windows, coated linings, or self-stick adhesives in the optional envelope tray.

Notes:

- Load letterhead faceup with the header on the left side of the tray for one-sided printing.
- Load letterhead facedown with the header on the right side of the tray for two-sided printing.
- Load letterhead faceup with the header on the right side of the tray for one-sided print jobs that require finishing.
- Load letterhead facedown with the header on the left side of the tray for two-sided print jobs that require finishing.
- Load pre-punched paper with the holes toward the front or left side of the tray.
- Load envelopes with the flap side down and against the back side of the tray. Load European envelopes with the flap side down and against the left side of the tray.
- Do not slide paper into the tray.
- Make sure that the stack height is below the maximum paper fill indicator. Overfilling may cause paper jams.

**5** Insert the tray.

If loading a paper type other than plain, set the paper size and paper type in the Paper menu to match the paper loaded.

Loading the multipurpose feeder

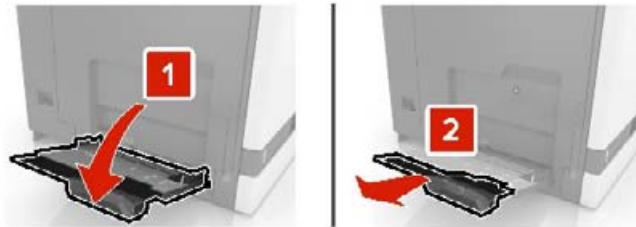
1 Open the multipurpose feeder.**2** Adjust the guide to match the size of the paper you are loading.**3** Flex, fan, and align the paper edges before loading.

4 Load the paper.

- Load paper, card stock, and transparencies with the printable side facedown and the top edge entering the printer first.



- Load envelopes with the flap side up and against the left side of the paper guide. Load European envelopes with the flap side up and entering the printer first.

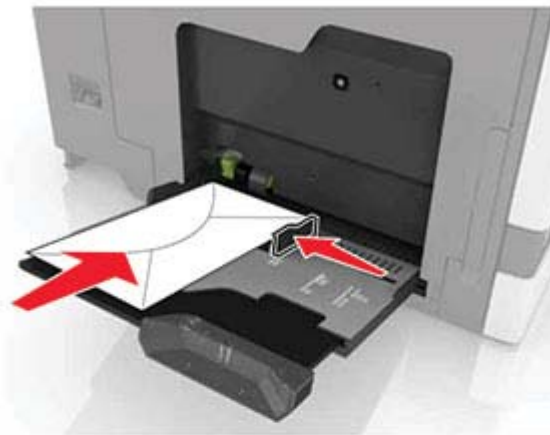

Warning—Potential Damage: Do not use envelopes with stamps, clasps, snaps, windows, coated linings, or self-stick adhesives.

5 From the control panel, set the paper size and type to match the paper loaded in the tray.

Linking trays

- 1 From the home screen, touch **Settings** > **Paper** > **Tray Configuration** > select a paper source.
- 2 Set the same paper size and paper type for the trays that you are linking.
- 3 From the home screen, touch **Settings** > **Device** > **Maintenance** > **Configuration Menu** > **Tray Configuration** > **Tray Linking**.
- 4 Touch **Automatic**.

To unlink trays, make sure that no trays have the same paper size and paper type settings.

Warning—Potential Damage: The temperature of the fuser varies according to the specified paper type. To avoid printing issues, match the paper type setting in the printer with the paper loaded in the tray.

Paper support

Supported paper sizes

Supported input sizes

Paper size	Dimensions	550-sheet tray	2200-sheet tray	Envelope tray	Multipurpose feeder ¹	Two-sided printing	ADF
3 x 5	76.2 x 127 mm (3 x 5 in.)	X	X	X	✓	X	X
4 x 6	101.6 x 152.4 mm (4 x 6 in.)	X	X	X	✓	X	X
A4	210 x 297 mm (8.3 x 11.7 in.)	✓	✓	X	✓	✓	✓
A5 landscape	210 x 148 mm (8.3 x 5.8 in.)	✓	✓	X	✓	✓	X
A5 portrait²	148 x 210 mm (5.8 x 8.3 in.)	✓	X	X	✓	✓	✓
A6	105 x 148 mm (4.1 x 5.8 in.)	X	X	X	✓	✓	✓
Banner	Max width: 215.9 mm (8.5 in.) Max length: 1320.8 mm (52 in.)	X	X	X	✓	X	X
Executive	184.2 x 266.7 mm (7.3 x 10.5 in.)	✓	X	X	✓	✓	✓
Folio	215.9 x 330.2 mm (8.5 x 13 in.)	✓	✓	X	✓	✓	✓
JIS B5	182 x 257 mm (7.2 x 10.1 in.)	✓	X	X	✓	✓	✓
Legal	215.9 x 355.6 mm (8.5 x 14 in.)	✓	✓	X	✓	✓	✓
Letter	215.9 x 279.4 mm (8.5 x 11 in.)	✓	✓	X	✓	✓	✓
Oficio	216 x 340 mm (8.5 x 13.4 in.)	✓	✓	X	✓	✓	✓

¹ This paper source does not support automatic size sensing.

² A5 portrait reports as Universal in the standard and optional 550-sheet trays.

Paper size	Dimensions	550-sheet tray	2200-sheet tray	Envelope tray	Multipurpose feeder ¹	Two-sided printing	ADF
Statement	139.7 x 215.9 mm (5.5 x 8.5 in.)	✓	X	X	✓	✓	✓
Universal	139.7 x 148 mm to 215.9 x 355.6 mm (5.5 x 5.8 in. to 8.5 x 14 in.)	X	X	X	✓	X	X
Universal	76.2 x 127 mm to 229 x 359.9 mm (3 x 5 in. to 9 x 14.2 in.)	✓	X	X	✓	✓	X
Universal	98.4 x 162 mm to 176 x 250 mm (3.9 x 6.4 in. to 6.9 x 9.8 in.)	X	X	✓	X	X	X
Universal	210 x 215.9 mm to 210 x 1321 mm (8.27 x 8.5 in. to 8.27 x 52 in.)	X	X	X	✓	X	X
7 3/4 Envelope	98 x 190.5 mm (3.9 x 7.5 in.)	X	X	✓	✓	X	X
9 Envelope	98.4 x 225.4 mm (3.86 x 8.9 in.)	X	X	✓	✓	X	X
10 Envelope	104.8 x 241.3 mm (4.1 x 9.5 in.)	X	X	✓	✓	X	X
B5 Envelope	176 x 250 mm (6.9 x 9.8 in.)	X	X	✓	✓	X	X
C4 Envelope	229 x 324 mm (9 x 13 in.)	X	X	X	✓	X	X
C5 Envelope	162 x 229 mm (6.4 x 9 in.)	X	X	✓	✓	X	X
DL Envelope	110 x 220 mm (4.3 x 8.7 in.)	X	X	✓	✓	X	X
Other Envelope	98.4 x 162 mm to 229 x 359.9 mm (3.9 x 6.4 in. to 9 x 14.2 in.)	X	X	X	✓	X	X

¹ This paper source does not support automatic size sensing.

² A5 portrait reports as Universal in the standard and optional 550-sheet trays.

Supported output sizes

Paper size	Dimensions	Standard bin	Staple finisher		Multiposition staple, hole punch finisher			
			Offset	Staple	Offset	Staple	Hole punch	2-bin mailbox
3 x 5	76.2 x 127 mm (3 x 5 in.)	✓	X	X	✓	X	X	✓
4 x 6	101.6 x 152.4 mm (4 x 6 in.)	✓	X	X	✓	X	X	✓
A4	210 x 297 mm (8.3 x 11.7 in.)	✓	✓	✓	✓	✓	✓	✓
A5 landscape	210 x 148 mm (8.3 x 5.8 in.)	✓	✓	X	✓	✓	X	✓
A5 portrait*	148 x 210 mm (5.8 x 8.3 in.)	✓	X	X	✓	X	✓	✓
A6	105 x 148 mm (4.1 x 5.8 in.)	✓	X	X	✓	X	X	X
Executive	184.2 x 266.7 mm (7.3 x 10.5 in.)	✓	✓	X	✓	✓	✓	✓
Folio	215.9 x 330.2 mm (8.5 x 13 in.)	✓	✓	✓	✓	✓	✓	✓
JIS B5	182 x 257 mm (7.2 x 10.1 in.)	✓	✓	X	✓	✓	✓	✓
Legal	215.9 x 355.6 mm (8.5 x 14 in.)	✓	✓	✓	✓	✓	X	✓
Letter	215.9 x 279.4 mm (8.5 x 11 in.)	✓	✓	✓	✓	✓	✓	✓
Oficio	216 x 340 mm (8.5 x 13.4 in.)	✓	✓	✓	✓	✓	✓	✓
Statement	139.7 x 215.9 mm (5.5 x 8.5 in.)	✓	X	X	✓	X	✓	✓
Universal	139.7 x 148 mm to 215.9 x 359.9 mm (5.5 x 5.8 in. to 8.5 x 14.2 in.)	✓	X	X	✓	X	X	X
Universal	76.2 x 127 mm to 229 x 359.9 mm (3 x 5 in. to 9 x 14.2 in.)	✓	X	✓	✓	X	X	X

* A5 portrait reports as Universal in the standard and optional 550-sheet trays.

Paper size	Dimensions	Standard bin	Staple finisher		Multiposition staple, hole punch finisher			
			Offset	Staple	Offset	Staple	Hole punch	2-bin mailbox
Universal	98.4 x 162 mm to 176 x 250 mm (3.9 x 6.4 in. to 6.9 x 9.8 in.)	✓	X	X	X	X	X	X
Universal	210 x 215.9 mm to 210 x 1321 mm (8.27 x 8.5 in. to 8.27 x 52 in.)	✓	X	X	X	X	X	X
7 3/4 Envelope	98 x 190.5 mm (3.9 x 7.5 in.)	✓	X	X	X	X	X	X
9 Envelope	98.4 x 225.4 mm (3.86 x 8.9 in.)	✓	X	X	X	X	X	X
10 Envelope	104.8 x 241.3 mm (4.1 x 9.5 in.)	✓	X	X	X	X	X	X
B5 Envelope	176 x 250 mm (6.9 x 9.8 in.)	✓	X	X	X	X	X	X
C4 Envelope	229 x 324 mm (9 x 13 in.)	✓	X	X	X	X	X	X
C5 Envelope	162 x 229 mm (6.4 x 9 in.)	✓	X	X	X	X	X	X
DL Envelope	110 x 220 mm (4.3 x 8.7 in.)	✓	X	X	X	X	X	X
Other Envelope	98.4 x 162 mm to 229 x 359.9 mm (3.9 x 6.4 in. to 9 x 14.2 in.)	✓	X	X	X	X	X	X

* A5 portrait reports as Universal in the standard and optional 550-sheet trays.

Supported paper types

Supported input types

Note: Labels, envelopes, and card stock always print at reduced speed.

Paper type	550-sheet tray	2200-sheet tray	Envelope tray	Multipurpose feeder	Two-sided printing	ADF
Plain Paper	✓	✓	X	✓	✓	✓
Card Stock ²	✓ ¹	X	X	✓ ¹	✓	X
Recycled	✓	✓	X	✓	✓	✓
Glossy	✓	✓	X	✓	✓	X
Heavy Glossy	✓	✓	X	✓	✓	X
Labels	✓	X	X	✓	X	X
Vinyl Labels	✓	X	X	✓	X	X
Bond	✓	✓	X	✓	✓	✓
Envelope	X	X	✓	✓	X	X
Rough Envelope	X	X	✓	✓	X	X
Transparency	X	X	X	✓	X	X
Letterhead	✓	✓	X	✓	✓	✓
Preprinted	✓	✓	X	✓	✓	✓
Colored Paper	✓	✓	X	✓	✓	✓
Light Paper	✓	✓	X	✓	✓	✓
Heavy Paper	✓	✓	X	✓	✓	✓
Rough Cotton	✓	✓	X	✓	✓	✓

¹ Supports up to 176 g/m² of card stock weight.

² Card stock that weighs more than 176 g/m² is supported only in one-sided printing using the standard 550-sheet tray.

Supported output types

Paper type	Staple finisher			Multiposition staple, hole punch finisher		
	Non-finishing	Offset	Staple	Standard bin (Normal and offset stacking)	2-bin mailbox	Staple and hole punch
Plain Paper	✓	✓	✓	✓	✓	✓
Card Stock	✓	✓	X	✓	X	X
Transparency	✓	X	X	✓	X	X
Recycled	✓	✓	✓	✓	✓	✓
Glossy	✓	✓	X	✓	✓	X

Paper type	Staple finisher			Multiposition staple, hole punch finisher		
	Non-finishing	Offset	Staple	Standard bin (Normal and offset stacking)	2-bin mailbox	Staple and hole punch
Heavy Glossy	✓	✓	X	✓	✓	X
Labels	✓	X	X	✓	X	X
Vinyl Labels	✓	X	X	✓	X	X
Bond	✓	✓	✓	✓	✓	✓
Envelope	✓	✓	X	✓	X	X
Rough Envelope	✓	✓	X	✓	X	X
Letterhead	✓	✓	✓	✓	✓	✓
Preprinted	✓	✓	✓	✓	✓	✓
Colored Paper	✓	✓	✓	✓	✓	✓
Light Paper	✓	✓	✓	✓	✓	✓
Heavy Paper	✓	✓	✓	✓	✓	✓
Rough Cotton	✓	✓	✓	✓	✓	✓

Supported paper weights

Paper type	Standard 550-sheet tray	2200-sheet tray	Envelope tray	Multipurpose feeder
Plain Paper ^{1,2}	60–176 g/m ² (16–47 lb) ³	60–120 g/m ² (16–32 lb)	N/A	60–176 g/m ² (16–47 lb)
Banner Paper	N/A	N/A	N/A	90–105 g/m ² (24–28 lb)
Glossy	88–176 g/m ² (60–120 lb)	N/A	N/A	88–176 g/m ² (60–120 lb)
Card stock	88–300 g/m ² (60–192 lb)	N/A	N/A	163–176 g/m ² (90–120 lb)
Labels	88–300 g/m ² (60–192 lb)	N/A	N/A	199–220 g/m ² (53–59 lb)

¹ Grain short paper that weighs at least 90 g/m² (24 lb) is supported in two-sided printing.

² Recycled paper that weighs 75–120 g/m² (20–32 lb) is supported in two-sided printing.

³ The paper weight is also supported in two-sided printing.

⁴ 100% cotton content maximum weight is 24 lb bond.

⁵ 28 lb-bond envelopes are limited to 25% cotton content.

Paper type	Standard 550-sheet tray	2200-sheet tray	Envelope tray	Multipurpose feeder
Envelopes	N/A	N/A	60–105 g/m ² (16–28 lb) ^{4, 5}	60–105 g/m ² (16–28 lb)

¹ Grain short paper that weighs at least 90 g/m² (24 lb) is supported in two-sided printing.

² Recycled paper that weighs 75–120 g/m² (20–32 lb) is supported in two-sided printing.

³ The paper weight is also supported in two-sided printing.

⁴ 100% cotton content maximum weight is 24 lb bond.

⁵ 28 lb-bond envelopes are limited to 25% cotton content.

Printing

 **CAUTION—PINCH HAZARD:** To avoid the risk of a pinch injury, use caution in areas marked with this label. Pinch injuries may occur around moving parts, such as gears, doors, trays, and covers.

Printing from a computer

Note: For labels, card stock, and envelopes, set the paper size and type in the printer before printing the document.

- 1 From the document that you are trying to print, open the Print dialog.
- 2 If necessary, adjust the settings.
- 3 Print the document.

Printing forms

- 1 From the home screen, navigate to:
Forms and Favorites > select form > **Print**
- 2 If necessary, configure the print settings.
- 3 Send the print job.

Printing from a mobile device

Printing from a mobile device using AirPrint



The AirPrint software feature is a mobile printing solution that allows you to print directly from Apple devices to an AirPrint-certified printer.



Notes:

- Make sure that the Apple device and the printer are connected to the same network. If the network has multiple wireless hubs, then make sure that both devices are connected to the same subnet.
 - This application is supported only in some Apple devices.
- 1 From your mobile device, select a document from your file manager or launch a compatible application.
 - 2 Tap the share icon, and then tap **Print**.
 - 3 Select a printer.
If necessary, adjust the settings.
 - 4 Print the document.

Printing from a mobile device using Wi-Fi Direct®

Wi-Fi Direct® is a printing service that lets you print to any Wi-Fi Direct-ready printer.

Note: Make sure that the mobile device is connected to the printer wireless network. For more information, see [“Connecting a mobile device to the printer” on page 143](#).

- 1 From your mobile device, launch a compatible application or select a document from your file manager.
- 2 Depending on your mobile device, do one of the following:
 - Tap  > **Print**.
 - Tap  > **Print**.
 - Tap  > **Print**.
- 3 Select a printer, and then adjust the settings, if necessary.
- 4 Print the document.

Printing from a flash drive

- 1 Insert the flash drive.

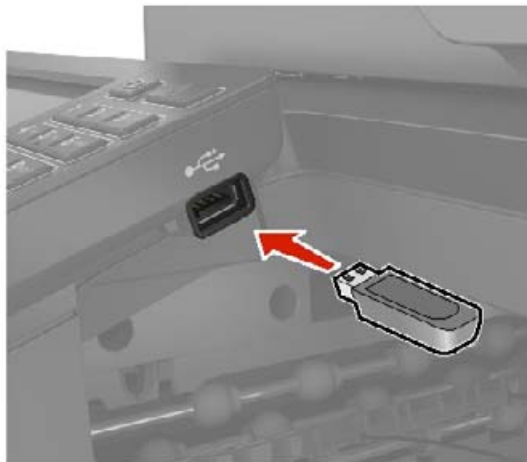

Notes:

- If you insert the flash drive when an error message appears, then the printer ignores the flash drive.
 - If you insert the flash drive while the printer is processing other print jobs, then **Busy** appears on the display.
- 2 From the display, touch the document that you want to print.
If necessary, configure other print settings.
 - 3 Send the print job.
To print another document, touch **USB Drive**.

Warning—Potential Damage: To avoid loss of data or printer malfunction, do not touch the flash drive or the printer in the area shown while actively printing, reading, or writing from the memory device.

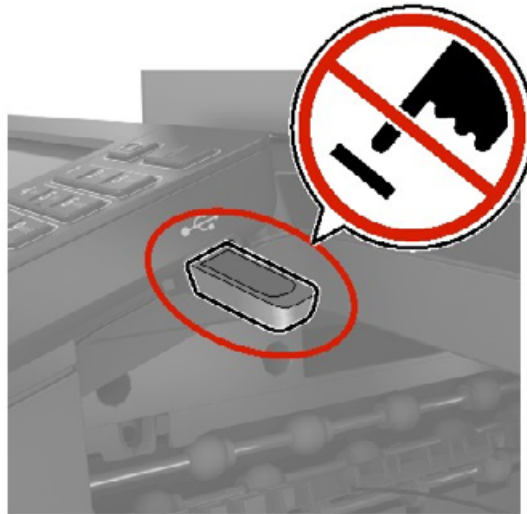

Supported flash drives and file types

Flash drives

Notes:

- The printer supports high-speed USB flash drives with full-speed standard.
- USB flash drives must support the File Allocation Table (FAT) system.

Many flash drives are tested and approved for use with the printer. For more information, contact the place where you purchased the printer.

File types

Documents:

- .doc or .docx
- .xls or .xlsx
- .ppt or .pptx
- .pdf
- .xps

Images:

- .dcx
- .gif
- .jpeg or .jpg
- .bmp
- .pcx
- .tiff or .tif
- .png

Configuring confidential jobs

Using the control panel

- 1 From the home screen, touch **Settings > Security > Confidential Print Setup**.
- 2 Configure the settings.

Using the Embedded Web Server

- 1 Open a web browser, and then type the printer IP address in the address field.

Notes:

- View the printer IP address on the home screen. The IP address appears as four sets of numbers separated by periods, such as 123.123.123.123.
- If you are using a proxy server, then temporarily disable it to load the web page correctly.

- 2 Click **Settings > Security > Confidential Print Setup**.
- 3 Configure the settings.

Setting	Description
Max Invalid PIN	Set the number of times an invalid PIN can be entered. Note: When the limit is reached, the print jobs for that user name are deleted.
Confidential Job Expiration	Set an individual expiration time for each held job before it is automatically deleted from the printer memory or hard disk. Note: A held job is either Confidential, Repeat, Reserve, or Verify.
Repeat Job Expiration	Set the expiration time for print jobs that you want to repeat.
Verify Job Expiration	Set the expiration time for printing a copy of a job for you to check its quality before printing the remaining copies.
Reserve Job Expiration	Set the expiration time print for jobs that you want to store in the printer for printing later.
Require All Jobs to be Held	Set the printer to hold all print jobs.
Keep duplicate documents	Set the printer to keep all documents with the same file name.

Printing confidential and other held jobs

For Windows users

- 1 With a document open, click **File > Print**.
- 2 Select a printer, and then click **Properties, Preferences, Options, or Setup**.
- 3 Click **Print and Hold**.
- 4 Select **Use Print and Hold**, and then assign a user name.

5 Select the print job type (Confidential, Repeat, Reserve, or Verify).

If you select **Confidential**, then secure the print job with a personal identification number (PIN).

6 Click **OK** or **Print**.

7 From the printer home screen, release the print job.

- For confidential print jobs, touch **Held jobs** > select your user name > **Confidential** > enter the PIN > select the print job > configure the settings > **Print**.
- For other print jobs, touch **Held jobs** > select your user name > select the print job > configure the settings > **Print**.

For Macintosh users

Using AirPrint

- 1** With a document open, choose **File** > **Print**.
- 2** Select a printer, and then from the drop-down menu following the Orientation menu, choose **PIN Printing**.
- 3** Enable **Print with PIN**, and then enter a four-digit PIN.
- 4** Click **Print**.
- 5** From the printer home screen, release the print job. Touch **Held jobs** > select your computer name > **Confidential** > enter the PIN > select the print job > **Print**.

Using the print driver

- 1** With a document open, choose **File** > **Print**.
- 2** Select a printer, and then from the drop-down menu following the Orientation menu, choose **Print and Hold**.
- 3** Choose **Confidential Print**, and then enter a four-digit PIN.
- 4** Click **Print**.
- 5** From the printer home screen, release the print job. Touch **Held jobs** > select your computer name > **Confidential** > select the print job > enter the PIN > **Print**.

Printing a font sample list

- 1** From the home screen, touch **Settings** > **Reports** > **Print** > **Print Fonts**.
- 2** Touch **PCL Fonts** or **PS Fonts**.

Printing a directory list

From the home screen, touch **Settings** > **Reports** > **Print** > **Print Directory**.

Canceling a print job

From the printer control panel

- 1 From the home screen, touch **Job Queue**.

Note: You can also access this setting by touching the top section of the home screen.

- 2 Select the job to cancel.

From the computer

- 1 Depending on the operating system, do either of the following:

- Open the printers folder, and then select your printer.
- From the System Preferences in the Apple menu, navigate to your printer.

- 2 Select the job to cancel.

Copying

Using the automatic document feeder and scanner glass

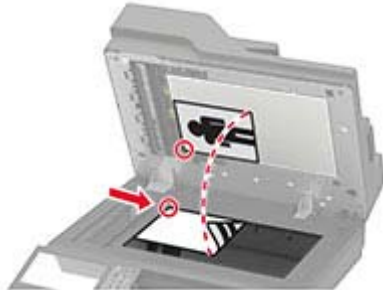
Automatic document feeder (ADF)	Scanner glass
 <ul style="list-style-type: none"> • Use the ADF for multiple-page or two-sided documents. • Load an original document faceup. For multiple-page documents, make sure to align the leading edge before loading. • Make sure to adjust the ADF guides to match the width of the paper that you are loading. 	 <ul style="list-style-type: none"> • Use the scanner glass for single-page documents, book pages, small items (such as postcards or photos), transparencies, photo paper, or thin media (such as magazine clippings). • Place the document facedown in the corner with the arrow.

Making copies

- 1 Load an original document into the ADF tray or on the scanner glass.

Note: To avoid a cropped image, make sure that the original document and output have the same paper size.

- 2 From the home screen, touch **Copy**, and then specify the number of copies.
If necessary, adjust the copy settings.
- 3 Copy the document.

Note: To make a quick copy, from the control panel, press .

Copying photos

- 1 Place a photo on the scanner glass.
- 2 From the home screen, touch **Copy** > **Content** > **Content Type** > **Photo**.
- 3 Touch **Content Source**, and then select the setting that best matches the original photo.
- 4 Copy the photo.

Copying on letterhead

- 1 Load an original document into the ADF tray or on the scanner glass.
- 2 From the home screen, touch **Copy** > **Copy From** > select the size of the original document.
- 3 Touch **Copy To**, and then select the paper source that contains the letterhead.
If you loaded the letterhead into the multipurpose feeder, then navigate to:
Copy To > **Multipurpose Feeder** > select a paper size > **Letterhead**
- 4 Copy the document.

Copying on both sides of the paper

- 1 Load an original document into the ADF tray or on the scanner glass.
- 2 From the home screen, touch **Copy** > **Sides**.
- 3 Adjust the settings.
- 4 Copy the document.

Reducing or enlarging copies

- 1 Load an original document into the ADF tray or on the scanner glass.
- 2 From the home screen, navigate to:
Copy > **Scale** > specify a scale value
Note: Changing the size of the original document or output after setting Scale restores the scale value to Auto.
- 3 Copy the document.

Collating copies

- 1 Load an original document into the ADF tray or on the scanner glass.
- 2 From the home screen, touch **Copy** > **Collate** > **On** [1,2,1,2,1,2].
- 3 Copy the document.

Placing separator sheets between copies

- 1 Load an original document into the ADF tray or on the scanner glass.
- 2 From the home screen, touch **Copy** > **Separator Sheets**.
- 3 Adjust the settings.
- 4 Send the copy job.

Copying multiple pages onto a single sheet

- 1 Load an original document into the ADF tray or on the scanner glass.
- 2 From the home screen, touch **Copy** > **Pages per Side**.
- 3 Adjust the settings.
- 4 Copy the document.

Creating a copy shortcut

- 1 From the home screen, touch **Copy**.
- 2 Configure the settings, and then touch .
- 3 Create a shortcut.

E-mailing

Using the automatic document feeder and scanner glass

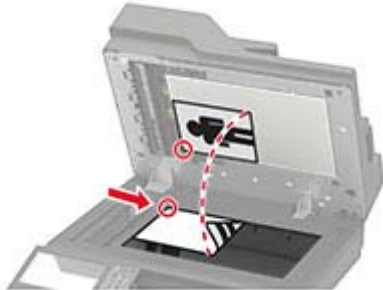
Automatic document feeder (ADF)	Scanner glass
 <ul style="list-style-type: none"> • Use the ADF for multiple-page or two-sided documents. • Load an original document faceup. For multiple-page documents, make sure to align the leading edge before loading. • Make sure to adjust the ADF guides to match the width of the paper that you are loading. 	 <ul style="list-style-type: none"> • Use the scanner glass for single-page documents, book pages, small items (such as postcards or photos), transparencies, photo paper, or thin media (such as magazine clippings). • Place the document facedown in the corner with the arrow.

Configuring the e-mail SMTP settings

Configure the Simple Mail Transfer Protocol (SMTP) settings to send a scanned document through e-mail. The settings vary with each e-mail service provider.

Before you begin, make sure that the printer is connected to a network and that the network is connected to the Internet.

Using the Embedded Web Server

- 1 Open a web browser, and then type the printer IP address in the address field.

Notes:

- View the printer IP address on the printer home screen. The IP address appears as four sets of numbers separated by periods, such as 123.123.123.123.
- If you are using a proxy server, then temporarily disable it to load the web page correctly.

- 2 Click **Settings > E-mail**.

- 3 From the E-mail Setup section, configure the settings.

Notes:

- For more information on the password, see the list of [e-mail service providers](#).
- For e-mail service providers that are not on the list, contact your provider and ask for the settings.

- 4 Click **Save**.

Using the Settings menu in the printer

1 From the home screen, touch **Settings > E-mail > E-mail Setup**.

2 Configure the settings.

Notes:

- For more information on the password, see the list of [e-mail service providers](#).
- For e-mail service providers that are not on the list, contact your provider and ask for the settings.

E-mail service providers

- [AOL Mail](#)
- [Comcast Mail](#)
- [Gmail](#)
- [iCloud Mail](#)
- [Mail.com](#)
- [NetEase Mail \(mail.126.com\)](#)
- [NetEase Mail \(mail.163.com\)](#)
- [NetEase Mail \(mail.yeah.net\)](#)
- [Outlook Live or Microsoft 365](#)
- [QQ Mail](#)
- [Sina Mail](#)
- [Sohu Mail](#)
- [Yahoo! Mail](#)
- [Zoho Mail](#)

Notes:

- If you encounter errors using the settings provided, then contact your e-mail service provider.
- For e-mail service providers that are not on the list, contact your provider.

AOL Mail

Setting	Value
Primary SMTP Gateway	smtp.aol.com
Primary SMTP Gateway Port	587
Use SSL/TLS	Required
Require Trusted Certificate	Disabled
Reply Address	Your e-mail address
SMTP Server Authentication	Login / Plain
Device-Initiated E-mail	Use Device SMTP Credentials
Device UserID	Your e-mail address

Setting	Value
Device Password	App password Note: To create an app password, go to the AOL Account Security page, log in to your account, and then click Generate app password .

Comcast Mail

Setting	Value
Primary SMTP Gateway	smtp.comcast.net
Primary SMTP Gateway Port	587
Use SSL/TLS	Required
Require Trusted Certificate	Disabled
Reply Address	Your e-mail address
SMTP Server Authentication	Login / Plain
Device-Initiated E-mail	Use Device SMTP Credentials
Device UserID	Your e-mail address
Device Password	Account password

Gmail™

Note: Make sure that two-step verification is enabled on your Google account. To enable two-step verification, go to the [Google Account Security](#) page, log in to your account, and then from the “Signing in to Google” section, click **2-Step Verification**.

Setting	Value
Primary SMTP Gateway	smtp.gmail.com
Primary SMTP Gateway Port	587
Use SSL/TLS	Required
Require Trusted Certificate	Disabled
Reply Address	Your e-mail address
SMTP Server Authentication	Login / Plain
Device-Initiated E-mail	Use Device SMTP Credentials
Device UserID	Your e-mail address
Device Password	App password Notes: <ul style="list-style-type: none"> To create an app password, go to the Google Account Security page, log in to your account, and then from the “Signing in to Google” section, click App passwords. “App passwords” shows only if two-step verification is enabled.

iCloud Mail

Note: Make sure that two-step verification is enabled on your account.

Setting	Value
Primary SMTP Gateway	smtp.mail.me.com
Primary SMTP Gateway Port	587
Use SSL/TLS	Required
Require Trusted Certificate	Disabled
Reply Address	Your e-mail address
SMTP Server Authentication	Login / Plain
Device-Initiated E-mail	Use Device SMTP Credentials
Device UserID	Your e-mail address
Device Password	App password Note: To create an app password, go to the iCloud Account Management page, log in to your account, and then from the Security section, click Generate Password .

Mail.com

Setting	Value
Primary SMTP Gateway	smtp.mail.com
Primary SMTP Gateway Port	587
Use SSL/TLS	Required
Require Trusted Certificate	Disabled
Reply Address	Your e-mail address
SMTP Server Authentication	Login / Plain
Device-Initiated E-mail	Use Device SMTP Credentials
Device UserID	Your e-mail address
Device Password	Account password

NetEase Mail (mail.126.com)

Note: Make sure that the SMTP service is enabled on your account. To enable the service, from the NetEase Mail home page, click **Settings > POP3/SMTP/IMAP**, and then enable either **IMAP/SMTP service** or **POP3/SMTP service**.

Setting	Value
Primary SMTP Gateway	smtp.126.com
Primary SMTP Gateway Port	465
Use SSL/TLS	Required
Require Trusted Certificate	Disabled

Setting	Value
Reply Address	Your e-mail address
SMTP Server Authentication	Login / Plain
Device-Initiated E-mail	Use Device SMTP Credentials
Device UserID	Your e-mail address
Device Password	Authorization password Note: The authorization password is provided when IMAP/SMTP service or POP3/SMTP service is enabled.

NetEase Mail (mail.163.com)

Note: Make sure that the SMTP service is enabled on your account. To enable the service, from the NetEase Mail home page, click **Settings** > **POP3/SMTP/IMAP**, and then enable either **IMAP/SMTP service** or **POP3/SMTP service**.

Setting	Value
Primary SMTP Gateway	smtp.163.com
Primary SMTP Gateway Port	465
Use SSL/TLS	Required
Require Trusted Certificate	Disabled
Reply Address	Your e-mail address
SMTP Server Authentication	Login / Plain
Device-Initiated E-mail	Use Device SMTP Credentials
Device UserID	Your e-mail address
Device Password	Authorization password Note: The authorization password is provided when IMAP/SMTP service or POP3/SMTP service is enabled.

NetEase Mail (mail.yeah.net)

Note: Make sure that the SMTP service is enabled on your account. To enable the service, from the NetEase Mail home page, click **Settings** > **POP3/SMTP/IMAP**, and then enable either **IMAP/SMTP service** or **POP3/SMTP service**.

Setting	Value
Primary SMTP Gateway	smtp.yeah.net
Primary SMTP Gateway Port	465
Use SSL/TLS	Required
Require Trusted Certificate	Disabled
Reply Address	Your e-mail address
SMTP Server Authentication	Login / Plain

Setting	Value
Device-Initiated E-mail	Use Device SMTP Credentials
Device UserID	Your e-mail address
Device Password	Authorization password Note: The authorization password is provided when IMAP/SMTP service or POP3/SMTP service is enabled.

Outlook Live or Microsoft 365

These settings apply to outlook.com and hotmail.com e-mail domains, and Microsoft 365 accounts.

Setting	Value
Primary SMTP Gateway	smtp.office365.com
Primary SMTP Gateway Port	587
Use SSL/TLS	Required
Require Trusted Certificate	Disabled
Reply Address	Your e-mail address
SMTP Server Authentication	Login / Plain
Device-Initiated E-mail	Use Device SMTP Credentials
Device UserID	Your e-mail address
Device Password	Account password or app password Notes: <ul style="list-style-type: none"> • For accounts with two-step verification disabled, use your account password. • For outlook.com or hotmail.com accounts with two-step verification enabled, use an app password. To create an app password, go to the Outlook Live Account Management page, and then log in to your account.

Note: For additional setup options for business using Microsoft 365, go to the [Microsoft 365 help page](#).

QQ Mail

Note: Make sure that the SMTP service is enabled on your account. To enable the service, from the QQ Mail home page, click **Settings > Account**. From the POP3/IMAP/SMTP/Exchange/CardDAV/CalDAV Service section, enable either **POP3/SMTP service** or **IMAP/SMTP service**.

Setting	Value
Primary SMTP Gateway	smtp.qq.com
Primary SMTP Gateway Port	587
Use SSL/TLS	Required
Require Trusted Certificate	Disabled
Reply Address	Your e-mail address

Setting	Value
SMTP Server Authentication	Login / Plain
Device-Initiated E-mail	Use Device SMTP Credentials
Device UserID	Your e-mail address
Device Password	Authorization code Note: To generate an authorization code, from the QQ Mail home page, click Settings > Account , and then from the POP3/IMAP/SMTP/Exchange/CardDAV/CalDAV Service section, click Generate authorization code .

Sina Mail

Note: Make sure that the POP3/SMTP service is enabled on your account. To enable the service, from the Sina Mail home page, click **Settings > More settings > User-end POP/IMAP/SMTP**, and then enable **POP3/SMTP service**.

Setting	Value
Primary SMTP Gateway	smtp.sina.com
Primary SMTP Gateway Port	587
Use SSL/TLS	Required
Require Trusted Certificate	Disabled
Reply Address	Your e-mail address
SMTP Server Authentication	Login / Plain
Device-Initiated E-mail	Use Device SMTP Credentials
Device UserID	Your e-mail address
Device Password	Authorization code Note: To create an authorization code, from the e-mail home page, click Settings > More settings > User-end POP/IMAP/SMTP , and then enable Authorization code status .

Sohu Mail

Note: Make sure that the SMTP service is enabled on your account. To enable the service, from the Sohu Mail home page, click **Options > Settings > POP3/SMTP/IMAP**, and then enable either **IMAP/SMTP service** or **POP3/SMTP service**.

Setting	Value
Primary SMTP Gateway	smtp.sohu.com
Primary SMTP Gateway Port	465
Use SSL/TLS	Required
Require Trusted Certificate	Disabled
Reply Address	Your e-mail address
SMTP Server Authentication	Login / Plain

Setting	Value
Device-Initiated E-mail	Use Device SMTP Credentials
Device UserID	Your e-mail address
Device Password	Independent password Note: The independent password is provided when IMAP/SMTP service or POP3/SMTP service is enabled.

Yahoo! Mail

Setting	Value
Primary SMTP Gateway	smtp.mail.yahoo.com
Primary SMTP Gateway Port	587
Use SSL/TLS	Required
Require Trusted Certificate	Disabled
Reply Address	Your e-mail address
SMTP Server Authentication	Login / Plain
Device-Initiated E-mail	Use Device SMTP Credentials
Device UserID	Your e-mail address
Device Password	App password Note: To create an app password, go to the Yahoo Account Security page, log in to your account, and then click Generate app password .

Zoho Mail

Setting	Value
Primary SMTP Gateway	smtp.zoho.com
Primary SMTP Gateway Port	587
Use SSL/TLS	Required
Require Trusted Certificate	Disabled
Reply Address	Your e-mail address
SMTP Server Authentication	Login / Plain
Device-Initiated E-mail	Use Device SMTP Credentials
Device UserID	Your e-mail address

Setting	Value
Device Password	Account password or app password Notes: <ul style="list-style-type: none"> • For accounts with two-step verification disabled, use your account password. • For accounts with two-step verification enabled, use an app password. To create an app password, go to the Zoho Mail Account Security page, log in to your account, and then from the Application-Specific Passwords section, click Generate New Password.

Sending an e-mail

Before you begin, make sure that the SMTP settings are configured. For more information, see [“Configuring the e-mail SMTP settings” on page 44](#).

Using the control panel

- 1 Load an original document into the ADF tray or on the scanner glass.
- 2 From the home screen, touch **E-mail**, and then enter the needed information.
- 3 If necessary, configure the output file type settings.
- 4 Send the e-mail.

Using a shortcut number

- 1 Load an original document into the ADF tray or on the scanner glass.
- 2 From the home screen, touch **Shortcut Center > E-mail**.
- 3 Select the shortcut number.
- 4 Send the e-mail.

Creating an e-mail shortcut

- 1 From the home screen, touch **E-mail**.
- 2 Configure the settings, and then touch .
- 3 Create a shortcut.

Faxing

Using the automatic document feeder and scanner glass

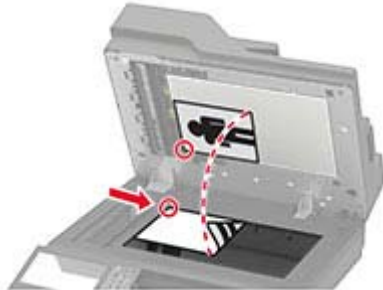
Automatic document feeder (ADF)	Scanner glass
 <ul style="list-style-type: none"> • Use the ADF for multiple-page or two-sided documents. • Load an original document faceup. For multiple-page documents, make sure to align the leading edge before loading. • Make sure to adjust the ADF guides to match the width of the paper that you are loading. 	 <ul style="list-style-type: none"> • Use the scanner glass for single-page documents, book pages, small items (such as postcards or photos), transparencies, photo paper, or thin media (such as magazine clippings). • Place the document facedown in the corner with the arrow.

Setting up the printer to fax

Notes:



- The following connection methods are applicable only in some countries or regions.
- During the initial printer setup, clear the fax function check box and any other function you plan to set up later, and then touch **Continue**.

Warning—Potential Damage: Do not touch cables or the printer in the area shown while actively sending or receiving a fax.



Choosing a fax connection

Setting up fax using a standard telephone line

-  **CAUTION—SHOCK HAZARD:** To avoid the risk of electrical shock, do not set up this product or make any electrical or cabling connections, such as the power cord, fax feature, or telephone, during a lightning storm.
-  **CAUTION—SHOCK HAZARD:** To avoid the risk of electrical shock, do not use the fax feature during a lightning storm.
-  **CAUTION—POTENTIAL INJURY:** To reduce the risk of fire, use only a 26 AWG or larger telecommunications (RJ-11) cord when connecting this product to the public switched telephone network. For users in Australia, the cord must be approved by the Australian Communications and Media Authority.

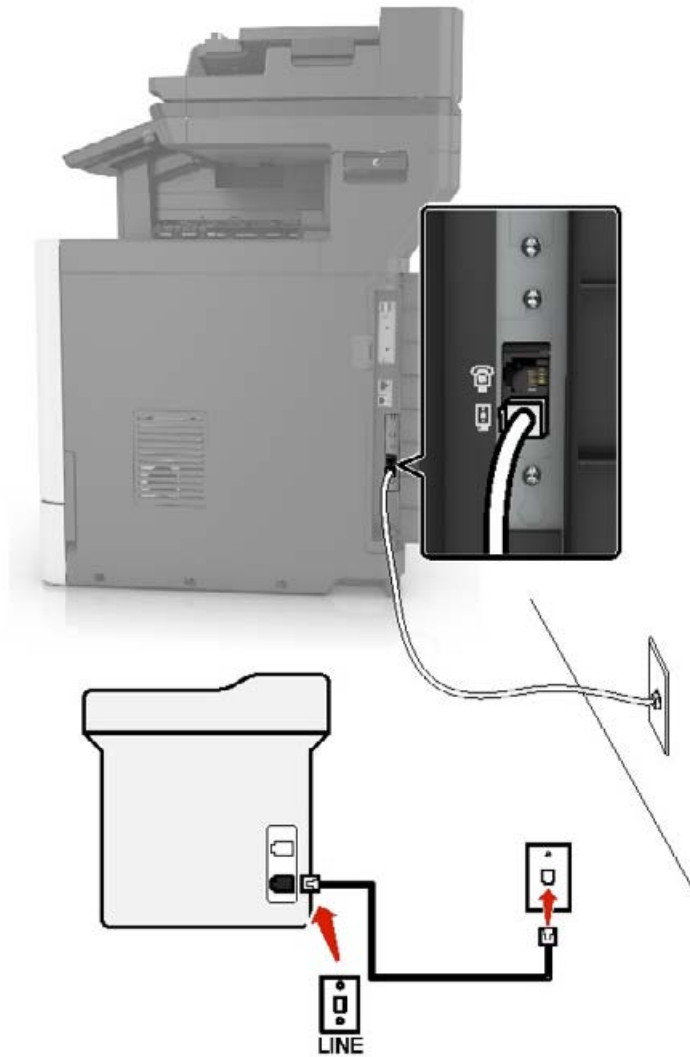
Setup 1: Printer is connected to a dedicated fax line

1 Connect one end of the telephone cable to the line port of the printer.

2 Connect the other end of the cable to an active analog wall jack.

Notes:

- You can set the printer to receive faxes automatically (Auto Answer On) or manually (Auto Answer Off).
- If you want to receive faxes automatically, then set the printer to pick up on a specified number of rings.

Setup 2: Printer is sharing the line with an answering machine

Note: If you subscribe to a distinctive ring service, then make sure that you set the correct ring pattern for the printer. Otherwise, the printer does not receive faxes even if you have set it to receive faxes automatically.

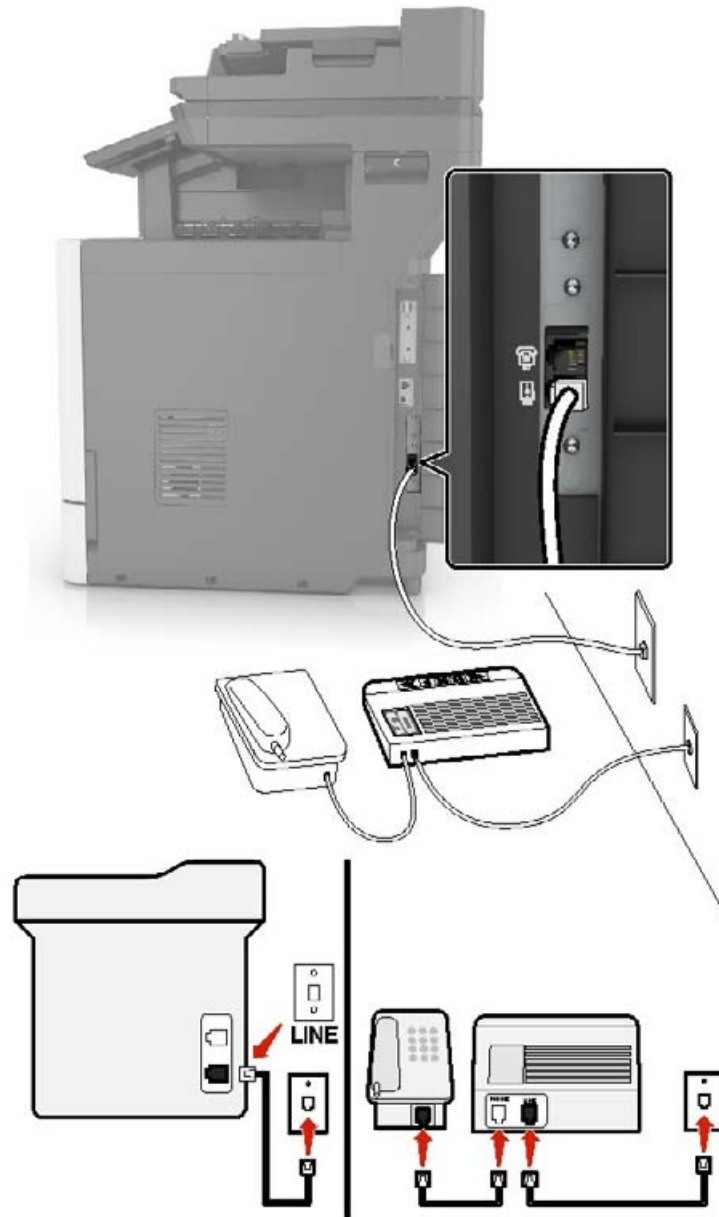
Connected to different wall jacks



1 Connect one end of the telephone cable to the line port of the printer.

2 Connect the other end of the cable to an active analog wall jack.

Notes:

- If you have only one telephone number on your line, then set the printer to receive faxes automatically.
- Set the printer to pick up calls two rings after the answering machine. For example, if the answering machine picks up calls after four rings, then set the printer Rings to Answer setting to six.

Setting up fax in countries or regions with different telephone wall jacks and plugs

-  **CAUTION—SHOCK HAZARD:** To avoid the risk of electrical shock, do not set up this product or make any electrical or cabling connections, such as the power cord, fax feature, or telephone, during a lightning storm.
-  **CAUTION—SHOCK HAZARD:** To avoid the risk of electrical shock, do not use the fax feature during a lightning storm.
-  **CAUTION—POTENTIAL INJURY:** To reduce the risk of fire, use only a 26 AWG or larger telecommunications (RJ-11) cord when connecting this product to the public switched telephone network. For users in Australia, the cord must be approved by the Australian Communications and Media Authority.

The standard wall jack adopted by most countries or regions is RJ11. If the wall jack or equipment in your facility is not compatible with this type of connection, then use a telephone adapter. An adapter for your country or region may not come with your printer, and you may need to purchase it separately.

There may be an adapter plug installed in the telephone port of the printer. Do not remove the adapter plug from the telephone port of the printer if you are connecting to a serial or cascaded telephone system.

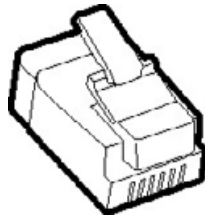

Connecting the printer to a non-RJ11 wall jack



- 1 Connect one end of the telephone cable to the line port of the printer.
- 2 Connect the other end of the cable to the RJ11 adapter, and then connect the adapter to the wall jack.
- 3 If you want to connect another device with a non-RJ11 connector to the same wall jack, then connect it directly to the telephone adapter.

Connecting the printer to a wall jack in Germany

The German wall jack has two kinds of ports. The N ports are for fax machines, modems, and answering machines. The F port is for telephones. Connect the printer to any of the N ports.



- 1 Connect one end of the telephone cable to the line port of the printer.
- 2 Connect the other end of the cable to the RJ11 adapter, and then connect the adapter to an N port.
- 3 If you want to connect a telephone and answering machine to the same wall jack, then connect the devices as shown.

Connecting to a distinctive ring service

A distinctive ring service lets you have multiple telephone numbers on one telephone line. Each telephone number is assigned a different ring pattern.

- 1 From the home screen, touch **Settings > Fax > Fax Setup > Fax Receive Settings > Admin Controls > Answer On**.
- 2 Select a ring pattern.

Setting the fax date and time

- 1 From the home screen, touch **Settings > Device > Preferences > Date and Time > Configure**.
- 2 Configure the settings.

Configuring daylight saving time

- 1 From the home screen, touch **Settings > Device > Preferences > Date and Time > Configure**.
- 2 In the Time Zone menu, select **(UTC+user) Custom**.
- 3 Configure the settings.

Sending a fax

Using the control panel

- 1 Load the original document into the ADF tray or on the scanner glass.
- 2 From the home screen, touch **Fax**, and then enter the needed information.
- 3 If necessary, configure other fax settings.
- 4 Send the fax job.

Using the computer

Note: Make sure that the Universal Fax driver is installed.

For Windows users

- 1 With a document open, click **File > Print**.
- 2 Select the printer, and then click **Properties, Preferences, Options, or Setup**.
- 3 Click **Fax > Enable fax**, and then enter the recipient number.
- 4 If necessary, configure other fax settings.
- 5 Send the fax job.

For Macintosh users

- 1 With a document open, choose **File > Print**.
- 2 Select the printer and enter the recipient number.
- 3 If necessary, configure other fax settings.
- 4 Send the fax job.

Scheduling a fax

- 1 Load the original document into the ADF tray or on the scanner glass.
- 2 From the home screen, navigate to:
Fax > To > enter the fax number > Done
- 3 Touch **Send Time**, configure the settings, and then touch **Done**.
- 4 Send the fax.

Creating a fax destination shortcut

- 1 From the home screen, touch **Fax > To**.
- 2 Enter the recipient number, and then touch **Done**.
- 3 Touch .
- 4 Create a shortcut.

Changing the fax resolution

- 1 Load an original document into the ADF tray or on the scanner glass.
- 2 From the home screen, touch **Fax**, and then enter the needed information.
- 3 Touch **Resolution**, and then adjust the setting.
- 4 Send the fax.

Adjusting the fax darkness

- 1 Load an original document into the ADF tray or on the scanner glass.
- 2 From the home screen, touch **Fax**, and then enter the needed information.
- 3 Touch **Darkness**, and then adjust the setting.
- 4 Send the fax.

Printing a fax log

- 1 From the home screen, touch **Settings** > **Reports** > **Fax**.
- 2 Touch **Fax Job Log** or **Fax Call Log**.

Blocking junk faxes

- 1 From the home screen, touch **Settings** > **Fax** > **Fax Setup** > **Fax Receive Settings** > **Admin Controls**.
- 2 Set Block No Name Fax to **On**.

Holding faxes

- 1 From the home screen, touch **Settings** > **Fax** > **Fax Setup** > **Fax Receive Settings** > **Holding Faxes**.
- 2 Select a mode.

Forwarding a fax

Using the control panel

- 1 Create a fax destination shortcut.
 - a From the home screen, touch **Fax** > **To**.
 - b Enter the recipient number, and then touch **Done**.
 - c Touch .
 - d Create a shortcut.
- 2 From the home screen, touch **Settings** > **Fax** > **Fax Setup** > **Fax Receive Settings** > **Admin Controls**.
- 3 In the Fax Forwarding menu, touch **Forward**.
- 4 In the Forward to menu, configure the destination.

Using the Embedded Web Server

- 1 Create a fax destination shortcut.
 - a Open a web browser, and then type the printer IP address in the address field.

Notes:

 - View the printer IP address on the home screen. The IP address appears as four sets of numbers separated by periods, such as 123.123.123.123.
 - If you are using a proxy server, then temporarily disable it to load the web page correctly.
 - b Click **Shortcuts** > **Add Shortcut**.
 - c From the Shortcut Type menu, select **Fax**, and then configure the settings.
 - d Apply the changes.
- 2 Click **Settings** > **Fax** > **Fax Setup** > **Fax Receive Settings** > **Admin Controls**.

- 3** In the Fax Forwarding menu, select **Forward**.
- 4** In the Forward to menu, configure the destination.

Scanning

Using the automatic document feeder and scanner glass

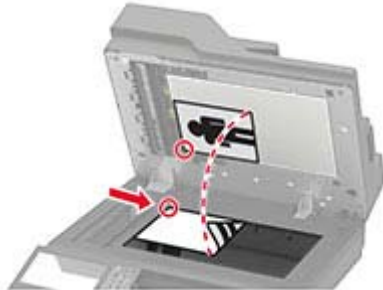
Automatic document feeder (ADF)	Scanner glass
 <ul style="list-style-type: none">• Use the ADF for multiple-page or two-sided documents.• Load an original document faceup. For multiple-page documents, make sure to align the leading edge before loading.• Make sure to adjust the ADF guides to match the width of the paper that you are loading.	 <ul style="list-style-type: none">• Use the scanner glass for single-page documents, book pages, small items (such as postcards or photos), transparencies, photo paper, or thin media (such as magazine clippings).• Place the document facedown in the corner with the arrow.

Scanning to a computer

Before you begin, make sure that:

- The printer firmware is updated. For more information, see [“Updating firmware” on page 277](#).
- The computer and the printer are connected to the same network.

For Windows users

Note: Make sure that the printer is added to the computer. For more information, see [“Adding printers to a computer” on page 275](#).

- 1 Load an original document into the automatic document feeder or on the scanner glass.
- 2 From the computer, open **Windows Fax and Scan**.
- 3 From the Source menu, select a scanner source.
- 4 If necessary, change the scan settings.
- 5 Scan the document.

For Macintosh users

Note: Make sure that the printer is added to the computer. For more information, see [“Adding printers to a computer” on page 275](#).

- 1 Load an original document into the automatic document feeder or on the scanner glass.
- 2 From the computer, do either of the following:
 - Open **Image Capture**.
 - Open **Printers & Scanners**, and then select a printer. Click **Scan > Open Scanner**.
- 3 From the Scanner window, do one or more of the following:
 - Select where you want to save the scanned document.
 - Select the size of the original document.
 - To scan from the ADF, select **Document Feeder** from the Scan Menu or enable **Use Document Feeder**.
 - If necessary, configure the scan settings.
- 4 Click **Scan**.

Scanning to an FTP server

- 1 Load the original document into the ADF tray or on the scanner glass.
- 2 From the home screen, touch **FTP**, and then enter the needed information.
- 3 If necessary, configure other FTP settings.
- 4 Send the FTP job.

Creating an FTP shortcut

- 1 From the home screen, touch **FTP**.
- 2 Enter the FTP server address, and then touch .
- 3 Create a shortcut.

Creating a network folder shortcut

- 1 Open a web browser, and then type the printer IP address in the address field.

Notes:

- View the printer IP address on the printer home screen. The IP address appears as four sets of numbers separated by periods, such as 123.123.123.123.
- If you are using a proxy server, then temporarily disable it to load the web page correctly.

- 2 Click **Shortcuts > Add Shortcut**.
- 3 From the Shortcut Type menu, select **Network Folder**, and then configure the settings.
- 4 Apply the changes.

Scanning to a flash drive

- 1 Load an original document into the ADF tray or on the scanner glass.
- 2 Insert the flash drive.



- 3 Touch **Scan to USB** and adjust the settings if necessary.

Notes:

- To save the scanned document to a folder, touch **Scan to**, select a folder, and then touch **Scan Here**.
- If the USB Drive screen does not appear, then touch **USB Drive** on the control panel.

- 4 Scan the document.

Warning—Potential Damage: To avoid loss of data or printer malfunction, do not touch the flash drive or the printer in the area shown while actively printing, reading, or writing from the memory device.

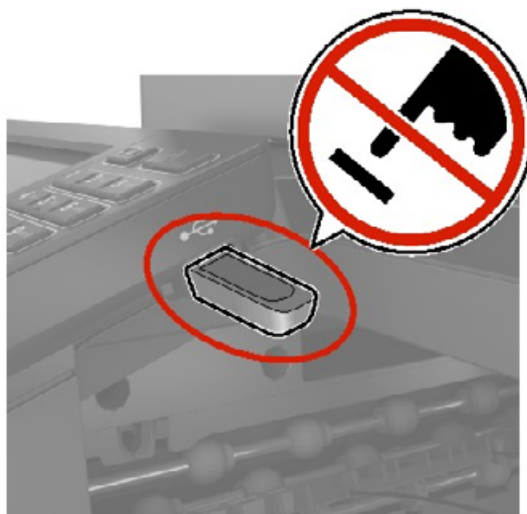

Scanning to a fax server

- 1 Load an original document into the ADF tray or on the scanner glass.
- 2 From the home screen, touch **Scan Center**, and then from the list of destinations, select **Fax**.
- 3 Select a fax destination.
Note: To create a fax destination, touch **Create Fax**.
- 4 Scan the document.

Scanning to a network folder

- 1 Load the document into the ADF tray or on the scanner glass.
- 2 From the home screen, touch **Scan Center**.
Note: The icon and name may have been changed. For more information, contact your administrator.
- 3 Do either of the following:
 - Select a destination.
Note: For SFTP, set the port number to **22**.
 - Use a shortcut by touching , and then selecting the shortcut from the list.
- 4 Scan the document.

Understanding the printer menus

Menu map

Device	<ul style="list-style-type: none"> • Preferences • Eco-Mode • Remote Operator Panel • Notifications • Power Management 	<ul style="list-style-type: none"> • Anonymous Data Collection • Restore Factory Defaults • Maintenance • Visible Home Screen Icons • About this Printer
Print	<ul style="list-style-type: none"> • Layout • Setup • Quality • Job Accounting • XPS 	<ul style="list-style-type: none"> • PDF • PostScript • PCL • HTML • Image
Paper	<ul style="list-style-type: none"> • Tray Configuration 	<ul style="list-style-type: none"> • Media Configuration
Copy	Copy Defaults	
Fax	Fax Defaults	
E-mail	<ul style="list-style-type: none"> • E-mail Setup • E-mail Defaults 	<ul style="list-style-type: none"> • Web Link Setup
FTP	FTP Defaults	
USB Drive	<ul style="list-style-type: none"> • Flash Drive Scan 	<ul style="list-style-type: none"> • Flash Drive Print
Network/Ports	<ul style="list-style-type: none"> • Network Overview • Wireless • Wi-Fi Direct • Ethernet • TCP/IP • SNMP • IPSec 	<ul style="list-style-type: none"> • 802.1x • LPD Configuration • HTTP/FTP Settings • ThinPrint • USB • Restrict external network access
Security	<ul style="list-style-type: none"> • Login Methods • Schedule USB Devices • Security Audit Log • Login Restrictions • Confidential Print Setup 	<ul style="list-style-type: none"> • Disk Encryption • Erase Temporary Data Files • Solutions LDAP Settings • Miscellaneous
Reports	<ul style="list-style-type: none"> • Menu Settings Page • Device • Print 	<ul style="list-style-type: none"> • Shortcuts • Fax • Network

Help	<ul style="list-style-type: none"> • Print All Guides • Color Quality Guide • Connection Guide • Copy Guide • E-mail Guide • Fax Guide 	<ul style="list-style-type: none"> • Information Guide • Media Guide • Moving Guide • Print Quality Guide • Scan Guide • Supplies Guide
Troubleshooting	Print Quality Test Pages	Cleaning the Scanner

Device

Preferences

Menu item	Description
Display Language	Set the language of the text that appears on the display.
Country/Region	Identify the country or region that the printer is configured to operate.
Run initial setup Off* On	Run the setup wizard.
Keyboard Keyboard Type	Select a language as a keyboard type. Note: All the Keyboard Type values may not appear or may require special hardware be installed to appear.
Displayed information Display Text 1 ([IP Address*]) Display Text 2 (Date/Time*) Custom Text 1 Custom Text 2	Specify the information to appear on the home screen.
Date and Time Configure Current Date and Time Manually Set Date and Time Date Format (MM-DD-YYYY*) Time Format (12 hour A.M./P.M.*) Time Zone (UTC-5:00*) Network Time Protocol Enable NTP (On*) NTP Server Enable Authentication	Configure the printer date and time and network time protocol.
Paper Sizes U.S.* Metric	Specify the unit of measurement for paper sizes. Note: The country or region selected in the initial setup wizard determines the initial paper size setting.
Note: An asterisk (*) next to a value indicates the factory default setting.	

Menu item	Description
Screen Brightness 20–100% (100*)	Adjust the brightness of the display.
Flash Drive Access Enabled* Disabled	Enable access to the flash drive.
Allow Background Removal Off On*	Specify whether background removal is allowed.
Allow Custom Job scans Off On*	Specify whether the Custom Job Scanning setting appears for copy, scan, and fax. Note: This menu item appears only when a hard disk is installed.
One Page Flatbed Scanning Off* On	Set the printer to scan any type of job involving the scanner glass as a single page. Note: The printer returns to the home screen after performing a single flatbed scan instead of displaying prompts.
Output Lighting Off* On	Enable the integrated output light or indicator light of an optional output bin.
Audio Feedback Button Feedback (On*) Volume (5*)	<ul style="list-style-type: none"> • Enable audio feedback for button presses, panel interactions, paper loaded prompts, and error notifications. • Adjust the feedback volume.
Screen Timeout 5–300 seconds (60*)	Set the idle time before the display shows the home screen or before the printer logs out a user account automatically.
Note: An asterisk (*) next to a value indicates the factory default setting.	

Eco-Mode

Menu item	Description
Print Sides (1-Sided*) Pages per Side (Off*) Toner Darkness (4*) Color Saver (Off*)	Configure the print settings of the printer.
Copy Sides (1 sided to 1 sided*) Pages per Side (Off*) Darkness (5*)	Configure the copy settings of the printer.
Note: An asterisk (*) next to a value indicates the factory default setting.	

Remote Operator Panel

Menu item	Description
External VNC Connection Don't Allow* Allow	Connect an external Virtual Network Computing (VNC) client to the remote control panel.
Authentication Type None* Standard Authentication	Set the authentication type when accessing the VNC client server.
VNC Password	Specify the password to connect to the VNC client server. Note: This menu item appears only if Authentication Type is set to Standard Authentication.
Note: An asterisk (*) next to a value indicates the factory default setting.	

Notifications

Menu item	Description
Error Lighting Off On*	Set the indicator light to come on when a printer error occurs.
ADF Loaded Beep Off On*	Enable a sound when loading paper into the ADF.
Alarm Control Off Single* Continuous	Set the number of times that the alarm sounds when the printer requires user intervention.
Supplies Show Supply Estimates Show estimates* Do not show estimates	Show the estimated status of the supplies.
Supplies Display Estimates Pages* Percent	Determine the unit that the printer uses to estimate supply usage and trigger custom notifications when user intervention is required. Note: This menu item appears only in the Embedded Web Server.
Supplies Cartridge Alarm Off Single* Continuous	Set the number of times that the alarm sounds when the toner cartridge is low.
Note: An asterisk (*) next to a value indicates the factory default setting.	

Menu item	Description
<p>Supplies</p> <ul style="list-style-type: none"> Custom Supply Estimates Show Estimates Do Not Show Estimates* 	<p>Configure notification settings when the printer requires user intervention.</p> <p>Note: This menu item appears only in the Embedded Web Server.</p>
<p>E-mail Alerts Setup</p> <ul style="list-style-type: none"> E-mail Setup <ul style="list-style-type: none"> Primary SMTP Gateway Primary SMTP Gateway Port (25*) Secondary SMTP Gateway Secondary SMTP Gateway Port (25*) SMTP Timeout (30 seconds*) Reply Address Always use SMTP default Reply Address(Off*) Use SSL/TLS(Disabled*) Require Trusted Certificate(On*) SMTP Server Authentication (No authentication required*) Device-Initiated E-mail(None*) User-Initiated E-mail(None*) Use Active Directory Device Credentials(Off*) Device Userid Device Password Kerberos 5 REALM NTLM Domain Disable "SMTP server not set up" error(Off*) 	<p>Configure the e-mail settings of the printer.</p>
<p>E-mail Alerts Setup</p> <ul style="list-style-type: none"> Setup E-mail Lists and Alerts <ul style="list-style-type: none"> E-mail List 1 E-mail List 2 E-mail Events 	<p>Specify the e-mail addresses and enable the e-mail alert events.</p> <p>Note: This menu item appears only in the Embedded Web Server.</p>
<p>Error Prevention</p> <ul style="list-style-type: none"> ADF Multifeed Sensor <ul style="list-style-type: none"> Off On* 	<p>Detect when the ADF picks more than one sheet of media at once.</p>
<p>Error Prevention</p> <ul style="list-style-type: none"> Jam Assist <ul style="list-style-type: none"> Off On* 	<p>Set the printer to flush blank pages or pages with partial prints automatically after a jammed page has been cleared.</p>
<p>Note: An asterisk (*) next to a value indicates the factory default setting.</p>	

Menu item	Description
<p>Error Prevention Auto Continue Off On* (5 seconds)</p>	<p>Let the printer continue processing or printing a job automatically after clearing certain printer conditions that require user intervention.</p>
<p>Error Prevention Auto Reboot Auto Reboot Reboot when idle Reboot always* Reboot never</p>	<p>Set the printer to restart when an error occurs.</p>
<p>Error Prevention Auto Reboot Max Auto Reboots 1–20 (2*)</p>	<p>Set the number of automatic reboots that the printer can perform.</p>
<p>Error Prevention Auto Reboot Auto Reboot Window 1–525600 seconds (720*)</p>	<p>Set the time before the printer performs an automatic reboot.</p>
<p>Error Prevention Auto Reboot Auto Reboot Counter</p>	<p>Show a read-only information of the reboot counter.</p>
<p>Error Prevention Auto Reboot Reset Auto Reboot Counter Cancel Continue</p>	<p>Reset Auto Reboot Counter.</p>
<p>Error Prevention Display Short Paper Error On Auto-clear*</p>	<p>Set the printer to show a message when a short paper error occurs. Note: Short paper refers to the size of the paper loaded.</p>
<p>Error Prevention Page Protect Off* On</p>	<p>Set the printer to process the entire page into the memory before printing it.</p>
<p>Jam Content Recovery Jam Recovery Off On Auto*</p>	<p>Set the printer to reprint jammed pages.</p>
<p>Note: An asterisk (*) next to a value indicates the factory default setting.</p>	

Menu item	Description
Jam Content Recovery Scanner Jam Recovery Job level Page level*	Specify how to restart a scan job after resolving a paper jam.
Note: An asterisk (*) next to a value indicates the factory default setting.	

Power Management

Menu item	Description
Sleep Mode Profile Print from Sleep Mode Stay awake after printing Enter Sleep Mode after printing*	Set the printer to stay in Ready mode or return to Sleep mode after printing.
Timeouts Proximity Sensor Disabled Short Range Long Range*	Determines the approximate distance of an object for the printer to sense it.
Timeouts Sleep Mode 1–120 minutes (15*)	Set the idle time before the printer begins operating in Sleep mode.
Timeouts Hibernate Timeout Disabled 1 hour 2 hours 3 hours 6 hours 1 day 2 days 3 days* 1 week 2 weeks 1 month	Set the time before the printer turns off.
Timeouts Hibernate Timeout on Connection Hibernate Do Not Hibernate*	Set Hibernate Timeout to turn off the printer while an active Ethernet connection exists.
Note: An asterisk (*) next to a value indicates the factory default setting.	

Anonymous Data Collection

Menu item	Description
Anonymous Data Collection Device Usage and Performance Information None*	Send printer usage and performance information to the manufacturer. Note: Anonymous Data Send Time appears only when you set Anonymous Data Collection to Device Usage and Performance.
Anonymous Data Send Time Start Time Stop Time	
Note: An asterisk (*) next to a value indicates the factory default setting.	

Restore Factory Defaults

Menu item	Description
Restore Settings Restore all settings Restore printer settings Restore network settings Restore fax settings Restore app settings	Restore the printer factory default settings.

Maintenance

Configuration Menu

Menu item	Description
USB Configuration USB PnP 1* 2	Change the USB driver mode of the printer to improve its compatibility with a personal computer.
USB Configuration USB Scan to Local On* Off	Set whether the USB device driver enumerates as a USB Simple device (single interface) or as a USB Composite device (multiple interfaces).
USB Configuration USB Speed Full Auto*	Set the USB port to run at full speed and disable its high-speed capabilities.
Note: An asterisk (*) next to a value indicates the factory default setting.	

Menu item	Description
Tray Configuration Size Sensing Tray [x] Sensing Off On*	Set the tray to sense automatically the paper size loaded into it.
Tray Configuration Tray Linking Automatic* Off	Set the printer to link the trays that have the same paper type and paper size settings.
Tray Configuration Show Tray Insert Message Off Only for unknown sizes* Always	Show the Tray Insert message.
Tray Configuration A5 Loading Short Edge Long Edge*	Determine the default loading orientation for the A5 size paper in all paper sources.
Tray Configuration Paper Prompts Auto* Multipurpose Feeder Manual Paper	Set the paper source that the user fills when a prompt to load paper appears. Note: For Multipurpose Feeder to appear, in the Paper menu, set Configure MP to Cassette.
Tray Configuration Envelope Prompts Auto* Multipurpose Feeder Manual Envelope	Set the paper source that the user fills when a prompt to load envelope appears. Note: For Multipurpose Feeder to appear, in the Paper menu, set Configure MP to Cassette.
Tray Configuration Action for Prompts Prompt user* Continue Use current	Set the printer to resolve paper- or envelope-related change prompts.
Reports Menu Settings Page Event Log Event Log Summary HealthCheck Statistics	Print reports about printer menu settings, status, and event logs.

Note: An asterisk (*) next to a value indicates the factory default setting.

Menu item	Description
Printer Emulations PPDS Emulation Off* On	Set the printer to recognize and use the PPDS data stream.
Printer Emulations PS Emulation Off On*	Set the printer to recognize and use the PS data stream.
Printer Emulations Emulator Security Page Timeout 0–60 (60*)	Set the page timeout during emulation.
Printer Emulations Emulator Security Reset Emulator After Job Off* On	Reset the emulator after a print job.
Printer Emulations Emulator Security Disable Printer Message Access Off On*	Disable access to printer message during emulation.
Fax Configuration Fax Low Power Support Disable Sleep Permit Sleep Auto*	Set fax to enter Sleep mode whenever the printer determines that it should.
Fax Configuration Fax Storage Location NAND Disk*	Set the storage location for all faxes. Note: This menu item appears only when a hard disk is installed.
Print Configuration Black Only Mode Off* On	Print non-copy jobs in grayscale.
Note: An asterisk (*) next to a value indicates the factory default setting.	

Menu item	Description
Print Configuration Color Trapping Off 1 2* 3 4 5	Enhance the printed output to compensate for misregistration in the printer.
Print Configuration Font Sharpening 0–150 (24*)	Set a text point-size value below which the high-frequency screens are used when printing font data. For example, if the value is 24, then all fonts sized 24 points or less use the high-frequency screens.
Device Operations Quiet Mode Off* On	Set the printer to operate in Quiet Mode. Note: Enabling this setting slows down the overall performance of the printer.
Device Operations Safe Mode Off* On	Set the printer to operate in a special mode, in which it attempts to continue offering as much functionality as possible, despite known issues. For example, when set to On, and the duplex motor is nonfunctional, the printer performs one-sided printing of the documents even if the job is two-sided printing.
Device Operations Minimum Copy Memory 80 MB* 100 MB	Set the minimum memory allocation for storing copy jobs.
Device Operations Clear Custom Status	Erase user-defined strings for the Default or Alternate custom messages.
Device Operations Clear all remotely-installed messages	Erase messages that were remotely installed.
Device Operations Automatically Display Error Screens Off On*	Show existing error messages on the display after the printer remains inactive on the home screen for a length of time equal to the Screen Timeout setting.
Device Operations Honor orientation on fast path copy Off* On	Enable the printer to use the orientation setting under the Copy menu when sending quick copy jobs.
Device Operations Automatic Media Type Detection Off On*	Set the printer to detect the paper type of a page being loaded.
Note: An asterisk (*) next to a value indicates the factory default setting.	

Menu item	Description
Device Operations Enable Optional Parallel Port Off* On	Enable the optional parallel port.
Toner patch sensor setup Calibration frequency preference Disabled Fewest color adjustments Fewer color adjustments Normal* Better color accuracy Best color accuracy	Set the printer to put down the correct amount of toner to maintain color consistency.
Toner patch sensor setup Full calibration	Run the full color calibration.
Toner patch sensor setup Print TPS information page	Print a diagnostic page that contains information on toner patch sensor calibration.
Scanner Configuration Scanner Manual Registration Print Quick Test	Print a Quick Test target page. Note: Make sure that the margin spacing on the target page is uniform all the way around the target. If it is not, then the printer margins must be reset.
Scanner Configuration Scanner Manual Registration Front ADF Registration Rear ADF Registration Flatbed Registration	Manually register the flatbed and ADF after replacing the ADF, scanner glass, or controller board.
Scanner Configuration Edge Erase Flatbed Edge Erase (3*) ADF Edge Erase (3*)	Set the size, in millimeters, of the no-print area around an ADF or flatbed scan job.
Scanner Configuration ADF Deskew ADF Mechanical Deskew (On*) ADF Electronic Deskew (On*)	Reduce skewing of documents that are scanned from the ADF.
Scanner Configuration Disable Scanner Enabled* Disabled ADF Disabled	Disable the scanner when it is not working properly.
Note: An asterisk (*) next to a value indicates the factory default setting.	

Menu item	Description
Scanner Configuration Tiff Byte Order CPU Endianness* Little Endian Big Endian	Set the byte order of a TIFF-formatted scan output.
Scanner Configuration Exact Tiff Rows Per Strip On* Off	Set the RowsPerStrip tag value of a TIFF-formatted scan output.
Note: An asterisk (*) next to a value indicates the factory default setting.	

Out of Service Erase

Menu item	Description
Out of Service Erase Memory Last Sanitized Hard Disk Last Sanitized	Show information on when the printer memory or hard disk was last sanitized. Note: Hard Disk Last Sanitized appears only when a hard disk is installed.
Out of Service Erase Sanitize all information on nonvolatile memory Erase all printer and network settings Erase all apps and app settings Erase all shortcuts and shortcut settings Sanitize all information on hard disk Erase downloads (Erase all macros, fonts, PPOs, etc.) Erase buffered jobs Erase Held jobs	Clear all information on non-volatile memory and information on the hard disk. Note: Sanitize all information on hard disk appears only when a hard disk is installed.

Visible Home Screen Icons

Menu	Description
Copy E-mail Fax Status/Supplies Job Queue Change Language Shortcut Center Address Book Bookmarks Held Jobs USB FTP Scan Profiles App Profiles Forms and Favorites Scan Center Card Copy	Specify which icons to show on the home screen.

About this Printer

Menu item	Description
Asset Tag	Show the serial number of the printer.
Printer's Location	Identify the printer location. The maximum length is 63 characters.
Contact	Personalize the printer name. The maximum length is 63 characters.
Export Configuration File to USB	Export the configuration file to a flash drive.
Export Compressed Logs to USB	Export the compressed log files to a flash drive.

Print

Layout

Menu item	Description
Sides 1-Sided* 2-Sided	Specify whether to print on one side or both sides of the paper.
Flip Style Long Edge* Short Edge	Determine which side of the paper is bound when performing two-sided printing.
Note: An asterisk (*) next to a value indicates the factory default setting.	

Menu item	Description
Blank Pages Print Do Not Print*	Print blank pages that are included in a print job.
Collate Off (1,1,1,2,2,2) On (1,2,1,2,1,2)*	Keep the pages of a print job stacked in sequence, particularly when printing multiple copies of the job.
Separator Sheets None* Between Copies Between Jobs Between Pages	Insert blank separator sheets when printing.
Separator Sheet Source Tray [x] (1*) Multipurpose Feeder	Specify the paper source for the separator sheet.
Pages per Side Off* 2 pages per side 3 pages per side 4 pages per side 6 pages per side 9 pages per side 12 pages per side 16 pages per side	Print multiple page images on one side of a sheet of paper.
Pages per Side Ordering Horizontal* Reverse Horizontal Vertical Reverse Vertical	Specify the positioning of multiple page images when using the Pages per Side menu.
Pages per Side Orientation Auto* Landscape Portrait	Specify the orientation of multiple page images when using the Pages per Side menu.
Pages per Side Border None* Solid	Print a border around each page image when using the Pages per Side menu.
Copies 1–9999 (1*)	Specify the number of copies for each print job.
Print Area Normal* Fit to page Whole Page	Set the printable area on a sheet of paper.
Note: An asterisk (*) next to a value indicates the factory default setting.	

Setup

Menu item	Description
Printer Language PCL Emulation PS Emulation*	Set the printer language. Note: Setting a printer language default does not prevent a software program from sending print jobs that use another printer language.
Job Waiting Off* On	Preserve print jobs requiring supplies so that jobs not requiring the missing supplies can print. Note: This menu item appears only when a printer hard disk is installed.
Job Hold Timeout 0–255 (30*)	Set the time in seconds that the printer waits for user intervention before it holds jobs that require unavailable resources and continues to print other jobs in the print queue. Note: This menu item appears only when a printer hard disk is installed.
Printer Usage Max Speed Max Yield*	Determine how the color imaging kit operates during printing. Notes: <ul style="list-style-type: none"> • When set to Max Yield, the color imaging kit slows or stops while printing groups of black-only pages. • When set to Max Speed, the color imaging kit always runs while printing, whether color or black pages are being printed.
Download Target RAM* Disk	Specify where to save all permanent resources, such as fonts and macros, that have been downloaded to the printer. Note: This menu item appears only when a printer hard disk is installed.
Resource Save Off* On	Determine what the printer does with downloaded resources, such as fonts and macros, when it receives a job that requires more than the available memory. Notes: <ul style="list-style-type: none"> • When set to Off, the printer retains downloaded resources only until memory is needed. Resources associated with the inactive printer language are deleted. • When set to On, the printer preserves all the permanent downloaded resources across all language switches. When necessary, the printer shows memory full messages instead of deleting permanent resources.
Print All Order Alphabetical* Newest First Oldest First	Specify the order when you choose to print all held and confidential jobs. Note: This menu item appears only when a printer hard disk is installed.
Note: An asterisk (*) next to a value indicates the factory default setting.	

Quality

Menu item	Description
Print Mode Black and White Color*	Set how the printer generates color content.
Print Resolution 4800 CQ* 1200 dpi	Set the resolution for the printed output. Note: 4800 CQ provides high-quality output at maximum speed.
Toner Darkness 1 to 5 (4*)	Determine the lightness or darkness of text images.
Halftone Normal* Detail	Enhance the printed output to have smoother lines with sharper edges.
Color Saver Off* On	Reduce the amount of toner used to print graphics and images. Note: When set to On, this setting overrides the value of the Toner Darkness setting.
RGB Brightness -6 to 6 (0*)	Adjust the brightness, contrast, and saturation for color output. Note: This setting does not affect files where CMYK color specifications are used.
RGB Contrast 0 to 5 (0*)	
RGB Saturation 0 to 5 (0*)	
Note: An asterisk (*) next to a value indicates the factory default setting.	

Advanced Imaging

Menu item	Description
Color Balance Cyan -5 to 5 (0*) Magenta -5 to 5 (0*) Yellow -5 to 5 (0*) Black -5 to 5 (0*) Reset Defaults	Adjust the amount of toner that is used for each color.
Note: An asterisk (*) next to a value indicates the factory default setting.	

Menu item	Description
Color Correction Off Auto* Manual	Modify the color settings used to print documents. Notes: <ul style="list-style-type: none"> • Off sets the printer to receive the color correction from the software. • Auto sets the printer to apply different color profiles to each object on the printed page. • Manual allows the customization of the RGB or CMYK color conversions applied to each object on the printed page.
Color Samples Print Color Samples	Print sample pages for each of the RGB and CMYK color conversion tables used in the printer.
Color Adjust	Calibrate the printer to adjust color variations in the printed output.
Spot Color Replacement Set Custom CMYK	Assign specific CMYK values to twenty named spot colors.
Note: An asterisk (*) next to a value indicates the factory default setting.	

Job Accounting

Menu item	Description
Job Accounting Off* On	Set the printer to create a log of the print jobs that it receives. Note: This menu item appears only when a flash memory or hard disk is installed.
Accounting Log Frequency Daily Weekly Monthly*	Specify how often the printer creates a log file.
Log Action at End of Frequency None* E-mail Current Log E-mail & Delete Current Log Post Current Log Post & Delete Current Log	Specify how the printer responds when the frequency threshold expires. Note: The value defined in Accounting Log Frequency determines when this action is triggered.
Log Near Full Level Off On (5)*	Specify the maximum size of the log file before the printer executes the Log Action at Near Full.
Note: An asterisk (*) next to a value indicates the factory default setting.	

Menu item	Description
Log Action at Near Full None* E-mail Current Log E-mail & Delete Current Log E-mail & Delete Oldest Log Post Current Log Post & Delete Current Log Post & Delete Oldest Log Delete Current Log Delete Oldest Log Delete All But Current Delete All Logs	Specify how the printer responds when the hard disk is nearly full. Note: The value defined in Log Near Full Level determines when this action is triggered.
Log Action at Full None* E-mail & Delete Current Log E-mail & Delete Oldest Log Post & Delete Current Log Post & Delete Oldest Log Delete Current Log Delete Oldest Log Delete All But Current Delete All Logs	Specify how the printer responds when hard disk usage reaches the maximum limit (100MB).
URL to Post Log	Specify where the printer posts job accounting logs.
E-mail Address to Send Logs	Specify the e-mail address to which the printer sends job accounting logs.
Log File Prefix	Specify the prefix for the log files. Note: The current host name defined in the TCP/IP menu is used as the default log file prefix.
Note: An asterisk (*) next to a value indicates the factory default setting.	

XPS

Menu item	Description
Print Error Pages Off* On	Print the error pages that the printer encountered while processing an XPS file.
Minimum Line Width 1–30 (2*)	Set the minimum stroke width. Notes: <ul style="list-style-type: none"> Jobs printed in 1200 dpi use the value directly. Jobs printed in 4800 CQ use half the value.
Note: An asterisk (*) next to a value indicates the factory default setting.	

PDF

Menu item	Description
Scale To Fit Off* On	Scale the page content to fit the selected paper size.
Annotations Print Do Not Print*	Specify whether to print annotations in the PDF.
Print PDF Error Off On*	Enable the printing of PDF error.
Note: An asterisk (*) next to a value indicates the factory default setting.	

PostScript

Menu item	Description
Print PS Error Off* On	Print a page that describes the PostScript® error. Note: When an error occurs, processing of the job stops, the printer prints an error message, and the rest of the print job is flushed.
Minimum Line Width 1–30 (2*)	Set the minimum stroke width. Notes: <ul style="list-style-type: none"> Jobs printed in 1200 dpi use the value directly. Jobs printed in 4800 CQ use half the value.
Lock PS Startup Mode Off On*	Disable the SysStart file.
Image Smoothing Off* On	Enhance the contrast and sharpness of low-resolution images. Note: This setting has no effect on images with a resolution of 300 dpi or higher.
Font Priority Resident* Flash/Disk	Establish the font search order. Notes: <ul style="list-style-type: none"> Resident sets the printer to search its memory for the requested font before searching the flash memory or printer hard disk. Flash/Disk sets the printer to search the flash memory or printer hard disk for the requested font before searching the printer memory. This menu item appears only when a flash memory or hard disk is installed.
Wait Timeout Off On* (40 seconds)	Enable the printer to wait for more data before canceling a print job.
Note: An asterisk (*) next to a value indicates the factory default setting.	

PCL

Menu item	Description
Font Source Resident* Disk Flash All	Choose the source which contains the default font selection. Notes: <ul style="list-style-type: none"> Flash and Disk appear only when a flash memory or hard disk is installed. For Flash and Disk to appear, make sure that they are not read- or write-protected.
Font Name Courier*	Select a font from the specified font source.
Symbol Set 10U PC-8*	Specify the symbol set for each font name. Note: A symbol set is a set of alphabetic and numeric characters, punctuation, and special symbols. Symbol sets support the different languages or specific programs such as math symbols for scientific text.
Pitch 0.08–100 (10*)	Specify the pitch for fixed or monospaced fonts. Note: Pitch refers to the number of fixed-space characters in a horizontal inch of type.
Orientation Portrait* Landscape	Specify the orientation of text and graphics on the page.
Lines per Page 1–255	Specify the number of lines of text for each page printed through the PCL® datastream. Notes: <ul style="list-style-type: none"> This menu item activates vertical escapement that causes the selected number of requested lines to print between the default margins of the page. 60 is the U.S. factory default setting. 64 is the international factory default setting.
PCL5 Minimum Line Width 1–30 (2*)	Set the initial minimum stroke width. Notes:
PCLXL Minimum Line Width 1–30 (2*)	<ul style="list-style-type: none"> Jobs printed in 1200 dpi use the value directly. Jobs printed in 4800 CQ use half the value.
A4 Width 198 mm* 203 mm	Set the width of the logical page on A4-size paper. Note: Logical page is the space on the physical page where data is printed.
Auto CR after LF Off* On	Set the printer to perform a carriage return after a line feed control command. Note: Carriage return is a mechanism that commands the printer to move the position of the cursor to the first position on the same line.
Note: An asterisk (*) next to a value indicates the factory default setting.	

Menu item	Description
Auto LF after CR Off* On	Set the printer to perform a line feed after a carriage return control command.
Tray Renumber Assign MP Feeder Assign Tray [x] Assign Manual Paper Assign Manual Envelope	Configure the printer to work with a different print driver or custom application that uses a different set of source assignments to request a given paper source. Choose from the following options: Off*—The printer uses the factory default paper source assignments. None—The paper source ignores the Select Paper Feed command. 0–199—Select a numeric value to assign a custom value to a paper source.
Tray Renumber View Factory Defaults	Show the factory default value assigned for each paper source.
Tray Renumber Restore Defaults	Restore the tray renumber values to their factory defaults.
Print Timeout Off On* (90 seconds)	Set the printer to end a print job after it has been idle for the specified amount of time.
Note: An asterisk (*) next to a value indicates the factory default setting.	

HTML

Menu item	Description
Font Name Times*	Set the font to use when printing HTML documents.
Font Size 1–255 (12*)	Set the font size to use when printing HTML documents.
Scale 1–400% (100*)	Scale HTML documents for printing.
Orientation Portrait* Landscape	Set the page orientation for HTML documents.
Margin Size 8–255 mm (19*)	Set the page margin for HTML documents.
Backgrounds Do Not Print Print*	Print background information or graphics in HTML documents.
Note: An asterisk (*) next to a value indicates the factory default setting.	

Image

Menu item	Description
Auto Fit On Off*	Select the best available paper size and orientation setting for an image. Note: When set to On, this menu item overrides the scaling and orientation settings for the image.
Invert Off* On	Invert bitonal monochrome images. Note: This menu item does not apply to GIF or JPEG image formats.
Scaling Anchor Top Left Best Fit* Anchor Center Fit Height/Width Fit Height Fit Width	Adjust the image to fit the printable area. Note: When Auto Fit is set to On, Scaling is automatically set to Best Fit.
Orientation Portrait* Landscape Reverse Portrait Reverse Landscape	Specify the orientation of text and graphics on the page.
Note: An asterisk (*) next to a value indicates the factory default setting.	

Paper

Tray Configuration

Menu item	Description
Default Source Tray [x] (1*) Multipurpose Feeder Manual Paper Manual Envelope	Set the paper source for all print jobs.
Paper Size/Type Tray [x] Multipurpose Feeder Manual Paper Manual Envelope	Specify the paper size or paper type loaded in each paper source.
Note: An asterisk (*) next to a value indicates the factory default setting.	

Menu item	Description
Substitute Size Off Letter/A4 All Listed*	Set the printer to substitute a specified paper size if the requested size is not loaded in any paper source. Notes: <ul style="list-style-type: none"> • Off prompts the user to load the required paper size. • All Listed allows all available substitutions.
Configure MP Cassette* Manual First	Determine the behavior of the multipurpose feeder. Notes: <ul style="list-style-type: none"> • Cassette configures the multipurpose feeder as the automatic paper source. • Manual sets the multipurpose feeder only for manual-feed print jobs. • First configures the multipurpose feeder as the primary paper source.
Note: An asterisk (*) next to a value indicates the factory default setting.	

Media Configuration

Universal Setup

Menu item	Description
Units of Measure Inches Millimeters	Specify the unit of measurement for the universal paper. Note: Inches is the U.S. factory default setting. Millimeters is the international factory default setting.
Portrait Width 3–52 inches (8.5*) 76–1321 mm (216*)	Set the portrait width of the universal paper.
Portrait Height 3–52 inches (14*) 76.2–1321 mm (356*)	Set the portrait height of the universal paper.
Feed Direction Short Edge* Long Edge	Set the printer to pick paper from the short edge or long edge direction. Note: Long Edge appears only when the longest edge is shorter than the maximum width supported.
Note: An asterisk (*) next to a value indicates the factory default setting.	

Custom Scan Sizes

Menu item	Description
<p>Custom Scan Size [x]</p> <ul style="list-style-type: none"> Scan Size Name Width <ul style="list-style-type: none"> 1–8.5 inches (8.5*) 25.4–215.9 mm (215.9*) Height <ul style="list-style-type: none"> 1–25 inches (11*) 25.4–635 mm (279.4*) Orientation <ul style="list-style-type: none"> Portrait* Landscape 2 scans per side <ul style="list-style-type: none"> Off* On 	<p>Assign a scan size name and configure the scan settings.</p>

Media Types

Menu item	Description
<ul style="list-style-type: none"> Plain Card Stock Recycled Transparency Glossy Heavy Glossy Labels Vinyl Labels Bond Envelope Rough Envelope Letterhead Preprinted Colored Paper Light Heavy Rough/Cotton Custom Type [X] 	<p>Specify the texture, weight, and orientation of the paper.</p>

Copy

Copy Defaults

Menu item	Description
Content Type Text Text/Photo* Photo Graphics	Improve the output result based on the content of the original document.
Content Source Black and White Laser Color Laser* Inkjet Photo/Film Magazine Newspaper Press Other	Improve the output result based on the source of the original document.
Sides 1 sided to 1 sided* 1 sided to 2 sided 2 sided to 1 sided 2 sided to 2 sided	Specify the scanning behavior based on the original document.
Separator Sheets None* Between Copies Between Jobs Between Pages	Specify whether to insert blank separator sheets when printing.
Separator Sheet Source Tray [x] (1*) Multipurpose Feeder	Specify the paper source for the separator sheet.
Color Off On* Auto	Set the printer to generate color output from a scan job.
Pages per Side Off* 2 Portrait pages 4 Portrait pages 2 Landscape pages 4 Landscape pages	Specify the number of page images to print on one side of a sheet of paper.
Note: An asterisk (*) next to a value indicates the factory default setting.	

Menu item	Description
Print Page Borders Off* On	Place a border around each image when printing multiple pages on a single page.
Collate Off [1,1,1,2,2,2] On [1,2,1,2,1,2]*	Print multiple copies in sequence.
“Copy from” Size [List of paper sizes]	Set the paper size of the original document. Note: Letter is the U.S. factory default setting. A4 is the international factory default setting.
“Copy to” Source Tray [x] (1*) Multipurpose Feeder Auto Size Match	Specify the paper source for the copy job.
Temperature -4 to 4 (0*)	Specify whether to generate a cooler or warmer output.
Darkness 1 to 9 (5*)	Adjust the darkness of the scanned image.
Number of Copies 1–9999 (1*)	Specify the number of copies.
Header/Footer Left Header Middle Header Right Header Left Footer Middle Footer Right Footer	Specify the header or footer information on the scanned image.
Overlay Confidential Copy Draft Urgent Custom Off*	Specify the overlay text to print on each copy.
Custom overlay	Type the text for the Custom choice in Overlay menu.
Note: An asterisk (*) next to a value indicates the factory default setting.	

Advanced Imaging

Menu item	Description
Color Balance Cyan (0*) Magenta (0*) Yellow (0*)	Adjust the color intensity for cyan, magenta, and yellow.
Color Dropout Color Dropout (None*) Default Red Threshold (128*) Default Green Threshold (128*) Default Blue Threshold (128*)	Specify which color to drop during scanning, and adjust the dropout setting for that color.
Auto Color Detect Color Sensitivity (5*) Area Sensitivity (5*)	Configure the auto color detection setting.
Contrast Best for content* 0–5	Specify the contrast for the scanned image.
Background Removal Background Detection (Content-based*) Level (0*)	Remove the background color or image noise from the original document. Notes: <ul style="list-style-type: none"> • Content-based removes the background color from the original document . • Fixed removes image noise from a photo.
Auto Center Off* On	Align the content at the center of the page.
Mirror Image Off* On	Create a mirror image of the original document.
Negative Image Off* On	Create a negative image of the original document.
Shadow Detail -4 to 4 (0*)	Adjust the shadow detail in the original document.
Scan Edge to Edge Off* On	Scan the original document from edge to edge.
Sharpness 1–5 (3*)	Adjust the sharpness of the scanned image.
Note: An asterisk (*) next to a value indicates the factory default setting.	

Admin Controls

Menu item	Description
Allow Color Copies Off On*	Print copies in color.
Transparency Separators Off On*	Insert a blank sheet between transparencies.
Allow Priority Copies Off On*	Interrupt a print job to make copies.
Custom Job Scanning Off* On	Set the printer to scan the first set of original documents using the specified settings, and then scan the next set with the same or different settings. Note: This menu item appears only when a hard disk is installed.
Allow Save as Shortcut Off On*	Save copy settings as a shortcut.
Adjust ADF Skew Off On*	Set the printer to adjust the skewed images from documents that are scanned from the ADF.
Sample Copy Off* On	Print a sample copy to check the quality before printing the remaining copies. Note: This menu item appears only when a hard disk is installed.
Note: An asterisk (*) next to a value indicates the factory default setting.	

Fax

Fax Defaults

Fax Mode

Menu item	Description
Fax Mode Fax* Fax Server Disabled	Select a fax mode.
Note: An asterisk (*) next to a value indicates the factory default setting.	

Fax Setup

Menu item	Description
General Fax Settings <ul style="list-style-type: none">Fax NameFax NumberFax ID (Fax Number*)Enable Manual Fax (Off*)Memory Use (Equal*)Cancel Faxes (Allow*)Fax Number Masking (Off*)Digits to MaskEnable Line Connected Detection (On*)Enable Line In Wrong Jack Detection (On*)Enable Extension In Use Support (On*)Optimize Fax CompatibilityFax Transport (Analog*)	Configure the general fax settings.
Note: An asterisk (*) next to a value indicates the factory default setting.	

Menu item	Description
<p>Fax Send Settings</p> <ul style="list-style-type: none"> Resolution (Standard*) Original Size (Mixed Sizes*) Orientation (Portrait*) Sides (Off*) Content Type (Text*) Content Source (Color Laser*) Darkness (5*) Behind a PABX (Off*) Dial Mode (Tone*) Advanced Imaging <ul style="list-style-type: none"> Color Balance Color Dropout Contrast (Best for Content*) Background Removal <ul style="list-style-type: none"> Background Detection (Content-based*) Level (0*) Mirror Image (Off*) Negative Image (Off*) Shadow Detail (0*) Scan Edge to Edge (Off*) Sharpness (3*) Temperature (0*) Admin Controls <ul style="list-style-type: none"> Automatic Redial (5*) Redial Frequency (3 minutes*) Enable ECM (On*) Enable Fax Scans (On*) Driver to Fax (Off*) Allow Save as Shortcut (On*) Max Speed (33600*) Custom Job Scanning (Off*) Scan Preview (Off*) Adjust ADF Skew (On*) Enable Color Fax Scans (Off by Default*) Auto Convert Color Faxes to Mono Faxes (On*) Confirm Fax Number (Off*) Dial Prefix Dialing Prefix Rules 	<p>Configure the fax send settings.</p> <p>Note: Custom Job Scanning and Scan Preview appear only when a hard disk is installed.</p>
<p>Note: An asterisk (*) next to a value indicates the factory default setting.</p>	

Menu item	Description
<p>Fax Receive Settings</p> <ul style="list-style-type: none"> Rings to Answer (3*) Auto Reduction (Off*) Paper Source (Auto*) Sides (Off*) Separator Sheets (None*) Separator Sheet Source(Tray 1*) Output Bin(Standard Bin*) Fax Footer (Off*) Fax Footer Time Stamp (Receive*) Holding Faxes <ul style="list-style-type: none"> Held Fax Mode (Off*) Admin Controls <ul style="list-style-type: none"> Enable Fax Receive (On*) Enable Color Fax Receive (On*) Enable Caller ID (On*) Block No Name Fax (Off*) Banned Fax List Answer On (All Rings*) Auto Answer (On*) Manual Answer Code (*9*) Fax Forwarding (Print*) Max Speed (33600*) 	<p>Configure the fax receive settings.</p>
<p>Fax Cover Page</p> <ul style="list-style-type: none"> Fax Cover Page (Off by Default*) Include To field (Off*) Include From field (Off*) Include Message field (Off*) Include Logo (Off*) Include Footer [x] 	<p>Configure the fax cover page settings.</p>
<p>Fax Log Settings</p> <ul style="list-style-type: none"> Transmission Log Frequency (Always*) Transmission Log Action <ul style="list-style-type: none"> Print (On*) E-mail (Off*) Receive Error Log (Print Never*) Auto Print Logs (On*) Log Paper Source (Tray 1*) Logs Display (Remote Fax Name*) Enable Job Log (On*) Enable Call Log (On*) Log Output Bin (Standard Bin*) 	<p>Configure the fax log settings.</p>
<p>Note: An asterisk (*) next to a value indicates the factory default setting.</p>	

Menu item	Description
Speaker Settings Speaker Mode (Always Off*) Speaker Volume (Low*) Ringer Volume (Off*)	Set the speaker mode and volume for incoming or outgoing fax.
Note: An asterisk (*) next to a value indicates the factory default setting.	

Fax Server Setup

Menu item	Description
General Fax Settings To Format Reply Address Subject: Message: Enable analog receive (Off*)	Configure the general fax settings.
Fax Server E-mail Settings Use E-mail SMTP Server (Off*) Primary SMTP Gateway Primary SMTP Gateway Port Secondary SMTP Gateway Secondary SMTP Gateway Port SMTP Timeout (30 seconds*) Reply Address Use SSL/TLS (Disabled*) Required Trusted Certificate (On*) SMTP Server Authentication (No authentication required*) Device-Initiated E-mail (None*) User-Initiated E-mail (None*) Use Active Directory Device Credentials (Off*) Device Userid Device Password Kerberos 5 REALM NTLM Domain Disable "SMTP server not set up" error (Off*)	Configure the fax server e-mail settings.
Note: An asterisk (*) next to a value indicates the factory default setting.	

Menu item	Description
Fax Server Scan Settings Image Format (PDF (.pdf)*) Content Type (Text*) Content Source (Color Laser*) Fax Resolution (Standard*) Sides (Off*) Darkness (5*) Orientation (Portrait*) Original Size (Mixed Sizes*) Use Multi-Page TIFF (On*)	Configure the fax server scan settings.
Note: An asterisk (*) next to a value indicates the factory default setting.	

E-mail

E-mail Setup

Menu item	Description
Primary SMTP Gateway	Type the IP address or host name of the primary SMTP server for sending e-mail.
Primary SMTP Gateway Port 1–65535 (25*)	Enter the port number of the primary SMTP server.
Secondary SMTP Gateway	Type the server IP address or host name of your secondary or backup SMTP server.
Secondary SMTP Gateway Port 1–65535 (25*)	Enter the server port number of your secondary or backup SMTP server.
SMTP Timeout 5–30 seconds (30*)	Set the time before the printer times out if the SMTP server does not respond.
Reply Address	Specify a reply address in the e-mail.
Always use SMTP default Reply Address On Off*	Always use the default reply address in the SMTP server.
Use SSL/TLS Disabled* Negotiate Required	Specify whether to send e-mail using an encrypted link.
Require Trusted Certificate Off On*	Require a trusted certificate when accessing the SMTP server.
Note: An asterisk (*) next to a value indicates the factory default setting.	

Menu item	Description
SMTP Server Authentication No authentication required* Login / Plain NTLM CRAM-MD5 Digest-MD5 Kerberos 5	Set the authentication type for the SMTP server.
Device-Initiated E-mail None* Use Device SMTP Credentials	Specify whether credentials are required for device-initiated e-mail.
User-Initiated E-mail None* Use Device SMTP Credentials Use Session User ID and Password Use Session E-mail address and Password Prompt user	Specify whether credentials are required for user-initiated e-mail.
Use Active Directory Device Credentials Off* On	Specify whether credentials are required for user-initiated e-mail.
Device Userid	Specify the user ID and password to connect to the SMTP server.
Device Password	
Kerberos 5 REALM	Specify the realm for the Kerberos 5 authentication protocol.
NTLM Domain	Specify the domain name for the NTLM security protocol.
Note: An asterisk (*) next to a value indicates the factory default setting.	

E-mail Defaults

Menu item	Description
Subject:	Specify the e-mail subject and message.
Message:	
File Name	Specify the filename for the scanned document.
Format JPEG (.jpg) PDF (.pdf)* TIFF (.tif) XPS (.xps)	Specify the file format of the scanned document.
Note: An asterisk (*) next to a value indicates the factory default setting.	

Menu item	Description
PDF Settings PDF Version (1.5*) Archival Version (A-1a*) Highly Compressed (Off*) Secure (Off*) Archival (PDF/A) (Off*)	Configure the PDF settings of the scanned document. Notes: <ul style="list-style-type: none"> • Archival Version and Archival (PDF/A) are supported only when PDF Version is set to 1.4. • Highly Compressed appears only when a hard disk is installed.
Content Type Text Text/Photo* Photo Graphics	Improve the output result based on the content type of the original document.
Content Source Black and White Laser Color Laser* Inkjet Photo/Film Magazine Newspaper Press Other	Improve the output result based on the content source of the original document.
Color Black and White Gray Color* Auto	Set the printer to capture file content in color or in mono.
Resolution 75 dpi 150 dpi* 200 dpi 300 dpi 400 dpi 600 dpi	Set the resolution of the scanned image.
Darkness 1–9 (5*)	Adjust the darkness of the scanned image.
Orientation Portrait* Landscape	Specify the orientation of the original document.
Original Size Mixed Sizes*	Set the paper size of the original document.
Note: An asterisk (*) next to a value indicates the factory default setting.	

Menu item	Description
Sides Off* Short Edge Long Edge	Specify the orientation of the original document when scanning on both sides of the document.
Note: An asterisk (*) next to a value indicates the factory default setting.	

Advanced Imaging

Menu item	Description
Color Balance Cyan (0*) Magenta (0*) Yellow (0*)	Adjust the color intensity for cyan, magenta, and yellow.
Color Dropout Color Dropout (None*) Default Red Threshold (128*) Default Green Threshold (128*) Default Blue Threshold (128*)	Specify which color to drop during scanning, and adjust the dropout setting for that color.
Auto Color Detect Color Sensitivity (5*) Area Sensitivity (5*) E-mail Bit Depth (1 bit*)	Configure the auto color detection setting.
JPEG Quality Best for content* 5–95	Set the JPEG quality of the scanned image.
Contrast Best for content* 0–5	Specify the contrast for the scanned image.
Background Removal Background Detection (Content-based*) Level (0*)	Remove the background color or image noise from the original document. Notes: <ul style="list-style-type: none"> • Content-based removes the background color from the original document. • Fixed removes image noise from a photo.
Mirror Image Off* On	Create a mirror image of the original document.
Negative Image Off* On	Create a negative image of the original document.
Note: An asterisk (*) next to a value indicates the factory default setting.	

Menu item	Description
Shadow Detail -4 to 4 (0*)	Adjust the shadow detail in the scanned image.
Scan Edge to Edge Off* On	Scan the original document from edge to edge.
Sharpness 1–5 (3*)	Adjust the sharpness in the scanned image.
Temperature -4 to 4 (0*)	Generate a bluer or redder output of the original document.
Blank Pages Blank Page Removal (Remove*) Blank Page Sensitivity (5*)	Set the sensitivity of scans in relation to blank pages in the original document.
Note: An asterisk (*) next to a value indicates the factory default setting.	

Admin Controls

Menu item	Description
Max E-mail Size 0–65535 (0*)	Set the allowable file size for each e-mail.
Size Error Message	Specify an error message that the printer sends when an e-mail exceeds its allowable file size. Note: You can type up to 1024 characters.
Limit Destinations	Limit sending of e-mail only to the specified list of domain name. Note: Use a comma to separate each domain.
Send Me a Copy Never appears* On by Default Off by Default Always On	Send a copy of the e-mail to yourself.
Allow self e-mails only Off* On	Set the printer to send e-mails to yourself only.
Use cc:/bcc: Off* On	Enable carbon copy and blind carbon copy in e-mail.
Use Multi-Page TIFF Off On*	Enable scanning of multiple TIFF images in one TIFF file.
Note: An asterisk (*) next to a value indicates the factory default setting.	

Menu item	Description
TIFF Compression JPEG LZW*	Specify the compression type for TIFF files.
Text Default 5–95 (75*)	Set the text quality in the content being scanned.
Text/Photo Default 5–95 (75*)	Set the text and photo quality in the content being scanned.
Photo Default 5–95 (50*)	Set the photo quality of the content being scanned.
Adjust ADF Skew Off On*	Set the printer to adjust the skewed images from documents that are scanned from the ADF.
Transmission Log Print log* Do Not Print Log Print Only For Error	Print a transmission log for e-mail scans.
Log Paper Source Tray [x] (1*) Multipurpose Feeder	Specify the paper source for printing e-mail logs.
Custom Job Scanning Off* On	Set the printer to scan the first set of original documents using the specified settings, and then scan the next set with the same or different settings. Note: This menu item appears only when a hard disk is installed.
Scan Preview Off On*	Show a scan preview of the original document. Note: This menu item appears only when a hard disk is installed.
Allow Save as Shortcut Off On*	Save an e-mail address as a shortcut.
E-mail Images Sent As Attachment* Web Link	Specify how to send the images that are included in the e-mail.
Reset E-mail Information After Sending Off On*	Reset the To, Subject, Message, and Filename fields to their default values after sending an e-mail.
Note: An asterisk (*) next to a value indicates the factory default setting.	

Web Link Setup

Menu item	Description
Server	Specify the credentials of the server that is hosting the images that are included in the e-mail.
Login	
Password	
Path	
File Name	
Web Link	

FTP

FTP Defaults

Menu item	Description
Format JPEG (.jpg) PDF (.pdf)* TIFF (.tif) XPS (.xps)	Specify the file format for the scanned image.
PDF Settings PDF Version (1.5*) Archival Version (A-1a*) Highly Compressed (Off*) Secure (Off*) Archival (PDF/A) (Off*)	Configure the PDF settings for the scanned image. Note: Highly Compressed appears only when a hard disk is installed.
Content Type Text Text/Photo* Graphics Photo	Improve the output result based on the content type of the original document.
Content Source Black and White Laser Color Laser* Inkjet Photo/Film Magazine Newspaper Press Other	Improve the output result based on the content source of the original document.
Note: An asterisk (*) next to a value indicates the factory default setting.	

Menu item	Description
Color Black and White Gray Color* Auto	Set the printer to capture file content in color or in mono.
Resolution 75 dpi 150 dpi* 200 dpi 300 dpi 400 dpi 600 dpi	Set the resolution of the scanned image.
Darkness 1–9 (5*)	Adjust the darkness of the scanned image.
Orientation Portrait* Landscape	Specify the orientation of the original document.
Original Size Mixed Sizes*	Set the paper size of the original document.
Sides Off* Long Edge Short Edge	Specify the orientation when scanning on both sides of the document.
File Name	Specify the file name of the scanned image.
Note: An asterisk (*) next to a value indicates the factory default setting.	

Advanced Imaging

Menu item	Description
Color Balance Cyan (0*) Magenta (0*) Yellow (0*)	Adjust the color intensity for cyan, magenta, and yellow.
Color Dropout Color Dropout (None*) Default Red Threshold (128*) Default Green Threshold (128*) Default Blue Threshold (128*)	Specify which color to drop during scanning, and adjust the dropout setting for that color.
Note: An asterisk (*) next to a value indicates the factory default setting.	

Menu item	Description
Auto Color Detect Color Sensitivity (5*) Area Sensitivity (5*) FTP Bit Depth (1 bit*)	Configure the auto color detection setting.
JPEG Quality Best for content* 5–95	Set the JPEG quality of the scanned image.
Contrast Best for content* 0 1 2 3 4 5	Specify the contrast for the scanned image.
Background Removal Background Detection (Content-based*) Level (0*)	Remove the background color or image noise from the original document. Notes: <ul style="list-style-type: none"> • Content-based removes the background color from the original document . • Fixed removes image noise from a photo.
Mirror Image Off* On	Create a mirror image of the original document.
Negative Image Off* On	Create a negative image of the original document.
Shadow Detail -4 to 4 (0*)	Adjust the shadow detail in the scanned image.
Scan Edge to Edge Off* On	Allow edge-to-edge scanning of the original document.
Sharpness 1–5 (3*)	Adjust the sharpness in the scanned image.
Temperature -4 to 4 (0*)	Generate a bluer or redder output of the original document.
Blank Pages Blank Page Removal (Remove*) Blank Page Sensitivity (5*)	Set the sensitivity of scans in relation to blank pages in the original document.
Note: An asterisk (*) next to a value indicates the factory default setting.	

Admin Controls

Menu item	Description
Text Default 5–95 (75*)	Set the quality of text on the scanned image.
Text/Photo Default 5–95 (75*)	Set the quality of text and photo on the scanned image.
Photo Default 5–95 (50*)	Set the quality of photo on the scanned image.
Use Multi-Page TIFF On* Off	Enable scanning of multiple TIFF images in one TIFF file.
TIFF Compression LZW* JPEG	Specify the compression type for TIFF files.
Transmission Log Print Log* Do Not Print Log Print Only For Error	Print a transmission log for FTP scans.
Log Paper Source Tray [x] (1*) Multipurpose Feeder	Specify the paper source for printing FTP logs.
Custom Job Scanning Off* On	Set the printer to scan the first set of original documents using the specified settings, and then scan the next set with the same or different settings. Note: This menu item appears only when a hard disk is installed.
Scan Preview Off On*	Show a preview of the original document. Note: This menu item appears only when a hard disk is installed.
Allow Save as Shortcut Off On*	Save an FTP address as a shortcut.
Adjust ADF Skew Off On*	Set the printer to adjust the skewed images from documents that are scanned from the ADF.
Note: An asterisk (*) next to a value indicates the factory default setting.	

USB Drive

Flash Drive Scan

Menu item	Description
Format JPEG (.jpg) PDF (.pdf)* TIFF (.tif) XPS (.xps)	Specify the file format for the scanned image.
PDF Settings PDF Version (1.5*) Archival Version (A-1a*) Highly Compressed (Off*) Secure (Off*) Archival (PDF/A) (Off*)	Configure the PDF settings of the scanned image. Notes: <ul style="list-style-type: none"> • Archival Version and Archival (PDF/A) are supported only when PDF Version is set to 1.4. • Highly Compressed appears only when a hard disk is installed.
Content Type Text Text/Photo* Graphics Photo	Improve the output result based on the content type of the original document.
Content Source Black and White Laser Color Laser* Inkjet Photo/Film Magazine Newspaper Press Other	Improve the output result based on the content source of the original document.
Color Black and White Gray Color* Auto	Set the printer to capture file content in color or in mono.
Resolution 75 dpi 150 dpi* 200 dpi 300 dpi 400 dpi 600 dpi	Set the resolution of the scanned image.
Note: An asterisk (*) next to a value indicates the factory default setting.	

Menu item	Description
Darkness 1–9 (5*)	Adjust the darkness of the scanned image.
Orientation Portrait* Landscape	Specify the orientation of the original document.
Original Size Mixed Sizes*	Set the paper size of the original document.
Sides Off* Long edge Short edge	Specify the orientation of the original document when scanning on both sides of the document.
File Name	Specify the file name of the scanned image.
Note: An asterisk (*) next to a value indicates the factory default setting.	

Advanced Imaging

Menu item	Description
Color Balance Cyan (0*) Magenta (0*) Yellow (0*)	Adjust the color intensity for cyan, magenta, and yellow.
Color Dropout Color Dropout (None*) Default Red Threshold (128*) Default Green Threshold (128*) Default Blue Threshold (128*)	Specify which color to drop during scanning, and adjust the dropout setting for that color.
Auto Color Detect Color Sensitivity (5*) Area Sensitivity (5*) Scan Bit Depth (1 bit*)	Configure the auto color detection setting.
JPEG Quality Best for content* 5–95	Set the JPEG quality of the scanned image.
Contrast Best for content* 0–5	Specify the contrast for the scanned image.
Note: An asterisk (*) next to a value indicates the factory default setting.	

Menu item	Description
Background Removal Background Detection (Content-based*) Level (0*)	Remove the background color or image noise from the original document. Notes: <ul style="list-style-type: none"> • Content-based removes the background color from the original document. • Fixed removes image noise from a photo.
Mirror Image Off* On	Create a mirror image of the original document.
Negative Image Off* On	Create a negative image of the original document.
Shadow Detail -4 to 4 (0*)	Adjust the shadow detail in the scanned image.
Scan Edge to Edge Off* On	Scan the original document from edge to edge.
Sharpness 1–5 (3*)	Adjust the sharpness in the scanned image.
Temperature -4 to 4 (0*)	Generate a bluer or redder output of the original document.
Blank Pages Blank Page Removal (Remove*) Blank Page Sensitivity (5*)	Set the sensitivity of scans in relation to blank pages in the original document.
Note: An asterisk (*) next to a value indicates the factory default setting.	

Admin Controls

Menu item	Description
Text Default 5–95 (75*)	Set the quality of text on the scanned image.
Text/Photo Default 5–95 (75*)	Set the quality of text and photo on the scanned image.
Photo Default 5–95 (50*)	Set the quality of a photo on the scanned image.
Use Multi-Page TIFF Off On*	Enable scanning of multiple TIFF images in one TIFF file.
Note: An asterisk (*) next to a value indicates the factory default setting.	

Menu item	Description
TIFF Compression LZW* JPEG	Specify the compression type for TIFF files.
Custom Job Scanning Off* On	Set the printer to scan the first set of original documents using the specified settings, and then scan the next set with the same or different settings. Note: This menu item appears only when a hard disk is installed.
Scan Preview Off On*	Show a scan preview of the original document. Note: This menu item appears only when a hard disk is installed.
Adjust ADF Skew Off On*	Set the printer to adjust the skewed images from documents that are scanned from the ADF.
Note: An asterisk (*) next to a value indicates the factory default setting.	

Flash Drive Print

Menu item	Description
Number of Copies 1–9999 (1*)	Set the number of copies.
Paper Source Tray [x] (1*) Multipurpose Feeder Manual Paper Manual Envelope	Set the paper source for the print job.
Color Off On*	Print a flash drive file in color.
Collate (1,1) (2,2,2) (1,2,3) (1,2,3)*	Keep the pages of a print job stacked in sequence, particularly when printing multiple copies of the job.
Sides 1-Sided* 2-Sided	Specify whether to print on one side or both sides of the paper.
Flip Style Long Edge* Short Edge	Determine which side of the paper is bound when performing two-sided printing.
Note: An asterisk (*) next to a value indicates the factory default setting.	

Menu item	Description
Pages per Side Off* 2 pages per side 3 pages per side 4 pages per side 6 pages per side 9 pages per side 12 pages per side 16 pages per side	Print multiple page images on one side of a sheet of paper.
Pages per Side Ordering Horizontal* Reverse Horizontal Reverse Vertical Vertical	Specify the positioning of multiple page images when using Pages per Side menu.
Pages per Side Orientation Auto* Landscape Portrait	Specify the orientation of multiple page images when using Pages per Side menu.
Pages per Side Border None* Solid	Print a border around each page image when using Pages per Side menu.
Separator Sheets Off* Between Copies Between Jobs Between Pages	Insert blank separator sheets when printing.
Separator Sheet Source Tray [x] (1*) Multipurpose Feeder	Specify the paper source for the separator sheet.
Blank Pages Do Not Print* Print	Print blank pages in a print job.
Note: An asterisk (*) next to a value indicates the factory default setting.	

Network/Ports

Network Overview

Menu item	Description
Active Adapter Auto* Standard Network Wireless	Specify the type of the network connection. Note: Wireless is available only in printers connected to a wireless network.
Network Status	Show the connectivity status of the printer network.
Display Network Status on Printer Off On*	Show the network status on the display.
Speed, Duplex	Show the speed of the currently active network card.
IPv4	Show the IPv4 address.
All IPv6 Addresses	Show all IPv6 addresses.
Reset Print Server	Reset all active network connections to the printer. Note: This setting removes all network configuration settings.
Network Job Timeout Off On* (90 seconds)	Set the time before the printer cancels a network print job.
Banner Page Off* On	Print a banner page.
Scan to PC Port Range	Specify a valid port range for printers that are behind a port blocking firewall.
Enable Network Connections Off On*	Enable the printer to connect to a network.
Enable LLDP Off* On	Enable Link Layer Discovery Protocol (LLDP) in the printer.
Note: An asterisk (*) next to a value indicates the factory default setting.	

Wireless

Note: This menu is available only in printers connected to a Wi-Fi network or printers that have a wireless network adapter.

Menu item	Description
<p>Setup On Printer Panel</p> <ul style="list-style-type: none"> Choose Network Add Wi-Fi Network <ul style="list-style-type: none"> Network Name Network Mode <ul style="list-style-type: none"> Infrastructure Wireless Security Mode <ul style="list-style-type: none"> Disabled* WEP WPA2/WPA - Personal WPA2 - Personal 802.1x - RADIUS 	<p>Configure the Wi-Fi connection using the control panel.</p> <p>Note: 802.1x - RADIUS can be configured only from the Embedded Web Server.</p>
<p>Wi-Fi Protected Setup</p> <ul style="list-style-type: none"> WPS Auto Detect <ul style="list-style-type: none"> Off On* Start Push Button Method Start PIN Method 	<p>Establish a Wi-Fi network and enable network security.</p> <p>Notes:</p> <ul style="list-style-type: none"> • WPS Auto Detect appears only when the Wireless Security Mode is set to WEP. • Start Push-Button Method connects the printer to a Wi-Fi network when buttons on both the printer and the access point (wireless router) are pressed within a given time. • Start PIN Method connects the printer to a Wi-Fi network when a PIN on the printer is entered into the wireless settings of the access point.
<p>Network Mode</p> <ul style="list-style-type: none"> BSS Type <ul style="list-style-type: none"> Infrastructure* 	<p>Specify the network mode.</p>
<p>Compatibility</p> <ul style="list-style-type: none"> 802.11b/g/n (2.4GHz)* 802.11a/b/g/n/ac (2.4GHz/5GHz) 802.11a/n/ac (5GHz) 	<p>Specify the standard for the Wi-Fi network.</p> <p>Note: 802.11a/b/g/n/ac (2.4GHz/5GHz) and 802.11a/n/ac (5GHz) only appear when a Wi-Fi option is installed.</p>
<p>Wireless Security Mode</p> <ul style="list-style-type: none"> Disabled* WEP WPA2/WPA-Personal WPA2-Personal 802.1x - RADIUS 	<p>Set the security mode for connecting the printer to Wi-Fi devices.</p> <p>Note: 802.1x - RADIUS can be configured only from the Embedded Web Server.</p>
<p>WEP Authentication Mode</p> <ul style="list-style-type: none"> Auto* Open Shared 	<p>Set the type of Wireless Encryption Protocol (WEP) for the printer.</p> <p>Note: This menu item appears only when the Wireless Security Mode is set to WEP.</p>
<p>Set WEP Key</p>	<p>Specify a WEP password for secure Wi-Fi connection.</p>

Menu item	Description
WPA2/WPA Personal AES	Enable Wi-Fi security through Wi-Fi Protected Access (WPA). Note: This menu item appears only when the Wireless Security Mode is set to WPA2/WPA-Personal.
Set Pre-Shared Key	Set the password for secure Wi-Fi connection.
WPA2-Personal AES	Enable Wi-Fi security through WPA2. Note: This menu item appears only when the Wireless Security Mode is set to WPA2-Personal.
802.1x Encryption Mode WPA+ WPA2*	Enable Wi-Fi security through 802.1x standard. Notes: <ul style="list-style-type: none"> • This menu item appears only when the Wireless Security Mode is set to 802.1x - RADIUS. • 802.1x - RADIUS can be configured only from the Embedded Web Server.
IPv4 Enable DHCP On* Off Set Static IP Address IP Address Netmask Gateway	Enable and configure IPv4 settings in the printer.
IPv6 Enable IPv6 On* Off Enable DHCPv6 On Off* Stateless Address Autoconfiguration On* Off DNS Server Address Manually Assigned IPv6 Address Manually Assigned IPv6 Router Address Prefix All IPv6 Addresses All IPv6 Router Addresses	Enable and configure IPv6 settings in the printer.
Network Address UAA LAA	View the network addresses.

Menu item	Description
PCL SmartSwitch Off On*	Set the printer to switch automatically to PCL emulation when a print job requires it, regardless of the default printer language. Note: If PCL SmartSwitch is off, then the printer does not examine incoming data and uses the default printer language specified in the Setup menu.
PS SmartSwitch Off On*	Set the printer to switch automatically to PS emulation when a print job requires it, regardless of the default printer language. Note: If PS SmartSwitch is off, then the printer does not examine incoming data and uses the default printer language specified in the Setup menu.
Job Buffering On Off*	Temporarily store print jobs in the printer hard disk before printing. Note: This menu item appears only when a hard disk is installed.
Mac Binary PS Auto* On Off	Set the printer to process Macintosh binary PostScript print jobs. Notes: <ul style="list-style-type: none"> • On processes raw binary PostScript print jobs. • Off filters print jobs using the standard protocol.

Wi-Fi Direct

Menu item	Description
Enable Wi-Fi Direct On Off*	Set the printer to connect directly to Wi-Fi devices.
Wi-Fi Direct Name	Specify the name of the Wi-Fi Direct network.
Wi-Fi Direct Password	Set the password to authenticate and validate users on a Wi-Fi connection.
Show Password on Setup Page Off On*	Show the Wi-Fi Direct Password on the Network Setup Page.
Preferred Channel Number 1–11 Auto*	Set the preferred channel of the Wi-Fi network.
Group Owner IP Address	Specify the IP address of the group owner.
Auto-Accept Push Button Requests Off* On	Accept requests to connect to the network automatically. Note: Accepting clients automatically is not secured.
Note: An asterisk (*) next to a value indicates the factory default setting.	

Ethernet

Menu item	Description
Network Speed	Show the speed of the active network adapter.
IPv4 Enable DHCP (On*) Set Static IP Address	Configure the IPv4 settings.
IPv6 Enable IPv6 (On*) Enable DHCPv6 (Off*) Stateless Address Autoconfiguration (On*) DNS Server Address Manually Assigned IPv6 Address Manually Assigned IPv6 Router Address Prefix (64*) All IPv6 Addresses All IPv6 Router Addresses	Configure the IPv6 settings.
Network Address UAA LAA	Specify the network address.
PCL SmartSwitch Off On*	Set the printer to switch automatically to PCL emulation when a print job requires it, regardless of the default printer language. Note: When this setting is disabled, the printer does not examine incoming data and uses the default printer language specified in the Setup menu.
PS SmartSwitch Off On*	Set the printer to switch automatically to PostScript emulation when a print job requires it, regardless of the default printer language. Note: When this setting is disabled, the printer does not examine incoming data and uses the default printer language specified in the Setup menu.
Job Buffering Off* On	Temporarily store jobs on the hard disk before printing. Note: This menu item appears only when a hard disk is installed.
Mac Binary PS Auto* On Off	Set the printer to process Macintosh binary PostScript print jobs. Notes: <ul style="list-style-type: none"> • Auto processes print jobs from computers using either Windows or Macintosh operating systems. • Off filters PostScript print jobs using the standard protocol.
Energy Efficient Ethernet On Off Auto*	Reduce power consumption when the printer does not receive data from the Ethernet network.
Note: An asterisk (*) next to a value indicates the factory default setting.	

TCP/IP

Note: This menu appears only in network printers or printers attached to print servers.

Menu item	Description
Set Hostname	Set the current TCP/IP host name.
Domain Name	Set the domain name.
Allow DHCP/BOOTP to update NTP server On* Off	Allow the DHCP and BOOTP clients to update the NTP settings of the printer.
Zero Configuration Name	Specify a service name for the zero configuration network.
Enable Auto IP Off* On	Assign an IP address automatically.
DNS Server Address	Specify the current Domain Name System (DNS) server address.
Backup DNS Address	Specify the backup DNS server addresses.
Backup DNS Address 2	
Backup DNS Address 3	
Domain Search Order	Specify a list of domain names to locate the printer and its resources that reside in different domains on the network.
Enable DDNS Off* On	Update the Dynamic DNS settings.
DDNS TTL	Specify the current DDNS settings.
Default TTL	
DDNS Refresh Time	
Enable mDNS Off On*	Update the multicast DNS settings.
WINS Server Address	Specify a server address for Windows Internet Name Service (WINS).
Enable BOOTP Off* On	Allow the BOOTP to assign a printer IP address.
Restricted Server List	Specify the IP addresses that are allowed to communicate with the printer over TCP/IP. Notes: <ul style="list-style-type: none"> • Use a comma to separate each IP address. • You can add up to 50 IP addresses.
Note: An asterisk (*) next to a value indicates the factory default setting.	

Menu item	Description
Restricted Server List Options Block All Ports* Block Printing Only Block Printing and HTTP Only	Specify the access option for IP addresses that are not in the list.
MTU 256–1500 Ethernet (1500*)	Specify a maximum transmission unit (MTU) parameter for the TCP connections.
Raw Print Port 1–65535 (9100*)	Specify a raw port number for printers connected on a network.
Outbound Traffic Maximum Speed Off* On	Set the maximum transfer rate of the printer. Note: When enabled, the option for this setting is 100–1000000 Kilobits/second.
Enable TLSv1.0 Off On*	Enable the TLSv1.0 protocol.
Enable TLSv1.1 Off On*	Enable the TLSv1.1 protocol.
SSL Cipher List	Specify the cipher algorithms to use for the SSL or the TLS connections.
Note: An asterisk (*) next to a value indicates the factory default setting.	

SNMP

Note: This menu appears only in network printers or printers that are attached to print servers.

Menu item	Description
SNMP Versions 1 and 2c Enabled Off On* Allow SNMP Set Off On* Enable PPM MIB Off On* SNMP Community	Configure Simple Network Management Protocol (SNMP) versions 1 and 2c to install print drivers and applications.
Note: An asterisk (*) next to a value indicates the factory default setting.	

Menu item	Description
SNMP Version 3 Enabled Off On* Set Read/Write Credentials User Name Password Set Read-only Credentials User Name Password Authentication Hash MD5 SHA1* Minimum Authentication Level No Authentication, No Privacy Authentication, No Privacy Authentication, Privacy* Privacy Algorithm DES AES-128*	Configure SNMP version 3 to install and update the printer security.
Note: An asterisk (*) next to a value indicates the factory default setting.	

IPSec

Note: This menu appears only in network printers or printers that are attached to print servers.

Menu item	Description
Enable IPSec Off On*	Enable Internet Protocol Security (IPSec).
Base Configuration Default* Compatibility Secure	Set the IPSec base configuration.
DH (Diffie-Hellman) Group Proposal modp2048 (14)* modp3072 (15) modp4096 (16) modp6144 (17)	Set the IPSec base configuration. Note: This menu item appears only when Base Configuration is set to Compatibility.
Proposed Encryption Method 3DES AES*	Set the encryption method. Note: This menu item appears only when Base Configuration is set to Compatibility.
Note: An asterisk (*) next to a value indicates the factory default setting.	

Menu item	Description
Proposed Authentication Method SHA1 SHA256* SHA512	Set the authentication method. Note: This menu item appears only when Base Configuration is set to Compatibility.
IKE SA Lifetime (Hours) 1 2 4 8 24*	Specify the IKE SA expiry period. Note: This menu item appears only when Base Configuration is set to Secure.
IPSec SA Lifetime (Hours) 1 2 4 8* 24	Specify the IPSec SA expiry period. Note: This menu item appears only when Base Configuration is set to Secure.
IPSec Device Certificate	Specify an IPSec certificate.
Pre-Shared Key Authenticated Connections Host [x]	Configure the authenticated connections of the printer.
Certificate Authenticated Connections Host [x] Address[/subnet]	
Note: An asterisk (*) next to a value indicates the factory default setting.	

802.1x

Note: This menu appears only in network printers or printers that are attached to print servers.

Menu item	Description
Active Off* On	Let the printer join networks that require authentication before allowing access.
Note: An asterisk (*) next to a value indicates the factory default setting.	

LPD Configuration

Note: This menu appears only in network printers or printers that are attached to print servers.

Menu item	Description
LPD Timeout 0–65535 seconds (90*)	Set the time-out value to stop the Line Printer Daemon (LPD) server from waiting indefinitely for hung or invalid print jobs.
Note: An asterisk (*) next to a value indicates the factory default setting.	

Menu item	Description
LPD Banner Page Off* On	Print a banner page for all LPD print jobs. Note: A banner page is the first page of a print job used as a separator of print jobs and to identify the originator of the print job request.
LPD Trailer Page Off* On	Print a trailer page for all LPD print jobs. Note: A trailer page is the last page of a print job.
LPD Carriage Return Conversion Off* On	Enable carriage return conversion. Note: Carriage return is a mechanism that commands the printer to move the position of the cursor to the first position on the same line.
Note: An asterisk (*) next to a value indicates the factory default setting.	

HTTP/FTP Settings

Menu item	Description
Enable HTTP Server Off On*	Access the Embedded Web Server to monitor and manage the printer.
Enable HTTPS Off On*	Enable Hypertext Transfer Protocol Secure (HTTPS) to encrypt data transferring to and from the print server.
Force HTTPS Connections On Off*	Force the printer to use HTTPS connections.
Enable FTP/TFTP Off On*	Send files using FTP/TFTP.
Local Domains	Specify domain names for HTTP and FTP servers.
HTTP Proxy IP Address	Configure the HTTP and FTP server settings.
FTP Proxy IP Address	
HTTP Default IP Port	
HTTPS Device Certificate	
FTP Default IP Port	
Timeout for HTTP/FTP Requests 1–299 (30*)	Specify the amount of time before the server connection stops.
Retries for HTTP/FTP Requests 1–299 (3*)	Set the number of retries to connect to the HTTP/FTP server.
Note: An asterisk (*) next to a value indicates the factory default setting.	

ThinPrint

Menu item	Description
Enable ThinPrint Off* On	Print using ThinPrint.
Port Number 4000–4999 (4000*)	Set the port number for the ThinPrint server.
Bandwidth (bits/sec) 100–1000000 (0*)	Set the speed to transmit data in a ThinPrint environment.
Packet Size (kbytes) 0–64000 (0*)	Set the packet size for data transmission.
Note: An asterisk (*) next to a value indicates the factory default setting.	

USB

Menu item	Description
PCL SmartSwitch Off On*	Set the printer to switch to PCL emulation when a print job received through a USB port requires it, regardless of the default printer language. Note: When this setting is disabled, the printer does not examine incoming data and uses the default printer language specified in the Setup menu.
PS SmartSwitch Off On*	Set the printer to switch to PostScript emulation when a print job received through a USB port requires it, regardless of the default printer language. Note: When this setting is disabled, the printer does not examine incoming data and uses the default printer language specified in the Setup menu.
Job Buffering Off* On	Temporarily store jobs on the hard disk before printing. Note: This menu item appears only when a hard disk is installed.
Mac Binary PS Auto* On Off	Set the printer to process Macintosh binary PostScript print jobs. Notes: <ul style="list-style-type: none"> • Auto processes print jobs from computers using either Windows or Macintosh operating systems. • Off filters PostScript print jobs using the standard protocol.
Enable USB Port Off On*	Enable the front USB drive port.
Note: An asterisk (*) next to a value indicates the factory default setting.	

Restrict external network access

Menu item	Description
Restrict external network access Off* On	Restrict access to network sites.
External network address	Specify the network addresses with restricted access.
E-mail address for notification	Specify an e-mail address to send a notification of logged events.
Ping frequency 1–300 (10*)	Specify the network query interval in seconds.
Subject	Specify the subject and message of the notification e-mail.
Message	
Note: An asterisk (*) next to a value indicates the factory default setting.	

Security

Login Methods

Manage Permissions

Menu item	Description
<p>Function Access</p> <ul style="list-style-type: none"> Access Address Book in Apps Modify Address Book Manage Shortcuts Create Profiles Manage Bookmarks Flash Drive Print Flash Drive Color Printing Flash Drive Scan Copy Function Copy Color Printing Color Dropout E-mail Function Fax Function FTP Function Release Held Faxes Held Jobs Access Use Profiles Cancel Jobs at the Device Change Language Internet Printing Protocol (IPP) Initiate Scans Remotely B/W Print Color Print Network Folder - Print Network Folder - Color Print Network Folder - Scan Hard Disk - Print Hard Disk - Color Print Hard Disk - Scan 	<p>Control access to the printer functions.</p> <p>Note: Some menu items appear only when a hard disk is installed.</p>

Menu item	Description
Administrative Menus Security Menu Network/Ports Menu Paper Menu Reports Menu Function Configuration Menus Supplies Menu Option Card Menu SE Menu Device Menu	Control access to the printer menu settings.
Device Management Remote Management Firmware Updates Apps Configuration Operator Panel Lock Import / Export All Settings Out of Service Erase	Control access to the printer management options.
Apps New Apps Card Copy Scan Center Scan Center Custom [x] Forms and Favorites	Control access to printer applications.

Local Accounts

Menu item	Description
Manage Groups/Permissions	Show a list of all saved groups in the printer.
Add User User Name/Password User Name Password PIN	Create local accounts and specify their access to the printer functions, administrative menus, printer management options, and applications.

Schedule USB Devices

Menu item	Description
Schedules Add New Schedule	Schedule access to the front USB port.

Security Audit Log

Menu item	Description
Enable Audit Off* On	Record the events in the secure audit log and remote syslog.
Enable Remote Syslog Off* On	Send audit logs to a remote server.
Remote Syslog Server	Specify the remote syslog server.
Remote Syslog Port 1–65535 (514*)	Specify the remote syslog port.
Remote Syslog Method Normal UDP* Stunnel	Specify a syslog method to transmit logged events to a remote server.
Remote Syslog Facility 0 - Kernel Messages 1 - User-Level Messages 2 - Mail System 3 - System Daemons 4 - Security/Authorization Messages* 5 - Messages Generated Internally by Syslogs 6 - Line Printer Subsystem 7 - Network News Subsystem 8 - UUCP Subsystem 9 - Clock Daemon 10 - Security/Authorization Messages 11 - FTP Daemon 12 - NTP Subsystem 13 - Log Audit 14 - Log Alert 15 - Clock Daemon 16 - Local Use 0 (local0) 17 - Local Use 1 (local1) 18 - Local Use 2 (local2) 19 - Local Use 3 (local3) 20 - Local Use 4 (local4) 21 - Local Use 5 (local5) 22 - Local Use 6 (local6) 23 - Local Use 7 (local7)	Specify a facility code that the printer uses when sending log events to a remote server.
Note: An asterisk (*) next to a value indicates the factory default setting.	

Menu item	Description
Severity of Events to Log 0 - Emergency 1 - Alert 2 - Critical 3 - Error 4 - Warning* 5 - Notice 6 - Informational 7 - Debug	Specify the priority level cutoff for logging messages and events.
Remote Syslog Non-Logged Events Off* On	Send all events, regardless of severity level, to the remote server.
Admin's E-mail Address	Send e-mail notification of logged events to the administrator.
E-mail Log Cleared Alert Off* On	Send e-mail notification to the administrator when a log entry is deleted.
E-mail Log Wrapped Alert Off* On	Send e-mail notification to the administrator when the log becomes full and begins to overwrite the oldest entries.
Log Full Behavior Wrap Over Older Entries* E-mail Log Then Delete All Entries	Resolve log storage issues when the log fills its allotted memory.
E-mail % Full Alert Off* On	Send e-mail notification to the administrator when the log fills its allotted memory.
% Full Alert Level 1–99 (90*)	
E-mail Log Exported Alert Off* On	Send e-mail notification to the administrator when a log is exported.
E-mail Log Settings Changed Alert Off* On	Send e-mail notification to the administrator when Enable Audit is set.
Log Line Endings LF (\n)* CR (\r) CRLF (\r\n)	Specify how the log file terminates the end of each line.
Note: An asterisk (*) next to a value indicates the factory default setting.	

Menu item	Description
Digitally Sign Exports Off* On	Add a digital signature to each exported log file.
Clear Log	Delete all audit logs.
Export Log Syslog (RFC 5424) Syslog (RFC 3164) CSV	Export a security log to a flash drive.
Note: An asterisk (*) next to a value indicates the factory default setting.	

Login Restrictions

Menu item	Description
Login failures 1–10 (3*)	Specify the number of failed login attempts before the user gets locked out.
Failure time frame 1–60 minutes (5*)	Specify the time frame between failed login attempts before the user gets locked out.
Lockout time 1–60 minutes (5*)	Specify the lockout duration.
Web Login Timeout 1–120 minutes (10*)	Specify the delay for a remote login before the user is logged off automatically.
Note: An asterisk (*) next to a value indicates the factory default setting.	

Confidential Print Setup

Menu item	Description
Max Invalid PIN 2–10	Set the number of times an invalid PIN can be entered. Notes: <ul style="list-style-type: none"> • A value of zero turns off this setting. • When the limit is reached, the print jobs for that user name and PIN are deleted.
Confidential Job Expiration Off* 1 Hour 4 Hours 24 Hours 1 Week	Set the expiration time for confidential print jobs. Notes: <ul style="list-style-type: none"> • If this menu item is changed while confidential print jobs reside in the printer memory or hard disk, then the expiration time for those print jobs does not change to the new default value. • If the printer is turned off, then all confidential jobs held in the printer memory are deleted.
Note: An asterisk (*) next to a value indicates the factory default setting.	

Menu item	Description
Repeat Job Expiration Off* 1 Hour 4 Hours 24 Hours 1 Week	Set the expiration time for a print job that you want to repeat.
Verify Job Expiration Off* 1 Hour 4 Hours 24 Hours 1 Week	Set the expiration time that the printer prints a copy for the user to examine its quality, before printing the remaining copies.
Reserve Job Expiration Off* 1 Hour 4 Hours 24 Hours 1 Week	Set the expiration time that the printer stores print jobs for printing later.
Require All Jobs to be Held Off* On	Set the printer to hold all print jobs.
Keep duplicate documents Off* On	Set the printer to print other documents with the same file name without overwriting any of the print jobs.
Note: An asterisk (*) next to a value indicates the factory default setting.	

Disk Encryption

Note: This menu appears only when a hard disk is installed.

Menu item	Description
Status Enabled Disabled	Enable disk encryption.
Start encryption	

Erase Temporary Data Files

Menu item	Description
Stored in onboard memory Off* On	Delete all files stored on the printer memory.
Stored on hard disk 1 Pass Erase* 3 Pass Erase 7 Pass Erase	Delete all files stored on the printer hard disk. Note: This menu item appears only when a printer hard disk is installed.
Note: An asterisk (*) next to a value indicates the factory default setting.	

Solutions LDAP Settings

Menu item	Description
Follow LDAP Referrals Off* On	Search the different servers in the domain for the logged-in user account.
LDAP Certificate Verification Yes No*	Enable verification of LDAP certificates.

Miscellaneous

Menu item	Description
Protected Features Show* Hide	Show all the features that Function Access Control (FAC) protects regardless of the security permission that the user has. Note: Hide displays only FAC-protected features that the user has access.
Print Permission Off* On	Let the user log in before printing.
Default Print Permission Login User Name/Password* User Name	Set the default login for Print Permission.
Security Reset Jumper Enable "Guest" access* No Effect	Specify user access to the printer. Notes: <ul style="list-style-type: none"> • The jumper is located beside a lock icon on the controller board. • Enable "Guest" access provides anyone access to all aspects of the printer. • No Effect may make access to the printer impossible when the required security information is unavailable.
Note: An asterisk (*) next to a value indicates the factory default setting.	

Menu item	Description
Minimum Password Length 0–32	Specify the password length.
Note: An asterisk (*) next to a value indicates the factory default setting.	

Reports

Menu Settings Page

Menu item	Description
Menu Settings Page	Print a report that contains the printer menus.

Device

Menu item	Description
Device Information	Print a report that contains information about the printer.
Device Statistics	Print a report about printer usage and supply status.
Profile List	Print a list of profiles that are stored in the printer.
Asset Report	Print a report that contains the printer serial number and model name.

Print

Menu item	Description
Print Fonts PCL Fonts PS Fonts	Print samples and information about the fonts that are available in each printer language.
Print Directory	Print the resources that are stored in the flash drive or hard disk. Note: This menu item appears only when a flash drive or hard disk is installed.

Shortcuts

Menu item	Description
All Shortcuts	Print a report that lists the shortcuts that are stored in the printer.
Fax Shortcuts	
Copy Shortcuts	
E-mail Shortcuts	
FTP Shortcuts	
Network Folder Shortcuts	

Fax

Menu item	Description
Fax Job Log	Print a report about the last 200 completed fax jobs. Note: This menu item appears only when Enable Job Log is set to On.
Fax Call Log	Print a report about the last 100 attempted, received, and blocked calls. Note: This menu item appears only when Enable Job Log is set to On.

Network

Menu item	Description
Network Setup Page	Print a page that shows the configured network and wireless settings on the printer. Note: This menu item appears only in network printers or printers connected to print servers.
Wi-Fi Direct Connected Clients	Print a page that shows the list of devices that are connected to the printer using Wi-Fi Direct. Note: This menu item appears only when Enable Wi-Fi Direct is set to On.

Help

Menu item	Description
Print All Guides	Prints all the guides
Color Quality Guide	Provides information about solving color quality issues
Connection Guide	Provides information about connecting the printer locally (USB) or to a network
Copy Guide	Provides information about making a copy and configuring the settings
E-mail Guide	Provides information about sending an e-mail and configuring the settings
Fax Guide	Provides information about sending a fax and configuring the settings
Information Guide	Provides information about the printer
Media Guide	Provides information about loading paper and specialty media
Moving Guide	Provides information about moving, locating, or shipping the printer
Print Quality Guide	Provides information about solving print quality issues
Scan Guide	Provides information about scanning a document and configuring the settings
Supplies Guide	Provides information about ordering supplies

Troubleshooting

Troubleshooting

Menu item	Description
Print Quality Test Pages	Print sample pages to identify and correct print quality defects.
Cleaning the Scanner	Print instructions on how to clean the scanner.

Securing the printer

Locating the security slot

The printer is equipped with a security lock feature. Attach a security lock compatible with most laptop computers in the location shown to secure the printer in place.

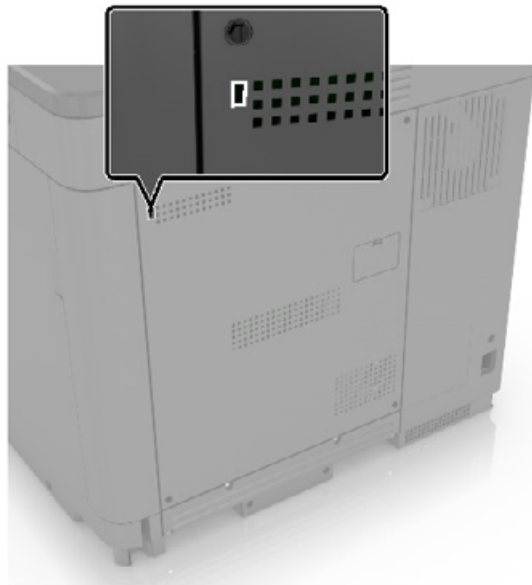

Erasing printer memory

To erase volatile memory or buffered data in your printer, turn off the printer.

To erase nonvolatile memory or individual settings, device and network settings, security settings, and embedded solutions, do the following:

- 1 From the home screen, touch **Settings > Device > Maintenance > Out of Service Erase**.
- 2 Select the **Sanitize all information on nonvolatile memory** check box, and then touch **ERASE**.
- 3 Select **Start initial setup wizard** or **Leave printer offline**, and then touch **Next**.
- 4 Start the operation.

Erasing printer hard disk memory

- 1 From the home screen, touch **Settings > Device > Maintenance > Out of Service Erase**.
- 2 Select the **Sanitize all information on hard disk** check box, and then touch **ERASE**.
- 3 Select a method to erase data.
- 4 Start the operation.

Note: This process can take from several minutes to more than an hour, making the printer unavailable for other tasks.

Encrypting the printer hard disk

This process erases all contents in the hard disk. If necessary, back up important data from the printer before starting the encryption.

- 1 From the home screen, touch **Settings > Security > Disk Encryption > Start encryption.**
- 2 Follow the instructions on the display.

Notes:

- To avoid loss of data, do not turn off the printer during the encryption process.
- This process can take from several minutes to more than an hour, making the printer unavailable for other tasks.
- After encryption, the printer automatically restarts.

Restoring factory default settings

- 1 From the home screen, touch **Settings > Device > Restore Factory Defaults.**
- 2 Touch **Restore Settings >** select the settings that you want to restore **> RESTORE.**
- 3 Start the operation.

Statement of Volatility

Type of memory	Description
Volatile memory	The printer uses standard random access memory (RAM) to buffer temporarily user data during simple print and copy jobs.
Non-volatile memory	The printer may use two forms of non-volatile memory: EEPROM and NAND (flash memory). Both types are used to store the operating system, printer settings, network information, scanner and bookmark settings, and embedded solutions.
Hard disk memory	Some printers may have a hard disk drive installed. The printer hard disk is designed for printer-specific functionality. The hard disk lets the printer retain buffered user data from complex print jobs, form data, and font data.

Erase the content of any installed printer memory in the following circumstances:

- The printer is decommissioned.
- The printer hard disk is replaced.
- The printer is moved to a different department or location.
- The printer is serviced by someone from outside your organization.

- The printer is removed from your premises for service.
- The printer is sold to another organization.

Disposing of a printer hard disk

- **Degaussing**—Flushes the hard disk with a magnetic field that erases stored data
- **Crushing**—Physically compresses the hard disk to break component parts and render them unreadable
- **Milling**—Physically shreds the hard disk into small metal bits

Note: To guarantee that all data are completely erased, destroy physically each hard disk where data is stored.

Maintaining the printer

Warning—Potential Damage: Failure to maintain optimum printer performance, or to replace parts and supplies, may cause damage to your printer.

Adjusting the speaker volume

Adjusting the default internal speaker volume

- 1 From the control panel, navigate to:
Settings > Device > Preferences > Audio Feedback
- 2 Adjust the volume.

Notes:

- If Quiet Mode is enabled, then audible alerts are turned off. This setting also slows the printer performance.
- The volume resets to the default value after the session is logged out or when the printer wakes from Sleep or Hibernate mode.

Configuring the fax speaker settings

- 1 From the home screen, touch **Settings > Fax > Fax Setup > Speaker Settings**.
- 2 Do the following:
 - Set the Speaker Mode to **Always On**.
 - Set the Speaker Volume to **High**.
 - Activate the Ringer Volume.

Networking

Connecting the printer to a Wi-Fi network

Make sure that Active Adapter is set to Auto. From the home screen, touch **Settings > Network/Ports > Network Overview > Active Adapter**.

- 1 From the home screen, touch **Settings > Network/Ports > Wireless > Setup On Printer Panel > Choose Network**.
- 2 Select a Wi-Fi network, and then type the network password.

Note: For Wi-Fi-network-ready printer models, a prompt for Wi-Fi network setup appears during initial setup.

Connecting the printer to a wireless network using Wi-Fi Protected Setup (WPS)

Before you begin, make sure that:

- The access point (wireless router) is WPS-certified or WPS-compatible. For more information, see the documentation that came with your access point.
- A wireless network adapter is installed in your printer. For more information, see the instructions that came with the adapter.
- Active Adapter is set to Auto. From the home screen, touch **Settings** > **Network/Ports** > **Network Overview** > **Active Adapter**.

Using the Push Button method

- 1 From the home screen, touch **Settings** > **Network/Ports** > **Wireless** > **Wi-Fi Protected Setup** > **Start Push Button Method**.
- 2 Follow the instructions on the display.

Using the personal identification number (PIN) method

- 1 From the home screen, touch **Settings** > **Network/Ports** > **Wireless** > **Wi-Fi Protected Setup** > **Start PIN Method**.
- 2 Copy the eight-digit WPS PIN.
- 3 Open a web browser, and then type the IP address of your access point in the address field.

Notes:

- To know the IP address, see the documentation that came with your access point.
- If you are using a proxy server, then temporarily disable it to load the web page correctly.

- 4 Access the WPS settings. For more information, see the documentation that came with your access point.
- 5 Enter the eight-digit PIN, and then save the changes.

Configuring Wi-Fi Direct

- 1 From the home screen, touch **Settings** > **Network/Ports** > **Wi-Fi Direct**.
- 2 Configure the settings.
 - **Enable Wi-Fi Direct**—Enables the printer to broadcast its own Wi-Fi Direct network.
 - **Wi-Fi Direct Name**—Assigns a name for the Wi-Fi Direct network.
 - **Wi-Fi Direct Password**—Assigns the password for negotiating the wireless security when using the peer-to-peer connection.
 - **Show Password on Setup Page**—Enables the password to show on the Network Setup Page.
 - **Auto-Accept Push Button Requests**—Determines what is displayed on the home screen when clients connect using Wi-Fi Direct. For security purposes, this setting is disabled by default. When disabled, a prompt appears asking the user whether to allow the connection.

Note: Accepting push-button requests automatically is not secured.

Notes:

- By default, the Wi-Fi Direct network password is not visible on the printer display. To show the password, from the home screen touch **Settings > Security > Miscellaneous > Enable Password/PIN Reveal**.
- To know the password of the Wi-Fi Direct network without showing it on the printer display, from the home screen touch **Settings > Reports > Network > Network Setup Page**.

Connecting a mobile device to the printer

Before connecting your mobile device, make sure that Wi-Fi Direct has been configured. For more information, see [“Configuring Wi-Fi Direct” on page 142](#).

Connecting using Wi-Fi Direct

Note: These instructions apply only to Android mobile devices.

- 1 From the mobile device, go to the settings menu.
- 2 Enable **Wi-Fi**, and then tap **Wi-Fi Direct**.
- 3 Select the printer Wi-Fi Direct name.
- 4 Confirm the connection on the printer control panel.

Connecting using Wi-Fi

- 1 From the mobile device, go to the settings menu.
- 2 Tap **Wi-Fi**, and then select the printer Wi-Fi Direct name.

Note: The string DIRECT-xy (where x and y are two random characters) is added before the Wi-Fi Direct name.

- 3 Enter the Wi-Fi Direct password.

Connecting a computer to the printer

Before connecting your computer, make sure that Wi-Fi Direct has been configured. For more information, see [“Configuring Wi-Fi Direct” on page 142](#).

For Windows users

- 1 Open **Printers & scanners**, and then click **Add a printer or scanner**.
- 2 Click **Show Wi-Fi Direct printers**, and then select the printer Wi-Fi Direct name.
- 3 From the printer display, take note of the eight-digit PIN of the printer.
- 4 Enter the PIN on the computer.

Note: If the print driver is not already installed, then Windows downloads the appropriate driver.

For Macintosh users

- 1 Click the wireless icon, and then select the printer Wi-Fi Direct name.

Note: The string DIRECT-xy (where x and y are two random characters) is added before the Wi-Fi Direct name.

- 2 Type the Wi-Fi Direct password.

Note: Switch your computer back to its previous network after disconnecting from the Wi-Fi Direct network.

Deactivating the Wi-Fi network

- 1 From the home screen, touch **Settings > Network/Ports > Network Overview > Active Adapter > Standard Network**.
- 2 Follow the instructions on the display.

Changing the printer port settings after installing an internal solutions port

Notes:

- If the printer has a static IP address, then do not change the configuration.
- If the computers are configured to use the network name instead of an IP address, then do not change the configuration.
- If you are adding a wireless internal solutions port (ISP) to a printer previously configured for an Ethernet connection, then disconnect the printer from the Ethernet network.

For Windows users

- 1 Open the printers folder.
- 2 From the shortcut menu of the printer with the new ISP, open the printer properties.
- 3 Configure the port from the list.
- 4 Update the IP address.
- 5 Apply the changes.

For Macintosh users

- 1 From System Preferences in the Apple menu, navigate to the list of printers, and then select + > **IP**.
- 2 Type the IP address in the address field.
- 3 Apply the changes.

Cleaning printer parts

Cleaning the printer

⚠ CAUTION—SHOCK HAZARD: To avoid the risk of electrical shock when cleaning the exterior of the printer, unplug the power cord from the electrical outlet and disconnect all cables from the printer before proceeding.

Notes:

- Perform this task after every few months.
- Damage to the printer caused by improper handling is not covered by the printer warranty.

- 1 Turn off the printer, and then unplug the power cord from the electrical outlet.
- 2 Remove paper from the standard bin and multipurpose feeder.
- 3 Remove any dust, lint, and pieces of paper around the printer using a soft brush or vacuum.
- 4 Wipe the outside of the printer with a damp, soft, lint-free cloth.

Notes:

- Do not use household cleaners or detergents, as they may damage the finish of the printer.
- Make sure that all areas of the printer are dry after cleaning.

- 5 Connect the power cord to the electrical outlet, and then turn on the printer.

⚠ CAUTION—POTENTIAL INJURY: To avoid the risk of fire or electrical shock, connect the power cord to an appropriately rated and properly grounded electrical outlet that is near the product and easily accessible.

Cleaning the scanner

- 1 Open the scanner cover.



2 Using a damp, soft, lint-free cloth, wipe the following areas:

- ADF glass



- ADF glass pad

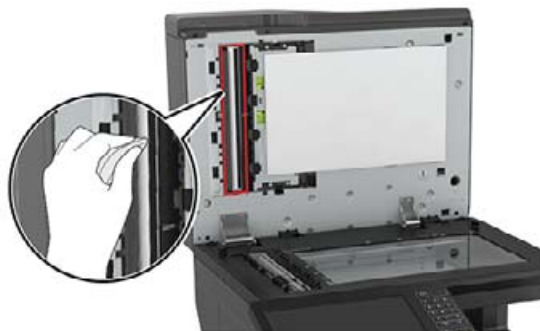

- Scanner glass



- Scanner glass pad



- 3 Close the scanner cover.

Ordering parts and supplies

Checking the status of parts and supplies

- 1 From the home screen, touch **Status/Supplies**.
- 2 Select the parts or supplies that you want to check.

Note: You can also access this setting by touching the top section of the home screen.

Ordering toner cartridges

Notes:

- The estimated cartridge yield is based on the ISO/IEC 19798 standard.
- Extremely low print coverage for extended periods of time may negatively affect actual yield and may cause cartridge parts to fail before toner exhaustion.

To order cartridges, contact the place where you purchased the printer.

Ordering a waste toner bottle

To order a waste toner bottle, contact the place where you purchased the printer.

Configuring supply notifications

- 1 Open a web browser, and then type the printer IP address in the address field.

Notes:

- View the printer IP address on the printer home screen. The IP address appears as four sets of numbers separated by periods, such as 123.123.123.123.

- If you are using a proxy server, then temporarily disable it to load the web page correctly.

- 2 Click **Settings** > **Device** > **Notifications**.
- 3 From the Supplies menu, click **Custom Supply Notifications**.
- 4 Select a notification for each supply item.
- 5 Apply the changes.

Replacing parts and supplies

Replacing a developer unit

- 1 Open door A.

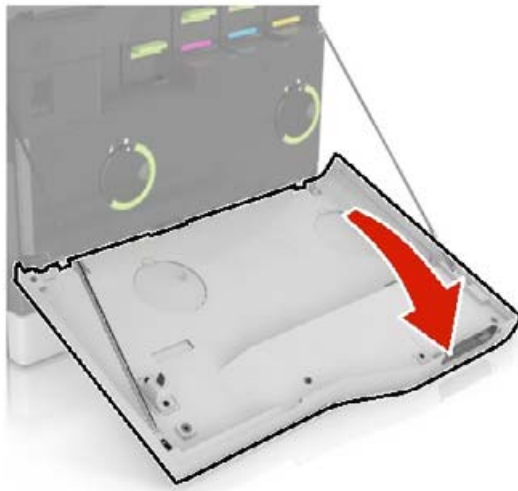

2 Remove the waste toner bottle.

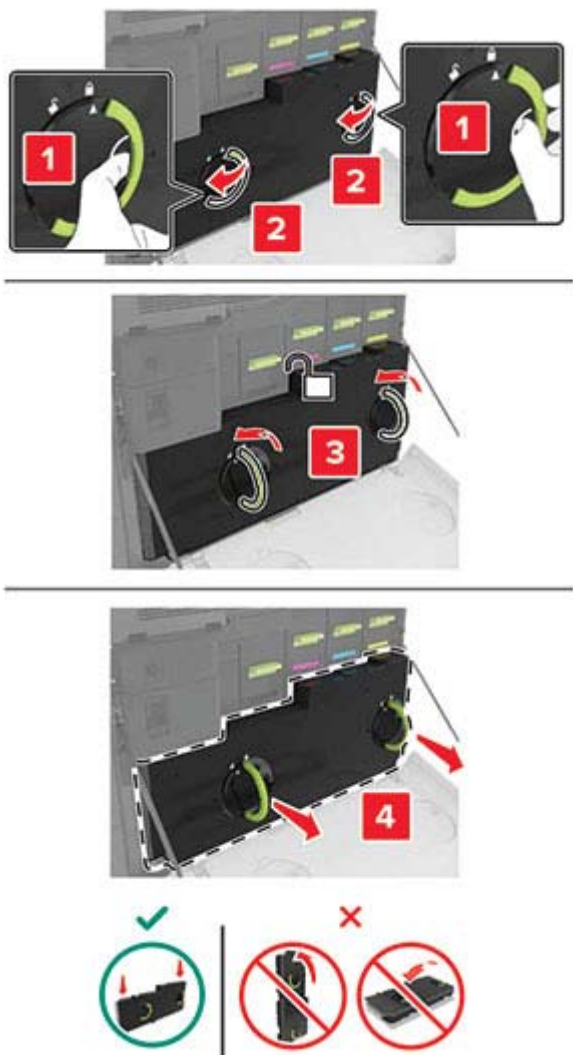

3 Remove the imaging unit.

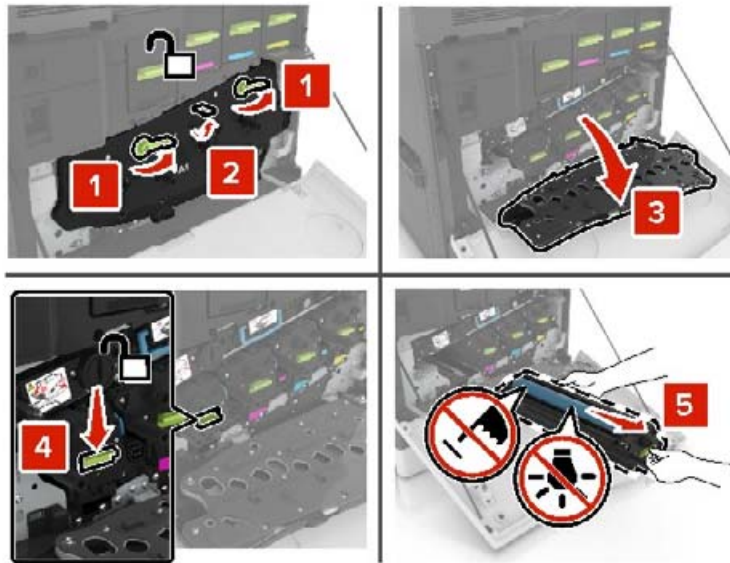

4 Remove the developer unit.

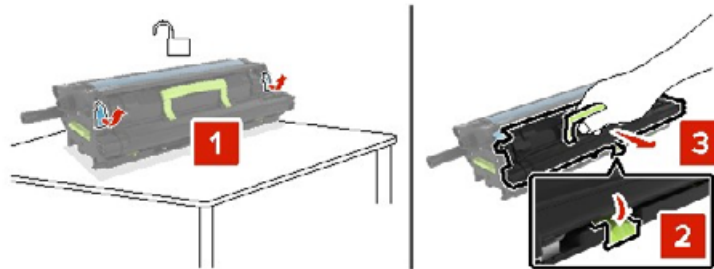

5 Unpack the new developer unit, and then remove the packing material.

6 Insert the new developer unit.

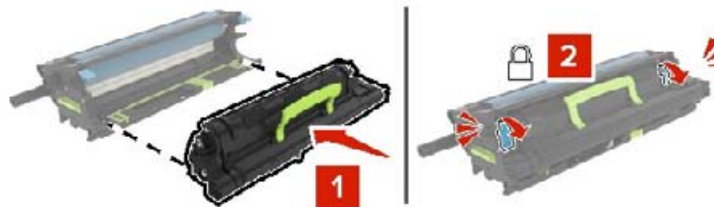

7 Insert the imaging unit.

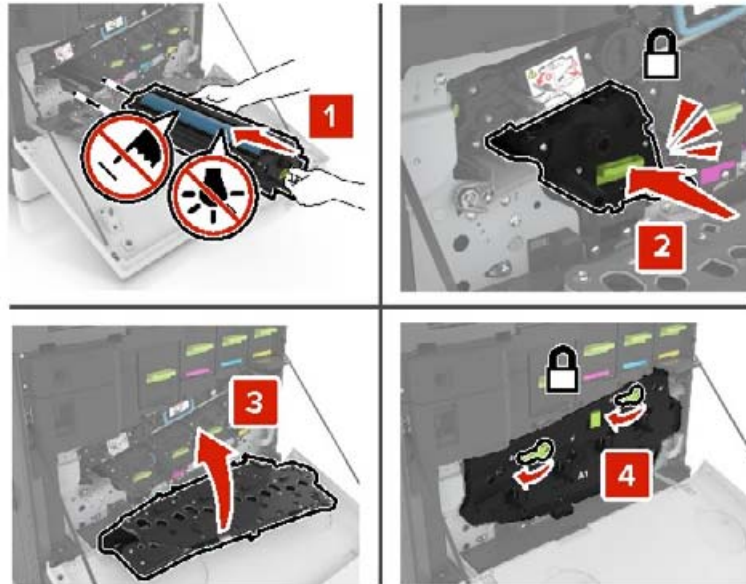

8 Insert the waste toner bottle.

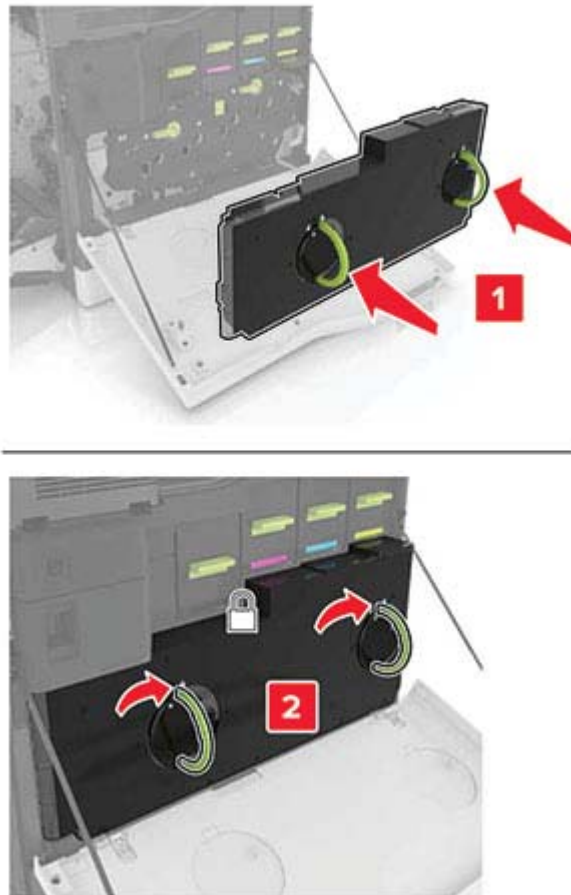

9 Close door A.

Replacing the fuser

1 Turn off the printer.

2 Open door B.

 **CAUTION—HOT SURFACE:** The inside of the printer might be hot. To reduce the risk of injury from a hot component, allow the surface to cool before touching it.

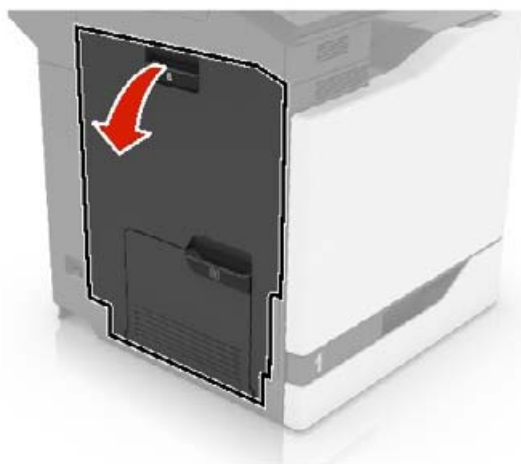

3 Remove the fuser.

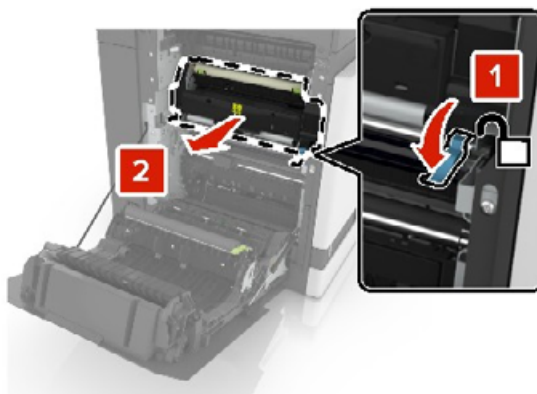

4 Unpack the new fuser.

5 Clean the fuser lens using the cotton swab that came with the package.

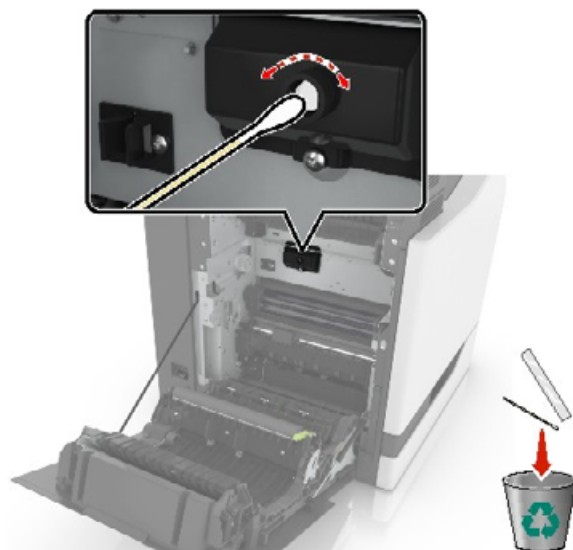

6 Insert the new fuser until it *clicks* into place.

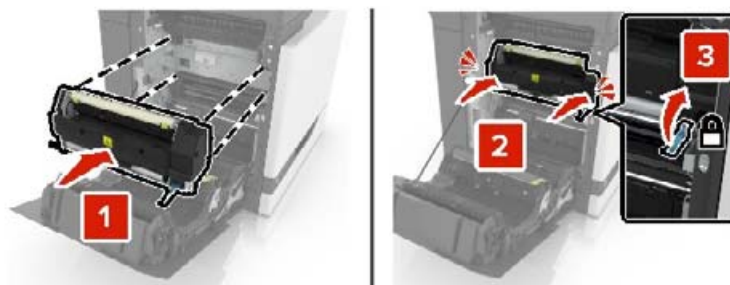

7 Close door B.

8 Turn on the printer.

Replacing a photoconductor unit

- 1 Open door A.

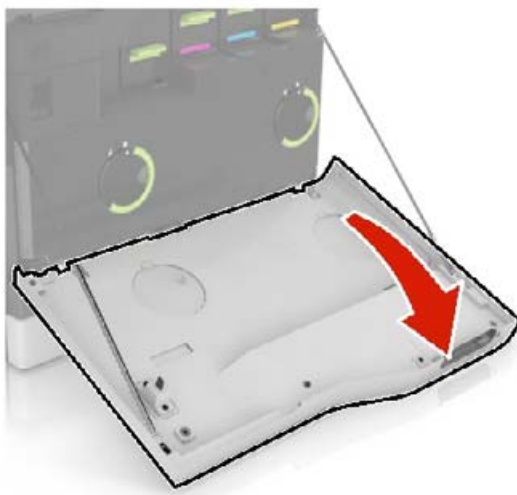

2 Remove the waste toner bottle.

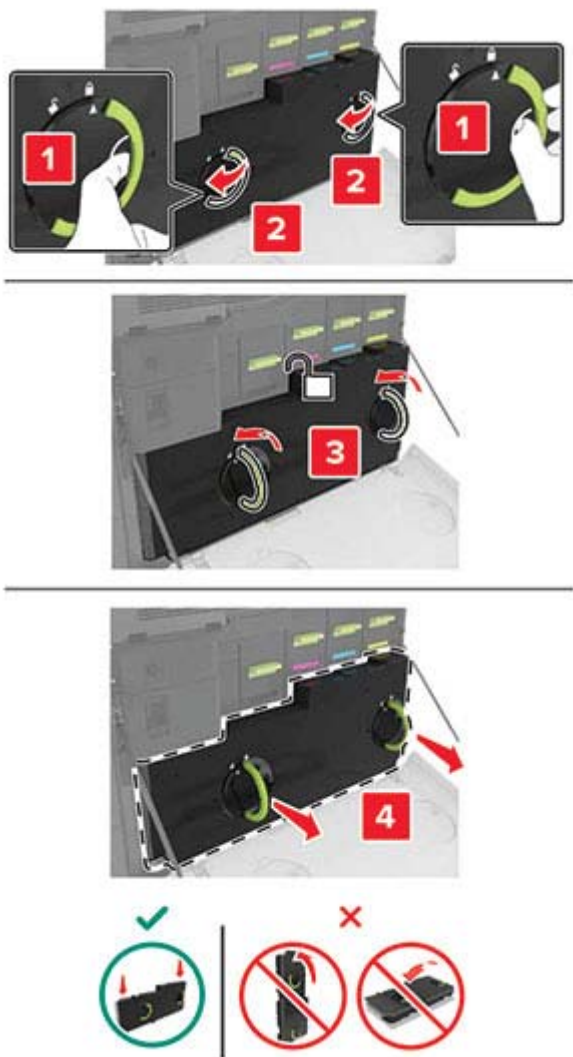

3 Remove the imaging unit.

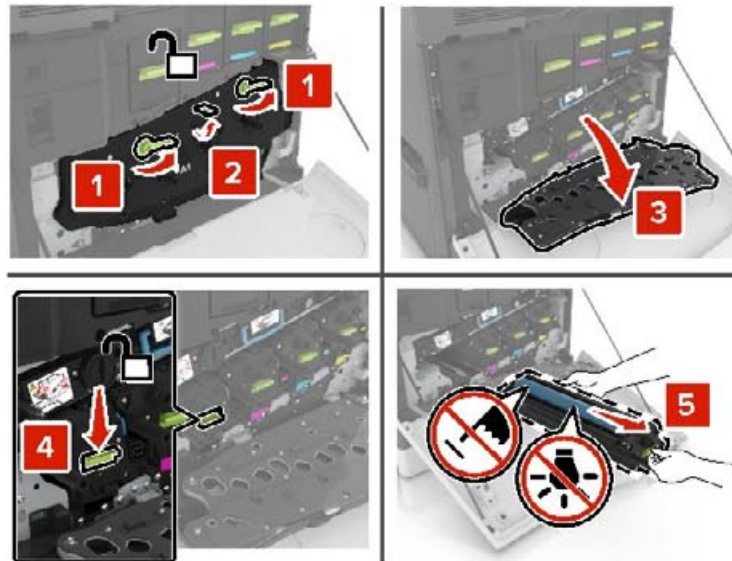

4 Remove the photoconductor unit.

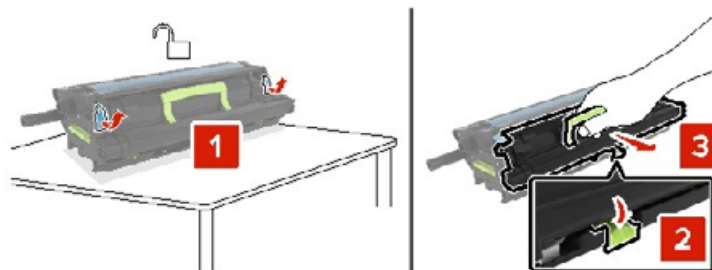

5 Unpack the new photoconductor unit, and then remove the packing material.

Warning—Potential Damage: Do not expose the photoconductor unit to direct light for more than 10 minutes. Extended exposure to light may cause print quality problems.

Warning—Potential Damage: Do not touch the photoconductor drum. Doing so may affect the print quality of future print jobs.

6 Insert the new photoconductor unit.

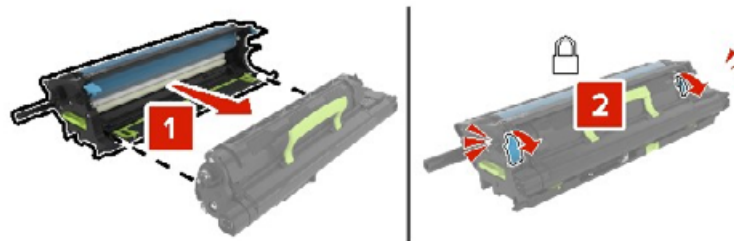

7 Insert the imaging unit.

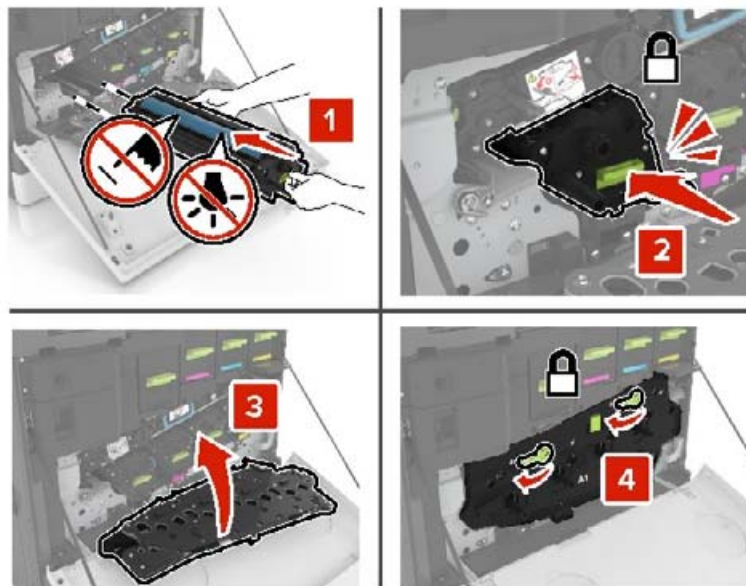

8 Insert the waste toner bottle.

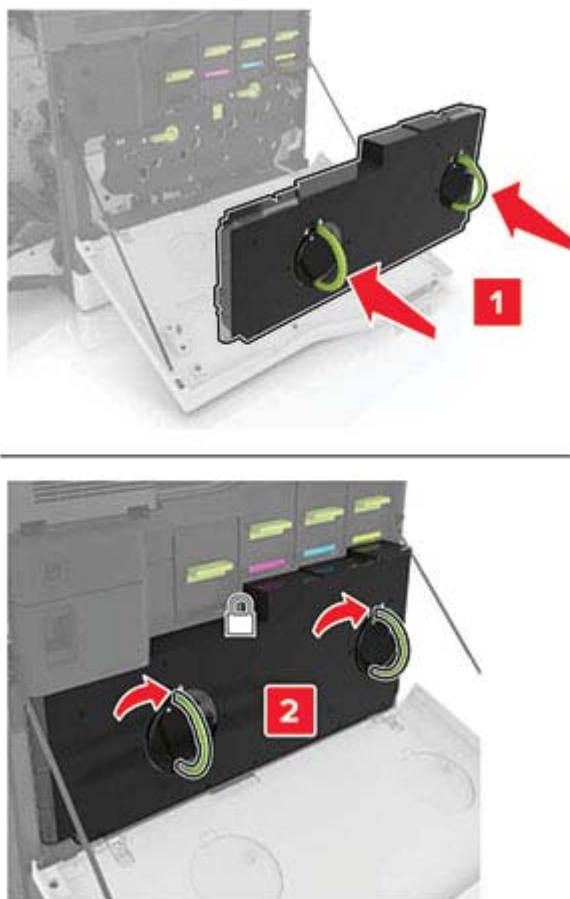

9 Close door A.

Replacing an imaging unit

- 1 Open door A.

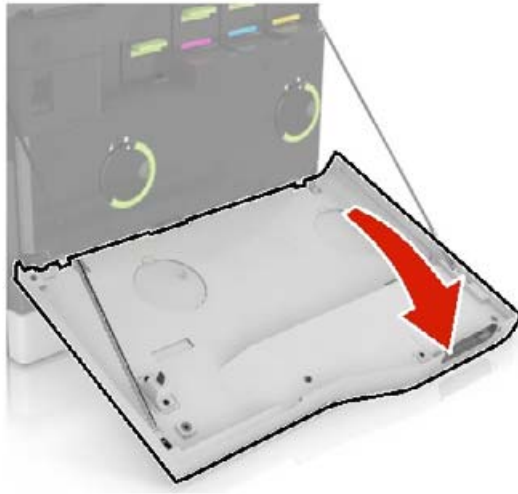

2 Remove the waste toner bottle.

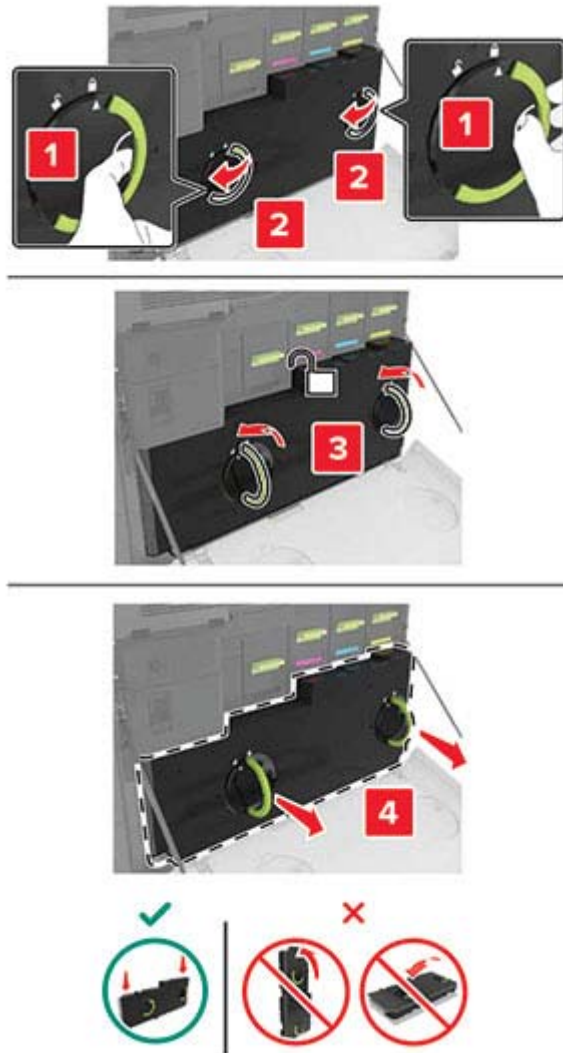

3 Remove the imaging unit.

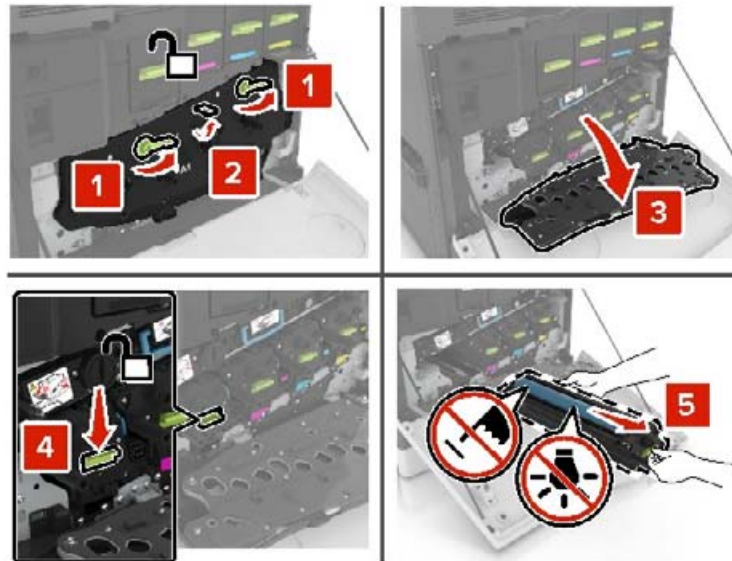

4 Unpack the new imaging unit, and then remove the packing material.

Warning—Potential Damage: Do not expose the photoconductor unit to direct light for more than 10 minutes. Extended exposure to light may cause print quality problems.

Warning—Potential Damage: Do not touch the photoconductor drum. Doing so may affect the print quality of future print jobs.

5 Insert the new imaging unit.

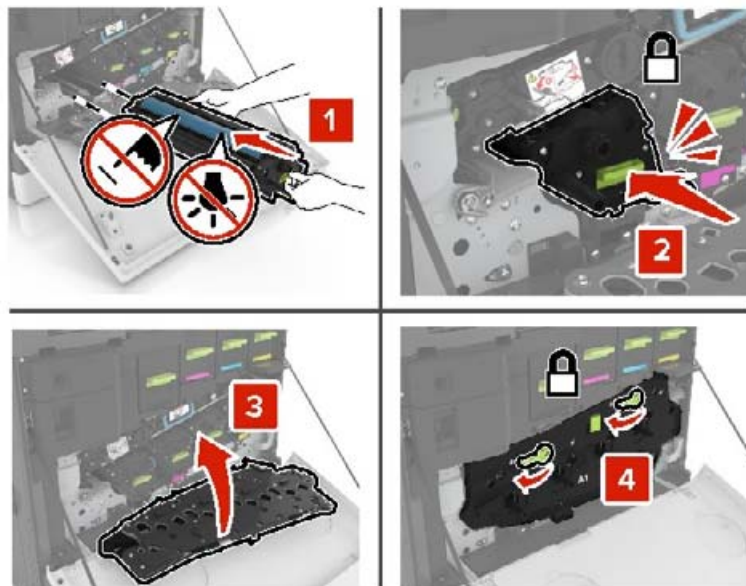

6 Insert the waste toner bottle.

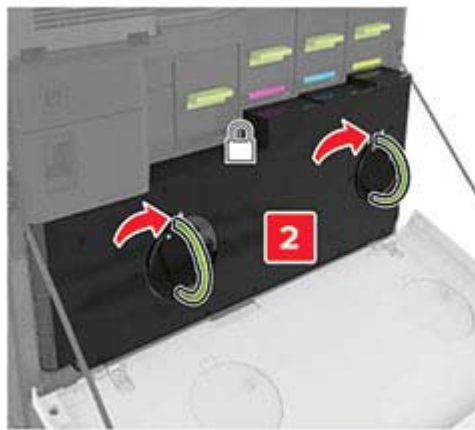
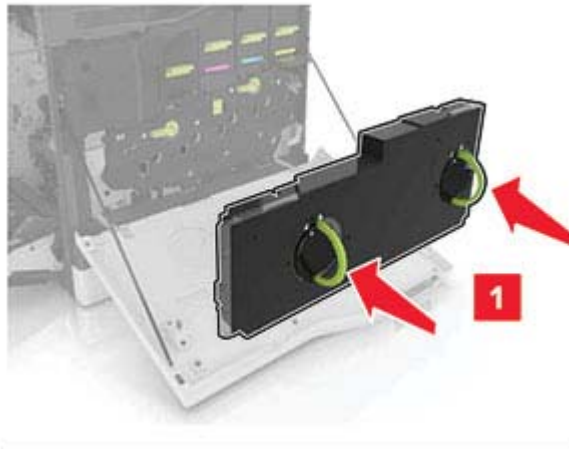

7 Close door A.

Replacing a toner cartridge

1 Open door A.

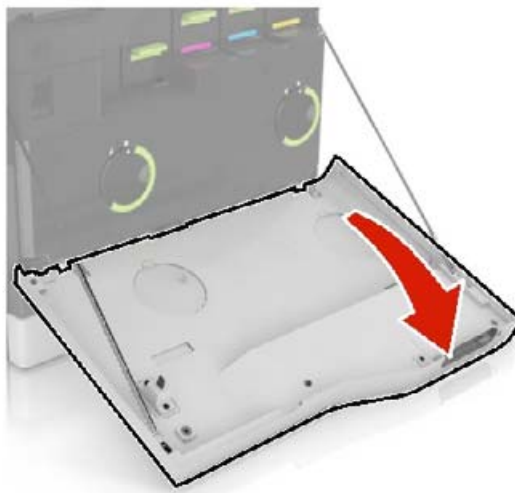

- 2 Remove the toner cartridge.

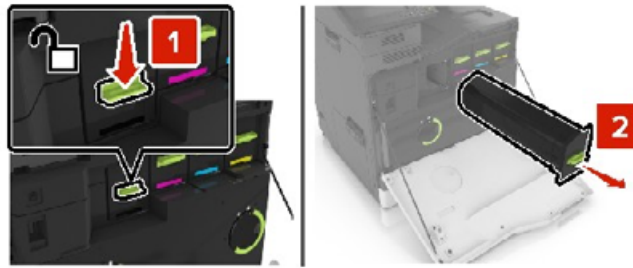

- 3 Unpack the new toner cartridge.

- 4 Insert the new toner cartridge until it *clicks* into place.

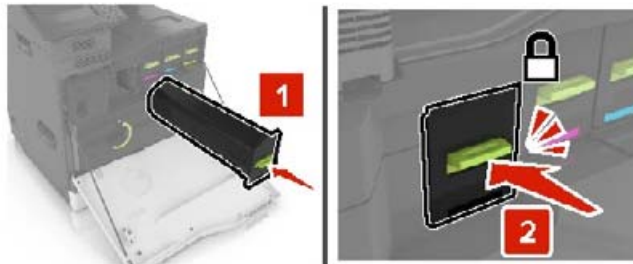

- 5 Close door A.

Replacing the pick roller

Replacing the pick roller in the 550-sheet tray or envelope tray

- 1 Turn off the printer.
- 2 Remove the tray.

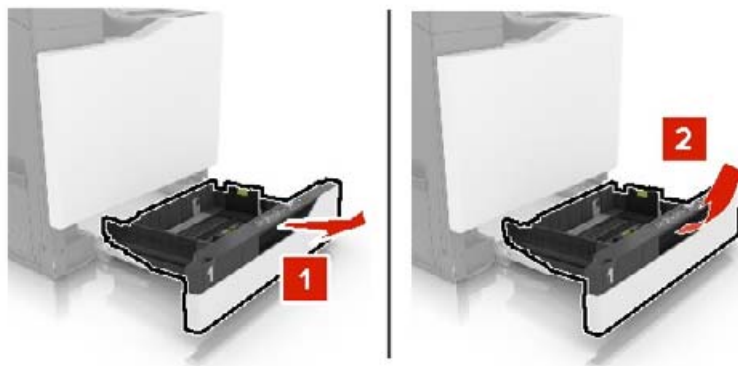

3 Remove the pick roller.

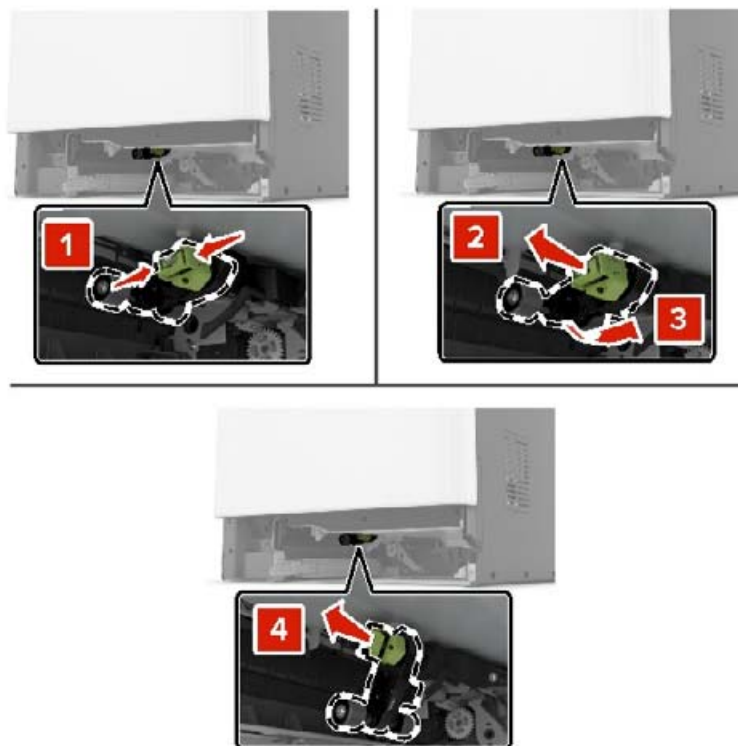

4 Unpack the new pick roller.

5 Insert the new pick roller until it *clicks* into place.

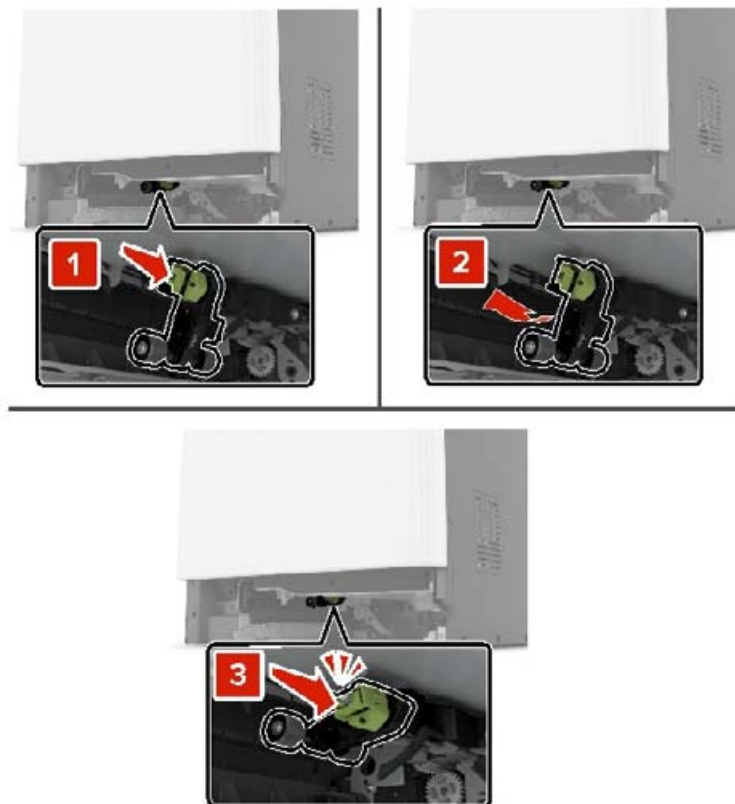

6 Insert the tray.



7 Turn on the printer.

Replacing the pick roller in the 2200-sheet tray

- 1 Turn off the printer.
- 2 Pull out, and then unlock the tray.

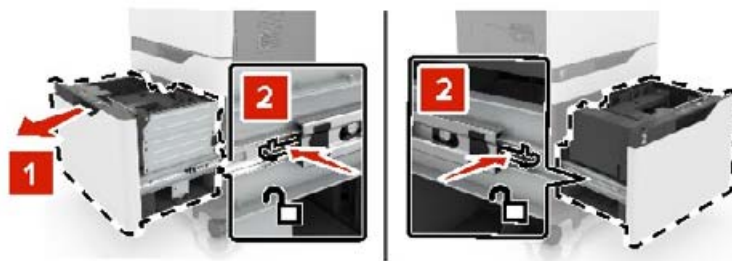

- 3 Remove the tray.
- 4 Remove the pick roller.

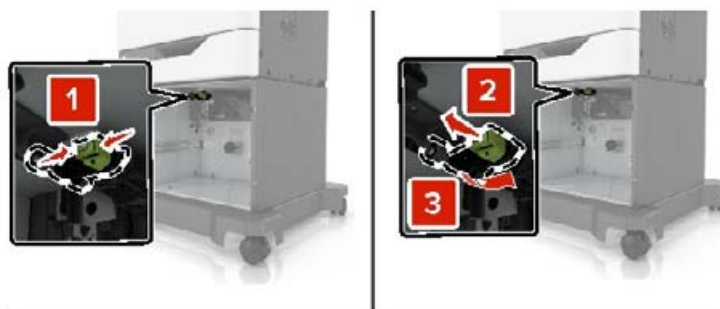

- 5 Unpack the new pick roller.

6 Insert the new pick roller until it *clicks* into place.

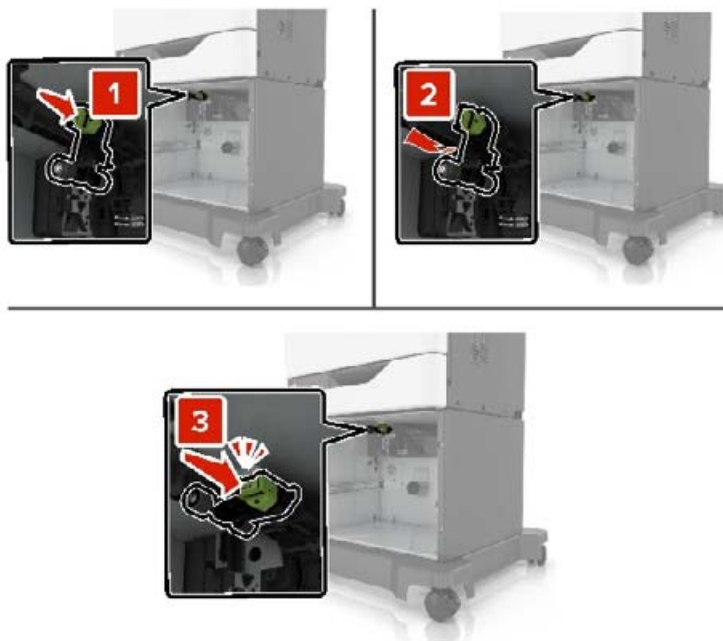

7 Insert the tray.

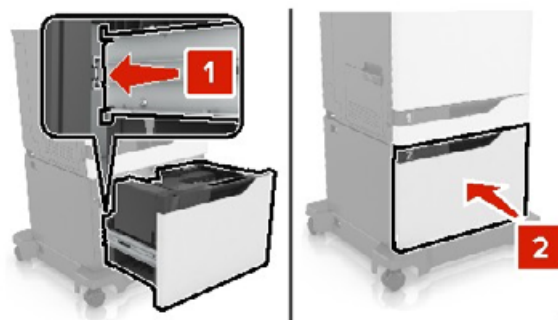

8 Turn on the printer.

Replacing the separator pad

- 1 Pull out the tray.

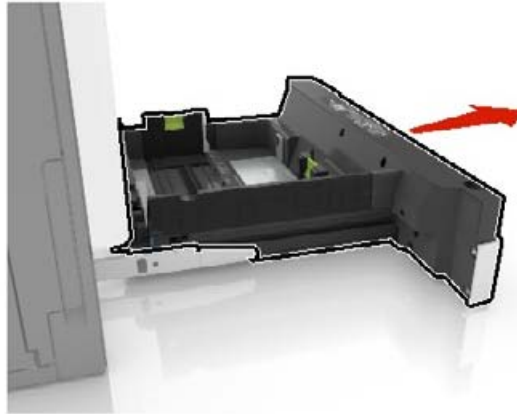

- 2 Remove the separator pad.

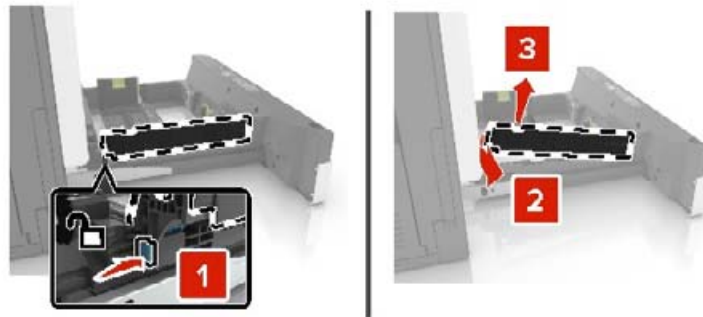

- 3 Unpack the new separator pad.

- 4 Insert the new separator pad until it *clicks* into place.

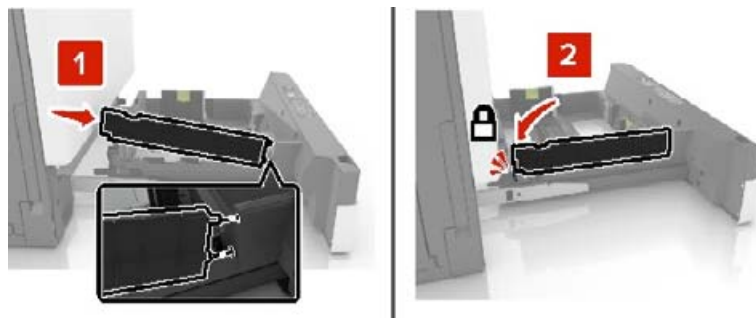

- 5 Insert the tray.

Replacing the waste toner bottle

- 1 Open door A.

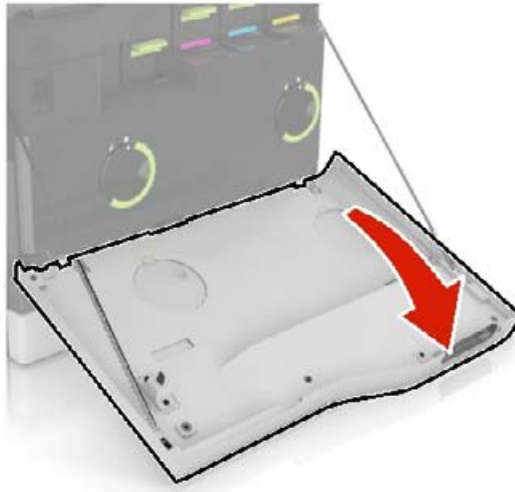

2 Remove the waste toner bottle.

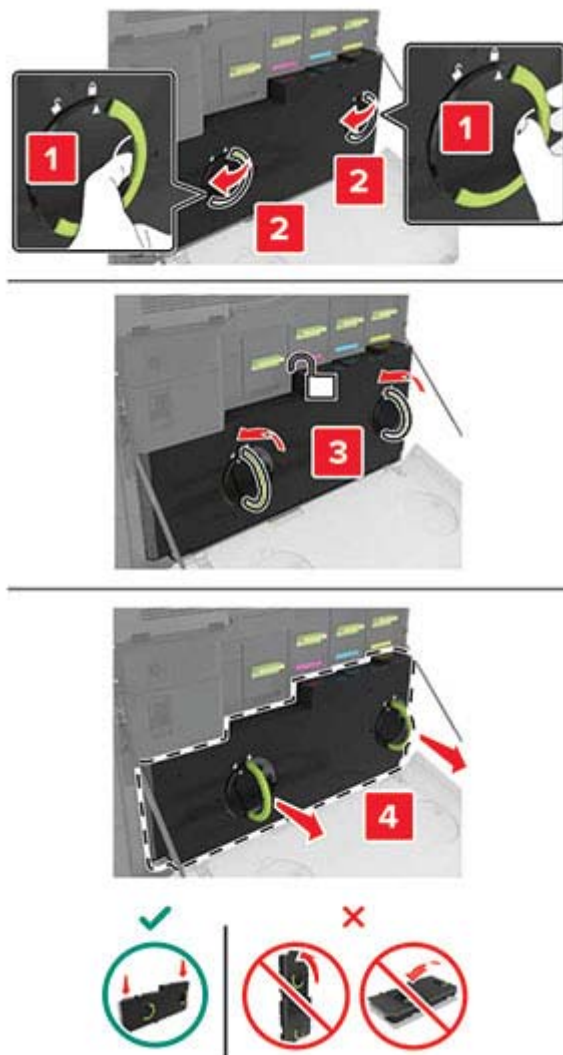

3 Unpack the new waste toner bottle.

4 Insert the new waste toner bottle.

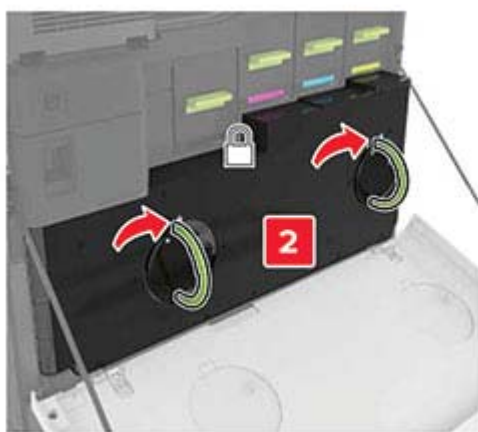
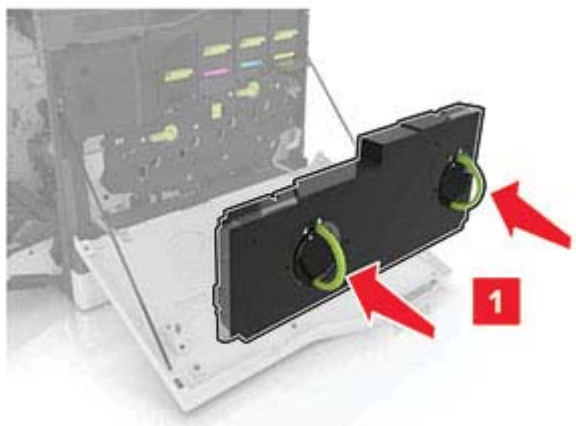

5 Close door A.

Replacing the transfer belt

- 1 Turn off the printer.
- 2 Open door A.

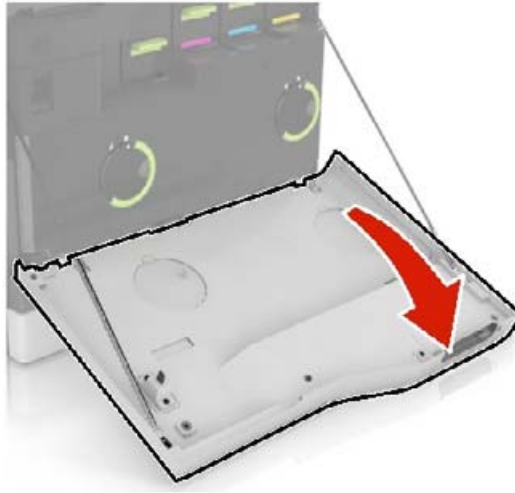

3 Remove the waste toner bottle.

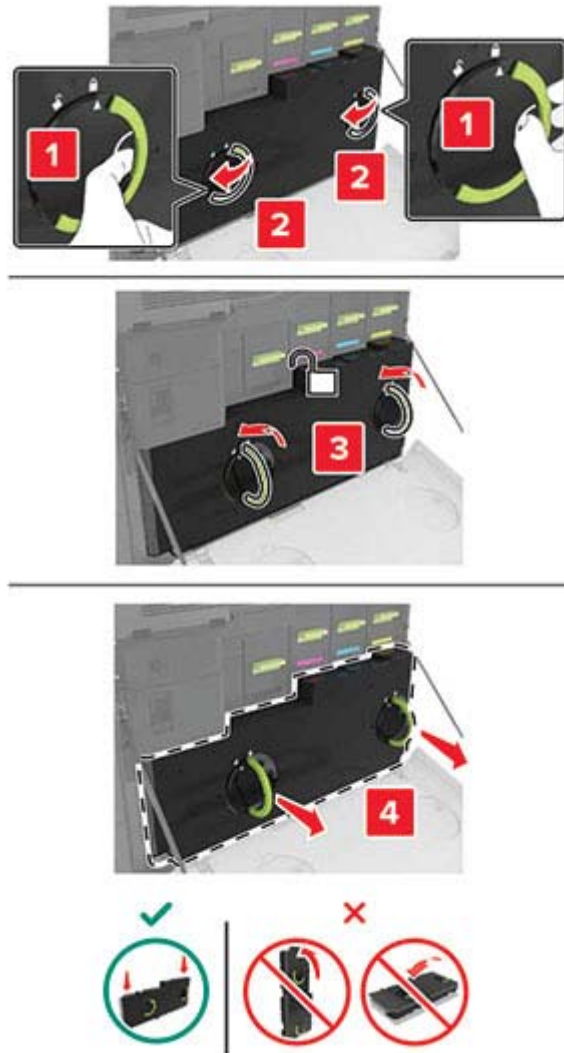

4 Open door A1.

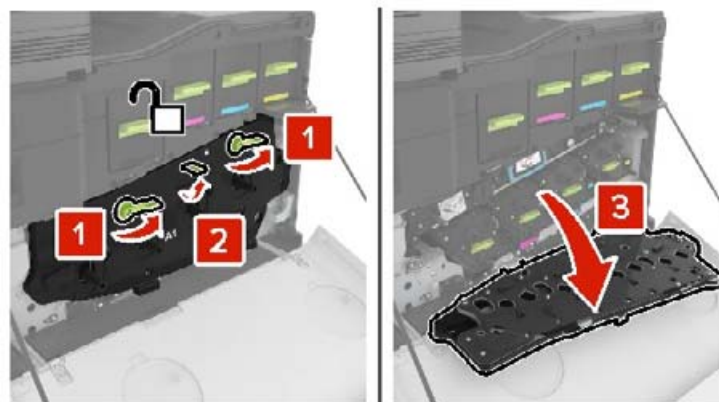

5 Remove the transfer belt.

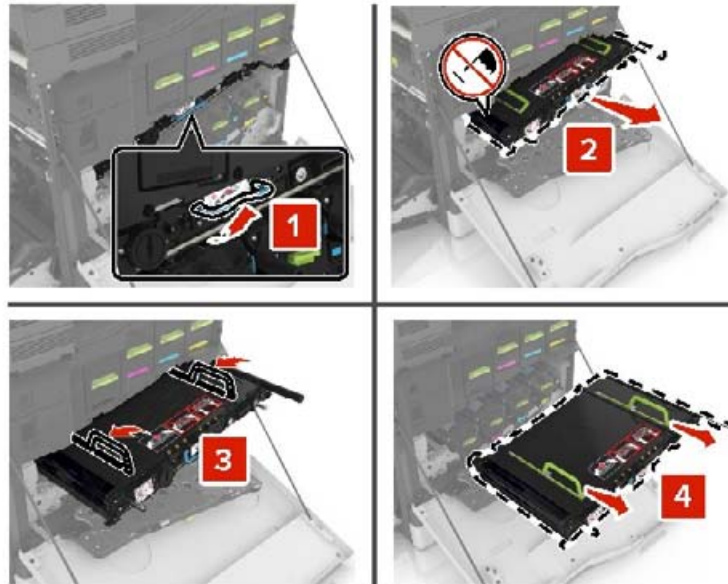

6 Unpack the new transfer belt, and then remove the packing material.

Warning—Potential Damage: Do not expose the transfer belt to direct light for more than 10 minutes. Extended exposure to light may cause print quality problems.

Warning—Potential Damage: Do not touch the transfer belt. Doing so may affect the print quality of future print jobs.



7 Insert the new transfer belt until it *clicks* into place.

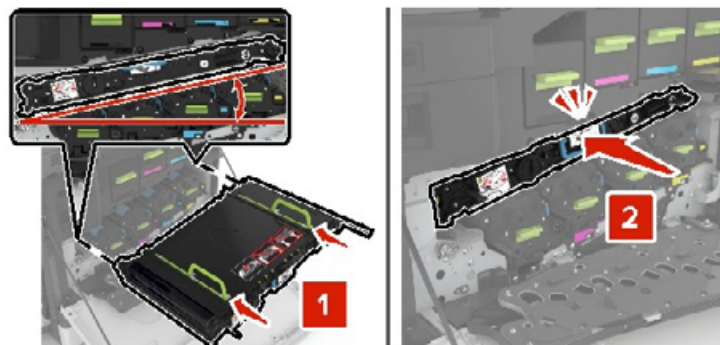

8 Close door A1.

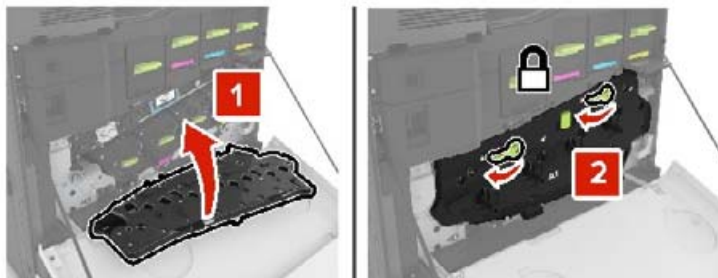

9 Insert the waste toner bottle.

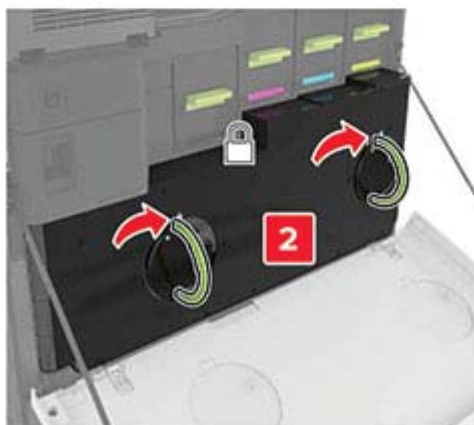
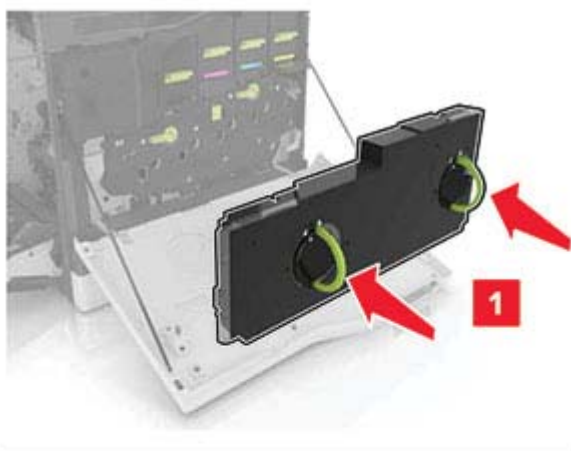

10 Close door A .

11 Turn on the printer.

Replacing the transfer roller

- 1 Open door B.

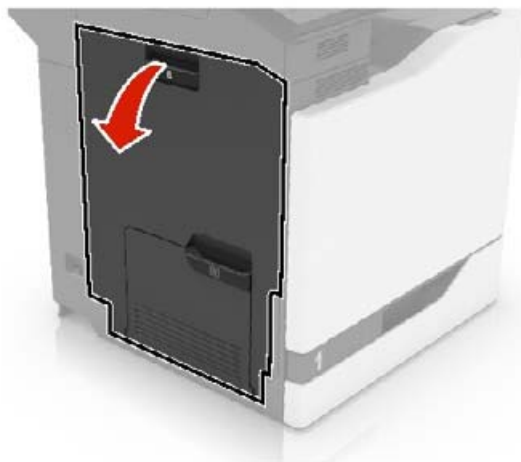

- 2 Remove the transfer roller.



- 3 Unpack the new transfer roller.

Note: Do not remove the white packing material.

4 Insert the new transfer roller.

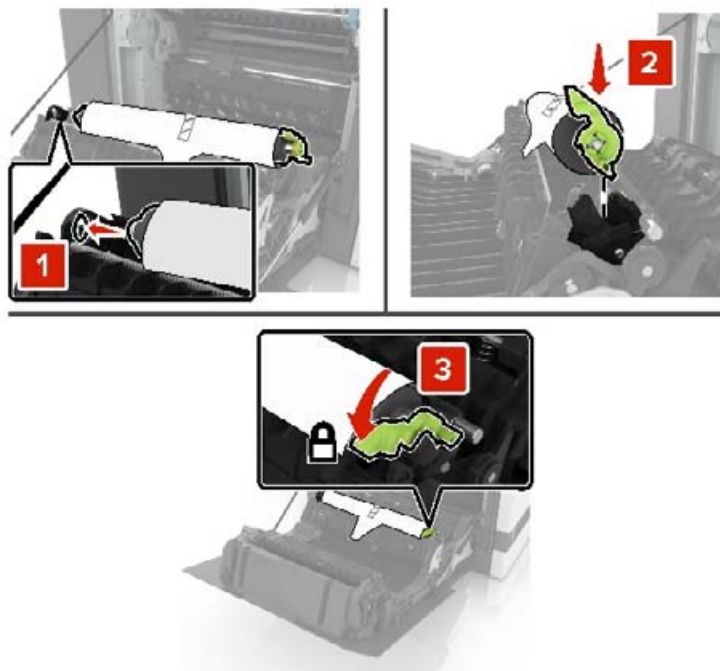

5 Remove the white packing material.



6 Close door B.

Replacing the ADF pick roller

- 1 Turn off the printer.
- 2 Open door D.

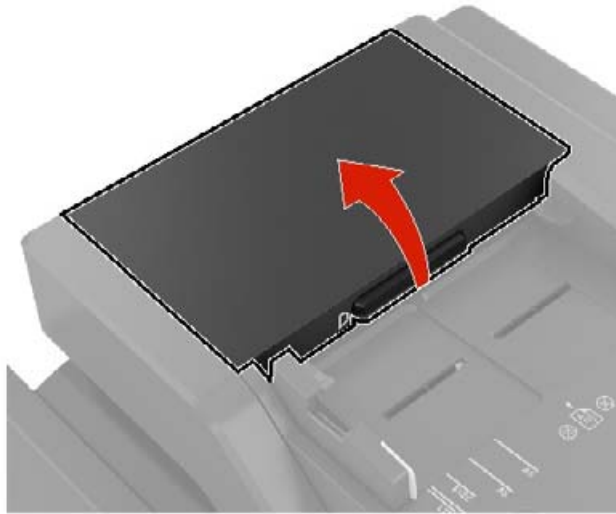

- 3 Remove the ADF pick roller cover.

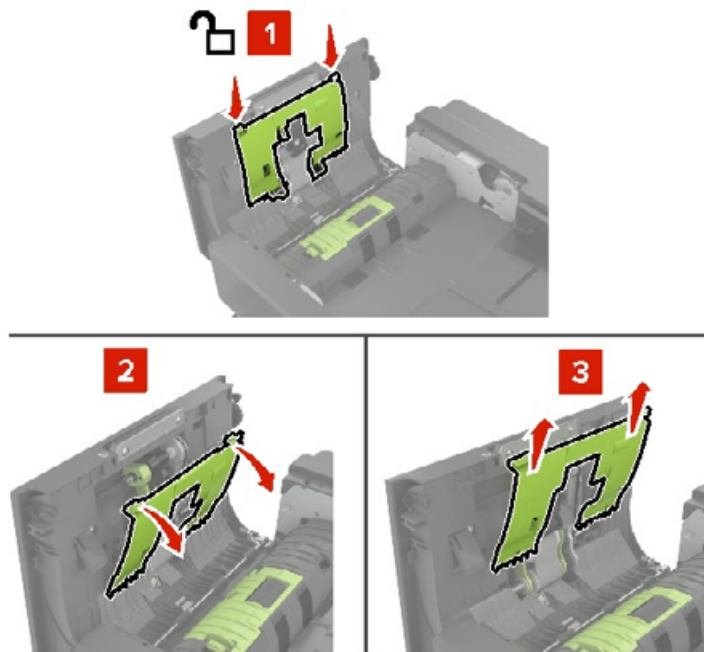

- 4 Remove the ADF pick roller.

Warning—Potential Damage: Some parts of the printer are easily damaged by static electricity. Before touching any parts or components in an area marked with the static-sensitive symbol, touch a metal surface in an area away from the symbol.

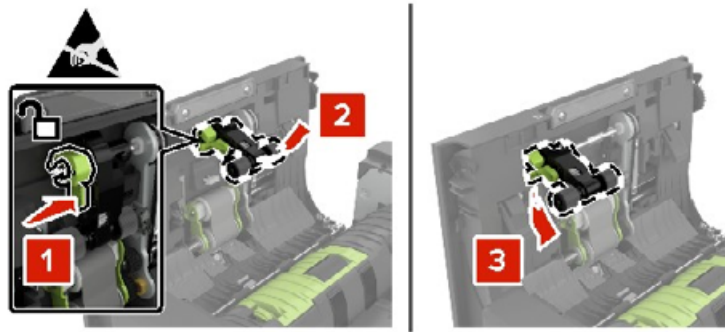

- 5 Unpack the new ADF pick roller.
- 6 Insert the new ADF pick roller until it *clicks* into place.

Warning—Potential Damage: Some parts of the printer are easily damaged by static electricity. Before touching any parts or components in an area marked with the static-sensitive symbol, touch a metal surface in an area away from the symbol.

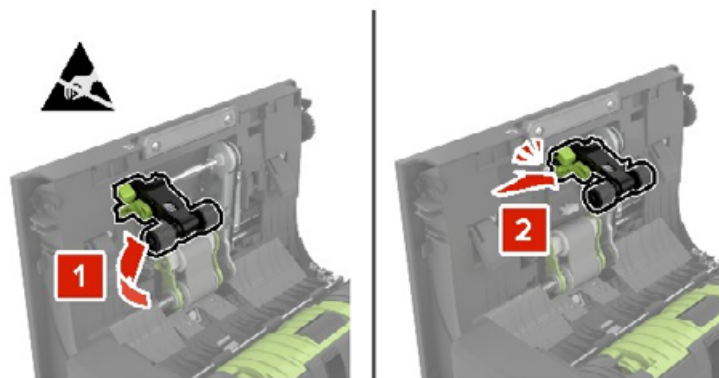

- 7 Insert the ADF pick roller cover until it *clicks* into place.

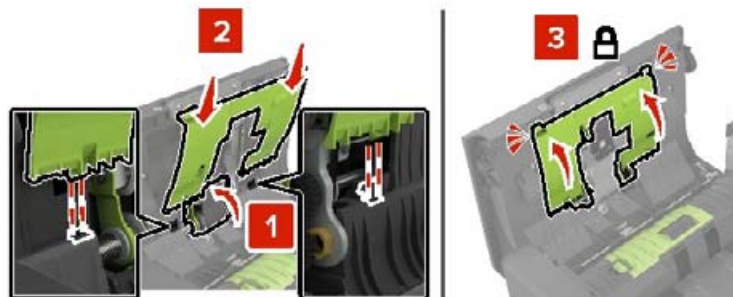

- 8 Close door D.
- 9 Turn on the printer.

Replacing the ADF feed roller

- 1 Turn off the printer.
- 2 Open door D.

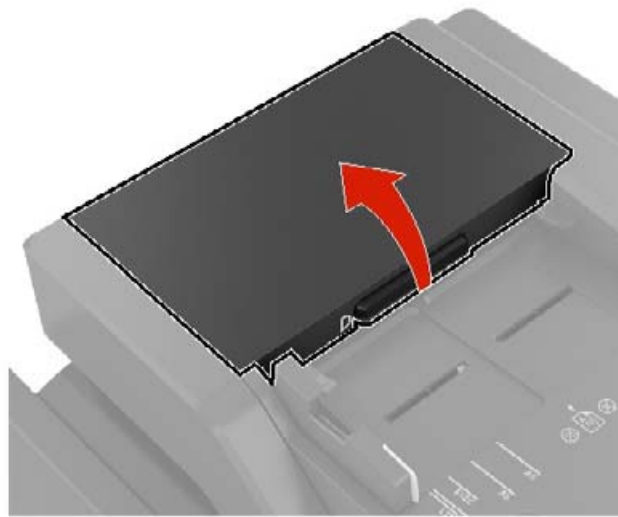

- 3 Remove the ADF pick roller cover.

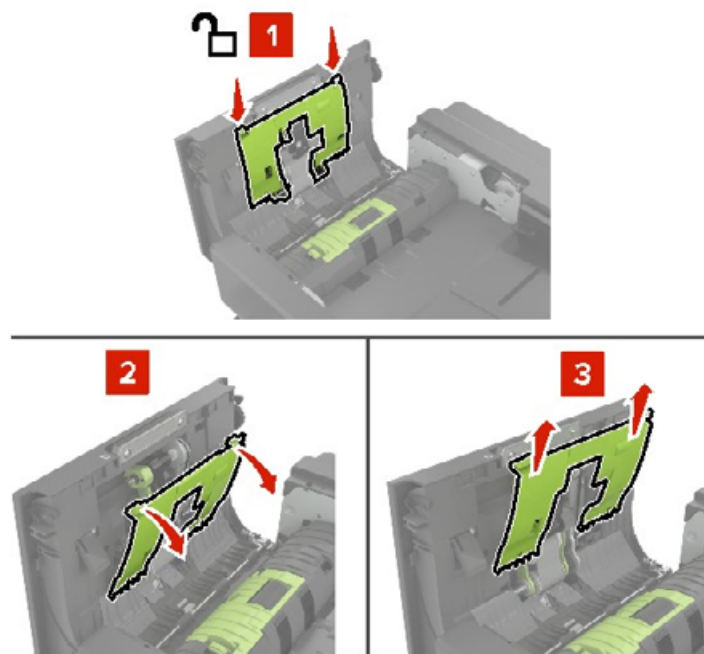

- 4 Remove the ADF feed roller.

Warning—Potential Damage: Some parts of the printer are easily damaged by static electricity. Before touching any parts or components in an area marked with the static-sensitive symbol, touch a metal surface in an area away from the symbol.

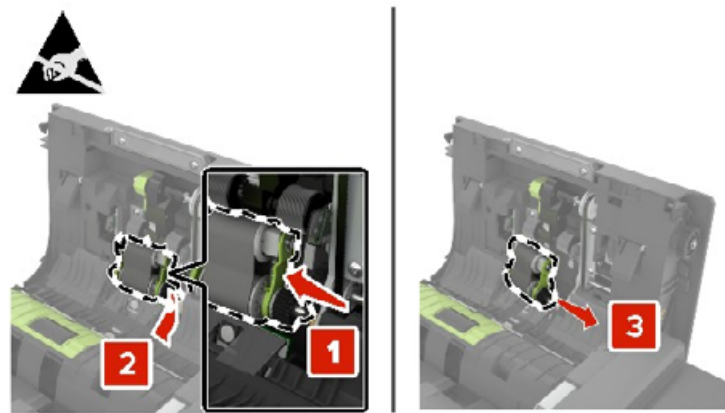

- 5 Unpack the new ADF feed roller.
- 6 Insert the new ADF feed roller until it *clicks* into place.

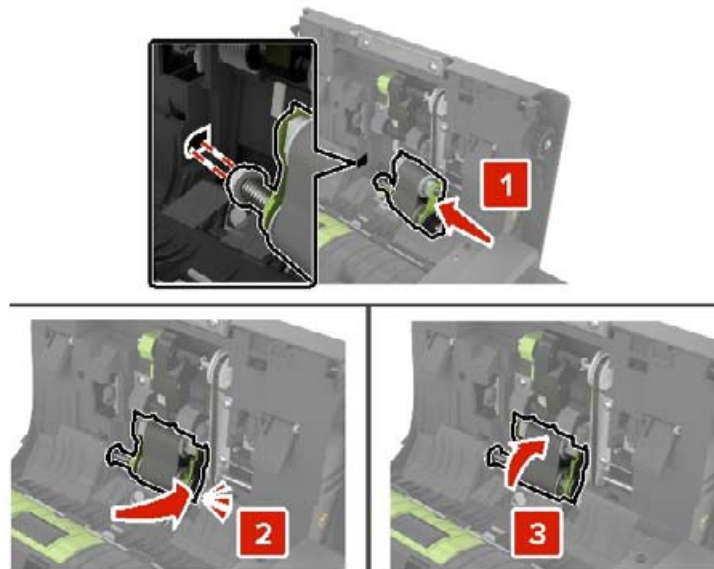

- 7 Insert the ADF pick roller cover until it *clicks* into place.



- 8 Close door D.
- 9 Turn on the printer.

Replacing the ADF separator roller

- 1 Turn off the printer.
- 2 Open door D.

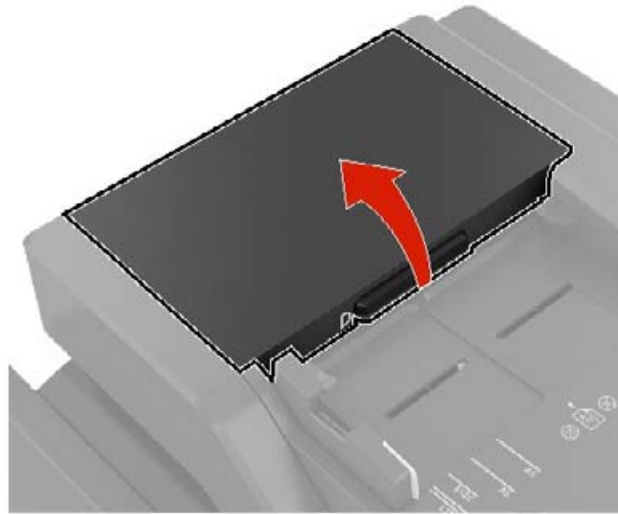

- 3 Remove the ADF separator roller cover.



- 4 Remove the ADF separator roller.

Warning—Potential Damage: Some parts of the printer are easily damaged by static electricity. Before touching any parts or components in an area marked with the static-sensitive symbol, touch a metal surface in an area away from the symbol.

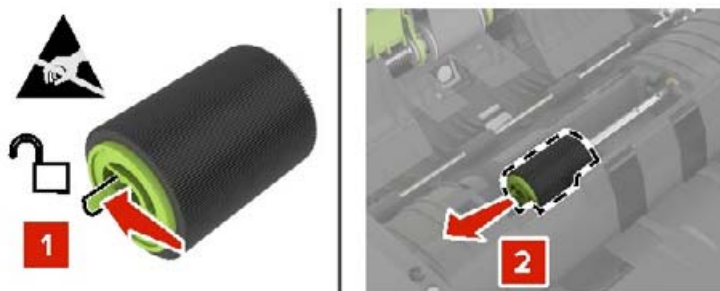

- 5 Unpack the new ADF separator roller.
- 6 Insert the new ADF separator roller until it *clicks* into place.

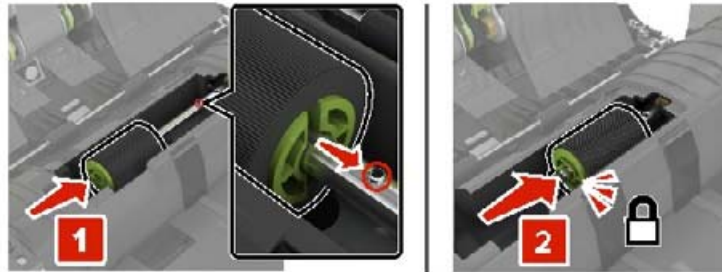

- 7 Insert the ADF separator roller cover until it *clicks* into place.



- 8 Close door D.
- 9 Turn on the printer.

Resetting the maintenance counter

- 1 From the home screen, touch **Settings** > **Device** > **Maintenance** > **Configuration Menu** > **Supply Usage And Counters**.
- 2 Select **Fuser Reset** or **ITM Reset**.

Resetting the supply usage counters

- 1 From the home screen, touch **Settings** > **Device** > **Maintenance** > **Configuration Menu** > **Supply Usage And Counters**.
- 2 Select the counter that you want to reset.

Warning—Potential Damage: Supplies and parts without use-and-return program agreement terms may be reset and remanufactured. However, the manufacturer's warranty does not cover any damage caused by non-genuine supplies or parts. Resetting counters on the supply or part without proper remanufacturing can cause damage to your printer. After resetting the supply or part counter, your printer may display an error indicating the presence of the reset item.

Replacing the staple cartridge unit

Replacing the staple cartridge in the staple finisher

1 Open door C.

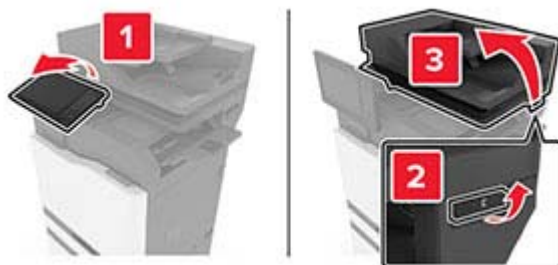

2 Open door G.



3 Remove the staple cartridge.

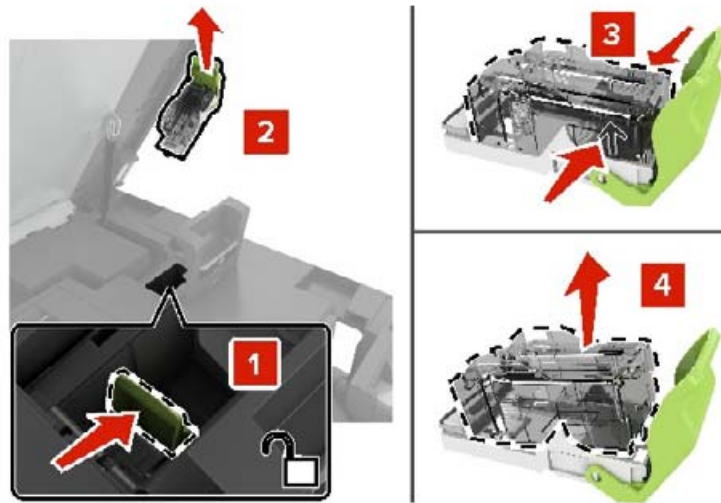

4 Unpack the new staple cartridge.

5 Insert the new staple cartridge until it *clicks* into place.

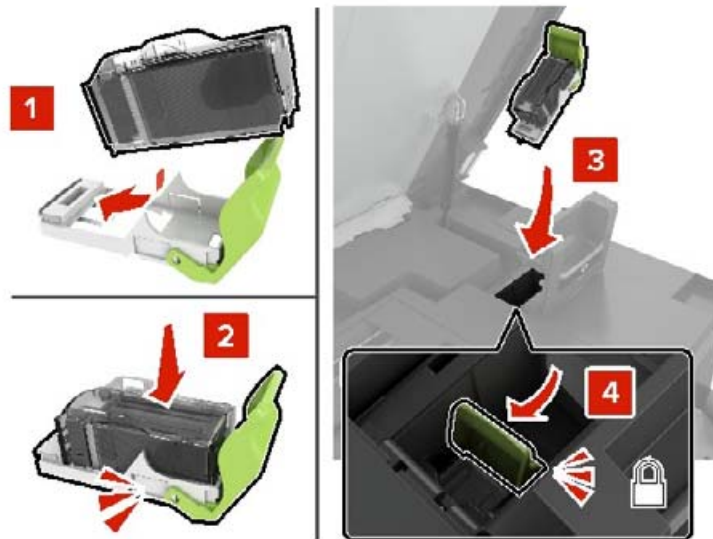

6 Close doors G and C.

 **CAUTION—PINCH HAZARD:** To avoid the risk of a pinch injury, keep hands clear of the labeled area when closing door C.

Replacing the staple cartridge holder in the staple finisher

1 Open door C.

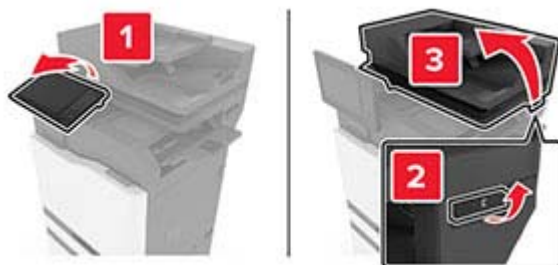

2 Open door G.



3 Pull out the staple cartridge holder.

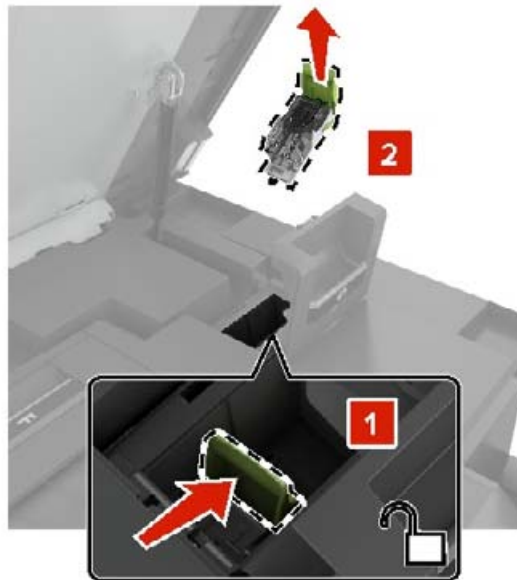

4 Remove the staple cartridge.

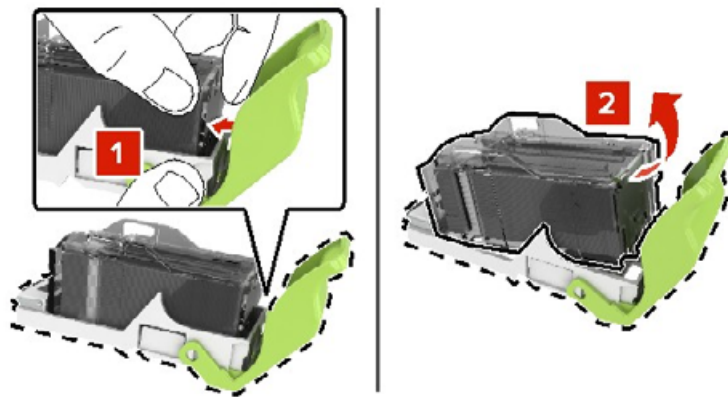

5 Unpack the new staple cartridge holder.

6 Insert the staple cartridge until it *clicks* into place.

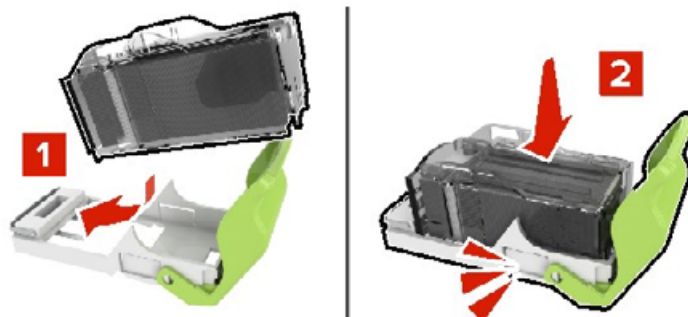

- 7 Insert the staple cartridge holder until it *clicks* into place.

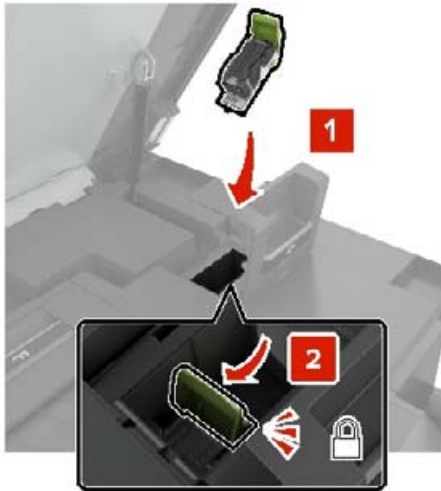

- 8 Close doors G and C.

 **CAUTION—PINCH HAZARD:** To avoid the risk of a pinch injury, keep hands clear of the labeled area when closing door C.

Replacing the staple cartridge in the multiposition staple, hole punch finisher

- 1 Open door J.



- 2 Remove the staple cartridge.

Note: If necessary, remove the tape from the staple cartridge holder.

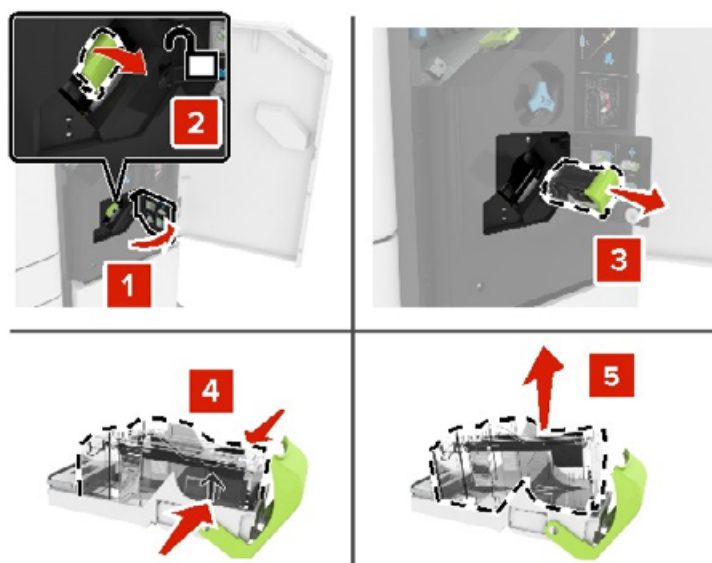

- 3 Unpack the new staple cartridge.
- 4 Insert the new staple cartridge until it *clicks* into place.

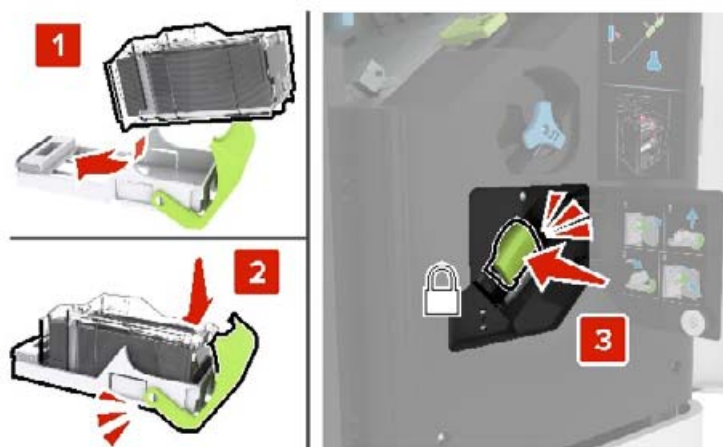

- 5 Close door J.

Replacing the staple cartridge holder in the multiposition staple, hole punch finisher

1 Open door J.



2 Remove the staple cartridge holder.



3 Remove the staple cartridge.

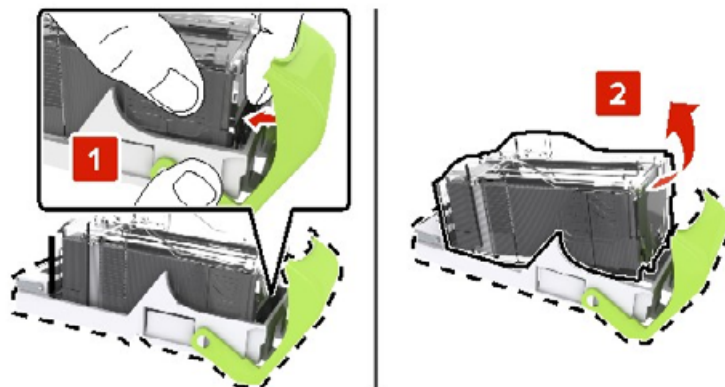

4 Unpack the new staple cartridge holder.

5 Insert the staple cartridge until it *clicks* into place.

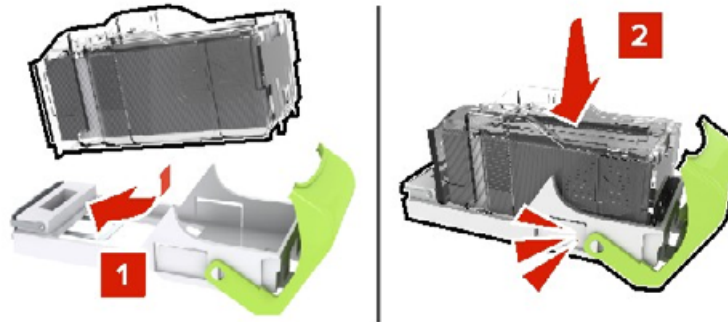

6 Insert the staple cartridge holder until it *clicks* into place.



7 Close door J.

Storing supplies

Choose a cool, clean storage area for the printer supplies. Store supplies right side up in their original packing until you are ready to use them.

Do not expose supplies to:

- Direct sunlight
- Temperatures above 35°C (95°F)
- High humidity above 80%
- Salty air
- Corrosive gases
- Heavy dust

Moving the printer

Moving the printer to another location

⚠ CAUTION—POTENTIAL INJURY: If the printer weight is greater than 20 kg (44 lb), then it may require two or more people to lift it safely.

⚠ CAUTION—POTENTIAL INJURY: To avoid the risk of fire or electrical shock, use only the power cord provided with this product or the manufacturer's authorized replacement.

 **CAUTION—POTENTIAL INJURY:** When moving the printer, follow these guidelines to avoid personal injury or printer damage:

- Make sure that all doors and trays are closed.
- Turn off the printer, and then unplug the power cord from the electrical outlet.
- Disconnect all cords and cables from the printer.
- If the printer has separate floor-standing optional trays or output options attached to it, then disconnect them before moving the printer.
- If the printer has a caster base, then carefully roll it to the new location. Use caution when passing over thresholds and breaks in flooring.
- If the printer does not have a caster base but is configured with optional trays or output options, then remove the output options and lift the printer off the trays. Do not try to lift the printer and any options at the same time.
- Always use the handholds on the printer to lift it.
- Any cart used to move the printer must have a surface able to support the full footprint of the printer.
- Any cart used to move the hardware options must have a surface able to support the dimensions of the options.
- Keep the printer in an upright position.
- Avoid severe jarring movements.
- Make sure that your fingers are not under the printer when you set it down.
- Make sure that there is adequate clearance around the printer.

Note: Damage to the printer caused by improper moving is not covered by the printer warranty.

Shipping the printer

When shipping the printer, use the original packaging or contact the place where you purchased the printer.

Saving energy and paper

Configuring the power save mode settings

Sleep mode

- 1 From the home screen, touch **Settings > Device > Power Management > Timeouts > Sleep Mode**.
- 2 Specify the amount of time that the printer stays idle before it enters Sleep Mode.

Hibernate mode

- 1 From the home screen, touch **Settings > Device > Power Management > Timeouts > Hibernate Timeout**.
- 2 Select the amount of time that the printer stays idle before it enters Hibernate mode.

Notes:

- For Hibernate Timeout to work, set Hibernate Timeout on Connection to Hibernate.
- The Embedded Web Server is disabled when the printer is in Hibernate mode.

Adjusting the brightness of the printer display

- 1 From the home screen, touch **Settings** > **Device** > **Preferences** > **Screen Brightness**.
- 2 Adjust the setting.

Conserving supplies

- Print on both sides of the paper.
Note: Two-sided printing is the default setting in the print driver.
- Print multiple pages on a single sheet of paper.
- Use the preview feature to see how the document looks like before printing it.
- Print one copy of the document to check its content and format for accuracy.

Clearing jams

Avoiding jams

Load paper properly

- Make sure that the paper lies flat in the tray.

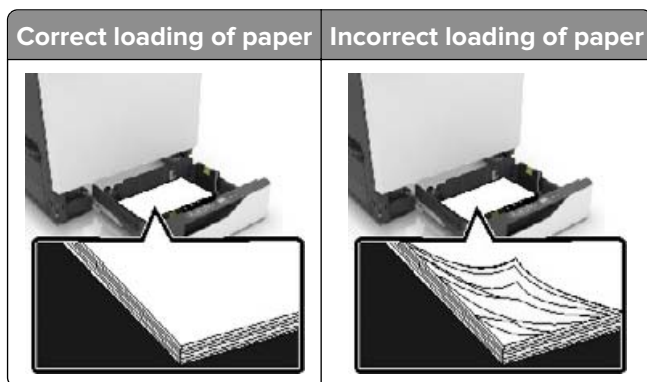

- Do not load or remove a tray while the printer is printing.
- Do not load too much paper. Make sure that the stack height is below the maximum paper fill indicator.
- Do not slide paper into the tray. Load paper as shown in the illustration.

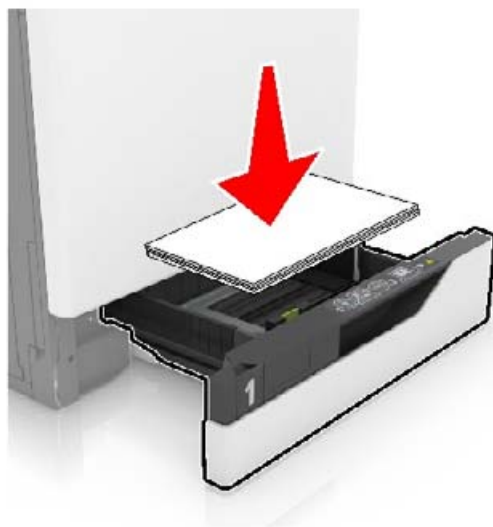

- Make sure that the paper guides are positioned correctly and are not pressing tightly against the paper or envelopes.
- Push the tray firmly into the printer after loading paper.

Use recommended paper

- Use only recommended paper or specialty media.
- Do not load paper that is wrinkled, creased, damp, bent, or curled.

- Flex, fan, and align the paper edges before loading.



- Do not use paper that has been cut or trimmed by hand.
- Do not mix paper sizes, weights, or types in the same tray.
- Make sure that the paper size and type are set correctly on the computer or printer control panel.
- Store paper according to manufacturer recommendations.

Identifying jam locations

Notes:

- When Jam Assist is set to On, the printer flushes blank pages or pages with partial prints after a jammed page has been cleared. Check your printed output for blank pages.
- When Jam Recovery is set to On or Auto, the printer reprints jammed pages.

Printer jam locations



1	Multipurpose feeder
2	Door B
3	Automatic document feeder (ADF)
4	Standard bin
5	Door G
6	Finisher bin
7	Trays

Finisher jam locations



1	Door L
2	Door J
3	Door K
4	Door N

Paper jam in trays

- 1 Pull out the tray.



- 2 Remove the jammed paper.

Note: Make sure that all paper fragments are removed.



3 Insert the tray.

4 Open the tray cover.



5 Remove the jammed paper.

Note: Make sure that all paper fragments are removed.

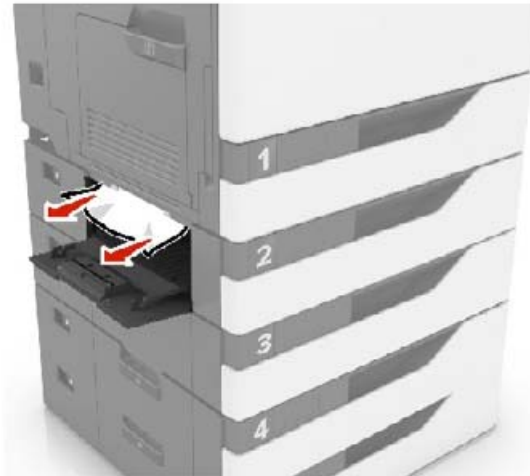

- 6 Close the tray cover.

Paper jam in the multipurpose feeder

- 1 Remove paper from the multipurpose feeder.
- 2 Remove the jammed paper.

Note: Make sure that all paper fragments are removed.

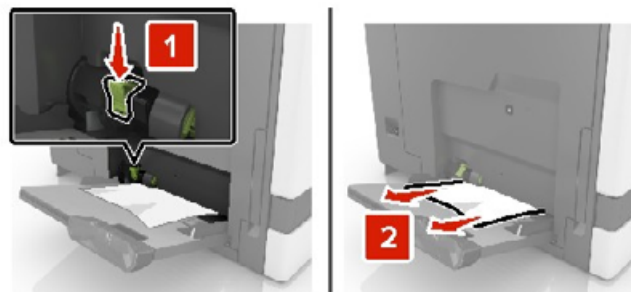

- 3 Open door B, and then remove any paper fragments.

 **CAUTION—HOT SURFACE:** The inside of the printer might be hot. To reduce the risk of injury from a hot component, allow the surface to cool before touching it.

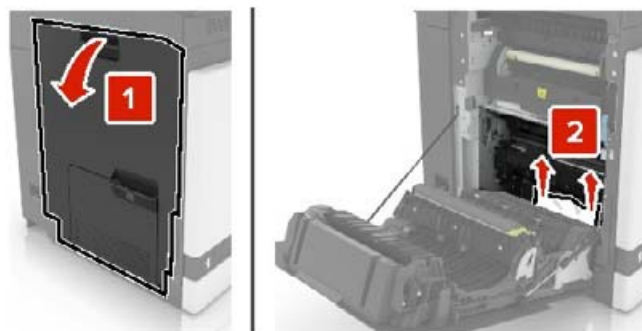

- 4 Close door B.
- 5 Flex, fan, and align the paper edges before loading.



- 6 Reload paper.

Paper jam in the automatic document feeder

- 1 Remove all original documents from the ADF tray.
- 2 Open door D.

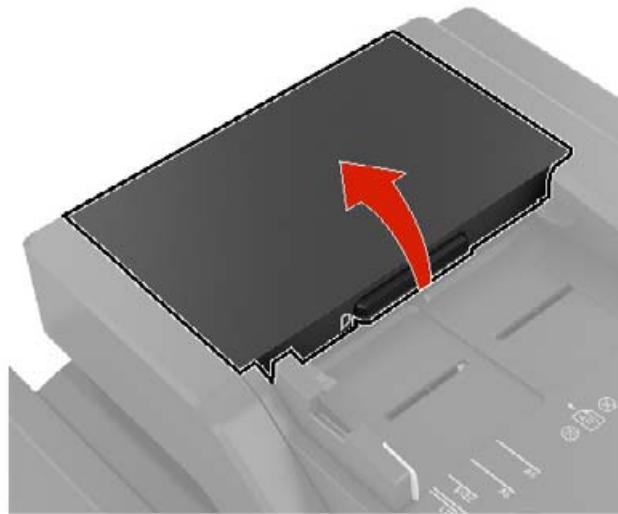

- 3 Remove the jammed paper.

Note: Make sure that all paper fragments are removed.

Warning—Potential Damage: Some parts of the printer are easily damaged by static electricity. Before touching any parts or components in an area marked with the static-sensitive symbol, touch a metal surface in an area away from the symbol.

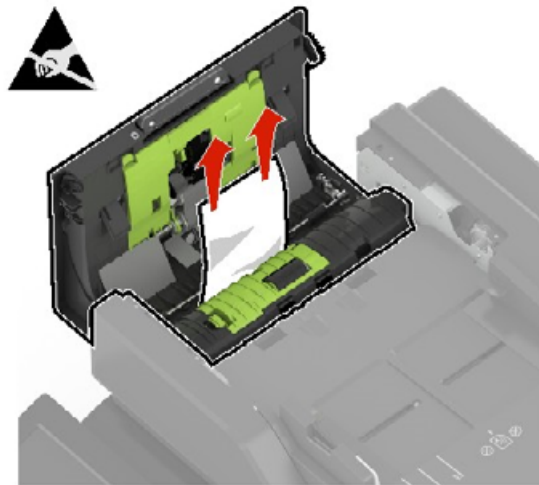

4 Close door D.

5 Open the scanner cover.



6 Open door E.

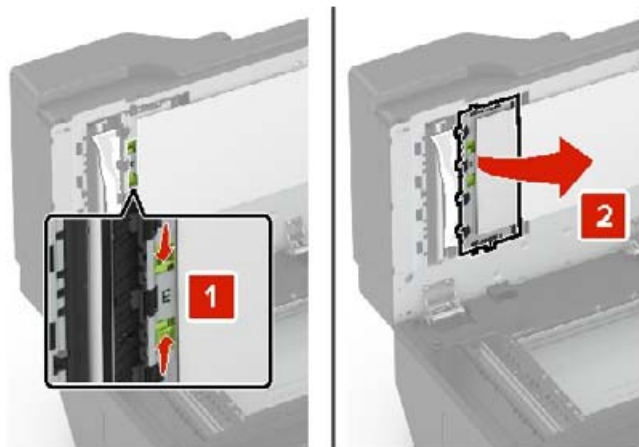

7 Remove the jammed paper.

Note: Make sure that all paper fragments are removed.

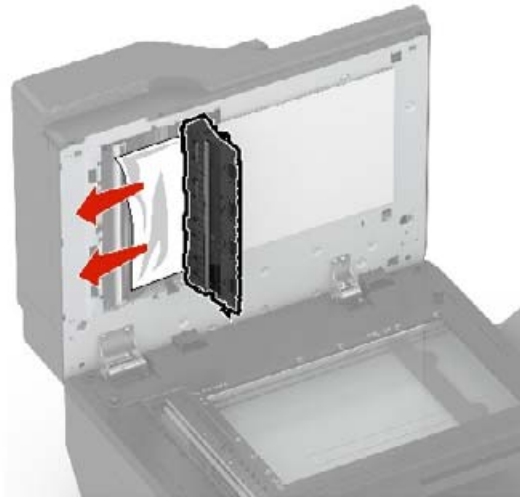

- 8 Close door E and the scanner cover.

Paper jam in the standard bin

- 1 Remove the jammed paper.

Note: Make sure that all paper fragments are removed.

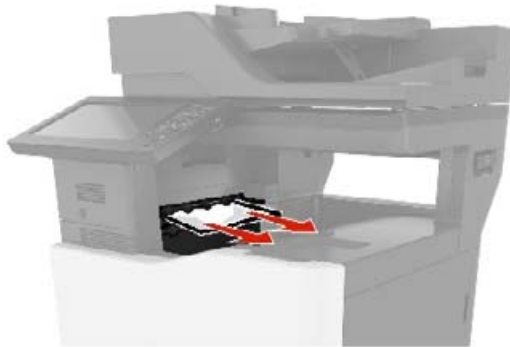

- 2 Open door B, and then remove any paper fragments.



CAUTION—HOT SURFACE: The inside of the printer might be hot. To reduce the risk of injury from a hot component, allow the surface to cool before touching it.

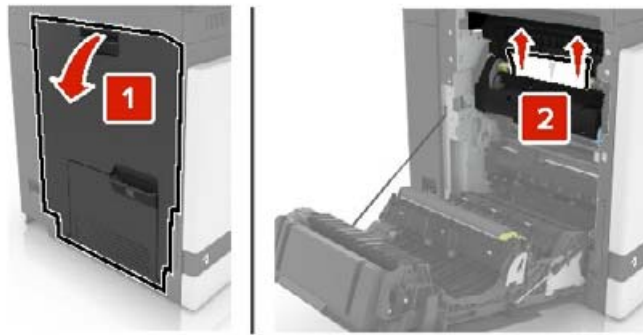

3 Close door B.

Paper jam in door B

Paper jam in the fuser

1 Open door B.

 **CAUTION—HOT SURFACE:** The inside of the printer might be hot. To reduce the risk of injury from a hot component, allow the surface to cool before touching it.

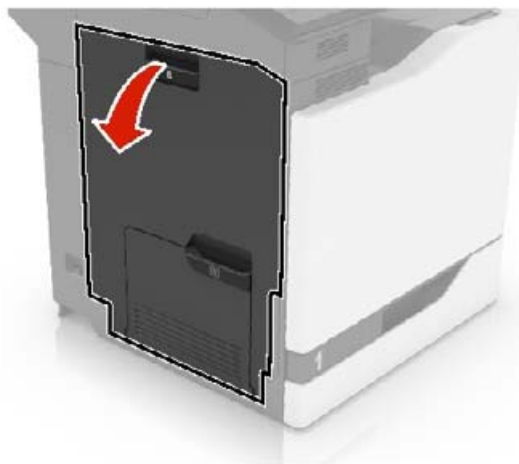

2 Remove the jammed paper.

Note: Make sure that all paper fragments are removed.

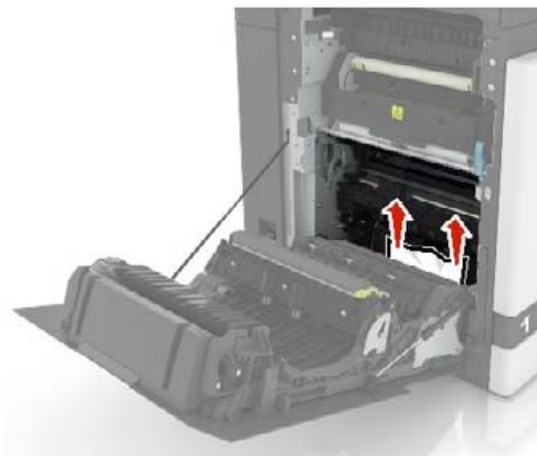

3 Open the fuser access door.

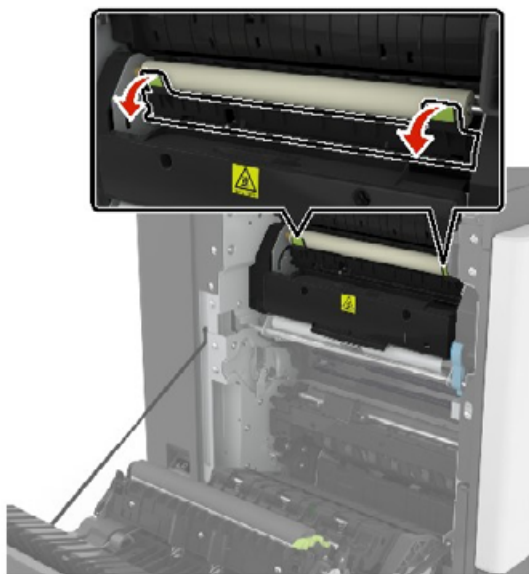

4 Remove the jammed paper.

Note: Make sure that all paper fragments are removed.

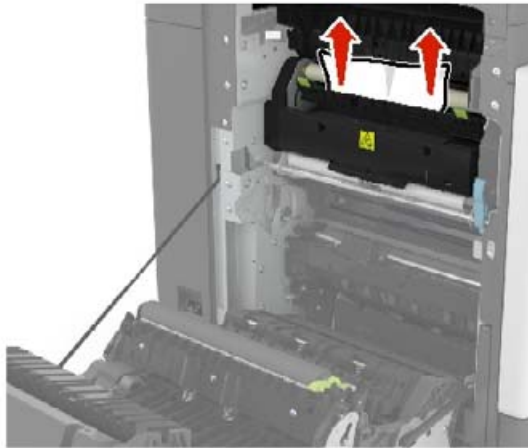

5 Close door B.

Paper jam in the duplex unit

1 Open door B.

 **CAUTION—HOT SURFACE:** The inside of the printer might be hot. To reduce the risk of injury from a hot component, allow the surface to cool before touching it.

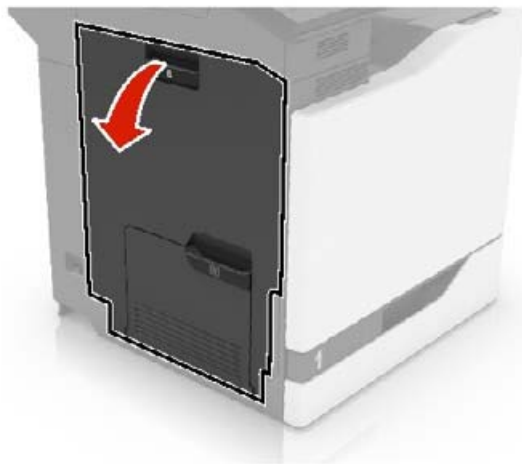

2 Remove the jammed paper.

Note: Make sure that all paper fragments are removed.

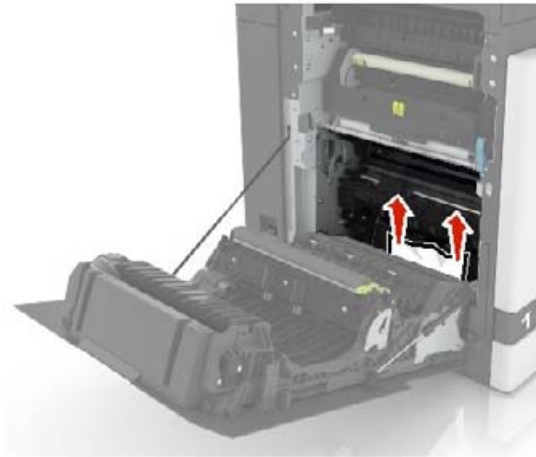

3 Open the duplex cover.



4 Remove the jammed paper.

Note: Make sure that all paper fragments are removed.

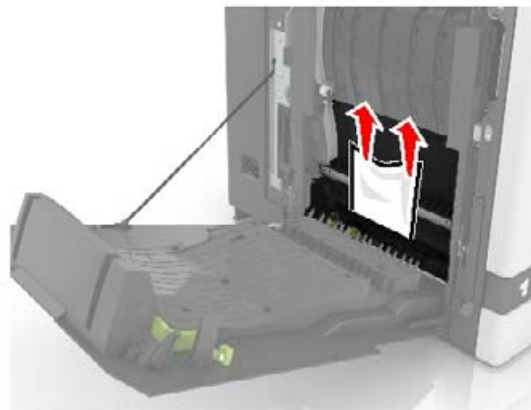

5 Close the duplex cover and door B.

Paper jam in the finisher bin

1 Remove the jammed paper.

Note: Make sure that all paper fragments are removed.

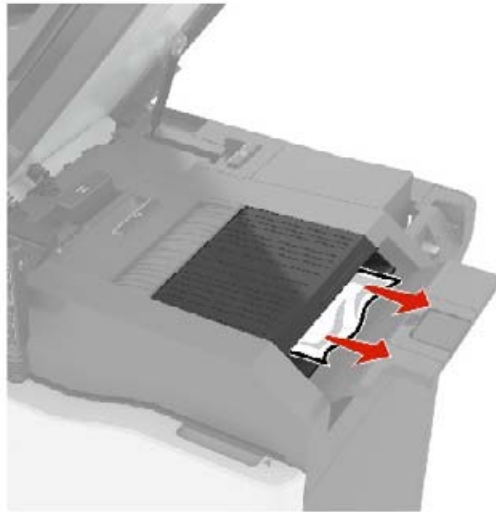

2 Open door C.



3 Open door F.

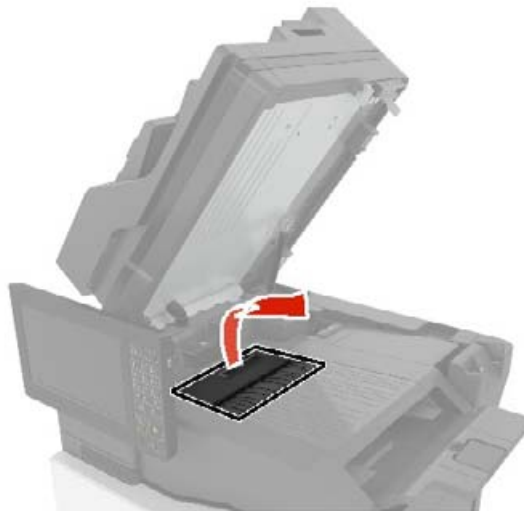

4 Remove the jammed paper.

Note: Make sure that all paper fragments are removed.



5 Close doors F and C.

 **CAUTION—PINCH HAZARD:** To avoid the risk of a pinch injury, keep hands clear of the labeled area when closing door C.

Staple jam in door G

1 Open door C.

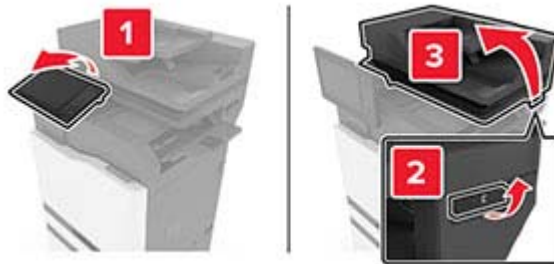

2 Open door G.



3 Pull out the staple cartridge holder.

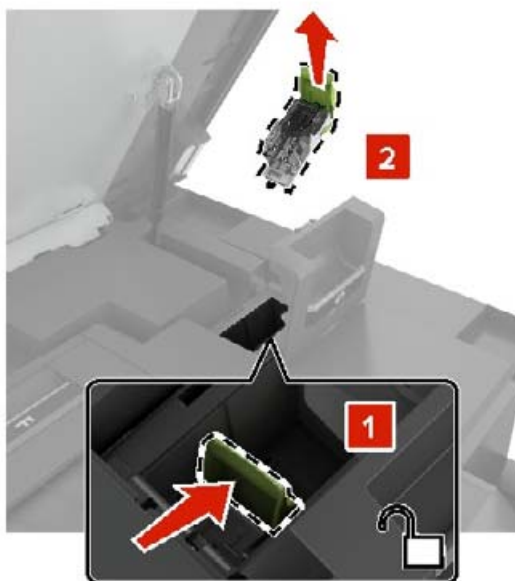

- 4 Lift the staple guard, and then remove the loose staples.



Note: Do not insert the staples that came out of the cartridge.

- 5 Close the staple guard.



6 Insert the staple cartridge holder.



7 Close doors G and C.

CAUTION—PINCH HAZARD: To avoid the risk of a pinch injury, keep hands clear of the labeled area when closing door C.

Paper jam in door K

1 Open doors C and K.

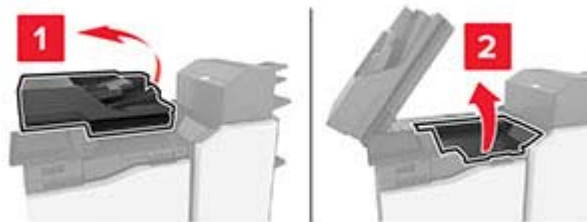

2 Remove the jammed paper.

Note: Make sure that all paper fragments are removed.

- Using knob K1

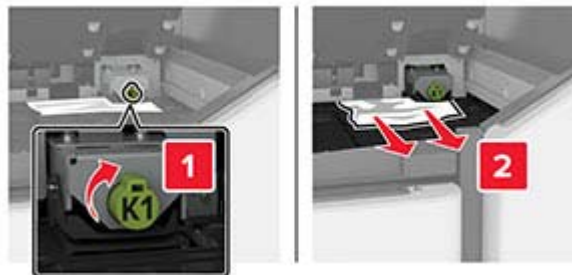

- Using knob J2

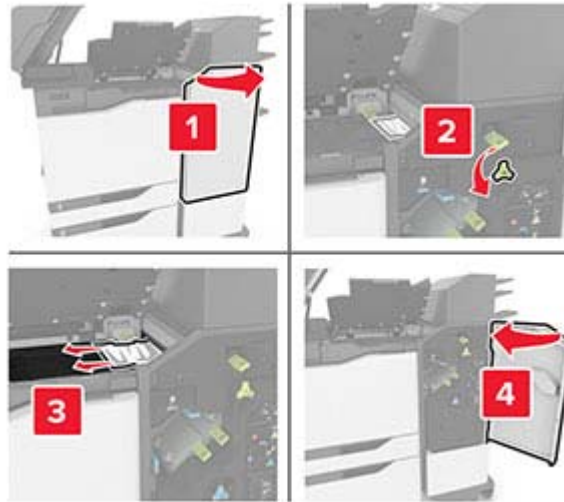

- 3** Close doors K and C.

 **CAUTION—PINCH HAZARD:** To avoid the risk of a pinch injury, keep hands clear of the labeled area when closing door C.

Paper jam in door J

- 1** Open door J.

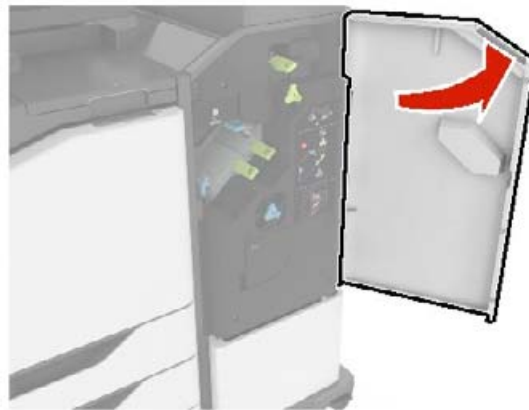

- 2** Remove the jammed paper.

Note: Make sure that all paper fragments are removed.

- Area J1

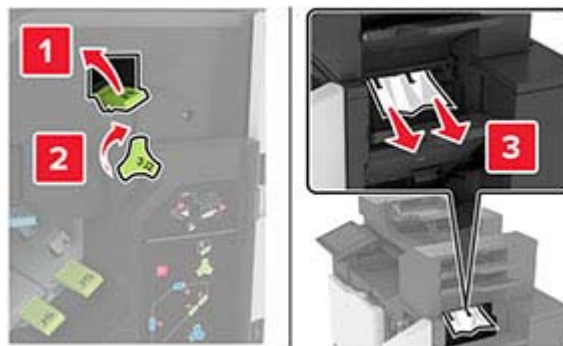

- Areas J3 and J4



- Areas J5 and J6



3 Close door J.

Paper jam in door N

- 1 Open door N.

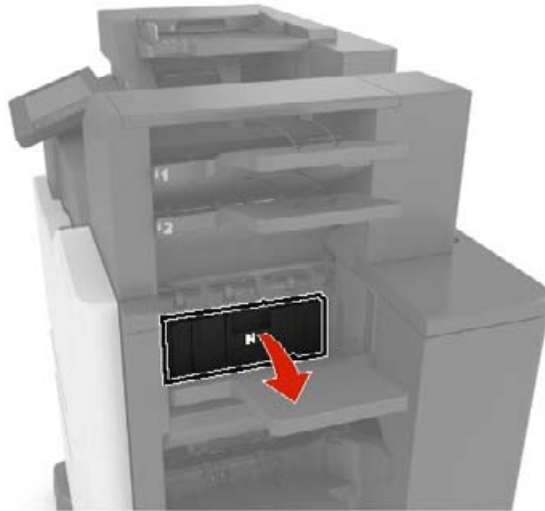

- 2 Remove the jammed paper.

Note: Make sure that all paper fragments are removed.

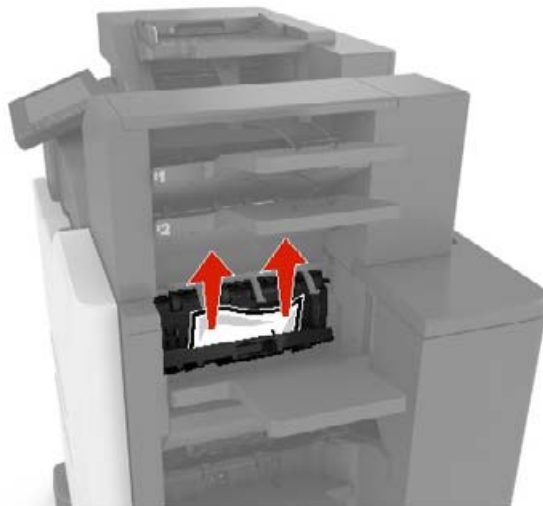

- 3 Close door N.

Paper jam in door L

- 1 Open door L.

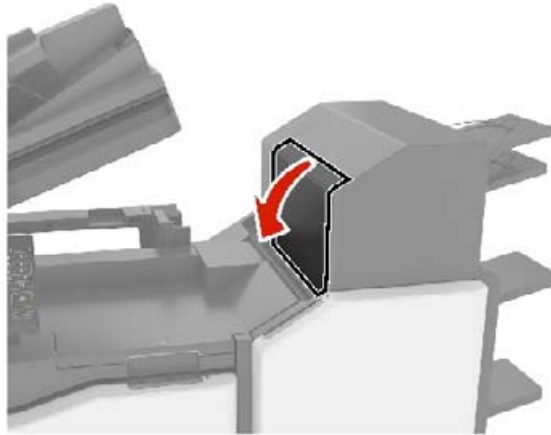

- 2 Remove the jammed paper.

Note: Make sure that all paper fragments are removed.

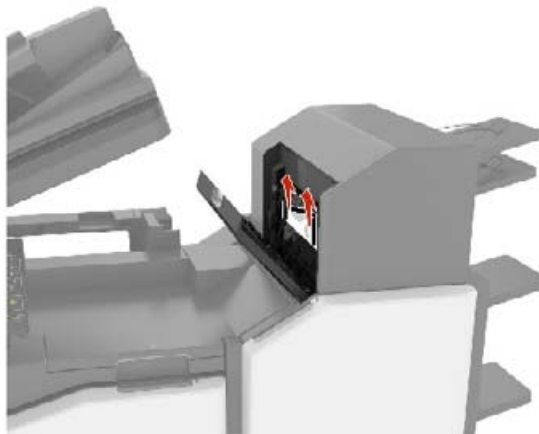

- 3 Close door L.

Paper jam in the staple finisher bin

- 1 Open door J.



- 2 Remove the jammed paper.

Note: Make sure that all paper fragments are removed.



- 3 Close door J.

Staple jam in door J

- 1 Open door J.



2 Remove the staple cartridge holder.



3 Open the staple guard, and then remove the loose staples.

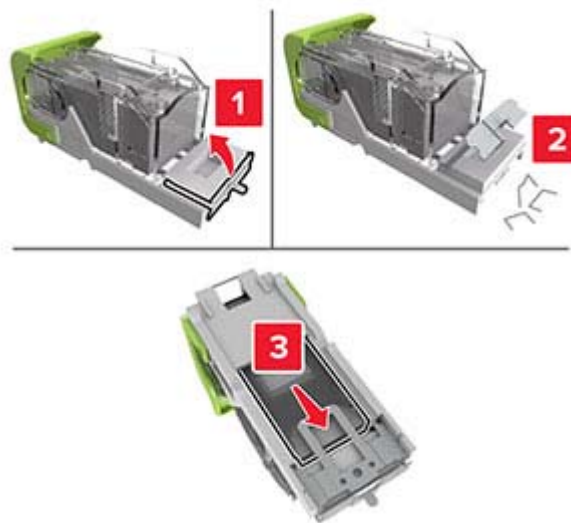

Note: Do not insert the staples that came out of the cartridge.

4 Close the staple guard.

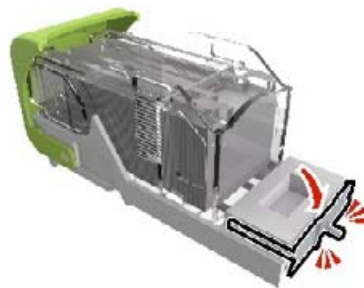

5 Insert the staple cartridge holder.



6 Close door J.

Troubleshooting

Network connection problems

Cannot open Embedded Web Server

Action	Yes	No
<p>Step 1 Check if the printer is on.</p> <p>Is the printer on?</p>	Go to step 2.	Turn on the printer.
<p>Step 2 Make sure that the printer IP address is correct.</p> <p>Notes:</p> <ul style="list-style-type: none"> • View the IP address on the home screen. • An IP address appears as four sets of numbers separated by periods, such as 123.123.123.123. <p>Is the printer IP address correct?</p>	Go to step 3.	Type the correct printer IP address in the address field.
<p>Step 3 Check if you are using a supported browser:</p> <ul style="list-style-type: none"> • Internet Explorer version 11 or later • Microsoft Edge • Safari version 6 or later • Google Chrome™ version 32 or later • Mozilla Firefox version 24 or later <p>Is your browser supported?</p>	Go to step 4.	Install a supported browser.
<p>Step 4 Check if the network connection is working.</p> <p>Is the network connection working?</p>	Go to step 5.	Contact your administrator.
<p>Step 5 Make sure that the cable connections to the printer and print server are secure. For more information, see the documentation that came with the printer.</p> <p>Are the cable connections secure?</p>	Go to step 6.	Secure the cable connections.
<p>Step 6 Check if the web proxy servers are disabled.</p> <p>Are the web proxy servers disabled?</p>	Go to step 7.	Contact your administrator.

Action	Yes	No
<p>Step 7 Access the Embedded Web Server.</p> <p>Did the Embedded Web Server open?</p>	The problem is solved.	Contact your dealer .

Unable to read flash drive

Action	Yes	No
<p>Step 1 Check if the printer is not busy processing another job.</p> <p>Is the printer ready?</p>	Go to step 2.	Wait for the printer to finish processing the other job.
<p>Step 2 Check if the flash drive is inserted into the front USB port.</p> <p>Note: The flash drive does not work when it is inserted into the rear USB port.</p> <p>Is the flash drive inserted into the correct port?</p>	Go to step 3.	Insert the flash drive into the correct port.
<p>Step 3 Check if the flash drive is supported. For more information, see “Supported flash drives and file types” on page 37.</p> <p>Is the flash drive supported?</p>	Go to step 4.	Insert a supported flash drive.
<p>Step 4</p> <p>a Check if the USB port is enabled. For more information, see “Enabling the USB port” on page 218.</p> <p>b Remove, and then insert the flash drive.</p> <p>Does the printer recognize the flash drive?</p>	The problem is solved.	Contact your dealer .

Enabling the USB port

From the home screen, touch **Settings > Network/Ports > USB > Enable USB Port**.

Checking the printer connectivity

- 1 From the home screen, touch **Settings > Reports > Network > Network Setup Page**.
- 2 Check the first section of the network setup page, and confirm that the status is connected.
If the status is not connected, then the LAN drop may be inactive, or the network cable may be unplugged or malfunctioning. Contact your administrator for assistance.

Hardware options problems

Defective flash detected

Contact your [dealer](#).

Not enough free space in flash memory for resources

Contact your [dealer](#).

Unformatted flash detected

Try one or more of the following:

- From the control panel, select **Continue** to stop the defragmentation and continue printing.
- Format the flash memory.

Note: If the error message remains, then the flash memory may be defective and needs to be replaced.

Issues with supplies

Replace cartridge, printer region mismatch

Install the correct toner cartridge.

Non-Printer Manufacturer supply

The printer has detected an unrecognized supply or part installed in the printer.

Your printer is designed to function best with genuine supplies and parts made by the printer manufacturer. Use of third-party supplies or parts may affect the performance, reliability, or life of the printer and its imaging components.

All life indicators are designed to function with supplies and parts from the printer manufacturer and may deliver unpredictable results if third-party supplies or parts are used. Imaging component usage beyond the intended life may damage your printer or associated components.

Warning—Potential Damage: Use of third-party supplies or parts can affect warranty coverage. Damage caused by the use of third-party supplies or parts may not be covered by the warranty.

To accept any and all of these risks and to proceed with the use of non-genuine supplies or parts in your printer, from the control panel, press and hold **X** and **#** simultaneously for 15 seconds.

If you do not want to accept these risks, then remove the third-party supply or part from your printer and install a genuine supply or part from the printer manufacturer.

Paper feed problems

Envelope seals when printing

Action	Yes	No
<p>Step 1</p> <p>a Use an envelope that has been stored in a dry environment. Note: Printing on envelopes with high moisture content can seal the flaps.</p> <p>b Send the print job.</p> <p>Does the envelope seal when printing?</p>	Go to step 2.	The problem is solved.
<p>Step 2</p> <p>a Make sure that the paper type is set to Envelope. From the control panel, touch Settings > Paper > Tray Configuration > Paper Size/Type > select a paper source</p> <p>b Send the print job.</p> <p>Does the envelope seal when printing?</p>	Contact your dealer .	The problem is solved.

Collated printing does not work

Action	Yes	No
<p>Step 1</p> <p>a From the control panel, touch Settings > Print > Layout > Collate > On [1,2,1,2,1,2].</p> <p>b Print the document.</p> <p>Are the pages collated correctly?</p>	The problem is solved.	Go to step 2.
<p>Step 2</p> <p>a From the document that you are trying to print, open the Print dialog, and then select Collate.</p> <p>b Print the document.</p> <p>Are the pages collated correctly?</p>	The problem is solved.	Go to step 3.
<p>Step 3</p> <p>a Reduce the number of pages to print.</p> <p>b Print the document.</p> <p>Are the pages collated correctly?</p>	The problem is solved.	Contact your dealer .

Paper curl



Action	Yes	No
<p>Step 1</p> <p>a Adjust the guides in the tray to the correct position for the paper loaded.</p> <p>b Print the document.</p> <p>Is the paper curled?</p>	Go to step 2.	The problem is solved.
<p>Step 2</p> <p>a Depending on your operating system, specify the paper type from the Printing Preferences or Print dialog.</p> <p>Notes:</p> <ul style="list-style-type: none"> • Make sure that the setting matches the paper loaded. • You can also change the setting on the printer control panel. From the home screen, touch Settings > Paper > Tray Configuration > Paper Size/Type. <p>b Print the document.</p> <p>Is the paper curled?</p>	Go to step 3.	The problem is solved.
<p>Step 3</p> <p>Print on the other side of the paper.</p> <p>a Remove paper, flip it over, and then reload paper.</p> <p>b Print the document.</p> <p>Is the paper curled?</p>	Go to step 4.	The problem is solved.
<p>Step 4</p> <p>a Load paper from a fresh package.</p> <p>Note: Paper absorbs moisture due to high humidity. Store paper in its original wrapper until you are ready to use it.</p> <p>b Print the document.</p> <p>Is the paper curled?</p>	Contact your dealer .	The problem is solved.

Tray linking does not work

Action	Yes	No
<p>Step 1</p> <p>a Check if the trays contain the same paper size and paper type.</p> <p>b Check if the paper guides are positioned correctly.</p> <p>c Print the document.</p> <p>Do the trays link correctly?</p>	The problem is solved.	Go to step 2.
<p>Step 2</p> <p>a From the home screen, touch Settings > Paper > Tray Configuration > Paper Size/Type.</p> <p>b Set the paper size and paper type to match the paper loaded in the linked trays.</p> <p>c Print the document.</p> <p>Do the trays link correctly?</p>	The problem is solved.	Go to step 3.
<p>Step 3</p> <p>a Make sure that Tray Linking is set to Automatic. For more information, see “Linking trays” on page 27.</p> <p>b Print the document.</p> <p>Do the trays link correctly?</p>	The problem is solved.	Contact your dealer .

Paper frequently jams

Action	Yes	No
<p>Step 1</p> <p>a Pull out the tray.</p> <p>b Check if paper is loaded correctly.</p> <p>Notes:</p> <ul style="list-style-type: none"> • Make sure that the paper guides are positioned correctly. • Make sure that the stack height is below the maximum paper fill indicator. • Make sure to print on recommended paper size and type. <p>c Insert the tray.</p> <p>d Print the document.</p> <p>Do paper jams occur frequently?</p>	Go to step 2.	The problem is solved.

Action	Yes	No
<p>Step 2</p> <p>a From the home screen, touch Settings > Paper > Tray Configuration > Paper Size/Type.</p> <p>b Set the correct paper size and type.</p> <p>c Print the document.</p> <p>Do paper jams occur frequently?</p>	Go to step 3.	The problem is solved.
<p>Step 3</p> <p>a Load paper from a fresh package.</p> <p>Note: Paper absorbs moisture due to high humidity. Store paper in its original wrapper until you are ready to use it.</p> <p>b Print the document.</p> <p>Do paper jams occur frequently?</p>	Contact your dealer .	The problem is solved.

Jammed pages are not reprinted

Action	Yes	No
<p>a From the home screen, touch Settings > Device > Notifications > Jam Content Recovery.</p> <p>b In the Jam Recovery menu, select On or Auto.</p> <p>c Print the document.</p> <p>Are the jammed pages reprinted?</p>	The problem is solved.	Contact your dealer .

Printing problems

Confidential and other held documents do not print

Action	Yes	No
<p>Step 1</p> <p>a From the control panel, check if the documents appear in the Held Jobs list.</p> <p>Note: If the documents are not listed, then print the documents using the Print and Hold options.</p> <p>b Print the documents.</p> <p>Are the documents printed?</p>	The problem is solved.	Go to step 2.

Action	Yes	No
<p>Step 2</p> <p>The print job may contain a formatting error or invalid data.</p> <ul style="list-style-type: none"> • Delete the print job, and then send it again. • For PDF files, generate a new file, and then print the documents. <p>Are the documents printed?</p>	The problem is solved.	Go to step 3.
<p>Step 3</p> <p>If you are printing from the Internet, then the printer may be reading the multiple job titles as duplicates.</p> <ol style="list-style-type: none"> Open the Printing Preferences dialog. From the Print and Hold tab, click Use Print and Hold, and then click Keep duplicate documents. From the Confidential Print section, enter a PIN. Print the documents. <p>Are the documents printed?</p>	The problem is solved.	Go to step 4.
<p>Step 4</p> <ol style="list-style-type: none"> Delete some held jobs to free up printer memory. Print the documents. <p>Are the documents printed?</p>	The problem is solved.	Contact your dealer .

Slow printing

Action	Yes	No
<p>Step 1</p> <p>Make sure that the printer cable is securely connected to the printer and to the computer, print server, option, or other network device.</p> <p>Is the printer printing slow?</p>	Go to step 2.	The problem is solved.
<p>Step 2</p> <ol style="list-style-type: none"> Make sure that the printer is not in Quiet Mode. From the home screen, touch Settings > Device > Maintenance > Configuration Menu > Device Operations > Quiet Mode. Print the document. <p>Is the printer printing slow?</p>	Go to step 3.	The problem is solved.

Action	Yes	No
<p>Step 3</p> <p>a Depending on your operating system, specify the print resolution from the Printing Preferences or Print dialog.</p> <p>b Set the resolution to 4800 CQ.</p> <p>c Print the document.</p> <p>Is the printer printing slow?</p>	Go to step 4.	The problem is solved.
<p>Step 4</p> <p>a From the home screen, touch Settings > Print > Quality > Print Resolution.</p> <p>b Set the resolution to 4800 CQ.</p> <p>c Print the document.</p> <p>Is the printer printing slow?</p>	Go to step 5.	The problem is solved.
<p>Step 5</p> <p>a Depending on your operating system, specify the paper type from the Printing Preferences or Print dialog.</p> <p>Notes:</p> <ul style="list-style-type: none"> • Make sure that the setting matches the paper loaded. • You can also change the setting on the printer control panel. From the home screen, touch Settings > Paper > Tray Configuration > Paper Size/Type. • Heavier paper prints more slowly. • Paper narrower than letter, A4, and legal may print more slowly. <p>b Print the document.</p> <p>Is the printer printing slow?</p>	Go to step 6.	The problem is solved.
<p>Step 6</p> <p>a Make sure that the printer settings for texture and weight match the paper being loaded.</p> <p>From the home screen, touch Settings > Paper > Media Configuration > Media Types.</p> <p>Note: Rough paper texture and heavy paper weight may print more slowly.</p> <p>b Print the document.</p> <p>Is the printer printing slow?</p>	Go to step 7.	The problem is solved.
<p>Step 7</p> <p>Remove held jobs.</p> <p>Is the printer printing slow?</p>	Go to step 8.	The problem is solved.

Action	Yes	No
<p>Step 8</p> <p>a Make sure that the printer is not overheating.</p> <p>Notes:</p> <ul style="list-style-type: none"> • Allow the printer to cool down after a long print job. • Observe the recommended ambient temperature for the printer. For more information, see “Selecting a location for the printer” on page 10. <p>b Print the document.</p> <p>Is the printer printing slow?</p>	<p>Contact your dealer.</p>	<p>The problem is solved.</p>

Print jobs do not print

Action	Yes	No
<p>Step 1</p> <p>a From the document you are trying to print, open the Print dialog, and then check if you have selected the correct printer.</p> <p>b Print the document.</p> <p>Is the document printed?</p>	<p>The problem is solved.</p>	<p>Go to step 2.</p>
<p>Step 2</p> <p>a Check if the printer is on.</p> <p>b Resolve any error messages that appear on the display.</p> <p>c Print the document.</p> <p>Is the document printed?</p>	<p>The problem is solved.</p>	<p>Go to step 3.</p>
<p>Step 3</p> <p>a Check if the ports are working and if the cables are securely connected to the computer and the printer.</p> <p>For more information, see the setup documentation that came with the printer.</p> <p>b Print the document.</p> <p>Is the document printed?</p>	<p>The problem is solved.</p>	<p>Go to step 4.</p>
<p>Step 4</p> <p>a Turn off the printer, wait for about 10 seconds, and then turn on the printer.</p> <p>b Print the document.</p> <p>Is the document printed?</p>	<p>The problem is solved.</p>	<p>Go to step 5.</p>

Action	Yes	No
<p>Step 5</p> <p>a Remove, and then reinstall the print driver.</p> <p>b Print the document.</p> <p>Is the document printed?</p>	<p>The problem is solved.</p>	<p>Contact your dealer.</p>

Job prints from the wrong tray or on the wrong paper

Action	Yes	No
<p>Step 1</p> <p>a Check if you are printing on the correct paper.</p> <p>b Print the document.</p> <p>Is the document printed on the correct paper?</p>	<p>Go to step 2.</p>	<p>Load the correct paper size and paper type.</p>
<p>Step 2</p> <p>a Depending on your operating system, specify the paper size and paper type from the Printing Preferences or Print dialog.</p> <p>Note: You can also change the settings on the printer control panel. From the home screen, touch Settings > Paper > Tray Configuration > Paper Size/Type.</p> <p>b Make sure that the settings match the paper loaded.</p> <p>c Print the document.</p> <p>Is the document printed on the correct paper?</p>	<p>The problem is solved.</p>	<p>Go to step 3.</p>
<p>Step 3</p> <p>a Check if the trays are linked.</p> <p>For more information, see “Linking trays” on page 27.</p> <p>b Print the document.</p> <p>Is the document printed from the correct tray?</p>	<p>The problem is solved.</p>	<p>Contact your dealer.</p>

The printer is not responding

Action	Yes	No
<p>Step 1 Check if the power cord is connected to the electrical outlet.</p> <p> CAUTION—POTENTIAL INJURY: To avoid the risk of fire or electrical shock, connect the power cord to an appropriately rated and properly grounded electrical outlet that is near the product and easily accessible.</p> <p>Is the printer responding?</p>	The problem is solved.	Go to step 2.
<p>Step 2 Check if the electrical outlet is turned off by a switch or breaker.</p> <p>Is the electrical outlet turned off by a switch or breaker?</p>	Turn on the switch or reset the breaker.	Go to step 3.
<p>Step 3 Check if the printer is on.</p> <p>Is the printer on?</p>	Go to step 4.	Turn on the printer.
<p>Step 4 Check if the printer is in Sleep or Hibernate mode.</p> <p>Is the printer in Sleep or Hibernate mode?</p>	Press the power button to wake the printer.	Go to step 5.
<p>Step 5 Check if the cables connecting the printer and the computer are inserted to the correct ports.</p> <p>Are the cables inserted to the correct ports?</p>	Go to step 6.	Insert the cables to the correct ports.
<p>Step 6 Install the correct print driver.</p> <p>Is the printer responding?</p>	The problem is solved.	Go to step 7.
<p>Step 7 Turn off the printer, wait for about 10 seconds, and then turn on the printer.</p> <p>Is the printer responding?</p>	The problem is solved.	Contact your dealer .

Print quality is poor

Blank or white pages



Contact your [dealer](#).

Dark print



Note: Before solving the problem, print the quality sample pages to determine the missing color. From the home screen, touch **Settings > Troubleshooting > Print Quality Test Pages**.

Action	Yes	No
<p>Step 1</p> <p>a Perform Color Adjust. From the home screen, touch Settings > Print > Quality > Advanced Imaging > Color Adjust.</p> <p>b Print the document.</p> <p>Is the print too dark?</p>	Go to step 2.	The problem is solved.
<p>Step 2</p> <p>a Depending on your operating system, reduce the toner darkness from the Printing Preferences or Print dialog. Note: You can also change the setting on the printer control panel. From the home screen, touch Settings > Print > Quality > Toner Darkness.</p> <p>b Print the document.</p> <p>Is the print too dark?</p>	Go to step 3.	The problem is solved.

Action	Yes	No
<p>Step 3</p> <p>a Depending on your operating system, specify the paper type from the Printing Preferences or Print dialog.</p> <p>Notes:</p> <ul style="list-style-type: none"> • Make sure that the setting matches the paper loaded in the tray. • You can also change the setting on the printer control panel. From the home screen, touch Settings > Paper > Tray Configuration > Paper Size/Type. <p>b Print the document.</p> <p>Is the print too dark?</p>	Go to step 4.	The problem is solved.
<p>Step 4</p> <p>Make sure that the paper has no texture or rough finishes.</p> <p>Are you printing on textured or rough paper?</p>	Go to step 5.	Go to step 6.
<p>Step 5</p> <p>a Replace textured or rough paper with plain paper.</p> <p>b Print the document.</p> <p>Is the print too dark?</p>	Go to step 6.	The problem is solved.
<p>Step 6</p> <p>a Load paper from a fresh package.</p> <p>Note: Paper absorbs moisture due to high humidity. Store paper in its original wrapper until you are ready to use it.</p> <p>b Print the document.</p> <p>Is the print too dark?</p>	Contact your dealer .	The problem is solved.

Ghost images



Note: Before solving the problem, print the Print Quality Test Pages. From the home screen, touch **Settings > Troubleshooting > Print Quality Test Pages**.

Action	Yes	No
<p>Step 1</p> <p>a Load the tray with the correct paper type and weight.</p> <p>b Print the document.</p> <p>Do ghost images appear on prints?</p>	Go to step 2.	The problem is solved.
<p>Step 2</p> <p>a Depending on your operating system, specify the paper type from the Printing Preferences or Print dialog.</p> <p>Notes:</p> <ul style="list-style-type: none"> • Make sure that the setting matches the paper loaded in the tray. • You can also change the setting on the printer control panel. From the home screen, touch Settings > Paper > Tray Configuration > Paper Size/Type. <p>b Print the document.</p> <p>Do ghost images appear on prints?</p>	Go to step 3.	The problem is solved.
<p>Step 3</p> <p>a Perform Color Adjust.</p> <p>From the home screen, touch Settings > Print > Quality > Advanced Imaging > Color Adjust.</p> <p>b Print the document.</p> <p>Do ghost images appear on prints?</p>	Contact your dealer .	The problem is solved.

Gray or colored background

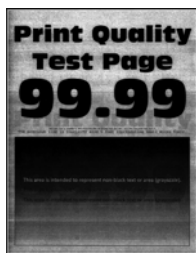

Note: Before solving the problem, print the Print Quality Test Pages. From the home screen, touch **Settings > Troubleshooting > Print Quality Test Pages**.

Action	Yes	No
<p>Step 1</p> <p>a Depending on your operating system, increase toner darkness from the Printing Preferences or Print dialog.</p> <p>Note: You can also change the setting on the printer control panel. From the home screen, touch Settings > Print > Quality > Toner Darkness.</p> <p>b Print the document.</p> <p>Does gray or colored background appear on prints?</p>	Go to step 2.	The problem is solved.
<p>Step 2</p> <p>a Perform Color Adjust.</p> <p>From the home screen, touch Settings > Print > Quality > Advanced Imaging > Color Adjust.</p> <p>b Print the document.</p> <p>Does gray or colored background appear on prints?</p>	Contact your dealer .	The problem is solved.

Incorrect margins



Note: Before solving the problem, print the Print Quality Test Pages. From the control panel, navigate to **Settings > Troubleshooting > Print Quality Test Pages**. For non-touch-screen printer models, press  to navigate through the settings.

Action	Yes	No
<p>Step 1</p> <p>a Adjust the paper guides to the correct position for the paper loaded.</p> <p>b Print the document.</p> <p>Are the margins correct?</p>	The problem is solved.	Go to step 2.

Action	Yes	No
<p>Step 2</p> <p>a Depending on your operating system, specify the paper size from the Printing Preferences or Print dialog.</p> <p>Notes:</p> <ul style="list-style-type: none"> • Make sure that the setting matches the paper loaded. • You can also change the setting from the printer control panel. Navigate to Settings > Paper > Tray Configuration > Paper Size/Type. <p>b Print the document.</p> <p>Are the margins correct?</p>	<p>The problem is solved.</p>	<p>Contact your dealer.</p>

Light print



Note: Before solving the problem, print the Print Quality Test Pages. From the control panel, navigate to **Settings > Troubleshooting > Print Quality Test Pages.**

Action	Yes	No
<p>Step 1</p> <p>a Perform Color Adjust. From the home screen, touch Settings > Print > Quality > Advanced Imaging > Color Adjust.</p> <p>b Print the document.</p> <p>S</p> <p>Is the print too light?</p>	<p>Go to step 2.</p>	<p>The problem is solved.</p>
<p>Step 2</p> <p>a Depending on your operating system, increase the toner darkness from the Printing Preferences or Print dialog. Note: You can also change the setting on the printer control panel. From the home screen, touch Settings > Print > Quality > Toner Darkness.</p> <p>b Print the document.</p> <p>Is the print too light?</p>	<p>Go to step 3.</p>	<p>The problem is solved.</p>

Action	Yes	No
<p>Step 3</p> <p>a Depending on your operating system, specify the paper type from the Printing Preferences or Print dialog.</p> <p>Notes:</p> <ul style="list-style-type: none"> • Make sure that the setting matches the paper loaded in the tray. • You can also change the setting on the printer control panel. From the home screen, touch Settings > Paper > Tray Configuration > Paper Size/Type. <p>b Print the document.</p> <p>Is the print too light?</p>	Go to step 4.	The problem is solved.
<p>Step 4</p> <p>Make sure that the paper has no texture or rough finishes.</p> <p>Are you printing on textured or rough paper?</p>	Go to step 5.	Go to step 6.
<p>Step 5</p> <p>a Replace textured or rough paper with plain paper.</p> <p>b Print the document.</p> <p>Is the print too dark?</p>	Go to step 6.	The problem is solved.
<p>Step 6</p> <p>a Load paper from a fresh package.</p> <p>Note: Paper absorbs moisture due to high humidity. Store paper in its original wrapper until you are ready to use it.</p> <p>b Print the document.</p> <p>Is the print too light?</p>	Contact your dealer .	The problem is solved.

Missing colors

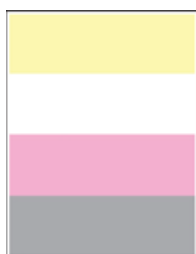

Contact your [dealer](#).

Mottled print and dots



Note: Before solving the problem, print the Print Quality Test Pages. From the home screen, touch **Settings** > **Troubleshooting** > **Print Quality Test Pages**.

Action	Yes	No
<p>Step 1 Check the printer for leaked toner contamination.</p> <p>Is the printer free of leaked toner?</p>	Go to step 2.	Contact your dealer .
<p>Step 2</p> <p>a Depending on your operating system, specify the paper type and size from the Printing Preferences or Print dialog.</p> <p>Notes:</p> <ul style="list-style-type: none"> • Make sure that the settings match the paper loaded. • You can also change the settings on the printer control panel. From the home screen, touch Settings > Paper > Tray Configuration > Paper Size/Type. <p>b Print the document.</p> <p>Is the print mottled?</p>	Go to step 3.	The problem is solved.
<p>Step 3</p> <p>a Replace the textured or rough paper loaded in the tray with plain paper.</p> <p>b Print the document.</p> <p>Is the print mottled?</p>	Contact your dealer .	The problem is solved.

Print crooked or skewed



Note: Before solving the problem, print the Print Quality Test Pages. From the home screen, touch **Settings** > **Troubleshooting** > **Print Quality Test Pages**.

Action	Yes	No
<p>Step 1</p> <ul style="list-style-type: none"> a Pull out the tray. b Remove the paper, and then load paper from a fresh package. Note: Paper absorbs moisture due to high humidity. Store paper in its original wrapper until you are ready to use it. c Squeeze and slide the paper guides to the correct position for the size of the paper you are loading. d Insert the tray. e Print the document. <p>Is the print crooked or skewed?</p>	Go to step 2.	The problem is solved.
<p>Step 2</p> <ul style="list-style-type: none"> a Check if you are printing on a supported paper. b Print the document. <p>Is the print crooked or skewed?</p>	Contact your dealer .	The problem is solved.

Solid color or black images



Contact your [dealer](#).

Text or images cut off



Note: Before solving the problem, print the Print Quality Test Pages. From the home screen, touch **Settings** > **Troubleshooting** > **Print Quality Test Pages**.

Action	Yes	No
<p>Step 1</p> <p>a Move the paper guides in the tray to the correct position for the paper loaded.</p> <p>b Print the document.</p> <p>Is the page or image clipped?</p>	Go to step 2.	The problem is solved.
<p>Step 2</p> <p>a Depending on your operating system, specify the paper size from the Printing Preferences or Print dialog.</p> <p>Notes:</p> <ul style="list-style-type: none"> • Make sure that the setting matches the paper loaded in the tray. • You can also change the setting on the printer control panel. From the home screen, touch Settings > Paper > Tray Configuration > Paper Size/Type. <p>b Print the document.</p> <p>Is the page or image clipped?</p>	Contact your dealer .	The problem is solved.

Toner easily rubs off



Note: Before solving the problem, print the Print Quality Test Pages. From the home screen, touch **Settings > Troubleshooting > Print Quality Test Pages**.

Action	Yes	No
<p>1 Depending on your operating system, specify the paper type from the Printing Preferences or Print dialog.</p> <p>Notes:</p> <ul style="list-style-type: none"> • Make sure that the setting matches the paper loaded. • You can also change the setting on the printer control panel. From the home screen, touch Settings > Paper > Tray Configuration > Paper Size/Type. <p>2 Print the document.</p> <p>Does the toner rub off?</p>	Contact your dealer .	The problem is solved.

Uneven print density



Contact your [dealer](#).

Horizontal dark lines



Notes:

- Before solving the problem, print the Print Quality Test Pages. From the home screen, touch **Settings > Troubleshooting > Print Quality Test Pages.**
- If horizontal dark lines keep appearing on the prints, then see the “Repeating defects” topic.

Action	Yes	No
<p>Step 1</p> <p>a Depending on your operating system, specify the paper source from the Printing Preferences or Print dialog.</p> <p>b Print the document.</p> <p>Do horizontal dark lines appear on prints?</p>	Go to step 2.	The problem is solved.
<p>Step 2</p> <p>a Depending on your operating system, specify the paper type from the Printing Preferences or from Print dialog.</p> <p>Notes:</p> <ul style="list-style-type: none"> • Make sure that the setting matches the paper loaded in the tray. • You can also change the setting on the printer control panel. From the home screen, touch Settings > Paper > Tray Configuration > Paper Size/Type. <p>b Print the document.</p> <p>Do horizontal dark lines appear on prints?</p>	Go to step 3.	The problem is solved.
<p>Step 3</p> <p>a Load paper from a fresh package.</p> <p>Note: Paper absorbs moisture due to high humidity. Store paper in its original wrapper until you use it.</p> <p>b Print the document.</p> <p>Do horizontal dark lines appear on prints?</p>	Contact your dealer .	The problem is solved.

Vertical dark lines



Note: Before solving the problem, print the Print Quality Test Pages. From the home screen, touch **Settings > Troubleshooting > Print Quality Test Pages**.

Action	Yes	No
<p>Step 1</p> <p>a Depending on your operating system, specify the paper type from the Printing Preferences or Print dialog.</p> <p>Notes:</p> <ul style="list-style-type: none"> • Make sure that the setting matches the paper loaded in the tray. • You can also change the setting on the printer control panel. From the home screen, touch Settings > Paper > Tray Configuration > Paper Size/Type. <p>b Print the document.</p> <p>Do vertical dark lines or streaks appear on prints?</p>	Go to step 2.	The problem is solved.
<p>Step 2</p> <p>a Load paper from a fresh package.</p> <p>Note: Paper absorbs moisture due to high humidity. Store paper in its original wrapper until you use it.</p> <p>b Print the document.</p> <p>Do vertical dark lines or streaks appear on prints?</p>	Contact your dealer .	The problem is solved.

Horizontal white lines



Notes:

- Before solving the problem, print the Print Quality Test Pages. From the home screen, touch **Settings > Troubleshooting > Print Quality Test Pages**.
- If horizontal white lines keep appearing on the prints, then see the “Repeating defects” topic.

Action	Yes	No
<p>Step 1</p> <p>a Depending on your operating system, specify the paper type from the Printing Preferences or Print dialog.</p> <p>Notes:</p> <ul style="list-style-type: none"> • Make sure that the setting matches the paper loaded in the tray. • You can also change the setting on the printer control panel. From the home screen, touch Settings > Paper > Tray Configuration > Paper Size/Type. <p>b Print the document.</p> <p>Do horizontal white lines appear on prints?</p>	Go to step 2.	The problem is solved.
<p>Step 2</p> <p>a Load the specified paper source with the recommended paper type.</p> <p>b Print the document.</p> <p>Do horizontal white lines appear on prints?</p>	Contact your dealer .	The problem is solved.

Vertical white lines



Note: Before solving the problem, print the Print Quality Test Pages. From the home screen, touch **Settings > Troubleshooting > Print Quality Test Pages**.

Action	Yes	No
<p>Step 1</p> <p>a Depending on your operating system, specify the paper type from the Printing Preferences or Print dialog.</p> <p>Notes:</p> <ul style="list-style-type: none"> • Make sure that the setting matches the paper loaded in the tray. • You can also change the setting on the printer control panel. From the home screen, touch Settings > Paper > Tray Configuration > Paper Size/Type. <p>b Print the document.</p> <p>Do vertical white lines appear on prints?</p>	Go to step 2.	The problem is solved.
<p>Step 2</p> <p>Check if you are using the recommended paper type.</p> <p>a Load the specified paper source with the recommended paper type.</p> <p>b Print the document.</p> <p>Do vertical white lines still appear on prints?</p>	Contact your dealer .	The problem is solved.

Repeating defects

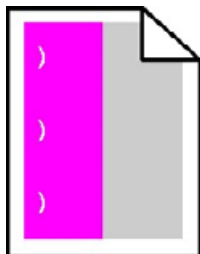

Contact your [dealer](#).

Color quality problems

Adjusting toner darkness

- 1 From the home screen, touch **Settings > Print > Quality**.
- 2 Adjust the toner darkness.
- 3 Apply the changes.

Modifying the colors in printed output

- 1 From the home screen, touch **Settings > Print > Quality > Advanced Imaging > Color Correction**.
- 2 In the Color Correction menu, touch **Manual > Color Correction Content**.
- 3 Choose the appropriate color conversion setting.

Object type	Color conversion tables
RGB Image RGB Text RGB Graphics	<ul style="list-style-type: none"> • Vivid—Produces brighter, more saturated colors and may be applied to all incoming color formats. • sRGB Display—Produces an output that approximates the colors shown on a computer monitor. Black toner usage is optimized for printing photographs. • Display-True Black—Produces an output that approximates the colors shown on a computer monitor. This setting uses only black toner to create all levels of neutral gray. • sRGB Vivid—Provides an increased color saturation for the sRGB Display color correction. Black toner usage is optimized for printing business graphics. • Off
CMYK Image CMYK Text CMYK Graphics	<ul style="list-style-type: none"> • US CMYK—Applies color correction to approximate the Specifications for Web Offset Publishing (SWOP) color output. • Euro CMYK—Applies color correction to approximate Euroscale color output. • Vivid CMYK—Increases the color saturation of the US CMYK color correction setting. • Off

FAQ about color printing

What is RGB color?

RGB color is a method of describing colors by indicating the amount of red, green, or blue used to produce a certain color. Red, green, and blue light can be added in various amounts to produce a large range of colors observed in nature. Computer screens, scanners, and digital cameras use this method to display colors.

What is CMYK color?

CMYK color is a method of describing colors by indicating the amount of cyan, magenta, yellow, and black used to reproduce a particular color. Cyan, magenta, yellow, and black inks or toners can be printed in various amounts to produce a large range of colors observed in nature. Printing presses, inkjet printers, and color laser printers create colors in this manner.

How is color specified in a document to be printed?

Software programs are used to specify and modify the document color using RGB or CMYK color combinations. For more information, see the software program Help topics.

How does the printer know what color to print?

When printing a document, information describing the type and color of each object is sent to the printer and is passed through color conversion tables. Color is translated into the appropriate amounts of cyan, magenta, yellow, and black toner used to produce the color you want. The object information determines the application of color conversion tables. For example, it is possible to apply one type of color conversion table to text while applying a different color conversion table to photographic images.

What is manual color correction?

When manual color correction is enabled, the printer employs user-selected color conversion tables to process objects. Manual color correction settings are specific to the type of object being printed (text, graphics, or images). It is also specific to how the color of the object is specified in the software program (RGB or CMYK combinations). To apply a different color conversion table manually, see [“Modifying the colors in printed output” on page 243](#).

If the software program does not specify colors with RGB or CMYK combinations, then manual color correction is not useful. It is also not effective if the software program or the computer operating system controls the adjustment of colors. In most situations, setting the Color Correction to Auto generates preferred colors for the documents.

How can I match a particular color (such as a corporate logo)?

From the printer Quality menu, nine types of Color Samples sets are available. These sets are also available from the Color Samples page of the Embedded Web Server. Selecting any sample set generates multiple-page prints consisting of hundreds of colored boxes. Each box contains a CMYK or RGB combination, depending on the table selected. The observed color of each box is obtained by passing the CMYK or RGB combination labeled on the box through the selected color conversion table.

By examining Color Samples sets, you can identify the box with color closest to the color being matched. The color combination labeled on the box can then be used for modifying the color of the object in a software program. For more information, see the software program Help topics. Manual color correction may be necessary to use the selected color conversion table for the particular object.

Selecting which Color Samples set to use for a particular color-matching problem depends on:

- The Color Correction setting being used (Auto, Off, or Manual)
- The type of object being printed (text, graphics, or images)
- How the color of the object is specified in the software program (RGB or CMYK combinations)

If the software program does not specify colors with RGB or CMYK combinations, then the Color Samples pages are not useful. Additionally, some software programs adjust the RGB or CMYK combinations specified in the program through color management. In these situations, the printed color may not be an exact match of the Color Samples pages.

The print appears tinted

Action	Yes	No
<p>Step 1</p> <p>a Perform Color Adjust. From the home screen, touch Settings > Print > Quality > Advanced Imaging > Color Adjust.</p> <p>b Print the document.</p> <p>Does the print appear tinted?</p>	Go to step 2.	The problem is solved.

Action	Yes	No
<p>Step 2</p> <p>a From the home screen, touch Settings > Print > Quality > Advanced Imaging > Color Balance.</p> <p>b Adjust the settings.</p> <p>c Print the document.</p> <p>Does the print appear tinted?</p>	Contact your dealer .	The problem is solved.

Faxing problems

Cannot send or receive faxes

Action	Yes	No
<p>Step 1</p> <p>Resolve any error messages that appear on the display.</p> <p>Can you send or receive a fax?</p>	The problem is solved.	Go to step 2.
<p>Step 2</p> <p>Make sure that the cable connections for the following equipment are secure:</p> <ul style="list-style-type: none"> • Telephone • Handset • Answering machine <p>Can you send or receive a fax?</p>	The problem is solved.	Go to step 3.
<p>Step 3</p> <p>Check for a dial tone.</p> <ul style="list-style-type: none"> • Call the fax number to check if it is working properly. • If you are using the On Hook Dial feature, then turn up the volume to check if you hear a dial tone. <p>Can you hear a dial tone?</p>	Go to step 5.	Go to step 4.

Action	Yes	No
<p>Step 4 Check the telephone wall jack.</p> <ul style="list-style-type: none"> a Connect the analog telephone directly to the wall jack. b Listen for a dial tone. c If you do not hear a dial tone, then use a different telephone cable. d If you still do not hear a dial tone, then connect the analog telephone to a different wall jack. e If you hear a dial tone, then connect the printer to that wall jack. <p>Can you send or receive a fax?</p>	<p>The problem is solved.</p>	<p>Go to step 5.</p>
<p>Step 5 Check if the printer is connected to an analog phone service or to the correct digital connector.</p> <ul style="list-style-type: none"> • If you are using an Integrated Services for Digital Network (ISDN) telephone service, then connect to an analog telephone port of an ISDN terminal adapter. For more information, contact your ISDN provider. • If you are using DSL, then connect to a DSL filter or router that supports analog use. For more information, contact your DSL provider. • If you are using a private branch exchange (PBX) telephone service, then make sure that you are connecting to an analog connection on the PBX. If none exists, then consider installing an analog telephone line for the fax machine. <p>Can you send or receive a fax?</p>	<p>The problem is solved.</p>	<p>Go to step 6.</p>
<p>Step 6 Temporarily disconnect other equipment and disable other telephone services.</p> <ul style="list-style-type: none"> a Disconnect other equipment (such as answering machines, computers, modems, or telephone line splitters) between the printer and the telephone line. b Disable call waiting and voice mail. For more information, contact your telephone company. <p>Can you send or receive a fax?</p>	<p>The problem is solved.</p>	<p>Go to step 7.</p>
<p>Step 7 Scan the original document one page at a time.</p> <ul style="list-style-type: none"> a Dial the fax number. b Scan the document. <p>Can you send or receive a fax?</p>	<p>The problem is solved.</p>	<p>Contact your dealer.</p>

Can receive but not send faxes

Action	Yes	No
<p>Step 1 Load the original document properly into the ADF tray or on the scanner glass.</p> <p>Can you send faxes?</p>	The problem is solved.	Go to step 2.
<p>Step 2 Set up the shortcut number properly.</p> <ul style="list-style-type: none"> • Check if the shortcut number is set for the telephone number that you want to dial. • Dial the telephone number manually. <p>Can you send faxes?</p>	The problem is solved.	Contact your dealer .

Can send but not receive faxes

Action	Yes	No
<p>Step 1 Make sure that the paper source is not empty.</p> <p>Can you receive faxes?</p>	The problem is solved.	Go to step 2.
<p>Step 2 Check the ring count delay settings. From the home screen, touch Settings > Fax > Fax Setup > Fax Receive Settings > Rings to Answer.</p> <p>Can you receive faxes?</p>	The problem is solved.	Go to step 3.
<p>Step 3 If the printer is printing blank pages, then see “Blank or white pages” on page 229.</p> <p>Can you receive faxes?</p>	The problem is solved.	Contact your dealer .

Poor fax print quality

Action	Yes	No
<p>Step 1 Make sure that there are no print quality defects.</p> <p>a From the control panel, touch Settings > Troubleshooting > Print Quality Test Pages.</p> <p>b Correct any print quality defects. For more information, see “Print quality is poor” on page 229.</p> <p>Is the fax print quality satisfactory?</p>	<p>The problem is solved.</p>	<p>Go to step 2.</p>
<p>Step 2 Decrease the incoming fax transmission speed.</p> <p>a From the control panel, touch Settings > Fax > Fax Setup > Fax Receive Settings > Admin Controls.</p> <p>b In the Max Speed menu, select a lower transmission speed.</p> <p>Is the fax print quality satisfactory?</p>	<p>The problem is solved.</p>	<p>Contact your dealer.</p>

Scanning problems

Cannot scan from a computer

Action	Yes	No
<p>Step 1</p> <p>a Turn off the printer, wait for about 10 seconds, and then turn it back on.</p> <p>b Resend the scan job.</p> <p>Can you send the scan job?</p>	<p>The problem is solved.</p>	<p>Go to step 2.</p>
<p>Step 2</p> <p>a Make sure that the cables between the printer and the print server are secure. For more information, see the setup documentation that came with the printer.</p> <p>b Resend the scan job.</p> <p>Can you send the scan job?</p>	<p>The problem is solved.</p>	<p>Contact your dealer.</p>

Partial copies of document or photo

Action	Yes	No
<p>Step 1</p> <p>a Make sure that the document or photo is loaded facedown on the upper left corner of the scanner glass.</p> <p>b Copy the document or photo.</p> <p>Is the document or photo copied correctly?</p>	The problem is solved.	Go to step 2.
<p>Step 2</p> <p>a Match the paper size setting and the paper loaded in the tray.</p> <p>b Copy the document or photo.</p> <p>Is the document or photo copied correctly?</p>	The problem is solved.	Contact your dealer .

Poor copy quality

Action	Yes	No
<p>Step 1</p> <p>a Clean the scanner glass and the ADF glass with a damp, soft, lint-free cloth. If your printer has a second ADF glass inside the ADF, then also clean that glass.</p> <p>For more information, see “Cleaning the scanner” on page 145.</p> <p>b Make sure that the document or photo is loaded facedown on the upper left corner of the scanner glass.</p> <p>c Copy the document or photo.</p> <p>Is the copy quality satisfactory?</p>	The problem is solved.	Go to step 2.
<p>Step 2</p> <p>a Check the quality of the original document or photo.</p> <p>b Adjust the scan quality settings.</p> <p>c Copy the document or photo.</p> <p>Is the copy quality satisfactory?</p>	The problem is solved.	Contact your dealer .

Scan job was not successful

Action	Yes	No
<p>Step 1 Check the cable connections.</p> <ul style="list-style-type: none"> a Make sure that the Ethernet or USB cable is securely connected to the computer and the printer. b Resend the scan job. <p>Is the scan job successful?</p>	The problem is solved.	Go to step 2.
<p>Step 2 Check the file that you want to scan.</p> <ul style="list-style-type: none"> a Make sure that the file name is not already used in the destination folder. b Make sure that the document or photo you want to scan is not open in another application. c Resend the scan job. <p>Is the scan job successful?</p>	The problem is solved.	Go to step 3.
<p>Step 3 a Make sure that the Append time stamp or the Overwrite existing file check box is selected in the destination configuration settings.</p> <ul style="list-style-type: none"> b Resend the scan job. <p>Is the scan job successful?</p>	The problem is solved.	

Scanner does not close

Action	Yes	No
<p>Remove obstructions that keep the scanner unit open.</p> <p>Did the scanner unit close correctly?</p>	The problem is solved.	Contact your dealer .

Scanning takes too long or freezes the computer

Action	Yes	No
<p>Close all applications that are interfering with the scan.</p> <p>Does scanning take too long or freeze the computer?</p>	Contact your dealer .	The problem is solved.

Scanner does not respond

Action	Yes	No
<p>Step 1</p> <p>a Check if the power cord is connected properly to the printer and the electrical outlet.</p> <p> CAUTION—POTENTIAL INJURY: To avoid the risk of fire or electrical shock, connect the power cord to an appropriately rated and properly grounded electrical outlet that is near the product and easily accessible.</p> <p>b Copy or scan the document.</p> <p>Is the scanner responding?</p>	The problem is solved.	Go to step 2.
<p>Step 2</p> <p>a Check if the printer is turned on.</p> <p>b Resolve any error messages that appear on the display.</p> <p>c Copy or scan the document.</p> <p>Is the scanner responding?</p>	The problem is solved.	Go to step 3.
<p>Step 3</p> <p>a Turn off the printer, wait for about 10 seconds, and then turn the printer on.</p> <p>b Copy or scan the document.</p> <p>Is the scanner responding?</p>	The problem is solved.	Contact your dealer .

Adjusting scanner registration

- From the home screen, touch **Settings > Device > Maintenance > Configuration Menu > Scanner Configuration > Scanner Manual Registration**.
- In the Print Quick Test menu, touch **Start**.
- Place the Print Quick Test page on the scanner glass, and then touch **Flatbed Registration**.
- In the Copy Quick Test menu, touch **Start**.
- Compare the Copy Quick Test page with the original document.

Note: If the margins of the test page are different from the original document, then adjust Left Margin and Top Margin.
- Repeat [step 4](#) and [step 5](#) until the margins of the Copy Quick Test page closely match the original document.

Adjusting ADF registration

- From the home screen, touch **Settings > Device > Maintenance > Configuration Menu > Scanner Configuration > Scanner Manual Registration**.
- In the Print Quick Test menu, touch **Start**.

3 Place the Print Quick Test page on the ADF tray.

4 Touch **Front ADF Registration** or **Rear ADF Registration**.

Notes:

- To align Front ADF Registration, place the test page faceup, short edge first into the ADF.
- To align Rear ADF Registration, place the test page facedown, short edge first into the ADF.

5 In the Copy Quick Test menu, touch **Start**.

6 Compare the Copy Quick Test page with the original document.

Note: If the margins of the test page are different from the original document, then adjust Horizontal Adjust and Top Margin.

7 Repeat [step 5](#) and [step 6](#) until the margins of the Copy Quick Test page closely match the original document.

Contacting your dealer

Before contacting your dealer, make sure to have the following information:

- Printer problem
- Error message
- Printer model type and serial number

Visit the place where you purchased your printer.

Upgrading and migrating

Hardware

Available internal options

- Memory card
 - DDR3 DIMM
 - Flash memory
 - Fonts
 - Application cards
 - Forms and Bar Code
 - PRESCRIBE
 - IPDS
- Internal solutions port (ISP)

Note: Some options are available only in some printer models. For more information, contact the place where you purchased the printer.

Installing a memory card

CAUTION—SHOCK HAZARD: To avoid the risk of electrical shock, if you are accessing the controller board or installing optional hardware or memory devices sometime after setting up the printer, then turn the printer off, and unplug the power cord from the electrical outlet before continuing. If you have any other devices attached to the printer, then turn them off as well, and unplug any cables going into the printer.

- 1 Turn off the printer, and then unplug the power cord from the electrical outlet.
- 2 Using a flat-head screwdriver, remove the controller board access cover.

Warning—Potential Damage: Controller board electronic components are easily damaged by static electricity. Touch a metal surface on the printer before touching any controller board components or connectors.

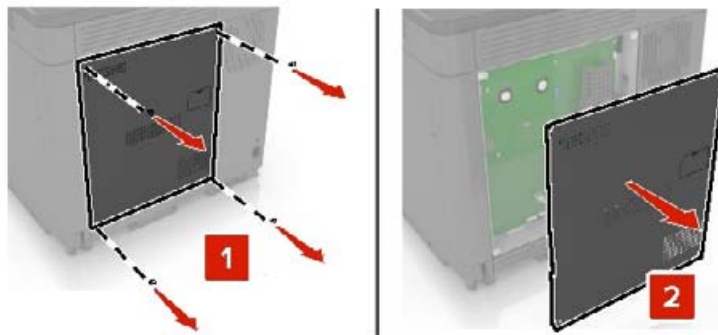

- 3 Unpack the memory card.

Warning—Potential Damage: Avoid touching the connection points along the edge of the card.

- 4 Insert the memory card until it *clicks* into place.

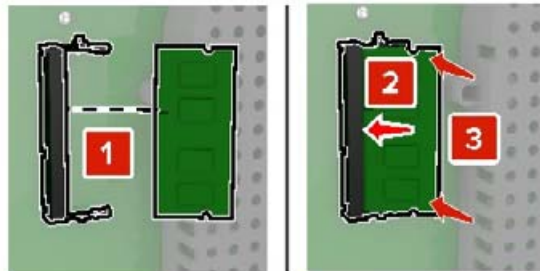

- 5 Reattach the access cover.

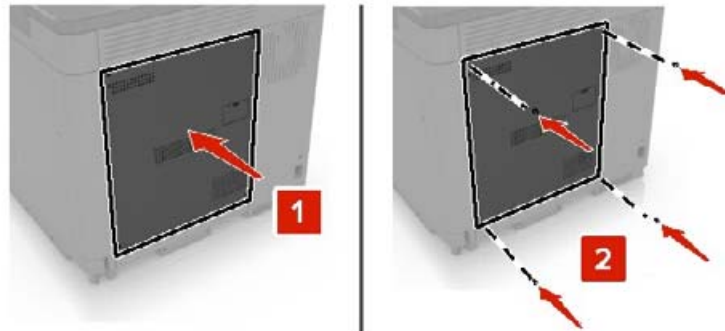

- 6 Connect the power cord to the electrical outlet, and then turn on the printer.

CAUTION—POTENTIAL INJURY: To avoid the risk of fire or electrical shock, connect the power cord to an appropriately rated and properly grounded electrical outlet that is near the product and easily accessible.

Installing an internal solutions port

CAUTION—SHOCK HAZARD: To avoid the risk of electrical shock, if you are accessing the controller board or installing optional hardware or memory devices sometime after setting up the printer, then turn the printer off, and unplug the power cord from the electrical outlet before continuing. If you have any other devices attached to the printer, then turn them off as well, and unplug any cables going into the printer.

- 1 Turn off the printer, and then unplug the power cord from the electrical outlet.
- 2 Using a flat-head screwdriver, remove the controller board access cover.

Warning—Potential Damage: Controller board electronic components are easily damaged by static electricity. Touch a metal surface on the printer before touching any controller board components or connectors.

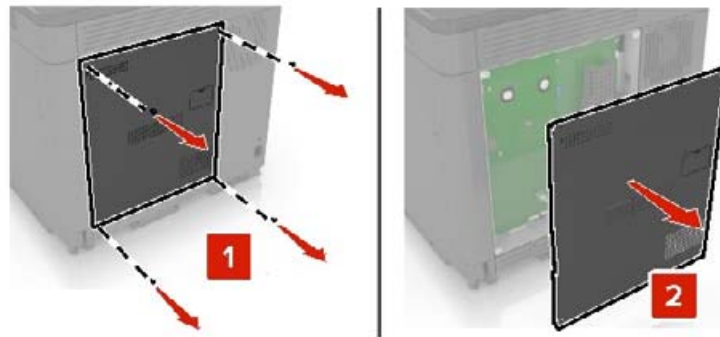

3 Unpack the internal solutions port (ISP) kit.

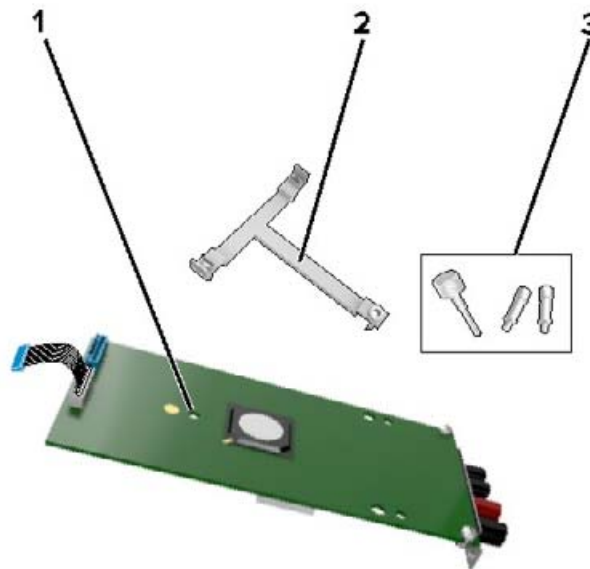

1	ISP
2	Mounting bracket
3	Thumbscrews

4 If necessary, remove the printer hard disk.

5 Insert the bracket into the board until it *clicks* into place.

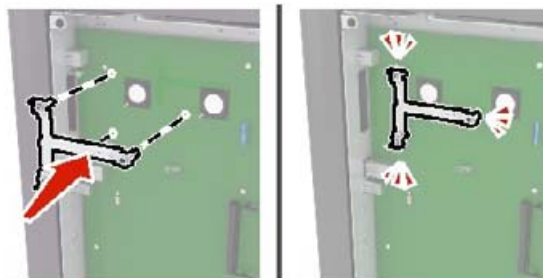

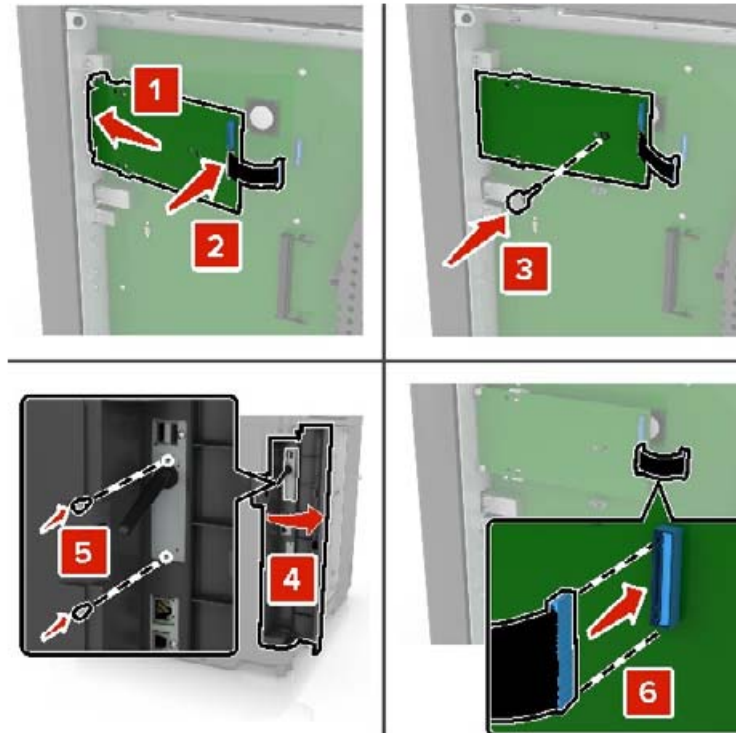
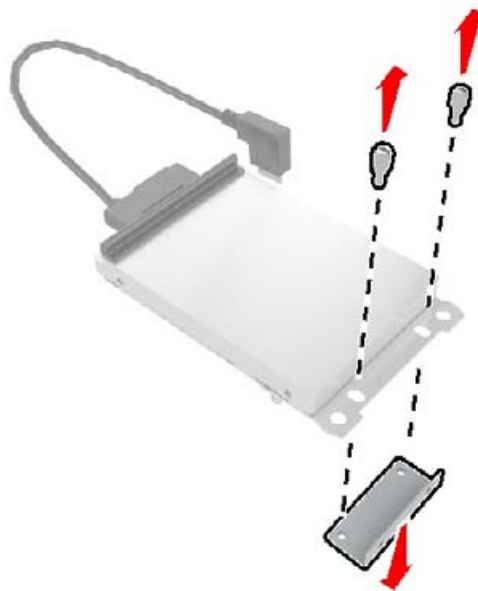
6 Attach the ISP to the bracket.**7** If necessary, attach the hard disk to the ISP.**a** Remove the hard disk bracket.**b** Connect the hard disk to the ISP.

Warning—Potential Damage: Do not touch or press the center of the hard disk.

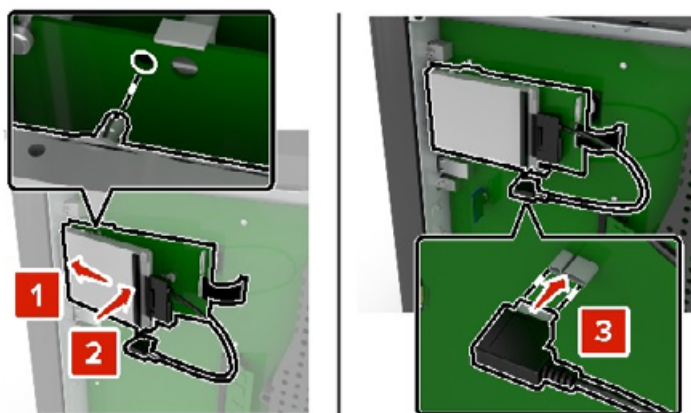

8 Reattach the access cover.

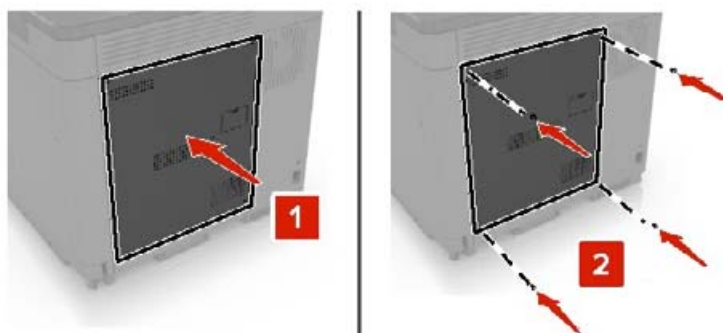

9 Connect the power cord to the electrical outlet, and then turn on the printer.

⚠ CAUTION—POTENTIAL INJURY: To avoid the risk of fire or electrical shock, connect the power cord to an appropriately rated and properly grounded electrical outlet that is near the product and easily accessible.

Installing an optional card

⚠ CAUTION—SHOCK HAZARD: To avoid the risk of electrical shock, if you are accessing the controller board or installing optional hardware or memory devices sometime after setting up the printer, then turn the printer off, and unplug the power cord from the electrical outlet before continuing. If you have any other devices attached to the printer, then turn them off as well, and unplug any cables going into the printer.

1 Turn off the printer, and then unplug the power cord from the electrical outlet.

2 Using a flat-head screwdriver, remove the controller board access cover.

Warning—Potential Damage: Controller board electronic components are easily damaged by static electricity. Touch a metal surface on the printer before touching any components or connectors.

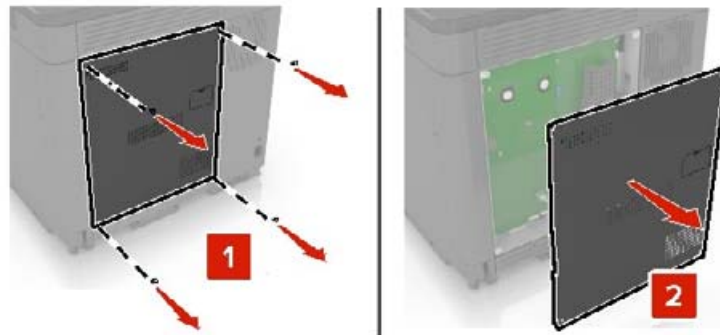

3 Unpack the optional card.

Warning—Potential Damage: Avoid touching the connection points along the edge of the card.

4 Push the card firmly into place.

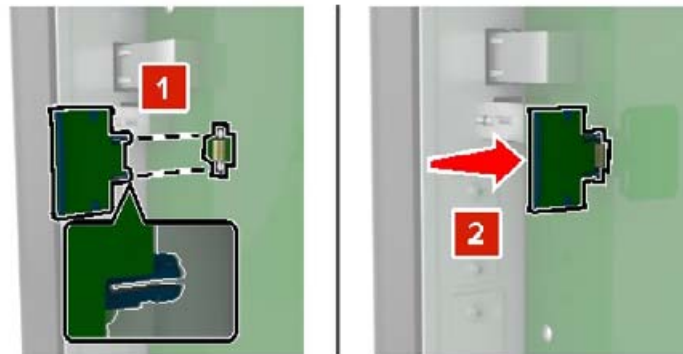

Note: The entire length of the connector on the card must touch and be flush against the controller board.

Warning—Potential Damage: Improper installation of the card may cause damage to the card and the controller board.

5 Reattach the access cover.

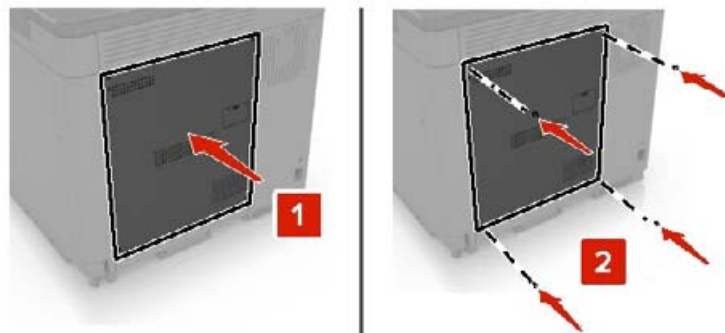

6 Connect the power cord to the electrical outlet, and then turn on the printer.

⚠ CAUTION—POTENTIAL INJURY: To avoid the risk of fire or electrical shock, connect the power cord to an appropriately rated and properly grounded electrical outlet that is near the product and easily accessible.

Installing a printer hard disk

⚠ CAUTION—SHOCK HAZARD: To avoid the risk of electrical shock, if you are accessing the controller board or installing optional hardware or memory devices sometime after setting up the printer, then turn the printer off, and unplug the power cord from the electrical outlet before continuing. If you have any other devices attached to the printer, then turn them off as well, and unplug any cables going into the printer.

- 1 Turn off the printer, and then unplug the power cord from the electrical outlet.
- 2 Using a flat-head screwdriver, remove the controller board access cover.

Warning—Potential Damage: Controller board electronic components are easily damaged by static electricity. Touch a metal surface on the printer before touching any controller board components or connectors.

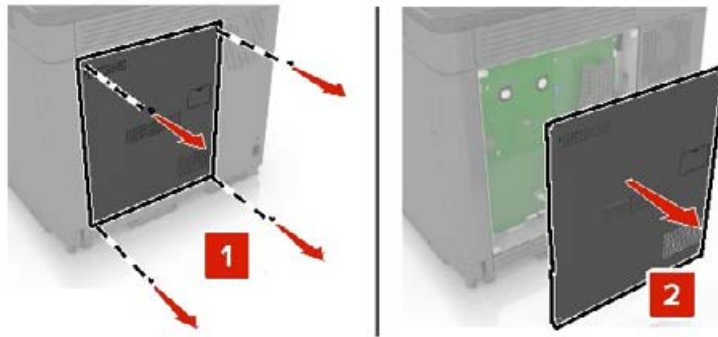

- 3 Unpack the hard disk.
- 4 Attach the hard disk to the controller board.

Warning—Potential Damage: Do not touch or press the center of the hard disk.

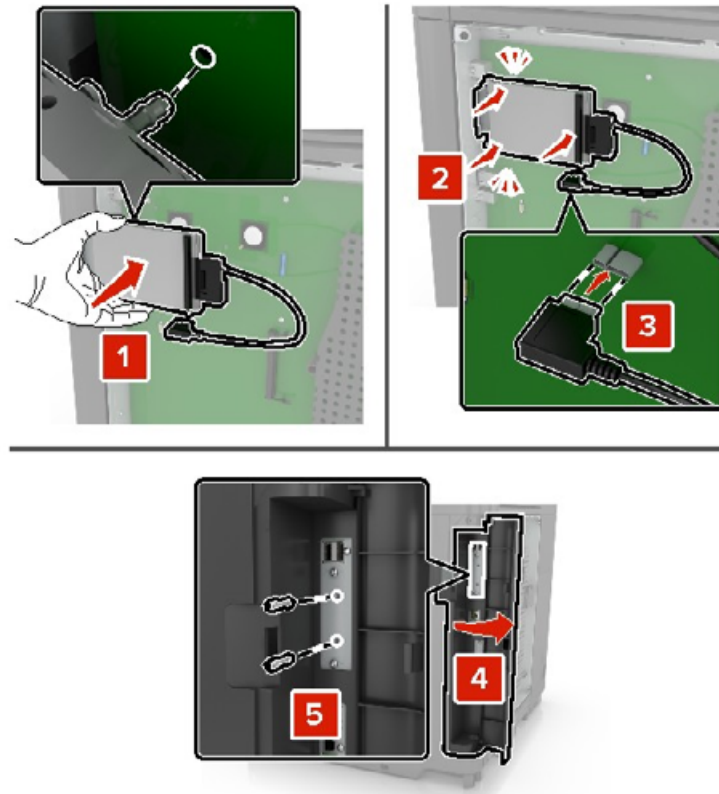

If an internal solutions port (ISP) is installed, then do the following:

- a Remove the hard disk bracket.

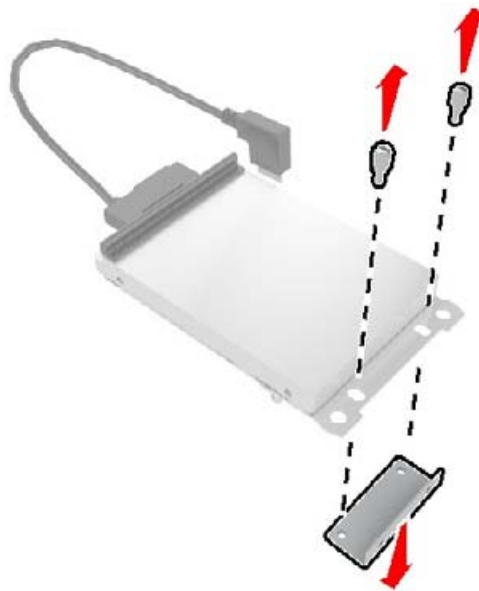

- b** Attach the hard disk to the ISP.

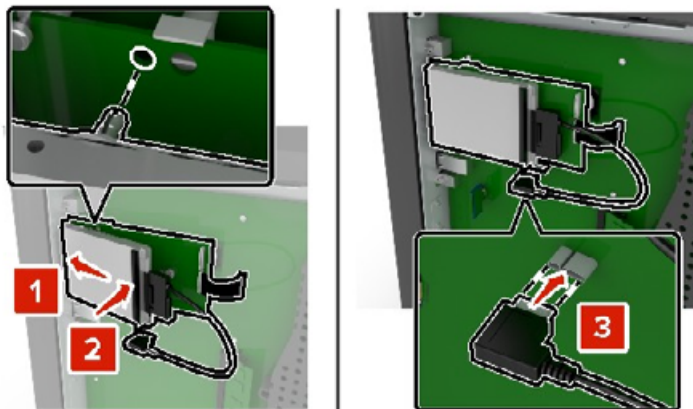

- 5** Reattach the access cover.

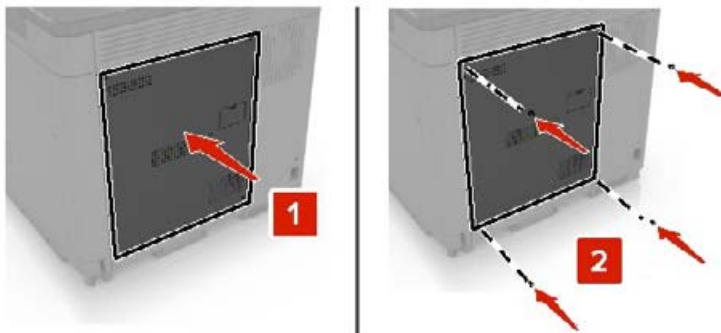

- 6** Connect the power cord to the electrical outlet, and then turn on the printer.

⚠ CAUTION—POTENTIAL INJURY: To avoid the risk of fire or electrical shock, connect the power cord to an appropriately rated and properly grounded electrical outlet that is near the product and easily accessible.

Installing optional trays

⚠ CAUTION—SHOCK HAZARD: To avoid the risk of electrical shock, if you are accessing the controller board or installing optional hardware or memory devices sometime after setting up the printer, then turn the printer off, and unplug the power cord from the electrical outlet before continuing. If you have any other devices attached to the printer, then turn them off as well, and unplug any cables going into the printer.

⚠ CAUTION—TIPPING HAZARD: Installing one or more options on your printer or MFP may require a caster base, furniture, or other feature to prevent instability causing possible injury. For more information on supported configurations, contact the place where you purchased the printer.

- 1** Turn off the printer.
- 2** Unplug the power cord from the electrical outlet, and then from the printer.
- 3** Unpack the optional tray, and then remove all packing material.

4 Lift the printer using the side and rear handles.

⚠ CAUTION—POTENTIAL INJURY: If the printer weight is greater than 20 kg (44 lb), then it may require two or more people to lift it safely.

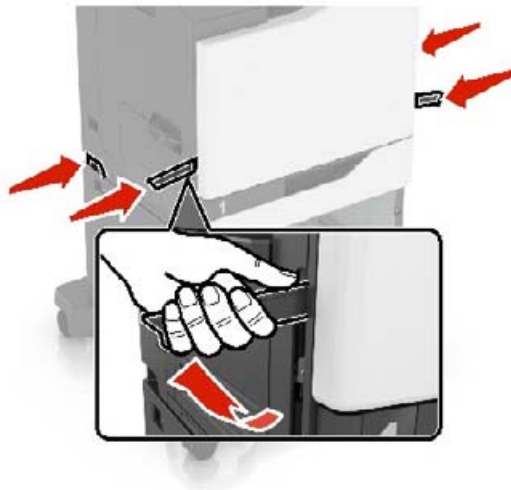

Note: If optional trays are already installed, then unlock them from the printer before lifting the printer. Do not try to lift the printer and trays at the same time.

5 Align the printer with the optional tray, and then lower the printer until it *clicks* into place.

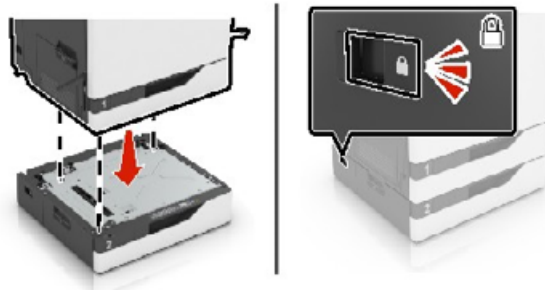

6 Connect the power cord to the printer, and then to the electrical outlet.

⚠ CAUTION—POTENTIAL INJURY: To avoid the risk of fire or electrical shock, connect the power cord to an appropriately rated and properly grounded electrical outlet that is near the product and easily accessible.

7 Turn on the printer.

If necessary, manually add the tray in the print driver to make it available for print jobs. For more information, see [“Adding available options in the print driver” on page 277](#).

When installing more than one hardware option, follow this order of installation.

- Caster base
- Optional 2200-sheet tray
- Optional 550-sheet tray or envelope tray

- Printer
- Staple finisher

Installing the keyboard tray

- 1 Turn off the printer.
- 2 Open door A.

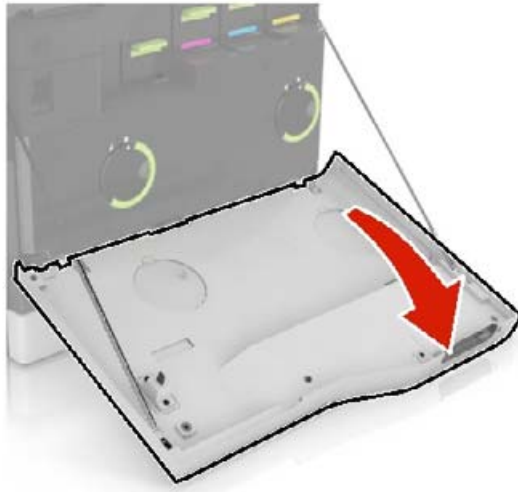

- 3 Remove the keyboard attach cover.

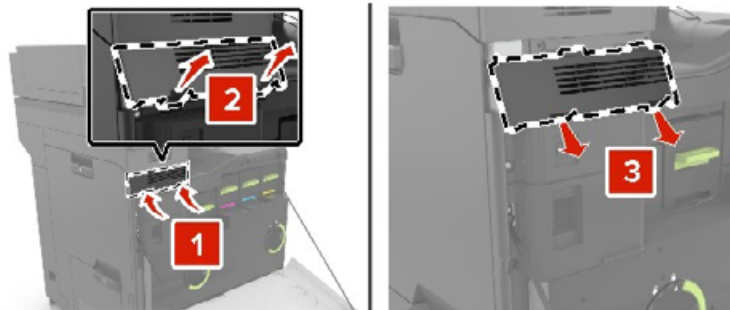

- 4 Unpack the keyboard tray.

5 Attach the keyboard to the base.

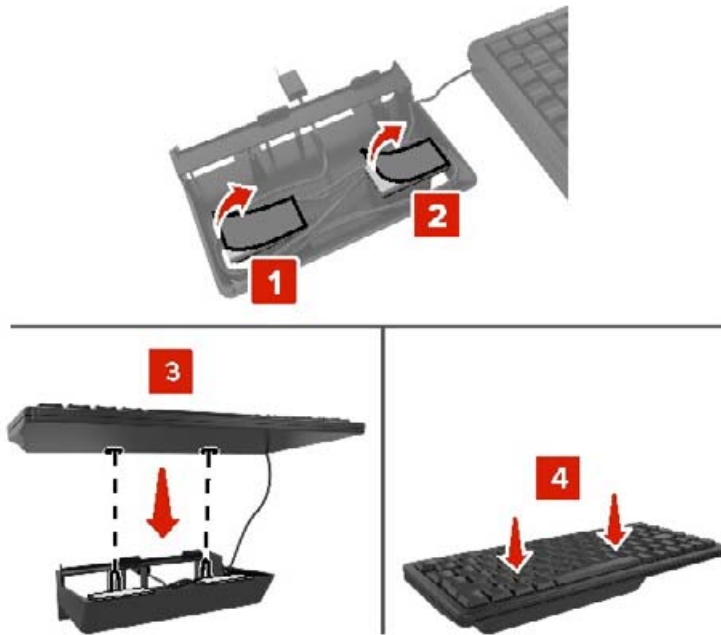

6 Insert the keyboard tray.

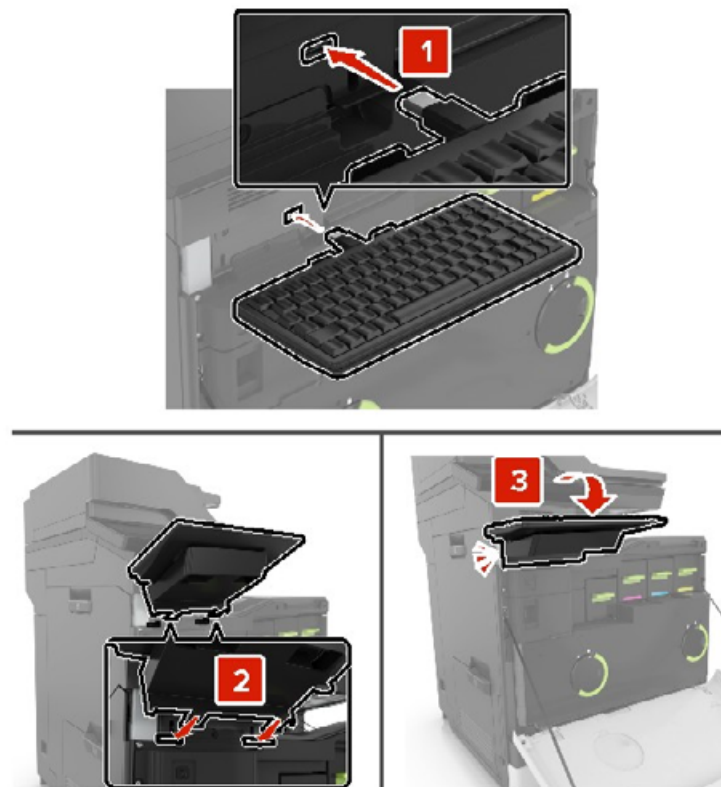

7 Close door A.

8 Turn on the printer.

Installing the staple finisher

- 1 Turn off the printer.
- 2 Open door C.

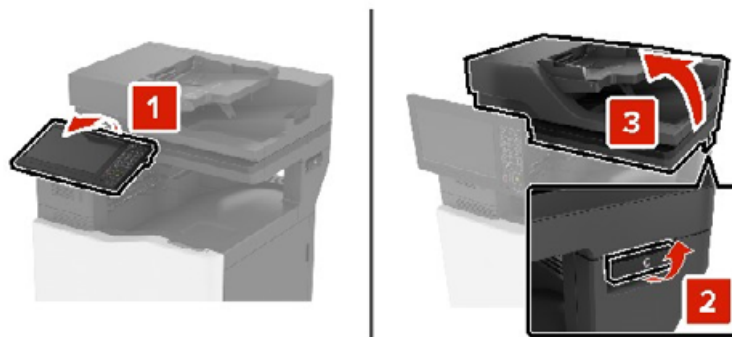

- 3 Remove the paper bail.

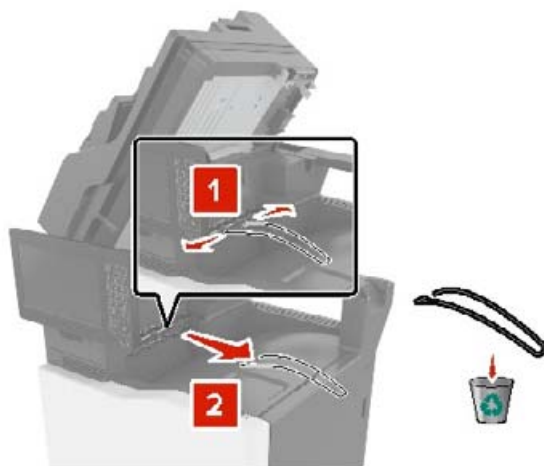

4 Remove the paper transport and staple finisher connector covers.

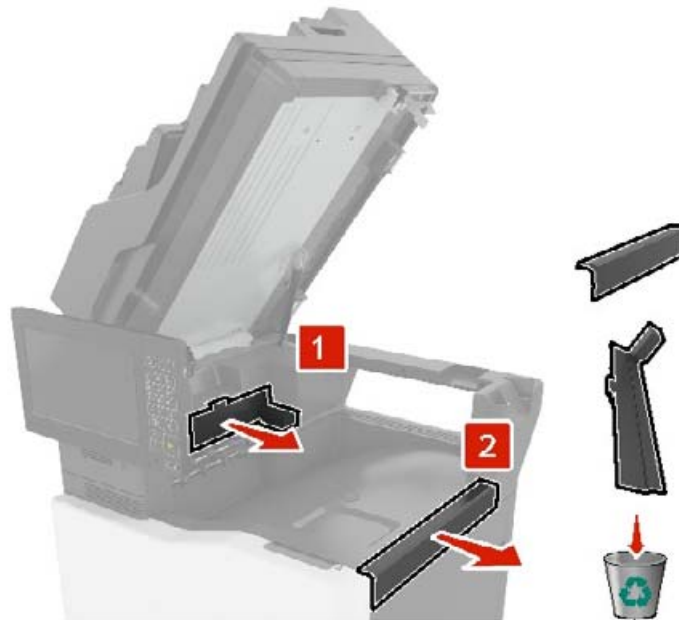

5 Unpack the staple finisher.

6 Insert the staple finisher until it *clicks* into place.

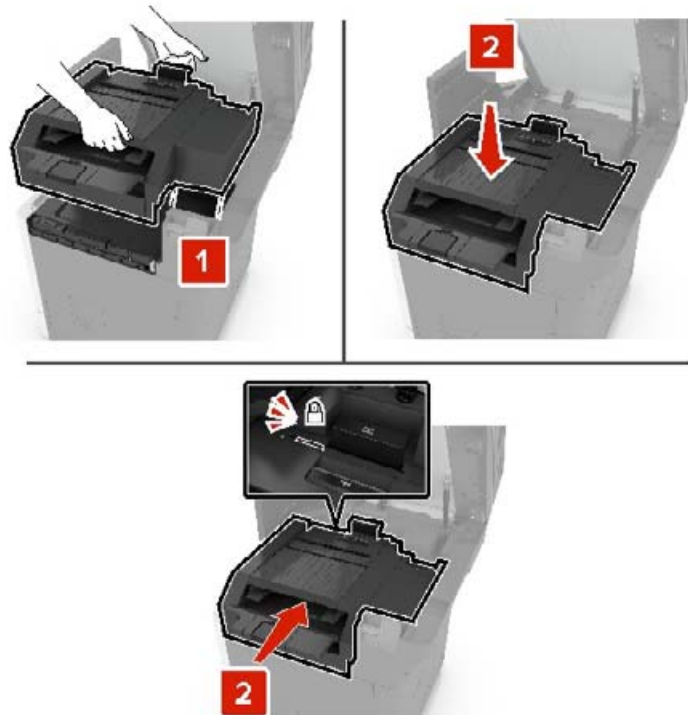

7 Close door C.

 **CAUTION—PINCH HAZARD:** To avoid the risk of a pinch injury, keep hands clear of the labeled area when closing door C.

8 Turn on the printer.

Installing the multiposition staple, hole punch finisher

 **CAUTION—TIPPING HAZARD:** Installing one or more options on your printer or MFP may require a caster base, furniture, or other feature to prevent instability causing possible injury. For more information on supported configurations, contact the place where you purchased the printer.

- 1 From the control panel, press and hold the power button for 5 seconds to turn off the printer.
- 2 Unplug the power cord from the electrical outlet, and then from the printer.
- 3 Lock the caster base wheels to keep the printer from moving.

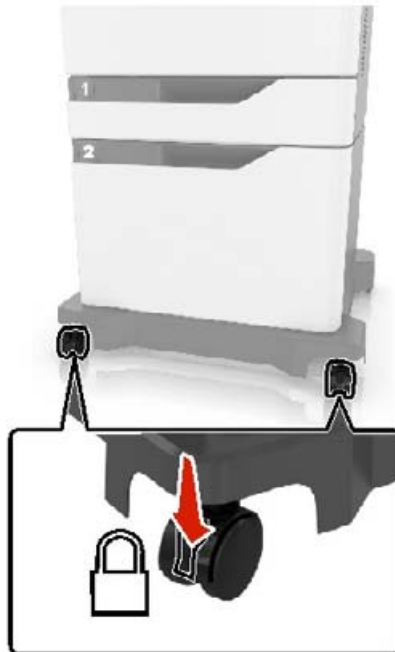

4 Open the covers at the side of the caster base.



5 Open door C.

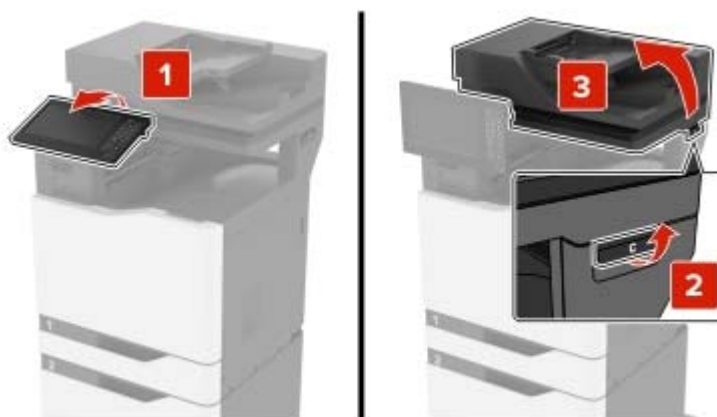

6 Remove the paper bail.

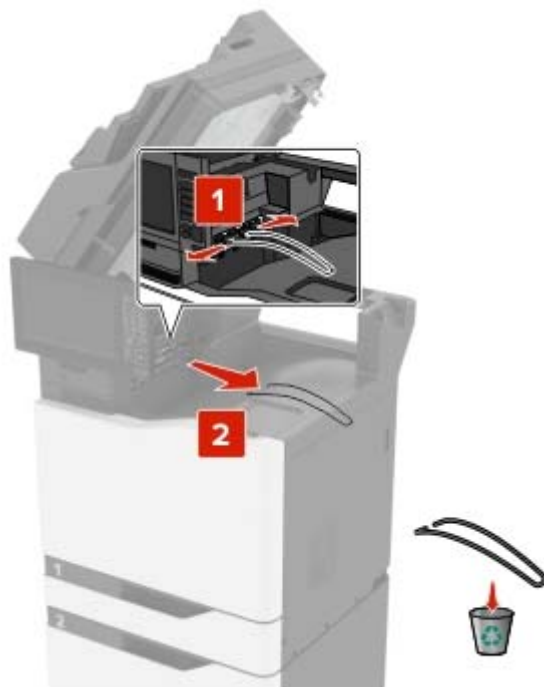

7 Remove the covers.

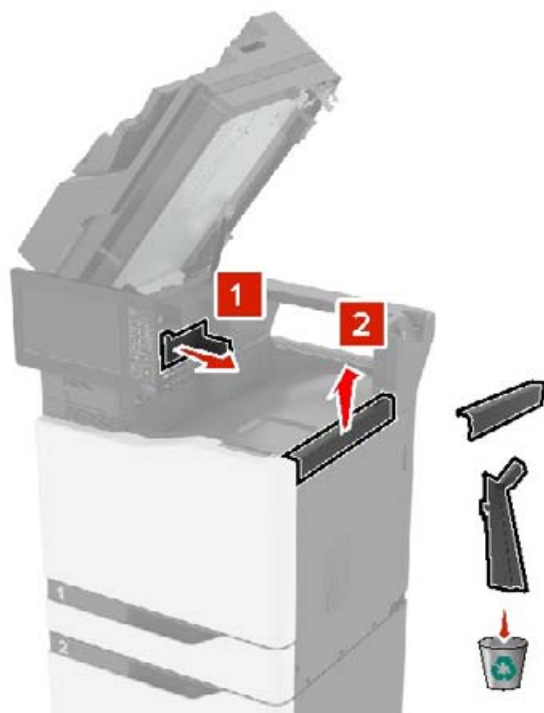

8 Unpack the paper transport, and then remove the pieces of tape.

9 Lift, and then align the paper transport to the printer.

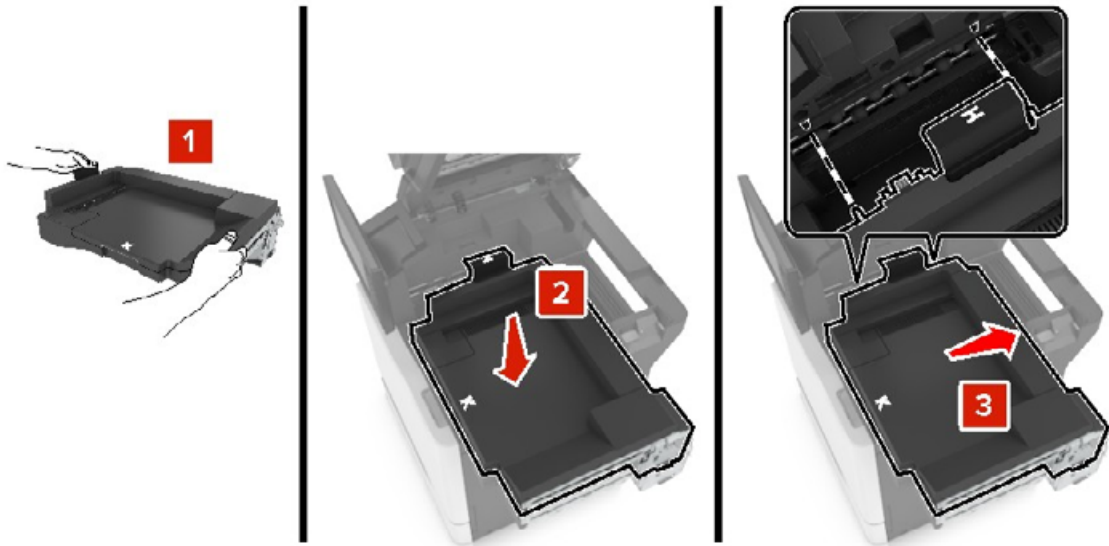

10 Firmly push the paper transport until it *clicks* into place.

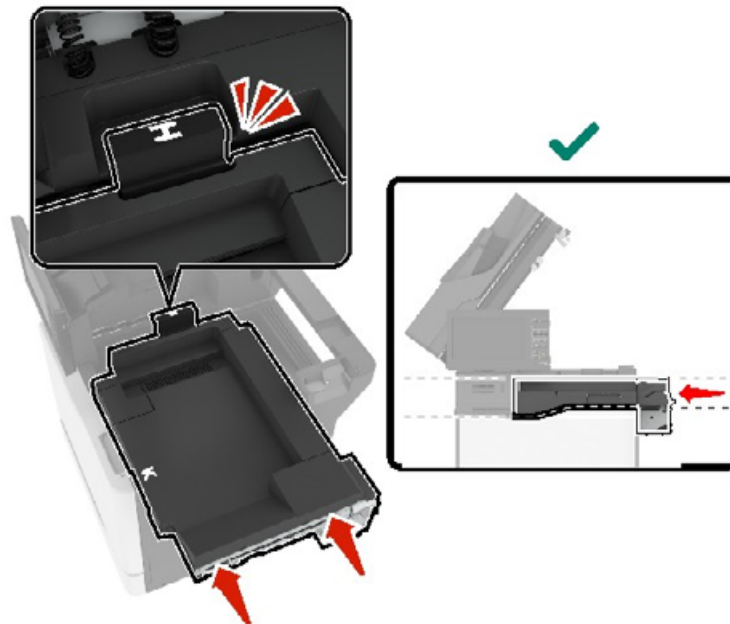

11 Close door C.



CAUTION—PINCH HAZARD: To avoid the risk of a pinch injury, keep hands clear of the labeled area when closing door C.



12 Unpack the multiposition staple, hole punch finisher, and then remove the pieces of tape.

13 On a flat, sturdy, and stable surface, align the finisher to the printer.

Note: Avoid installing the finisher on a carpeted surface.



- 14** Push the finisher to the printer by applying pressure at the bottom of the finisher until it *clicks* into place.



Check if the finisher and printer are properly locked by pulling hard the finisher away from the printer. If the finisher detaches from the printer, then repeat [step 13](#) through [step 14](#) until they are properly locked.

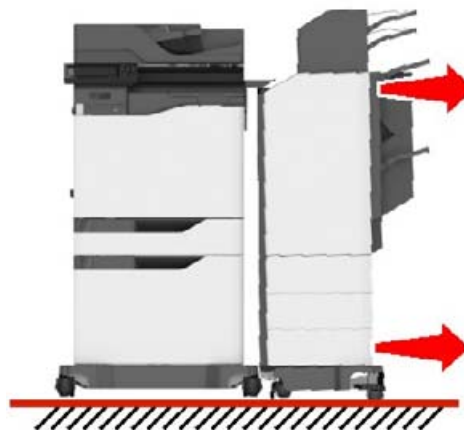

15 When the finisher is locked, do the following:

- a** Open the bottom front door of the finisher.

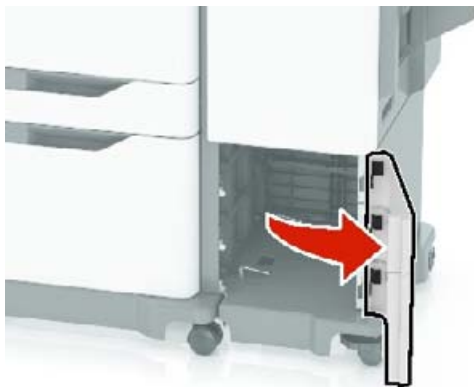

- b** Turn the levers of the finisher counterclockwise until the levers are loose.

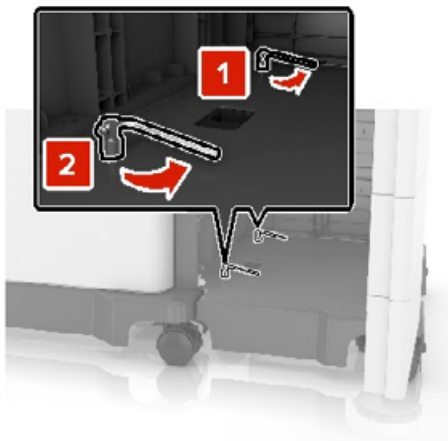

- c** Close the door.

- 16** Check the gap between the printer and the finisher.

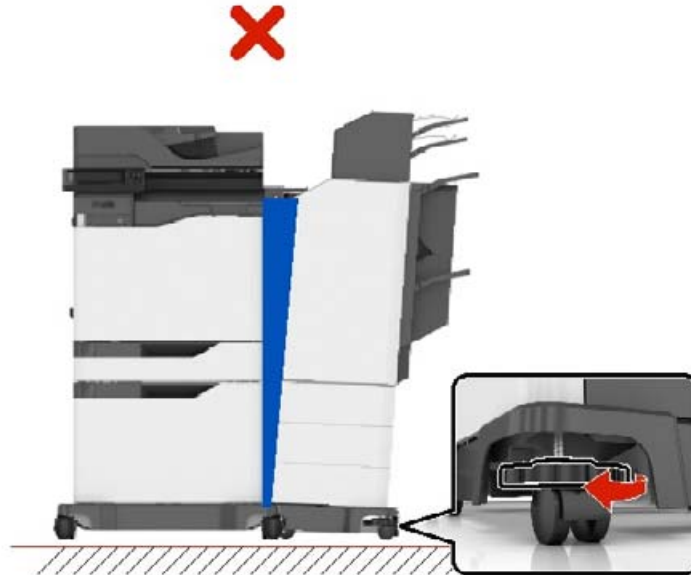

If the gap is uneven, then do either of the following:

- a** To fix the gap at the top, rotate the side wheels of the finisher clockwise.
 - b** To fix the gap at the bottom, rotate the side wheels of the finisher counterclockwise.
- 17** Connect the power cords to the finisher and the printer, and then connect them to a properly grounded electrical outlet.
- CAUTION—POTENTIAL INJURY:** To avoid the risk of fire or electrical shock, connect the power cord to an appropriately rated and properly grounded electrical outlet that is near the product and easily accessible.
- CAUTION—POTENTIAL INJURY:** Do not use this product with extension cords, multioutlet power strips, multioutlet extenders, or UPS devices. The power capacity of these types of accessories can be easily overloaded by a laser printer and may result in a risk of fire, property damage, or poor printer performance.
- 18** Turn on the printer.
- If necessary, manually add the finisher in the print driver to make it available for print jobs.
- CAUTION—PINCH HAZARD:** To avoid the risk of a pinch injury, keep hands clear of the labeled area during print jobs that use the stapler in the multiposition staple, hole punch finisher.

Software

Supported operating systems

Using the software CD, you can install the printer software on the following operating systems:

- Windows 10
- Windows 8.1
- Windows Server 2012 R2

- Windows Server 2012
- Windows 7 SP1
- Windows Server 2008 R2 SP1
- Windows Server 2008 SP2
- Windows Vista SP2
- Mac OS X version 10.7 or later
- Red Hat Enterprise Linux WS
- openSUSE Linux
- SUSE Linux Enterprise Server
- Debian GNU/Linux
- Ubuntu
- Fedora
- IBM AIX
- Oracle Solaris SPARC
- Oracle Solaris x86

Notes:

- For Windows operating systems, the print drivers and utilities are supported in both 32- and 64-bit versions.
- For drivers and utilities that are compatible with Mac OS X version 10.6 or earlier and for specific supported Linux or UNIX operating system versions, go to our website.
- For more information on software compatibility with all other operating systems, contact customer support.

Installing the printer software

Notes:

- The print driver is included in the software installer package.
- For Macintosh computers with macOS version 10.7 or later, you do not need to install the driver to print on an AirPrint-certified printer. If you want custom printing features, then download the print driver.

1 Obtain a copy of the software installer package.

- From the software CD that came with your printer.
- From our website or the place where you purchased the printer.

2 Run the installer, and then follow the instructions on the computer screen.

Adding printers to a computer

Before you begin, do one of the following:

- Connect the printer and the computer to the same network. For more information on connecting the printer to a network, see [“Connecting the printer to a Wi-Fi network” on page 141](#).
- Connect the computer to the printer. For more information, see [“Connecting a computer to the printer” on page 143](#).

- Connect the printer to the computer using a USB cable. For more information, see [“Attaching cables” on page 13](#).

Note: The USB cable is sold separately.

For Windows users

- 1 From a computer, install the print driver.

Note: For more information, see [“Installing the printer software” on page 275](#).

- 2 Open **Printers & scanners**, and then click **Add a printer or scanner**.

- 3 Depending on your printer connection, do one of the following:

- Select a printer from the list, and then click **Add device**.
- Click **Show Wi-Fi Direct printers**, select a printer, and then click **Add device**.
- Click **The printer that I want isn't listed**, and then from the Add Printer window, do the following:
 - a Select **Add a printer using a TCP/IP address or hostname**, and then click **Next**.
 - b In the “Hostname or IP address” field, type the printer IP address, and then click **Next**.

Notes:

- View the printer IP address on the printer home screen. The IP address appears as four sets of numbers separated by periods, such as 123.123.123.123.
- If you are using a proxy server, then temporarily disable it to load the web page correctly.

- c Select a print driver, and then click **Next**.
- d Select **Use the print driver that is currently installed (recommended)**, and then click **Next**.
- e Type a printer name, and then click **Next**.
- f Select a printer sharing option, and then click **Next**.
- g Click **Finish**.

For Macintosh users

- 1 From a computer, open **Printers & Scanners**.

- 2 Click **+**, and then select a printer.

- 3 From the Use menu, select a print driver.

Notes:

- To use the Macintosh print driver, select either **AirPrint** or **Secure AirPrint**.
- If you want custom printing features, then select the manufacturer print driver. To install the driver, see [“Installing the printer software” on page 275](#).

- 4 Add the printer.

Adding available options in the print driver

For Windows users

- 1 Open the printers folder.
- 2 Select the printer you want to update, and then do either of the following:
 - For Windows 7 or later, select **Printer properties**.
 - For earlier versions, select **Properties**.
- 3 Navigate to the Configuration tab, and then select **Update Now - Ask Printer**.
- 4 Apply the changes.

For Macintosh users

- 1 From System Preferences in the Apple menu, navigate to your printer, and then select **Options & Supplies**.
- 2 Navigate to the list of hardware options, and then add any installed options.
- 3 Apply the changes.

Firmware

Exporting or importing a configuration file

You can export the configuration settings of your printer into a text file, and then import the file to apply the settings to other printers.

- 1 Open a web browser, and then type the printer IP address in the address field.

Notes:

- View the printer IP address on the printer home screen. The IP address appears as four sets of numbers separated by periods, such as 123.123.123.123.
- If you are using a proxy server, then temporarily disable it to load the web page correctly.

- 2 From the Embedded Web Server, click **Export Configuration** or **Import Configuration**.
- 3 Follow the instructions on the screen.
- 4 If the printer supports applications, then do the following:
 - a Click **Apps** > select the application > **Configure**.
 - b Click **Export** or **Import**.

Updating firmware

Some applications require a minimum device firmware level to operate correctly.

For more information on updating the device firmware, contact your sales representative.

- 1 Open a web browser, and then type the printer IP address in the address field.

Notes:

- View the printer IP address on the printer home screen. The IP address appears as four sets of numbers separated by periods, such as 123.123.123.123.
- If you are using a proxy server, then temporarily disable it to load the web page correctly.

2 Click **Settings > Device > Update Firmware**.

3 Do either of the following:

- Click **Check for updates > I agree, start update**.
- Upload the flash file.
 - a** Browse to the flash file.
 - b** Click **Upload > Start**.

Notices

Product information

Product name:

DIGITAL FULL COLOR MULTIFUNCTIONAL SYSTEM
MX-C557F/MX-C607F

Machine type:

7564

Models:

5H6, 5H8

Edition notice

October 2021

The following paragraph does not apply to any country where such provisions are inconsistent with local law: THIS PUBLICATION IS PROVIDED "AS IS" WITHOUT WARRANTY OF ANY KIND, EITHER EXPRESS OR IMPLIED, INCLUDING, BUT NOT LIMITED TO, THE IMPLIED WARRANTIES OF MERCHANTABILITY OR FITNESS FOR A PARTICULAR PURPOSE. Some states do not allow disclaimer of express or implied warranties in certain transactions; therefore, this statement may not apply to you.

This publication could include technical inaccuracies or typographical errors. Changes are periodically made to the information herein; these changes will be incorporated in later editions. Improvements or changes in the products or the programs described may be made at any time.

GOVERNMENT END USERS

The Software Program and any related documentation are "Commercial Items," as that term is defined in 48 C.F.R. 2.101, "Computer Software" and "Commercial Computer Software Documentation," as such terms are used in 48 C.F.R. 12.212 or 48 C.F.R. 227.7202, as applicable. Consistent with 48 C.F.R. 12.212 or 48 C.F.R. 227.7202-1 through 227.7207-4, as applicable, the Commercial Computer Software and Commercial Software Documentation are licensed to the U.S. Government end users (a) only as Commercial Items and (b) with only those rights as are granted to all other end users pursuant to the terms and conditions herein.

Supplies

Standard supplies for this product that can be replaced by the user include toner cartridges.

Be sure to use only SHARP-specified products for the toner cartridges.

 <p>SHARP GENUINE SUPPLIES</p>	<p>For best copying results, be sure to use only Sharp Genuine Supplies which are designed, engineered, and tested to maximize the life and performance of Sharp products. Look for the Genuine Supplies label on the toner package.</p>
---	--

Noise emission levels

The following measurements were made in accordance with ISO 7779 and reported in conformance with ISO 9296.

Note: Some modes may not apply to your product.

1-meter average sound pressure, dBA	
Printing	One-sided: 55 (mono), 56 (color) Two-sided: 57 (mono), 57 (color)
Scanning	56 (7564-5H6); 55 (7564-5H8)
Copying	58 (mono); 59 (color)
Ready	16 (7564-5H6); 14 (7564-5H8)

Waste from Electrical and Electronic Equipment (WEEE) directive



The WEEE logo signifies specific recycling programs and procedures for electronic products in countries of the European Union. We encourage the recycling of our products. If you have further questions about recycling options, contact your local sales office.

India E-Waste notice



This product including components, consumables, parts and spares complies with the “India E-Waste Rules” and prohibits use of lead, mercury, hexavalent chromium, polybrominated biphenyls or polybrominated diphenyl ethers in concentrations exceeding 0.1% by weight and 0.01% by weight for cadmium, except for the exemption set in the Rule.

Lithium-ion rechargeable battery



This product may contain a coin-cell, lithium-ion rechargeable battery, which should only be removed by a trained technician. Crossed-out wheeled bin means the product should not be discarded as unsorted waste but must be sent to separate collection facilities for recovery and recycling. In the event the battery is removed, do not dispose of the battery in your household waste. There may be separate collection systems for batteries in your local community, such as a battery-recycling drop-off location. The separate collection of waste batteries assures appropriate treatment of waste including reuse and recycling and prevents any potential negative effects on human health and environment. Please responsibly dispose of the batteries.

Information on disposal

Information on the disposal of this equipment and its batteries

IF YOU WISH TO DISPOSE OF THIS EQUIPMENT, DO NOT USE THE ORDINARY WASTE BIN, AND DO NOT PUT THEM INTO A FIREPLACE!

Used electrical and electronic equipment and batteries should always be collected and treated SEPARATELY in accordance with local law.

Separate collection promotes an environment-friendly treatment, recycling of materials, and minimizing final disposal of waste. IMPROPER DISPOSAL can be harmful to human health and the environment due to certain substances! Take USED EQUIPMENT to a local, usually municipal, collection facility, where available. This

equipment contains a BATTERY which cannot be removed by the user. For battery exchange, please contact your dealer.

If in doubt about disposal, contact your local authorities or dealer and ask for the correct method of disposal.

ONLY FOR USERS IN THE EUROPEAN UNION, AND SOME OTHER COUNTRIES; FOR INSTANCE NORWAY AND SWITZERLAND: Your participation in separate collection is requested by law.



Users from PRIVATE HOUSEHOLDS are requested to use existing return facilities for used equipment. Return is free of charge.

The symbol shown above appears on electrical and electronic equipment (or the packaging) to remind the users of this. If the equipment has been used for BUSINESS PURPOSES, please contact your SHARP dealer who will inform you about take-back. You might be charged for the costs arising from take-back. Small equipment (and small quantities) might be taken back by your local collection facility. For Spain: Please contact the established collection system or your local authority for take-back of your used products.

Cartridge disposal and treatment

Regarding your used Sharp toner cartridges and other consumables from Sharp copiers/multifunctional machines, please observe that these waste products shall be treated properly according to the legal requirements in your area. We recommend to contact competent service providers (e.g. waste recycling companies) for this, and to ask local authorities for support, when necessary. For information on existing Sharp collection and recycling programs, which exist in some countries, please see our website www.sharp.eu.

Blue Angel

For Sharp Multifunctional Copiers/Printer which are certified with the German environmental label Blue Angel, please find detailed information on the websites of our respective national sales company:

<http://www.sharp.eu>

Static sensitivity notice



This symbol identifies static-sensitive parts. Do not touch the areas near these symbols without first touching a metal surface in an area away from the symbol.

To prevent damage from electrostatic discharge when performing maintenance tasks such as clearing paper jams or replacing supplies, touch any exposed metal frame of the printer before accessing or touching interior areas of the printer even if the symbol is not present.

ENERGY STAR

Any product bearing the ENERGY STAR® emblem on the product or on a start-up screen is certified to comply with Environmental Protection Agency (EPA) ENERGY STAR requirements as of the date of manufacture.



Temperature information

Operating temperature and relative humidity	10 to 32.2°C (50 to 90°F) and 15 to 80% RH 15.6 to 32.2°C (60 to 90°F) and 8 to 80% RH Maximum wet-bulb temperature ² : 22.8°C (73°F) Non-condensing environment
Printer / cartridge / imaging unit long-term storage ¹	15.6 to 32.2°C (60 to 90°F) and 8 to 80% RH Maximum wet-bulb temperature ² : 22.8°C (73°F)
Printer / cartridge / imaging unit short-term shipping	-40 to 40°C (-40 to 104°F)
¹ Supplies shelf life is approximately 2 years. This is based on storage in a standard office environment at 22°C (72°F) and 45% humidity. ² Wet-bulb temperature is determined by the air temperature and the relative humidity.	

Laser notice

The printer is certified in the U.S. to conform to the requirements of DHHS 21 CFR, Chapter I, Subchapter J for Class I (1) laser products, and elsewhere is certified as a Class I laser product conforming to the requirements of IEC 60825-1: 2014.

Class I laser products are not considered to be hazardous. The laser system and printer are designed so there is never any human access to laser radiation above a Class I level during normal operation, user maintenance, or prescribed service conditions. The printer has a non-serviceable printhead assembly that contains a laser with the following specifications:

Class: IIIb (3b) AlGaAs

Nominal output power (milliwatts): 20

Wavelength (nanometers): 755–800

Power consumption

Product power consumption

The following table documents the power consumption characteristics of the product.

Note: Some modes may not apply to your product.

Mode	Description	Power consumption (Watts)
Printing	The product is generating hard-copy output from electronic inputs.	One-sided: 825 (7564-5H6), 870 (7564-5H8) Two-sided: 775 (7564-5H6), 820 (7564-5H8)
Copy	The product is generating hard-copy output from hard-copy original documents.	650
Scan	The product is scanning hard-copy documents.	110 (7564-5H6); 115 (7564-5H8)
Ready	The product is waiting for a print job.	Higher power usage: 71.9 (7564-5H6), 68.5 (7564-5H8) Lower power usage: 63 (7564-5H6), 64.3 (7564-5H8)
Sleep Mode	The product is in a high-level energy-saving mode.	1.43 (7564-5H6); 1.46 (7564-5H8)
Hibernate	The product is in a low-level energy-saving mode.	0.3
Off	The product is plugged into an electrical outlet, but the power switch is turned off.	0.2

The power consumption levels listed in the previous table represent time-averaged measurements. Instantaneous power draws may be substantially higher than the average.

Sleep Mode

This product is designed with an energy-saving mode called *Sleep Mode*. The Sleep Mode saves energy by lowering power consumption during extended periods of inactivity. The Sleep Mode is automatically engaged after this product is not used for a specified period of time, called the *Sleep Mode Timeout*.

Factory default Sleep Mode Timeout for this product (in minutes):	1
---	---

By using the configuration menus, the Sleep Mode Timeout can be modified between 1 minute and 120 minutes. If the print speed is less than or equal to 30 pages per minute, then you can set the timeout only up to 60 minutes. Setting the Sleep Mode Timeout to a low value reduces energy consumption, but may increase the response time of the product. Setting the Sleep Mode Timeout to a high value maintains a fast response, but uses more energy.

Hibernate Mode

This product is designed with an ultra-low power operating mode called *Hibernate mode*. When operating in Hibernate Mode, all other systems and devices are powered down safely.

The Hibernate mode can be entered in any of the following methods:

- Using the Hibernate Timeout
- Using the Schedule Power modes

Factory default Hibernate Timeout for this product in all countries or regions	3 days
--	--------

The amount of time the printer waits after a job is printed before it enters Hibernate mode can be modified between one hour and one month.

Notes on EPEAT-registered imaging equipment products:

- Standby power level occurs in Hibernate or Off mode.
- The product shall automatically power down to a standby power level of ≤ 1 W. The auto standby function (Hibernate or Off) shall be enabled at product shipment.

Off mode

If this product has an off mode which still consumes a small amount of power, then to completely stop product power consumption, disconnect the power supply cord from the electrical outlet.

Total energy usage

It is sometimes helpful to estimate the total product energy usage. Since power consumption claims are provided in power units of Watts, the power consumption should be multiplied by the time the product spends in each mode in order to calculate energy usage. The total product energy usage is the sum of each mode's energy usage.

Environmental information

Please read this part carefully. It will help you to reduce your impact on the environment and help you to reduce your costs at the same time.

Saving paper

- 1** The automated duplex printing function is for printing both sides of paper automatically without turning over the paper manually. If the machine is equipped with the automated duplex printing function, set up your print settings on your computer to automatically print double-sided. Please use the automatic duplex printing function of this machine wherever possible.
- 2** By printing on recycled paper and thin 64 g/m² paper that meet the standard EN12281:2002 and similar quality standards, you can reduce the impact on the environment.

Saving energy

The ENERGY STAR® program is a voluntary scheme to promote the development and purchase of energy efficient models, which help to minimize environmental impact. Products which meet the stringent requirements of the ENERGY STAR program for both environmental benefits and the amount of energy consumption may carry the ENERGY STAR logo in case they have been registered with an ENERGY STAR program.

Regulatory notices for telecommunication terminal equipment

This section contains regulatory information pertaining to products that contain the analog facsimile card:

Regulatory Type/Model Number:

LEX-M03-002

Notice to users of the US telephone network: FCC requirements

This equipment complies with Part 68 of the FCC rules and the requirements adopted by the Administrative Council for Terminal Attachments (ACTA). On the back of this equipment is a label that contains, among other information, a product identifier in the format US:AAAEQ##TXXXX. If requested, this number must be provided to your telephone company.

This equipment uses the RJ-11C Universal Service Order Code (USOC) jack.

A plug and jack used to connect this equipment to the premises' wiring and telephone network must comply with the applicable FCC Part 68 rules and requirements adopted by the ACTA. Use a compliant telephone cord (RJ-11) that is 26 AWG or larger when connecting this product to the public switched telephone network. See your setup documentation for more information.

The Ringer Equivalence Number (REN) is used to determine the number of devices that may be connected to a telephone line. Excessive RENs on a telephone line may result in the devices not ringing in response to an incoming call. In most but not all areas, the sum of RENs should not exceed five (5.0). To be certain of the number of devices that may be connected to a line, as determined by the total RENs, contact your local telephone company. For products approved after July 23, 2001, the REN for this product is part of the product identifier that has the format US:AAAEQ##TXXXX. The digits represented by ## are the REN without a decimal point (for example, 03 is a REN of 0.3). For earlier products, the REN is shown separately on the label.

If this equipment causes harm to the telephone network, the telephone company will notify you in advance that temporary discontinuance of service may be required. If advance notice is not practical, the telephone company will notify the customer as soon as possible. You will also be advised of your right to file a complaint with the FCC.

The telephone company may make changes in its facilities, equipment, operations or procedures that could affect the operation of this equipment. If this happens, the telephone company will provide advance notice in order for you to make necessary modifications to maintain uninterrupted service.

If you experience trouble with this equipment, for repair or warranty information, contact your point of purchase. If the equipment is causing harm to the telephone network, the telephone company may request that you disconnect the equipment until the problem is resolved.

This equipment contains no user serviceable parts. For repair and warranty information, contact your point of purchase.

Connection to party line service is subject to state tariffs. Contact the state public utility commission, public service commission, or corporation commission for information.

If your home has specially wired alarm equipment connected to the telephone line, ensure the installation of this equipment does not disable your alarm equipment. If you have questions about what will disable alarm equipment, consult your telephone company or a qualified installer.

The Telephone Consumer Protection Act of 1991 makes it unlawful for any person to use a computer or other electronic device, including fax machines, to send any message unless said message clearly contains in a margin at the top or bottom of each transmitted page or on the first page of the transmission, the date and time it is sent and an identification of the business or other entity, or other individual sending the message, and the telephone number of the sending machine or such business, other entity, or individual. (The telephone number provided may not be a 900 number or any other number for which charges exceed local or long-distance transmission charges.)

See your user documentation in order to program this information into your fax machine.

Notice to users of the Canadian telephone network

This product meets the applicable Innovation, Science and Economic Development Canada technical specifications.

The Ringer Equivalence Number (REN) indicates the maximum number of devices allowed to be connected to a telephone interface. The termination of an interface may consist of any combination of devices subject only to the requirement that the sum of the RENs of all the devices not exceed five. The REN is located on the product label.

This equipment uses CA11A telephone jacks.

Avis réservé aux utilisateurs du réseau téléphonique du Canada

Ce produit est conforme aux spécifications techniques d'Innovation, Sciences et Développement économique Canada.

Le numéro REN (ringer equivalence number : numéro d'équivalence de sonnerie) indique le nombre maximum d'appareils pouvant être connectés à l'interface téléphonique. En bout de ligne, le nombre d'appareils qui peuvent être connectés n'est pas directement limité, mais la somme des REN de ces appareils ne doit pas dépasser cinq. Le numéro REN est indiqué sur l'étiquette produit.

Cet équipement utilise des prises de téléphone CA11A.

Notice to users of the New Zealand telephone network

The following are special conditions for the Facsimile User Instructions. The grant of a telepermit for any item of terminal equipment indicates only that Spark has accepted that the item complies with minimum conditions for connection to its network. It indicates no endorsement of the product by Spark, nor does it provide any sort of warranty. Above all, it provides no assurance that any item will work correctly in all respects with another item of telepermitted equipment of a different make or model, nor does it imply that any product is compatible with all of Spark's network services.

This equipment shall not be set up to make automatic calls to the Spark "111" Emergency Service.

This equipment may not provide for the effective hand-over of a call to another device connected to the same line.

This equipment should not be used under any circumstances that may constitute a nuisance to other Spark customers.

This equipment is not capable, under all operating conditions, of correct operation at the higher speeds for which it is designed. Spark will accept no responsibility should difficulties arise in such circumstances.

The decadic (or pulse) dialing on this device is unsuitable for use on the Spark network in New Zealand.

For correct operation, the total of all the Ringer Equivalence Numbers (RENs) of all parallel devices connected to the same telephone line may not exceed 5. The REN of this device is located on the label.

This device uses an RJ-11C modular connector. Contact your point of purchase if a BT adapter is required. The part number is 80D1873.

Some parameters required for compliance with Spark's telepermit requirements are dependent on the equipment associated with this device. The associated equipment shall be set to operate within the following limits for compliance to Spark's specifications:

- There shall be no more than 10 call attempts to the same number within any 30 minute period for any single manual call initiation, and
- The equipment shall go on-hook for a period of not less than 30 seconds between the end of one attempt and the beginning of the next call attempt.
- The equipment shall be set to ensure that automatic calls to different numbers are spaced such that there is not less than 5 seconds between the end of one call attempt and the beginning of another.

Japanese telecom notice

The installed optional modem is in compliance with Japanese Telecommunication Law and has been Certified by JATE, with the following Certification Number:

A11-0160001JP

	Lexmark International, Inc.
	LEX-M03-002
	A11-0160001JP

Using this product in Switzerland

This product requires a Swiss billing tone filter to be installed on any line which receives metering pulses in Switzerland.

Utilisation de ce produit en Suisse

Cet appareil nécessite l'utilisation d'un filtre de tonalité de facturation suisse devant être installé sur toute ligne recevant des impulsions de comptage en Suisse.

Verwendung dieses Produkts in der Schweiz

Für dieses Produkt muss ein schweizerischer Billing Tone Filter zur Zählzeichenübertragung für jede Leitung installiert werden, über die in der Schweiz Zeitsteuertakte übertragen werden.

Uso del prodotto in Svizzera

Questo prodotto richiede un filtro toni Billing svizzero, a installare su tutte le linee che ricevono impulsi remoti in Svizzera.

Federal Communications Commission (FCC) compliance information statement

This product has been tested and found to comply with the limits for a Class A digital device, pursuant to Part 15 of the FCC Rules. Operation is subject to the following two conditions: (1) this device may not cause harmful interference, and (2) this device must accept any interference received, including interference that may cause undesired operation.

The FCC Class A limits are designed to provide reasonable protection against harmful interference when the equipment is operated in a commercial environment. This equipment generates, uses, and can radiate radio frequency energy and, if not installed and used in accordance with the instruction manual, may cause harmful interference to radio communications. Operation of this equipment in a residential area is likely to cause harmful interference, in which case the user will be required to correct the interference at his own expense.

The manufacturer is not responsible for any radio or television interference caused by using other than recommended cables or by unauthorized changes or modifications to this equipment. Unauthorized changes or modifications could void the user's authority to operate this equipment.

Note: To assure compliance with FCC regulations on electromagnetic interference for a Class A computing device, use a properly shielded and grounded cable such as Lexmark part number 1021231 for parallel attach or 1021294 for USB attach. Use of a substitute cable not properly shielded and grounded may result in a violation of FCC regulations.

Any questions regarding this compliance information statement should be directed to:

Director of Lexmark Technology & Services
Lexmark International, Inc.
740 West New Circle Road
Lexington, KY 40550
Telephone: (859) 232-2000
E-mail: regulatory@lexmark.com

Innovation, Science and Economic Development Canada compliance statement

This Class A digital apparatus meets all requirements of the Canadian Interference-Causing Equipment Standard ICES-003.

Avis de conformité aux normes de l'Innovation, Sciences et Développement économique Canada

Cet appareil numérique de classe A est conforme aux exigences de la norme canadienne relative aux équipements pouvant causer des interférences NMB-003.

Japanese VCCI notice

製品にこのラベルが表示されている場合、
次の要件を満たしています。

この装置は、クラス A 情報技術装置です。この装置を家庭環境で使用すると電波妨害を引き起こすことがあります。この場合には使用者が適切な対策を講ずるよう要求されることがあります。 VCCI-A

この装置は、クラスA情報技術装置です。この装置を家庭環境で使用すると電波妨害を引き起こすことがあります。この場合には使用者が適切な対策を講ずるよう要求されることがあります。 VCCI-A

Notice to users of Class A products in Brazil

Este produto não é apropriado para uso em ambientes domésticos, pois poderá causar interferências eletromagnéticas que obrigam o usuário a tomar medidas necessárias para minimizar estas interferências.

European Community (EC) directives conformity

This product is in conformity with the protection requirements of EC Council directives 2014/30/EU, 2014/35/EU, and 2011/65/EU as amended by (EU) 2015/863 on the approximation and harmonization of the laws of the Member States relating to electromagnetic compatibility, safety of electrical equipment designed for use within certain voltage limits, and on the restrictions of use of certain hazardous substances in electrical and electronic equipment.

This product satisfies the Class A limits of EN 55032 and safety requirements of EN 62368-1.

United Kingdom (UK) conformity

This product is in conformity with the protection requirements of the Electromagnetic Compatibility Regulations 2016, the Electrical Equipment (Safety) Regulations 2016, and the Restriction of the Use of Certain Hazardous Substances in Electrical and Electronic Equipment Regulations 2012.

This product satisfies the Class A limits of BS EN 55032 and safety requirements of BS EN 62368-1.

Radio interference notice

Warning

This is a product that complies with the emission requirements of EN 55032 Class A limits and immunity requirements of EN 55035. This product is not intended to be used in residential/domestic environments.

This is a Class A product. In a domestic environment, this product may cause radio interference, in which case the user may be required to take adequate measures.

Index

A

- adapter plug 57
- adding a shortcut
 - copy 43
- adding contacts 20
- adding groups 21
- adding hardware options
 - print driver 277
- adding internal options
 - print driver 277
- adding printers to a computer 275
- adding shortcut
 - e-mail 52
 - fax destination 61
 - FTP address 65
- ADF feed roller
 - replacing 179
- ADF pick roller
 - replacing 177
- ADF registration
 - adjusting 251
- ADF separator roller
 - replacing 181
- adjusting
 - scanner registration 251
- adjusting ADF registration 251
- adjusting darkness
 - fax 61
- adjusting default volume
 - speaker 141
- adjusting the brightness
 - printer display 192
- adjusting the brightness of the printer display 192
- adjusting toner darkness 242
- AirPrint
 - using 35
- answering machine
 - setting up 54
- assigning printer to a ring pattern 60
- attaching cables 13
- automatic document feeder (ADF)
 - using 41, 44, 53, 64
- available internal options 253
- avoiding paper jams 193

B

- blocking junk faxes 62
- bookmarks
 - creating 19
 - creating folders for 20

C

- can send but not receive faxes 247
- canceling a print job
 - from the computer 40
 - from the printer control panel 40
- cannot open Embedded Web Server 217
- cannot scan from a computer 248
- cannot send faxes 247
- cannot send or receive faxes 245
- Card Copy
 - setting up 18
- card stock
 - loading 25
- changing resolution
 - fax 61
- changing the printer port settings after installing ISP 144
- checking the printer connectivity 218
- checking the status of parts and supplies 147
- cleaning
 - exterior of the printer 145
 - interior of the printer 145
- cleaning the printer 145
- Cleaning the Scanner 137
- cleaning the scanner 145
- collated printing does not work 220
- collating copies 42
- color correction 243
- computer
 - connecting to the printer 143
- computer, scanning to 64
- confidential print jobs
 - configuring 38
 - printing 38
- configuring daylight saving time 60
- configuring supply notifications 147
- configuring the e-mail server settings 44
- configuring the settings
 - fax speaker 141
- configuring Wi-Fi Direct 142
- connecting a computer to the printer 143
- connecting mobile device to printer 143
- connecting printer to distinctive ring service 60
- connecting the printer to a wireless network 141
- connecting to a wireless network
 - using PIN method 142
 - using Push Button method 142
- conserving supplies 192
- contacting your dealer 252
- contacts
 - adding 20
 - deleting 21
 - editing 21
- control panel
 - using 15
- copy troubleshooting
 - partial copies of documents or photos 249
 - poor copy quality 249
 - scanner does not respond 251
 - scanner unit does not close 250
- copying
 - on both sides of the paper 42
 - on letterhead 42
 - photos 41
 - using the automatic document feeder (ADF) 41
 - using the scanner glass 41
- copying different paper sizes 41
- copying from
 - selected tray 41
- copying multiple pages onto a single sheet 43

- creating a shortcut
 - copy 43
 - network folder 65
- creating bookmarks 19
- creating folders
 - for bookmarks 20
- creating shortcut
 - e-mail 52
 - fax destination 61
 - FTP address 65
- crooked print 235

D

- dark print 229
- date and time
 - fax settings 60
- daylight saving time
 - configuring 60
- deactivating the Wi-Fi network 144
- dealer
 - contacting 252
- default speaker volume
 - adjusting 141
- Defective flash detected 219
- deleting contacts 21
- deleting groups 21
- developer unit
 - replacing 148
- different paper sizes, copying 41
- directory list
 - printing 39
- distinctive ring service, fax
 - enabling 60
- documents
 - scanning to a fax server 67
- documents, printing
 - from a computer 35

E

- editing contacts 21
- editing groups 21
- emission notices 280, 290
- enabling the USB port 218
- enabling Wi-Fi Direct 143
- encrypting
 - printer hard disk 139
- enlarging copies 42
- envelope seals when printing 220

- envelopes
 - loading 25
- environmental settings 191
- erasing
 - printer memory 138
- erasing hard disk memory 138
- erasing printer memory 139
- Ethernet port 13
- exporting a configuration file
 - using the Embedded Web Server 277
- EXT port 13
- e-mail
 - sending 52
- e-mail function
 - setting up 44
- e-mail server
 - configuring 44
- e-mail service providers 44
- e-mail shortcut
 - creating 52
- e-mailing
 - using the automatic document feeder (ADF) 44
 - using the scanner glass 44

F

- factory default settings
 - restoring 139
- FAQ about color printing 243
- fax
 - forwarding 62
 - holding 62
 - setting the schedule to send 61
- fax darkness
 - adjusting 61
- fax destination shortcut
 - creating 61
- fax log
 - viewing 62
- fax resolution
 - changing 61
- fax setup
 - country- or region-specific 57
 - standard telephone line connection 54
- fax speaker
 - configuring the settings 141
- fax troubleshooting
 - cannot receive faxes 247
 - cannot send faxes 247

- cannot send or receive faxes 245
- poor print quality 248
- faxing
 - setting the date and time 60
 - using the automatic document feeder (ADF) 53
 - using the scanner glass 53
- firmware card 253
- firmware, updating 277
- flash drive
 - printing from 36
 - scanning to 66
- font sample list
 - printing 39
- forms
 - printing 35
- Forms and Favorites
 - setting up 18
- FTP address
 - creating shortcut 65
- FTP server, scanning to
 - using the control panel 65
- fuser
 - replacing 152

G

- ghost images appear on prints 230
- gray or colored background 231
- groups
 - adding 21
 - deleting 21
 - editing 21

H

- hard disk memory
 - erasing 138
- hardware options
 - installing 261
- hardware options, adding
 - print driver 277
- held jobs
 - printing 38
 - setting expiration time 38
- Hibernate mode
 - configuring 191
- holding faxes 62
- home screen
 - customizing 18

home screen icons
 displaying 18
 using 16
horizontal dark lines 238
horizontal white lines 240
humidity around the printer 283

I

icons on the home screen
 showing 18
imaging unit
 replacing 158
importing a configuration file
 using the Embedded Web
 Server 277
indicator light
 understanding the status 16
installing a memory card 253
installing a printer hard disk 259
installing an internal solutions
 port 254
installing an optional card 257
installing optional trays 261
installing options
 internal solutions port 254
 printer hard disk 259
installing the keyboard tray 263
installing the multiposition staple,
 hole punch finisher 267
installing the print driver 275
installing the printer
 software 275
installing the staple finisher 265
internal options 253
 installing 257
 memory card 253
internal options, adding
 print driver 277
internal solutions port
 installing 254

J

jam locations
 identifying 194
jam, clearing
 automatic document feeder 198
 door J 210
 door K 209
 door L 213
 door N 212
 duplex unit 201

finisher bin 204
fuser 201
multipurpose feeder 197
standard bin 200
staple cartridge 206, 214
staple finisher bin 214
trays 195

jammed pages are not
 reprinted 223
jams
 avoiding 193
job prints from the wrong
 tray 227
job prints on the wrong
 paper 227
junk faxes
 blocking 62

K

keyboard tray
 installing 263

L

letterhead
 copying on 42
light print 233
LINE port 13
linking trays 27
loading
 card stock 25
 envelopes 23
 transparencies 25
 trays 23
loading envelopes
 multipurpose feeder 25
loading paper
 multipurpose feeder 25
locating jam areas 194
locating the security slot 138

M

maintenance counter
 resetting 182
making copies 41
manual color correction 243
memory card 253
 installing 253
menu
 802.1x 124
 About this Printer 81
 Anonymous Data Collection 75

Confidential Print Setup 132
Configuration Menu 75
Copy Defaults 93
Custom Scan Sizes 92
Device 135
Disk Encryption 133
Eco-Mode 70
Erase Temporary Data Files 134
Ethernet 120
E-mail Defaults 102
E-mail Setup 101
Fax 136
Fax Mode 96
Fax Server Setup 100
Fax Setup 97
Flash Drive Print 114
Flash Drive Scan 111
FTP Defaults 107
Help 136
HTML 89
HTTP/FTP Settings 125
Image 90
IPSec 123
Job Accounting 85
Layout 81
Local Accounts 129
Login Restrictions 132
LPD Configuration 124
Manage Permissions 128
Media Types 92
Menu Settings Page 135
Miscellaneous 134
Network 136
Network Overview 116
Notifications 71
Out of Service Erase 80
PCL 88
PDF 87
PostScript 87
Power Management 74
Preferences 69
Print 135
Quality 84
Remote Operator Panel 71
Restore Factory Defaults 75
Restrict external network
 access 127
Schedule USB Devices 129
Security Audit Log 130
Setup 83
Shortcuts 135
SNMP 122

- Solutions LDAP Settings 134
- TCP/IP 121
- ThinPrint 126
- Tray Configuration 90
- Troubleshooting 137
- Universal Setup 91
- USB 126
- Visible Home Screen Icons 81
- Web Link Setup 107
- Wireless 116
- Wi-Fi Direct 119
- XPS 86
- Menu Settings Page
 - printing 17
- mobile device
 - connecting to printer 143
 - printing from 35, 36
- modifying color output 243
- mottled print and dots 235
- moving the printer 10, 190
- multiposition staple, hole punch finisher
 - installing 267
- multipurpose feeder
 - loading 25

N

- network folder
 - creating a shortcut 65
- noise emission levels 280
- nonvolatile memory
 - erasing 138
- Non-Printer Manufacturer supply 219
- non-volatile memory 139
- Not enough free space in flash memory for resources 219
- notices 280, 284, 285, 290

O

- operating systems
 - supported 274
- optional card
 - installing 257
- optional trays
 - installing 261
- options
 - firmware cards 253
 - memory card 253
 - wireless 253

- ordering
 - toner cartridges 147
- ordering supplies
 - waste toner bottle 147

P

- paper
 - Universal size setting 23
- paper jam behind door N 212
- paper jam in door B 201
- paper jam in door J 210
- paper jam in door K 209
- paper jam in door L 213
- paper jam in the automatic document feeder 198
- paper jam in the finisher bin 204
- paper jam in the multipurpose feeder 197
- paper jam in the standard bin 200
- paper jam in the staple finisher bin 214
- paper jam in trays 195
- paper jam, clearing
 - automatic document feeder 198
 - door J 210
 - door K 209
 - door L 213
 - door N 212
- duplex unit 201
- finisher bin 204
- fuser 201
- multipurpose feeder 197
- standard bin 200
- staple finisher bin 214
- trays 195

- paper jams
 - avoiding 193
 - location 194
- paper size
 - setting 23
- paper sizes
 - supported 28
- paper type
 - setting 23
- paper types
 - supported 31
- partial copies of documents or photos 249
- parts status
 - checking 147
- personal identification number method 142
- photoconductor unit
 - replacing 154
- photos, copying 41
- pick roller
 - replacing 162
- placing separator sheets between copies
 - copying 42
- poor copy quality 249
- poor fax print quality 248
- power button light
 - understanding the status 16
- power cord socket 13
- power save modes
 - configuring 191
- print appears tinted 244
- print driver
 - hardware options, adding 277
 - installing 275
- print job
 - canceling from the computer 40
 - canceling from the printer control panel 40
- print jobs not printed 226
- Print Quality Test Pages 137
- print quality troubleshooting
 - blank pages 229
 - crooked print 235
 - dark print 229
 - ghost images appear on prints 230
 - gray or colored background 231
 - horizontal dark lines 238
 - horizontal white lines 240
 - light print 233
 - missing colors 234
 - mottled print and dots 235
 - paper curl 221
 - print appears tinted 244
 - repeating print defects 242
 - skewed print 235
 - solid color or black images 236
 - text or images cut off 236
 - toner easily rubs off 237
 - uneven print density 238
 - vertical dark lines or streaks appear on prints 239
 - vertical white lines 241

- white pages 229
- print troubleshooting
 - collated printing does not work 220
 - confidential and other held documents do not print 223
 - envelope seals when printing 220
 - incorrect margins 232
 - jammed pages are not reprinted 223
 - job prints from the wrong tray 227
 - job prints on the wrong paper 227
 - paper frequently jams 222
 - print jobs do not print 226
 - slow printing 224
 - tray linking does not work 222
 - unable to read flash drive 218
- printer
 - basic model 11
 - fully configured 11
 - minimum clearances 10
 - moving 10
 - selecting a location 10
 - shipping 191
- printer configurations 11
- printer display
 - adjusting the brightness 192
- printer hard disk
 - encrypting 139
- printer hard disk memory 139
- printer is not responding 228
- printer memory
 - erasing 138
- printer menus 68
- printer messages
 - Defective flash detected 219
 - Non-Printer Manufacturer supply 219
 - Not enough free space in flash memory for resources 219
 - Replace cartridge, printer region mismatch 219
 - Unformatted flash detected 219
- printer port settings
 - changing 144
- printer ports 13
- printer settings
 - restoring factory default 139

- printer software
 - installing 275
- printer status 16
- printing
 - confidential print jobs 38
 - directory list 39
 - font sample list 39
 - from a computer 35
 - from a flash drive 36
 - from a mobile device 35, 36
 - held jobs 38
 - Menu Settings Page 17
 - using Wi-Fi Direct 36
- printing a directory list 39
- printing a font sample list 39
- printing a network setup page 218
- printing forms 35
- printing from a computer 35
- printing from a flash drive 36
- Push Button method 142

R

- received fax
 - forwarding 62
- received faxes
 - holding 62
- reducing copies 42
- repeat print jobs 38
- repeating print defects 242
- Replace cartridge, printer region mismatch 219
- replacing
 - transfer belt 171
- replacing a developer unit 148
- replacing a photoconductor unit 154
- replacing a toner cartridge 161
- replacing an imaging unit 158
- replacing parts
 - ADF feed roller 179
 - ADF pick roller 177
 - ADF separator roller 181
 - pick roller 162
 - separator pad 167
- replacing supplies
 - staple cartridge 183, 187
 - staple cartridge holder 185, 189
 - waste toner bottle 168
- replacing the ADF feed roller 179
- replacing the ADF pick roller 177

- replacing the ADF separator roller 181
- replacing the fuser 152
- replacing the pick roller 162
- replacing the separator pad 167
- replacing the staple cartridge holder in the multiposition staple, hole punch finisher 189
- replacing the staple cartridge holder in the staple finisher 185
- replacing the staple cartridge in the multiposition staple, hole punch finisher 187
- replacing the staple cartridge in the staple finisher 183
- replacing the transfer belt 171
- replacing the waste toner bottle 168
- replacing transfer roller 175
- resetting supply usage counters 182
- resetting the fuser page count 182
- resetting the maintenance counter 182
- resetting the transfer module page count 182
- RJ11 adapter 57

S

- safety information 8, 9
- saving paper 43
- saving toner 43
- Scan Center
 - setting up 19
- scan job not successful 250
- scan troubleshooting
 - cannot scan from a computer 248
 - partial copies of documents or photos 249
 - poor copy quality 249
 - scanner does not respond 251
 - scanning freezes the computer 250
 - scanning takes too long 250
- scanner
 - cleaning 145
- scanner glass
 - using 41, 44, 53, 64
- scanner unit does not close 250

- scanning
 - to a computer 64
 - to an FTP server 65
 - to flash drive 66
 - using the automatic document feeder (ADF) 64
 - using the scanner glass 64
 - scanning to a fax server 67
 - scanning to a network folder 67
 - scanning to an FTP server
 - using the control panel 65
 - scheduling a fax 61
 - securing printer memory 139
 - security slot
 - locating 138
 - selecting a location for the printer 10
 - sending a fax
 - using the computer 60
 - using the control panel 60
 - sending e-mail 52
 - separator pad
 - replacing 167
 - setting the paper size 23
 - setting the paper type 23
 - setting the Universal paper size 23
 - setting up fax
 - country- or region-specific 57
 - standard telephone line connection 54
 - shipping the printer 191
 - Shortcut Center
 - using 19
 - shortcut, creating
 - e-mail 52
 - fax destination 61
 - FTP address 65
 - shortcut, creating a copy 43
 - skewed print 235
 - Sleep mode
 - configuring 191
 - slow printing 224
 - SMB
 - scanning 67
 - SMTP settings
 - configuring 44
 - solid color or black images 236
 - sorting multiple copies 42
 - staple cartridge
 - replacing 183, 187
 - staple cartridge holder
 - replacing 185, 189
 - staple finisher
 - installing 265
 - staple jam in door G 206
 - staple jam in door J 214
 - staple jam, clearing
 - door G 206
 - door J 214
 - statement of volatility 139
 - storing
 - supplies 190
 - storing print jobs 38
 - streaks on prints 239
 - supplies
 - conserving 192
 - storing 190
 - supplies status
 - checking 147
 - supplies, ordering
 - toner cartridges 147
 - waste toner bottle 147
 - supply notifications
 - configuring 147
 - supply usage counters
 - resetting 182
 - supported file types 37
 - supported flash drives 37
 - supported operating systems 274
 - supported paper sizes 28
 - supported paper types 31
 - supported paper weights 33
- T**
- temperature around the printer 283
 - text or images cut off 236
 - toner cartridge
 - replacing 161
 - toner cartridges
 - ordering 147
 - toner darkness
 - adjusting 242
 - toner easily rubs off 237
 - transfer belt
 - replacing 171
 - transfer roller
 - replacing 175
 - transparencies
 - loading 25
 - tray linking does not work 222
- trays
 - linking 27
 - loading 23
 - unlinking 27
 - troubleshooting
 - cannot open Embedded Web Server 217
 - FAQ about color printing 243
 - printer is not responding 228
 - troubleshooting, copy
 - partial copies of documents or photos 249
 - poor copy quality 249
 - scanner does not respond 251
 - troubleshooting, print
 - collated printing does not work 220
 - confidential and other held documents do not print 223
 - envelope seals when printing 220
 - incorrect margins 232
 - jammed pages are not reprinted 223
 - job prints from the wrong tray 227
 - job prints on the wrong paper 227
 - paper frequently jams 222
 - print jobs do not print 226
 - slow printing 224
 - troubleshooting, print quality
 - blank pages 229
 - crooked print 235
 - dark print 229
 - ghost images appear on prints 230
 - gray or colored background 231
 - horizontal dark lines 238
 - horizontal white lines 240
 - light print 233
 - missing colors 234
 - mottled print and dots 235
 - paper curl 221
 - repeating print defects 242
 - skewed print 235
 - solid color or black images 236
 - text or images cut off 236
 - toner easily rubs off 237
 - uneven print density 238

- vertical dark lines or streaks
 - appear on prints 239
- vertical white lines 241
- white pages 229
- troubleshooting, scan
 - partial copies of documents or photos 249
 - poor copy quality 249
 - scan job not successful 250
 - scanner does not respond 251
 - scanner unit does not close 250
- two-sided copying 42

U

- unable to read flash drive
 - troubleshooting, print 218
- uneven print density 238
- Unformatted flash detected 219
- Universal paper size
 - setting 23
- unlinking trays 27
- updating firmware 277
- USB port
 - enabling 218
- USB printer port 13
- using the ADF
 - copying 41
- using the automatic document feeder (ADF) 41, 44, 53, 64
- using the control panel 15
- using the home screen 16
- using the scanner
 - glass 41, 44, 53, 64
 - copying 41

V

- verify print jobs 38
- vertical dark lines on prints 239
- vertical white lines 241
- viewing a fax log 62
- volatile memory 139
 - erasing 138

W

- waste toner bottle
 - ordering 147
 - replacing 168
- wireless network
 - connecting the printer to 141
 - Wi-Fi Protected Setup 142

- wireless networking 141
- wireless option 253
- Wi-Fi Direct
 - configuring 142
 - enabling 143
 - printing from a mobile device 36
- Wi-Fi network
 - deactivating 144
- Wi-Fi Protected Setup
 - wireless network 142