

SHARP®

MX-M1056

MX-M1206

Administrator Machine Adjustment Guide

Please keep the manual in a safe place where it will not be lost.

Caution

The Machine Adjustment is provided assuming that an administrative user who has sufficient knowledge for machine maintenance and management and is responsible for them uses the adjustment.

Changing adjustment values provided by the Machine Adjustment without having sufficient knowledge may lead to unexpected incidents such as insufficient print quality or product performance, increase in toner consumption and influence on machine life.

Table of Contents

1	Image Quality Adjustment.....	6
1.1	Laser Adjustment.....	6
1.1.1	Density Smoothing Adjustment (Auto Adjustment).....	6
1.1.2	Density Smoothing Adjustment (Densitometer Adjustment)	7
1.1.3	Density Smoothing Adjustment (Visual Adjustment)	8
1.2	Density Adjustment.....	10
1.2.1	Density Adjustment Automatic Execution Frequency.....	10
1.2.2	Maximum Density Setting.....	10
1.2.3	Density Adjustment (Forced Execution)	11
1.3	Fuser Adjustment.....	11
1.3.1	Fusing Temperature Setting	11
1.4	Image Quality Adjustment	12
1.4.1	Engine Gray Balance Adjustment	12
1.4.2	Printer Gray Balance Adjustment	12
1.4.3	User Calibration.....	13
1.4.4	Copy Calibration by Dither Pattern.....	13
1.4.5	Printer Calibration by Dither Pattern	14
1.5	Other Functions	15
1.5.1	Main Charger Cleaner Operation	15
1.5.2	Temperature/Humidity Display	15
2	Image Position/Ratio/Area Adjustment.....	16
2.1	Ratio Adjustment	16
2.1.1	Scan Ratio Adjustment	16
2.2	Edge Adjustment.....	16
2.2.1	Scan Original Edge Adjustment.....	16
2.2.2	Feed Direction Print Position Adjustment (Registration Motor On Timing)	17
2.2.3	Scan Original Edge Adjustment (Duplex Single Pass Feeder)	17
2.3	Void Area Adjustment	17
2.3.1	Copy Image Loss Amount Settings	17
2.3.2	Print Void Settings	18
2.3.3	Duplex Single Pass Feeder Image Loss Amount Settings.....	18
2.3.4	Scanner Image Loss Amount Settings	18
2.4	Off-Center Adjustment.....	19
2.4.1	Print Off-Center Adjustment	19
2.4.2	Scan Original Off-Center Adjustment	19
2.4.3	Auto Centering Adjustment.....	19

3	<i>Peripheral Adjustment</i>	20
3.1	Saddle Finisher (When the 100-sheet saddle finisher is installed)	20
3.1.1	Staple Position Adjustment.....	20
3.1.2	Paper Alignment Width Adjustment for Staple Position	21
3.1.3	Fold Position Adjustment for Saddle Fold	21
3.1.4	Fold/Staple Position Adjustment for Saddle Stitch	21
3.1.5	Staple Position Fine Adjustment for Saddle Stitch	21
3.1.6	Paper Alignment Width Adjustment for Saddle Stitch/Saddle Fold	22
3.2	Trimming Module	22
3.2.1	Trimming Original Point Adjustment.....	22
3.3	Finisher (When the 100-sheet finisher is installed)	22
3.3.1	Staple Position Adjustment.....	22
3.3.2	Paper Alignment Width Adjustment for Staple Position	23
3.4	Punch Module (When the 100-sheet saddle finisher and the punch module for the finisher is installed)	23
3.4.1	Punch Position Adjustment.....	23
3.4.2	Punch Mode Switch.....	24
3.4.3	Punch Operation Skew Adjustment.....	24
3.5	Folding Unit	24
3.5.1	Saddle Fold Position Adjustment	24
3.5.2	C-Fold Position Adjustment.....	25
3.5.3	Accordion Fold Position Adjustment.....	25
3.5.4	Double Fold Position Adjustment	25
3.5.5	Z-Fold Position Adjustment	26
4	<i>Print Setting Value List</i>	26
5	<i>Layout of the 10-key Pad</i>	27
5.1	Location of the 10-key Pad in the Screen	27
5.2	Behavior Specifications of the 10-key Pad	27

Purpose of Document

This document is for explaining the content, procedure and caution on each adjustment so that users in charge of machine maintenance understand and perform the machine adjustment properly.

To adjust the machine, tap the [Machine Adjustment] key in the Home Screen to open the Machine Adjustment screen.

■ Home Screen



※When the machine is in process, machine cannot enter [Machine Adjustment] screen. If the [Machine Adjustment] is tapped the following messages appears with beep: Machine Adjustment is not available due to the job currently reserved/executed.

Terminology

Process control

Density adjustment performed automatically either during job or between jobs.

Gray balance adjustment

Manual adjustment for gradation density
This adjustment is performed by setting specific adjustment values for density points of gradation density.

Calibration

Automatic adjustment for gradation density
This adjustment is performed by scanning printed test pattern with original glass.

Dither

This refers to screen precisely, which is the gradation (half tone) process, including error diffusion and dithering.

Main Charger

This charges the drum electrically.

Bypass

Multi bypass tray

LCC

Large Capacity Cassette
This refers to either MX-LC12.

LCT

Large Capacity Trays
This refers to MX-LC13 N.

Void Area

Unprinted area around the edges of sheet in printing

Image Loss

Unscanned area around the edges of original in scanning

Main Scan Direction

Direction of machine front and rear
Perpendicular to paper feed direction

Sub Scan Direction

Paper feed direction

Jogger

This adjusts the alignment of sheets piled in the finisher in front and rear direction for staple.

Machine Adjustment

1 Image Quality Adjustment

Select [Image Quality Adjustment] in the Machine Adjustment screen.

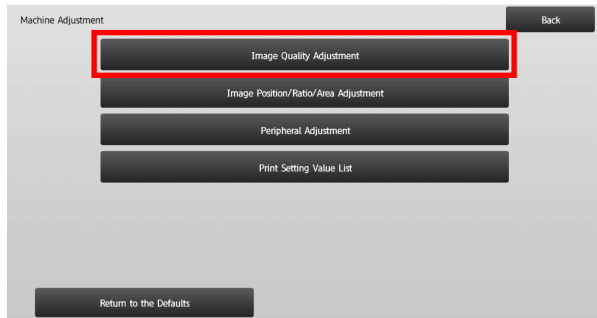

1.1 Laser Adjustment

Select [Laser Adjustment] in the Image Quality Adjustment screen.

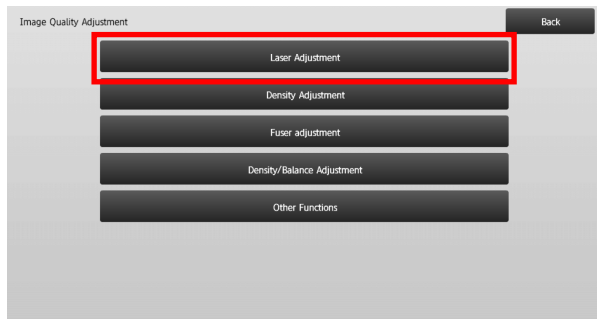

1.1.1 Density Smoothing Adjustment (Auto Adjustment)

This performs density smoothing adjustment for printing in front / rear (main scan) direction automatically.

1) Select [Auto Adjustment] in the Laser Adjustment screen.

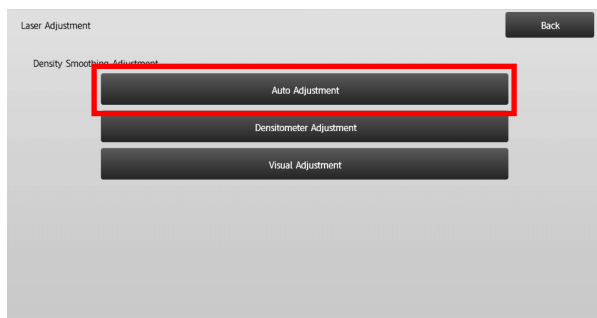

2) To print a test patch, tap the [Execute] key in the Density Smoothing Adjustment (Auto Adjustment) screen. If you need to change the density, select the desired density and then tap the [Execute] key.

[Before Adjustment]

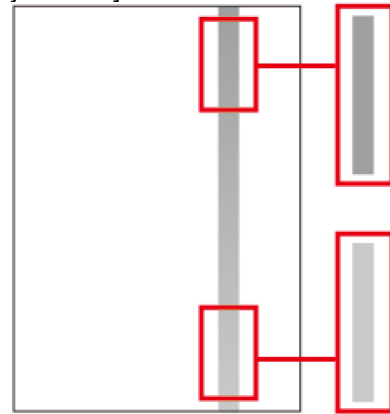

[After Adjustment]

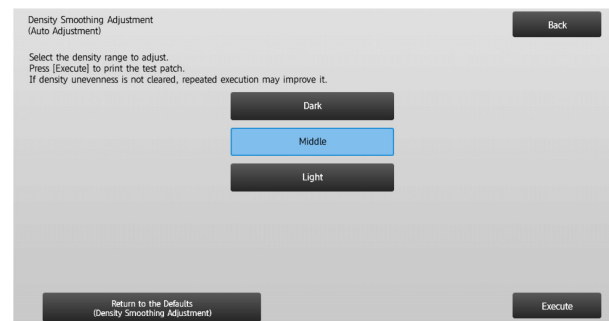
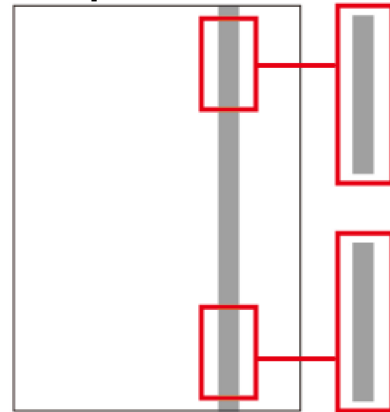

3) A message “Value set at Density Smoothing Adjustment (Densitometer/Visual) is cleared if executed. Execute?” comes up when you tap the [Execute] key. Tap the [Execute] key to continue if you do not see a problem. Tap the [Cancel] key if you do not want to clear the value.

Note:

To return your preferences to the factory defaults, tap the [Return to the Defaults (Density Smoothing Adjustment)] key. When a confirmation message appears, tap the [OK] key. The machine reboots to return to the factory defaults.

4) A test patch is printed.

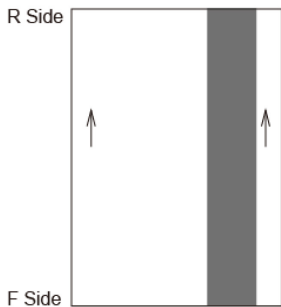

Note:

When the printing of a test patch fails, the following message appears: Printing test patch has failed. Use 8 1/2" X 11" or A4 paper for this adjustment. Press [Execute] to print the test patch.

5) Place the test patch on the document glass and tap the [Execute] key to start the adjustment.

Note:

When the scanning of the test patch fails, the following message appears: Auto adjustment has failed. Please check if the test patch is properly set on the document glass. Press [Execute] to resume scanning.

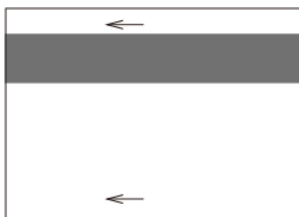

6) When the adjustment is completed, a completion message appears and the adjustment result is printed.

Note:

When the printing of the adjustment result fails, the following message appears: Printing adjustment result has failed. Use 8 1/2" X 11" or A4 paper. Press [Execute] to print the adjustment result.

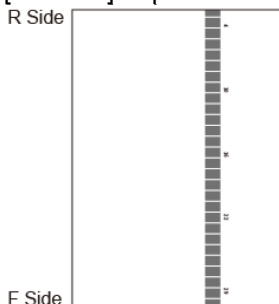

7) Tap the [Back] key to return to the Laser Adjustment screen.

Note:

It is recommended to perform Auto Adjustment several times. (2 to 3 times)

8) Make sure to perform [1.4.3 User Calibration] under [Settings] if you wish not to erase the adjustment values set by [1.4.1 Engine Gray Adjustment] and [1.4.2 Printer Gray Balance Adjustment] after this adjustment. Make sure to choose both the copy and printer calibrations in the calibration.

1.1.2 Density Smoothing Adjustment (Densitometer Adjustment)

This performs density smoothing adjustment for printing in front / rear (main scan) direction by measuring test patch with a densitometer.

Note:

The densitometer is to be prepared by users.

1) Select [Densitometer Adjustment] in the Laser Adjustment screen.

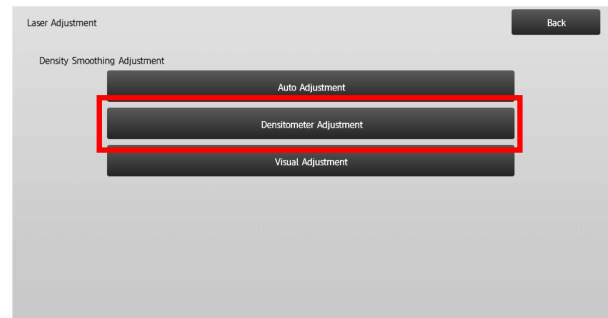

2) To print a test patch, tap the [Execute] key in the Density Smoothing Adjustment (Densitometer Adjustment) screen. If you need to change the density, select the desired density and then tap the [Execute] key.

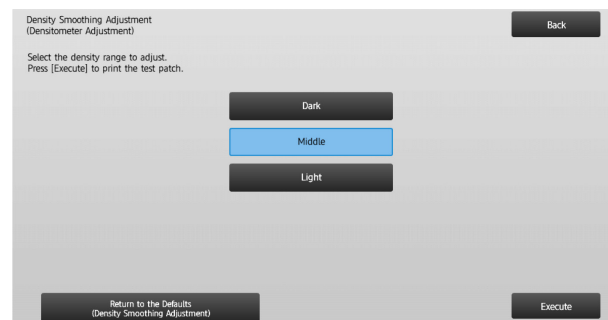

Note:

To return your preferences to the factory defaults, tap the [Return to the Defaults (Density Smoothing Adjustment)] key. When a confirmation message appears, tap the [OK] key. The machine reboots to return to the factory defaults.

3) A test patch containing a column of 28 patches (3-30) is printed.

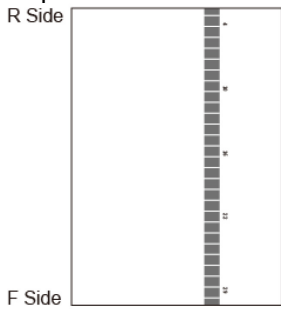

Note:

When the printing of a test patch fails, the following message appears: Printing test patch has failed. Use 8 1/2" X 11" or A4 paper for this adjustment. Press [Execute] to print the test patch.

4) Measure the values of the five specified positions on the test patch with the densitometer.

Note:

All five values must be entered. Adjustment is performed by reduction of all five points.

5) Enter the five measured values and tap the [Execute] key to start the adjustment.



Input range: [0] to [300] (1 = 0.01)
Default: [100] for each

6) When the adjustment is completed, a completion message appears and the adjustment result is printed.

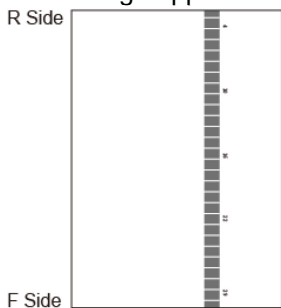

Note:

When the printing of the adjustment results fails, the following message appears: Printing adjustment result has failed. Use 8 1/2" X 11" or A4 paper. Press [Execute] to print the adjustment result.

7) Check the density in the adjustment result.

- When the desired density is not achieved, tap the [Readjust] key and repeat steps 3) to 7).
 - When the desired density is achieved, tap the [Back] key to return to the Laser Adjustment screen.
- 8) Make sure to perform [1.4.3 User Calibration] under [Settings] if you wish not to erase the adjustment values set by [1.4.1 Engine Gray Adjustment] and [1.4.2 Printer Gray Balance Adjustment] after this adjustment. Make sure to choose both the copy and printer calibrations in the calibration.

1.1.3 Density Smoothing Adjustment (Visual Adjustment)

This performs density smoothing adjustment for printing in front / rear (main scan) direction by measuring test patch visually.

1) Select [Visual Adjustment] in the Laser Adjustment screen.

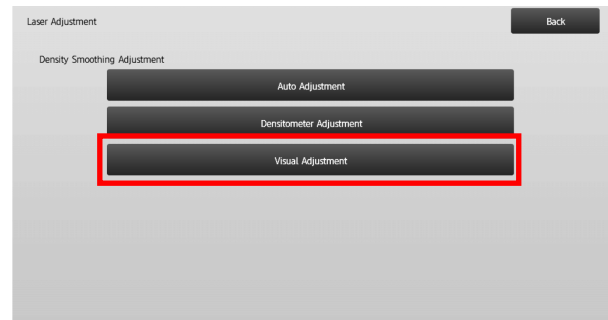

2) To print a test patch, tap the [Execute] key in the Density Smoothing Adjustment (Visual Adjustment) screen. If you need to change the density, select the desired density and then tap the [Execute] key.

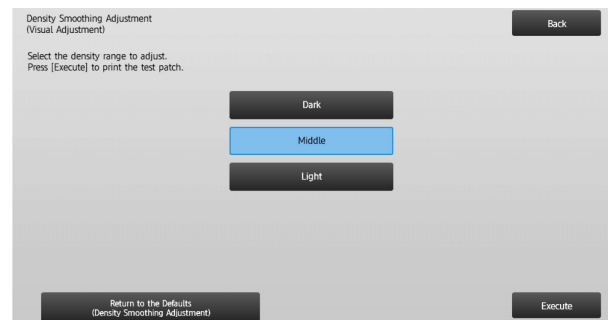

Note:

To return your preferences to the factory defaults, tap the [Return to the Defaults (Density Smoothing Adjustment)] key. When a confirmation message appears, tap the [OK] key. The machine reboots to return to the factory defaults.

3) A test patch containing a column of 28 patches (3-30) is printed.

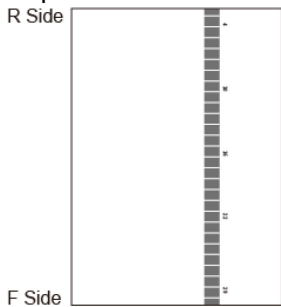

Note:

When the printing of a test patch fails, the following message appears: Printing test patch has failed. Use 8 1/2" X 11" or A4 paper for this adjustment. Press [Execute] to print the test patch.

4) Select [5] or [32] for the number of adjustment points.

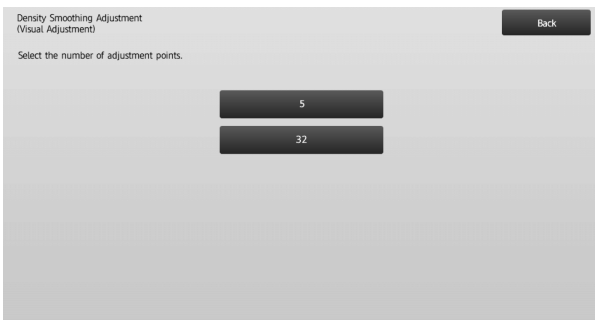

5) Enter the desired values and tap the [Execute] key to start the adjustment.

◆When [5] is selected in step 4):

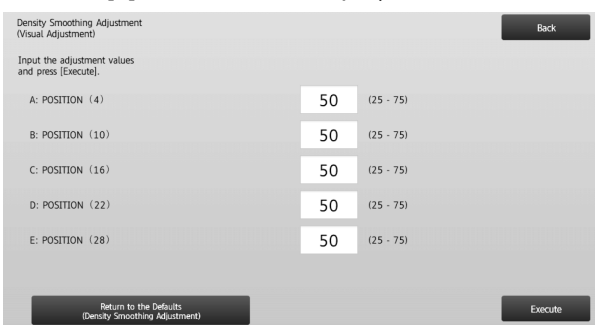

Input range: [0] to [100]

Default: 50

C: POSITION (16) is fixed at [50].

◆When [32] is selected in step 4):

Example of the Density Smoothing Adjustment (Visual Adjustment) screen

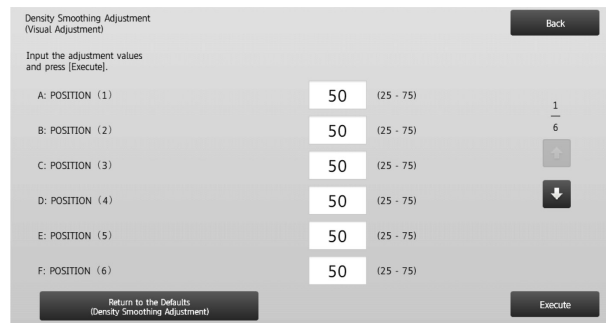

Input range: [25] to [75]

Default: 50

P: POSITION (16) is fixed at [50].

6) When the adjustment is completed, a completion message appears and the adjustment result is printed.

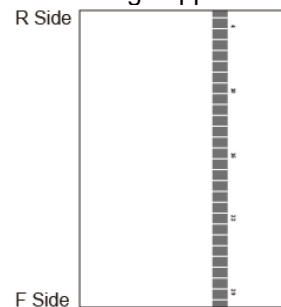

Note:

When the printing of the adjustment result fails, the following message appears: Printing adjustment result has failed. Use 8 1/2" X 11" or A4 paper. Press [Execute] to print the adjustment result.

- When the desired density is not achieved, tap the [Readjust] key and repeat steps 3) to 6).

- In 4-point adjustment (excluding fixed values), 4 points can be entered to extrapolate and adjust all of the remaining 32 points.

- In 28-point adjustment (excluding fixed points), each point can be adjusted.

- When the desired density is achieved, tap the [Back] key to return to the Laser Adjustment screen.

7) Make sure to perform [1.4.3 User Calibration] under [Settings] if you wish not to erase the adjustment values set by [1.4.1 Engine Gray Adjustment] and [1.4.2 Printer Gray Balance Adjustment]) after this adjustment. Make sure to choose both the copy and printer calibrations in the calibration.

1.2 Density Adjustment

Select [Density Adjustment] in the Image Quality Adjustment screen.

1.2.1 Density Adjustment Automatic Execution Frequency

This makes a setting of frequency (condition) to perform density adjustment (process control) automatically.

- 1) Select [Density Adjustment Automatic Execution Frequency] in the Density Adjustment screen.

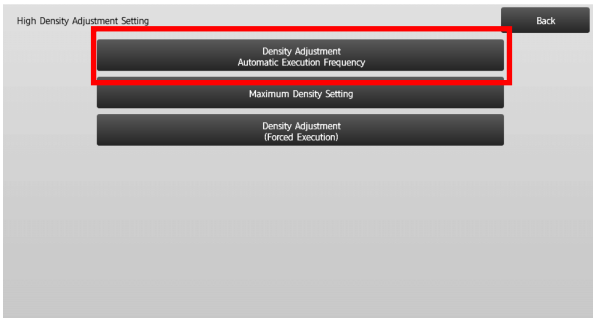

- 2) When job efficiency is prior, set Density adjustment during job to [No]. When image stability is prior, set Density adjustment to [Yes].

Note:

Even if the Density adjustment during job is set to [No], density adjustment may execute by machine state.

- 3) When the density adjustment during job is set to [Yes], tap the [+] and [-] keys to change the execution frequency of the density adjustment.

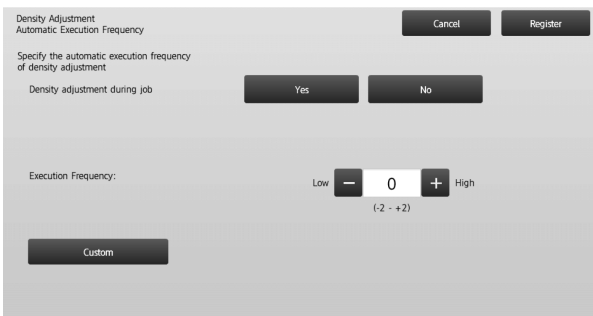

Density adjustment during job:

[Yes]: The process control adjustment interrupts the job in progress.

[No]: The process control adjustment does not interrupt the job in progress.

Default: [No]

Execution Frequency:

Input range: [-2] to [2]

Default: [0]

Note:

When the density adjustment while a job is in progress is set to [No], the execution frequency is grayed out with the default value displayed.

- 4) To reflect the settings, the machine needs to reboot. When the [Register] key is tapped, a message appears prompting you to reboot the machine.

- 5) Tap the [OK] key to reboot the machine.

1.2.2 Maximum Density Setting

This performs the adjustment of maximum density.

- 1) Select [Maximum Density Setting] in the Density Adjustment screen.
- 2) To change the maximum density setting of density adjustment, tap [+] and [-] key.



Max. Density (K): [-2] to [2]

Default: [0]

Note:

Toner consumption may increase by the settings.

- 3) Tap the [Register] key to register the setting.
- 4) To reflect the settings, the machine needs to reboot. When the [Register] key is tapped, a message appears prompting you to reboot the machine.
- 5) Tap the [OK] key to reboot the machine.
- 6) After the machine is rebooted, perform Calibration in the system settings instead.
- 7) The setting in step 3) is reflected.

Note:

When this adjustment is performed, Engine Gray Balance Adjustment and Printer Gray Adjustment need to be adjusted.

When [User Calibration] is performed, values entered manually using Engine Gray Balance Adjustment and Printer Gray Balance Adjustment are initialized. If you do not want to initialize these values, you must perform Calibration in the system settings instead.

When this adjustment is performed, a message will appear in the touch panel prompting you to perform Calibration in the system settings.

1.2.3 Density Adjustment (Forced Execution)

This performs density adjustment (process control) forcefully.

- 1) Select [Density Adjustment (Forced Execution)] in the Density Adjustment screen.
- 2) Tap the [Execute] key in the Density Adjustment (Forced Execution) screen.
- 3) The following message appears: When image density adjustment mode is executed, more toner is consumed, it takes about 20 seconds and the main unit is rebooted after completion Execute?
Tap the [Execute] key to confirm the message.
- 4) When the adjustment is completed, a completion message appears. After a certain period of time lapses, the machine starts rebooting.
(No requests are accepted by the machine in the period before the rebooting starts.)

1.3 Fuser Adjustment

Select [Fuser Adjustment] in the Image Quality Adjustment screen.

1.3.1 Fusing Temperature Setting

This performs setting of fusing temperature.

Fusing performance largely depends on basis weight of paper. Select proper paper type for fusing temperature adjustment. When unrecommended paper is used, set paper property.

See below for detail of adjustment.

Adjustment Detail

Symptoms to adjust the temperature high

- Poor fusing caused by low temperature (toner is not on the paper)
- Not enough gloss is applied.

Symptoms to adjust the temperature low

- Poor fusing caused by high temperature (surface of images are rough, Toner may come off)
- Too much gloss is applied.
- Paper is curled.
- Paper is creased.
- Paper jam occurs in fusing area.
- Toner blisters occurs.
- Paper blisters occurs.

Note:

- When plain paper or recycled paper is used, Set [Fusing Control Settings] of [Device Control] in [System Settings].
- When unrecommended glossy paper is used, set paper property to print with proper weight of paper setting.
- When an envelope is not set properly in the tray, poor fusing or crease may occur.
- When unrecommended envelope is used, poor fusing or crease may occur.

- 1) Select [Fusing Temperature Settings] in the Fusing Adjustment screen.

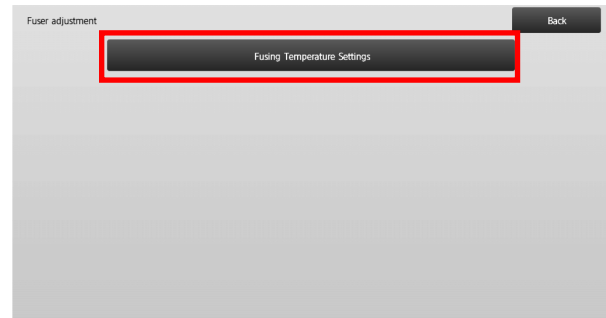

- 2) To change the fusing temperature setting, tap the [+] and [-] key or use the 10-key pad appears when each of the textboxes is tapped.

Example of Fusing Temperature Setting screen

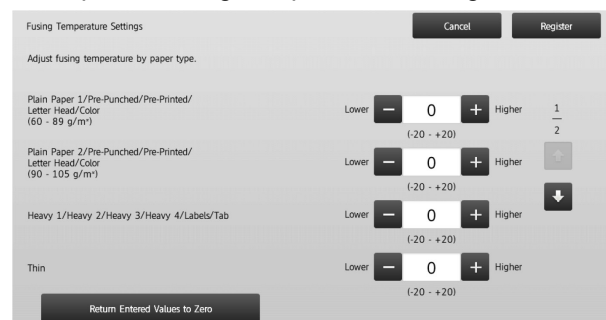

Input range: [-10] to [10]

Default: [0] for each

- 3) Tap the [Register] key to register the setting.

Note:

To reflect the settings, the machine needs to reboot. When the [Register] key is tapped, a message appears prompting you to reboot the machine.

- 4) Tap the [OK] key to reboot the machine.

1.4 Image Quality Adjustment

Select [Image Quality Adjustment] in the Image Quality Adjustment screen.

1.4.1 Engine Gray Balance Adjustment

This enables adjustment of gradation density for printing in copy mode by measuring test patch visually.

- 1) Select [Gray Balance Adjustment (for Copy)] in the Image Quality Adjustment screen.

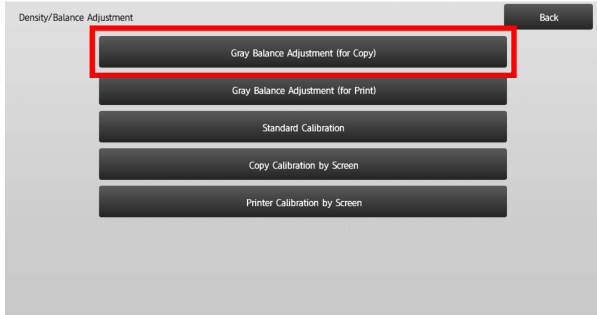

- 2) To start the adjustment, tap the [Execute] key in the Engine Gray Balance Adjustment screen.
- 3) An adjustment pattern is printed.
- 4) Referring to the adjustment pattern, select the density point to adjust. Enter the desired value and then tap the [Execute] key.

Example of the Engine Gray Balance Adjustment screen



- To change the density points separately
The density points can be specified separately.
Input range: [1] to [999]
Default: [500] for each

- To change all density points at once
The density points can be also specified all at once by checking the [Set in a Batch] checkbox.
Input range: [1] to [999]

The [Set in a Batch] checkbox is not checked by default. When this checkbox is checked, the value [500] appears in the textbox.

Note:

When the [Set in a Batch] checkbox is checked, Density Points 1-17 are grayed out. When this checkbox is not checked, the textbox for [Set in a Batch] is not active. (A beep sounds when the textbox is tapped.)

- 5) After adjustment, tap the [Execute] button again, print a print pattern, and check the results of adjustment. You will return to the Image Quality Adjustment screen.

Note:

To return your preferences to the factory defaults, tap the [Return to the Defaults (Gray Balance Adjustment)] key. When a confirmation message appears, tap the [OK] key. Your preferences are returned to the factory defaults and the screen returns to the Image Quality Adjustment screen.

1.4.2 Printer Gray Balance Adjustment

This enables adjustment of gradation density for printing in printer mode by measuring test patch visually.

- 1) Select [Printer Gray Balance Adjustment] in the Image Quality Adjustment screen.
- 2) To start the adjustment, tap the [Execute] key in the Printer Gray Balance Adjustment screen.
- 3) An adjustment pattern is printed.
- 4) Referring to the adjustment pattern, select the density point to adjust. Enter the desired value and then tap the [Execute] key.

Example of the Printer Gray Balance Adjustment screen

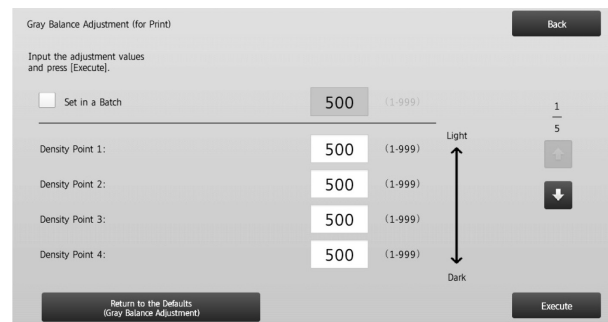

- To change the density points separately
The density points can be specified separately.
Input range: [1] to [999]
Default: [500] for each

- To change all density points at once
The density points can be also specified all at once by checking the [Set in a Batch] checkbox.
Input range: [1] to [999]

The [Set in a Batch] checkbox is not checked by default. When this checkbox is checked, the value [500] appears in the textbox.

Note:

When the [Set in a Batch] checkbox is checked, Density Points 1-17 are grayed out. When this checkbox is not checked, the textbox for [Set in a Batch] is not active. (A beep sounds when the textbox is tapped.)

- 5) When adjustment is completed, you will return to the Image Quality Adjustment screen. After adjustment, tap the [Execute] button again, print a print pattern, and check the results of adjustment.

Note:

To return your preferences to the factory defaults, tap the [Return to the Defaults (Gray Balance Adjustment)] key. When a confirmation message appears, tap the [OK] key. Your preferences are returned to the factory defaults and the screen returns to the Image Quality Adjustment screen.

1.4.3 User Calibration

This performs gradation density for printing in copy and printer modes automatically. It is possible to perform adjustment for copy and printer modes separately. This function uses the scanner to adjust gray balance.

Note:

When this adjustment is performed, the values set in Engine Gray Balance Adjustment (1.4.1) / Printer Gray Balance Adjustment (1.4.2) will be cleared. To perform calibration without clearing those values, perform Calibration in System settings.

When [1.4.4 Copy Calibration by Dither Pattern] or [1.4.5 Printer Calibration by Dither Pattern] is to be performed, this adjustment is not necessary.

- 1) Select [User Calibration] in the Image Quality Adjustment screen.
- 2) To print a test patch, select the desired calibration and tap the [Execute] key in the User Calibration screen.

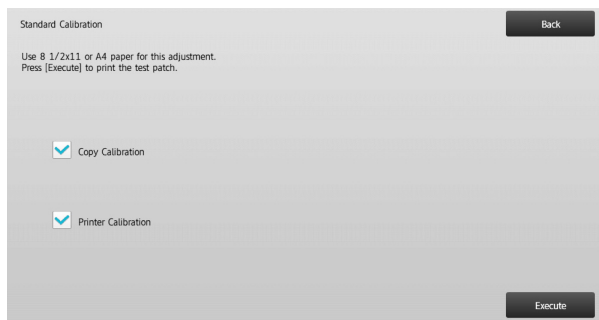

Copy calibration checkbox*:

When this checkbox is checked and the [Execute] key is tapped, copy calibration is executed.

Printer calibration checkbox *:

When this checkbox is checked and the [Execute] key is tapped, printer calibration is executed.

Note:

When both of [Copy Calibration] and [Printer Calibration] are checked, copy calibration is first executed and then printer calibration.

- 3) When the [Execute] key is tapped, the checked calibration starts.
- 4) A test patch is printed.

Note:

When the printing of a test patch fails, the following message appears: Printing test patch has failed. Use 8 1/2" X 11" or A4 paper for this adjustment. Press [Execute] to print the test patch.

- 5) Place the test patch printer in step 4) on the document glass (the thin line at the edge of the page is to the left). Lay copy paper (about five sheets) that is the same size as the test patch on top of the placed test patch, gently close the automatic document feeder, and tap the [Execute].

Note:

When the scanning of the test patch fails, the following message appears: Auto adjustment has failed. Please check if the test patch is properly set on the document glass. Press [Execute] to resume scanning.

- 6) When the calibration is completed, a completion message appears. The completion message varies depending on the calibration that has been executed.
 - To return to the Image Quality Adjustment screen, tap the [Back] key.
 - When both of [Copy Calibration] and [Printer Calibration] are executed, tap the [Execute] key to move on to the execution of Printer Calibration. Repeat the step 4) to 6) for Printer Calibration.

1.4.4 Copy Calibration by Dither Pattern

This performs gradation density for printing in copy mode for each dither pattern. The scanner can be used to perform fine adjustment of the copying gray balance of each screen.

- 1) Select [Copy Calibration by dither pattern] in the Image Quality Adjustment screen.
- 2) To start copy calibration by screen, tap the [Execute] key in the Copy Calibration by dither pattern screen.
- 3) A test patch is printed.

Note:

When the printing of a test patch fails, the following message appears: Printing test patch has failed. Use 8 1/2" X 11" or A4 paper for this adjustment. Press [Execute] to print the test patch.

- 4) Place the printed test patch on the document glass and tap [Execute] to start the auto adjustment. Place the test patch in portrait orientation.

Note:

When the scanning of the test patch fails, the following message appears: Auto adjustment has failed. Please check if the test patch is properly set on the document glass. Press [Execute] to resume scanning.

- 5) When the adjustment is completed, the dither pattern selection screen appears.
- 6) Select the desired dither pattern and tap the [Execute] key to start calibration by screen.
- 7) A test patch is printed.

Note:

When the printing of a test patch fails, the following message appears: Printing test patch has failed. Use 8 1/2" X 11" or A4 paper for this adjustment. Press [Execute] to print the test patch.

- 8) Place the printed test patch on the document glass. Press [Execute] to start the auto adjustment. Place the test patch in portrait orientation.
- 9) When the copy calibration by screen is completed, a completion message appears.

Note:

When the scanning of the test patch fails, the following message appears: Auto adjustment has failed. Please check if the test patch is properly set on the document glass. Press [Execute] to resume scanning.

- To return to the dither pattern selection screen, tap the [Pattern Selection] key.
- To return to the Image Quality Adjustment screen, tap the [Back] key.

1.4.5 Printer Calibration by Dither Pattern

This performs gradation density for printing in printer mode for each dither pattern.

The scanner can be used to perform fine adjustment of the printer gray balance of each screen.

- 1) Select [Printer Calibration by dither pattern] in the Image Quality Adjustment screen.
- 2) To start printer calibration by screen, tap the [Execute] key in the Printer Calibration by dither pattern screen.
- 3) A test patch is printed.

Note:

When the printing of a test patch fails, the following message appears: Printing test patch has failed. Use 8 1/2" X 11" or A4 paper for this adjustment. Press [Execute] to print the test patch.

- 4) Place the printed test patch on the document glass. Press [Execute] to start the auto adjustment. Place the test patch in portrait orientation.
- 5) When the adjustment is completed, the dither pattern selection screen appears.
- 6) Select the desired dither pattern and tap the [Execute] key to start calibration by screen.
- 7) A test patch is printed.

Note:

When the printing of a test patch fails, the following message appears: Printing test patch has failed. Use 8 1/2" X 11" or A4 paper for this adjustment. Press [Execute] to print the test patch.

- 8) Place the printed test patch on the document glass. Press [Execute] to start the auto adjustment. Place the test patch in portrait orientation.
- 9) When the printer calibration by screen is completed, a completion message appears.

Note:

When the scanning of the test patch fails, the following message appears: Auto adjustment has failed. Please check if the test patch is properly set on the document glass. Press [Execute] to resume scanning.

- To return to the dither pattern selection screen, tap the [Pattern Selection] key.
- To return to the Image Quality Adjustment screen, tap the [Back] key.

1.5 Other Functions

Select [Other Functions] in the Image Quality Adjustment screen.

1.5.1 Main Charger Cleaner Operation

This performs main charger cleaning.

1) Select [MC Cleaning] in the Other Functions screen.

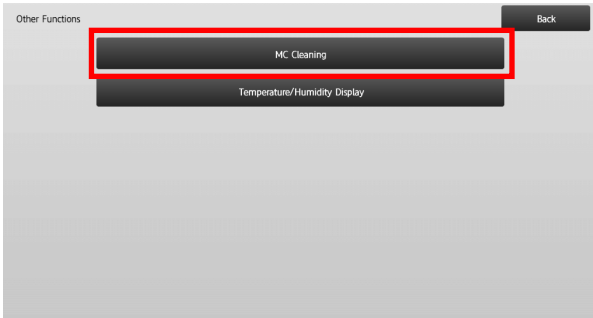

- 2) To start the main charger cleaner operation, tap the [Execute] key in the MC Cleaning screen.
- 3) When the cleaner operation is completed, a completion message appears.
- 4) To return to the Other Functions screen, tap the [Back] key.

1.5.2 Temperature/Humidity Display

This shows temperature and humidity in the machine.

- 1) Select [Temperature/Humidity Display] in the Other Functions screen.
- 2) Temperatures and humidity inside the machine are displayed (display only).

Example of Temperature/Humidity Display screen.



Caution:

Fuser temperature adjustment stops when you enter the machine adjustment mode. Therefore, the displayed temperature may not correspond with the fusing temperature for printing.

- 3) To return to the Other Functions screen, tap the [Back] key.

2 Image Position/Ratio/Area Adjustment

Adjustment

Select [Image Position/Ratio/Area Adjustment] in the Machine Adjustment screen.

2.1 Ratio Adjustment

Select [Ratio Adjustment] in the Image Position/Ratio/Area Adjustment screen.

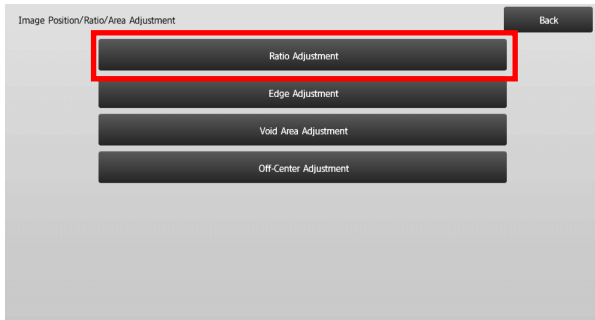

2.1.1 Scan Ratio Adjustment

This performs magnification adjustment in sub scan direction for scanning original in copy and scan modes.

- 1) Select [Scan Ratio Adjustment] in the Ratio Adjustment screen.
Specify the Print Position Adjustment first.

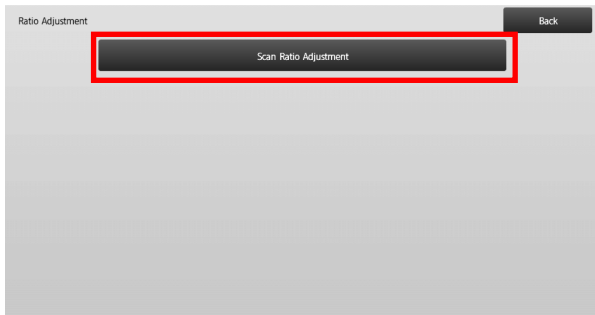

- 2) Enter the desired values and tap the [Register] key.



Input range: [20] to [80] (1 = 0.1 %)
Default: [50] for each

Note:

To return your preferences to the factory defaults, tap the [Return to the Defaults (Scan Ratio Adjustment)] key. When a confirmation message appears, tap the [OK] key. Your preferences are returned to the factory defaults and the screen returns to the Ratio Adjustment screen.

2.2 Edge Adjustment

Select [Edge Adjustment] in the Image Position/Ratio/Area Adjustment screen.

2.2.1 Scan Original Edge Adjustment

This performs edge (scanning start) position adjustment for scanning original from original glass.

- 1) Select [Scan Original Edge Adjustment (Original Glass)] in the Edge Adjustment screen.
Specify the Print Position Adjustment first.

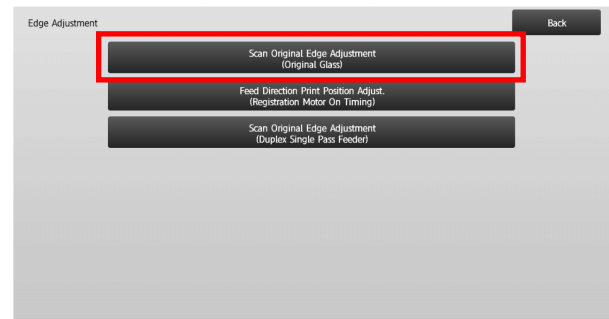

- 2) Enter the desired value and tap the [Register] key.

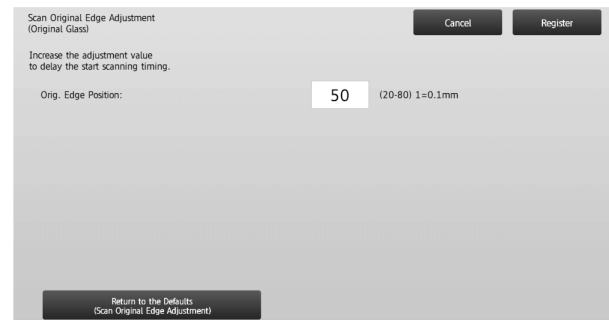

Input range: [20] to [80] (1 = 0.1 mm)
Default: [50]

Note:

To return your preferences to the factory defaults, tap the [Return to the Defaults (Scan Original Edge Adjustment)] key. When a confirmation message appears, tap the [OK] key. Your preferences are returned to the factory defaults and the screen returns to the Edge Adjustment screen.

2.2.2 Feed Direction Print Position Adjustment (Registration Motor On Timing)

This performs print start position adjustment for printing.

- 1) Select [Feed Direction Print Position Adjust. (Registration Motor On Timing)] in the Edge Adjustment screen.
- 2) Enter the desired values and tap the [Register] key.

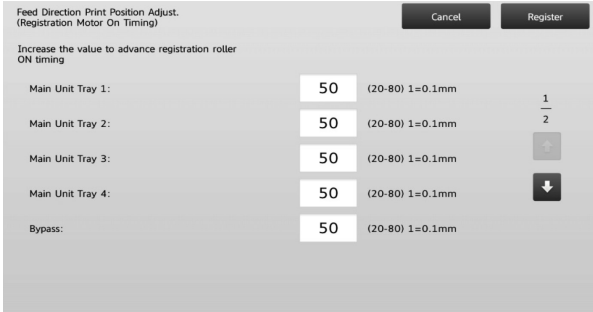

The input range is [20] to [80] (1 = 0.1 mm) and the default is [50] for each.

Note:

[Bypass], [LCC] and [LCT] are displayed only when the options are installed.

2.2.3 Scan Original Edge Adjustment (Duplex Single Pass Feeder)

This performs edge (scanning start) position adjustment for scanning original from document feeder.

- 1) Select [Scan Original Edge Adjustment (Duplex Single Pass Feeder)] in the Edge Adjustment screen. Specify the Print Position Adjustment first.
- 2) Enter the desired values and tap the [Register] key.



Input range: [20] to [80] (1 = 0.1 mm)
Default: [50] for each

Note:

To return your preferences to the factory defaults, tap the [Return to the Defaults (Scan Original Edge Adjustment)] key. When a confirmation message appears, tap the [OK] key. Your preferences are returned to the factory defaults and the screen returns to the Edge Adjustment screen.

2.3 Void Area Adjustment

Select [Void Area Adjustment] in the Image Position/Ratio/Area Adjustment screen.

2.3.1 Copy Image Loss Amount Settings

This performs adjustment of image loss amount for scanning original in copy mode.

- 1) Select [Copy Image Loss Amount Settings] in the Void Area Adjustment screen. Specify the Print Position Adjustment first.

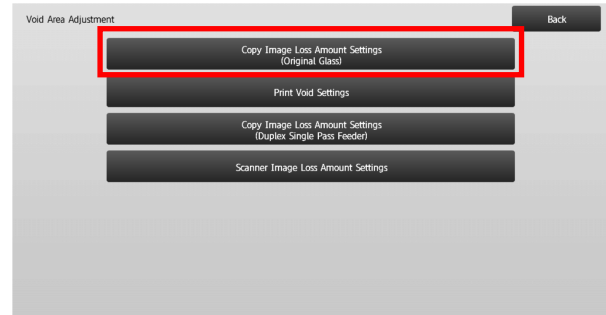

- 2) Enter the desired values and tap the [Register] key.

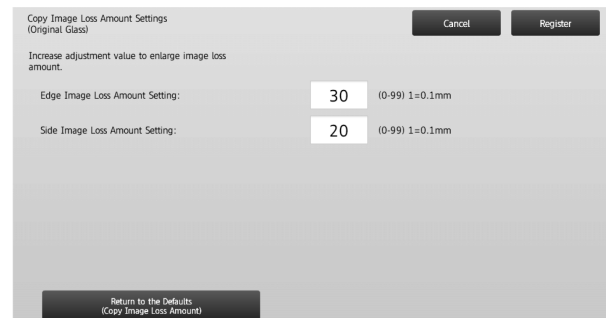

Input range: [0] to [99] (1 = 0.1 mm)

Defaults:

Edge image loss amount setting: [30]

Side image loss amount setting: [20]

Note:

To return your preferences to the factory defaults, tap the [Return to the Defaults (Copy Image Loss Amount)] key. When a confirmation message appears, tap the [OK] key. Your preferences are returned to the factory defaults and the screen returns to the Void Area Adjustment screen.

2.3.2 Print Void Settings

This performs adjustment of print void amount for printing.

- 1) Select [Print Void Settings] in the Void Area Adjustment screen.
- 2) Enter the desired values and tap the [Register] key.

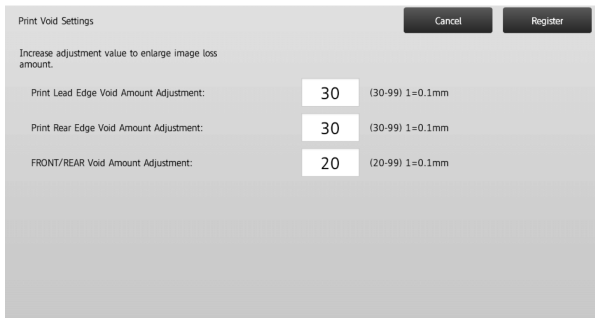

Print Lead Edge Void Amount Adjustment:

Print Rear Edge Void Amount Adjustment:

Input range: [30] to [99] (1 = 0.1 mm)

FRONT/REAR Void Amount Adjustment:

Input range: [20] to [99] (1 = 0.1 mm)

Defaults:

Print Lead Edge Void Amount Adjustment: [30]

Print Rear Edge Void Amount Adjustment: [30]

FRONT/REAR Void Amount Adjustment: [20]

2.3.3 Duplex Single Pass Feeder Image Loss Amount Settings

This performs adjustment of image loss amount for scanning original from document feeder in copy mode.

- 1) Select [Duplex Single Pass Feeder Image Loss Amount Settings] in the Void Area Adjustment screen. Specify the Print Position Adjustment / Scan Position Adjustment first.
- 2) Enter the desired values and tap the [Register] key.

Example of the Duplex Single Pass Feeder Image Loss Amount Settings screen

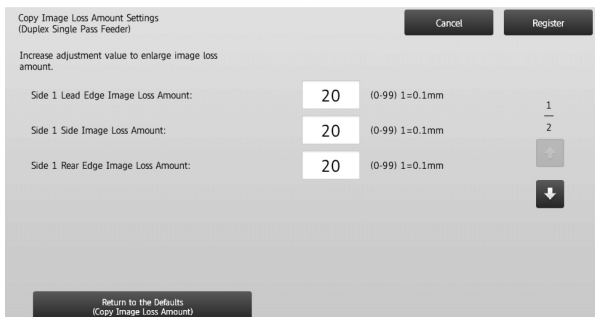

Input range: [0] to [99] (1 = 0.1 mm)

Defaults:

Side 1 lead edge image loss amount: [20]

Side 1 side image loss amount: [20]

Side 1 rear edge image loss amount: [30]

Side 2 lead edge image loss amount: [30]

Side 2 side image loss amount: [20]

Side 2 rear edge image loss amount: [20]

Note:

To return your preferences to the factory defaults, tap the [Return to the Defaults (Density Smoothing Adjustment)] key. When a confirmation message appears, tap the [OK] key. Your preferences are returned to the factory defaults and the screen returns to the Void Area Adjustment screen.

2.3.4 Scanner Image Loss Amount Settings

This performs adjustment of image loss amount for scanning original in scanner mode.

- 1) Select [Scanner Image Loss Amount Settings] in the Void Area Adjustment screen. Specify the Print Position Adjustment first.
- 2) Enter the desired values and tap the [Register] key.

Example of the Scanner Image Loss Amount Settings screen

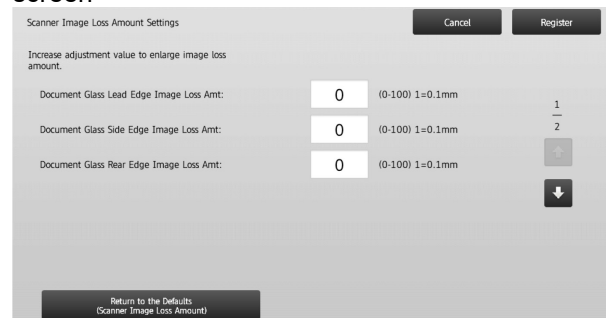

Input range: [0] to [100] (1 = 0.1 mm)

Default: [0] for each

Note:

To return your preferences to the factory defaults, tap the [Return to the Defaults (Copy Image Loss Amount)] key. When a confirmation message appears, tap the [OK] key. Your preferences are returned to the factory defaults and the screen returns to the Void Area Adjustment screen.

2.4 Off-Center Adjustment

Select [Off-Center Adjustment] in the Image Position/Ratio/Area Adjustment screen.

2.4.1 Print Off-Center Adjustment

This performs center position adjustment for printing.

- 1) Select [Print Off-Center Adjustment] in the Off-Center Adjustment screen.

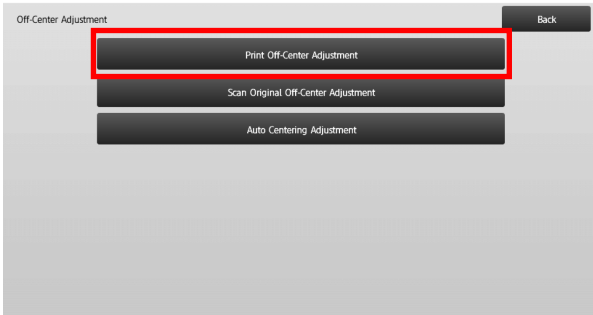

- 2) Enter the desired values and tap the [Register] key.

Example of the Print Off-Center Adjustment screen

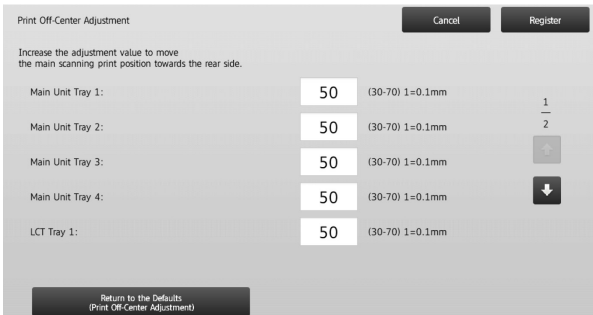

Input range: [30] to [70] (1 = 0.1 mm)
Default: [50] for each

Note:

- LCT Tray 1, LCT Tray 2, LCT Tray 3, LCT Tray 4, LCT Bypass Tray and LCC are displayed only when the options are installed.
- To return your preferences to the factory defaults, tap the [Return to the Defaults (Print Off-Center Adjustment)] key. When a confirmation message appears, tap the [OK] key. Your preferences are returned to the factory defaults and the screen returns to the Off-Center Adjustment screen.

2.4.2 Scan Original Off-Center Adjustment

This performs center position adjustment for scanning original.

- 1) Select [Scan Original Off-Center Adjustment] in the Off-Center Adjustment screen. Specify the Print Position Adjustment first.

- 2) Enter the desired values and tap the [Register] key.

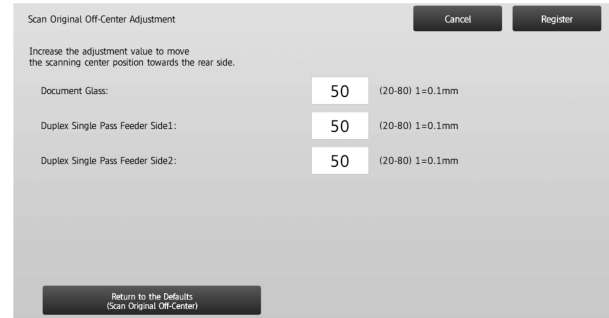

Input range: [20] to [80] (1 = 0.1 mm)
Default: [50] for each

Note:

To return your preferences to the factory defaults, tap the [Return to the Defaults (Scan Original Off-Center)] key. When a confirmation message appears, tap the [OK] key. Your preferences are returned to the factory defaults and the screen returns to the Off-Center Adjustment screen.

2.4.3 Auto Centering Adjustment

This makes settings of condition for automatic centering adjustment (function to detect paper position and perform centering adjustment automatically).

- 1) Select [Auto Centering Adjustment] in the Off-Center Adjustment screen.
- 2) Select [ON] or [OFF] for each scan direction adjustment and tap the [Register] key.

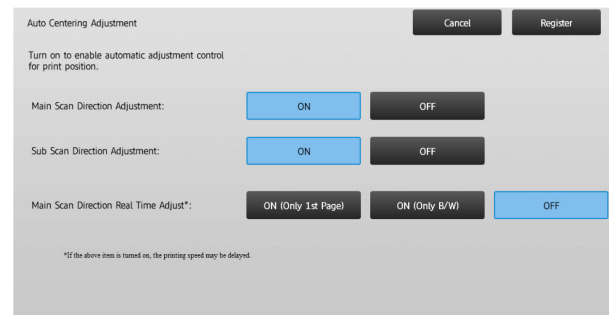

Main Scan Direction Adjustment:
Select [ON] or [OFF]. Default: [ON]

Sub Scan Direction Adjustment:
Select [ON] or [OFF]. Default: [ON]

Main Scan Direction Real Time Adjust:
Select [ON] or [OFF]. Default: [OFF]

Caution:

Turning the Main Scan Direction Real Time Adjustment ON might affect the print speed and the drum life.

3 Peripheral Adjustment

Select [Peripheral Adjustment] in the Machine Adjustment screen.

Adjustable options:

The saddle finisher, trimming module, finisher, punch module, and folding unit can be adjusted:

The installed options are displayed as follows:

- When the 100-sheet saddle finisher, trimming module and punch module are installed:

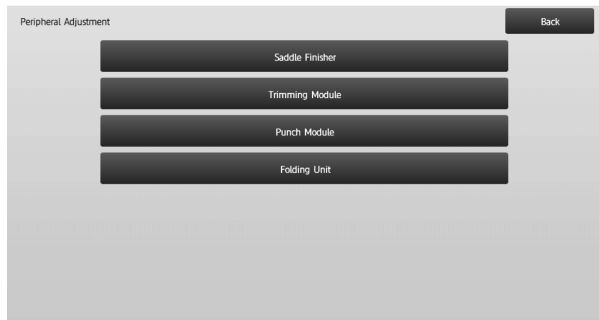

3.1 Saddle Finisher (When the 100-sheet saddle finisher is installed)

3.1.1 Staple Position Adjustment

This performs staple position adjustment in the direction of paper width.

- 1) Select [Staple Position Adjustment] in the Saddle Finisher screen.

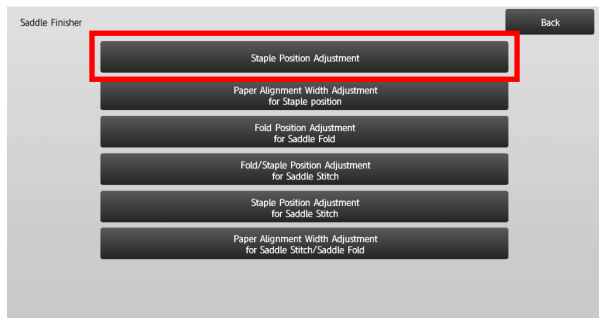

- 2) Adjust the staple positions in the direction of paper width.

The 10-key pad appears when each of the textboxes is tapped. Enter the desired values.



Input range:

One staple: [70] to [130]

Two staples: [85] to [115] (1 = 0.1 mm)

Default: 100 for each

Note:

Staple position in paper feed direction cannot be adjusted.

Functional restriction

For 2 staples, the staple positions that can be adjusted vary depending on the paper size and the number of sheets included in a set to be stapled as the following table shows:

Paper size	Number of sheets included in a set	Staple position that can be adjusted
A4R/Letter R or smaller	20 sheets or less	Only the staple at back
	More than 20 sheets	Both staples at front and back
Larger than A4R/Letter R	-	Both staples at front and back

3.1.2 Paper Alignment Width Adjustment for Staple Position

This performs jogger width adjustment for staple (paper width direction).
Set this adjustment when the stapled stack of paper is not aligned.

- 1) Select [Paper Alignment Width Adjustment for Staple Position] in the Saddle Finisher screen.
- 2) Adjust the distance between the alignment plates in the direction of paper width for stapling.
The 10-key pad appears when the textbox is tapped. Enter the desired value.

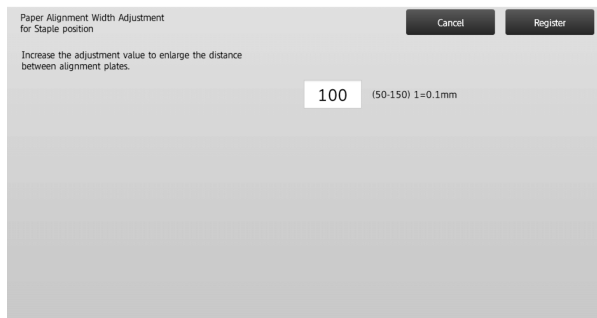

Input range: [50] to [150] (1 = 0.1 mm)
Default: [100]

3.1.3 Fold Position Adjustment for Saddle Fold

This performs fold position adjustment for saddle fold (without staple).

- 1) Select [Fold Position Adjustment for Saddle Fold] in the Saddle Finisher screen.
- 2) Adjust the fold positions in the direction of paper transport for saddle folding.
The 10-key pad appears when each of the textboxes is tapped. Enter the desired values.

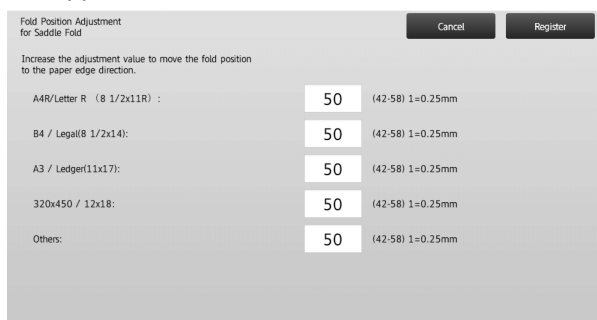

Input range: [42] to [58] (1 = 0.25 mm)
Default: [50] for each

3.1.4 Fold/Staple Position Adjustment for Saddle Stitch

This performs adjustment of fold and staple positions for saddle stitch (fold and staple) (both fold and staple positions are adjusted together).

- 1) Select [Fold/Staple Position Adjustment for Saddle Stitch] in the Saddle Finisher screen.
- 2) Adjust the fold/staple positions in the direction of paper transport for saddle stitching.
The 10-key pad appears when each of the textboxes is tapped. Enter the desired values.

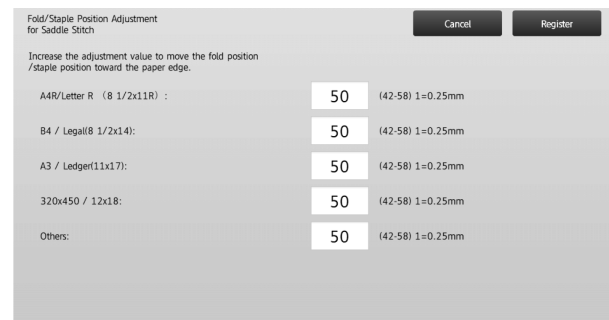

Input range: [42] to [58] (1 = 0.25 mm)
Default: [50] for each

3.1.5 Staple Position Fine Adjustment for Saddle Stitch

This performs fine adjustment of staple position for saddle stitch (fold and staple) (used for fine adjusting staple position only).

- 1) Select [Staple Position Fine Adjustment for Saddle Stitch] in the Saddle Finisher screen.
- 2) Fine-tune the staple position in relation to the fold position for saddle folding.
The 10-key pad appears when the textbox is tapped. Enter the desired value.



Input range: [20] to [80] (1 = 0.1 mm)
Default: [50]

3.1.6 Paper Alignment Width Adjustment for Saddle Stitch/Saddle Fold

This performs jogger width adjustment for saddle stitch and saddle fold.

Set this adjustment when the stapled stuck of paper is not aligned.

- 1) Select [Paper Alignment Width Adjustment for Saddle Stitch/Saddle Fold] in the Saddle Finisher screen.
- 2) Adjust the distance between the alignment plates in the direction of paper width for saddle stitching/saddle folding.
The 10-key pad appears when the textbox is tapped. Enter the desired value.



Input range: [80] to [120] (1 = 0.20944 mm)
Default: [100]

3.2 Trimming Module

Select [Trimming Module] in the Peripheral Adjustment screen.

3.2.1 Trimming Original Point Adjustment

This performs adjustment of trimming origin position for saddle stitch (fold and staple).
This corrects deviation of the actual cutting amount from the amount set with the trimming setting.

- 1) Select [Trimming Original Point Adjustment] in the Trimming Module screen.

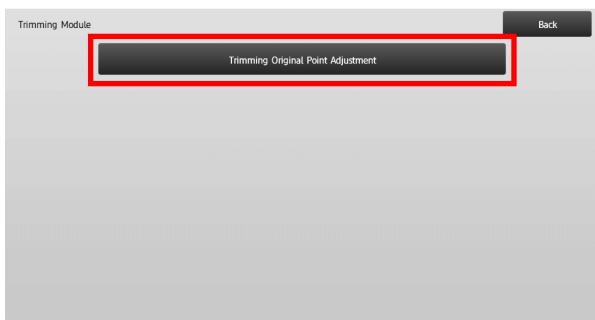

- 2) Adjust the trimming original point for saddle stitching. The 10-key pad appears when each of the textboxes is tapped. Enter the desired values.

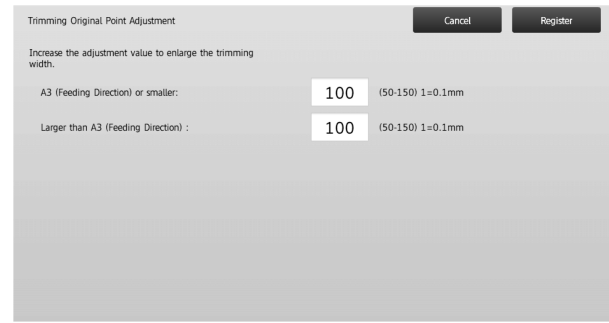

Input range: [50] to [150] (1 = 0.1 mm)
Default: [100] for each

3.3 Finisher (When the 100-sheet finisher is installed)

Select [Finisher] in the Peripheral Adjustment screen.

3.3.1 Staple Position Adjustment

This performs staple position adjustment for staple in the direction of paper width.

- 1) Select [Staple Position Adjustment] in the Finisher screen.

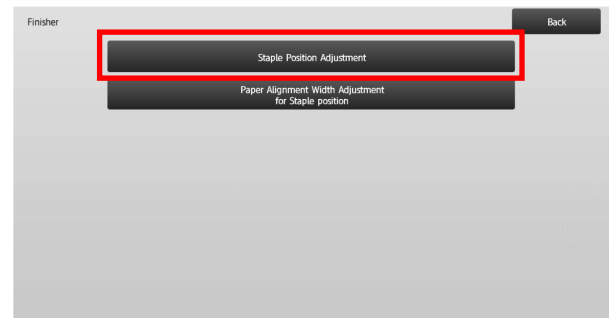

- 2) Adjust the staple positions in the direction of paper width. The 10-key pad appears when each of the textboxes is tapped. Enter the desired values.

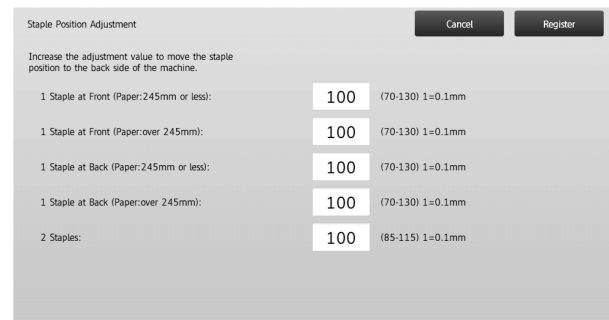

Input range:
One staple: [70]-[130] (1 = 0.1 mm)
Two staples: [85]-[115] (1 = 0.1 mm)
Default: [100] for each

Note:

Staple position in paper feed direction cannot be adjusted.

Functional Restriction

For 2 staples, the staple positions that can be adjusted vary depending on the paper size and the number of sheets included in a set to be stapled as the following table shows:

Paper size	Number of sheets included in a set	Staple position that can be adjusted
A4R/Letter R or smaller	20 sheets or less	Only the staple at back
	More than 20 sheets	Both staples at front and back
Larger than A4R/Letter R	-	Both staples at front and back

3.3.2 Paper Alignment Width Adjustment for Staple Position

This performs jogger width adjustment for staple (paper width direction).

- 1) Select [Paper Alignment Width Adjustment for Staple Position] in the Finisher screen.
- 2) Adjust the distance between the alignment plates in the direction of paper width for stapling.
The 10-key pad appears when the textbox is tapped. Enter the desired value.

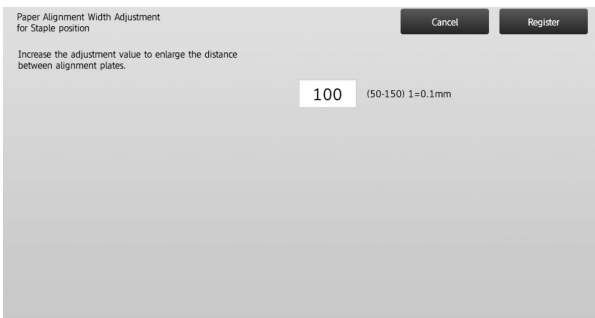

Input range: [50] to [150] (1 = 0.1 mm)
Default: [100]

3.4 Punch Module (When the 100-sheet saddle finisher and the punch module for the finisher is installed)

Select [Punch Module] in the Peripheral Adjustment screen.

3.4.1 Punch Position Adjustment

This performs adjustment of punch position from paper edge or in the direction of paper width.

- 1) Select [Punch Position Adjustment] in the Punch Module screen.

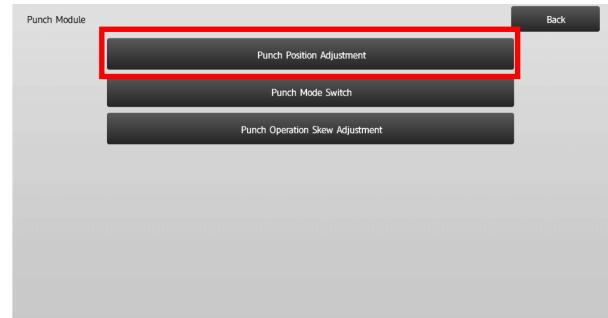

- 2) Adjust the hole positions in relation to the lead edge and in the direction of paper width.
The 10-key pad appears when the textbox is tapped. Enter the desired value.

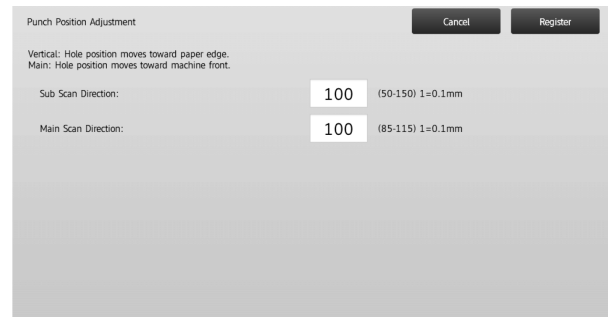

Sub Scan Direction:
Input range: [50] to [150] (1 = 0.1 mm)
Default: [100]

Main Scan Direction:
Input range: [85] to [115] (1 = 0.1 mm)
Default: [100]

3.4.2 Punch Mode Switch

This switches punch operation mode.

High Accuracy Mode: Prioritizes punch position accuracy when punching.

High Production Mode: Prioritizes speed when punching.

- 1) Select [Punch Mode Switch] in the Punch Module screen.
- 2) Select [High Accuracy Mode] or [High Production Mode] for punch mode.

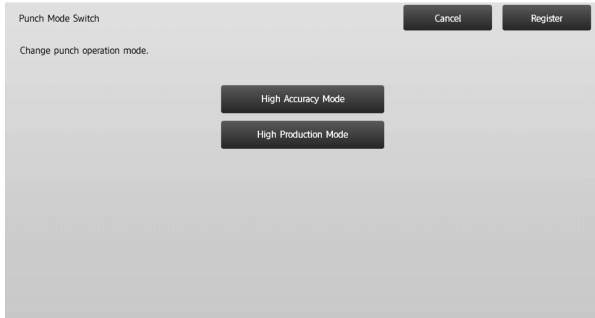

Default: [High Production Mode]

Note:

Select [High Accuracy Mode] when punch hole is skewed against paper.

- 3) Tap the [Register] key to switch to the desired mode.

3.4.3 Punch Operation Skew Adjustment

This performs skew (paper tilt) adjustment for punch in High Accuracy Mode.

Perform this adjustment when the punch hole is skewed against paper in high accuracy mode.

- 1) Select [Punch Operation Skew Adjustment] in the Punch Module screen.
- 2) Adjust the paper jog amounts for the paper skew adjustment in high accuracy mode. The 10-key pad appears when each of the textboxes is tapped. Enter the desired values.

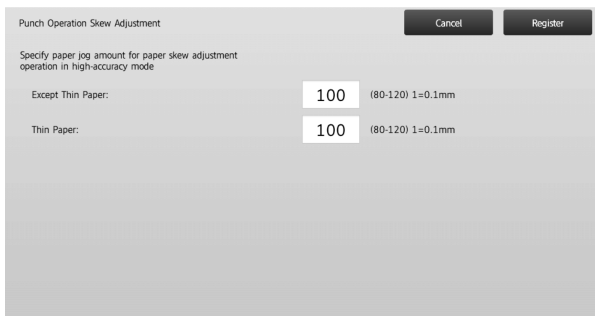

Input range: [80] to [120] (1 = 0.1 mm)

Default: [100] for each

3.5 Folding Unit

Select [Folding Unit] in the Peripheral Adjustment screen.

3.5.1 Saddle Fold Position Adjustment

This performs adjustment of fold position for saddle fold.

- 1) Select [Saddle Fold Position Adjustment] in the Folding Unit screen.



- 2) Adjust the saddle fold position for when the folding unit is installed.

The 10-key pad appears when the textbox is tapped. Enter the desired value.

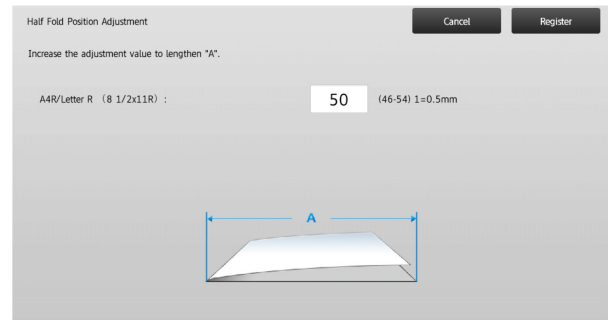

Input range: [46] to [54] (1 = 0.5 mm)

Default: [50]

Diagram showing the saddle fold position

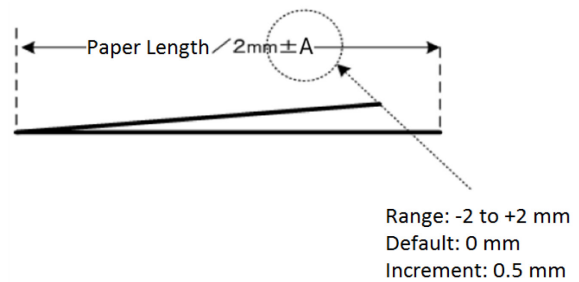

3.5.2 C-Fold Position Adjustment

This performs adjustment of fold position for C-fold.

- 1) Select [C-Fold Position Adjustment] in the Folding Unit screen.
- 2) Adjust the C-fold position for when the folding unit is installed.
The 10-key pad appears when the textbox is tapped.
Enter the desired value.

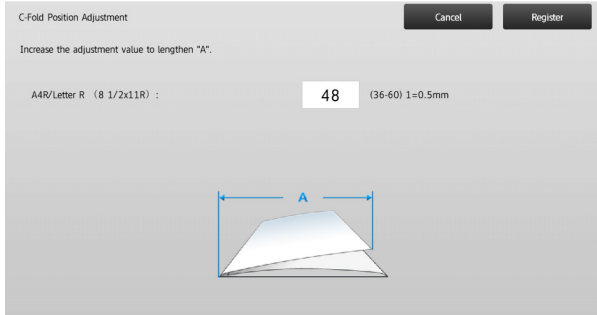

Input range: [36] to [60] (1 = 0.5 mm)
Default: [48]

Diagram showing the C-fold position

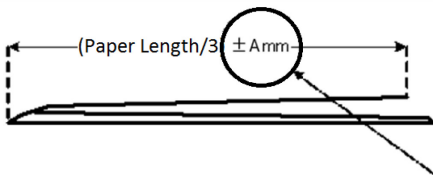

Range: -7 to +5 mm
Default: -1 mm
Increment: 0.5 mm

3.5.3 Accordion Fold Position Adjustment

This performs adjustment of fold position for accordion fold.

- 1) Select [Accordion Fold Position Adjustment] in the Folding Unit screen.
- 2) Adjust the accordion fold position for when the folding unit is installed.
The 10-key pad appears when the textbox is tapped.
Enter the desired value.

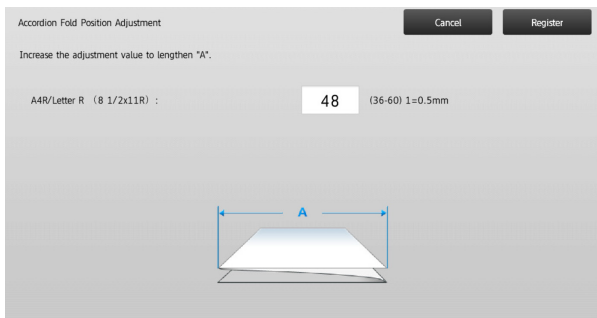

Input range: [36] to [60] (1 = 0.5 mm)
Default: [48]

Diagram showing the accordion fold position

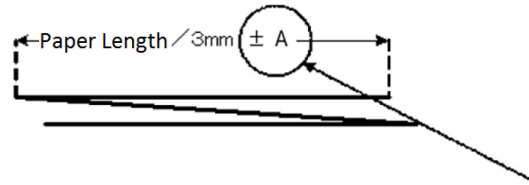

Range: -7 to +5 mm
Default: -1 mm
Increment: 0.5 mm

3.5.4 Double Fold Position Adjustment

This performs adjustment of fold position for double fold.

- 1) Select [Double Fold Position Adjustment] in the Folding Unit screen.
- 2) Adjust the double fold position for when the folding unit is installed.
The 10-key pad appears when each of the textboxes is tapped. Enter the desired values.

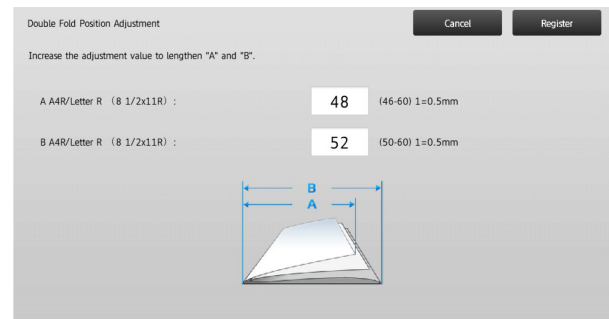

Input range:

A4R/Letter R (8 1/2 x 11R): [46] to [60] (1 = 0.5 mm)
Default: [48]

A4R/ Letter R (8 1/2 x 11R): [50] to [60] (1 = 0.5 mm)
Default: [52]

Diagram showing the double fold position

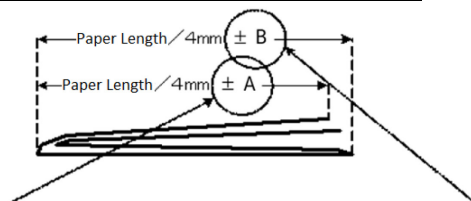

Range: -2 to +5 mm
Default: -1 mm
Increment: 0.5 mm

Range: 0 to +5 mm
Default: 1 mm
Increment: 0.5 mm

3.5.5 Z-Fold Position Adjustment

This performs adjustment of fold position for Z-fold.

- 1) Select [Z-Fold Position Adjustment] in the Folding Unit screen.
- 2) Adjust the Z-fold position for when the folding unit is installed.
The 10-key pad appears when each of the textboxes is tapped. Enter the desired values.

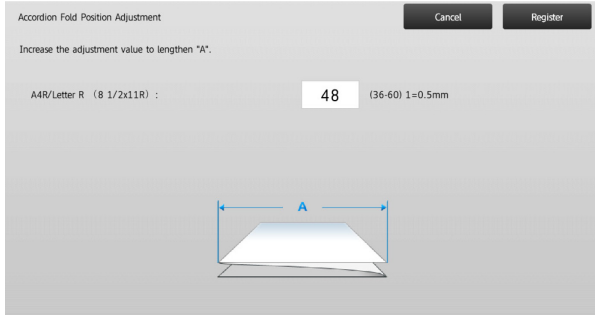

Input range: [46] to [53] (1 = 0.5 mm)
The default is [50].

Diagram showing the Z-fold position

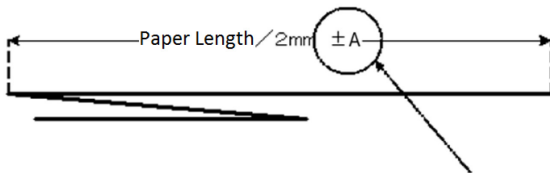

Range: -2 to +1.5 mm
Default: 0 mm
Increment: 0.5 mm

4 Print Setting Value List

The current setting values and the factory defaults for the items in the machine adjustment can be printed.

Select [Print Setting Value List] in the Machine Adjustment screen.

Note: Settings that have been changed from the factory defaults are marked with an asterisk.

- 1) Check the items to print.

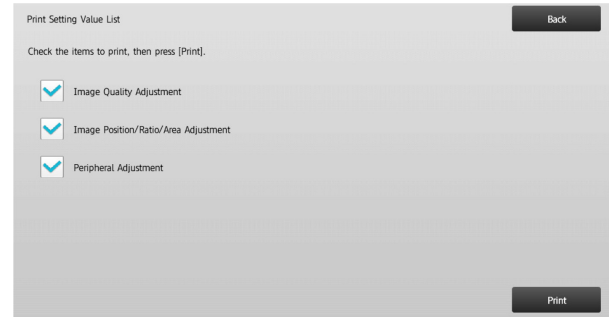

Default: [Checked] for all

- 2) To print the selected items, tap the [Print] key.

Note: The [Print] key is grayed out when no item is checked.

5 Layout of the 10-key Pad

- 1) The 10-key pad used for the machined adjustment consists of the numeric keys from 0 to 9, the [C] and [OK] keys and the numerical display.
- 2) The numeric keys on the 10-key pad are arranged in the ascending order starting from the top left. The order cannot be changed.

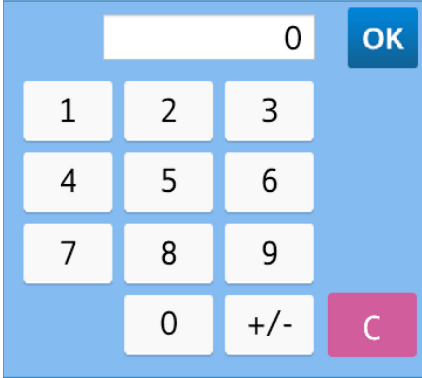

5.1 Location of the 10-key Pad in the Screen

The 10-key pad appears when each of the textboxes in the screen is tapped.

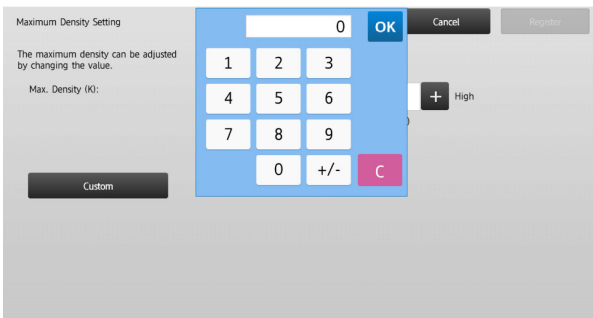

5.2 Behavior Specifications of the 10-key Pad

The behavior specifications of the 10-key pad are as follows:

- When the 10-key pad is opened, the numerical display shows by default the value currently shown in the textbox or the factory default value.
- A new entry made with the numeric keys of 0 to 9 overwrites a value currently shown in the numerical display.
- The 10-key pad is closed by tapping the [OK] key. When the 10-key pad is closed, the value in the numerical display is reflected in the textbox. Any value that is more than the range is not accepted; a beep sounds to alert accordingly when a numeric key that results in such value is tapped. When the value in the numerical display is less than the range, the [OK] key becomes inactive.
- The value in the numerical display is cleared by tapping the [C] key. When the [OK] key is tapped just after the numerical display is cleared, the entry is canceled and not reflected in the textbox; the original value or the factory default value remains effective.
- The [Cancel] and [Back] keys in each setting screen are active while the 10-key pad is being displayed. When the [Cancel] or [Back] key in the screen is tapped, the ongoing entry on the 10-key pad is canceled and the 10-key pad is closed and then the screen returns to the previous one. The [Register], [Execute] and [Return to the Defaults] keys in each setting screen, however, are not active while the 10-key pad is being displayed.

SHARP®