

# SHARP®

DIGITAL MULTIFUNCTIONAL SYSTEM

MODEL: MX-M1056  
MX-M1206

# User's Manual

Click to jump to the table of contents of the desired chapter.



## BEFORE USING THE MACHINE

Functions of the machine and procedures for placing originals and loading paper



## COPIER

Using the copy function



## PRINTER

Using the printer function



## SCANNER

Using the scan



## DOCUMENT FILING

Storing jobs as files on the local drive



## MANUAL FINISHING

Using the manual finishing function



## SETTING MODE

Configuring settings to make the machine easier to use



## APPENDIX

Specifications  
License Information



# HOW TO USE THIS MANUAL

Click a button below to move to the page that you wish to view.

The following explanation assumes that Adobe Acrobat Reader is being used (Some buttons do not appear in the default state.).

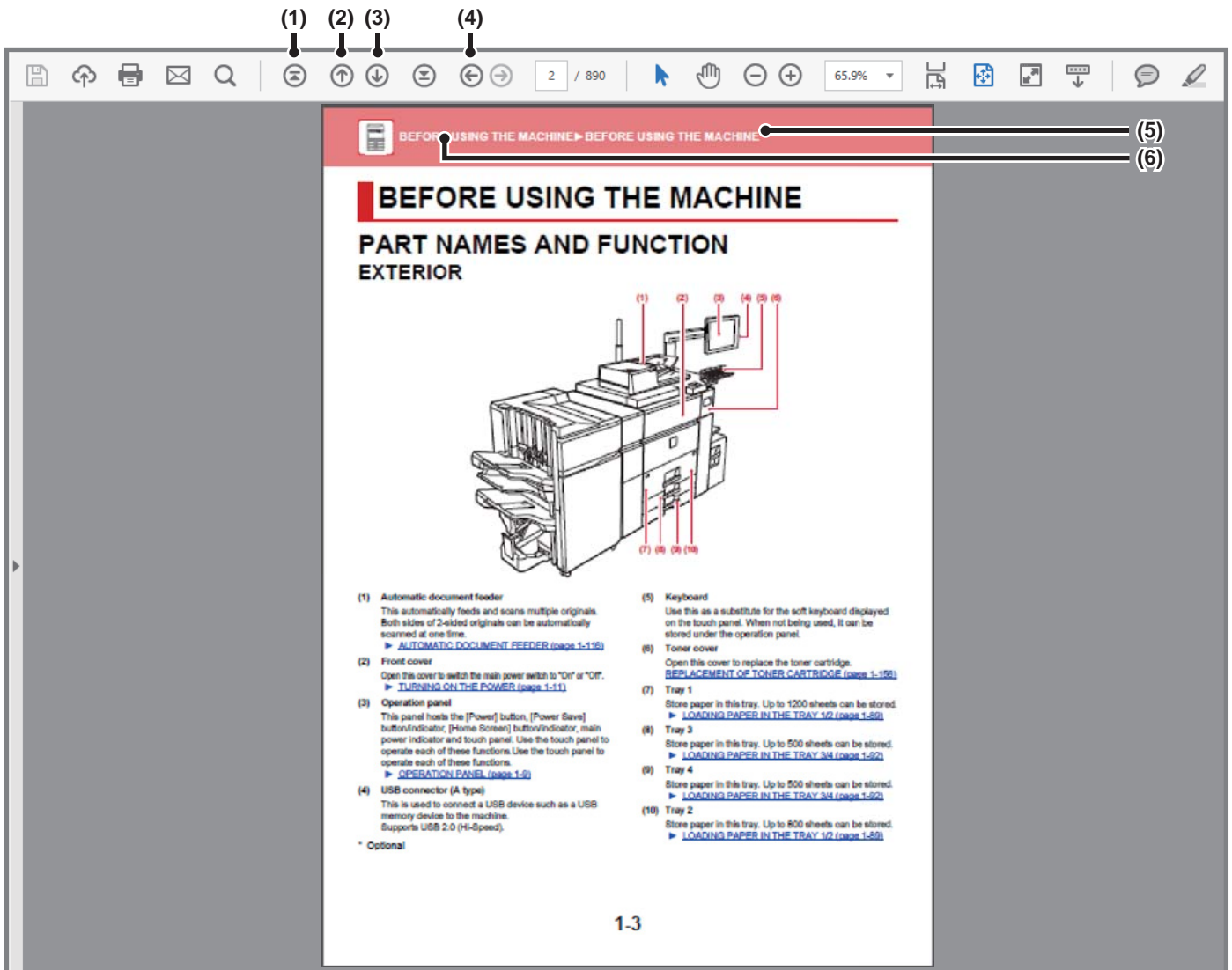

## (1) Return to top page button

If an operation does not proceed as expected, click this button to start over again.

## (2) Back one page button

Displays the previous page.

## (3) Forward one page button

Displays the next page.

## (4) Return to previously displayed page button

Displays the page that was displayed before the current page.

## (5) Title button

Displays the page of the title indicated by the button.

## (6) Contents button

Displays the contents of each chapter.

For example, if the current page is part of the printer chapter, the table of contents of the printer chapter appears.



If a button does not appear, refer to Adobe Reader Help to display the button.

# ABOUT OPERATION MANUAL

This manual explains how to use the MX-M1056/MX-M1206 digital multifunctional system.

## Please note

- For information on installing the drivers and software cited in this manual, please refer to the Software Setup Guide.
- For information on your operating system, please refer to your operating system manual or the online Help function.
- The explanations of screens and procedures in a Windows environment are primarily for Windows® 10. The screens may be different depending on the version of the operating system or the software application.
- The explanations of screens and procedures for use in a macOS environment generally assume that macOS 10.12 is being used and a PPD driver is installed. The screens may be different depending on the version of the operating system or the software application.
- Wherever "MX-xxxx" appears in this manual, please substitute your model name for "xxxx".
- Considerable care has been taken in preparing this manual. If you have any comments or concerns about the manual, please contact your dealer or nearest SHARP Service Department.
- This product has undergone strict quality control and inspection procedures. In the unlikely event that a defect or other problem is discovered, please contact your dealer or nearest SHARP Service Department.
- Aside from instances provided for by law, SHARP is not responsible for failures occurring during the use of the product or its options, or failures due to incorrect operation of the product and its options, or other failures, or for any damage that occurs due to use of the product.

## Warning

- Reproduction, adaptation or translation of the contents of the manual without prior written permission is prohibited, except as allowed under copyright laws.
- All information in this manual is subject to change without notice.

## Illustrations and the operation panel and touch panel shown in this manual





The peripheral devices are generally optional, however, some models include certain peripheral devices as standard equipment. The explanations in this manual assume that a multi bypass tray, large capacity tray, punch module, paper pass unit and curl correction unit is installed on the MX-M1206.

For some functions and procedures, the explanations assume that devices other than the above are installed.

The display screens, messages, and key names shown in the manual may differ from those on the actual machine due to product improvements and modifications.

## Icons used in the manuals

The icons in the manuals indicate the following types of information:

|   |  |   |   |
|---|--|---|---|
|  | This alerts you to a situation that could result in death or serious personal injury. This alerts you to a situation that could result in personal injury or damage to properties. |  | This explains how to stop or correct an operation.      |
|  | This alerts you to a situation where there is a risk of machine damage or failure.   |  | This describes a routine work relevant to setting mode. |
|  | This supplements function or operation procedure.  |   |   |



# BEFORE USING THE MACHINE

## BEFORE USING THE MACHINE

|  |             |
|--|-------------|
| <b>PART NAMES AND FUNCTION</b> .....   | <b>1-3</b>  |
| • EXTERIOR .....   | 1-3         |
| • INTERIOR .....   | 1-6         |
| • AUTOMATIC DOCUMENT FEEDER AND DOCUMENT GLASS .....                                 | 1-7         |
| • SIDE AND BACK .....  | 1-8         |
| • OPERATION PANEL .....  | 1-9         |
| <b>TURNING ON THE POWER</b> .....  | <b>1-10</b> |
| <b>HOME SCREEN AND PREVIEW SCREEN</b> .....  | <b>1-11</b> |
| • HOME SCREEN .....  | 1-11        |
| • PREVIEW SCREEN .....   | 1-14        |
| <b>Eco</b> .....   | <b>1-21</b> |
| • ECO FUNCTIONS OF THE MACHINE .....   | 1-21        |
| • AUTO POWER SHUT-OFF MODE .....   | 1-22        |
| • PREHEAT MODE .....   | 1-23        |
| • AS SOON AS THE REMOTE JOB IS FINISHED, ENTER AUTO POWER SHUT OFF MODE .....        | 1-23        |
| • Power ON/OFF Schedule Setting .....  | 1-26        |
| • Specific Date Operation Settings .....   | 1-27        |
| • DISPLAYING ECO RECOMMENDATION SETTINGS (ECO RECOMMENDATION FUNCTION DISPLAY) ..... | 1-28        |
| • Toner Save Mode .....  | 1-28        |
| <b>USER AUTHENTICATION</b> .....   | <b>1-29</b> |
| • AUTHENTICATION BY USER NUMBER .....  | 1-29        |
| • AUTHENTICATION BY LOGIN NAME/PASSWORD .....  | 1-31        |
| • QUICK AUTHENTICATION .....   | 1-34        |

|   |             |
|---|-------------|
| <b>User Control</b> .....                               | <b>1-37</b> |
| • User List .....                                       | 1-37        |
| • Default Settings .....                                | 1-41        |
| • Administration Settings .....                         | 1-45        |
| • Actions when the user is authenticated .....          | 1-46        |
| • Card Reader Settings .....                            | 1-47        |
| • Pages Limit Group .....                               | 1-48        |
| • Machine Page Limit Setting .....                      | 1-48        |
| • Authority Group .....                                 | 1-49        |
| • Favorite Operation Group .....                        | 1-53        |
| • User Count .....                                      | 1-55        |
| • ACTIVE DIRECTORY LINKING FUNCTION .....               | 1-57        |
| <b>BILLING CODE</b> .....                               | <b>1-61</b> |
| • BILLING CODE .....                                    | 1-61        |
| • USE BILLING CODE .....                                | 1-62        |
| • REGISTERING A NEW BILLING CODE .....                  | 1-65        |
| • EDITING OR DELETING THE REGISTERED BILLING CODE ..... | 1-68        |
| • Billing Code Setting .....                            | 1-71        |
| <b>NAS</b> .....  | <b>1-74</b> |
| <b>REMOTE OPERATION OF THE MACHINE</b> .....            | <b>1-76</b> |
| <b>UNIVERSAL DESIGN IN THE MACHINE</b> .....            | <b>1-78</b> |
| • UNIVERSAL DESIGN RELATED TO OPERATION .....           | 1-78        |
| • UNIVERSAL DESIGN RELATED TO VISION .....              | 1-79        |
| • UNIVERSAL DESIGN RELATED TO HEARING .....             | 1-79        |
| • UNIVERSAL DESIGN FEATURES .....                       | 1-80        |
| <b>ITEMS RECORDED IN THE JOB LOG</b> .....              | <b>1-82</b> |
| <b>PRINTING A MANUAL FROM THE OPERATION PANEL</b> ..... | <b>1-84</b> |







**LOADING PAPER**

**IMPORTANT POINTS ABOUT PAPER** ..... 1-85

- NAMES AND LOCATIONS OF TRAYS ..... 1-85
- THE DEFINITION OF "R" IN PAPER SIZE .... 1-86
- APPLICABLE PAPER TYPES ..... 1-86

**LOADING PAPER IN THE TRAY 1/2** ..... 1-90

**LOADING PAPER IN THE TRAY 3/4** ..... 1-93

**LOADING PAPER IN THE LARGE CAPACITY TRAY** ..... 1-97

**LOADING PAPER IN THE LARGE CAPACITY TRAYS** ..... 1-99

**LOADING PAPER INTO THE BYPASS TRAY** .... 1-104

- PAPER SETTINGS IN THE SYSTEM SETTINGS ..... 1-110

**HOW TO PLACE THE ORIGINAL**

**SELECTING A PROCEDURE FOR PLACING THE ORIGINAL DEPENDING ON THE TYPE AND STATUS OF THE ORIGINAL** ..... 1-114

**AUTOMATIC DOCUMENT FEEDER** ..... 1-116

**PREVENTIVE LIGHT TO INDICATE ORIGINAL LEFT BEHIND** ..... 1-119

**DOCUMENT GLASS** ..... 1-120

**PERIPHERAL DEVICES**

**PERIPHERAL DEVICES** ..... 1-122

**FINISHER (LARGE STACKER)** ..... 1-124

- PART NAMES ..... 1-124
- SUPPLIES ..... 1-125
- REPLACING THE STAPLE CARTRIDGE ..... 1-125

**SADDLE STITCH FINISHER (LARGE STACKER)** 1-129

- PART NAMES ..... 1-129
- SUPPLIES ..... 1-130
- REPLACING THE CARTRIDGE ..... 1-130

**PUNCH MODULE (MX-PN13A/B/C/D)** ..... 1-138

- DISCARDING PUNCH WASTE ..... 1-138

**FOLDING UNIT** ..... 1-140

- PART NAMES ..... 1-140

**INSERTER** ..... 1-141

- PART NAMES ..... 1-141

**STATUS INDICATORS** ..... 1-142

- PART NAMES ..... 1-142

**Sharp OSA** ..... 1-143

- APPLICATION COMMUNICATION ..... 1-143
- EXTERNAL ACCOUNT APPLICATION ..... 1-144
- Sharp OSA Settings ..... 1-146

**REMOVING MISFEEDS**

**REMOVING MISFEEDS** ..... 1-150

**MAINTENANCE**

**REGULAR MAINTENANCE** ..... 1-151

- CLEANING THE DOCUMENT GLASS AND AUTOMATIC DOCUMENT FEEDER ..... 1-151
- CLEANING THE BYPASS FEED ROLLER ..... 1-153
- CLEANING THE PAPER FEED ROLLER ..... 1-155

**REPLACEMENT OF TONER CARTRIDGE** ..... 1-156

**REPLACING THE WASTE TONER BOTTLE** ..... 1-159

**REPLACING THE STAMP CARTRIDGE** ..... 1-160



# BEFORE USING THE MACHINE

## PART NAMES AND FUNCTION EXTERIOR

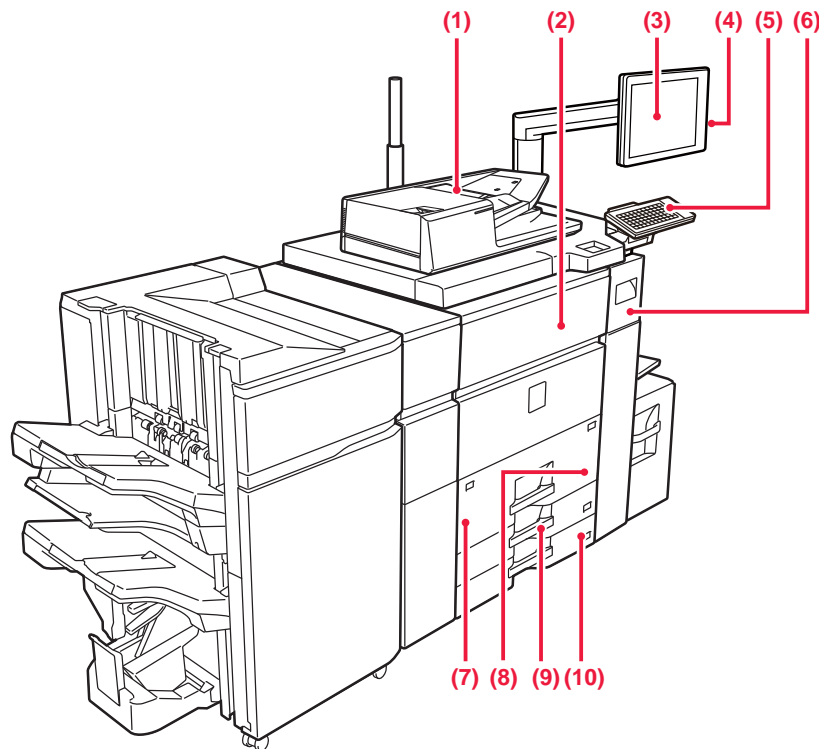

- (1) **Automatic document feeder**  
This automatically feeds and scans multiple originals. Both sides of 2-sided originals can be automatically scanned at one time.  
► [AUTOMATIC DOCUMENT FEEDER \(page 1-116\)](#)
- (2) **Front cover**  
Open this cover to switch the main power switch to "On" or "Off".  
► [TURNING ON THE POWER \(page 1-10\)](#)
- (3) **Operation panel**  
This panel hosts the [Power] button, [Power Save] button/indicator, [Home Screen] button/indicator, main power indicator and touch panel. Use the touch panel to operate each of these functions. Use the touch panel to operate each of these functions.  
► [OPERATION PANEL \(page 1-9\)](#)
- (4) **USB connector (A type)**  
This is used to connect a USB device such as a USB memory device to the machine. Supports USB 2.0 (Hi-Speed).
- (5) **Keyboard**  
Use this as a substitute for the soft keyboard displayed on the touch panel.
- (6) **Toner cover**  
Open this cover to replace the toner cartridge.  
[REPLACEMENT OF TONER CARTRIDGE \(page 1-156\)](#)
- (7) **Tray 1**  
Store paper in this tray. Up to 1200 sheets can be stored.  
► [LOADING PAPER IN THE TRAY 1/2 \(page 1-90\)](#)
- (8) **Tray 2**  
Store paper in this tray. Up to 800 sheets can be stored.  
[LOADING PAPER IN THE TRAY 1/2 \(page 1-90\)](#)
- (9) **Tray 3**  
Store paper in this tray. Up to 500 sheets can be stored.  
► [LOADING PAPER IN THE TRAY 3/4 \(page 1-93\)](#)
- (10) **Tray 4**  
Store paper in this tray. Up to 500 sheets can be stored.  
► [LOADING PAPER IN THE TRAY 3/4 \(page 1-93\)](#)

\* Optional

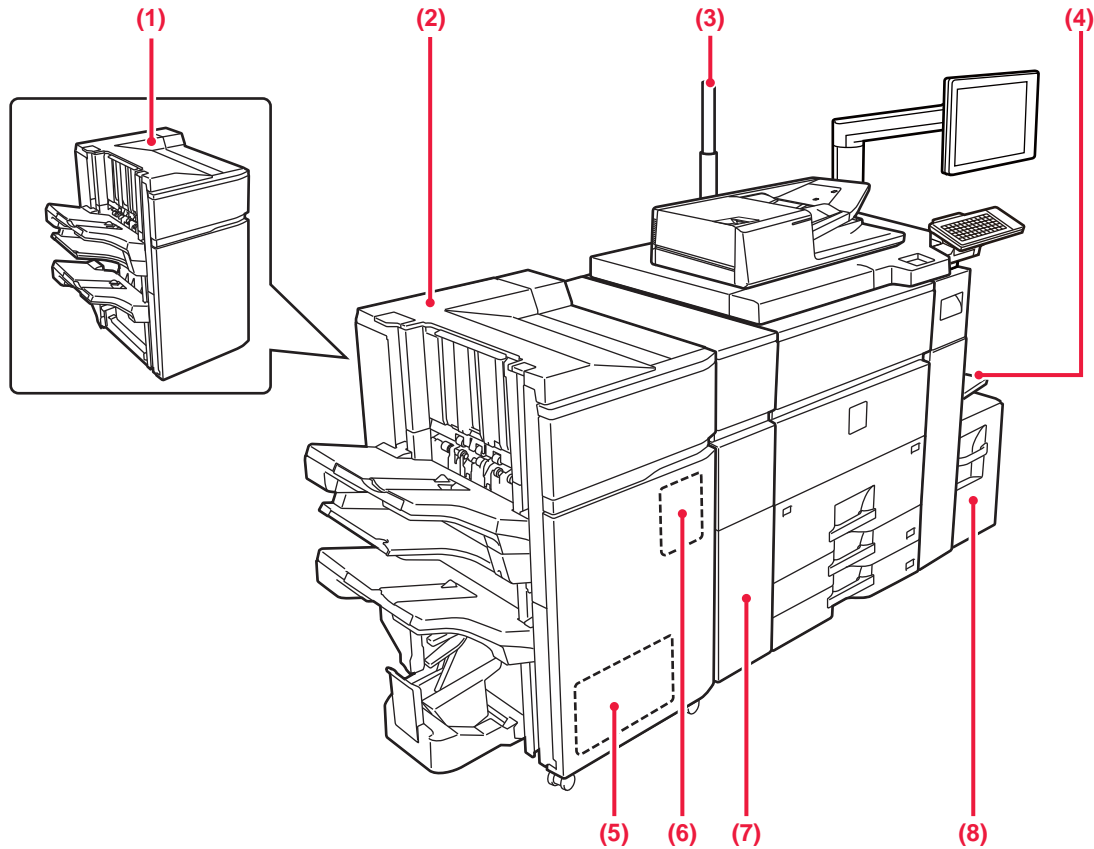

**(1) Finisher (large stacker)\***

This staples paper. A punch module can also be installed to punch holes in output paper.

► [FINISHER \(LARGE STACKER\) \(page 1-124\)](#)

**(2) Saddle stitch finisher (large stacker)\***

This staples and folds paper. A punch module can also be installed to punch holes in output paper. You can also perform stapling manually.

► [SADDLE STITCH FINISHER \(LARGE STACKER\) \(page 1-129\)](#)

**(3) Status indicator\***

The status of the machine is indicated.

► [STATUS INDICATORS \(page 1-142\)](#)

**(4) Bypass tray**

Use this tray to feed paper manually.

When loading paper larger than 8-1/2" x 11"R or A4R, pull out the extension guide.

► [LOADING PAPER INTO THE BYPASS TRAY \(page 1-104\)](#)

**(5) Trimming module\***

This trims the excess of saddle-stitched output.

**(6) Punch module\***

This punches and outputs paper.

**(7) Curl correction unit\***

This punches and outputs paper.

**(8) Tray 5 (MX-LC12)\***

Store paper in this tray. Up to 3500 sheets can be stored.

\* Optional

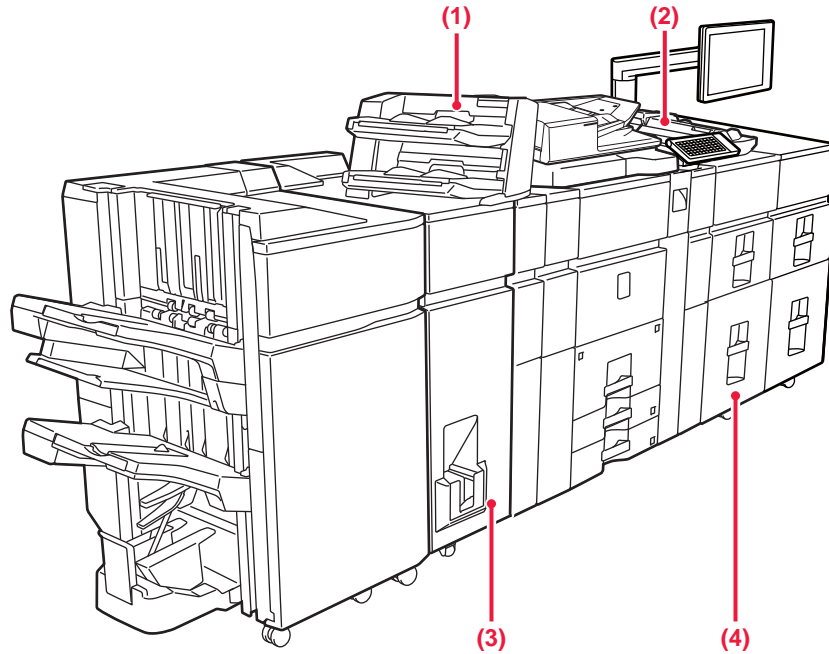

**(1) Bypass tray\***

Use this tray to feed paper manually.  
When loading paper larger than 8-1/2" × 11"R or A4R,  
pull out the extension guide.  
► [LOADING PAPER INTO THE BYPASS TRAY \(page 1-104\)](#)

**(2) Inserter\***

Covers and insertion sheets to be inserted into printed sheets can be loaded.  
Using the manual finishing function, you can directly feed paper into the finisher or saddle stitch finisher to staple, punch or fold the paper.

**(3) Folding unit\***

This folds and outputs paper.

\* Optional

**(4) Large capacity trays\***

Store paper in this tray. Up to 2500 sheets can be stored in each tray.  
► [LOADING PAPER IN THE LARGE CAPACITY TRAY \(page 1-97\)](#)



# INTERIOR

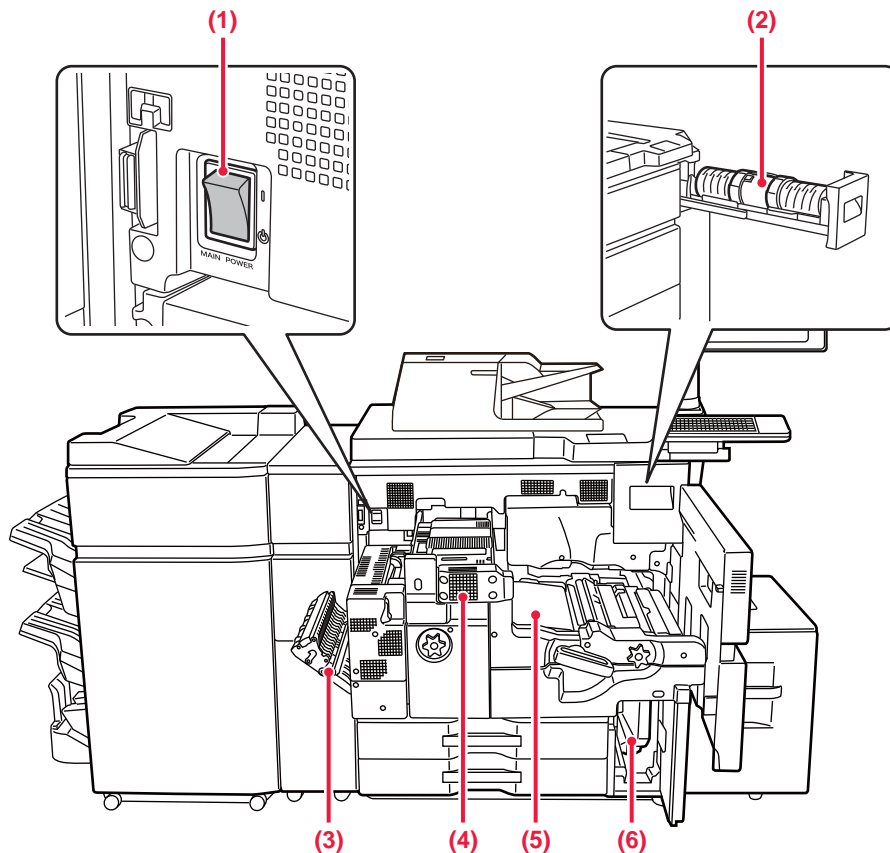

**(1) The main power switch**

Use this switch to turn on the power for the machine.

► [TURNING ON THE POWER \(page 1-10\)](#)

**(2) Toner cartridge**

This cartridge contains toner.

When the toner in a cartridge runs out, the cartridge out must be replaced.

► [REPLACEMENT OF TONER CARTRIDGE \(page 1-156\)](#)

**(3) Paper reversing section cover**

This unit is used for reversing paper when 2-sided printing is performed. Open this cover to remove a paper misfeed.

**(4) Fusing unit**

Heat is applied here to fuse the transferred image onto the paper.

 The fusing unit is hot. Take care not to burn yourself when removing a misfeed.

**(5) Transfer belt**

This belt takes the image formed with toner off the photoconductive unit and transfers the image onto paper.

 Do not touch or damage the transfer belt. This may cause a defective image.

**(6) Waste toner bottle**

This bottle collects excess toner that is produced during printing.

► [REPLACING THE WASTE TONER BOTTLE \(page 1-159\)](#)

 A service technician collects replaced waste toner bottles.



# AUTOMATIC DOCUMENT FEEDER AND DOCUMENT GLASS

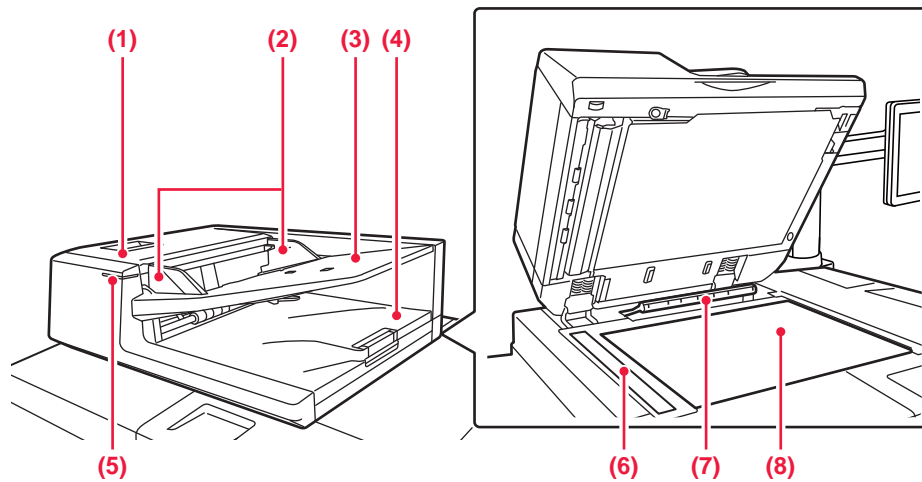

- (1) Document feeding cover**  
Open this cover to remove an original misfeed.  
► [CLEANING THE PAPER FEED ROLLER \(page 1-155\)](#)
- (2) Original guides**  
These guides help ensure that the original is scanned correctly.  
Adjust the guides to the width of the original.
- (3) Document feeder tray**  
Place the original.  
Place the original with the print side facing up.  
► [AUTOMATIC DOCUMENT FEEDER \(page 1-116\)](#)
- (4) Original exit tray**  
The original is discharged to this tray after scanning.
- (5) Original setting indicator**  
This indicator lights up when originals are placed on the document feeder tray.  
► [AUTOMATIC DOCUMENT FEEDER \(page 1-116\)](#)
- (6) Scanning area**  
Originals placed in the automatic document feeder tray are scanned here.  
► [CLEANING THE DOCUMENT GLASS AND AUTOMATIC DOCUMENT FEEDER \(page 1-151\)](#)
- (7) Original size detector**  
This unit detects the size of an original placed on the document glass.  
► [DOCUMENT GLASS \(page 1-120\)](#)
- (8) Document glass**  
If you want to scan books or other thick originals that cannot be fed through the automatic document feeder, place them on this glass.  
► [DOCUMENT GLASS \(page 1-120\)](#)



## SIDE AND BACK

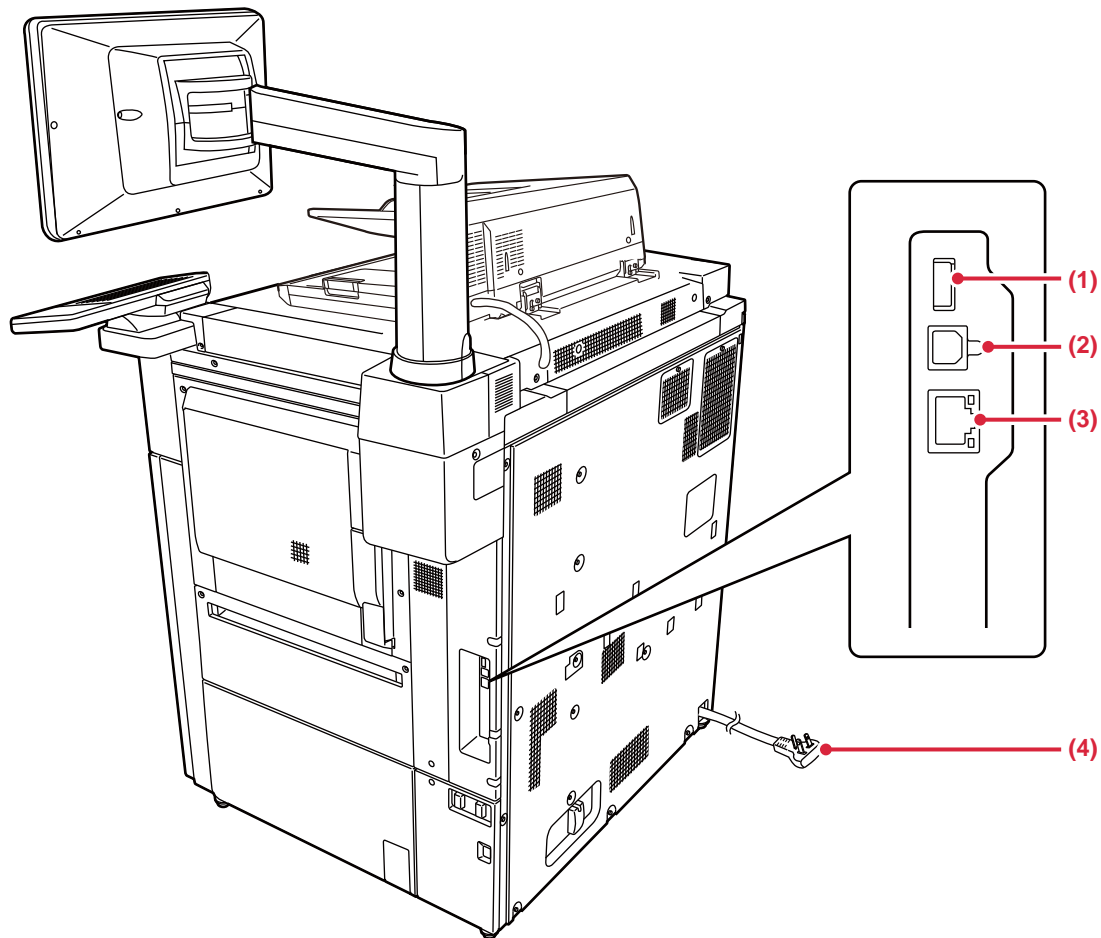

- (1) **USB connector (A type)**  
This is used to connect a USB device such as a USB memory device to the machine.  
Supports USB 2.0 (Hi-Speed).
- (2) **USB connector (B type)**  
Cannot be used.
- (3) **LAN connector**  
Connect the LAN cable to this connector when the machine is used on a network.  
Use a shielded LAN cable.
- (4) **Power plug**



# OPERATION PANEL

This section describes the names and functions of the respective parts of the operation panel.

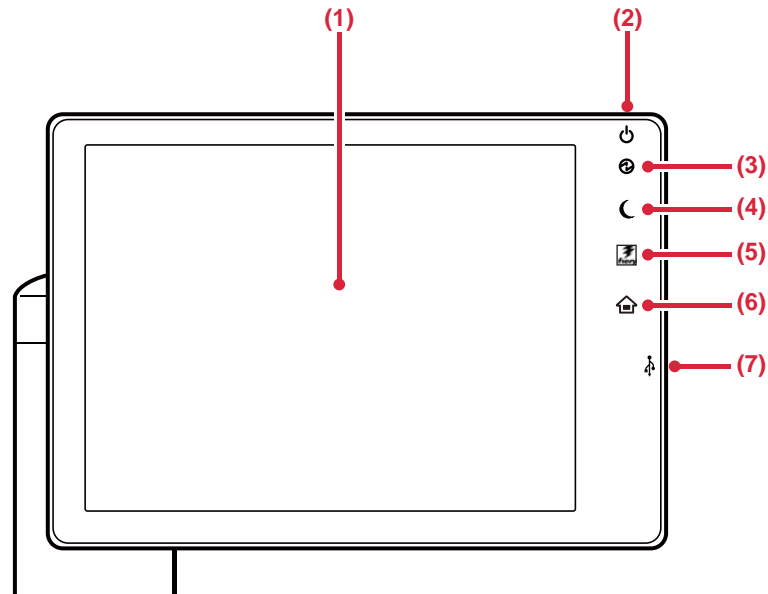

## (1) Touch panel

Messages and keys appear on the touch panel display. Operate the machine by directly tapping the displayed keys.

► [HOME SCREEN \(page 1-11\)](#)

## (2) [Power] button

Use this button to turn the machine's power on and off.

► [TURNING ON THE POWER \(page 1-10\)](#)

## (3) Main power indicator

This lamp lights up when the machine's main power switch is in the "I" position.

► [TURNING ON THE POWER \(page 1-10\)](#)

## (4) [Power Save] button/indicator

Use this button to set the machine to Sleep mode for energy saving.

[Power Save] button blinks when the machine is in Sleep Mode.

► [AUTO POWER SHUT-OFF MODE \(page 1-22\)](#)

## (5) [Fiery] key

When the Fiery Server (option) is installed, use this button to switch the Fiery Web LCD screen.

## (6) [Home Screen] key

Use this button to display the home screen.

► [HOME SCREEN \(page 1-11\)](#)

## (7) USB connector (A type)

This is used to connect a USB device such as a USB memory device to the machine. For the USB cable, use a shielded cable. Supports USB 2.0 (Hi-Speed).

### [Home Screen] key

Use your finger to touch the [Home Screen] key.

If you use a pen or other tool to touch the key, it may not operate properly.

Risk of malfunctioning if you use with jewelry or other accessories.

You can change the angle of the touch panel and keyboard.

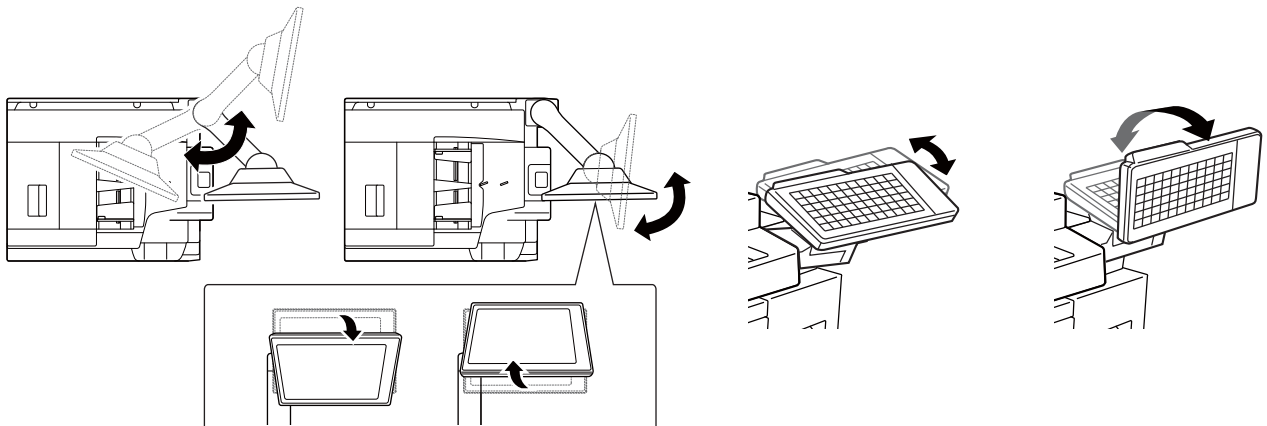





# TURNING ON THE POWER

This section describes how to turn on/off the machine's power and how to restart the machine.

Operate two power switches: the main power switch inside the front cover, located in the lower left corner, and the [Power] button on the operation panel.

## Turning on the power

- Turn the main power switch to the " | " position.
- When the main power indicator lights in green, press the [Power] button.

## Turning off the power

Turn off the power by pressing the [Power] button, then turn the main power switch to the " ⏻ " position.

## Restart the machine

Turn off the power by pressing the [Power] button and then press it again to turn on the power.

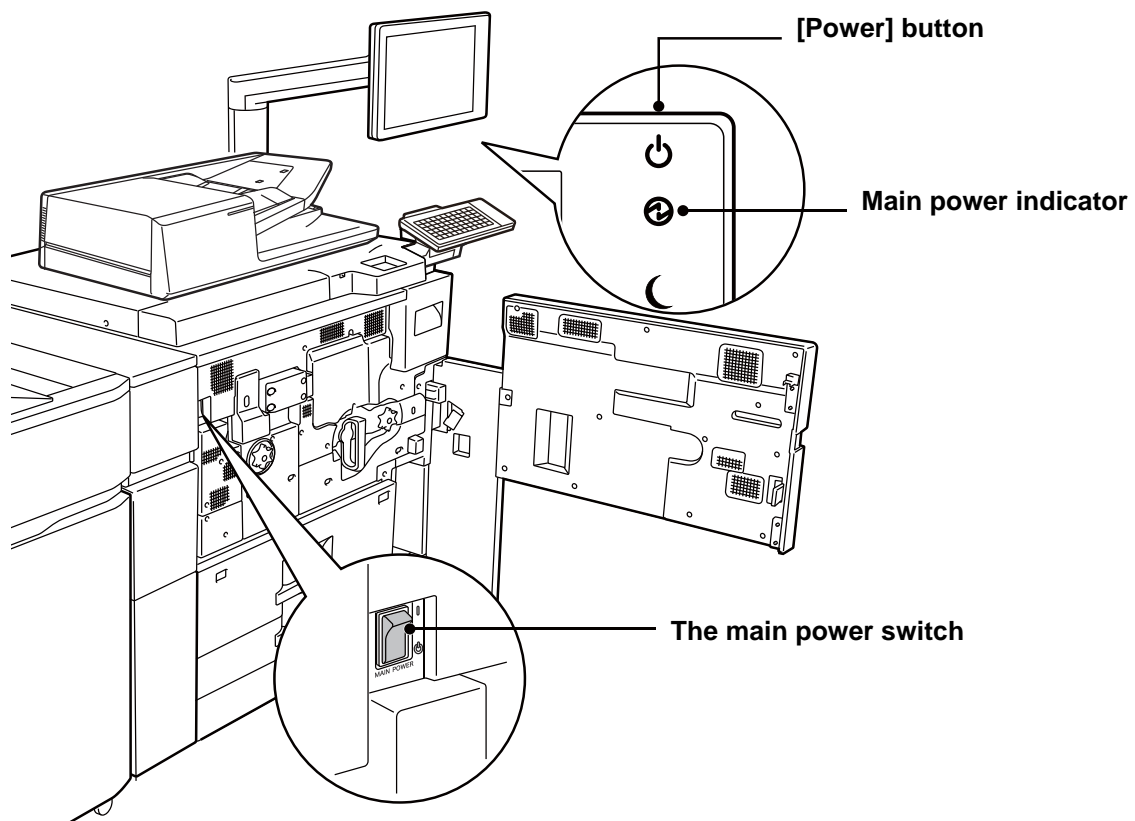

- When turning off the main power switch, press the [Power] button on the operation panel and then turn the main power switch to the " ⏻ " position.  
In a sudden case of main power outage, turn the power for the machine back on and then turn it off in the correct order. If the machine is left for a long time with the main power having been turned off prior to the [Power] button being turned off, abnormal noises, degraded image quality or other problems may result.
- Turn off both the [Power] button and the main power switch and unplug the power cord if you suspect a machine failure, if there is a bad thunderstorm nearby, or when you are moving the machine.



- In order for some settings to take effect, the machine must be restarted. In some states of the machine, restarting with the [Power] button may not make the settings take effect. In this case, turn off the main power switch and then turn it on again.



# HOME SCREEN AND PREVIEW SCREEN

## HOME SCREEN

Pressing the [Home Screen] key on the operation panel displays the home screen on the touch panel. The home screen displays the keys for selecting modes or functions.

Displays the machine's status other than the job using icons.  
▶ [Icon indicating the status of the machine \(page 1-12\)](#)

Displays the time.

Displays the job in progress or waiting with text or icon.

Tap a mode to change to that mode.  
▶ [Changing mode from the mode display \(page 1-13\)](#)

Select shortcut keys for modes or functions.  
▶ [Changing mode from the Home screen \(page 1-13\)](#)

Use these keys to select functions that make the machine easier to use.

Select functions that can be utilized in respective modes. Tap the tab, and the list of function keys is displayed.

Switch the pages for displaying shortcut keys.

For procedures for adding and deleting shortcut keys, see "User's Manual (Touch Panel Operation)".



### To set the home screen for each "Favorite Operation Group List":

In "Settings (administrator)", select [User Control] → [Access Control Settings] → [Favorite Operation Group] → [Home Screen List].

Perform this setting when user authentication is used.



## Icon indicating the status of the machine

| Icon | Machine status                           |
|------|--|
|      | Printer data is being processed.         |
|      | Printer data is being printed.           |
|      | Send data exists.                        |
|      | OSA communication is in progress.        |
|      | Enlarge display mode is enabled.         |
|      | A USB device is installed.               |
|      | The field support system is enabled.     |
|      | Single-byte alphanumeric character entry |
|      | A data security kit is installed.        |
|      | Eco mode is enabled.                     |
|      | A maintenance notification is issued.    |
|      | Remote operation is in progress.         |
|      | A LAN cable is not connected.            |

\* Contact your dealer or nearest SHARP Service Department.



## CHANGING MODES

### Changing mode from the Home screen

Press the [Home Screen] key.

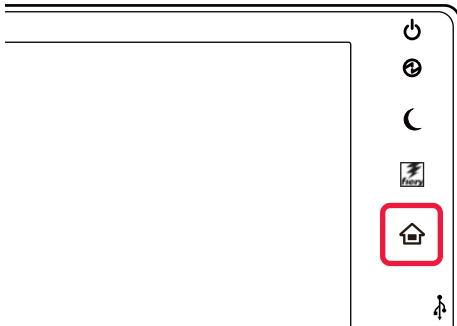

Tap the mode icon.

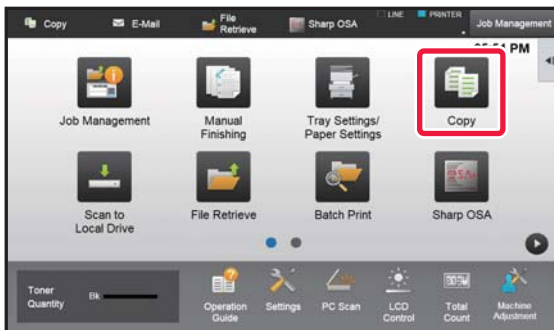

### Changing mode from the mode display

Tap on the mode display.



Tap the key that shows ▼.



Tap for any mode desired.

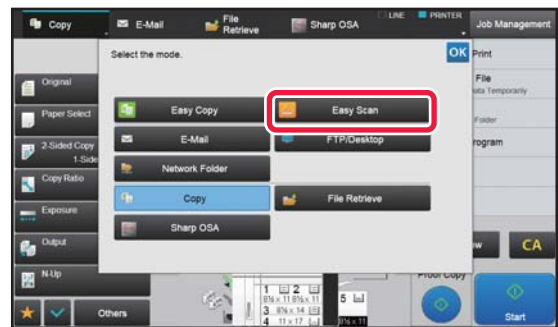

For procedures for editing the home screen, see "User's Manual (Touch Panel Operation)".



#### • Mode Key Display Setting

In "Settings (administrator)", select [System Settings] → [Common Settings] → [Operation Settings] → [Mode Key Display Setting].

Configure settings for the display of mode keys at the top of the screen.

#### • Modes to Display

Select the mode keys that you want to display.

#### • Display Mode Keys on Home

You can enable display of the mode keys in the home screen as well.



# PREVIEW SCREEN

In the preview screen, you can view output images or images stored in the machine using the touch panel.

## In Easy mode

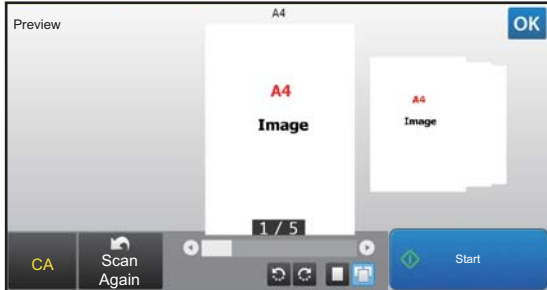

## In Normal mode

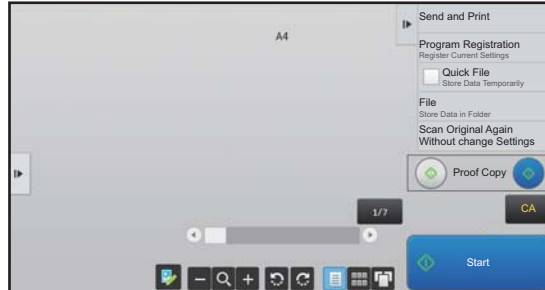

## Keys used in the preview screen

|  |  |  |  |
|--|--|--|--|
|  | This changes the mode to edit mode. Pages of the original can be changed, rotated, or deleted.   |  | This rotates the preview image of whole page in the arrow's direction. The printing result is not rotated. |
|  | This reduces the image.  |  | This displays preview images of respective pages.  |
|  | This displays the scroll bar for enlargement/reduction operations. Moving the slider to the left reduces the image, and moving the slider to the right enlarges the image. |  | This displays thumbnails of preview images.  |
|  | This enlarges the image.   |  | This displays pages in a 3D view.  |

\* Can also be used in Easy mode.



- The display position of an image can be moved by dragging it while it is enlarged.
- To enlarge an image, double-tap it when the preview image is displayed by page.



## Preview Setting

Configure preview settings and settings such as specifying thumbnail view as the default setting for display of Document Filing and other files.

In "Settings (administrator)", select [System Settings] → [Common Settings] → [Operation Settings] → [Condition Settings] → [Preview Setting].

### Default List/Thumbnail Display

- File Retrieve of Main Folder/Quick File Folder: Select whether the default display format of the document filing main folder and temporary folder screens is list or thumbnails.
- File Retrieve of Custom Folder: Select whether the default display format of the document filing custom folder screen is list or thumbnails.
- File Retrieve of Direct Print: Select whether the default state of the folder screen for direct print shows the folders as a list or as thumbnails.



## Deleting a page

1

In the preview screen, tap to switch to edit mode.

2

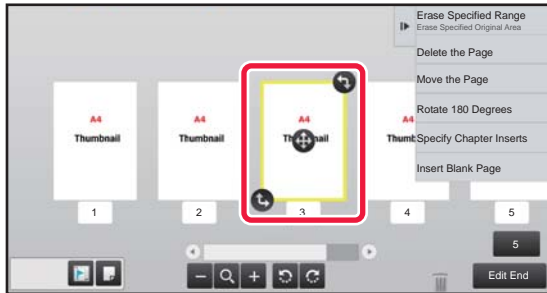

Tap the page you want to delete, and tap .



- You can also delete the page by tapping [Delete the Page] on the action panel.
- You can also delete the page by dragging a page to .

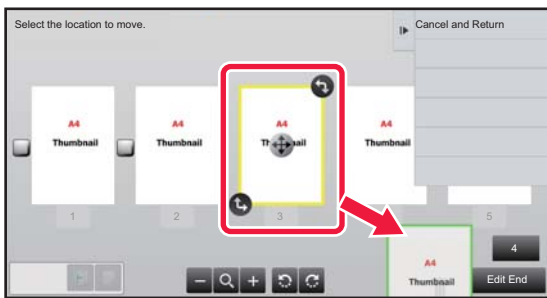

- To undo the deletion, tap . To redo the deletion, tap .

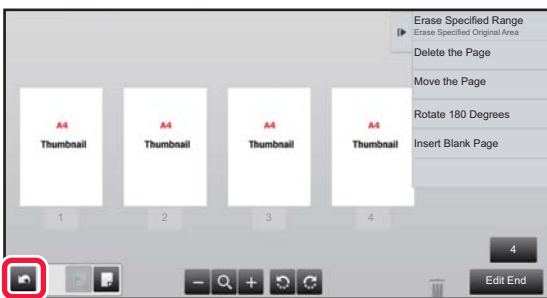

3

Tap the [Edit End] key.





## Moving a page

1

In the preview screen, tap  to switch to edit mode.

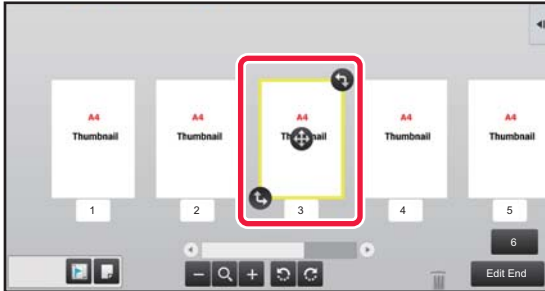
2



Tap the page you want to move, and drag  to move the page.



You can also move the page by tapping [Move the Page] on the action panel and then tap  of the destination.

3

Tap the [Edit End] key.



## Rotating a page

1

In the preview screen, tap  to switch to edit mode.

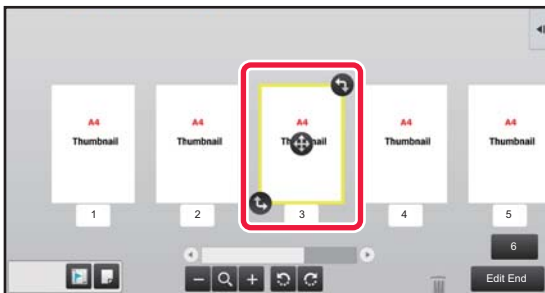
2



Tap the page you want to rotate, and drag  or  to rotate the page.



You can also rotate the page by tapping [Rotate 180 Degrees] (Copy mode only) or [Rotate 90 Degrees] (Scanner mode only) on the action panel.

3

Tap the [Edit End] key.





## Setting chapter inserts

When N-Up or 2-Sided is specified, you can move a page marked with  to the first page.

1

In the preview screen, tap  to switch to edit mode.

2

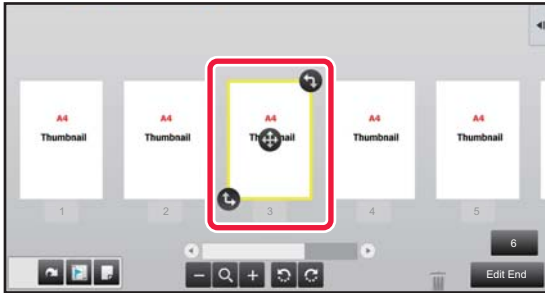

Tap the page you want to set chapter inserts.

3

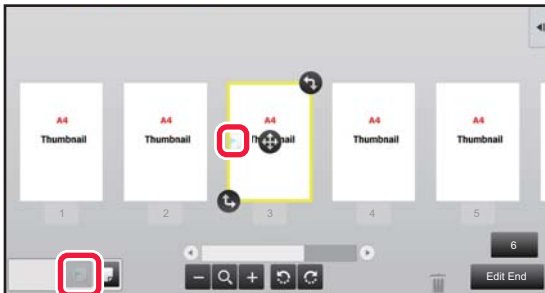

Tap .

 is displayed on the page.



• You can also set chapter inserts by tapping [Specify Chapter Inserts] on the action panel.

• **To cancel the Chapter Inserts setting:**

Tap  displayed on the page, or select the page and tap [Cancel Chapter Inserts of Selected Page.] on the action panel.

4

Tap the [Edit End] key.



## Inserting a blank page

1

In the preview screen, tap  to switch to edit mode.

2

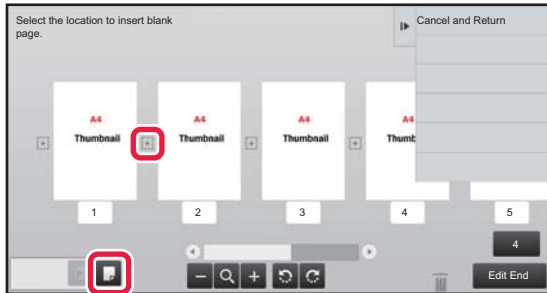

Tap , and tap  for the location into which you want to insert a blank page.



You can also insert a blank page by tapping [Insert Blank Page] on the action panel.

3

Tap the [Edit End] key.

## Deleting part of the original image

1

In the preview screen, tap  to switch to edit mode.

2

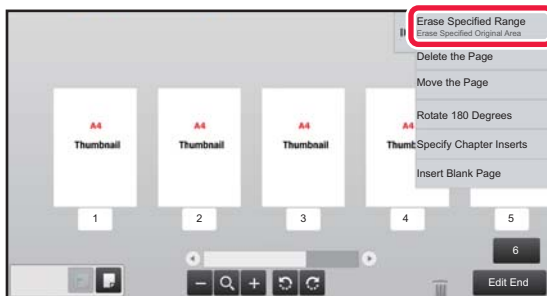

Tap [Erase Specified Range] on the action panel.



3

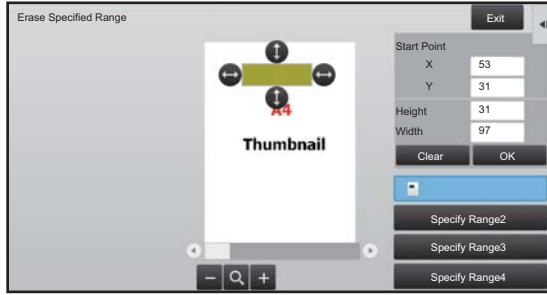

Follow the on-screen instructions to specify the erase range.

Specify the erase range and then tap the [Execute] key.



To delete the image outside the selected range, tap [Reverse Erase Range] on the action panel.

4

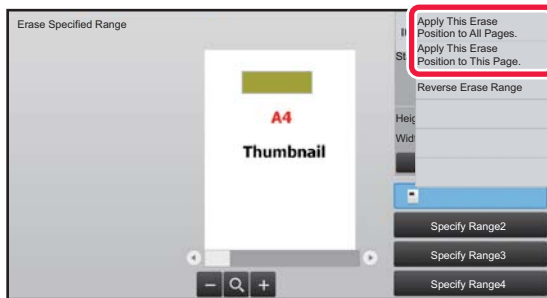

On the action panel, select [Apply This Erase Position to All Pages.] or [Apply This Erase Position to This Page.].

5

As necessary, repeat the steps to specify the erase range and the pages to which it is applied.

6



Tap the [Exit] key.

## Changing the settings

Tapping the tab on the left of the screen allows you to change the settings. You cannot tap the keys for functions whose settings cannot be changed.

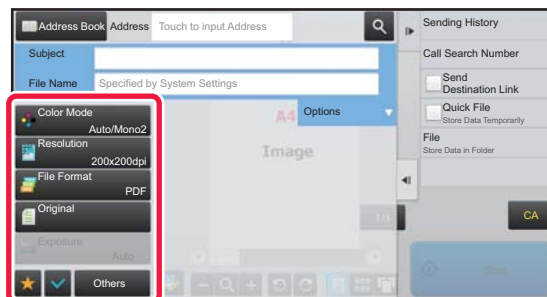
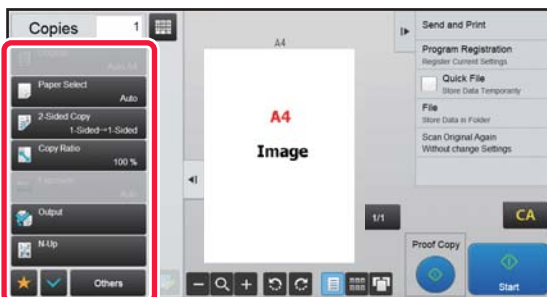



# Eco

## ECO FUNCTIONS OF THE MACHINE

These functions help save power consumption by managing operations of sections prone to high power consumption. The machine provides two power-saving modes.

| Function                                 | Description  | Page                 |
|--|--|----------------------|
| <a href="#">AUTO POWER SHUT-OFF MODE</a> | If no operations take place, this mode will turn off the power to the operation panel and the fusing unit, and makes the machine wait in the lowest power consumption state.<br>Although the power-saving rate is higher, the wakeup time is longer. | <a href="#">1-22</a> |
| <a href="#">PREHEAT MODE</a>             | This mode lowers the temperature of the fusing unit and makes the machine wait in low power consumption state.<br>Compared to Auto Power Shut-Off mode, the power-saving rate is lower, but the wakeup time is shorter.                              | <a href="#">1-23</a> |

In addition to these two modes, using the following functions in conjunction helps reduce even more power consumption.

| Function   | Description   | Page                 |
|--|---|----------------------|
| <a href="#">DISPLAYING ECO RECOMMENDATION SETTINGS (ECO RECOMMENDATION FUNCTION DISPLAY)</a> | Shows recommended copy/print settings for copy, document filing reprint, and direct print.  | <a href="#">1-28</a> |
| <a href="#">AS SOON AS THE REMOTE JOB IS FINISHED, ENTER AUTO POWER SHUT OFF MODE</a>        | The machine returns from Auto Power Shut-Off and enters Auto Power Shut-Off mode as soon as printing is completed.  | <a href="#">1-23</a> |
| <a href="#">ECO SCAN</a>   | The machine is operated with the fusing unit turned off for non-printing operations (that do not use the fusing unit) such as image transmission.   | <a href="#">1-25</a> |
| <a href="#">Power ON/OFF Schedule Setting</a>  | Use this function to set the times for turning the power on and off to reduce power consumption.  | <a href="#">1-26</a> |
| <a href="#">Specific Date Operation Settings</a>   | When you must have the machine perform exceptionally many print jobs or other special operation on a certain day, you can specify the day as a "Specific Date" and define an energy saving pattern only for that day. | <a href="#">1-27</a> |
| <a href="#">Toner Save Mode</a>  | This mode is used to reduce toner consumption.  | <a href="#">1-28</a> |
| <a href="#">Sleep Mode Power Level</a>   | Level Select whether priority is given to power saving or wakeup time.  | <a href="#">1-24</a> |



## Mode Settings

The eco function settings are set in a batch. "Custom Mode" and "Eco Mode" are available. Setting values applied by each mode is as follows.

| Function   | Custom Mode                  | Eco Mode                    |
|--|------------------------------|-----------------------------|
| Preheat Mode Setting   | 1min.                        | 1min.                       |
| Turn off Panel Display during pre-heat mode                            | On                           | On                          |
| Auto Power Shut-Off Timer  | Fix transition time.: 15min. | Fix transition time.: 1min. |
| As soon as the remote job is finished, enter Auto power shut off mode. | On                           | On                          |
| Sleep Mode Power Level   | Low Power                    | Low Power                   |
| Eco Scan   | On                           | On (All Modes Except Copy)  |

Each Energy Save settings in System Settings is not applied when Custom/Eco mode is used.



### To set mode settings

"Settings (administrator)" → select [System Settings] → [Energy Save] → [Eco Setting] → [Mode Setting].

## AUTO POWER SHUT-OFF MODE

This mode turns off the power to the operation panel and the fusing unit, and makes the machine wait in the lowest power consumption state.

Auto Power Shut-Off mode will activate when the set duration of time elapses in waiting status without executing a job. Compared to preheat mode, the power-saving rate is considerably higher but the wakeup time is longer.

The [Power Save] button blinks when the machine is in Auto Power Shut-Off mode.

Auto Power Shut-Off mode is also activated by pressing the [Power Save] button while the [Power Save] button is not lit. This mode is cleared when print data is being received, or when the [Power Save] button is pressed while it is blinking.

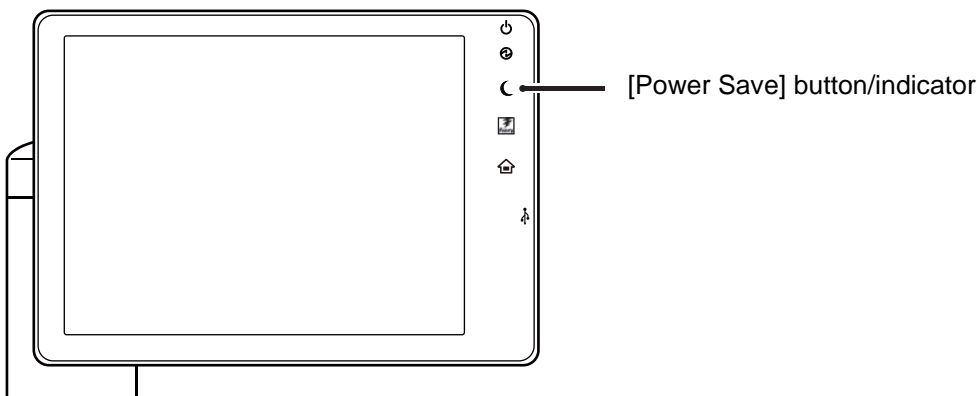

A message appears 15 seconds before Auto Power Shut-Off Mode is entered.

To close the message and continue normal operation, tap the [Continue] button.

The message appears again 15 seconds before the end of the extension of normal operation time.

If no action is taken within 15 seconds after the message appears, the machine enters auto power shutoff mode.



### To set display of the message:

In "Settings (administrator)", select [System Settings] → [Energy Save] → [Eco Setting] → [Display Message When Extending Transition Time to Preheat/Auto Power Shut-Off Mode].



## PREHEAT MODE

This mode lowers the temperature of the fusing unit and makes the machine wait in low power consumption state. Preheat mode will activate when the set duration of time elapses in waiting status without executing a job. Compared to Auto Power Shut-Off Mode, the amount of energy saved is less and the wakeup time is shorter. In the preheat mode, the [Home Screen] key is lit and the light goes off for the touch panel and the [Power Save] button. The touch panel is cleared when it is tapped or the [Home Screen] button is pressed.



### To set preheat mode:

"Settings (administrator)" → select [System Settings] → [Energy Save] → [Eco Setting] → [Preheat Mode Setting].

A message appears 15 seconds before Preheat Mode is entered.

To close the message and continue normal operation, tap the [Continue] button.

If no action is taken within 15 seconds after the message appears, the machine enters preheat mode.



### To set display of the message:

In "Settings (administrator)", select [System Settings] → [Energy Save] → [Eco Setting] → [Display Message When Extending Transition Time to Preheat/Auto Power Shut-Off Mode].

## AS SOON AS THE REMOTE JOB IS FINISHED, ENTER AUTO POWER SHUT OFF MODE

Printing in Auto Power Shut-Off Timer turns on the power, and then the machine returns to Auto Power Shut-Off Mode immediately after completing the print job.

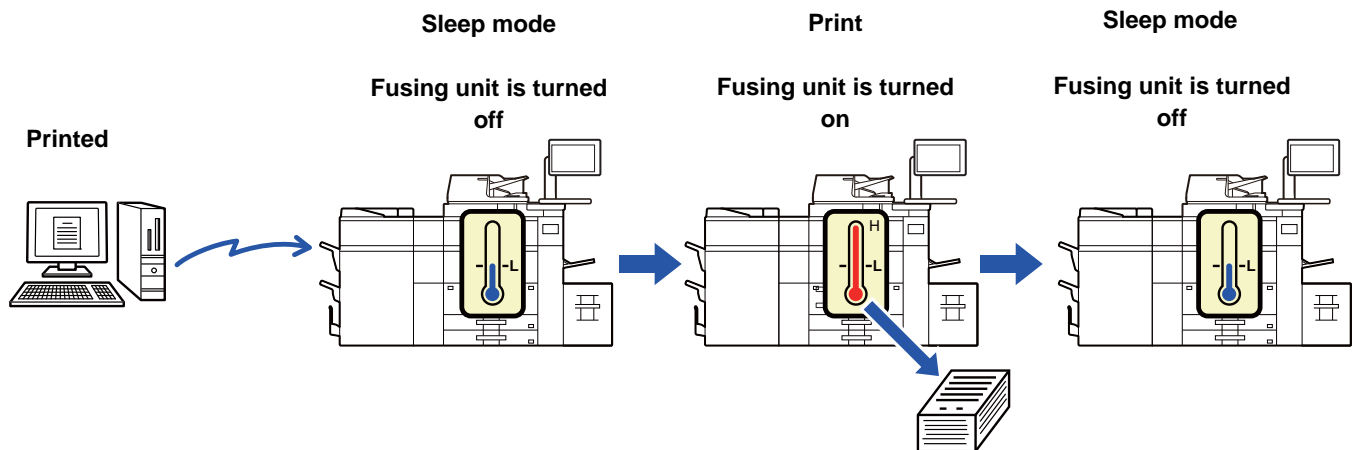

### To set "As soon as the remote job is finished, enter Auto power shut off mode.":

In "Settings (administrator)", select [System Settings] → [Energy Save] → [Eco Setting] → [As soon as the remote job is finished, enter Auto power shut off mode.].

## Fix transition time.

The Auto Power Shut-Off Timer is fixed. Select [Fix transition time.], and set the transition time in [Auto Power Shut-Off Timer].

When this setting is enabled, the [Change transition time by time of day.] option is disabled.



## Change transition time by time of day.

This function controls the transition to Auto Power Shut-Off mode optimally for each time period by analyzing the use of the machine based on job logs obtained during a 4-week period.

When this setting is enabled, the [Fix transition time.] option is disabled.



- The image transfer control settings are not changed.
- This does not link to the Power On/Off Scheduling. If both of them are enabled, the Power On/Off Scheduling settings precede.
- Pages are counted for each paper size separately.
- When the power supply of the machine was off, there was no job during this time.

### Transition to Energy Saving and Auto Power Shut-Off modes

| Pattern                         | Transition time   | Average outputs per hour * |
|---------------------------------|---|----------------------------|
| Mode1 (Job Start Priority1)     | After 1 hour  | 700 or more                |
| Mode2 (Job Start Priority2)     | After 30 minutes  | 150 to 699                 |
| Mode3 (Energy Saving Priority1) | After 5 minutes   | 40 to 149                  |
| Mode4 (Energy Saving Priority2) | After the minimum time period   | Up to 39                   |
| Sleep Mode Power Level          | <p>Low Power: The machine switches to the power saving mode, but it takes some time to recover.</p> <p>Fast Wake Up: Compared with Low Power, the power value rises by a certain degree, but it results in faster recovery.</p> | –                          |

\* Factory default setting

### Automatic

This function controls the power optimally for each time period by analyzing the use of machine based on job logs obtained during a certain time period.



If the machine does not have the 4-week job log information, the machine enters the template2 (Mode3 (Energy Saving Priority1) between 8:00 and 18:00 hours). Then after that, it enters Mode4 (Energy Saving Priority2).

### Sleep Mode Power Level

**Low Power:** The machine switches to the power saving mode, but it takes some time to recover.

**Fast Wake Up:** Compared with Low Power, the power value rises by a certain degree, but it results in faster recovery.



## ECO SCAN

Non-print jobs such as sending a scanned original are performed with the fusing unit turned off.

### Sleep mode

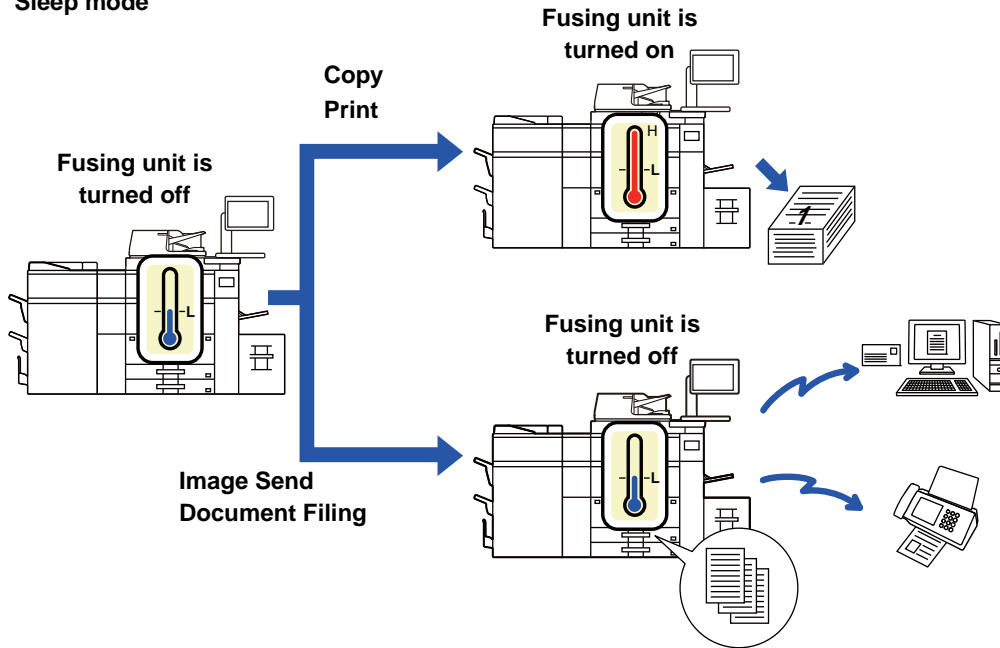

## Eco Scan Setting

Set "Eco Scan Setting" to , and select a mode or screen in which to enable Eco Scan Setting.

The following modes and screens can be set.

- Home Screen
- Copy
- Image Send
- Document Filing
- System Settings
- Sharp OSA



### To set Eco scan:

"Settings (administrator)" → select [System Settings] → [Energy Save] → [Eco Scan Setting] .





## Power ON/OFF Schedule Setting

The machine operator panel can be turned On or Off at a preset time. Up to three (3) patterns can be set. The "Setting 1", "Setting 2" and "Setting 3" are executed in this sequence if set at the same day of week or at the same clock time.

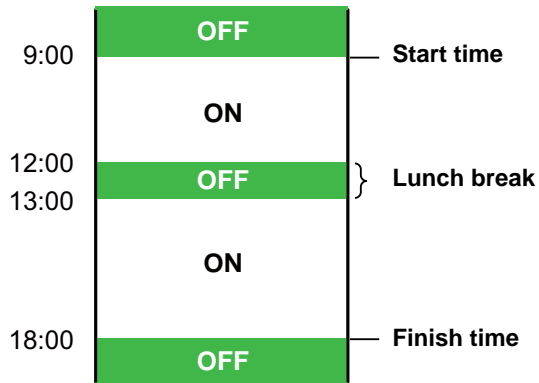

- The scheduling function does not support the power management settings in the Preheat Mode and Auto Power Shut-Off Mode.
- The preset power-off time is subject to the following restrictions:
- If the machine is running due to the current job execution or other reasons, the machine is turned off only after the job has finished.
- The machine cannot receive printer jobs.
- If the power management setting is also enabled, the Power On/Off Scheduling settings precede.
- If the same time is specified, settings are applied in the order of "Setting 1", "Setting 2", and "Setting 3".
- The power is not turned off in the following cases:
- "Power Up Auto Clear" is in progress.
- While the optimization of the storage is in progress or while a restart is in progress after the setting mode has been changed.
- The preset power on/off time is within one minute from when the setting is accepted.



### Setting Power ON/OFF Scheduling Function

In "Settings", select [System Settings] → [Energy Save] → [Power ON/OFF Schedule Setting].



## Specific Date Operation Settings

You can configure a day on which you have high-output printing or want to perform a special operation as the "specific date" and set a specific energy saving pattern only for that specific date.

### "Specific Date" tab

A period of up to 7 days can be set for Specific Date. Set the specific date, energy saving pattern to be applied, and the operation that takes place if the specific date falls on a non-work day.

| Item                            | Description   |
|---------------------------------|---|
| Date Setting                    | Configure the date on which you want to operate the machine with a specific pattern. Select a day between 1 and 31 in Every Month or from End of Every Month.           |
| Applied Energy Saving Operation | Select an energy saving pattern you want to apply. Use the <a href="#">"Pattern" tab (page 1-27)</a> to specify the details of the energy saving pattern.               |
| Operation for Holiday           | Configure how the machine operates if the preset specific date falls on a holiday. Use the <a href="#">"Holiday" tab (page 1-27)</a> to specify the day as the holiday. |



- If a specific date that is initially specified coincides with the one that is moved because it falls on a holiday, the setting for the former takes precedence.
- If specific dates of the same dates are configured, they are used in ascending order between 1 and 7 (specific date numbers).

### "Pattern" tab

This tab is used to configure the details of an energy saving pattern.

| Item                  | Description   |
|-----------------------|---|
| Energy Save Operation | Select a specific date pattern you want to specify.                                 |
| Change Pattern Name   | Enter a pattern name when you want to change the name of a specific date pattern.   |
| Pattern to Be Modeled | Select a source pattern when you create a pattern using a stored or preset pattern. |
| Add new schedule.     | Add a schedule.   |

### "Holiday" tab

Specify a holiday. The day you specified as the holiday will not be a specific date.

| Item         | Description   |
|--------------|---|
| Holiday List | When you tap this option, the dates and days of the week for the holidays you have set for two years.                                 |
| Day of Week  | Use this option to specify a holiday using a day of the week.   |
| Set Period   | Use this to specify a holiday using a date. "Final Registered Time" shows when the holiday that is stored with Set Period was stored. |



## DISPLAYING ECO RECOMMENDATION SETTINGS (ECO RECOMMENDATION FUNCTION DISPLAY)

When the base screen of normal mode is displayed, eco recommendation settings appear.



This function does not operate in easy mode.



**To use the eco recommendation function display:**

"Settings (administrator)" → [System Settings] → [Energy Save] → [Eco Setting] → [Eco Recommendation Function Display].

The displayed functions are as follows.

- 2-Sided Copy ► [page 2-16](#)
- N-Up ► [page 2-46](#)
- Image Orientation ► [page 2-29](#)

## Toner Save Mode

This mode is used to reduce toner consumption.

Toner consumption can be set for each print job of "Copy", "Printer", and "Prints (Document Filing)".

Toner consumption can be selected from three levels.

- **Toner Save1** (Toner Consumption: Much)
- **Toner Save2** (Toner Consumption: Middle)
- **Toner Save3** (Toner Consumption: Little)



# USER AUTHENTICATION

User authentication restricts the use of the machine to users that have been registered. The functions that each user is allowed to use can be specified, allowing the machine to be customized to meet the needs of your workplace. When the administrator of the machine has enabled user authentication, each user must log in to use the machine. There are different types of user authentication, and each type has a different login method.

For more information, see the explanations of the login methods.

- ▶ [AUTHENTICATION BY USER NUMBER \(page 1-29\)](#)
- ▶ [AUTHENTICATION BY LOGIN NAME/PASSWORD \(page 1-31\)](#)
- ▶ [QUICK AUTHENTICATION \(page 1-34\)](#)

For the settings that are required for user authentication, refer to [User Control \(page 1-37\)](#).

## AUTHENTICATION BY USER NUMBER

The following procedure is used to log in using a user number received from the administrator of the machine. When starting the machine, the login screen appears.

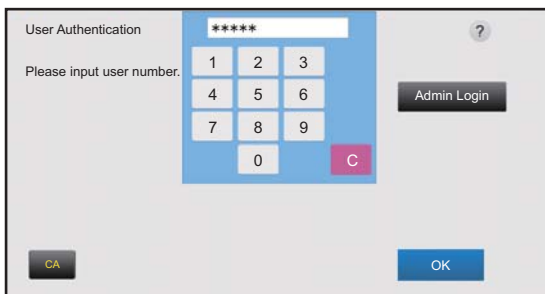

### When controlled by user number



If "A Warning when Login Fails" is enabled in the system settings, the operation panel will be locked for five minutes if an incorrect user number is entered three times in a row.

Contact the machine administrator to check the user number assigned for you.

1

### Enter your user number (5 to 8 digits) using the numeric keys.

Each entered digit will be displayed as " \* ".



2

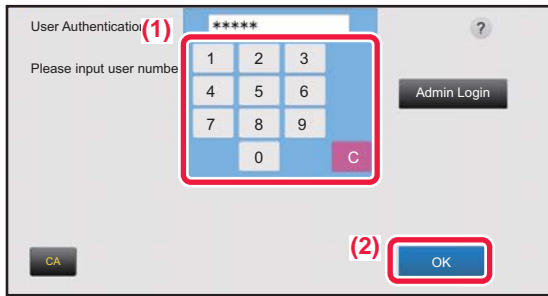

**Tap the [OK] key.**

If the entered user number is authenticated, the number of remaining pages that the user can copy or scan is displayed. When a limitation is set for the number of pages that a user can use, the use count for the user that has logged in is displayed.



**To limit the number of pages that a user can use:**

In "Settings (administrator)", select [User Control] → [Access Control Settings] → [Pages Limit Group].

**To hide the number of pages that can be used after login:**

In "Settings (administrator)", disable [System Settings] → [Authentication Settings] → [Default Settings] → [Display Usage Status after Login].

**To change the message display time:**

In "Settings" (administrator)", select [System Settings] → [Common Settings] → [Operation Settings] → [Condition Settings] → [Message Time Setting].



When the user number is an 8-digit number, this step is not necessary. Login takes place automatically after the user number is entered.

3

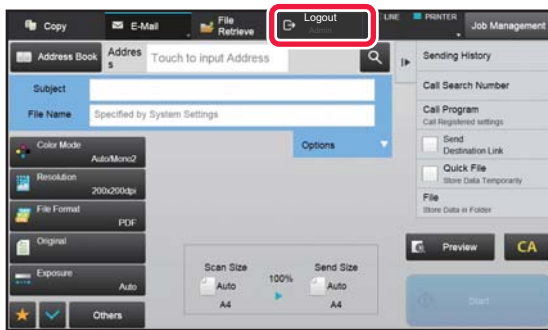

**When you have finished using the machine and are ready to log out, tap [Logout].**



## AUTHENTICATION BY LOGIN NAME/PASSWORD

This method enables users to log in using a login name and password received from the administrator of the machine or the administrator of the LDAP server.

When starting the machine, the login screen appears.

The screenshot shows the 'User Authentication' screen. At the top, it says 'Enter login name and password.' Below this are three input fields: 'Login Name' with a 'Touch to input Log-in Name' prompt and a 'Select from List' button; 'Password' with a 'Touch to Input Password' prompt; and 'Auth to' with a 'Login Locally' button. There are also 'CA' and 'OK' buttons at the bottom.

### When controlled by login name and password



- Different items may appear in the screen when LDAP authentication is used.
- When LDAP authentication is used, the [E-mail Address] key may appear, depending on the authentication method. Tap the [E-mail Address] text box and enter your e-mail address.

This screenshot is similar to the previous one but includes an 'E-mail Address' field with a 'Touch to input E-mail Address' prompt. This field is highlighted with a red rectangular box.



If "A Warning when Login Fails" is enabled in the system settings, the operation panel will be locked for five minutes if an incorrect login name or password is entered three times in a row. Contact the machine administrator to check the login name/password assigned to you.



- **To set [A Warning when Login Fails]:**

In "Settings (administrator)", select [System Settings] → [Authentication Settings] → [A Warning when Login Fails].

- **To store a user name:**

In "Settings (administrator)", select [User Control] → [User Settings] → [User List].

Also register detailed information such as the login name, user number, and password. Ask the administrator of the machine for the information that you need to use the machine.



1

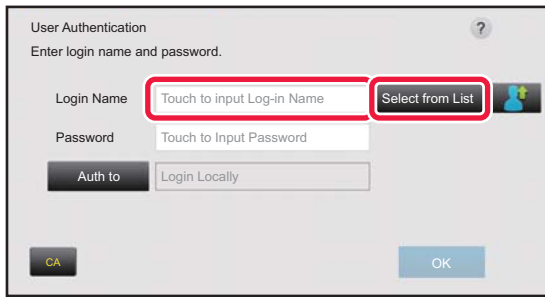

## Enter the login name.

### Entering using the soft keyboard

If user name registration has not been performed in setting mode, a user only using LDAP authentication should tap the [Login Name] text box and enter the login name using the soft keyboard.

### Selecting from a list

Tap the [Select from List] key and select a user name from the User List screen.



LDAP authentication can be used when the administrator of the server provides LDAP service on the LAN (local area network).

2

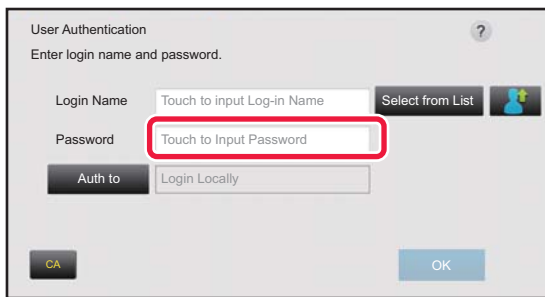

## Enter the password.

Enter the password from the soft keyboard.

If you are logging in to an LDAP server, enter the password that is stored with your LDAP server login name.

Each entered character will be displayed as "\*". After entering the password, tap the [OK] key.

When authentication is by LDAP server and you have different passwords stored in "User List" and in the LDAP server, use the password stored in the LDAP server.



### To have the user name and password registered:

In "Settings (administrator)", select [User Control] → [User Settings] → [User List].



When registering the LDAP server, change the information for [Auth to] as required.

- **When selecting from the User List screen:**

The LDAP server you are connecting to has been registered upon user registration, and so the target server to which authentication should be directed appears when the login name is selected.

Go to step 3.

- **When entering from the soft keyboard:**

Tap [Auth to] and select the LDAP server to log in.



3

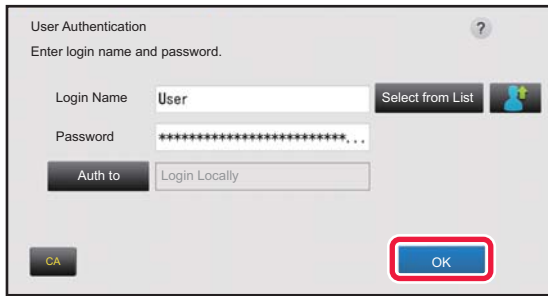

**Tap the [OK] key.**

If the entered login name and password are authenticated, the number of remaining pages that the user can copy or scan is displayed.

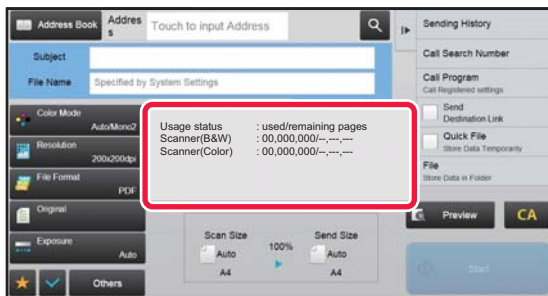

When a limitation is set for the number of pages that a user can use, the use count for the user that has logged in is displayed.



- **To limit the number of pages that a user can use:**  
In "Settings (administrator)", select [User Control] → [Access Control Settings] → [Pages Limit Group].
- **To hide the number of pages that can be used after login:**  
In "Settings (administrator)", disable [System Settings] → [Authentication Settings] → [Default Settings] → [Display Usage Status after Login].
- **To change the message display time:**  
In "Settings (administrator)", select [System Settings] → [Common Settings] → [Operation Settings] → [Condition Settings] → [Message Time Setting].

4

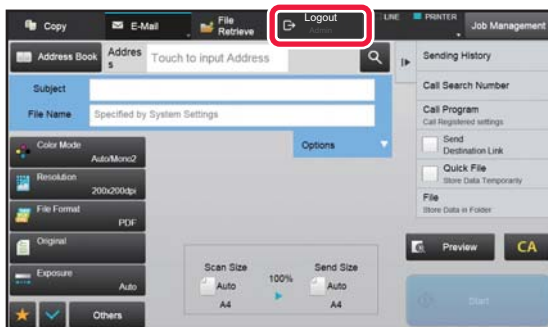

**When you have finished using the machine and are ready to log out, tap [Logout].**





## QUICK AUTHENTICATION

When operating the machine, this enables easy authentication by tapping a preconfigured icon.



- Up to 20 users can be registered.
- Only the machine supports quick authentication. Web page authentication and authentication from a printer driver cannot be used. To use web page authentication and authentication from a printer driver, enter Login Name/Password to authenticate.
- Quick authentication cannot use IC card authentication or device account mode.
- If [A Warning when Login Fails] is enabled in the system settings, the operation panel will be locked for five minutes if an incorrect password is entered three times in a row. Contact the machine administrator to check the password assigned to you.



### To use quick authentication

In "Settings (administrator)", enable [System Settings] → [Authentication Settings] → [Default Settings] → [Enable Quick Login].

For the authentication server settings, set "Login Locally", and for the authentication method settings, set "Login Name/Password".

## Register users with quick authentication

When registering users with quick authentication, the User Administration Settings and Web page settings used when registering normal users cannot be used. Registration is carried out on the quick authentication login screen.

1

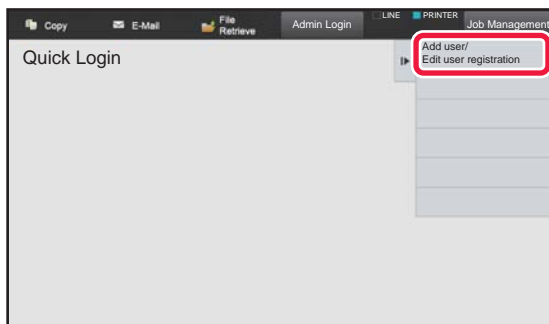

Tap [Add user/Edit user registration] on the action panel.

2

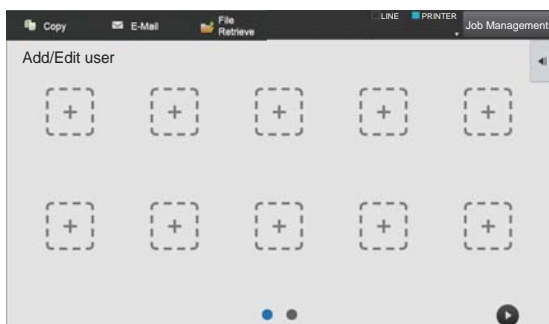

Tap the position you wish to register.

This switches to the user registration screen.

When tapping an icon that is already registered, this switches to the user information edit screen.

Details to edit are the same as the settings details in registering a new user screen. See step 3 when editing.



3

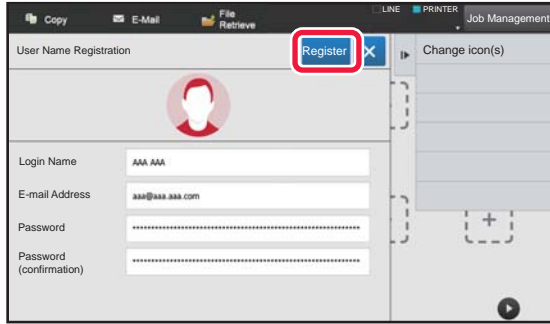

### Enter user information, and tap the [Register] key.

Specify the user icon, Login Name, E-mail Address, Password, and Password (confirmation). Tap the items to register, and enter necessary details.

- Tap "Change icon(s)" on the action panel, and the icon selection screen appears. Select the desired icon to configure.
- Login Name is displayed together with the icon. Ensure this is entered.
- When editing user information, the Password cannot be changed. "Password" and "Password (confirmation)" will not be displayed on the edit screen.



#### To delete a registered user

Tap [Add user/Edit user registration] on the action panel, then tap the icon of the user to delete. Tap [Delete] on the action panel, and then tap the [Delete] key in the displayed confirmation message.



#### User editing and deleting from User Administration Settings and Web page

Users cannot be registered from User Administration Settings and the Web page, but users registered using quick authentication are displayed in the User List. Editing and deletion of user data is possible from the User List. Configure the User List from [User Control] → [User Settings] → [User List] in the "Settings (administrator)".

## Authenticating the machine using quick authentication

1

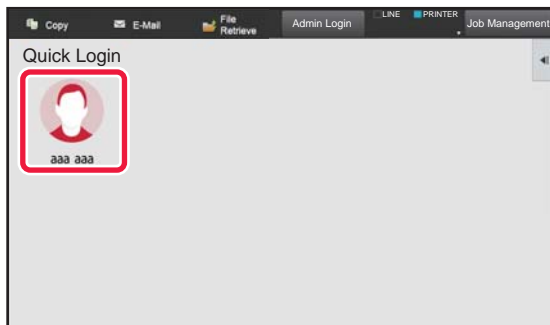

### Tap the icon.

If a password is not set, then login will close at this time.

2

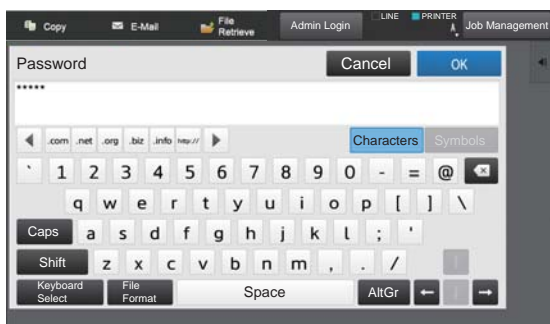

### If setting a Password, enter the Password.

Enter the Password from the soft keyboard. Entered text is displayed with "\*"3. After entering the Password, tap the [OK] key.



3

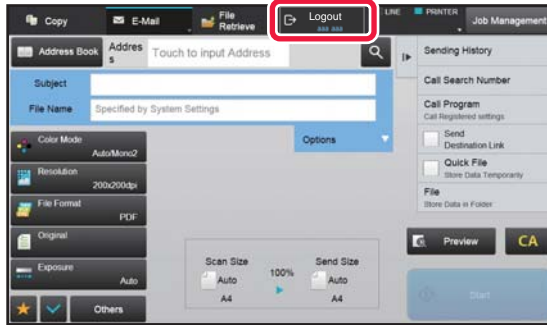

When you have finished using the machine and are ready to log out, tap [Logout].



# User Control

You can perform user management such as registering login users and specifying the user authentication method. In [User Control] of "Settings (administrator)" and [Authentication Settings] of [System Settings].

## User List

This is used to store, edit, and delete users when user authentication is enabled.

- **[Add] key**  
Adds a new user.
- **[Delete All Users] key**  
Deletes all registered users. (Excluding users stored as factory default.) Only the administrator of the machine can use this function.
- **[Delete All Auto-registered users] key**  
Deletes all auto-registered users.  
▶ [Users auto-registered \(page 1-43\)](#)
- **[Delete All Information for External Service Connect] key**  
Only the administrator of the machine can perform this action. Delete all External Connect caches. [Store user authentication information for External Connect] must be enabled to use this function.
- **User List**  
This shows the users stored as factory default and the currently stored users. An asterisk [\*] appears in front of the user name of auto-registered users.  
When you select a user name, the user edit or delete screen appears.



The [Vender] and [Vender2] options are displayed only when the vender is connected.

## Storing a user

When you tap the [Add] key, the registration screen appears. Up to 1000 groups can be registered. For information on the settings, see "[Settings \(page 1-39\)](#)".

## Editing and deleting a user

When you select a user from the list, the user edit/delete screen appears. For information on the settings, see "[Settings \(page 1-39\)](#)". A user can be deleted using the [Delete] key.



- If the login authentication with a Fixed User is set, the "Delete All Users" option cannot be used.
- Users stored as factory default cannot be deleted.



## Users stored as factory default

The following users are stored in the machine at the factory.

- Administrator: The administrator account of the machine, stored as factory default.
- System Administrator: The account for system maintenance, stored as factory default. This account cannot execute jobs.
- User: This is used when network authentication is used and a login name that is not stored in the machine is entered directly. (This cannot be selected from the login user screen.)
- Device Account: User\*1
- Other User: This is used when a print job is executed using invalid user information. (This cannot be selected from the login user screen.)

For settings related to each of the users, see the following table.

| User Name                             | Admin                           | System Administrator             | Users   | Device Account   | Other User |
|---------------------------------------|---------------------------------|----------------------------------|---------|------------------|------------|
| <b>Login Name</b>                     | admin                           | sysadmin                         | users   | device account   | Other      |
| <b>PIN Code/Password</b>              | (See "Start Guide.")*1          | sysadmin*1                       | users*1 | device account*1 | –          |
| <b>My Folder</b>                      | No                              | Main Folder                      | No      | Main Folder      | No         |
| <b>Authentication Server Settings</b> | Login Locally                   |                                  |         |                  | –          |
| <b>Pages Limit Group</b>              | Unlimited*1                     |                                  |         |                  |            |
| <b>Authority Group*2</b>              | Admin                           | System Administrator Authority*1 | User*1  | User*1           | Guest*1    |
| <b>Favorite Operation Group</b>       | Following the System Settings*1 |                                  |         |                  |            |
| <b>Default Billing Code</b>           | Not Set*1                       |                                  |         |                  |            |

\*1 Items that can be changed

\*2 For detailed information, see "[Authority Group \(page 1-49\)](#)".



## Settings

| Item                                   | Description   |
|--|---|
| User Name                              | Store a user name consisting of up to 255 characters. This user name is used as the key name in the authentication screen, the user name for document filing, and the sender name.  |
| Apply User Name to Log-in Name.*1      | Select this <input checked="" type="checkbox"/> to enter the entered user name in the login name.   |
| Initial (Optional)                     | This determines where the user name will appear in the user list. Enter a maximum of 10 characters for the initials.  |
| Index                                  | Select a custom index to be stored. The custom index names are the same as those used in the address book.  |
| User Number*2                          | Enter a user number in 5 to 8 digits.   |
| Login Name*1                           | Enter the login name that is used when authentication by login name and password is enabled (up to 255 characters). (The login name must be unique.)  |
| Password*1, 3                          | Enter the password, consisting of 1 to 255 characters, that is used for user authentication by login name and password (the password is optional).<br>After entering the password, enter once again in "Password (confirmation)". |
| Change Password                        | Select this checkbox to change the set password. (Displayed when it is modified/deleted.)   |
| Release Operation Lock Status          | Displayed when login has failed, and subsequent login to the printer is not possible. Tap the [Execute] to clear this login lock, and allow the user to log in again.   |
| E-mail Address                         | Enter the e-mail address that is used in the sender list and for LDAP authentication (up to 255 characters).  |
| Home Directory Path                    | Enter a maximum of 127 full-width/half-width characters for the home directory path.  |
| Use Login Name for User Authentication | Set whether or not the login name for user authentication will be the same as the user name for home directory path authentication.   |
| User Name                              | Enter a maximum of 127 full-width/half-width characters for the user name for home directory path authentication.   |
| Password                               | Enter a maximum of 255 numeric digits for the password for home directory path authentication.  |
| Change Password                        | Select this checkbox to change the set password. (Displayed when it is modified/deleted.)   |
| Authentication Settings*1              | Select either [Login Locally], [Network Authentication] (when LDAP is enabled) or [Active Directory] (when Active Directory is enabled) for authentication.   |
| Authentication Server                  | When the [Network Authentication] is selected, select the server to be used for user authentication from the LDAP server list that is stored using Setting mode (Web version).  |
| Organization/Group                     | Set a group to which the user belongs.<br>Up to 8 groups can be assigned.   |
| Pages Limit Group                      | Specify the page limit for the user by selecting one of the stored page limit groups. The factory default setting is [Unlimited].<br>For more information, see " <a href="#">Pages Limit Group (page 1-48)</a> ".                 |
| Authority Group                        | Specify the user authority by selecting one of the stored authority groups. The factory default setting is [User].<br>For more information, see " <a href="#">Authority Group (page 1-49)</a> ".                                  |
| Favorite Operation Group               | The favorite operation group is displayed when the user logs in. The factory default setting is [Following the System Settings].<br>To change the settings, select [User Control] in Setting mode (Web version).                  |
| Default Billing Code                   | Set the Main Code and Sub Code when the user logs in.<br>The factory default setting is [Not Set].  |
| My Folder                              | Store a folder to be used for document filing as the dedicate user folder (or My Folder). A stored folder can be selected, or you can create and specify a new folder.  |

\*1 It is not displayed when "User Number" is selected for the authentication method.

\*2 It is displayed when "User Number" is selected for the authentication method.

\*3 Not required when network authentication is used, as the password stored in the LDAP server is used.



## Custom Index

You can change the custom index name.

Tap the custom index name on the list to edit it.

Delete the previously entered characters and enter a new name (up to 127 characters).

## Organization /Group List

This is used to store user groups.

Tap each group name to enter them directly.

## User Information Print

Prints the following item lists.

- User List
- List of Number of Pages Used
- Page Limit Group List\*
- Authority Group List
- Favorite Operation Group List\*
- All User Information Print

Select each item and tap the [Print] key to print it out.

\* Cannot be printed when no groups are stored.



In All User Information Print, the following items are handled by 2-sided printing on an item basis.

- User List
  - List of Number of Pages Used
  - Page Limit Group List
  - Favorite Operation Group List
-



## Default Settings

This section describes of "Settings (administrator)" → [System Settings] → [Authentication Settings] → [Default Settings].

### User Authentication

This setting enables or disables user authentication and specifies the authentication method.

When the user authentication is enabled, each user of the machine is registered. When a user logs in, the separate authentication settings apply to the user. This function allows greater control of security and cost management than that on previous machines.

Even if user information is not stored on the machine, you can directly enter the user information stored in an LDAP server to log in the machine if necessary. In this case, the authentication information of the "User" being stored as factory default applies to the login user. For more information, see "[Users stored as factory default \(page 1-38\)](#)".



- For the procedure for storing users, see "[User List \(page 1-37\)](#)".
- For details on login procedures when user authentication is enabled, see "[USER AUTHENTICATION \(page 1-29\)](#)".

### User Authentication

When [User Authentication] is enabled, the authentication screen appears before an operation is carried out in any mode except the job management screen\*.

Log in as an already registered user.

After logging in, you can move freely through the modes.

\* The login screen appears when a document filing file is used or when a broadcast transmission is reattempted from the job management screen.

### Authentication Server Settings

Set the location where user authentication is to be enabled.

Login Locally: User authentication by the machine.

LDAP: User authentication by LDAP server.

Active Directory: User authentication by Active Directory.

### Default Network Authentication Server Setting

Use this to set the default network authentication server.

When you log into Setting mode (Web version) or send a print job to the machine using user information that is not registered in the machine, the authentication server is not known. This setting is used to select one of the LDAP servers registered in the machine as the authentication server.



When login is performed by network authentication using user information that is not registered in the machine, the login user will be the "User" registered as factory default. For more information, see "[Users stored as factory default \(page 1-38\)](#)".





## Specify network server access control

Register the access control information for page count limits, authorities, and favorite operations can be registered on a network server in advance. By using this network server for network authentication, perform the user authentication based on the registered access control information.

Use this function when user authentication is performed by network authentication using an LDAP server or a directory service (Active Directory, etc.).

Before using this function, configure settings for authentication by network server, obtain control numbers for the "Pages Limit Group", "Authority Group", "Favorite Operation Group", and "My Folder" (including base settings for each group), and associate these with the control numbers registered in the machine.

To use this function, add the properties associated with "Pages Limit Group", "Authority Group", "Favorite Operation Group", and "My Folder" to the directory information of the network server used for user authentication.

The property information is indicated below. Settings previously stored in the machine cannot be changed.

| Property                 | Name of property in factory default state | Setting   |
|--------------------------|---|---|
| Pages Limit Group        | pagelimit                                 | Registration number of Pages Limit Group registered in the machine, or a group name previously registered in the machine.<br>Unlimited: unlimited                                 |
| Authority Group          | authority                                 | Registration number of Authority Group registered in the machine, or a group name previously registered in the machine.<br>Admin: admin<br>User: user<br>Guest: guest             |
| Favorite Operation Group | favorite                                  | Registration number of Favorite Operation Group registered in the machine, or a group name previously registered in the machine.<br>Following the System Settings: systemsettings |
| My Folder                | myfolder                                  | Folder name of user folder stored in the machine.<br>Do not enter if the default folder is specified.   |

Rename the properties that the machine obtains from the LDAP server as follows. In "Settings", select [Network Settings] → [LDAP Settings]. From the Global Address Book setting screen that is displayed, select [Linkage with User Control Function] and then select [Pages Limit Group], [Authority Group], [Favorite Operation Group] and [My Folder].

The [Pages Limit Group], [Authority Group], and [Favorite Operation Group] information that is registered in each machine determines the authority and settings that the user is actually granted. To use this function to ensure that users are granted the same authority and settings on any machine, register the [Pages Limit Group], [Authority Group], and [Favorite Operation Group] information with the same authority so that they will be registered in each machine using the same registration numbers.

For [My Folder], register the folder having the same name in [Custom Folder] in each machine.

The directory information of the network server that is used cannot be changed from the machine. Consult the administrator of the network server.

If 1000 users have already been manually registered, login will not be possible. Please delete old or unused user name. Consult the administrator of the machine.



- If Access Control is enabled and the access control information cannot be acquired from the authentication server, user authentication will not be possible.
- If a user that is registered in the machine is authenticated by network authentication, the user registration settings in the machine will be given priority for the page count limit group, authority group, favorite operations group, and my folder.
- If the access control obtained from the server is not registered in the machine, the factory default user authority will be applied.
- When this function is not enabled and a user is authenticated by network authentication as a non-registered user, the factory default user authority will be applied.

## Users auto-registered

When you log in by network authentication, your user information is automatically registered in the machine. The information stored is as follows:

| Item                           | Description  |
|--------------------------------|--|
| User Name                      | This information is acquired from the authentication server.*                                |
| Initial                        | 1  |
| Index                          | User1  |
| Card ID                        | –  |
| PIN Code/Password              | –  |
| Authentication Server Settings | –  |
| Authentication Server          | Network Authentication   |
| E-mail Address                 | When Access Control is enabled, this information is acquired from the authentication server. |
| My Folder                      |  |
| Pages Limit Group              |  |
| Authority Group                |  |
| Favorite Operation Group       |  |

\* If the user name cannot be acquired by network authentication, the first 16 characters of the text string used as the login name for network authentication is applied.

## Authentication Method Setting

This selects the authentication method. When using user authentication, be sure to configure this setting first. The items to be configured for users stored after setting the user authentication method vary depending on the selected authentication method.

### Authenticate a User by Login Name and Password

Standard authentication method using a login name and password.

### Authenticate a User by Login Name, Password and E-mail Address

This authentication also checks the e-mail address, in addition to the login name and password of the user.

### Authenticate a User by User Number Only

Use this option for simple authentication if you skip the network authentication.



- The login screen will vary depending on the authentication method that is selected. For details, see "[USER AUTHENTICATION \(page 1-29\)](#)".
- When "Authenticate a User by User Number Only" is selected for the authentication method, network authentication cannot be used.



### Case sensitivity of login name is enabled.

Set whether or not to make login names used at the time of user authentication case sensitive. If the checkbox is set to , login names with identical spelling but different cases (upper and lower) will be identified as different login names. Therefore, login names with identical spelling but different cases will be authenticated as user names of different users. If the checkbox is set to , case sensitivity for login names is disabled. Therefore, identically spelled user names with upper and lower case character differences will be authenticated as the user name of the same user.



If the selected checkbox is changed to , and identical user names with only upper and lower case character differences exist, the user names that have already been registered are identified as user names of different users.

## Enable Quick Login

Enable "[QUICK AUTHENTICATION \(page 1-34\)](#)".

## Device Account Mode Setting

A specific user can be registered as an auto login user. When this option is enabled, the registered user can log in the machine automatically.

This function can eliminate each login procedure on the authentication screen and apply the selected user settings (such as network authentication and favorite operations). As an example, this enables uses such as "authentication for copying only".

Also, you can temporarily log in as a user other than the auto login user, and operate the machine with the privileges of this user. To allow other users to log in temporarily when [Device Account Mode] is enabled, select [Allow Login by Different User].



- If you have logged in as the Auto Login user, and if you have failed automatic login due to some reasons or if you do not have the administrator's privileges, you cannot use the general setting modes or Setting mode. In that case, the administrator should tap the [Admin Password] key on the Setting mode screen and log in again.
- To log in as a user other than a fixed user when [Allow Login by Different User] is enabled, tap the [Logout] key to cancel the fixed user login state. When the user authentication screen appears, log in as the desired user again. After you have used the machine, tap the [Logout] key to log out as the current user.

## Login User

This setting is used to select the auto login user when auto user login is enabled.

## Settings for Using Authentication Information

### Store User Information

Set whether or not automatically registered users are created. Externally authenticated users in Sharp OSA can also be automatically registered.

### Store Password

Set whether or not password information is retained as cache information when a user is cached.

### Cache Period

Select the cache period for user information.

To set the cache period, [Cache User Information] must be enabled.

### Enable Offline Authentication with stored User Information

When a network failure occurs, you can use the machine even if user authentication is used over a network.

### Enable Personalization when external authentication is used

You can customize by each user even if you use external authentication such as LDAP authentication.

The following settings can be customized.

Icons on the Home screen, Text color on the Home screen, MFP Display Pattern, Display Language, Enlarge Display Mode, and Favorite



## Cache Authentication Information for External Service Connect

Set whether or not authentication information for connection to the cloud is retained as cache information.

When this setting is enabled, the authentication information of a successfully authenticated user is retained to enable smooth authentication when the user subsequently logs in.

When this setting is disabled, the previously retained cloud connection authentication information of all users is deleted and authentication information is no longer retained.

## Card Setting

### Use IC Card for Authentication

This setting enables HID or other IC card to be used for user authentication.

### Request Password at IC Card Authentication

This can be enabled when "Authentication Settings" is "Active Directory" and "Use IC Card for Authentication" is enabled. When enabled, a password must be entered each time authentication is performed by IC card. When disabled, a password is entered the 1st time the user logs in by IC card, and the password information is sent to the Active Directory server. When the user subsequently logs in, the password can be omitted.

### Authentication Method Setting

Set the authentication method for IC cards.

### Automatic Logout with a Card

At the point that the IC card is removed from the IC card reader/writer, the user is logged out. (The user can also log out by tapping the [Logout] key.)

## Administration Settings

### Disabling of Printing by Invalid User

Printing by users whose information is not stored in the machine, such as printing without entering valid user information in the printer driver or printing of a file on an FTP server in Setting mode (administrator), can be prohibited.

► [DIRECTLY PRINTING A FILE ON AN FTP SERVER \(page 3-81\)](#)

### Automatic Logout Setting

When user authentication is enabled, this setting specifies whether or not to enable automatic logout.

The time until logout can be specified up to 240 seconds in increments of 10 seconds.

### A Warning when Login Fails

When entering passwords, including administrator passwords, during user authentication, the number of incorrect password attempts is counted, and if the number of attempts reaches the specified number (three), the user account is locked, and the user is blocked from making any more attempts at authenticating their account until a period of five minutes has elapsed.

The number of incorrect entries made is counted separately for each user, and the count is reset when the correct password is entered.

This prevents an unauthorized person from attempting to guess a password. (The number of failed login attempts is retained even if the power is turned off.)



- Lockout only applies to the user who failed to login, not all users. Even if one user is locked out, the other users can still log in.
- When LDAP or Active Directory network authentication is used, lockout is executed by the server, not the machine. Select appropriate lockout settings on the server.
- If the same user has been locked out, the [Release Operation Lock Status] key is displayed in the "User Registration" screen for that user. An administrator can tap this key to carry out a manual clear.



## Allow Remote Scanner Using Before Login.

This setting specifies whether scanning can be performed by remote operation before a user has logged in.

## Include Job Management in user authentication

When user authentication is enabled, this setting specifies whether or not to include the job management in user authentication.

## Enable IPP Authentication Except for Printer Driver.

Enable IPP authentication for other than the printer driver.

# Actions when the user is authenticated

## Actions when the Limit of Pages for Output Jobs

This setting determines whether or not a job will be completed if the page limit is reached while the job is in progress. The following settings can be configured.

- Print through the end of the job
- Stop the job
- Cancel and delete the job during receiving

## Automatically print stored jobs after login

When retention is enabled in the printer driver and print data has been spooled to the machine, you can have the spooled print data automatically print out when the user who enabled retention logs in.

## Reset Counter After Sending E-mail Status

After E-mail Status has been sent, the counter is reset.

This only appears when E-mail Status is enabled.

## Disable display/change of other users' information in the job management

If you include job management in user authentication, this setting can be configured.

When this setting is enabled, only the job for login user will be displayed on the job management screen.

## Apply login name to the user name of network folder

Apply login name to the user name of network folder

## Login Name Display

When user authentication is enabled, select whether the login name is shown or asterisks are shown.

| Item  | Description                         |
|---|-------------------------------------|
| Display login name                          | Show the login name.                |
| Display Login Name with Asterisk<br>"*****" | Hide the login name with asterisks. |

## Display Usage Status after Login

When user authentication is enabled, this setting specifies whether or not to display the page counts of a user when the user logs in.

## Edit Help Display of Login Screen

Settings you have created here is displayed on the login screen.



# Card Reader Settings

## Card Scan Test

Execute the scan test of the card to be used.

## Card ID Registration/Change Authority

This setting specifies whether the logged-in user can register/change/delete the card ID information on the machine.

## Check System Code only in FeliCa User Area mode

Check the System Code only in FeliCa User Area mode.

## Check Facility Code in HID mode

This setting specifies whether or not to check facility code when you use HID mode.  
When this setting is enabled, register the facility code (maximum of 128 characters).

## Facility Code

Enters the facility code of a HID card. When you tap the [Store] key, the facility code is stored.

## Importing from the setup file

When you enter the configuration file name and tap the [Execute] key, the card area settings are read from the configuration file. If you tap the [Clear] key, all files that match the current search conditions are deleted.



## Pages Limit Group

This section describes of "Settings (administrator)" → [System Settings] → [Access Control Settings] → [Pages Limit Group].

This is used to register the page limit settings in advance for each group.

The page limit for each user is specified by selecting one of these registered groups when the user is registered.

- [Add] key

Use this to add a new group.

- List

This shows the currently stored groups. Selecting a group name displays the edit screen for that group.

## Storing page limit groups

When you tap the [Add] key, the registration screen appears. Up to 20 groups can be registered.

For information on the settings, see "[Settings \(page 1-48\)](#)".

## Editing a page limit group

Selecting a group from the list displays the edit screen for that group.

For information on the settings, see "[Settings \(page 1-48\)](#)".

To return a group to the factory default state, set "Select the Group Name to be the Registration Model" to "Unlimited" on the edit screen.

## Settings

| Item   | Description   |
|--|---|
| Group Name   | Store a name of group (up to 32 characters).  |
| Select the Group Name to be the Registration Model | Select one of the previously stored groups for use as a template for the new group. When selected, the settings of this group are applied.  |
| Function Names                                     | The name of the functions that can be configured is displayed. Set a limit for each function.   |
| Page Limit   | When [Prohibited] is selected for a mode, input from the mode is prohibited.<br>When [Unlimited] is selected for a mode, there is no limit to the number of pages that can be input/output in that mode.<br>When [Limited] is selected, enter a page limit (1 to 99999999 pages). |

## Machine Page Limit Setting

Sets the page limit for the machine.

## Settings

| Item           | Description   |
|----------------|---|
| Function Names | The name of the functions that can be configured is displayed. Set a limit for each function.   |
| Page Limit     | When [Prohibited] is selected for a mode, input from the mode is prohibited.<br>When [Unlimited] is selected for a mode, there is no limit to the number of pages that can be input/output in that mode.<br>When [Limited] is selected, enter a page limit (1 to 99999999 pages). |



## Authority Group

This section describes of "Settings (administrator)" → [System Settings] → [Access Control Settings] → [Authority Group].

This is used to store the settings relevant to user authorities in advance for each group. The authority of each user is specified by selecting one of these registered groups when the user is registered.

- [Add] key  
Use this to add a new group.
- List  
This shows the currently stored groups. Selecting a group name displays the edit screen for that group.

## Storing authority groups

When you tap the [Add] key, the registration screen appears. Up to 20 groups can be registered.

For detailed information about each of the settings, see the following table.

## Editing an authority group

Selecting a group from the list displays the edit screen for that group. For detailed information about each of the settings, see the following table.

To return a group to the factory default state, select the group from the list and select any of options [Return to the Administrator Authority], [Return to the system administrator authority.], [Return to the User Authority], [Return to the Guest Authority], and [Return to the scanner prohibited authority.].

Tapping the [Execute] key resets the group status to the factory default.

| Item   | Description  |                             |               |               |                                     |
|--|--|-----------------------------|---------------|---------------|-------------------------------------|
| Group Name   | Store a name of group (up to 32 characters).   |                             |               |               |                                     |
| Select the Group Name to be the Registration Model | Select one of the previously stored groups for use as a template for the new group. When selected, the settings of this group are applied. |                             |               |               |                                     |
|  | The factory default groups and their settings are shown below.   |                             |               |               |                                     |
|  | <b>Admin</b>   | <b>System Administrator</b> | <b>User</b>   | <b>Guest</b>  | <b>Scanner Prohibited Authority</b> |
| <b>Copy</b>  |  |                             |               |               |                                     |
| Special Modes Usage                                | Allowed  | Prohibited                  | Allowed       | Prohibited    | Allowed                             |
| Sending while copying                              | Allowed  | Allowed                     | Allowed       | Allowed       | Allowed                             |
| Approval Setting to Use Toner Save Mode            | No Toner Save  | No Toner Save               | No Toner Save | No Toner Save | No Toner Save                       |
| Creation of PDF for PC Browsing                    | Allowed  | Prohibited                  | Allowed       | Allowed       | Allowed                             |
| <b>Printer</b>                                     |  |                             |               |               |                                     |
| FTP Pull Print                                     | Allowed  | Prohibited                  | Allowed       | Prohibited    | Allowed                             |
| USB Memory Direct Print                            | Allowed  | Prohibited                  | Allowed       | Prohibited    | Allowed                             |
| Network Folder Pull Print                          | Allowed  | Prohibited                  | Allowed       | Prohibited    | Allowed                             |
| Sending while printing                             | Allowed  | Allowed                     | Allowed       | Allowed       | Allowed                             |
| Creation of PDF for PC Browsing                    | Allowed  | Prohibited                  | Allowed       | Allowed       | Allowed                             |
| Approval Setting to Use Toner Save Mode            | No Toner Save  | No Toner Save               | No Toner Save | No Toner Save | No Toner Save                       |





| Item  | Description |                |             |                            |                |
|---|-------------|----------------|-------------|----------------------------|----------------|
| <b>Image Send</b>   |             |                |             |                            |                |
| Approval Settings for Each Mode   |             |                |             |                            |                |
| <ul style="list-style-type: none"> <li>• E-mail</li> <li>• FTP</li> <li>• Desktop</li> <li>• Network Folder</li> <li>• Scan to Ext.Memory Dev.</li> <li>• PC Scan</li> </ul>                            | All allowed | All prohibited | All allowed | All allowed                | All prohibited |
| Color Scan  | Allowed     | Prohibited     | Allowed     | Prohibited                 | Allowed        |
| Special Modes Usage   | Allowed     | Prohibited     | Allowed     | Prohibited                 | Allowed        |
| Registration/Deletion of Program  | Allowed     | Prohibited     | Allowed     | Prohibited                 | Allowed        |
| Creation of PDF for PC Browsing   | Allowed     | Prohibited     | Allowed     | Allowed                    | Allowed        |
| Approval Setting for Addressing   |             |                |             |                            |                |
| <ul style="list-style-type: none"> <li>• Approval Setting for Direct Entry</li> <li>• Approval Setting to Use a Local Address Book</li> <li>• Approval Settings to Use a Global Address Book</li> </ul> | All allowed | All allowed    | All allowed | All allowed                | All allowed    |
| <b>Document Filing</b>  |             |                |             |                            |                |
| Scan to Local Drive   |             |                |             |                            |                |
| Color Scan  | Allowed     | Prohibited     | Allowed     | Only Black & White Allowed | Allowed        |
| Special Modes Usage   | Allowed     | Prohibited     | Allowed     | Prohibited                 | Allowed        |
| Creating Downloadable File  | Allowed     | Prohibited     | Allowed     | Allowed                    | Allowed        |
| Prints (Document Filing)  |             |                |             |                            |                |
| Color Mode Approval Setting   | Allowed     | Prohibited     | Allowed     | Allowed                    | Allowed        |
| Special Modes Usage   | Allowed     | Prohibited     | Allowed     | Prohibited                 | Allowed        |
| Document Filing Image Check   |             |                |             |                            |                |
| Apprpval Setting  | Allowed     | Prohibited     | Allowed     | Prohibited                 | Allowed        |
| Display only the Files of Logged-in Users   | Prohibited  | Prohibited     | Prohibited  | Prohibited                 | Prohibited     |



| Item   | Description |                |             |                |             |
|--|-------------|----------------|-------------|----------------|-------------|
| <b>Sharp OSA</b>   |             |                |             |                |             |
| Approval Setting to Use a Sharp OSA                        | Allowed     | Prohibited     | Allowed     | Allowed        | Allowed     |
| <b>Common Functions</b>                                    |             |                |             |                |             |
| Approval Settings for 2-Sided Print                        | All allowed | All allowed    | All allowed | All allowed    | All allowed |
| Change Billing Code  | Allowed     | Allowed        | Allowed     | Allowed        | Allowed     |
| Output Approval Settings                                   | All allowed | All prohibited | All allowed | All prohibited | All allowed |
| <b>Security</b>  |             |                |             |                |             |
| Document Filing Approval Setting: Quick File/ Sharing Mode | Prohibited  | Prohibited     | Prohibited  | Prohibited     | Prohibited  |
| Document Filing Approval Setting: Confidential Mode        | Allowed     | Prohibited     | Allowed     | Prohibited     | Allowed     |
| Print Jobs Other than Print Hold Job                       | Allowed     | Allowed        | Allowed     | Allowed        | Allowed     |
| Hidden Pattern Print Setting - Direct Entry                | Allowed     | Prohibited     | Allowed     | Prohibited     | Allowed     |
| <b>Machine Settings</b>                                    |             |                |             |                |             |
| Total Count  | Allowed     | Allowed        | Allowed     | Prohibited     | Allowed     |
| Device / Network Status                                    | Allowed     | Allowed        | Allowed     | Prohibited     | Allowed     |
| Power Reset  | Allowed     | Allowed        | Prohibited  | Prohibited     | Prohibited  |
| List for User  | Allowed     | Allowed        | Allowed     | Prohibited     | Allowed     |
| List for Administrator                                     | Allowed     | Allowed        | Prohibited  | Prohibited     | Prohibited  |
| Address Registration                                       | Allowed     | Allowed        | Allowed     | Prohibited     | Allowed     |
| Document Filing Folder Registration                        | Allowed     | Allowed        | Allowed     | Prohibited     | Allowed     |
| User Control (Admin)                                       | Allowed     | Allowed        | Prohibited  | Prohibited     | Prohibited  |
| User Control (User)  | Allowed     | Allowed        | Allowed     | Prohibited     | Allowed     |
| Home Screen Settings                                       | Allowed     | Allowed        | Prohibited  | Prohibited     | Prohibited  |
| Copy Function Settings                                     | Allowed     | Allowed        | Prohibited  | Prohibited     | Prohibited  |
| Printer Settings (Admin)                                   | Allowed     | Allowed        | Prohibited  | Prohibited     | Prohibited  |
| Printer Settings (User)                                    | Allowed     | Allowed        | Allowed     | Prohibited     | Allowed     |
| Image Send Settings > Common Settings                      | Allowed     | Allowed        | Prohibited  | Prohibited     | Prohibited  |
| Scan Settings  | Allowed     | Allowed        | Prohibited  | Prohibited     | Prohibited  |
| Inbound Routing (Forwarding/Storing) Settings (Admin)      | Allowed     | Allowed        | Prohibited  | Prohibited     | Prohibited  |
| Inbound Routing (Forwarding/Storing) Settings (User)       | Allowed     | Allowed        | Allowed     | Prohibited     | Allowed     |
| Metadata Entry   | Allowed     | Allowed        | Prohibited  | Prohibited     | Prohibited  |
| Document Filing Settings                                   | Allowed*    | Allowed*       | Prohibited  | Prohibited     | Prohibited  |
| Sharp OSA Settings   | Allowed     | Allowed        | Prohibited  | Prohibited     | Prohibited  |



| Item                                  | Description |         |            |            |            |
|---------------------------------------|-------------|---------|------------|------------|------------|
| Paper Settings (Bypass Tray Excluded) | Allowed     | Allowed | Allowed    | Prohibited | Allowed    |
| Paper Settings (Bypass Tray)          | Allowed     | Allowed | Allowed    | Prohibited | Allowed    |
| Operation Settings                    | Allowed     | Allowed | Prohibited | Prohibited | Prohibited |
| Keyboard Settings                     | Allowed     | Allowed | Prohibited | Prohibited | Prohibited |
| Device Control                        | Allowed     | Allowed | Prohibited | Prohibited | Prohibited |
| Machine Identification Settings       | Allowed     | Allowed | Prohibited | Prohibited | Prohibited |
| Clock                                 | Allowed     | Allowed | Prohibited | Prohibited | Prohibited |
| Product Key                           | Allowed     | Allowed | Prohibited | Prohibited | Prohibited |
| Custom Link Setting                   | Allowed     | Allowed | Prohibited | Prohibited | Prohibited |
| Network Settings                      | Allowed     | Allowed | Prohibited | Prohibited | Prohibited |
| Security Settings                     | Allowed     | Allowed | Prohibited | Prohibited | Prohibited |
| Energy Save                           | Allowed     | Allowed | Prohibited | Prohibited | Prohibited |
| System Control                        | Allowed     | Allowed | Prohibited | Prohibited | Prohibited |
| Image Quality Adjustment              | Allowed     | Allowed | Prohibited | Prohibited | Prohibited |
| Operation Manual Download             | Allowed     | Allowed | Allowed    | Allowed    | Allowed    |
| Shortcut Page Setting                 | Allowed     | Allowed | Prohibited | Prohibited | Prohibited |

\* For information on each setting, see the setting mode list.



Depending on the machine specifications and peripheral devices installed, it may not be possible to use some settings.



# Favorite Operation Group

## Favorite Operation Group List

This section describes of "Settings (administrator)" → [System Settings] → [Access Control Settings] → [Favorite Operation Group].

The preferred operation environment can be set for each group. For example, a user who speaks a different language would normally have to change the display language each time he or she uses the machine; however, by registering the language in a favorite operation group in advance, the language is automatically selected when the user logs in.



- Depending on the machine specifications and peripheral devices installed, it may not be possible to use some settings.
- This setting can only be configured in Setting mode (Web version). It cannot be configured in the touch panel of the machine.

### Adding/editing a group

Tap the [Add] key to display the favorite operation group registration screen.

Tap a group name to display the registration screen for that favorite operation group. You can edit the group in this screen.

### Settings

| Item   | Description  |
|--|--|
| Group Name   | Store a name of group (up to 32 characters).   |
| Select the Group Name to be the Registration Model           | Select one of the previously stored groups for use as a template for the new group. When selected, the settings of this group are applied.   |
| <b>Copy</b>  |  |
| Initial Status Settings                                      | Select settings for Image Orientation, Paper Tray, Exposure Type, Copy Ratio, 2-Sided, Original Binding, Output Binding, Output, Offset, Output Tray, Separator Page, Staple Sort, Staple Position, Punch, and Fold. |
| <b>Image Send</b>  |  |
| Initial Status Settings                                      | Select settings for Image Orientation, Exposure, Resolution, Color Mode, File Format, and Original Image Type. Select settings for Specified Pages per File.   |
| <b>Document Filing</b>                                       |  |
| Image Orientation  | Specify the image orientation.   |
| Initial Status Settings                                      | Select settings for Color Mode, Exposure, Original Image Type, and Resolution.   |
| Prints (Document Filing)                                     | Set the default output tray for document filing print.   |
| <b>System Settings</b>                                       |  |
| Enlarge Display Mode   | Turn this option ON to display large characters on the Setting mode screen.  |
| Original Size Detector Setting                               | Select whether Inch sizes or AB sizes are detected, or disable detection on the document glass.  |
| Cancel Detection at Document Glass                           | Original size detection on the document glass can be disabled. When this is done, all originals placed on the document glass are treated as special size originals.  |
| Language Setting   | Select the display language.   |
| Switch the Number of Sets to be Displayed for Job Management | Select whether to display the number of progress sets or remaining sets as the job management.   |
| Key Operation Setting  | Set the key input time and Auto Key Repeat setting.  |



| Item   | Description  |
|--|--|
| Time for Accepting Key Entry of Long Touch             | Select a time when a long key touch is detected.   |
| Double Tap Interval Setting                            | Select an interval when a double tap is detected.  |
| Keys Touch Sound                                       | Set the sound made when keys are touched.  |
| Keyboard Select  | Set the language that appears on the keyboard.   |
| MFP Display Pattern Setting                            | Select the color pattern used in the touch panel.  |
| Automatically print stored jobs after login            | When retention is enabled in the printer driver and print data has been spooled to the machine, the spooled print data is automatically printed out when the user who enabled retention logs in. |
| Favorite Key Setting                                   | Select to use System Settings or use the registered Favorite key settings for performing Favorite Key Setting.   |
| Home Screen Settings                                   | Select to use System Settings or use the stored home screen settings for performing Home Screen Settings.  |
| <b>Preview Setting: Default List/Thumbnail Display</b> |  |
| File Retrieve of Main Folder/Quick File Folder         | Select whether the default display format of the document filing main folder and temporary folder screens is list or thumbnails.   |
| File Retrieve of Custom Folder                         | Select whether the default display format of the document filing custom folder screen is list or thumbnails.   |
| File Retrieve of Direct Print                          | Select whether the default state of the file list screen for direct print shows the folders as a list or as thumbnails.  |

### Returning a favorite operation group to "Unlimited"

To return a selected favorite operation group to the factory default state, select the checkbox (  ) to the left of "No." and tap the [Return to the Defaults] key.

## Favorite Key List

Assign shortcut keys to frequently used functions. They will be displayed in the base screen of each mode.

### Settings

| Item                         | Description  |
|------------------------------|--|
| Key Name                     | Enter a maximum of 20 characters for the favorite key name. (Up to 20 full-width characters can be entered, but only 10 will be shown on the key.) |
| Function Menu/Program/Others | Select the function that you wish to assign to the favorite key. The functions that can be selected vary by mode.                                  |
| No Display                   | Enable this setting to not show favorite keys.   |



## Home Screen List

Home screen settings must be previously stored. Select a home screen when registering Favorite Operation Group List.

| Item   | Description  |
|--|--|
| Name   | Enter a maximum of 32 characters for the home screen name.   |
| Select the Group Name to be the Registration Model | Select one of the previously stored home screens as a template for the new home screen. When selected, the settings of this home screen are applied. |
| Change Home Screen Name                            | Enter a home screen name to change the existing name.  |
| Template   | Select a layout pattern of the registered key.   |
| Key Layout of the Screen                           | The layout of the keys in the home screen is displayed.  |
| Change Text Color On Home Screen                   | Set the color of the text in the scroll area, fixed area, and clock.   |
| Home Button  | Registers the function to use for the selected key number.   |
| Fix Key  | Registers the function to use for the selected key number. This button is displayed on all pages of the home screen.                                 |
| Display Toner Quantity                             | Select this to display the toner level in the fixed area.  |

## User Count

This displays the total number of pages printed by each user.

- [Select All] key  
This selects all users.
- [Clear Checked] key  
This clears all selections.
- [Show] key  
This shows the counts of the selected user.
- [Clear Count] key  
Use this to reset the counts of the selected user.
- User List  
This shows the users stored as factory default and the currently stored users. When you select a user name, the user is selected.

## View User Count

When you select a user and tap the [Show] key, this user count is displayed.

| Item        | Description   |
|-------------|---|
| Next        | Displays the next user (in the order of the registration numbers).                            |
| Previous    | Displays the previous user (in the order of the registration numbers).                        |
| Show Counts | Displays the counts and the number of pages remaining of the selected user for each function. |
| Page Limit  | The page limit set for the user appears in parentheses below the count.                       |



If peripheral devices are not mounted, their count is not displayed.



## Resetting user counts

Select a user in the setting screen and tap the [Clear Count] key. A count reset screen for that user will appear. The reset screen will vary depending on whether a single user or multiple users were selected. The items displayed in each case are described in the table below.

### When a single user is selected

| Item            | Description   |
|-----------------|---|
| Next            | Displays the next user (in the order of the registration numbers).                            |
| Previous        | Displays the previous user (in the order of the registration numbers).                        |
| Show Counts     | Displays the counts and the number of pages remaining of the selected user for each function. |
| Clear Count     | Reset the count of the selected item to "0".  |
| Clear All Count | Clears all counts of the selected user to zero (0).   |

### When multiple users are selected

| Item            | Description   |
|-----------------|---|
| Show Counts     | Displays the counts and the number of pages remaining of the selected user for each function. |
| Clear Count     | Reset the count of the selected item to "0".  |
| Clear All Count | Clears all counts of the selected user to zero (0).   |

## Save User Count

Clicking the [Save] button saves the user count information as a data file.

To delete the user count information in the machine, click the checkbox next to the "Save and Delete the Data" so that it is selected and click the [Save] button.



This setting can only be configured in Setting mode (Web version). It cannot be configured in the touch panel of the machine.



# ACTIVE DIRECTORY LINKING FUNCTION

You can join the Active Directory domain (AD domain) of the machine, and easily perform user management on the network.

On a network that does not have Active Directory enabled, you must perform network device authentication for each device.

For this reason, one user must have multiple domain names and passwords.

When you join an AD domain, you only need to be authenticated once. After you are authenticated, the Active Directory server automatically authenticates network devices. You can log in to multiple devices on the network with a single domain name and password.

## Joining an AD domain

To have the machine join an AD domain, set the authentication destination to [Active Directory] in "Settings (administrator)" - [System Settings] → [Authentication Settings] → [Default Settings] → [Authentication Server Settings].



When the authentication destination is set to Active Directory, the Kerberos setting cannot be used.

## Registering the machine in an AD domain

When you join an AD domain, the machine is registered as a printer in the AD domain. Enter the machine information in setting mode.

### Device name of the machine

In "Settings (administrator)", select [System Settings] → [Network Settings] → [Network Name Setting] → [Device Name].

### Domain name of the machine

In "Settings (administrator)", select [System Settings] → [Network Settings] → [Active Directory Settings] → [Domain Name].

### Machine user name and password

In "Settings (administrator)", select [System Settings] → [Network Settings] → [Active Directory Settings] → [Device Registration Account].

### DNS domain name

In "Settings (administrator)", select [System Settings] → [Network Settings] → [Interface Settings] → [DNS Settings] → [Domain Name].





## User authentication in the AD domain

The following methods can be used for user authentication in the AD domain.

### 1. Authentication by manual entry on the machine

Perform authentication using the touch panel of the machine. For the authentication method, refer to "[AUTHENTICATION BY LOGIN NAME/PASSWORD \(page 1-31\)](#)".

Configure the following setting in "Settings (administrator)".

Disable "Settings (administrator)" → [System Settings] → [Authentication Settings] → [Default Settings] → [Card Setting] → [Use IC Card for Authentication].

### 2. Login by IC card (Quick Mode)

Use the card ID registered in an IC card to perform AD domain authentication.

When you first perform authentication, you must enter your password. After that you can perform authentication with just your IC card.



If you change your password on the Active Directory server, your initially entered password information will be reset and you will need to enter your password again.

Configure the following settings in "Settings (administrator)".

Enable "Settings (administrator)" → [System Settings] → [Authentication Settings] → [Default Settings] → [Card Setting] → [Use IC Card for Authentication].

Enable "Settings (administrator)" → [System Settings] → [Authentication Settings] → [Default Settings] → [Store Password].

### 3. Login by IC card (security card)

Use the card ID registered in an IC card to perform AD domain authentication.

You must always enter your password when you perform authentication using an IC card.

Enable "Settings (administrator)" → [System Settings] → [Authentication Settings] → [Default Settings] → [Card Setting] → [Use IC Card for Authentication].

Disable "Settings (administrator)" → [System Settings] → [Authentication Settings] → [Default Settings] → [Store User Information] → [Store Password].



- You can use both AD domain authentication users and users set on the machine. In this case, the authentication destination is set when logging in.
- When an AD domain authentication user reserves a job and logs out before the job is executed, the user information is temporarily stored in the machine and the reserved job is executed.



## Functions that can be used by linking with Active Directory

### User accessible network folders

When a user who has logged in to the AD domain accesses a network folder from the machine, the user can only access a folder for which he has permission.

#### Shared folder

When a logged in user taps the [Browse] key for a shared folder address, only folders for which the user has permission are displayed.

#### Document filing

When a logged in user taps [Select File from Network Folder to Print] on the action panel in document filing and then taps [Refer to Folders on Network], only folders for which the user has permission are displayed.

### Home Directory

#### Scan to Home Directory

When scanning, a logged in user can use his Home Directory property that is set in the AD domain to send the scanned file to that folder.

To use this function, enable "Settings (administrator)" → [System Settings] → [Image Send Settings] → [Scan Settings] → [Default Address] → [Default Address Setting] → [Apply Home Directory of The User for Login].

#### Shared folder

In the shared folder address, the path of the logged in user's Home Directory is automatically entered in [Path Input to Folder]. The folder that appears after the [Browse] key is tapped is the user's Home Directory.



If the Active Directory server cannot be accessed, the [Path Input to Folder] field will be blank, and when the [Browse] key is tapped, the search results of the entire network will appear.

### Print from Home Directory

The logged in user's Home Directory property that is set in the AD domain can be used to set the print folder for printing to the Home Directory.

#### Shared folder

When the user taps [Select File from Network Folder to Print] on the action panel in document filing and then taps [Refer to Folders on Network], the folder that appears is the user's Home Directory.



- When authentication information is stored in the address book and the user sends a file by specifying an address in the address book, the file is sent according to the user's permissions in the address book. If authentication information is not stored in the address book, the file is sent according to the logged in user's authentication permissions.
- In AD domain authentication mode, a file can be sent to a shared folder using the logged in user's authentication permissions. In this case, a user name and password cannot be entered manually.

### E-Mail

#### Scan to E-Mail

A logged in user can use his mail property set in the AD domain to send a scanned image to himself by e-mail.

To apply the e-mail address of the logged-in user set in the AD domain, tap [Find My Address] which appears on the action panel when e-mail is sent, or enable [Apply E-mail address of the user for login.] in "Settings (administrator)" → [System Settings] → [Image Send Settings] → [Scan Settings] → [Default Address].



## Active Directory Settings

Among the items that must be set to use Active Directory on the machine, this section explains those items that can be set in the Active Directory settings of the System Settings.

In "Settings (administrator)", select [System Settings] → [Network Settings] → [Active Directory Settings].

### Search Attribute:

Set the lookup attribute. The default setting is cn.

### Linkage with User Control Function

#### Pages Limit Group

Enter to set a page limit group. The default setting is pagelimit.

#### Authority Group

Enter to set an authority group. The default setting is authority.

#### Favorite Operation Group

Enter to set a favorite operation group. The default setting is favorite.

#### My Folder

Enter to set My Folder. The default setting is myfolder.

### Device Registration Account

#### User Name

Enter the user name to be used.

#### Password

Enter a password.



# BILLING CODE

## BILLING CODE

A billing code, which is added to a recorded job log when a printing or sending job has been executed, is used to perform billing processing.

Billing codes are classified into two types: main code and sub code. A billing code is recorded in the job log when it is entered and a print or send job is executed.

Summing up the amounts by Billing Code based on the job logs will facilitate the subsequent operations, for instance, when making combined billings.

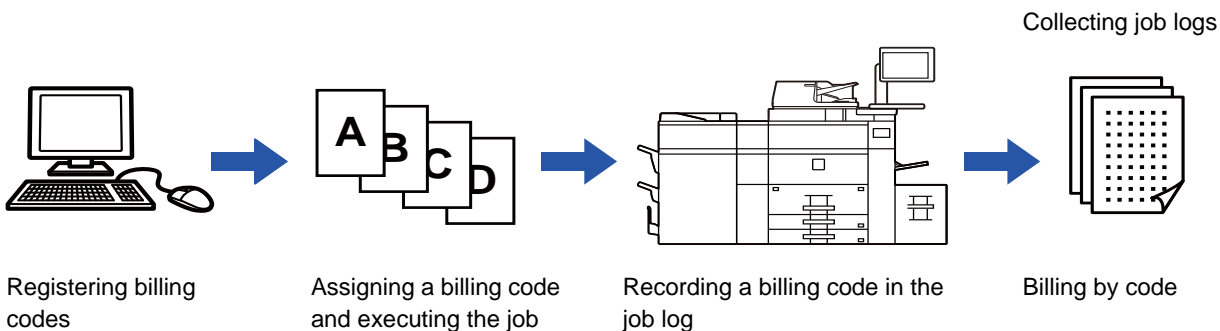

## Types of billing codes

| Type         | Description   |
|--------------|---|
| Main Code    | Used to categorize the results of the executed print and send jobs to enable efficient management. For example, you can assign a code by customer and collect cost information by customer from job logs.<br>Code example: Issue of company A   |
| Sub Code     | Available when the main code alone is not sufficient to enable management of billing codes. For example, you can assign monthly cost information to a sub code and collect the total monthly cost information of all customers when the customer name is assigned to the main code.<br>Code example: Issue of October, 2020 |
| Default Code | Automatically assigned when the main code or sub code has not been specified.   |

## Enable use of billing code

To enable use of the billing code, select "Settings (administrator)" → [User Control] → [Billing Code Setting] → [Administration Settings], then set [Use Billing Code] to [Enable].

## Collecting billing codes

In "Settings (administrator)", select [System Settings] → [System Control] → [Job Log] → [Job Log Operation], and click [Save] button to download the job logs. Then sum up the data by classifying and arranging the stored job logs.



## USE BILLING CODE

If the use of billing code is enabled in "Settings (administrator)", the billing code entry window is displayed at the time of mode transition (at the time of printing/sending in document filing mode).

Enter the main code or sub code as required.



- **To enable use of the billing code**

Select "Settings (administrator)" → [User Control] → [Billing Code Setting] → [Administration Settings], then set [Use Billing Code] to [Enable].

- **To retain the specified billing code at the time of mode transition**

Select "Settings (administrator)" → [User Control] → [Billing Code Setting] → [Administration Settings], then set the [Remember Billing Code Between Modes] check box to . This eliminates the need to enter billing codes at each mode transition.



You can assign billing codes to reprinting/resending of target files and sending of print jobs from "Settings (administrator)" → [Document Operations].

## Specifying a billing code again

To change the specified billing code to another one, tap [Switch Billing Code.] on the action panel.

When the billing code entry window is displayed, select a new billing code.

## Select a billing code from the list

Select the desired billing code from the list of registered billing codes.

You need to register billing codes in advance.

▶ [REGISTERING A NEW BILLING CODE \(page 1-65\)](#)

1

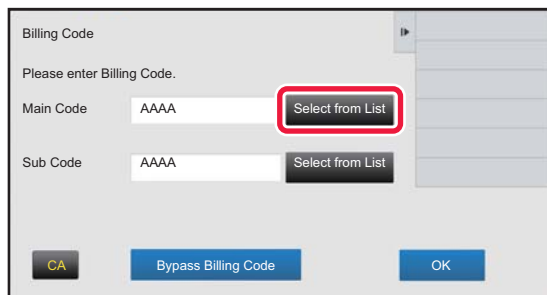

When the billing code entry window is displayed, tap the [Select from List] key of the main code.



- **When not specifying a billing code**

Tap the [Bypass Billing Code] key.



- **To select the previously used billing code (at the time of user authentication)**

Tap [Use Previously-Used Billing Code] on the action panel at the time of user authentication; this displays the main code and sub code the authenticated user has entered previously.



2

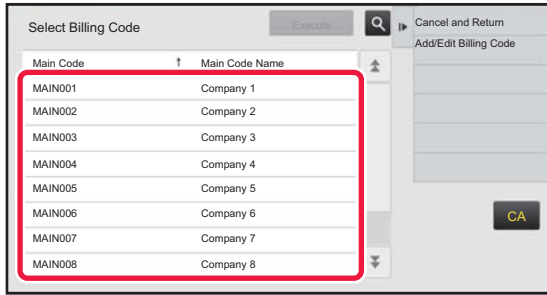

Tap and select the main code from the list.



**To search for the main code or main code name**

Tap . When the search window is displayed, enter the main code and main code name, then tap the [Search Start] key. The search result list is displayed.

3

**Tap the [Execute] key.**

Returns the screen to the billing code entry window.



**To cancel the selection from the list**

Tap [Cancel and Return] on the action panel. This cancels the selected main code and returns the screen to the billing code entry window.



**To check the details of the main code**

Tap [Display Details] on the action panel. The detail window is displayed. Check the details, then tap .

4

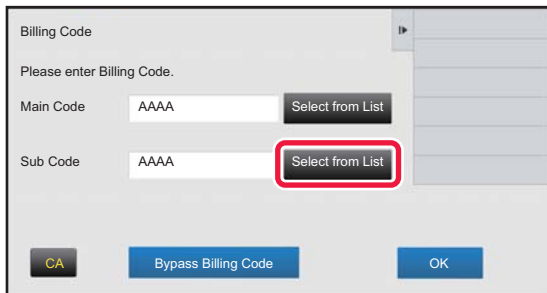

**Tap the [Select from List] key of the sub code.**

The sub code list is displayed. Perform the procedure shown in steps 2 and 3, then specify the sub code.

5

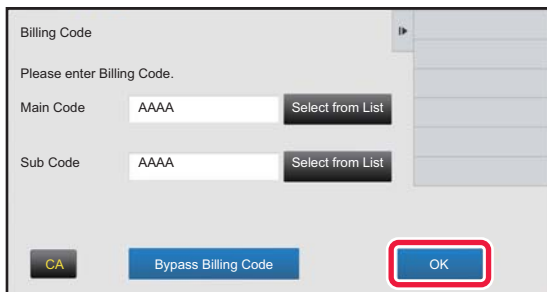

**Tap the [OK] key.**



**To clear the value of the specified billing code**

Tap the [CA] key. Enter the billing code again.



## Directly entering a billing code

1

Billing Code

Please enter Billing Code.

Main Code  Select from List

Sub Code  Select from List

CA Bypass Billing Code OK

**When the billing code entry window is displayed, tap the box in [Main Code], then enter the main code.**

Specify the code using up to 32 single-byte characters.



### When not specifying a billing code

Tap the [Bypass Billing Code] key. The use code is set to the main code.

2

Billing Code

Please enter Billing Code.

Main Code  Select from List

Sub Code  Select from List

CA Bypass Billing Code OK

**Tap the box of [Sub Code], then enter the sub code.**

Specify the code using up to 32 single-byte characters.

3

Billing Code

Please enter Billing Code.

Main Code  Select from List

Sub Code  Select from List

CA Bypass Billing Code OK

**Tap the [OK] key.**



### To clear the value of the specified billing code

Tap the [CA] key. Enter the billing code again.



## REGISTERING A NEW BILLING CODE

Register a new billing code.

A billing code can be registered not only from the billing code entry window but also from "Settings".



### To register a billing code from Setting Mode

Select "Settings" → [User Control] → [Billing Code Setting] → [Main Code List] or [Sub Code List]. Register a main code in [Main Code List], and a sub code in [Sub Code List].



A total of up to 2000 main and sub codes can be registered.

## Shared range of billing code

The registered billing codes can only be shared in the specified group at the time of user authentication.

If the shared range is not specified, the registered billing codes are shared by all users.



### To register a user group

In "Settings (administrator)", select [User Control] → [User Settings] → [Organization /Group List].

1

**When the billing code entry window is displayed, tap [Select from List] of the main code.**

To register a new sub code, tap the [Select from List] key of the sub code.

The subsequent steps are the same as the main code.

2

**Tap [Add/Edit Billing Code] on the action panel**





3

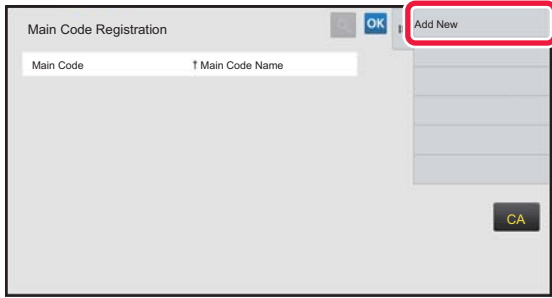

Tap [Add New] on the action panel.



To return to the billing code selection window  
Tap **OK**.

4

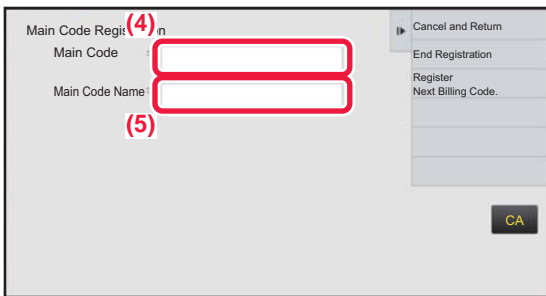

Tap the box of [Main Code], then type in the main code.

Specify the code using up to 32 single-byte characters.

5

Tap the box of [Main Code Name], then type in the main code name.  
Specify the code name using up to 32 double- or single-byte characters.

6



If necessary, select the share range of billing code.

Public to All: Registers the billing code as a public code for all users who use the machine.  
Specify target public address: Limits the share range of billing code to be registered only to the specified group. Up to eight groups can be specified as a public destination.

For details on how to specify a public destination, refer to "[Shared range of billing code \(page 1-65\)](#)".



The public destination of a billing code is not displayed if user authentication is not performed. The mode is automatically set to [Public to All].



7

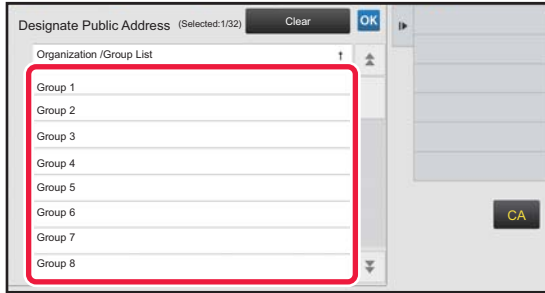

### Tap and select a group as a public destination

Up to eight groups can be specified. After the settings are completed, tap **OK**.



#### To cancel the setting

Tap [Clear] on the action panel. This cancels the registered public destination and returns the screen to the previous window.

8

### To continuously register other billing codes, tap [Register Next Billing Code.].

Execute steps 4 to 7 to register the main code.



#### To cancel the registration

Tap [Cancel and Return] on the action panel. This cancels all the registered billing codes and returns the screen to the previous window.

9

### Tap [End Registration] on the action panel.

This finalizes the registration and returns the screen to the previous window. Tap **OK** to finish the registration procedure.



#### To return to the billing code entry window

Tap the [CA] key.



# EDITING OR DELETING THE REGISTERED BILLING CODE

You can change or delete the registered billing code.  
The billing code can also be edited or deleted from "Settings".



## To edit or register a billing code from Setting mode

Select "Settings" → [User Control] → [Billing Code Setting] → [Main Code List] or [Sub Code List]. Edit or register a main code in [Main Code List], and a sub code in [Sub Code List].

## Editing a billing code

1

When the billing code entry window is displayed, tap the [Select from List] key of the main code.

To register a new sub code, tap the [Select from List] key of the sub code.

The subsequent steps are the same as the main code.

2

Tap [Add/Edit Billing Code] on the action panel.

3

Tap and select the main code to be edited, then tap [Edit] on the action panel.



To return to the billing code selection window

Tap .



4

Main Code Registration

Main Code: AAAA

Main Code Name: AAAA

Available to: Public to All

Specify target public address

Cancel and Return

End Registration

Register

Next Billing Code.

CA

### Edit the main code as required.

For information on how to correct the code, refer to steps 4 to 7 in "[REGISTERING A NEW BILLING CODE \(page 1-65\)](#)".

5

### Tap [End Registration] on the action panel.

This finalizes the registration and returns the screen to the previous window. Tap **OK** to finish the registration procedure.



### To return to the billing code entry window

Tap the [CA] key.



## Deleting a billing code

1

Billing Code

Please enter Billing Code.

Main Code: AAAA [Select from List]

Sub Code: AAAA [Select from List]

[CA] [Bypass Billing Code] [OK]

When the billing code entry window is displayed, tap the [Select from List] key of the main code.

To delete a sub code, tap the [Select from List] key of the sub code.

The subsequent steps are the same as the main code.

2

Select Billing Code

| Main Code | Main Code Name |
|-----------|----------------|
| MAIN001   | Company 1      |
| MAIN002   | Company 2      |
| MAIN003   | Company 3      |
| MAIN004   | Company 4      |
| MAIN005   | Company 5      |
| MAIN006   | Company 6      |
| MAIN007   | Company 7      |
| MAIN008   | Company 8      |

[Add/Edit Billing Code]

[Execute] [Cancel and Return] [CA]

Tap [Add/Edit Billing Code] on the action panel.

3

Main Code Registration

| Main Code | Main Code Name |
|-----------|----------------|
| MAIN001   | Company 1      |
| MAIN002   | Company 2      |
| MAIN003   | Company 3      |
| MAIN004   | Company 4      |
| MAIN005   | Company 5      |
| MAIN006   | Company 6      |
| MAIN007   | Company 7      |
| MAIN008   | Company 8      |

[Delete]

[Add New] [Edit] [OK] [CA]

Tap and select the main code to be deleted, then tap [Delete] on the action panel.



To return to the billing code selection window

Tap [OK].

4

When the confirmation message appears, tap the [Delete] key.



# Billing Code Setting

Configure settings for the Billing Code Setting

In "Settings (administrator)" → [User Control] → [Billing Code Setting].

## Administration Settings

Change the billing code setting.

### Use Billing Code

Switch whether to enable or disable a billing code.

### Default Code Setting

A use code is automatically assigned when no billing code is entered. Specify the code using up to 32 single-byte characters.

### Remember Billing Code Between Modes

If this function is enabled, the billing code entry window is not displayed at the time of mode transition.

### Disable Change of Billing Code

If this function is enabled, you cannot register, edit, or delete a billing code.

In addition, you cannot directly type in a billing code in the billing code entry window.

### Apply Default Code when Billing Code not entered

If this function is enabled, a use code is always set while you are logging in with device account.

### Disable Billing Code for Selected Applications

The billing code entry window is displayed when the external application that is set to enable is started.

The following settings can be configured.

- Application Name registered as Standard Application

### Billing Code Display Name Setting

You can change the main code or sub code name displayed in the billing code entry window or billing code selection window.

## Main Code List

You can display a list of main codes to search for, register, correct, or delete a main code.

- [Search] key  
Searches for a main code.
- [Add] key  
Adds a new main code.
- List  
Displays a list of registered main codes. Selecting each main code displays the window to correct the main code.
- [Delete] key  
Set the check box on the left of each main code to , then tap the [Delete] key; the selected main code is deleted.

### Register a main code

When you tap the [Add] key, the registration screen appears. A total of up to 2,000 main and sub codes can be registered.

For information on the settings, see "[Settings \(page 1-72\)](#)".

After the setting has been completed, tap the [Submit and Register Next] key; you can continuously register the next main code. To end the registration process, tap the [Submit] key.



## Correct a main code

Selecting a main code from the list displays the window to correct the main code.

For information on the settings, see "[Settings \(page 1-72\)](#)".

After the setting has been completed, tap the [Submit] key; you can apply the corrected contents and complete processing.

## Search for a main code

Enter the main code and main code name, then tap the [Search] key; the search result is displayed.

## Settings

| Item           | Description   |
|----------------|---|
| Main Code      | Enter the main code. Specify the code using up to 32 single-byte characters.  |
| Main Code Name | Enter the main code. Specify the code name using up to 32 double- or single-byte characters.  |
| Available to   | The registered billing codes can only be shared in the specified group.<br>When not specifying a public destination, select [All Users].<br>When specifying a public destination, select [Designate Public Address.], then specify a group to share the billing code. |



### To register a group for specifying a public destination

In "Settings (administrator)", select [User Control] → [User Settings] → [Organization /Group List].

## Sub Code List

You can display a list of sub codes to search for, register, correct, or delete a sub code.

- [Search] key  
Searches for a sub code.
- [Add] key  
Adds a new sub code.
- List  
Displays a list of registered sub codes. Selecting each sub code displays the window to correct the sub code.
- [Delete] key  
Set the check box on the left of each sub code to , then tap the [Delete] key; the selected sub code is deleted.

## Register a sub code

When you tap the [Add] key, the registration screen appears. A total of up to 2,000 main and sub codes can be registered.

For information on the settings, see "[Settings \(page 1-72\)](#)".

After the setting has been completed, tap the [Next] key; you can continuously register the next sub code. To end the registration process, tap the [Submit] key.

## Correct a sub code

Selecting a sub code from the list displays the window to correct the sub code.

For information on the settings, see "[Settings \(page 1-72\)](#)".

After the setting has been completed, tap the [Submit] key; you can apply the corrected contents and complete processing.



## Search for a sub code

Enter the sub code and sub code name, then tap the [Search] key; the search result is displayed.

## Settings

| Item          | Description   |
|---------------|---|
| Sub Code      | Enter the sub code. Specify the code using up to 32 single-byte characters.   |
| Sub Code Name | Enter the sub code. Specify the code name using up to 32 double- or single-byte characters.   |
| Available to  | The registered billing codes can only be shared in the specified group.<br>When not specifying a public destination, select [All Users].<br>When specifying a public destination, select [Designate Public Address.], then specify a group to share the billing code. |



### To register a group for specifying a public destination

In "Settings (administrator)", select [User Control] → [User Settings] → [Organization /Group List].





# NAS

NAS (Network Attached Storage) is a storage device that is connected to the network.

You can use part of the machine's local drive area as a simple file server to save files and browse saved files.

## Folder structure

The folder structure is as follows.

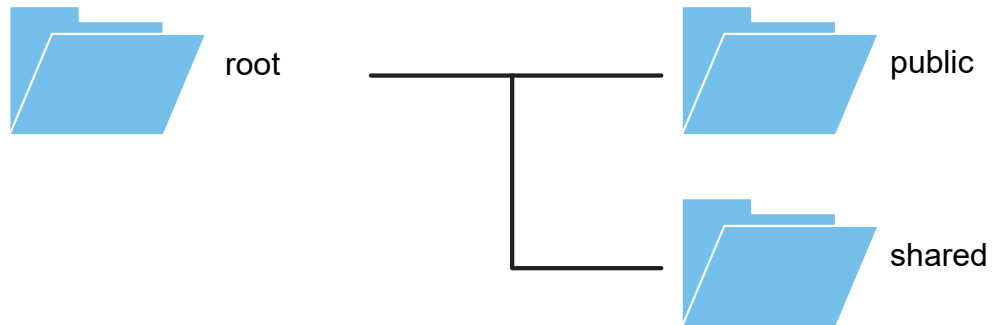

- root
- public: Area for storing PDF files for PC browsing that have been created using the document filing function.
- shared: Area where you can freely create folders.



### To use NAS

- Set the folder that you want to allow to be used to [Allow] in "Settings (administrator)" - [System Settings] → [Network Settings] → [Public Folder / NAS Setting]. (The factory default setting is "Allow".)
- Set the SMB setting of the server port to [Valid] in "Settings (administrator)" - [System Settings] → [Security Settings] → [Port Control]. (The factory default setting is "Invalid".)



## Saving files in NAS / browsing NAS files

**1**

**You can save data that you need to the machine's local drive, and view the data on your computer.**

**Document scanned on the machine**

In document filing, tap the [Create PDF for PC Browsing] checkbox so that it is selected , and copy to the public folder to save the data.

► [Creating PDF for PC browsing \(page 5-14\)](#)

**2**

**Using as a file server / browsing saved files.**

To use this, open any folder screen on your computer and enter the IP address of the machine after "\\" in the address bar (example: \\192.168.1.28).



- Access restrictions are set for each folder, so you must enter the login name and password of the administrator account or of a user account that has been registered in the machine.
- The maximum size per file is 2 GB.

## Public Folder / NAS Setting

In "Settings (administrator)", select [System Settings] → [Network Settings] → [Public Folder / NAS Setting]. The "public" and "shared" folders of the MFP can be accessed as network folders from a network PC.

### Settings

| Item   | Settings  |
|--------|---|
| public | When [Use of Storage] is set to [Allow], the PDF files for PC viewing in the "public" folder can be accessed. |
| shared | If the [Use of Storage] is set to [Allow], you can use the "shared" folder as a network folder.               |



# REMOTE OPERATION OF THE MACHINE

Remotely operate the machine on your computer.

You can operate the machine from the same panel as the machine's operation panel that is displayed on your PC, with the same feel as operating in front of the machine.

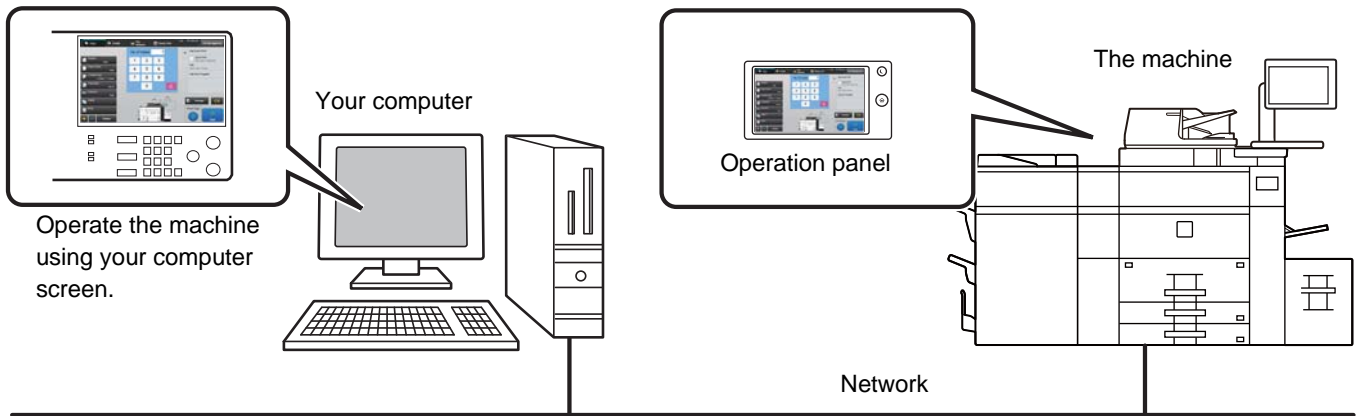

The remote operation function can only be used on one computer at a time.

Before you can use the remote operation function, the following preparation is required.

- In "Settings (administrator)", select [System Settings] → [Common Settings] → [Operation Settings] → [Condition Settings] → [Remote Operation Settings] → [Remote Software Operation] and select [Allow] for [Operational Authority].
- Connect the machine to the network.
- Install a VNC application software (recommended VNC software: RealVNC) in your computer.

After the preparation is completed, follow the operation described below to set up the function.

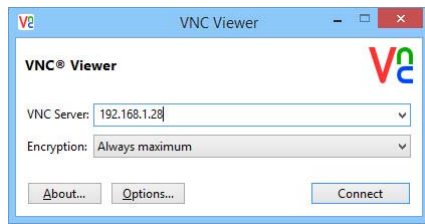

## Example: RealVNC

**1**



Start the VNC viewer, enter the IP address of the machine in the "VNC Server" entry box, and click the [Connect] button.



Check with the administrator of the machine for its IP address.

**2**

### Follow the message on the operation panel of the machine to permit the connection.

When the machine is connected to a VNC application software,  appears on the system bar of the machine's touch panel. If you wish to disconnect, exit the VNC application software or tap .



Use the operation panel in the same way as you would on the machine. However, you cannot enter values in series by continuously clicking the key.



#### Remote Operation Settings

Configure settings required for remote operation of the machine from a PC connected to the same network. In "Settings (administrator)", select [System Settings] → [Common Settings] → [Operation Settings] → [Condition Settings] → [Remote Operation Settings].

#### Remote Software Operation

- Operational Authority: This is used when remote software is used to operate the machine remotely.
- View Password Entry Screen: When operating the machine by remote control using the remote software, the password entry screen will appear on both the computer and the machine, or on only the computer.

#### Operation from Specified PC

- Operational Authority: This is used to allow remote operation of the machine using the specified PC.
- Hostname or IP Address of PC: Enter the host name or IP address of the PC to be connected to the machine.
- View Password Entry Screen: When operating the machine by remote control using the remote software, the password entry screen will appear on both the computer and the machine, or on only the computer.

#### Operation by User who Has Password

- Operational Authority: This is used to allow a user who has a password to operate the machine remotely. For information on the password, consult your service technician.
- View Password Entry Screen: When operating the machine by remote control using the remote software, the password entry screen will appear on both the computer and the machine, or on only the computer.



# UNIVERSAL DESIGN IN THE MACHINE

The structure of the machine and the software are designed to allow all people to use the machine with ease.

## UNIVERSAL DESIGN RELATED TO OPERATION

### Grip handle on paper trays

The grip-type handles allow easy use from above or below. By simply placing your hand on a handle and gently pulling forward, the lock releases. The trays can be manipulated in a natural manner.

### Changing of key response time

The response time of the keys can be changed as needed.

In "Settings" (administrator), select [System Settings] → [Common Settings] → [Operation Settings] → [Condition Settings] → [Key Operation Setting].

- **Time for Accepting Key Entry**

This setting determines how long a key in the touch panel must be tapped until the key input is registered. The time can be set from 0 to 2 seconds in increments of 0.5 seconds.

By lengthening the time setting, key input can be prevented when a key is tapped accidentally. Keep in mind, however, that when a longer setting is selected more care is required when tapping keys to ensure that key input is registered.

- **Disable Auto Key Repeat**

This is used to disable key repeat.

Key repeat causes a setting to change continuously not only each time the key is tapped but while a key is tapped.

- **Long-touch Detection Time**

Select a time when a long key touch is detected.

- **Double Tap Speed Interval**

Select an interval when a double tap is detected.



## Confirmation of placement of original in document feeder

You can use the original setting indicator to check if an original has been correctly placed in the auto document feeder. Select "Settings (administrator)" → [System Settings] → [Common Settings] → [Device Control] → [Status Indicator Setting] → [Use Original Detection Light for Document Feeder].

## UNIVERSAL DESIGN RELATED TO VISION

### Changing of text size

The size of the text on the touch panel can be changed. When the text on the touch panel is small and difficult to read, the text can be enlarged.

In "Settings" (administrator), select [System Settings] → [Common Settings] → [Operation Settings] → [Condition Settings] → [Enlarge Display Mode].

- **Enlarge Display Mode**

Displays large characters on the screen.

 appears in the system area when Enlarge Display Mode is enabled.

## UNIVERSAL DESIGN RELATED TO HEARING

### Audible alert sounds when changing settings

When moving through copy ratio or exposure settings, the user is alerted by an audible sound at the default setting (copy ratio 100%, exposure 3).

In "Settings (administrator)", select [System Settings] → [Sound Settings] → [Beep Sound Settings (Common)] → [Keys Touch Sound] and [Reference Tone].

- **Keys Touch Sound**

Controls the key touch sound level, or turns the sound off. You can also have two peeps sound at initial values when setting the ratio in copy mode or when adjusting the exposure in any mode.

| Screen in which setting is effective                                       | Initial value              |
|--|----------------------------|
| Ratio setting screen in base screen of copy mode                           | Ratio 100%                 |
| Exposure setting screen in base screen of copy mode                        | Exposure level: 3 (medium) |
| Exposure adjustment screen in base screen of network scanner modes         |                            |
| Exposure adjustment screen for Scan to Local Drive in document filing mode |                            |

- **Make Key Touch Sound at Default Setting**

When you specify the exposure in the exposure adjustment screen of each mode, a bleep sounds two times when the reference value is reached.



# UNIVERSAL DESIGN FEATURES

The machine has design features and settings that are compatible with universal design.

## Easy-to-use user interface

- **Easy mode**

This mode shows only frequently used items. Buttons and text are enlarged to increase ease of operation. Almost all regular operations can be completed using the easy mode screen.

- ▶ [COPY MODE \(page 2-3\)](#)

- ▶ [NETWORK SCANNER MODE \(page 4-7\)](#)

- **Customizing the home screen and adding icons**

You can add icons to the home screen. You can also change an icon image to a custom image.

Add an icon image in "Settings (administrator)" - [System Settings] → [Home Screen Settings] → [Icon].

To add an icon to the home screen, add a key in "Settings (administrator)" - [System Settings] → [Home Screen Settings] → [Condition Settings] → [Home Button]/[Fix Key].

- **Customizing the home screen - changing the display order**

You can change the order of the items in the home screen so that the items you use most frequently appear first.

To change the order of the items in the home screen, change in "Settings (administrator)" - [System Settings] → [Home Screen Settings] → [Condition Settings] → [Home Button].

- **Customizing the home screen - intuitive and easy-to-use design**

A flat icon design is used to make the screen intuitive and easy to view. The toner level is always shown, eliminating the need to perform an action to check the toner level.



For the procedures for editing the home screen, see "User's Manual (Touch Panel Operation)".

- **High-contrast display (UD pattern)**

The touch panel image can be set to high contrast.

Select [Pattern 5] in "Settings (administrator)" - [System Settings] → [Common Settings] → [Operation Settings] → [Condition Settings] → [MFP Display Pattern Setting].

- **Multi-language display**

The language used in the touch panel can be changed to another language such as English or French.

Select the desired language in "Settings (administrator)" - [System Settings] → [Common Settings] → [Operation Settings] → [Condition Settings] → [Display Language Setting].



## Intuitive operation

- **Quick-view operation guide**

Touch the [Operation Guide] key in the home screen on the touch panel to display the operation guide. The operation guide provides simple explanations of how to use the machine.

- **Easy operation by storing programs**

The program function lets you store groups of settings for copying, and other functions. By storing groups of settings that you frequently use, you can easily select those settings.

- ▶ [PROGRAMS \(page 2-134\)](#)

- ▶ [STORING SCAN OPERATIONS \(PROGRAM\) \(page 4-59\)](#)

- **Remote operation**

You can display the machine's touch panel on a computer on the same network to operate the machine from the computer. You can show how to use the machine on a computer, and people who have difficulty using the touch panel can operate the machine from a computer.

- ▶ [Public Folder / NAS Setting \(page 1-75\)](#)

## Easier operation at the machine

- **Darkened output tray color**

Output tray colors are darkened to make it easy to distinguish the tray to which a job has been output.

- **On right side of operation panel**

Located on the right side of the operation panel, this allows smooth removal of paper without interfering with the output tray.

## Simple toner replacement

- **Prevention of toner cartridge mis-installation**

To prevent installation of a toner cartridge in the wrong location, each color of toner cartridge can only be installed in its own location.

- ▶ [REPLACEMENT OF TONER CARTRIDGE \(page 1-156\)](#)

- **Toner box can be opened with one hand**

The box that contains a toner cartridge can be easily opened with one hand.





# ITEMS RECORDED IN THE JOB LOG

The machine records the performed jobs in the job log.  
The main information recorded in the job log is described below.



- To make it easy to total the usage counts of differently configured machines, the items recorded in the job log are fixed, regardless of what peripheral devices are installed or the objective of the recording.
- In some cases, job information may not be correctly recorded, such as when a power failure occurs during a job.

| No. |            | Item name                          | Description   |
|-----|------------|------------------------------------|---|
| 1   | Main items | Job ID                             | The job ID is recorded. Job IDs appear in the log as consecutive numbers up to a maximum of 999999, after which the count resets to 1.  |
| 2   |            | Account Job ID                     | The job ID used in the Sharp OSA is recorded.   |
| 3   |            | Job Mode                           | The job mode type, such as copy or print is recorded.   |
| 4   |            | Computer Name                      | The name of the computer that sent a print job is recorded.*  |
| 5   |            | User Name                          | The user name when the user authentication function is used is recorded.  |
| 6   |            | Login Name                         | The login name when the user authentication function is used is recorded.   |
| 7   |            | Card ID                            | The card ID when it is used for an authentication process is recorded.  |
| 8   |            | Number of Card Issuance            | The number of times the card has been issued is written in an SSFC IC card is recorded.   |
| 9   |            | Main Code                          | Main Code is recorded.  |
| 10  |            | Sub Code                           | Sub Code is recorded.   |
| 11  |            | Starting Date & Time               | The date and time the job was started are recorded.   |
| 12  |            | Completing Date & Time             | The date and time the job was completed are recorded.   |
| 13  |            | Black & White Total Count          | For a print job, the total count is recorded. For a send job, the number of transmitted black & white pages is recorded. When a broadcast transmission is summarized, the total number of pages is recorded. For a scan to Local Drive job, the number of stored black & white pages is recorded. |
| 14  |            | Full Color Total Count             | The total number of pages in a print job that have been printed using a full color is recorded.   |
| 15  |            | Count according to size            | Counts by original/paper size in color mode and black & white mode are recorded.  |
| 16  |            | Number of sheets according to size | The number of pages is logged by paper size.  |
| 17  |            | Invalid Paper Count                | The invalid sheet count is recorded.  |
| 18  |            | Number of Reserved Sets            | Number of specified sets or reserved destinations is recorded.  |
| 19  |            | Number of Completed Sets           | Number of completed sets or number of destinations to which transmission was successfully completed is recorded.  |



| No. |                              | Item name                          | Description   |
|-----|------------------------------|------------------------------------|---|
| 20  | Main items                   | Number of Reserved Pages           | Number of reserved original pages of a copy, print, scan job, or other job is recorded.                         |
| 21  |                              | Number of Completed Pages          | Number of completed pages of a set is recorded.   |
| 22  |                              | Result                             | The result of a job is recorded.  |
| 23  |                              | Error Cause                        | When an error occurs during a job, the cause of the error is recorded.  |
| 24  | Print Job Related Item       | Output                             | The output mode of a printed job is recorded.   |
| 25  |                              | Staple                             | The status of stapling is recorded.   |
| 26  |                              | Staple Count                       | The staple count is recorded.   |
| 27  |                              | Punch                              | The status of punching is recorded.   |
| 28  |                              | Punch Count                        | The punch count is recorded.  |
| 29  |                              | Fold                               | A job that uses the fold function is recorded.  |
| 30  |                              | Fold Count                         | Number of folded pages is recorded.   |
| 31  |                              | Saddle Fold                        | A job that uses the saddle fold function is recorded.   |
| 32  |                              | Saddle Fold Count                  | Number of saddle folded pages is recorded.  |
| 33  |                              | Printer Tone                       | The tone used for a print job is recorded.  |
| 34  | Image Send Related Item      | Address                            | Address of an image send job is recorded.   |
| 35  |                              | Sender Name                        | Sender name of an image send job is recorded.   |
| 36  |                              | Sender Address                     | Sender address of an image send job is recorded.  |
| 37  |                              | Transmission Type                  | Transmission type of an image send job is recorded.   |
| 38  |                              | Administrative Serial Number       | Administrative serial number of an image send job is recorded.  |
| 39  |                              | Broadcast number                   | Broadcast number of an image send job is recorded.  |
| 40  |                              | Entry Order                        | Reservation order for broadcast transmission of an image send job is recorded.                                  |
| 41  |                              | File Format                        | File format of an image send job or scan to local drive job is recorded.  |
| 42  |                              | Sign                               | Records whether or not an electronic signature is used in e-mail transmission.                                  |
| 43  |                              | Encry.                             | Records whether or not encryption is used for e-mail transmission.  |
| 44  |                              | Compression Mode/Compression Ratio | Compression mode and compression ratio of the file of an image send job or scan to local drive job is recorded. |
| 45  |                              | Communication Time                 | The communication time of image send jobs is recorded.  |
| 46  | Document Filing Related Item | Document Filing                    | Status of document filing is recorded.  |
| 47  |                              | Storing Mode                       | Document filing storing mode is recorded.   |



| No. |                      | Item name      | Description  |
|-----|----------------------|----------------|--|
| 48  | Common Functionality | Color Setting  | Color mode selected by user is recorded.   |
| 49  |                      | Special Modes  | Special modes selected when the job was executed is recorded.  |
| 50  |                      | File Name      | The stored file name is recorded.*   |
| 51  |                      | Data Size [KB] | The size of a file is recorded.  |
| 52  | Detailed Items       | Original Size  | Size of scanned original is recorded. For a document filing print job, the paper size of the file is recorded.   |
| 53  |                      | Original Type  | Original type (text, printed photo, etc.) set in the exposure settings screen is recorded.   |
| 54  |                      | Original Count | Number of scanned original sheets is recorded.   |
| 55  |                      | Paper Size     | For a print job, the paper size is recorded. For a send job, the transmitted paper size is recorded. For a Scan to Local Drive job, the paper size of the stored file is recorded. |
| 56  |                      | Paper Type     | The paper type used for printing is recorded.  |
| 57  |                      | Paper Property | The paper property specified in "Paper Type" is recorded.  |
| 58  |                      | Duplex Setup   | The duplex setting is recorded.  |
| 59  |                      | Resolution     | The scanning resolution is recorded.   |
| 60  |                      | Machine Item   | Model Name   |
| 61  | Unit Serial Number   |                | The serial number of the machine is recorded.  |
| 62  | Name                 |                | The name of the machine that is set in the Web pages is recorded.  |
| 63  | Machine Location     |                | The installation location of the machine that is set in the Web pages is recorded.   |
| 64  | Machine ID           |                | Record the Machine ID entered by the service technician.   |

\* In some environments this is not recorded.

## PRINTING A MANUAL FROM THE OPERATION PANEL

The manuals can be printed from the Operation Guide embedded in the machine. To print a manual, refer to the Quick Start Manual.



### Prohibiting printing of manuals from the operation panel

In "Settings (administrator)" - [System Settings] → [Common Settings] → [Operation Settings] → [Condition Settings] → [Disable Printing of Operation Manual from the Operation Panel].



# LOADING PAPER

## IMPORTANT POINTS ABOUT PAPER NAMES AND LOCATIONS OF TRAYS

When a large capacity tray is installed

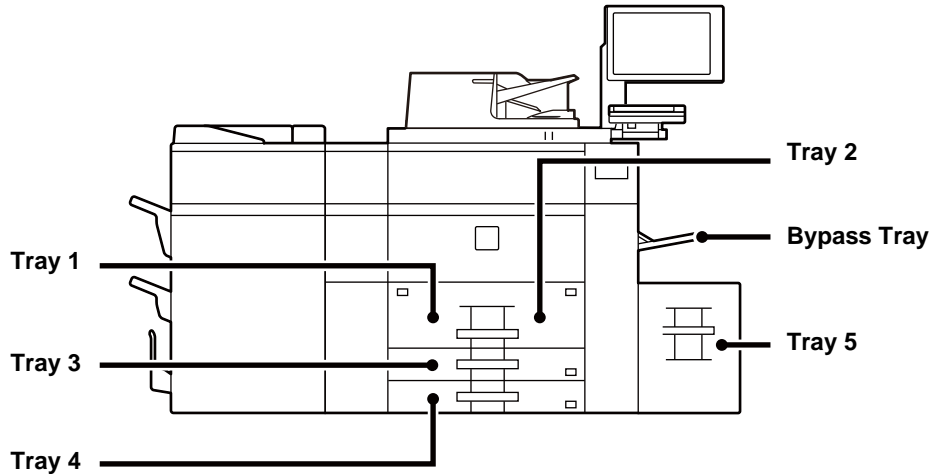

When large capacity trays are installed

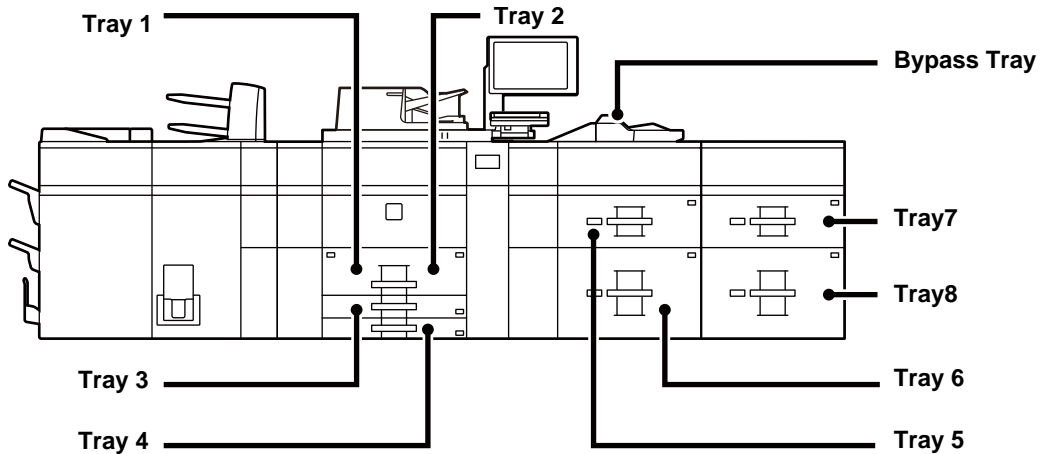



## THE DEFINITION OF "R" IN PAPER SIZE

To indicate the landscape setting, "R" is added to the end of the name of a paper size enabled for both landscape and portrait settings.

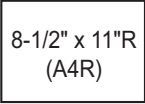
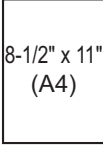
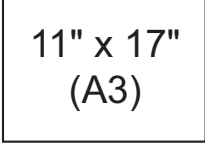
| Paper that can be set either in the portrait or landscape orientation             |   | Paper that can only be set in the landscape orientation                             |
|---|---|---|
| 8-1/2" x 11", A4, B5  |   | 12" x 18", 11" x 17", 8-1/2" x 14", 8-1/2" x 13", SRA3, A3W, A3, SRA4, B4           |
| Paper set in the landscape orientation  | Paper set in the portrait orientation   | Can be placed only in the landscape orientation                                     |
|  |  |  |

## APPLICABLE PAPER TYPES

This section describes paper types that can be used and those that cannot be used. All types of paper other than plain paper are referred to as special media.



- Various types of paper are commercially available, some of which cannot be used on the machine. Before using any paper, consult the dealer or nearest SHARP Service Department.
- The image quality and toner fusibility of paper may change due to ambient conditions, operating conditions, and paper characteristics, resulting in image quality inferior to that of Sharp standard paper. Before using any paper, consult the dealer or nearest SHARP Service Department.
- For paper specifications, see "[SPECIFICATIONS \(page 8-2\)](#)".
- The use of non-recommended or non-usable paper may result in skewed feeding, misfeeds, poor toner fusing (the toner does not adhere to the paper well and can be rubbed off), or machine failure.
- The use of non-recommended paper may result in misfeeds or poor image quality. Before using non-recommended paper, check whether printing can be performed properly.

## Useable paper

### Specifications of plain paper, heavy paper and thin paper

|              |               |  |
|--------------|---------------|--|
| Plain Paper* | Plain Paper 1 | 16 lbs. bond to 24 lbs. bond (60 g/m <sup>2</sup> to 89 g/m <sup>2</sup> )       |
|              | Plain Paper 2 | 24 lbs. bond to 28 lbs. bond (90 g/m <sup>2</sup> to 105 g/m <sup>2</sup> )      |
| Heavy paper  | Heavy paper 1 | 28 lbs. bond to 65 lbs. cover (106 g/m <sup>2</sup> to 176 g/m <sup>2</sup> )    |
|              | Heavy paper 2 | 65 lbs. cover to 80 lbs. cover (177 g/m <sup>2</sup> to 220 g/m <sup>2</sup> )   |
|              | Heavy paper 3 | 80 lbs. cover to 140 lbs. index (221 g/m <sup>2</sup> to 256 g/m <sup>2</sup> )  |
|              | Heavy paper 4 | 140 lbs. index to 110 lbs. cover (257 g/m <sup>2</sup> to 300 g/m <sup>2</sup> ) |
| Thin paper   |               | 13 lbs to 16 lbs (52 g/m <sup>2</sup> to 59 g/m <sup>2</sup> )                   |

\* If the paper that you normally use is Recycled, Pre-Punched, Pre-Printed, Letter Head, Color, or User Type 1 to 11, set an appropriate paper weight in "Settings" – [System Settings] → [Common Settings] → [Paper Settings] → [Paper Tray Settings] → [Paper Weight].



- The category of "Useable paper" is based on Sharp standard paper.
- If non-recommended paper is used, print quality may be affected even if a paper type setting that accords with the above paper divisions is selected. In that case, try setting the paper type to a type that is slightly heavier or slightly lighter than normal. For details, consult your dealer or nearest SHARP Service Department.
- For paper specifications, see see "[SPECIFICATIONS \(page 8-2\)](#)".
- Recycled paper, colored paper and pre-punched paper must meet the same specifications as plain paper. Before using any paper, consult the dealer or nearest SHARP Service Department.
- If the paper that was output is significantly curled, remove the paper from the cassette, turn the paper over so it is face down, and resume use.



### Types of paper that can be set in each tray

|   | Tray 1/2 | Tray 3 | Tray 4 | Bypass tray | Tray 5 Large capacity tray (MX-LC12) | Large capacity trays |          | Bypass tray (for large capacity trays) | Inserter (Upper / Lower) |
|---|----------|--------|--------|-------------|--------------------------------------|----------------------|----------|--|--------------------------|
|   |          |        |        |             |                                      | Tray 5/7             | Tray 6/8 |  |                          |
| Thin paper  | -        | -      | -      | Yes         | -                                    | Yes                  | Yes      | Yes                                    | -                        |
| Plain paper 1 (16 to 24 lbs bond (60 to 89 g/m <sup>2</sup> ))                                | Yes      | Yes    | Yes    | Yes         | Yes                                  | Yes                  | Yes      | Yes                                    | Yes                      |
| Plain paper 2 (24 to 28 lbs bond (90 to 105 g/m <sup>2</sup> ))                               | Yes      | Yes    | Yes    | Yes         | Yes                                  | Yes                  | Yes      | Yes                                    | Yes                      |
| Recycled paper  | Yes      | Yes    | Yes    | Yes         | Yes                                  | Yes                  | Yes      | Yes                                    | Yes                      |
| Color   | Yes      | Yes    | Yes    | Yes         | Yes                                  | Yes                  | Yes      | Yes                                    | Yes                      |
| Letter head   | Yes      | Yes    | Yes    | Yes         | Yes                                  | Yes                  | Yes      | Yes                                    | Yes                      |
| Pre-printed   | Yes      | Yes    | Yes    | Yes         | Yes                                  | Yes                  | Yes      | Yes                                    | Yes                      |
| Pre-punched   | Yes      | Yes    | Yes    | Yes         | Yes                                  | Yes                  | Yes      | Yes                                    | Yes                      |
| Heavy paper 1: 28 lbs bond to 65 lbs index (106 g/m <sup>2</sup> to 176 g/m <sup>2</sup> )    | -        | Yes    | Yes    | Yes         | Yes                                  | Yes                  | Yes      | Yes                                    | Yes                      |
| Heavy paper 2: 65 lbs index to 80 lbs Cover (177 g/m <sup>2</sup> to 220 g/m <sup>2</sup> )   | -        | Yes    | Yes    | Yes         | Yes                                  | Yes                  | Yes      | Yes                                    | Yes                      |
| Heavy paper 3: 80 lbs bond to 140 lbs index (221 g/m <sup>2</sup> to 256 g/m <sup>2</sup> )   | -        | -      | -      | Yes         | -                                    | Yes                  | Yes      | -                                      | -                        |
| Heavy paper 4: 140 lbs index to 110 lbs Cover (257 g/m <sup>2</sup> to 300 g/m <sup>2</sup> ) | -        | -      | -      | Yes         | -                                    | Yes                  | Yes      | -                                      | -                        |
| Tab paper   | -        | -      | Yes    | Yes         | -                                    | Yes                  | Yes      | Yes                                    | -                        |
| Transparency film   | -        | -      | Yes    | Yes         | -                                    | Yes                  | Yes      | Yes                                    | -                        |
| Labels  | -        | -      | Yes    | Yes         | -                                    | Yes                  | Yes      | -                                      | -                        |
| Glossy paper  | -        | -      | -      | Yes         | -                                    | Yes                  | Yes      | -                                      | -                        |

Yes: Can be used

-: Cannot be used



## Setting orientation of the print side

The setting orientation varies for the print side of paper, depending on the tray used. Place with the print side facing the direction indicated below.

| Tray                    | Print side  |
|-------------------------|-------------|
| Trays 1 - 4             | Facing down |
| Bypass tray, Tray 5 - 8 | Facing up   |

## Paper that cannot be used

- Embossed
- Envelope
- Special media for an ink jet printer  
(fine paper, glossy paper, glossy film, etc.)
- Carbon paper or thermal paper
- Pasted paper
- Paper with clips
- Paper with fold marks
- Torn paper
- Oil-feed transparency film
- Thin paper less than 15 lbs (55 g/m<sup>2</sup>)
- Heavy paper as thick as 140 lbs. cover (300 g/m<sup>2</sup>) over
- Irregularly shaped paper
- Stapled paper
- Damp paper
- Curled paper
- Paper whose print side or reverse side has been already printed on by printer or multifunction device.
- Paper with a wave-like pattern due to moisture absorption
- Paper with creases
- Paper with dust

## Non-recommended paper

- Iron-on transfer paper
- Perforated paper





# LOADING PAPER IN THE TRAY 1/2

A maximum of 1200 sheets of 8-1/2" × 11" (A4) paper can be loaded into tray 1.

A maximum of 800 sheets of 8-1/2" × 11" (A4) paper can be loaded into tray 2.



If you loaded paper of a different type or size from the paper previously loaded, be sure to check the settings in "Settings (administrator)". An incorrect setting may cause print failure, printing on paper of an incorrect size, or type or paper misfeeds.



Do not place heavy objects on the tray or press down on the tray.



• **To check the type and size of paper:**

[Tray Settings] in the home screen or in "Settings", select [Status] → [Machine Identification] → [Paper Input Tray Status] → [Paper Tray Settings].

• **To set the type and size of paper:**

Set this in [Tray Settings] in the home screen or in "Settings" - [System Settings]→[Common Settings]→[Paper Settings]→[Paper Tray Settings].

1

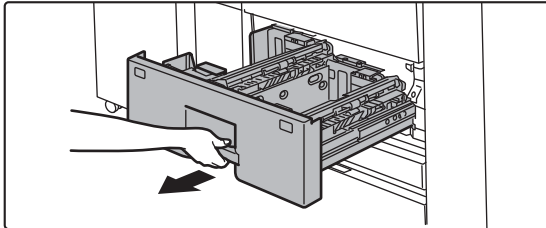

## Pull out the paper tray.

Gently pull the tray out until it stops.



Keep holding the handle until the lock is released.

2

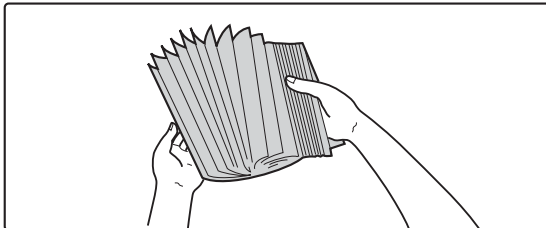

## Fan the paper.

Fan the paper well before loading it. If the paper is not fanned, multiple sheets may feed at once and cause a misfeed.



3

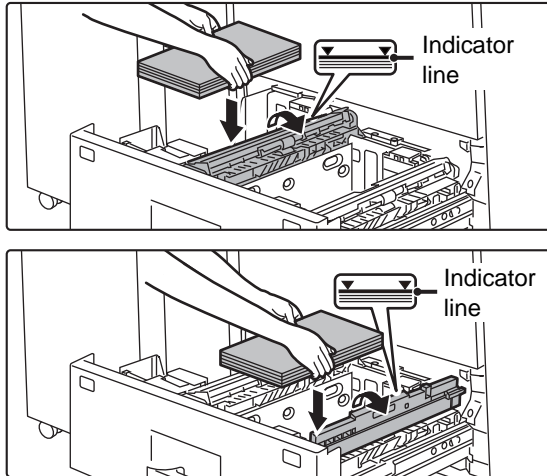

**Lift the feed roller, and place paper into the tray.**

Load the paper with the print side facing down.. The stack must not be higher than the indicator line (maximum of 1200 sheets for tray 1, or maximum of 800 sheets for tray 2).

4

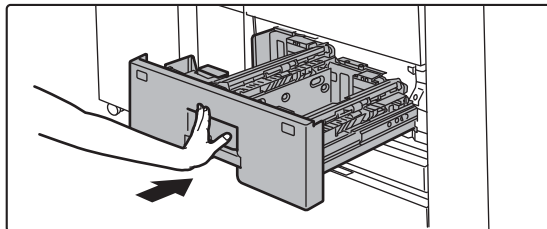

**Lower the feed roller, and gently push the paper tray into the machine.**

Push the tray firmly all the way into the machine slowly. Forcefully inserting the paper may cause skewed feeding and paper misfeeds.

**Changing the paper size**

1

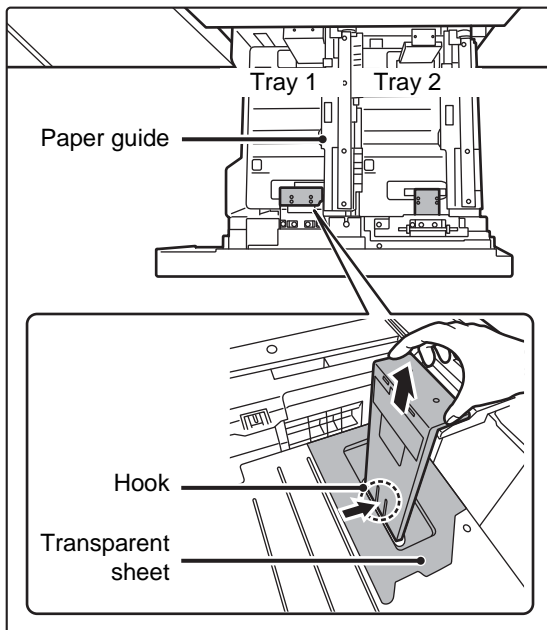

**Remove the paper size guide.**

With the base of the tray pressed all the way down, hold down the hook at the bottom on the paper size guide and pull the paper size guide up slightly.



Before changing the paper size of tray 2, raise the paper guide.



2

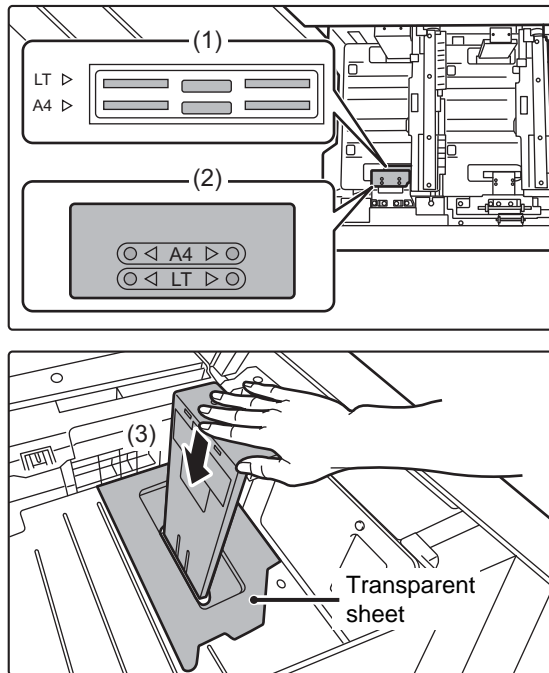

**Attach the paper size guide and transparent sheet appropriately for the size of paper to be used.**

**(1) Align the bottom of the paper size guide with the appropriate slot on the base of the tray.**

Align the paper size guide with the slot for the paper size to be used (indicated by the paper size mark).

**(2) Align the holes at the top of the paper size guide with the protrusions that secure the paper size guide.**

Align with the holes for the paper size to be used (indicated by the paper size mark).

**(3) Push in the paper guide so that it locks into place.**

Push the paper size guide in until the hook at the bottom locks into place. (You will hear a "click" when the hook locks.) Move the paper size guide slightly to verify that it has locked into place.



- When attaching the paper size guide, place the transparent sheet in direct contact with the base of the tray in the correct orientation as shown.
- The slot or hole with the "LT" mark is for 8-1/2" x 11" size.

When attaching the paper size guide, make sure that the top and bottom of the guide are aligned to the same paper size. If the top and bottom of the paper size guide are not aligned to the same paper size, skewed feeding and misfeeds will result.

3

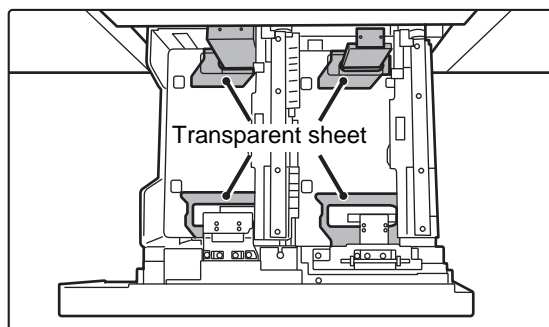

**Repeat steps 1 and 2 to adjust the far paper guide to the paper size to be used.**

Be sure to adjust the far paper guide to the same size as the near paper guide.

When removing and attaching the far paper size guide, take care not to hit the front cover of the machine.



Adjusting only one paper guide may result in skewed feeding or misfeeds.

4

**Set the paper size and paper type.**

Be sure to set the paper size and paper type by selecting [Tray Settings] in the home screen or in "Settings", select [System Settings] → [Common Settings] → [Paper Settings] → [Paper Tray Settings].

If the paper size setting is not configured correctly, automatic paper selection will not operate correctly and printing may take place on the wrong size or type of paper or a misfeed may occur.



# LOADING PAPER IN THE TRAY 3/4

A maximum of 500 sheets of paper from 12" x 18" to 7-1/4" x 10-1/2"R (A3W to B5R) can be loaded into tray 3.

A maximum of 500 sheets of paper from 12" x 18" to 5-1/2" x 8-1/2"R (A3W wide to A5R) can be loaded into tray 4.



- Other than plain paper, special media such as transparency film and tab paper can be loaded into tray 4. To load tab paper, the dedicated guide must be installed.
- If you loaded paper of a different type or size from the paper previously loaded, be sure to check the settings in "Settings (administrator)". An incorrect setting may cause print failure, printing on paper of an incorrect size, or type or paper misfeeds.



Do not place heavy objects on the tray or press down on the tray.



### To check the type and size of paper:

[Tray Settings] in the home screen or in "Settings", select [Status] → [Machine Identification] → [Paper Input Tray Status] → [Paper Tray Settings].

### To set the type and size of paper:

Set this in [Tray Settings] in the home screen or in "Settings", select [System Settings] → [Common Settings] → [Paper Settings] → [Paper Tray Settings].

1

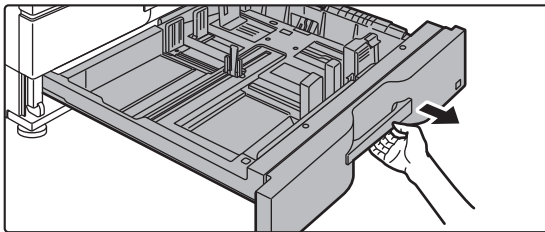

### Pull out the paper tray.

Gently pull the tray out until it stops.

To load paper, go to step 3.

To load a different size of paper, go to the next step.



Keep holding the handle until the lock is released.



2

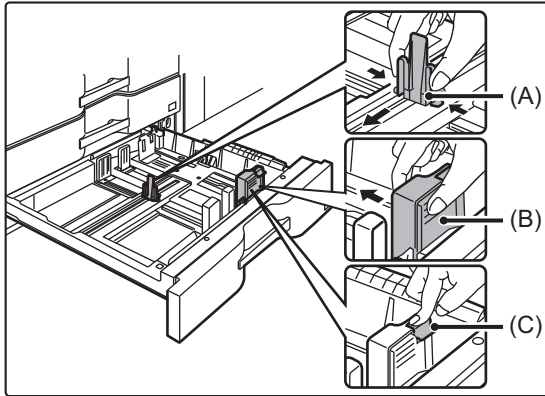

**Adjust guide plates A and B by squeezing their lock levers and sliding them to match the longitudinal and transversal dimensions of the paper to be loaded.**

**(1) Squeeze the lock knob on guide plate A and slide to the desired paper size.**

**(2) Squeeze the lock knob on guide plate B and slide to the desired paper size.**

If slid to a standard paper size, guide plate B will lock automatically.

**(3) For a non-standard paper size, after sliding guide plate B to the desired size, press the lock button (C).**



A non-standard size of paper can only be loaded in tray 4. A non-standard size of paper cannot be loaded in tray 3.

3

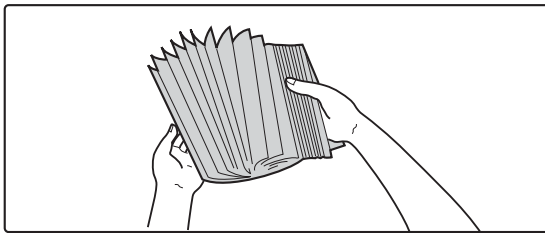

**Fan the paper.**

Fan the paper well before loading it. If the paper is not fanned, multiple sheets may feed at once and cause a misfeed.

4

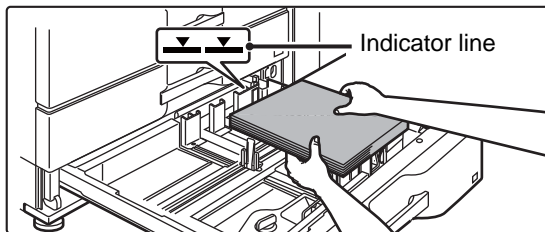

**Insert the paper into the tray.**

Load the paper with the print side facing down. The stack must not be higher than the indicator line (maximum of 500 sheets).

5

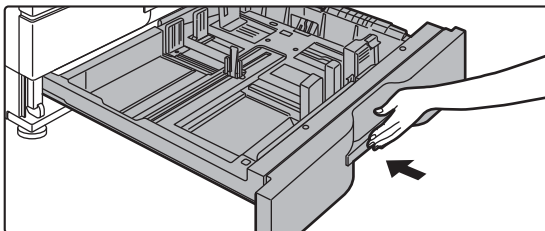

**Gently push the paper tray into the machine.**

Push the tray firmly all the way into the machine slowly. Forcefully inserting the paper may cause skewed feeding and paper misfeeds.



## Loading tab paper into tray 4

1

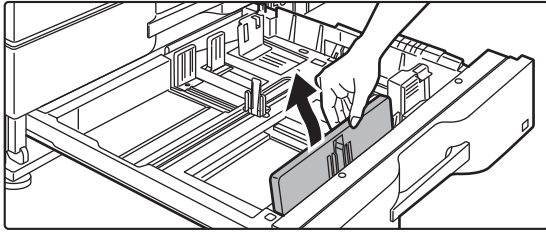

### Remove the tab paper guide.

The guide is stored inside tray 4.

2

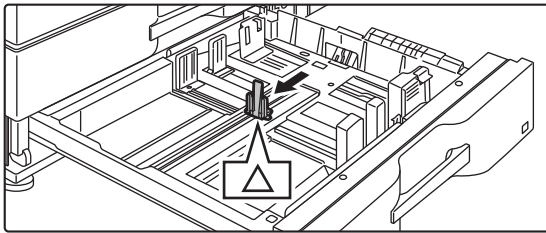

### Pull out the tray and install the guide.

Adjust the guide plates to the triangle mark position. Install the guide so that it may cover the guide plates. Adjust the guide plates in the tray to match the longitudinal and transversal dimensions of the paper to be loaded.

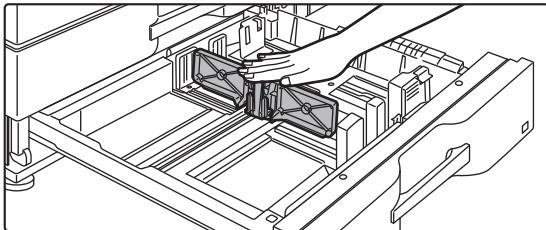
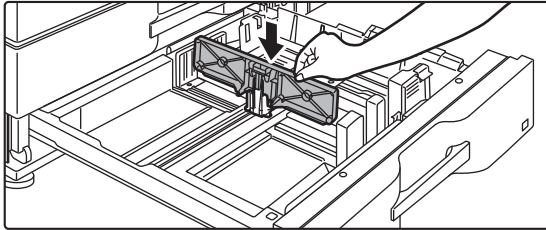

3

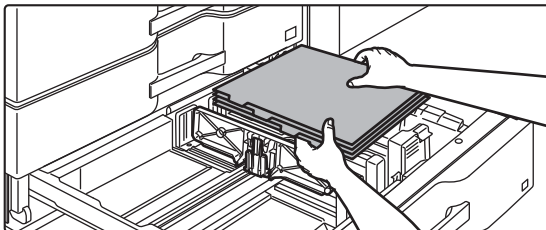

### Insert the tab paper into the tray.

Place the tab paper with the print side facing down so that the tab is to the left.



See the following figure and adjust the tab position of the tab paper.

**Originals**

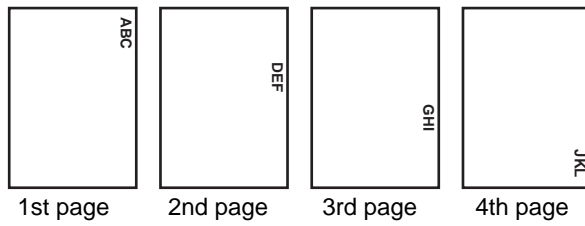

**Tab paper**

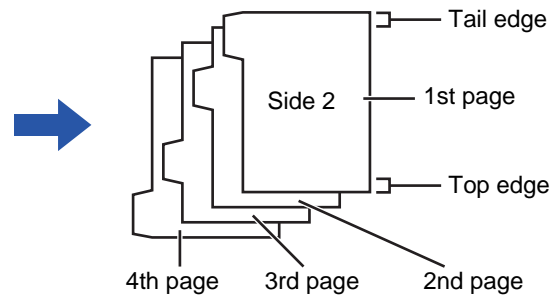

4

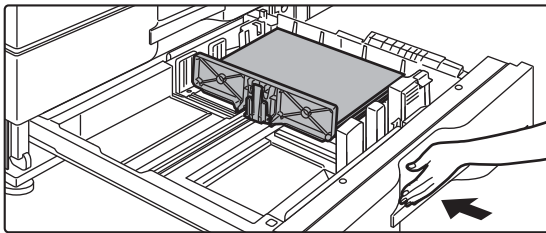

**Gently push the tray into the machine, and set the paper type to tab paper.**

Using "Paper Tray Settings" in the system settings, set the paper type to tab paper.



**To set the paper type to tab paper:**

Set this in [Tray Settings] in the home screen or in "Settings", select [System Settings] → [Common Settings] → [Paper Settings] → [Paper Tray Settings].



# LOADING PAPER IN THE LARGE CAPACITY TRAY

Use the large capacity tray for outputting massive prints that cannot be processed using the regular tray.

- Large capacity tray (MX-LC12) stores a maximum of 3500 sheets of 8-1/2" x 11", A4 and B5 paper.

When changing the paper size, consult the dealer or nearest SHARP Service Department.



Do not place heavy objects on the tray or press down on the tray.



## To check the type and size of paper:

[Tray Settings] in the home screen or in "Settings", select [Status] → [Machine Identification] → [Paper Input Tray Status] → [Paper Tray Settings].

## To set the type and size of paper:

Set this in [Tray Settings] in the home screen or in "Settings", select [System Settings] → [Common Settings] → [Paper Settings] → [Paper Tray Settings].

## Large capacity tray (MX-LC12)

1

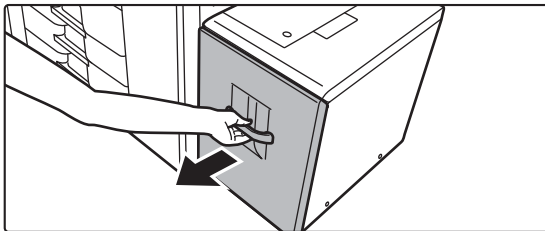

### Pull out the paper tray.

Gently pull the tray out until it stops.

2

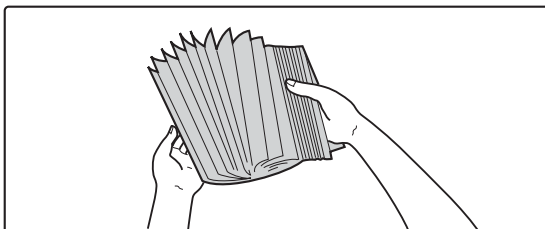

### Fan the paper.

Fan the paper well before loading it. If the paper is not fanned, multiple sheets may feed at once and cause a misfeed.

3

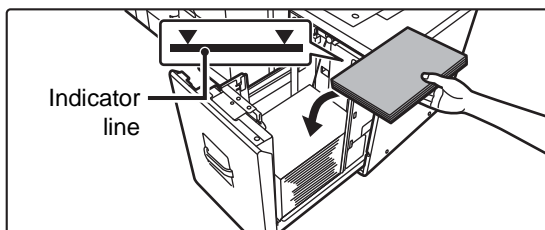

### Place the paper in the center of the paper table.

Load the paper with the print side facing up. The stack must not be higher than the indicator line (maximum of 3500 sheets).





4

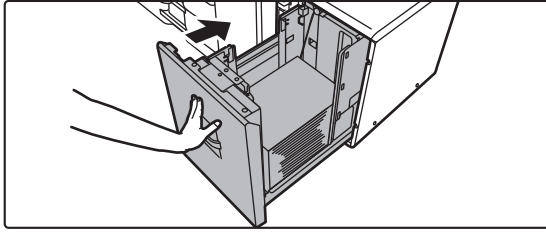

**Gently push the paper tray into the machine.**

Push the tray firmly all the way into the machine slowly. Forcefully inserting the paper may cause skewed feeding and paper misfeeds.



# LOADING PAPER IN THE LARGE CAPACITY TRAYS

Use the large capacity trays for outputting massive prints that cannot be processed using the regular tray. The large capacity trays store a maximum of 5000 sheets of paper (2500 sheets for tray 5 and 2500 sheets for tray 6) from 12" x 18" (A3W) to 7-1/4" x 10-1/2"R (B5R).



Other than plain paper, special media such as tab paper and transparency film can be loaded into the large capacity trays. To load tab paper, the dedicated guide must be installed.



Do not place heavy objects on the tray or press down on the tray.



### To check the type and size of paper:

[Tray Settings] in the home screen or in "Settings", select [Status] → [Machine Identification] → [Paper Input Tray Status] → [Paper Tray Settings].

### To set the type and size of paper:

Set this in [Tray Settings] in the home screen or in "Settings", select [System Settings] → [Common Settings] → [Paper Settings] → [Paper Tray Settings].

1

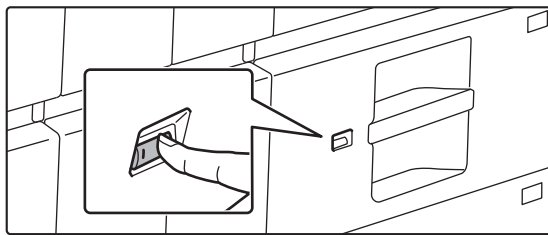

### Press the operation button.

The operation button blinks, and the tray paper table goes down to the paper loading position. Wait until the operation button light goes off.



Do not pull out the tray until the light goes off. If you pull out the tray forcibly while the button lights up or blinks, a machine failure may be resulted.

2

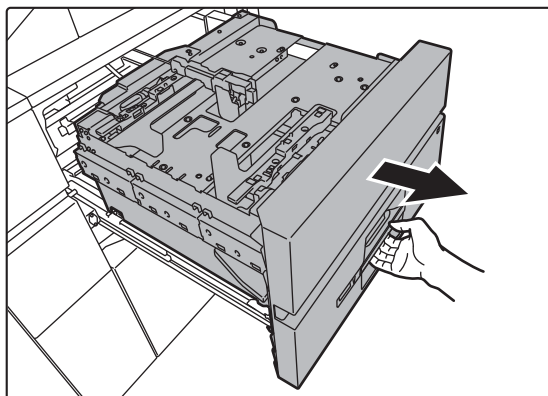

### Pull out the paper tray.

Gently pull the tray out until it stops.



3

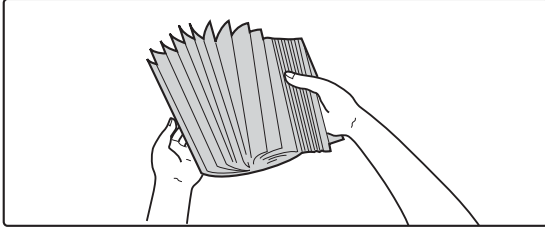

### Fan the paper.

Fan the paper well before loading it. If the paper is not fanned, multiple sheets may feed at once and cause a misfeed.

4

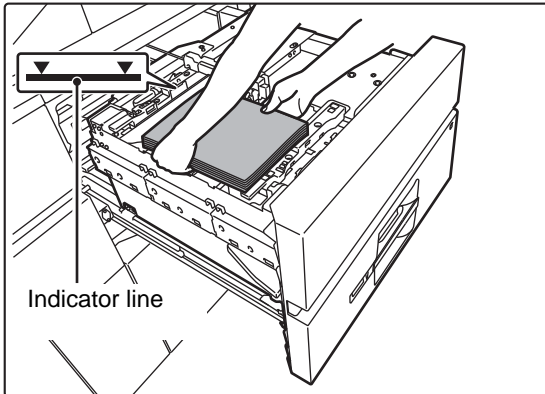

### Load the paper.

Load the paper with the print side facing up. The stack must not be higher than the indicator line (maximum of 2500 sheets).

5

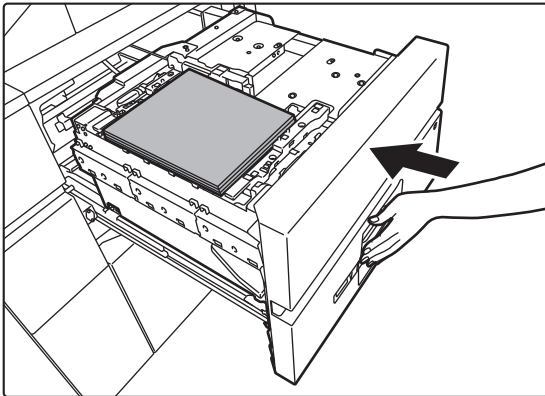

### Gently push the paper tray into the machine.

Push the tray firmly all the way into the machine slowly. Forcefully inserting the paper may cause skewed feeding and paper misfeeds. The paper table goes up after the tray is pushed in. The operation button blinks while the paper table goes up. The button lights up when the paper table has gone up.



## Loading the tab paper

1

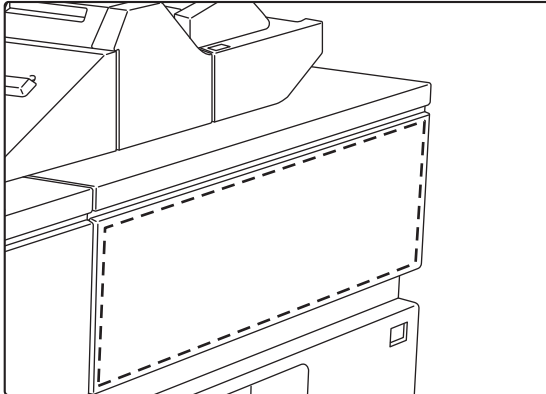

### Remove the tab paper guide.

The guide is stored in the upper tray.

2

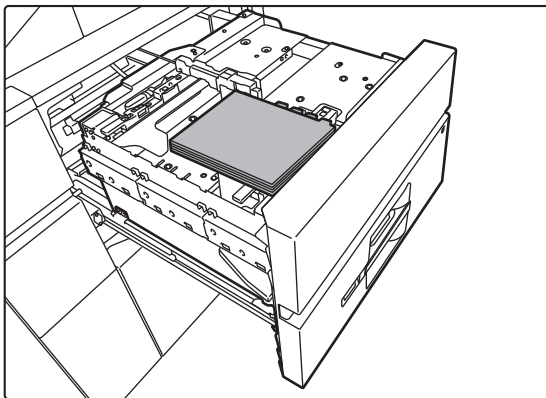

### Insert the tab paper into the tray.

Place the tab paper with the print side facing up so that the tab is to the right.



See the following figure and adjust the tab position of the tab paper.

#### Originals

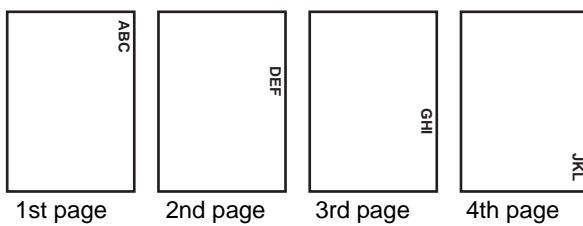

#### Tab paper

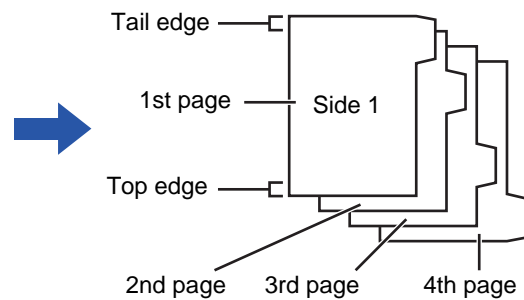



3

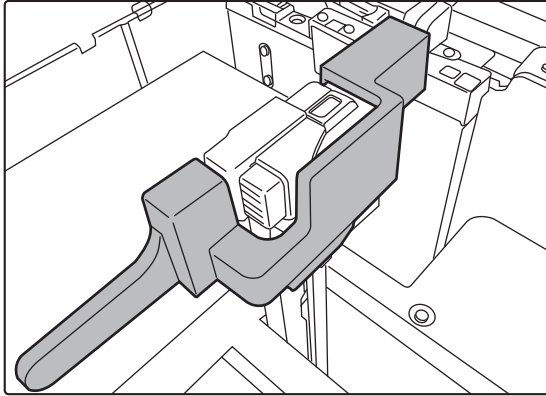

**Place the tab paper guide.**

Place the guide on the top of the tab paper.

4

**Gently push the tray into the machine, and set the paper type to tab paper.**

Using "Paper Tray Settings" in the system settings, set the paper type to tab paper.



**To set the paper type to tab paper:**

Set this in [Tray Settings] in the home screen or in "Settings", select [System Settings] → [Common Settings] → [Paper Settings] → [Paper Tray Settings].

**Changing the paper size**

1

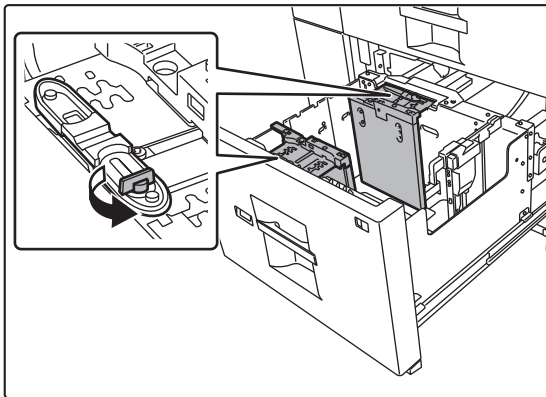

**Loosen the paper guide screw.**

2

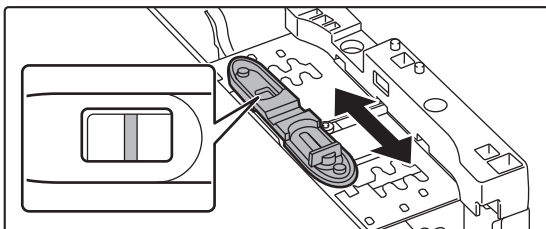

**Slide the plate of the paper guide.**

Slide the plate until the red line appears at the center of the size window of the plate.  
Both near and far plates slides when you slide one of those.



3

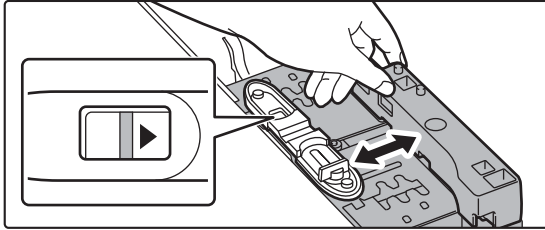

### Adjust the paper guide to the paper size that will be used.

Slide the paper guide forward or backward until the size mark of the paper to be used ( ◀ or ▶ ) appears in the size window of the plate.

Both near and far plates slides when you slide one of those.

4

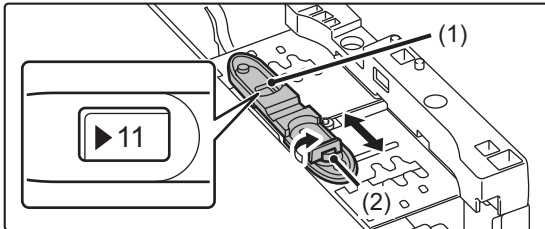

### Secure the paper guide.

#### (1) Slide the plate of the paper guide.

Slide the plate until the paper size to be used appears in the size window of the plate.

Both near and far plates slides when you slide one of those.

#### (2) Tighten the paper guide screw.

Tighten both far and near paper guide screws.

5

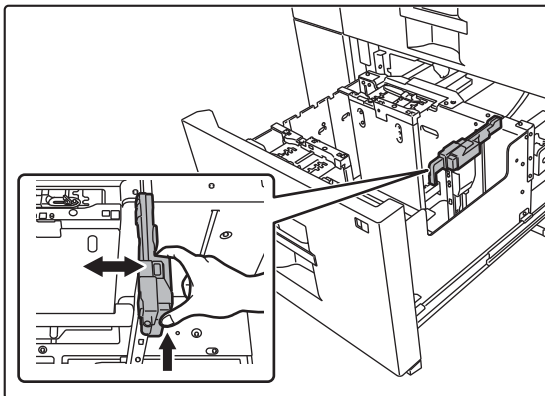

### Change the right paper guide to the paper size to be used.

#### (1) While holding the paper guide lock, slide the paper guide to the paper size to be used.

#### (2) Release the paper guide lock.

#### (3) Move the paper guide slightly to the right and left so that it locks into place.

You will hear a "click" when the paper guide locks.

6

### Set the paper size and paper type.

Be sure to set the paper size and paper type by selecting [Tray Settings] in the home screen or in "Settings", select [System Settings] → [Common Settings] → [Paper Settings] → [Paper Tray Settings].

If the paper size setting is not configured correctly, automatic paper selection will not operate correctly and printing may take place on the wrong size or type of paper or a misfeed may occur.



# LOADING PAPER INTO THE BYPASS TRAY

Use the bypass tray for printing on plain paper, label sheets, tab paper, and other special media.

A maximum of 100 sheets of paper can be loaded into the bypass tray (on the machine), or a maximum of 500 sheets can be loaded in the bypass tray (on the large capacity trays), and continuous printing is possible as is the case with other trays. For detailed information on the sizes and types of paper that can be loaded into the bypass tray, see "[SPECIFICATIONS \(page 8-2\)](#)" in the "Start Guide" and "[Paper Tray Settings \(page 1-110\)](#)".



- When using plain paper other than Sharp standard paper or special media other than SHARP-recommended transparency film, or when printing on the reverse side of paper that has been printed on one side, load paper one sheet at a time. Loading more than one sheet at a time will cause misfeeds.
- Before loading paper, straighten any curling in the paper.
- When adding paper, remove any paper remaining in the bypass tray, combine it with the paper to be added, and reload as a single stack. If paper is added without removing the remaining paper, a misfeed may result.

## How to place the original

Load paper up to 7-1/4" x 10-1/2" (A5) size in landscape orientation.

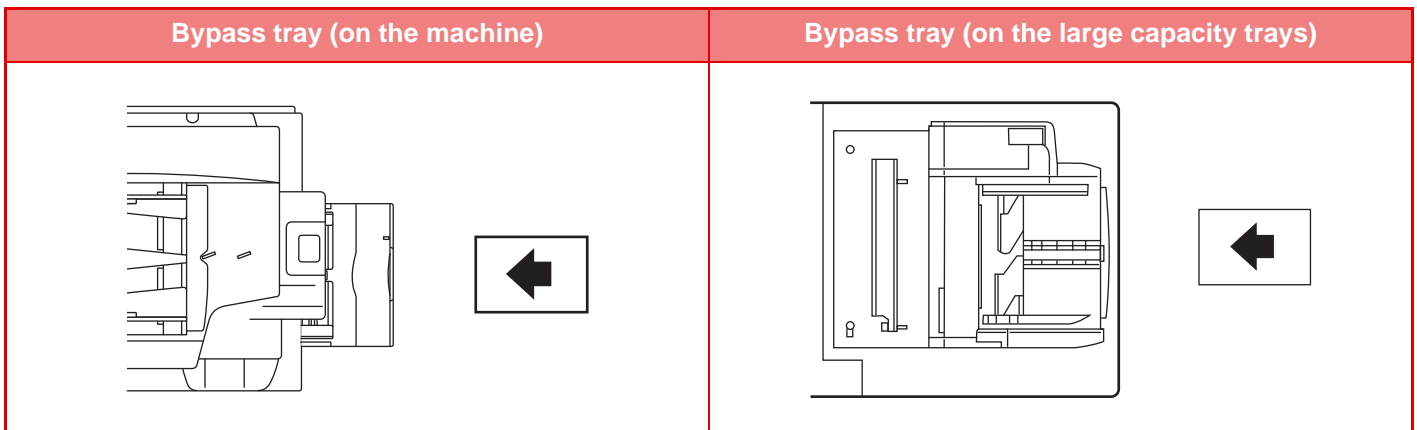



## Loading tab paper

When printing on tab paper, be sure to place the paper with the print side facing up.

For the bypass tray (on the large capacity trays), the dedicated guide must be installed in the bypass tray guides at the rear end. The dedicated guide is in the upper side of the large capacity trays.

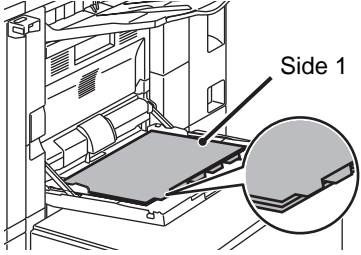
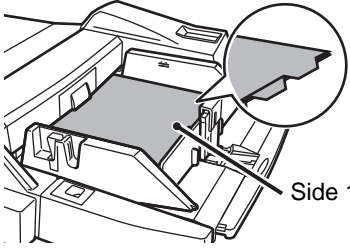
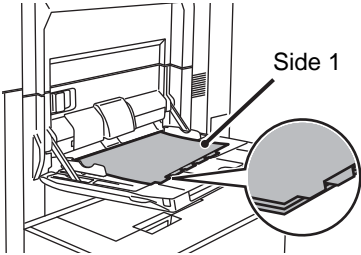
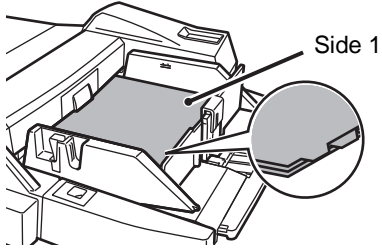
|       | Bypass tray (on the machine)   | Bypass tray (on the large capacity trays)  |
|-------|--|--|
| Left  |  <p>Place the first sheet of tab paper so that the tab faces away from you.</p> |  <p>Place the first sheet of tab paper so that the tab faces away from you.</p> |
| Right |  <p>Place the first sheet of tab paper so that the tab faces toward you.</p>   |  <p>Place the first sheet of tab paper so that the tab faces toward you.</p>   |



- Use only tab paper that is made of paper. Tab paper made of a material other than paper (film, etc.) cannot be used.
- To copy onto the tabs of tab paper, [Tab Copy] in "Others" is useful.

## Inserting transparency film



- Use SHARP-recommended transparency film.
- When loading multiple sheets of transparency film into the bypass tray, fan the sheets several times before loading.
- When printing on transparency film, remove each sheet as it is printed and output from the machine. Allowing sheets to stack in the output tray may result in curling.





## Important points when using label sheets

- Some labels may have to be loaded into the bypass tray in the specified orientation. Follow such instructions. If a form is already printed on the labels, and the print images and the preprinted form do not line up, adjust the application or printer driver settings to rotate the print images.
- Do not use the following types of label sheets.
  - Label sheets without an adhesive copy or label copy
  - Label sheets with adhesive exposed
  - Label sheets with a specified feeding direction that is not supported by the machine
  - A label sheet that has already been fed or has some labels removed
  - Label sheets consisting of multiple sheets
  - Label sheets that do not support laser printing
  - Label sheets that cannot withstand heat
  - Label sheets that have perforations in the backing paper
  - Label sheets with slits in the backing paper
  - Non-standard label sheets
  - Label sheets with adhesive that has deteriorated due to prolonged storage or otherwise
  - Label sheets with cutouts that expose the backing paper
  - Curled or otherwise deformed label sheets
  - Torn or creased label sheets



## Loading paper into the bypass tray (on the machine)

1



Open the bypass tray.



When loading paper larger than 8-1/2" x 11"R or A4R, pull out the extension guide. Pull the bypass tray extension all the way out.

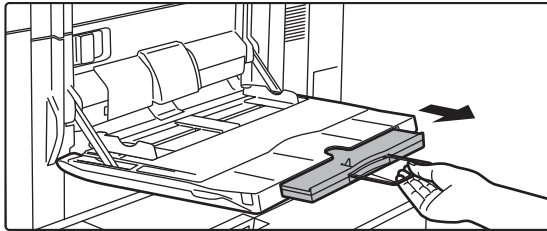

Do not place heavy objects on the bypass tray or press down on the tray.

2

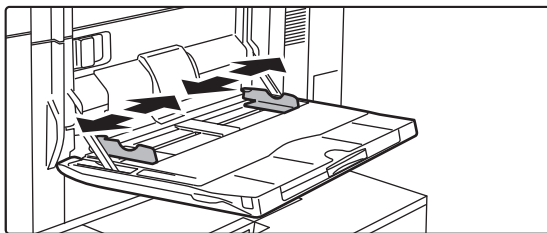

Adjust the bypass tray guides to the size of paper to be loaded.

3

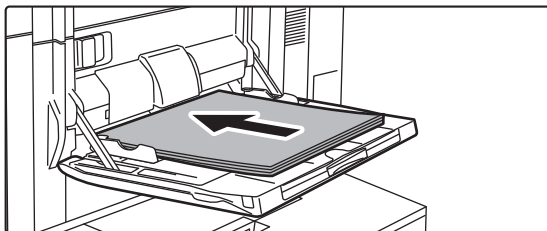

Insert the paper along the bypass tray guides all the way into the bypass tray until it stops.

Load paper with the print side facing up.



- Do not force the paper in.
- If the bypass tray guides are set wider than the paper, move the bypass tray guides in until they correctly fit the width of the paper. If the bypass guides are set too wide, the paper may skew or be creased.



## Loading paper into the bypass tray (on the large capacity trays)

1

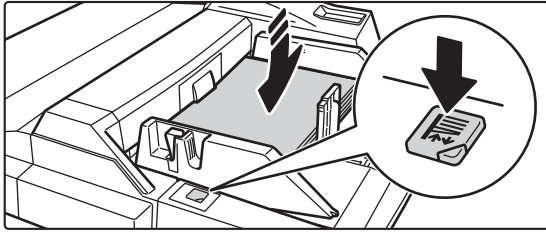

**To replace the paper in the bypass tray, press the operation button and remove the paper.**

The paper table goes down. The operation button blinks while the paper table goes down. The button lights up when the paper table has gone down. Do not remove the paper until the button ceases blinking.

2

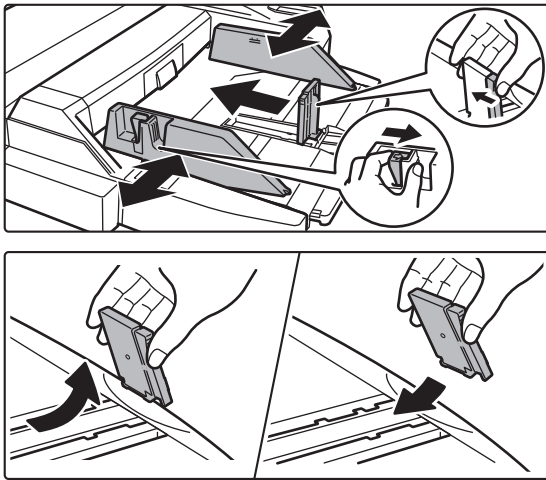

**Adjust the bypass tray guides to the size of paper to be loaded.**

Grasp the guide lock lever to adjust the bypass tray guides to the paper size. Be sure to adjust the bypass tray guides at the rear end.

When loading paper larger than 8-1/2" x 11"R or A4R, be sure to pull out the bypass tray extension. Remove the bypass tray guide at the rear end and attach them to the inserter tray.



- Pull the bypass tray extension all the way out.
- When loading paper larger than 8-1/2" x 14", or A3W, remove the bypass tray guides at the rear end.



Do not place heavy objects on the bypass tray or press down on the tray.

3

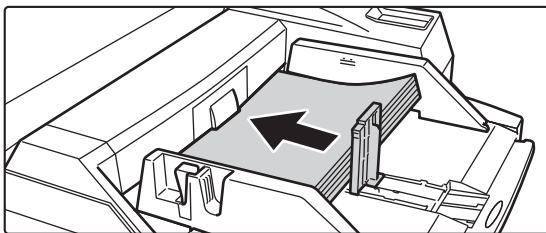

**Insert the paper along the bypass tray guides all the way into the bypass tray until it stops and adjust the right-side guide.**

Load paper with the print side facing up.

The stack must not be higher than the indicator line.

A maximum of 500 sheets of paper can be loaded into the tray.



- Do not force the paper in.
- If the bypass tray guides are set wider than the paper, move the bypass tray guides in until they correctly fit the width of the paper. If the bypass guides are set too wide, the paper may skew or be creased.



4

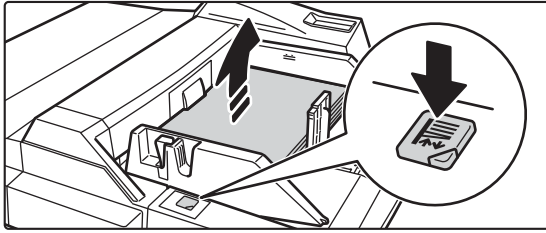

**Press the operation button.**

The paper table goes up. The operation button blinks while the paper table goes up. The button lights up when the paper table has gone up.



# PAPER SETTINGS IN THE SYSTEM SETTINGS

You can configure detailed settings such as the size and type of paper in a tray.

In "Settings (administrator)", select [System Settings] → [Common Settings] → [Paper Settings].

## Paper Settings

### Paper Tray Settings

Paper tray and paper type settings are explained in this section.

These settings specify the paper type, paper size, and functions allowed for each paper tray.

When [Paper Tray Settings] is selected, a list appears showing the trays and the current settings.

#### Auto Switching of Tray

When a tray runs out of paper during printing, this determines whether or not another tray with the same size and type of paper is automatically selected and printing continues.

#### Display Paper Tray Settings when bypass tray detects paper.

You can have the paper tray settings appear automatically when paper is detected in the bypass tray.

#### Settings of each tray

When the [Change] key is tapped, the corresponding setting screen appears.

The following settings can be configured.

| List name            | Description  |
|----------------------|--|
| Type                 | Select a type of paper to be loaded into the tray.<br>The paper types that can be selected vary by paper tray. For more information, see " <a href="#">Tray Settings (page 1-111)</a> ".<br>To user type setup, see " <a href="#">Paper Type Registration (page 1-113)</a> ".  |
| Size                 | Select the paper size from the list. The paper sizes that can be selected vary by tray. The sizes that can be selected may also be restricted by the paper type selected above. For more information, see " <a href="#">Tray Settings (page 1-111)</a> ".<br>If the desired size does not appear in the list, select [Custom Size] and directly enter the size (only for the bypass tray). For more information, see " <a href="#">Tray Settings (page 1-111)</a> ". |
| Feeding Approved Job | Select the modes that can be used. If there is a function that you do not wish to be used with the selected tray, disable the function.  |



- If the paper size specified here is different from the size of paper that is loaded into a tray, a problem or misfeed may occur when printing.
- To change the paper size in a tray, see "[LOADING PAPER \(page 1-85\)](#)".
- Paper properties such as "Fixed Paper Side" are automatically set when the paper type is selected. The paper tray properties cannot be changed in this screen.
- If [System Settings] in "Settings" → [Common Settings] → [Device Control] → [Condition Settings] → [Disabling of Tray Settings], [Disabling of Large Capacity Cassette], [Disabling of Optional Paper Drawer] is selected, the tray settings (except for the bypass tray) cannot be configured.



## Tray Settings

| Paper Tray   | Paper Type  | Size  |
|--|---|---|
| Tray 1   | Plain Paper 1 to 2*1,<br>Recycled, Color, Letter<br>Head, Pre-Printed,<br>Pre-Punched, User Type  | 8-1/2" x 11", A4  |
| Tray 2   | Plain Paper 1 to 2*1,<br>Recycled, Color, Letter<br>Head, Pre-Printed,<br>Pre-Punched, User Type  | 8-1/2" x 11", A4  |
| Tray 3   | Plain Paper 1 to 2*1,<br>Recycled, Color, Letter<br>Head, Pre-Printed,<br>Pre-Punched, Heavy Paper<br>1 to 2*2, User Type   | Auto-Inch (12" x 18", 11" x 17", 8-1/2" x 14", 8-1/2" x 11",<br>8-1/2" x 11"R, 7-1/4" x 10-1/2"R),<br>Auto-AB (A3W, A3, B4, A4, A4R, B5, B5R, 8-1/2" x 13"<br>(216 x 330 mm)),<br>9" x 12" (A4W), 8-1/2" x 13-1/2" (216 x 343 mm), 8-1/2" x 13-2/5"<br>(216 x 340 mm)), 8K, 16K, 16KR   |
| Tray 4   | Plain Paper 1 to 2*1,<br>Recycled, Color, Letter<br>Head, Pre-Printed,<br>Pre-Punched, Heavy Paper<br>1 to 2*2, Tab Paper,<br>Transparencies, Labels,<br>User Type                              | Auto-Inch (12" x 18", 11" x 17", 8-1/2" x 14", 8-1/2" x 11",<br>8-1/2" x 11"R, 7-1/4" x 10-1/2"R, 5-1/2" x 8-1/2"R),<br>Auto-AB (A3W, A3, B4, A4, A4R, B5, B5R, A5R, 8-1/2" x 13"<br>(216 x 330 mm)),<br>9" x 12" (A4W), 8-1/2" x 13-1/2" (216 x 343 mm), 8-1/2" x 13-2/5"<br>(216 x 340 mm)), 8K, 16K, 16KR, custom size   |
| Tray 5 (when a large<br>capacity tray (MX-LC12)<br>is installed) | Plain Paper 1 to 2*1,<br>Recycled, Color, Letter<br>Head, Pre-Printed,<br>Pre-Punched, Heavy Paper<br>1 to 2*2, User Type   | 8-1/2" x 11", A4, B5  |
| Tray 5/7 (when a large<br>capacity trays are<br>installed)       | Plain Paper 1 to 2*1,<br>Recycled, Color, Letter<br>Head, Pre-Printed,<br>Pre-Punched, Thin Paper,<br>Heavy Paper 1 to 4*2,<br>Tab Paper, Transparencies,<br>Labels, Glossy Paper, User<br>Type | Auto-Inch (12" x 18", 9" x 12", 11" x 17", 8-1/2" x 14",<br>8-1/2" x 13-1/2" (216 x 343 mm), 8-1/2" x 13-2/5"<br>(216 x 340 mm), 8-1/2" x 11", 8-1/2" x 11"R, 7-1/4" x 10-1/2"R,<br>SRA3, A3W, A3, B4, SRA4, A4W, A4, B5),<br>Auto-AB (SRA3, A3W, A3, B4, SRA4, A4W, A4, A4R, B5, B5R,<br>12" x 18", 11" x 17", 8-1/2" x 13-1/2" (216 x 343 mm),<br>8-1/2" x 13-2/5" (216 x 340 mm), 8-1/2" x 13" (216 x 330 mm),<br>8-1/2" x 11"), 234 x 318, 220 x 312, 318 x 469, 312 x 440, 8K, 16K,<br>16KR, custom size |
| Tray 6/8 (when a large<br>capacity trays are<br>installed)       | Plain Paper 1 to 2*1,<br>Recycled, Color, Letter<br>Head, Pre-Printed,<br>Pre-Punched, Thin Paper,<br>Heavy Paper 1 to 4*2,<br>Tab Paper, Transparencies,<br>Labels, Glossy Paper, User<br>Type | Auto-Inch (12" x 18", 9" x 12", 11" x 17", 8-1/2" x 14",<br>8-1/2" x 13-1/2" (216 x 343 mm), 8-1/2" x 13-2/5"<br>(216 x 340 mm), 8-1/2" x 11", 8-1/2" x 11"R, 7-1/4" x 10-1/2"R,<br>SRA3, A3W, A3, B4, SRA4, A4W, A4, B5),<br>Auto-AB (SRA3, A3W, A3, B4, SRA4, A4W, A4, A4R, B5, B5R,<br>12" x 18", 11" x 17", 8-1/2" x 13-1/2" (216 x 343 mm),<br>8-1/2" x 13-2/5" (216 x 340 mm), 8-1/2" x 13" (216 x 330 mm),<br>8-1/2" x 11"), 234 x 318, 220 x 312, 318 x 469, 312 x 440, 8K, 16K,<br>16KR, custom size |



## BEFORE USING THE MACHINE ► LOADING PAPER

| Paper Tray                                   | Paper Type  | Size   |
|--|---|--|
| Bypass tray<br>(on the machine)              | Plain Paper 1 to 2*1,<br>Recycled, Color, Letter<br>Head, Pre-Printed,<br>Pre-Punched, Thin Paper,<br>Heavy Paper 1 to 4*2, Tab<br>Paper, Transparencies,<br>Labels, Glossy Paper, User<br>Type | Auto-Inch (12" x 18", 11" x 17", 8-1/2" x 14",<br>8-1/2" x 13-1/2" (216 x 343 mm), 8-1/2" x 13-2/5"<br>(216 x 340 mm), 8-1/2" x 11", 8-1/2" x 11"R, 7-1/4" x 10-1/2"R,<br>5-1/2" x 8-1/2"R, A3, B4, A4, B5),<br>Auto-AB (A3W, A3, B4, A4, A4R, B5, B5R, A5R,<br>11" x 17", 8-1/2" x 13-1/2" (216 x 343 mm),<br>8-1/2" x 13-2/5" (216 x 340 mm), 8-1/2" x 13" (216 x 330 mm),<br>8-1/2" x 11"),<br>9" x 12" (A4W), 8K, 16K, 16KR, custom size   |
| Bypass tray (on the<br>large capacity trays) | Plain Paper 1 to 2*1,<br>Recycled, Color, Letter<br>Head, Pre-Printed,<br>Pre-Punched, Thin Paper,<br>Heavy Paper 1 to 2*2, Tab<br>Paper, Transparencies, User<br>Type                          | Auto-Inch (12" x 18", 11" x 17", 9" x 12", 8-1/2" x 14",<br>8-1/2" x 13-1/2" (216 x 343 mm), 8-1/2" x 13-2/5"<br>(216 x 340 mm), 8-1/2" x 11", 8-1/2" x 11"R,<br>7-1/4" x 10-1/2"R, 5-1/2" x 8-1/2"R, A3, B4, A4),<br>Auto-AB (A3W, A3, B4, A4W, A4, A4R, B5, B5R, A5R,<br>11" x 17", 8-1/2" x 13-1/2" (216 x 343 mm),<br>8-1/2" x 13-2/5" (216 x 340 mm), 8-1/2" x 13" (216 x 330 mm),<br>8-1/2" x 11"), 234 x 318, 220 x 312, 318 x 469, 312 x 440, SRA3,<br>SRA4, 8K, 16K, 16KR, custom size          |
| Insertor (Upper tray)                        | Plain Paper 1 to 2*1,<br>Recycled, Color, Letter<br>Head, Pre-Printed,<br>Pre-Punched, Heavy Paper<br>1 to 2*2, User Type   | Auto-Inch (12" x 18", 9" x 12", 11" x 17", 8-1/2" x 14",<br>8-1/2" x 13-1/2" (216 x 343 mm), 8-1/2" x 13-2/5"<br>(216 x 340 mm), 8-1/2" x 11", 8-1/2" x 11"R, 7-1/4" x 10-1/2"R,<br>5-1/2" x 8-1/2"R, A3, B4, A4W, A4),<br>Auto-AB (A3W, A3, B4, A4W, A4, A4R, B5, B5R, A5R,<br>11" x 17", 8-1/2" x 13-1/2" (216 x 343 mm), 8-1/2" x 13-2/5"<br>(216 x 340 mm), 8-1/2" x 13" (216 x 330 mm),<br>8-1/2" x 11"), SRA3, SRA4, A5, 234 x 318, 220 x 312, 318 x 469,<br>312 x 440, 8K, 16K, 16KR, custom size |
| Insertor (Lower tray)                        | Plain Paper 1 to 2*1,<br>Recycled, Color, Letter<br>Head, Pre-Printed,<br>Pre-Punched, Heavy Paper<br>1 to 2*2, User Type   | Auto-Inch (12" x 18", 9" x 12", 11" x 17", 8-1/2" x 14",<br>8-1/2" x 13-1/2" (216 x 343 mm), 8-1/2" x 13-2/5"<br>(216 x 340 mm), 8-1/2" x 11", 8-1/2" x 11"R, 7-1/4" x 10-1/2"R,<br>5-1/2" x 8-1/2"R, A3, B4, A4W, A4),<br>Auto-AB (A3W, A3, B4, A4W, A4, A4R, B5, B5R, A5R,<br>11" x 17", 8-1/2" x 13-1/2" (216 x 343 mm),<br>8-1/2" x 13-2/5" (216 x 340 mm), 8-1/2" x 13" (216 x 330 mm),<br>8-1/2" x 11"), SRA3, SRA4, A5, 234 x 318, 220 x 312, 318 x 469,<br>312 x 440, 8K, 16K, 16KR, custom size |

\*1 Plain Paper 1: 16 to 24 lbs bond (60 to 89g/m<sup>2</sup>)  
Plain Paper 2: 24 to 28 lbs bond (90 to 105g/m<sup>2</sup>)

\*2 Heavy paper 1: 28 lbs bond to 65 lbs cover (106 g/m<sup>2</sup> to 176 g/m<sup>2</sup>)  
Heavy paper 2: 65 lbs cover to 80 lbs cover (177 g/m<sup>2</sup> to 220 g/m<sup>2</sup>)  
Heavy paper 3: 80 lbs cover to 140 lbs index (221 g/m<sup>2</sup> to 256 g/m<sup>2</sup>)  
Heavy paper 4: 140 lbs index to 110 lbs cover (257 g/m<sup>2</sup> to 300 g/m<sup>2</sup>)



## Select Paper Sizes for Auto Detection

"Select Paper Sizes for Auto Detection" in the bypass tray settings screen is used to select the paper size that is automatically detected from similar sizes when the automatic paper size detection takes place.

Select one of two sizes when "Auto-Inch" is set. Select one of five sizes when "Auto-AB" is set.

When paper that is the same size as one of the paper sizes in the settings is placed in the bypass tray, the size that is selected in the settings will be automatically detected.

| List name | Description   |
|-----------|---|
| Auto-Inch | 8-1/2" x 14", 8-1/2" x 13-2/5" (216 mm x 340 mm), 8-1/2" x 13-1/2" (216 mm x 343 mm)                            |
| Auto-AB   | 8-1/2" x 13" (216 mm x 330 mm), 8-1/2" x 13-2/5" (216 mm x 340 mm), 8-1/2" x 13-1/2" (216 mm x 343 mm), A4R, A5 |

## Custom Size Registration (Bypass)

If you frequently use a non-standard size paper in the bypass tray, register that paper size in advance.

Registering the paper size saves you the trouble of setting the size each time you need to use it.

Up to Seven paper sizes can be registered.

Tap the key ([Custom 1] to [Custom 7]) in which you wish to register or change a paper size, and the registration screen appears.

Select whether you wish to enter the size in mm ("Size Input-AB") or inches ("Size Input-Inch"), and then set the X and Y dimensions of the paper.

### "Size Input-AB"

The X direction can be set between 140mm and 470mm. The factory default setting is 420mm.

The Y direction can be set between 100mm and 320mm. The factory default setting is 297mm.

### "Size Input-Inch"

The X direction can be set between 5-1/2" and 18-1/2". The factory default setting is 17".

The Y direction can be set between 4" and 12-1/2". The factory default setting is 11".

## Paper Type Registration

Store a paper type when the desired paper type does not appear as a selection or when you wish to create a new set of paper properties.

Up to 7 paper types can be registered.

| List name        | Description  |
|------------------|--|
| Type Name        | Register any name.<br>The factory default names are "User Type 1" to "User Type 11". |
| Fixed Paper Side | Use this setting when paper with a front and reverse side is used.                   |
| Disable Duplex   | Use this setting when paper loaded cannot be used for 2-sided printing.              |
| Disable Staple   | Use this setting when paper used cannot be stapled.                                  |
| Disable Punch    | Use this setting when paper used cannot be punched.                                  |



The settings that can be selected vary depending on the peripheral devices installed.





# HOW TO PLACE THE ORIGINAL

## SELECTING A PROCEDURE FOR PLACING THE ORIGINAL DEPENDING ON THE TYPE AND STATUS OF THE ORIGINAL

Place the original in the automatic document feeder. Depending the type and status of the original, use the document glass. Follow the instructions to select the method for placing the original.

To place it in the automatic document feeder, see "[AUTOMATIC DOCUMENT FEEDER \(page 1-116\)](#)".

### Detectable original sizes

In "Settings (administrator)", select [System Settings] → [Common Settings] → [Device Control] → [Condition Settings] → [Original Size Detector Setting].

### Original Size Detector Setting

One of the 8 groups of standard original sizes shown below can be selected for detection by the original size detection function.

| Selections | Detectable original sizes   |   |
|------------|---|---|
|            | Document glass  | Document feeder tray (automatic document feeder)  |
| AB-1       | A3, A4, A4R, A5, B4, B5, B5R  | 11" x 17", 8-1/2" x 14", 8-1/2" x 11", A3, A4, A4R, A5, A5R, B4, B5, B5R  |
| AB-2       | A3, A4, A4R, A5, B5, B5R, 216 mm x 330 mm (8-1/2" x 13")                                    | A3, A4, A4R, A5, A5R, B4, B5, B5R, 11"x17", 8-1/2"x11", 216 mm x 330 mm (8-1/2"x13")                                    |
| AB-3       | A3, A4, A4R, A5, B4, 8K, 16K, 16KR  | A3, A4, A4R, A5, A5R, B4, B5, B5R, 11"x17", 8-1/2"x11", 216 mm x 330 mm (8-1/2"x13"), 8K, 16K, 16KR                     |
| AB-4       | 216 mm x 340 mm (8-1/2" x 13-2/5"), A3, A4, A4R, A5, B5, B5R                                | A3, A4, A4R, A5, A5R, B4, B5, B5R, 11"x17", 8-1/2"x11", 216 mm x 340 mm (8-1/2"x13-2/5")                                |
| AB-5       | 216 mm x 343 mm (8-1/2" x 13-1/2"), A3, A4, A4R, A5, B5, B5R                                | A3, A4, A4R, A5, A5R, B4, B5, B5R, 11"x17", 8-1/2"x11", 216 mm x 343 mm (8-1/2"x13-1/2")                                |
| Inch-1     | 11" x 17", 8-1/2" x 14", 8-1/2" x 11", 8-1/2" x 11"R, 5-1/2" x 8-1/2"                       | 11" x 17", 8-1/2" x 14", 8-1/2" x 11", 8-1/2" x 11"R, 5-1/2" x 8-1/2", 5-1/2" x 8-1/2"R, A3, A4, B4, B5, B5R            |
| Inch-2     | 11" x 17", 216 mm x 330 mm (8-1/2" x 13"), 8-1/2" x 11", 8-1/2" x 11"R, 5-1/2" x 8-1/2"     | 11"x17", 216 mm x 330 mm (8-1/2"x13"), 8-1/2"x11", 8-1/2"x11"R, 5-1/2"x8-1/2", 5-1/2" x 8-1/2"R, A3, A4, B4, B5, B5R    |
| Inch-3     | 11" x 17", 8-1/2" x 13-2/5" (216 mm x 340 mm), 8-1/2" x 11", 8-1/2" x 11"R, 5-1/2" x 8-1/2" | 11"x17", 8-1/2"x13-2/5 (216 mm x 340 mm), 8-1/2"x11", 8-1/2"x11"R, 5-1/2"x8-1/2", 5-1/2" x 8-1/2"R, A3, A4, B4, B5, B5R |

### Cancel Detection at Document Glass

Original size detection on the document glass can be disabled. When this is done, all originals placed on the document glass are treated as special size originals.



## Original Feeding Mode

The following original feeding modes can be set to operate by default in copy, image send, and scan to local drive. When a mode is frequently used, this saves you from having to select the mode in another mode each time you need to use it.

- Mixed Size Doc. Different Width
- Slow Scan Mode
- Blank Page Skip\*



---

### Initial Original Count Setting

Specifies whether or not "Original Count" in Others is enabled for each function.

In "Settings (administrator)", select [System Settings] → [Common Settings] → [Operation Settings] → [Condition Settings] → [Initial Original Count Setting].

The following settings can be configured.

Copy

- Copy

Image Send

- Scan to

- Data Entry

Document Filing

- Scan to Local Drive
-



# AUTOMATIC DOCUMENT FEEDER

This section explains how to place originals in the automatic document feeder.



- Place originals of different sizes together, if needed, in the automatic document feeder. In that case, use the "Others" function in each mode to set [Mixed Size Original]. An original cannot be detected if all pages are of the same size but some of them are set in a different orientation.

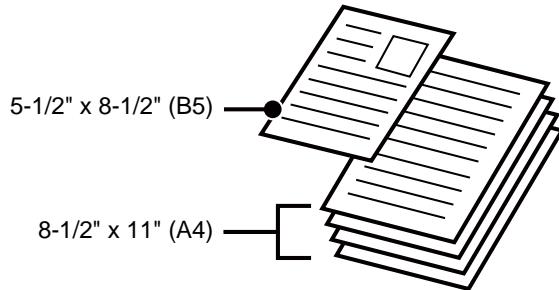

- Before inserting originals into the document feeder tray, be sure to remove any staples or paper clips.
- If originals have damp spots due to correction fluid, ink or paste up glue, wait until the originals are dry before making copies. Otherwise the interior of the machine or the document glass may be soiled.
- Do not use the following originals. Incorrect original size detection, original misfeeds, and smudges may result. Transparency film or other transparent material for backup copy, tracing paper, carbon paper, thermal paper or originals printed with thermal transfer ink ribbon should not be fed through the document feeder. Originals to be fed through the feeder should not be damaged, crumpled, folded, loosely pasted together, or have cut-out holes. Originals with multiple punched holes other than two-hole or three-hole punched paper may not feed correctly.
- The condition, material, shape, or fabrication method of some business cards may prevent correct feeding or scanning.
- When using originals with two or three holes, place them so that the punched edge is at a position away from the feed slot of the document feeder tray. Specify the orientation of the original using [Original].

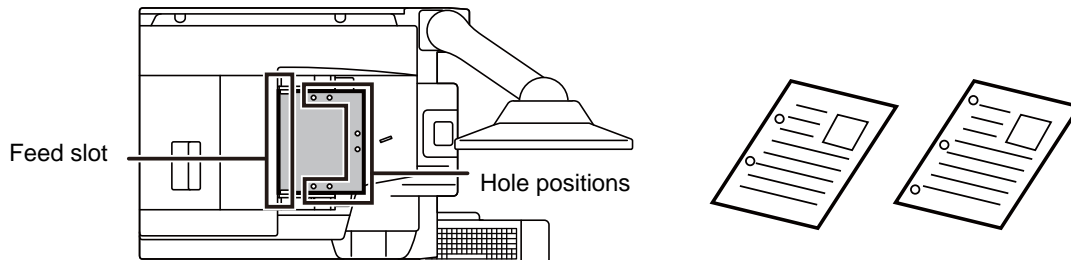

- When the document rolls in the original exit tray on the automatic document feeder, fix the paper fixing arm at the center to the top.

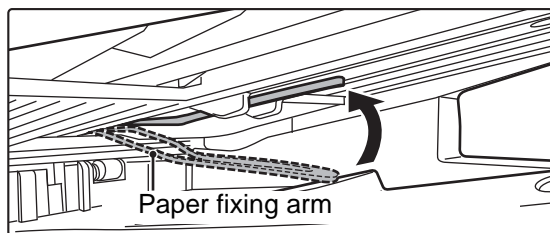



## Allowed original sizes

| Minimum original size  | Maximum original size  |
|--|--|
| <p><b>Standard size</b><br/>(Minimum size that can be automatically detected)<br/>5-1/2" (longitudinal) × 8-1/2" (transversal)<br/>148 mm (longitudinal) × 210 mm (transversal), or A5</p> <p><b>Non-standard size</b><br/>(Minimum size that can be specified manually)<br/>5-1/8" (longitudinal) × 5-1/2" (transversal)<br/>131 mm (longitudinal) × 140 mm (transversal)</p> <p><b>Business card:</b><br/>51 mm x 89 mm to 55 mm x 91 mm</p> | <p><b>Standard size</b><br/>(Maximum size that can be automatically detected)<br/>11" (longitudinal) × 17" (transversal)<br/>297 mm (longitudinal) × 420 mm (transversal) or A3<br/>12" × 18" (A3W) cannot be used.</p> <p><b>Non-standard size</b><br/>(Maximum size that can be specified manually)<br/>Copy mode:<br/>11-5/8" (longitudinal) × 17" (transversal)<br/>297 mm (longitudinal) × 432 mm (transversal)<br/>image send mode:<br/>11" (longitudinal) × 39-3/8" (transversal)<br/>297 mm (longitudinal) × 1000 mm (transversal)</p> |

When the original is a non-standard size, see the appropriate explanation below for the mode you are using.

- COPIER: "[SELECTING THE ORIENTATION AND SIZE OF THE ORIGINAL \(page 2-29\)](#)"
- IMAGE SEND: "[SPECIFYING THE ORIGINAL SCAN SIZE USING NUMERIC VALUES \(page 4-42\)](#)"

## Allowed original weights

1-Sided scanning: 9 lbs. bond to 120 lbs. index (35 g/m<sup>2</sup> to 220 g/m<sup>2</sup>)

2-Sided scanning: 13 lbs. bond to 120 lbs. index (50 g/m<sup>2</sup> to 220 g/m<sup>2</sup>)

To scan originals from 9 to 13- lbs Bond (35 to 49g/m<sup>2</sup>), use "Slow Scan Mode" in the "Others" function. Scanning without using "Slow Scan Mode" may result in original misfeeds.

When "Slow Scan Mode" is selected, automatic 2-sided scanning is not possible.

To scan originals from 40 lbs. bond to 120 lbs. index (158 g/m<sup>2</sup> to 220 g/m<sup>2</sup>), use "Heavy Paper Scan" in the "Others" function. Scanning without using "Heavy Paper Scan" may result in original misfeeds.

## Double Feed Detection

This automatic document feeder is equipped with a double feed detection function.

If you attempt to scan multiple originals at the same time, scanning stops as a document jam.

Set in [System Settings] → [Common Settings] → [Device Control] → [Condition Settings] → [Multifeed Detection Settings] in "Settings (Administrator)".

## Preventing skew feed

This automatic document feeder is equipped with an anti-skew feed.

When a document is scanned at an angle, scanning stops as a document jam.

## Original size detection

If the operation panel is placed over the automatic document feeder, original size of the document feeder tray (automatic document feeder) may not be recognized correctly.



1

**Make sure that there is no original on the document glass.**

2

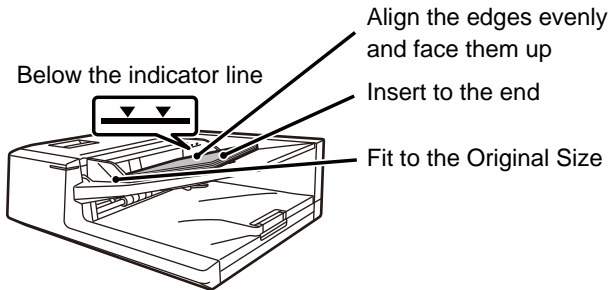

### Place the original.

Up to 300 sheets can be inserted.

After scanning is finished on the automatic document feeder, remove originals from the original exit tray.

The original setting indicator lights when originals are placed on the document feeder tray.

## Original setting indicator

The original setting indicator lights when the document is correctly loaded on the document feeder tray.

If the original setting indicator is lit, it is possible for a user who has difficulty in confirming that a document is loaded on the document feeder tray to confirm that the document is loaded.

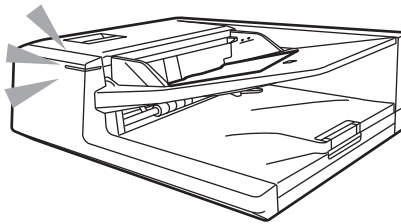

### Original setting indicator ON/OFF settings

In "Settings (administrator)", select [System Settings] → [Common Settings] → [Device Control] → [Status Indicator Setting] → [Use Original Detection Light for Document Feeder].



# PREVENTIVE LIGHT TO INDICATE ORIGINAL LEFT BEHIND

In order to prevent originals being left behind, the automatic document feeder incorporates a lamp on the top of the original exit tray.

This lamp detects a document on the automatic document feeder, and starts blinking after the last original is output from the original exit tray.

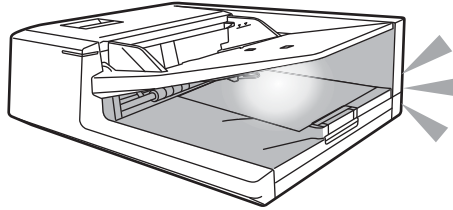

## Light turning off

The preventive light to indicate original left behind will turn off in the event of the following.

- When the scanned original is removed
- After the preventive light to indicate original left behind blinks three times, repeated three times
- When a new original is placed in the automatic document feeder, and a job started
- When the machine enters sleep mode
- When use of the automatic document feeder is prohibited



- When the preventive light to indicate original left behind is blinking, placing the original on the document glass will not turn off the preventive light to indicate original left behind.
- The preventive light to indicate original left behind will not turn off by only placing an original on the automatic document feeder.
- The preventive light to indicate original left behind will not turn off even if the operation panel is off.
- If the preventive light to indicate original left behind turns off, this will not flash even if an original is left on the automatic document feeder.



### Preventive light to indicate original left behind ON/OFF settings

In "Settings (administrator)", select [System Settings] → [Common Settings] → [Device Control] → [Status Indicator Setting] → [Use Preventive Light to Indicate Original Left Behind].



# DOCUMENT GLASS

This section describes the steps for setting the original on the document glass.



- Close the automatic document feeder slowly. Abruptly closing the automatic document feeder may damage it.
- Take care that your fingers are not pinched when closing the automatic document feeder.

## Allowed original sizes

### Maximum original size

#### Standard size

11" (longitudinal) x 17" (transversal)  
 297 mm (longitudinal) x 420 mm (transversal) or A3

#### Non-standard size

11-5/8" (longitudinal) x 17" (transversal)  
 297 mm (longitudinal) x 432 mm (transversal)

When the original is a non-standard size, see the appropriate explanation below for the mode you are using.

- COPIER: "[SELECTING THE ORIENTATION AND SIZE OF THE ORIGINAL \(page 2-29\)](#)"
- IMAGE SEND: "[SPECIFYING THE ORIGINAL SCAN SIZE USING NUMERIC VALUES \(page 4-42\)](#)"

**1**

Open the automatic document feeder.

**2**

Load the paper with the print side facing down.

Place the original face down and align the top left corner of the original with back left (at the tip of the mark ) of the document glass.

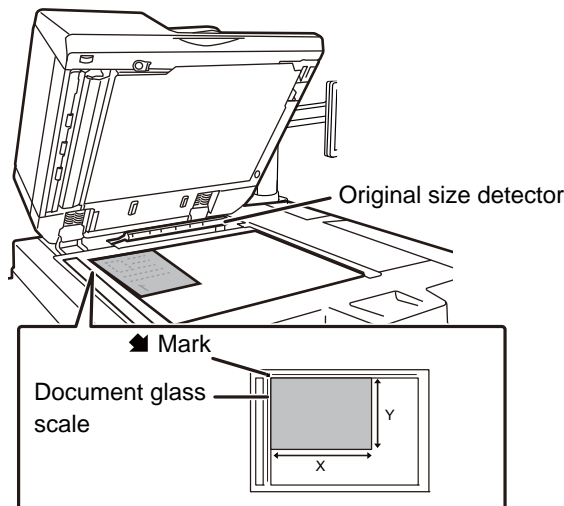

Do not place any objects under the original size detector.  
 Closing the automatic document feeder with an object underneath may damage the original size detector or disable correct detection of the original size.



When placing a non-standard size original on the document glass, the size can be detected easily if a blank sheet of 8-1/2" x 11" (A4), 5-1/2" x 8-1/2" (B5), or other standard size paper is placed on top of the original.



3

### Close the automatic document feeder.

After placing the original, close the automatic document feeder. If the unit is left open, parts outside of the original will be copied in black, causing excessive use of toner.



- When closing, open the automatic document feeder all the way and then close it.
- If originals have damp spots due to correction fluid, ink or paste up glue, wait until the originals are dry before making copies. Otherwise the interior of the machine or the document glass may be soiled.





# PERIPHERAL DEVICES

## PERIPHERAL DEVICES

Peripheral devices can be installed on the machine to increase its range of functionality.

The peripheral devices are generally optional. However, some models include certain peripheral devices as standard equipment.

(As of December, 2020)

| Product name                           | Product number | Description   |
|--|----------------|---|
| Large capacity tray                    | MX-LC12        | Additional tray. A maximum of 3500 sheets of paper can be placed.   |
| Large capacity trays                   | MX-LC13 N      | Additional tray. A maximum of 5000 sheets of paper can be placed.   |
| Multi bypass tray                      | MX-MFX1        | Additional tray. A maximum of 100 sheets of paper can be placed. Install this tray in the machine.  |
|  | MX-MF11        | Additional tray. A maximum of 500 sheets of paper can be placed. Install this tray on the large capacity trays.   |
| Finisher (large stacker)               | MX-FN21        | Output device that enables the use of the staple function and offset function. A maximum of 100 sheets of paper can be stapled.                                   |
| Saddle stitch finisher (large stacker) | MX-FN22        | Output device that enables use of the staple function, offset function and pamphlet copy function. A maximum of 100 sheets of paper can be stapled.               |
| Punch module                           | MX-PN13B       | This unit punches holes in copies and other output. A finisher (MX-FN21) or saddle stitch finisher (MX-FN22) is required.   |
| Trimming module                        | MX-TM10        | This unit trims the excess portions of saddle-stitched sheets. A saddle stitch finisher (MX-FN22) is required.  |
| Folding unit                           | MX-FD10        | This unit folds and outputs paper. A finisher (MX-FN21) or saddle stitch finisher (MX-FN22) is required.  |
| Inserter                               | MX-CF11        | This unit inserts covers and insertion sheets. This unit can also feed paper to a finisher (MX-FN21) or saddle stitch finisher (MX-FN22) for finishing.           |
| Curl correction unit                   | MX-RB18        | This unit corrects curls in printed paper. This unit is required for installing a finisher (MX-FN21), saddle stitch finisher (MX-FN22), folding unit or inserter. |
| Relay unit                             | MX-RB13        | This unit is required for directly installing a finisher (MX-FN21) or saddle stitch finisher (MX-FN22) and inserter.  |
| Barcode Font Kit                       | MX-PF10        | Adds barcode fonts to the machine.  |
| Application Integration Module         | MX-AMX1        | The application integration module can be combined with the network scanner function to append a metadata file to a scanned image file.                           |
| Stamp unit                             | AR-SU1         | This stamps each original page after it is scanned in image send mode.  |



| Product name     | Product number | Description  |
|------------------|----------------|--|
| Stamp cartridge  | AR-SV1         | Two Verification Stamp cartridges are included.                                      |
| Staple cartridge | MX-SCX2        | Staples paper. A finisher (MX-FN21) or saddle stitch finisher (MX-FN22) is required. |
|                  | MX-SCX1        | Saddle stitches paper. A saddle stitch finisher (MX-FN22) is required.               |
| Status indicator | MX-SL10 N      | The status of the machine is indicated.  |



# FINISHER (LARGE STACKER)

This includes the offset function that outputs sorted paper while staggering each set of paper and the staple sort function that staples each set of prints.

Installing an optional hole punch module allows you to punch holes in printed paper.

## PART NAMES

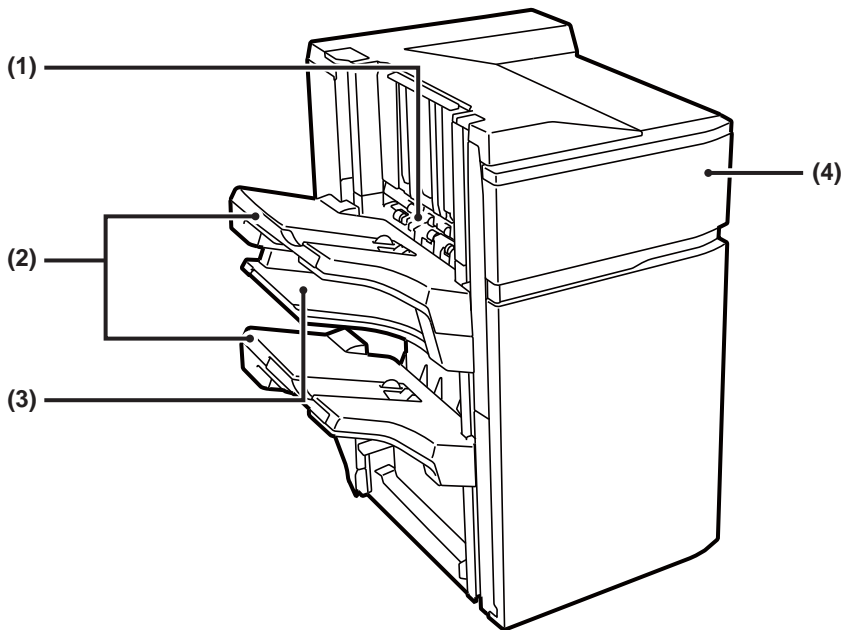

**(1) Staple compiler**

This temporarily stacks paper to be stapled.

**(2) Output tray**

Stapled and offset output is delivered to this tray. The tray is slidable. Extend the tray for printing on large-size paper (larger than 8-1/2" x 11" (A4)).

**(3) Middle output tray**

Output paper that will not be offset in this tray. The tray is slidable. Extend the tray for printing on large-size paper (larger than 8-1/2" x 11" (A4)).

**(4) Front cover**

Open this cover to replace the staple cartridge or remove a staple jam.



- Do not place heavy objects or press down on the finisher (Large stacker).
- Exercise caution when you turn on the power and when printing is taking place, as the tray may move up and down.
- A finisher (Large stacker) cannot be installed simultaneously with a saddle stitch finisher (Large stacker).



## SUPPLIES

The finisher (Large stacker) requires the following staple cartridge:  
Staple cartridge (approx. 5000 staples per cartridge × three cartridges)  
MX-SCX2

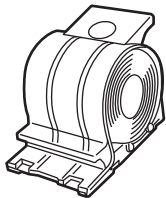

## REPLACING THE STAPLE CARTRIDGE

When the staple cartridge runs out of staples, a message will appear in the operation panel. Follow the operation procedure to replace the staple cartridge.

1

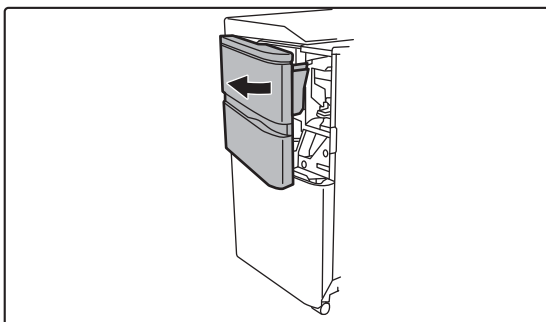

Open the front cover.

2

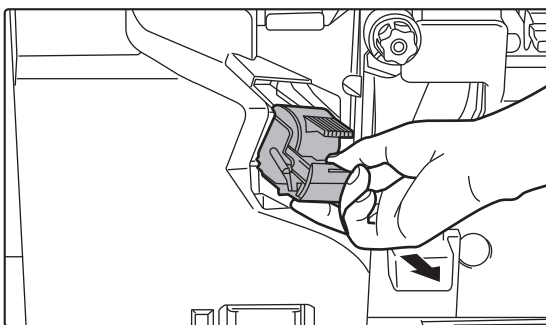

Squeeze the green parts of the staple case and pull the case up and then out.



3

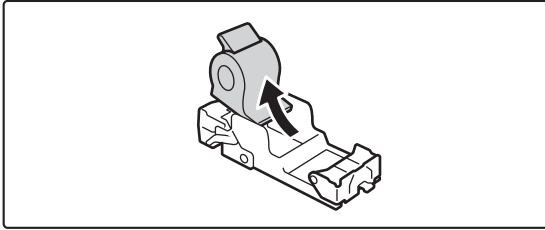

**Remove the empty staple cartridge.**



When staples remain, the staple cartridge cannot be removed.

4

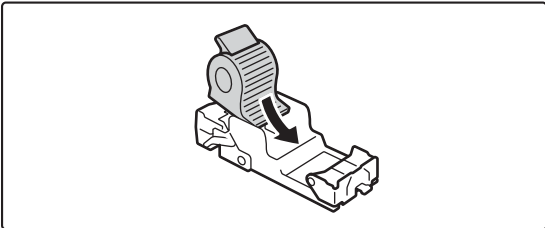

**Insert a new staple cartridge into the staple case.**

Push the staple case in until it clicks into place.

5

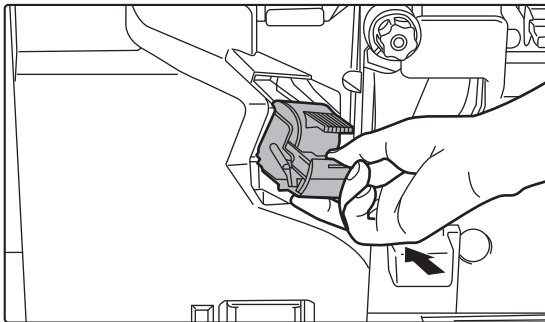

**Install a staple case.**

Push the staple case in until it clicks into place.

6

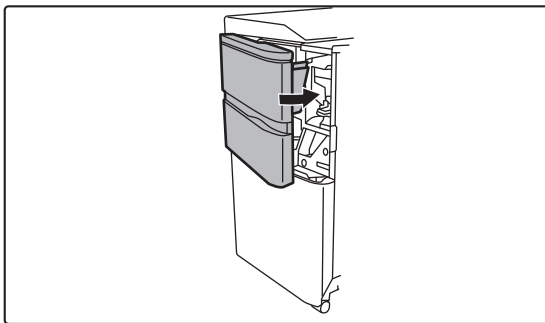

**Close the front cover.**



Make a proof copy in staple sort function to verify that stapling takes place correctly.



## DISCARDING STAPLE WASTE

When a finisher is used for stapling, staple waste is produced. The staple waste is collected in the staple waste box. Follow the steps below to discard staple waste.

1

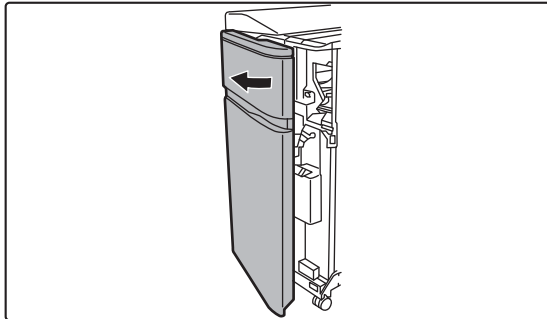

Open the front cover.

2

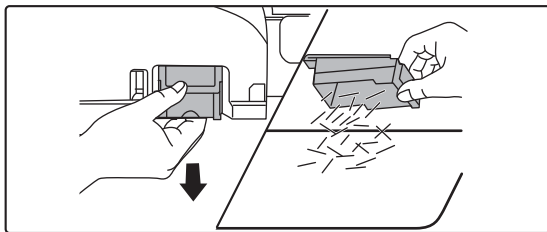

Grasp the tab of the staple waste box, gently pull out the box, and discard the staple waste.



- Do not put your fingers into the staple waste box. The staples may prick and injure your fingers.
- Do not discard the staple waste in a plastic bag. The staples may create holes in the bag.

3

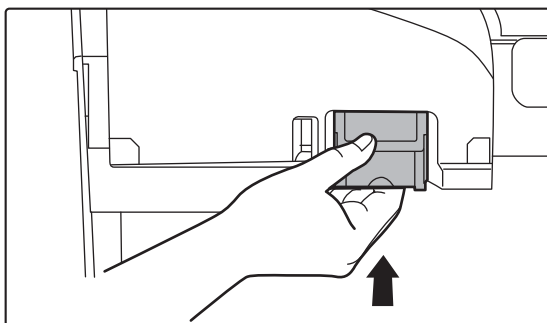

Replace the staple waste box.

Make sure that the staple waste box is replaced correctly.



4

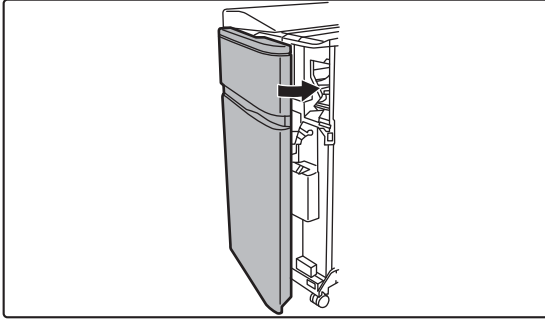

**Close the front cover.**



# SADDLE STITCH FINISHER (LARGE STACKER)

This includes the offset function that outputs sorted sheets of paper while staggering each set of paper, the staple sort function that staples each set of prints, the saddle stitch function that staples the center of the sheets and folds the sheets in half, and the paper folding function that folds paper in half. Installing an optional hole punch module allows you to punch holes in printed paper.

## PART NAMES

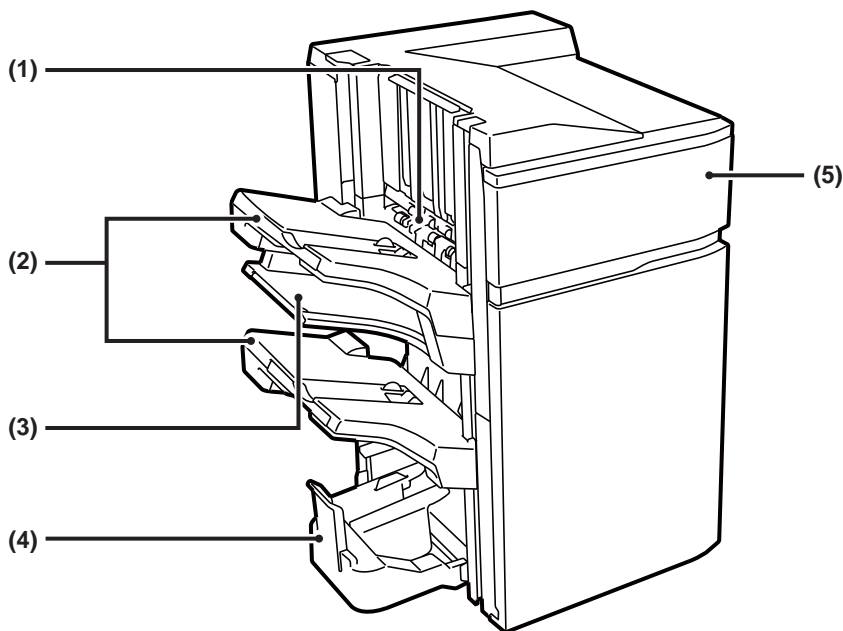

**(1) Staple compiler**

This temporarily stacks paper to be stapled.

**(2) Output tray**

Stapled and offset output is delivered to this tray. The tray is slidable. Extend the tray for printing on large-size paper (larger than 8-1/2" x 11" (A4)).

**(3) Middle output tray**

Output paper that will not be offset in this tray. The tray is slidable. Extend the tray for printing on large-size paper (larger than 8-1/2" x 11" (A4)).

**(4) Saddle stitch tray**

Saddle-stitched output is delivered to this tray.

**(5) Front cover**

Open this cover to replace the staple cartridge or remove a staple jam.



- To install a saddle stitch finisher (large stacker), a paper pass unit is required.
- Do not place heavy objects on the saddle stitch finisher (large stacker) or press down on the saddle stitch finisher (large stacker).
- Exercise caution when you turn on the power and when printing take place, as the tray may move up and down.





## SUPPLIES

The saddle stitch finisher (Large stacker) requires the following staple cartridge:

### Finisher unit

Staple cartridge (approx. 5000 staples per cartridge × three cartridges)  
MX-SCX2

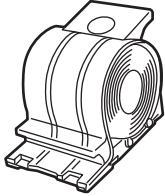

### Saddle stitch unit

Staple cartridge (approx. 5000 staples per cartridge × four cartridges)  
MX-SCX1

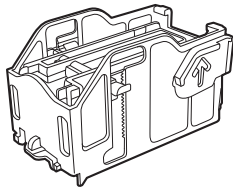

## REPLACING THE CARTRIDGE

### Finisher unit

When the staple cartridge runs out of staples, a message will appear in the operation panel. Follow the operation procedure to replace the staple cartridge.

1

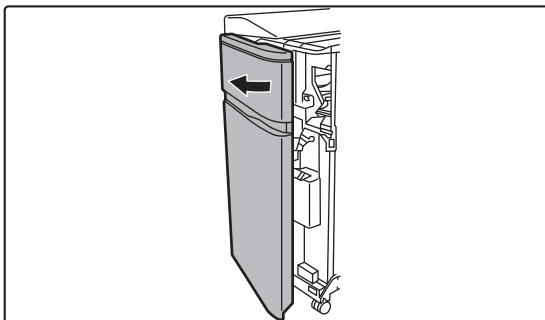

Open the front cover.



2

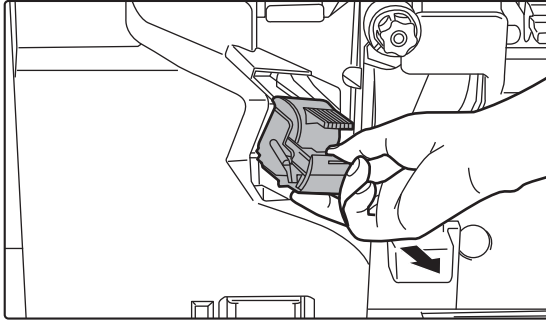

**Squeeze the green parts of the staple case and pull the case up and then out.**

3

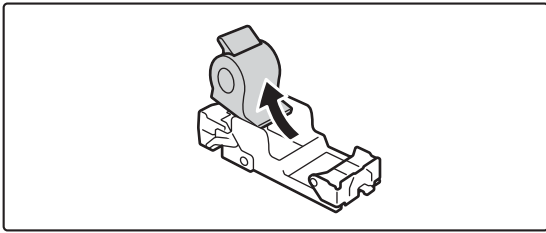

**Remove the empty staple cartridge.**



When staples remain, the staple cartridge cannot be removed.

4

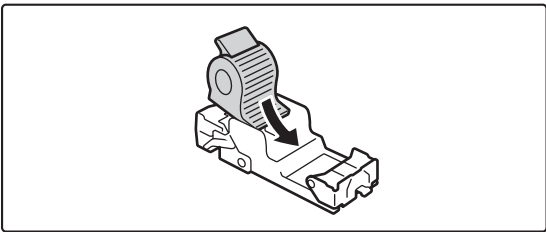

**Insert a new staple cartridge into the staple case.**

Push the staple case in until it clicks into place.

5

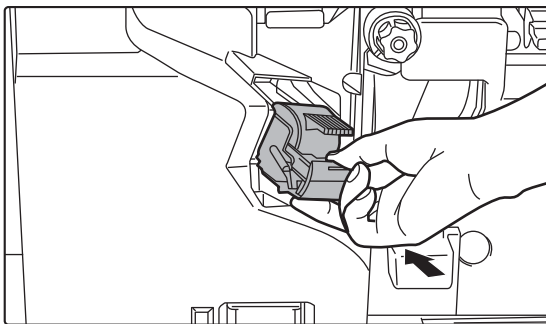

**Install a staple case.**

Push the staple case in until it clicks into place.



6

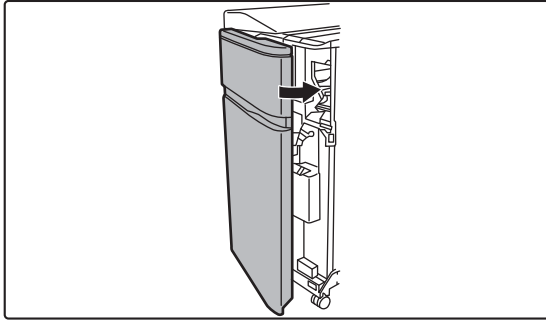

**Close the front cover.**



Make a proof copy in staple sort function to verify that stapling takes place correctly.

## Saddle stitch unit

When the staple cartridge runs out of staples, a message will appear in the operation panel. Follow the operation procedure to replace the staple cartridge.

Before starting this procedure, remove all output from the output tray of the saddle stitch finisher (Large stacker). Do not replace removed output back in the output tray.

1

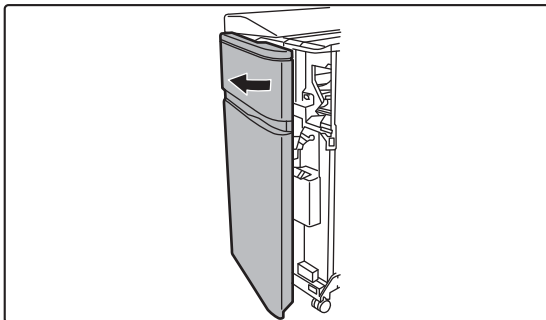

**Open the front cover.**

2

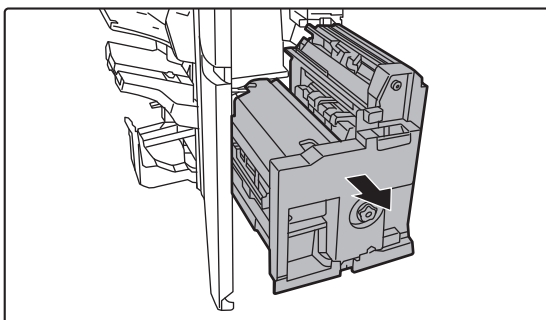

**Grasp the handle on the saddle stitch unit and pull it slowly out until it stops.**



3

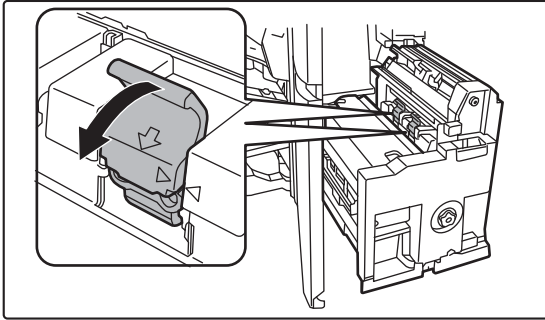

**Lower the staple case release lever and remove the staple case.**

Pull the staple case out to the left.  
Replace both staple cartridges.

4

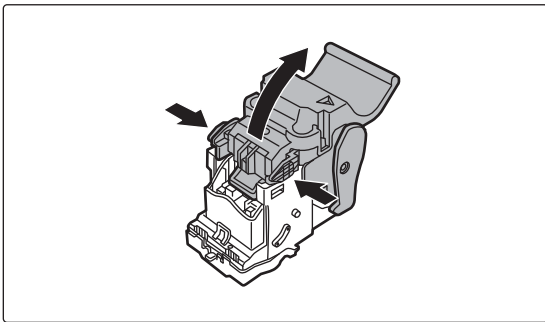

**Press the lock button to open the release lever.**

5

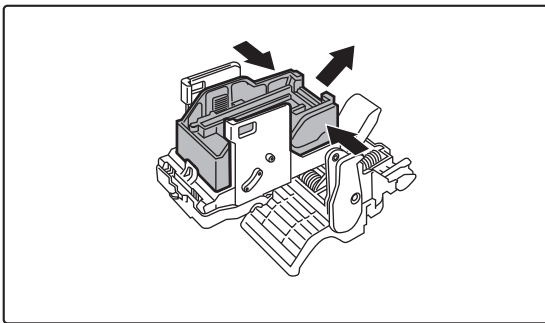

**Remove the empty staple cartridge.**



Press the lock button to open the release lever.

6

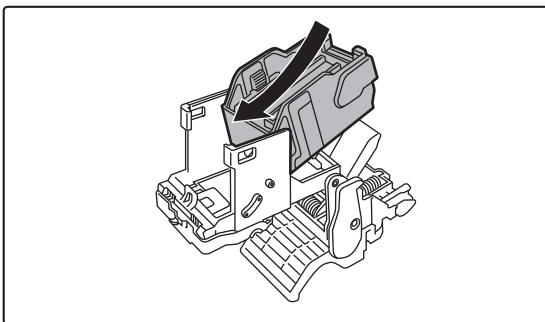

**Install a new staple cartridge.**

Push the staple case in until it clicks into place.



7

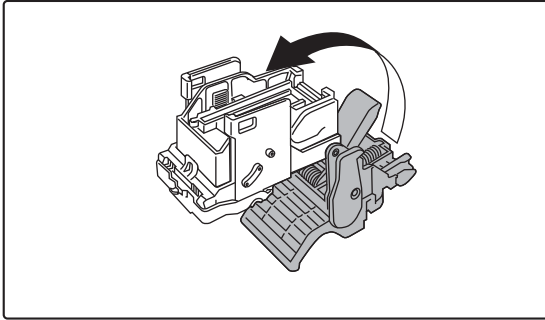

**Press the lock button to open the release lever.**

8

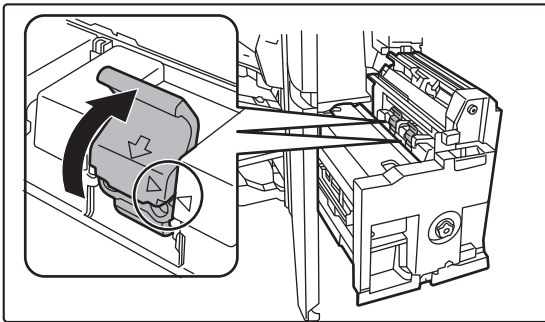

**Push the staple case firmly back in.**

Align ► of the staple case with ◀ of the unit.  
Push the staple case in until it clicks into place.

9

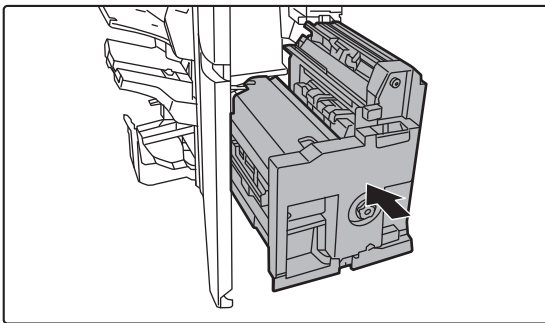

**Push the saddle stitch unit in.**

10

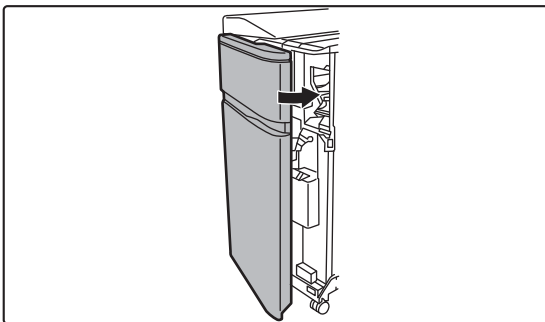

**Close the front cover.**



Make a test print or copy using the saddle stitch function to verify that stapling takes place correctly.



## DISCARDING STAPLE WASTE

When a finisher is used for stapling, staple waste is produced. The staple waste is collected in the staple waste box. Follow the steps below to discard staple waste.

1

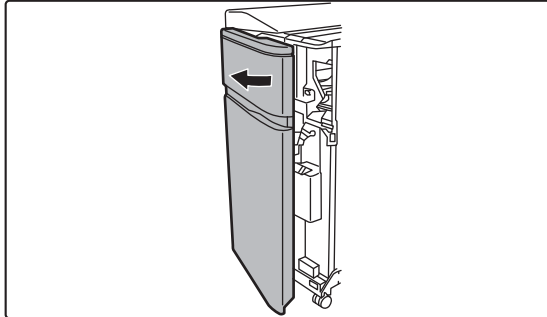

Open the front cover.

2

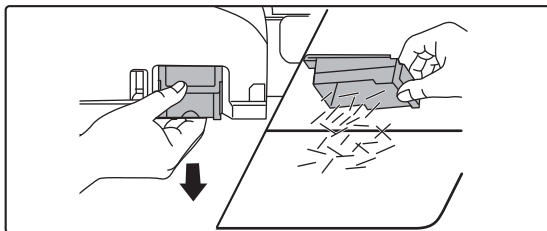

Grasp the tab of the staple waste box, gently pull out the box, and discard the staple waste.



- Do not put your fingers into the staple waste box. The staples may prick and injure your fingers.
- Do not discard the staple waste in a plastic bag. The staples may create holes in the bag.

3

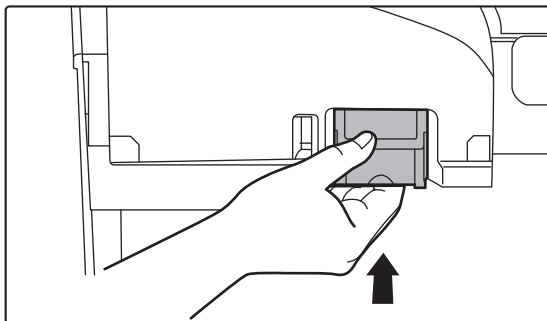

Replace the staple waste box.

Make sure that the staple waste box is replaced correctly.

4

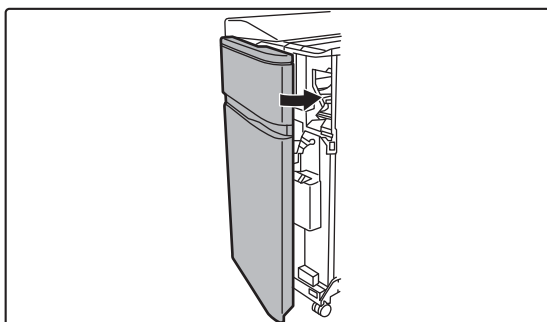

Close the front cover.



## DISCARDING PAPER WASTE

When folded paper is trimmed in trimmer settings, paper waste is generated.  
Paper waste is collected in the paper waste box.  
Follow the operation procedure to remove paper waste.



Using the trimmer function trims a side drop at the time of folding, creating a neat finish.

1

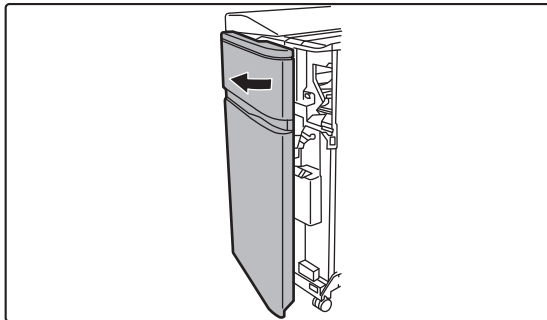

**Open the front cover.**

2

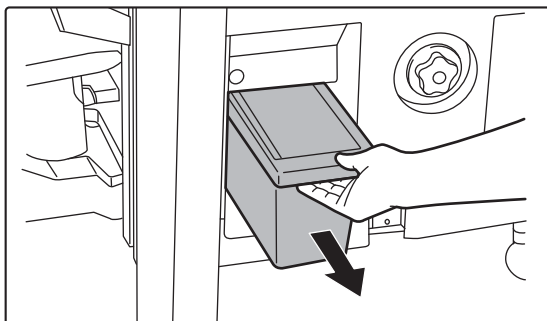

**Grasp the paper waste box handle, gently pull out the box, and discard the paper waste.**

Discard the paper waste into a plastic bag or other container, being careful not to let any waste scatter.

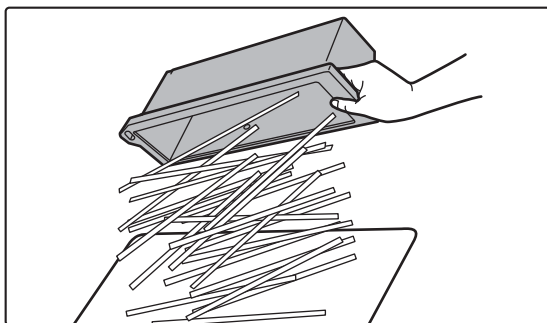

3

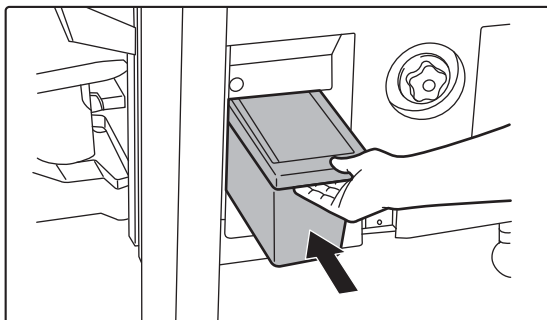

**Gently push the box back in.**



4

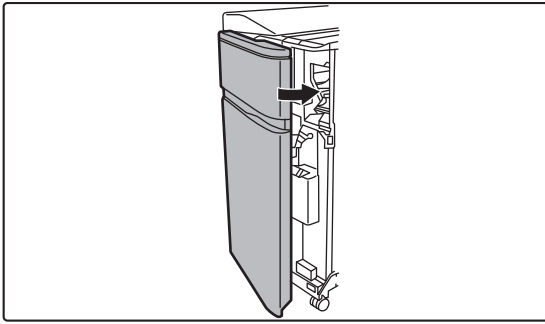

**Close the front cover.**





# PUNCH MODULE (MX-PN13A/B/C/D)

The punch module can be installed on a finisher (large stacker) or saddle stitch finisher (large stacker) to punch holes in paper to be output.



A finisher (large stacker) or saddle stitch finisher (large stacker) is required to install the punch module (large stacker).

## DISCARDING PUNCH WASTE

Punch waste from punched holes is collected in the punch waste box. Follow the operation procedure to replace punch waste.

1

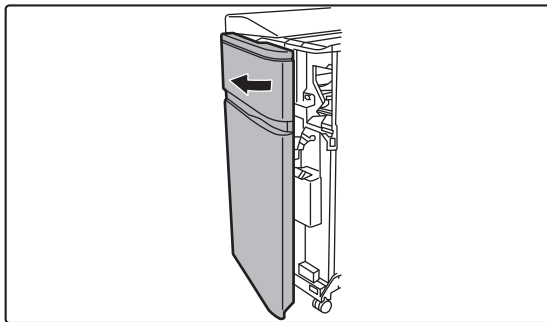

Open the front cover.

2

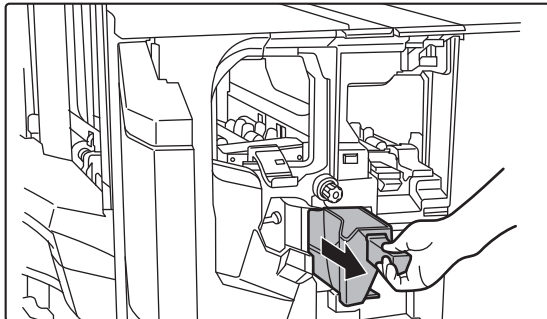

Grasp the punch waste box handle, gently pull out the box, and discard the punch waste.

Discard the punch waste in a plastic bag or other container, taking care not to let the waste scatter.

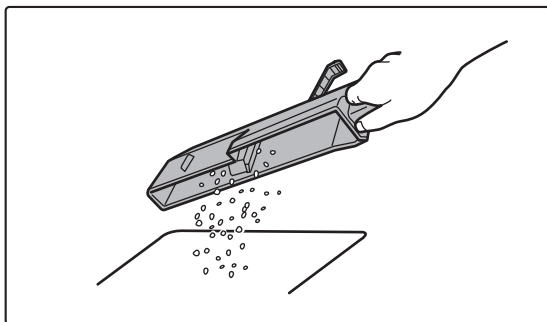



3

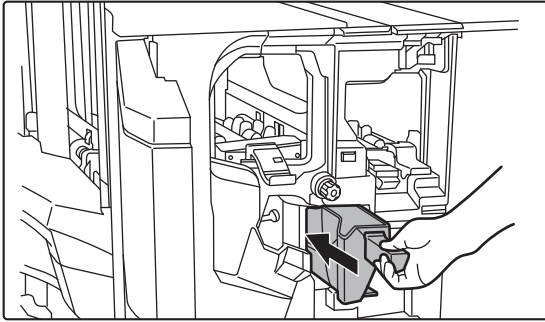

**Gently push the box back in.**

4

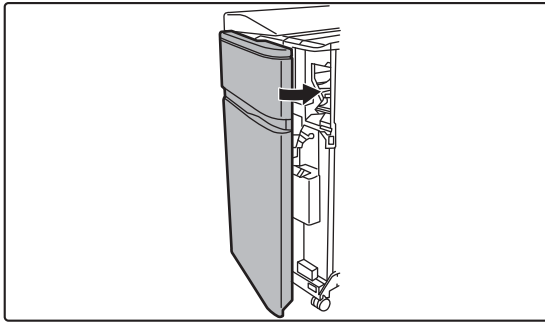

**Close the front cover.**



# FOLDING UNIT

A folding unit can be used for Z-Fold, C-Fold, Accordion Fold, Double Fold, and Half Fold.

---



A finisher (Large stacker) or saddle stitch finisher (Large stacker) is required to install the folding unit.

---

## PART NAMES

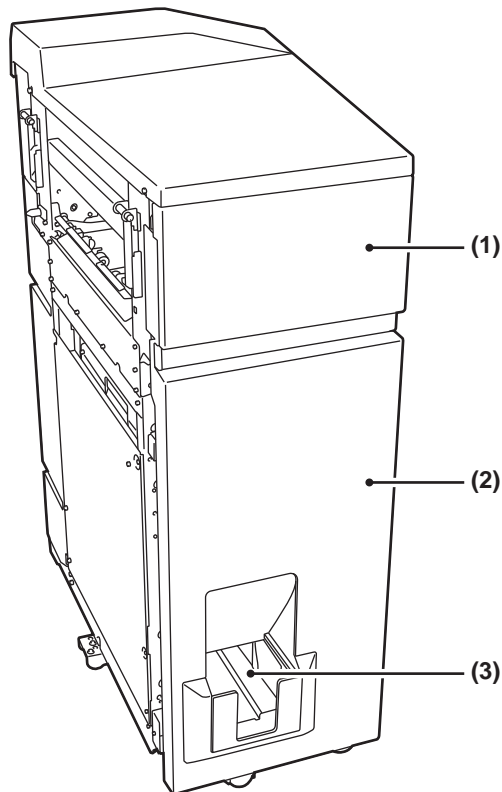

**(1) Top cover**

Open this cover to remove a paper misfeed.

**(2) Bottom cover**

Open this cover to remove a paper misfeed.

**(3) Output tray of folding unit**

Folded output is delivered to this tray.

---



Do not place heavy objects on the folding unit or press down on the folding unit.

---



# INSERTER

Covers and insertion sheets to be inserted into printed sheets can be loaded.

Using the manual finishing function, you can directly feed paper into the finisher (large stacker) or saddle stitch finisher (large stacker) to staple, punch or fold the paper.



For detailed information on paper that can be loaded into the inserter, see the "[SPECIFICATIONS \(page 8-2\)](#)".

## PART NAMES

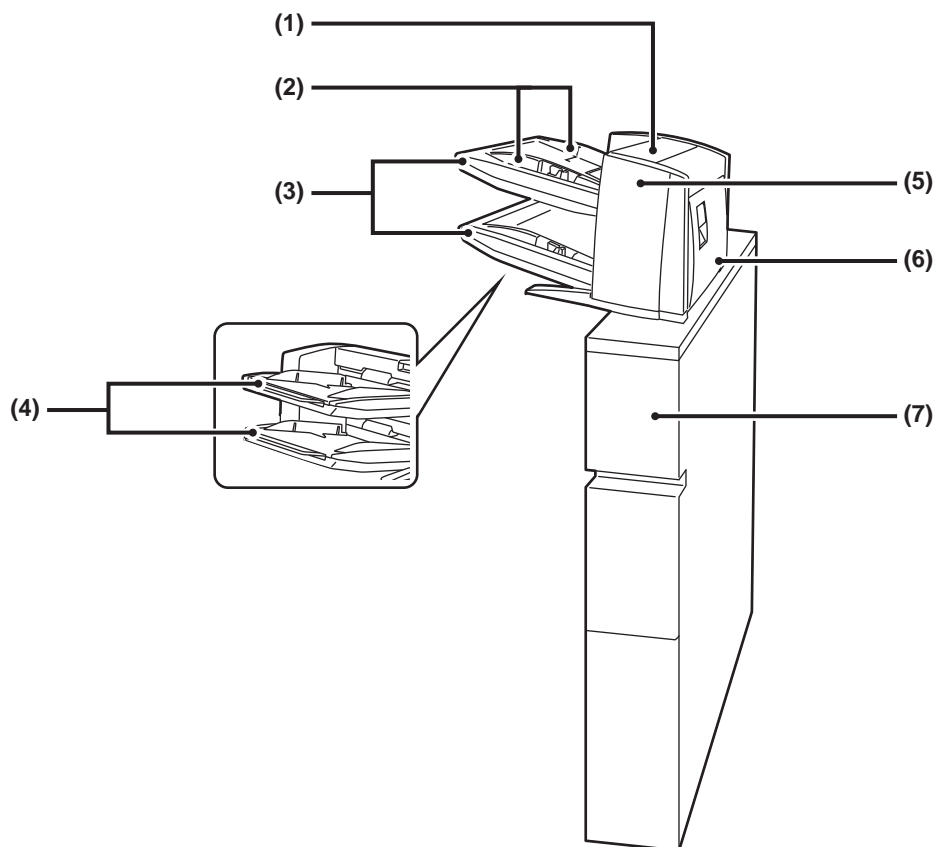

**(1) Paper insertion unit cover**

Open this cover to remove a paper misfeed.

**(2) Paper guide**

Push the lock lever to adjust to the paper size.

**(3) Paper tray (upper/lower)**

Insert paper or printed paper. A maximum of 200 sheets of paper can be loaded into each tray.

**(4) Bypass tray extension**

Extend this when loading paper larger than 8-1/2" x 11"R or A4R.

**(5) Paper transfer unit front cover**

Open this cover to remove a paper misfeed.

**(6) Paper transfer unit rear cover**

Open this cover to remove a paper misfeed.

**(7) Cover**

Open this cover to remove a paper misfeed.



# STATUS INDICATORS

These indicators show the status of the machine. The green indicator lights up or blinks according to the job status of the machine. The red indicator lights up or blinks when an error occurs. It lights up when an error occurs but the machine is still able to be used, and blinks when the machine is not able to be used due to an error. In setting mode, you can change the operation settings for the status indicators.

## PART NAMES

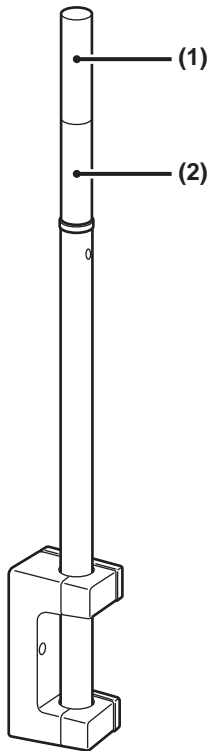

**(1) Indicator (Red)**

The red indicator lights up or blinks when an error occurs.

**(2) Indicator (Green)**

The green indicator lights up or blinks according to the job status of the machine.



In Auto Power Shut-Off mode, the status indicators go off.



**To change the conditions for the status indicators to light up or blink:**

In "Settings (administrator)", select [System Settings] → [Common Settings] → [Device Control] → [Status Indicator Setting].



# Sharp OSA

Sharp OSA (Open Systems Architecture) is an architecture that directly links the machine to software applications for work (external applications) over a network.

When you use a machine that supports Sharp OSA, you can link controls on the operation panel and device functions such as scan send to external applications.

## APPLICATION COMMUNICATION

This module enables you to link the machine with a scanner application and other standard applications. Set a standard application in "Settings (administrator)" and "Sharp OSA".



### To set a standard application in "Settings (administrator)":

In "Settings (administrator)", select [System Settings] → [Sharp OSA Settings] → [Standard Application Settings].

1



### Tap the [Sharp OSA] key in the Home screen.

If no standard applications have been stored, the key cannot be tapped.

2



### Select a standard application.

If two or more standard applications have been stored, the screen for selecting a standard application will appear. Tap the standard application that you wish to use.

If only one standard application has been stored, connection to the standard application will begin.

3

### Connect the machine to the standard application.

The message "Connecting to the external application." appears while the machine communicates with the standard application.



# EXTERNAL ACCOUNT APPLICATION

The external account module enables you to use an "external account application" for centralized account management of an MFP on a network.

An "external account application" can be used in "external authentication mode" or "external count mode". When "external authentication mode" is used, the login screen is retrieved from the application when the machine is started. When a job ends, a job notification screen is sent to the application for counts by authenticated user. When "external count mode" is used, the login screen is not displayed when the machine is started. Only a job result notification is sent to the application. User authentication by the external account application cannot be used. However, the external account application can be used in combination with the internal account function.

## External account application setup

After setting an external application in "Settings (administrator)", restart the machine to enable the setting. To restart the machine, see "[TURNING ON THE POWER \(page 1-10\)](#)".



### To set up the external account application:

In "Settings (administrator)", select [System Settings] → [Sharp OSA Settings] → [External Accounting Application Settings].

## Operation in external account mode

The following describes operation in the two modes for using an external account application.

### External authentication mode

When the machine is powered on in external authentication mode, the machine accesses the external account application and displays the login screen. The login screen also appears when the [Call] key is tapped to run a job in the job management complete screen. (The login screen does not appear if the user has already logged in by the normal method.)

Tap the job management display while the login screen is displayed, and the Job Management screen appears. To return to the previous screen, tap a mode select key.



### To enable the external authentication mode:

In "Settings (administrator)", select [System Settings] → [Authentication Settings] and enable the [User Authentication] setting. Next, in "Settings (administrator)", select [System Settings] → [Sharp OSA Settings] → [External Accounting Application Settings] and enable the [External Account Control] setting.



- The user control function of the machine cannot be used in external authentication mode. However, "User Registration", "User Count Display", "User Count Reset", "User Information Print", and "The Number of User Name Displayed Setting" can be used.
- The mode select key cannot be used while the login screen appears.

### If login fails:

If the login screen fails to appear or the application does not operate correctly, the machine may also stop operating correctly. In that case, terminate external account mode forcibly.



### To forcibly terminate the external account mode:

In "Settings (administrator)", select [System Settings] → [Authentication Settings] and enable the [User Authentication] setting.



## External count mode

Unlike in external authentication mode, when the machine is started in "external count mode", the login screen of the external account application is not displayed after the machine has started up. Only the job result is sent to the external account application.

External count mode can be used together with the user control function of the machine. (External count mode can also be used when the user control function is disabled.)



### To enable the external count mode:

In "Settings (administrator)", select [System Settings] → [Sharp OSA Settings] → [External Accounting Application Settings] and enable the [External Account Control] setting.

---





# Sharp OSA Settings

In "Settings (administrator)", select [System Settings] → [Sharp OSA Settings]

## Condition Settings

### Sharp OSA version

Displays Sharp OSA version supported by this machine.

### Cookie Setting

Specify how application cookies are handled when using an application in Sharp OSA. When "Hold Cookie" is selected, the machine holds cookies that are used in an application. When "Not hold Cookie" is selected, cookies are not held when an application is used.

### Delete Cookie

Delete cookies held by the machine.

### Accept remote access request from application

Select if using a Sharp OSA application of a type that uses remote access from external to the machine.

### Application allowed to access

Register the application URL of the Sharp OSA application for which to allow remote access to the machine.

### Approve remote access request on operation panel

Displays a permission dialogue on the printer operation panel when starting usage of the remote access function.

### Accept UI operation request from application

Select when using applications that control UI of the multifunction machine.

### Display dialog of connection in Sharp OSA mode

Displays a connecting dialogue on the printer operation panel during remote access.

### Accept secondary send request from Sharp OSA application

Select when sending scan data processed by an application to an arbitrary destination through the machine.

## Standard Application Settings

The standard application settings can be added and controlled.

- [Add] key  
Adds a new standard application.
- List  
Lists the currently stored standard applications.



The application communication module is required.

## Store Standard Application

When you tap the [Add] key, the registration screen appears. Up to 64 items can be stored. For information on the settings, see the following table.

## Edit or Delete Standard Application

When you tap an application name on the list, the edit screen appears for that standard application. Tap the [Delete] key to delete the standard application.



## Settings

| Item                       | Settings   |
|----------------------------|--|
| Application Name           | Enter an application name.   |
| Address for Application UI | Set an IP address of the application or a network name to control the UI of the machine. |
| Timeout                    | Enter a timeout. The default setting is 20 seconds.                                      |
| Extended Platform          | Set this option to use the expansion platform.   |
| Data Size                  | Set the screen size of application.  |
| Use Custom Icon*           | Select whether or not custom icon is used.   |
| File Name*                 | Reports file name.   |
| Select File*               | Please enter File Name.  |

\* These functions can be set only in the Web page.



## External Accounting Application Settings

An external account application can be added and controlled.  
Set the server name where you have installed the external accounting application.



The external account module is required.

| Item                        | Settings  |
|-----------------------------|---|
| Server 1-4                  | Set to enable each of the servers.  |
| Application Name            | Enter an application name.  |
| Use Embedded Application    | Set to use the embedded application.  |
| Address for Application UI* | Enter the URL of the login screen to be accessed first when the machine is turned on.         |
| Address for Web Service     | Enter the URL of the server or computer which sends commands and events by XML/SOAP protocol. |
| Timeout                     | Enter a timeout. The default setting is 20 seconds.   |
| Extended Platform           | Set this option to use the expansion platform.  |
| Data Size*                  | Set the screen size of application.   |
| Find My Address             | Search my address.  |

\* This setting can be set in Server 1.

## Embedded Application Settings

Store and manage "embedded applications" that are installed in the machine.

- [Add] key  
Adds a new embedded application.
- List  
Lists the currently installed embedded applications.



The application communication module is required.

## Install Embedded Application

When you tap the [Add] key, the registration screen appears. Up to 64 items can be installed.



- When installing from the operation panel of the machine, the files in the USB memory connected to the machine are installed. When installing from the Web page, the files in the computer are installed.
- The maximum area of the local drive that applications can use is 4 GB. If previously installed applications are already using 4 GB of area, a new application cannot be installed.

## Store Embedded Application

By storing an already installed embedded application in "standard application", the application can be used. Select the application name checkbox and tap the [Add Standard Applications] key.

## Delete Embedded Application

Tap an application name in the list to display the information of that standard application.  
After checking the information, delete the standard application with the [Delete] key.



## Polling Setting

When linked to an external application, you can store and manage addresses in order to use a service that uses a polling function.



The application communication module is required.

| Item                | Settings  |
|---------------------|---|
| Server 1 - Server 2 | Set to enable each of the servers.                                  |
| Polling Address     | Enter the URL of the server or computer that the machine will poll. |
| Check Interval      | Enter the check interval for the server. The default is 1 minute.   |
| Timeout             | Set the timeout time. The default setting is 20 seconds.            |



# REMOVING MISFEEDS

## REMOVING MISFEEDS

If a paper misfeed occurs, the "Paper Jam" message will appear in the touch panel and printing and scanning will stop. In this event, tap the [Check how to remove misfeeds] key in the touch panel.

When the key is tapped, instructions for removing the misfeed will appear. Follow the instructions. When the misfeed is cleared, the message will automatically disappear.

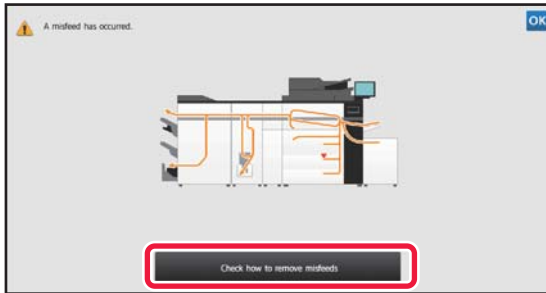

- The fusing unit and paper output area are hot.
- When removing a misfeed, do not touch the fusing unit. You may burn yourself.

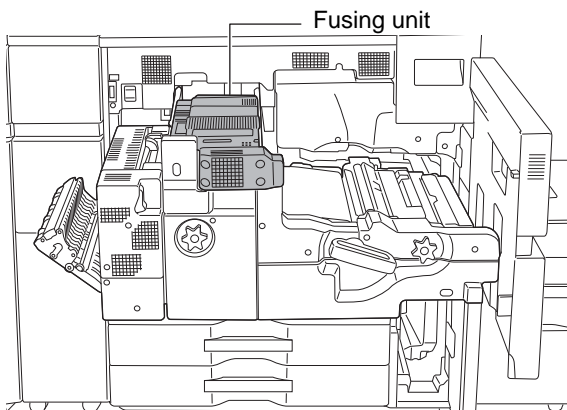



# MAINTENANCE

This section explains how to clean the machine, replace the toner cartridge, the waste toner box, and the stamp cartridge.

## REGULAR MAINTENANCE

To ensure that the machine continues to provide top quality performance, periodically clean the machine.



Do not use a flammable spray to clean the machine. If gas from the spray comes in contact with hot electrical components or the fusing unit inside the machine, fire or electrical shock may result.



Do not use thinner, benzene, or similar volatile cleaning agents to clean the machine. These may degrade or discolor the housing.

## CLEANING THE DOCUMENT GLASS AND AUTOMATIC DOCUMENT FEEDER

If the document glass or document backplate sheet becomes dirty, the dirt will appear as dirty spots, colored lines, or white lines in the scanned image. Keep these parts clean at all times.

Wipe the parts with a clean, soft cloth.

If necessary, moisten the cloth with water or a small amount of neutral detergent. After that, wipe with a clean dry cloth.

### Examples of lines in the image

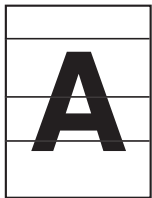

Colored lines



White lines

### Document glass

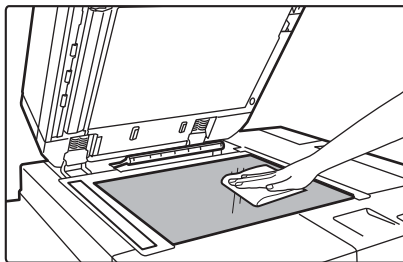

### Document backplate sheet

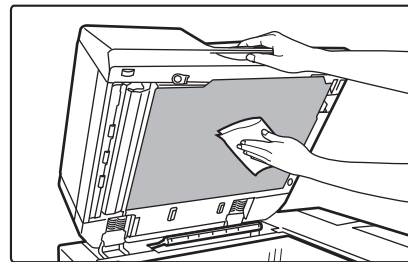



## SCANNING AREA

If black lines or white lines appear in images scanned using the automatic document feeder, clean the scanning area (the thin long glass next to the document glass).

To clean this part, use the glass cleaner that is stored in the automatic document feeder. After using the glass cleaner, be sure to return it to its storage position.

1

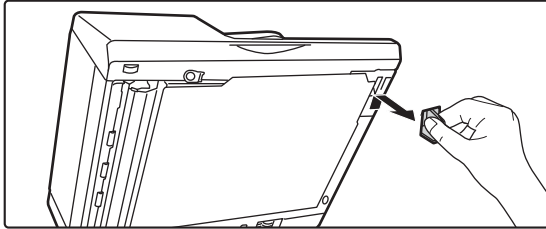

**Open the automatic document feeder and remove the glass cleaner.**

2

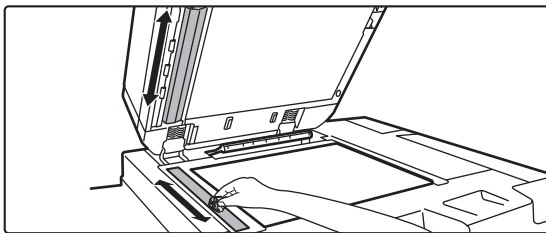

**Clean the document scanning area on the document glass with the glass cleaner.**

One scanning area is on the document glass and the other is inside the automatic document feeder.

3

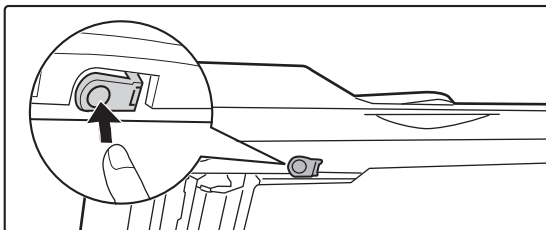

**Open the scanning area cover on the automatic document feeder.**

Push in the release switch to release the cover.

4

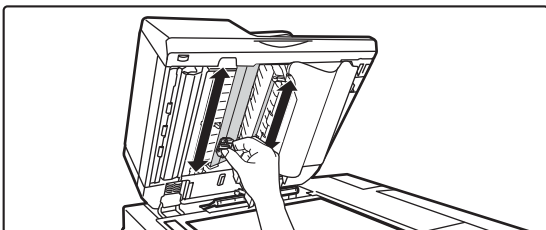

**Clean the scanning area in the automatic document feeder.**

5

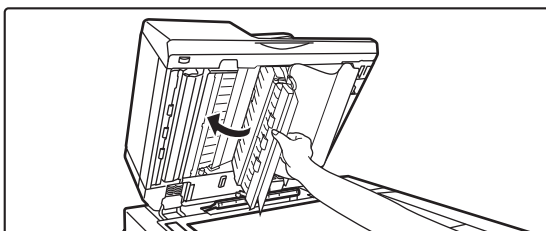

**Close the cover.**



6

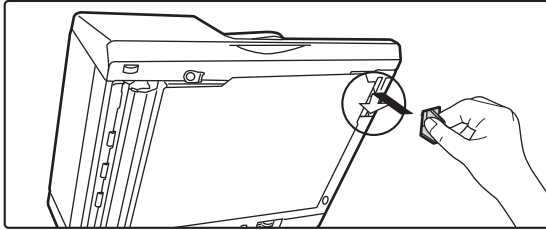

Replace the glass cleaner.

## CLEANING THE BYPASS FEED ROLLER

If paper misfeed frequently occur in the bypass tray, clean the bypass feed roller. Wipe the surface of the feed roller with a clean soft cloth moistened with water or a neutral detergent.

### Bypass tray (on the machine)

1

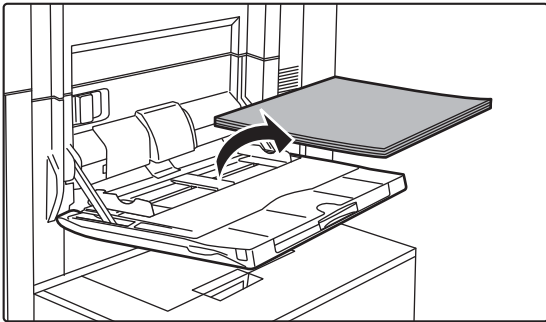

Remove paper.

2

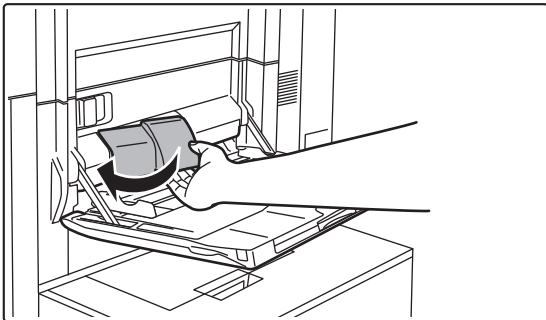

Remove the maintenance cover.

3

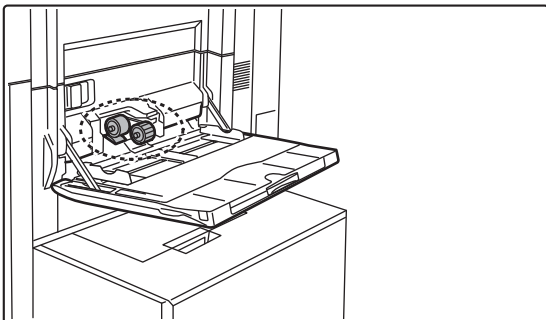

Clean the bypass feed roller.

Install the maintenance cover after the cleaning is completed.





4

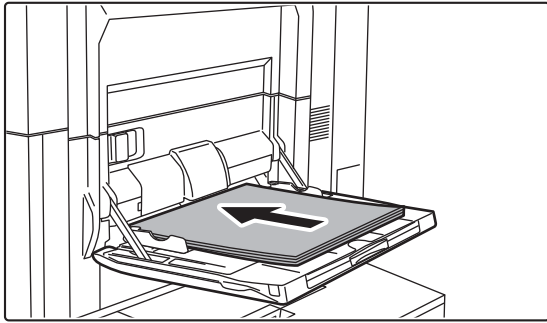

**Load the paper.**

### Bypass tray (large capacity trays)

1

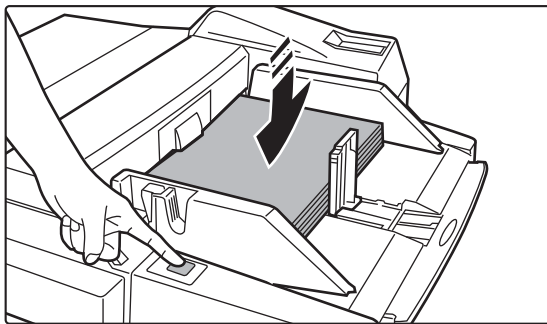

**Press the operation button and remove paper.**

The paper table goes down. The operation button blinks while the paper table goes down. The button lights up when the paper table has gone down. Do not remove the paper until the button ceases blinking.

2

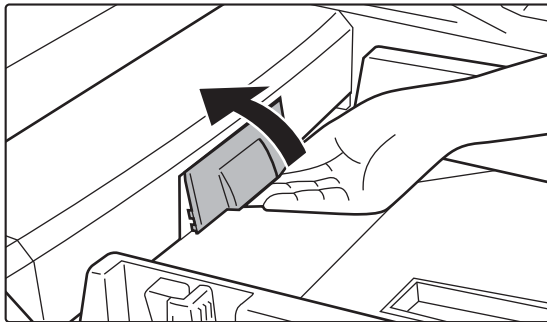

**Remove the maintenance cover.**

3

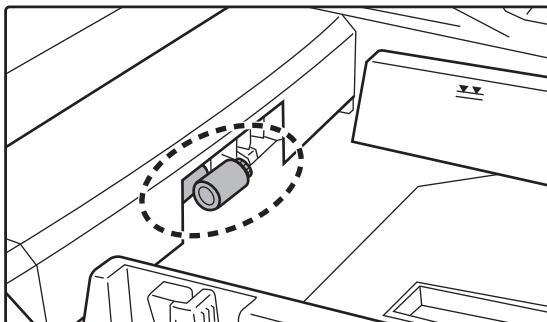

**Clean the bypass feed roller.**

Install the maintenance cover after the cleaning is completed.



4

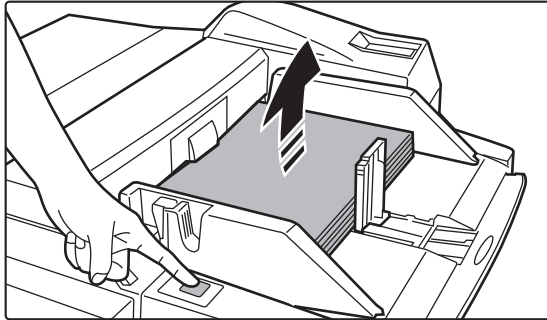

**Load the paper and press the operation button.**

The paper table goes up when the operation button is pressed.

## CLEANING THE PAPER FEED ROLLER

If lines or other dirt appear on the scanned original when the automatic document feeder is used, wipe the surface of the roller with a clean soft cloth moistened with water or a neutral detergent.

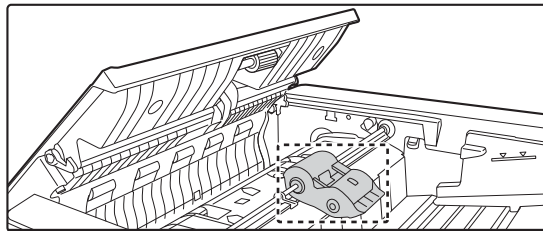



# REPLACEMENT OF TONER CARTRIDGE

As a rule, toner cartridges should be replaced after the message "Change the toner cartridge." appears. You should keep one set of replacement toner cartridge on hand so that you can preplace a toner cartridge immediately when toner runs out.



Empty toner cartridge can be replaced without interrupting a copy/print job.

## Replacement message

If you continue printing, the following message appears.

When this message appears, prepare a toner cartridge for replacement and replace it.

In this state, printing is possible.

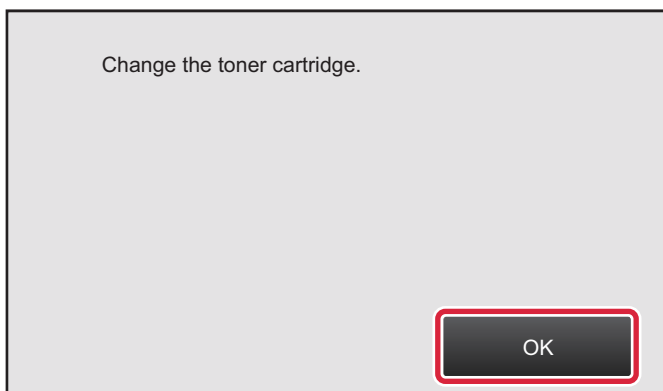

If you continue to use the machine without replacing the cartridge, printing is stopped and the follow message appears. Once the machine enters this state, printing can not be carried out until the toner cartridge is replaced.

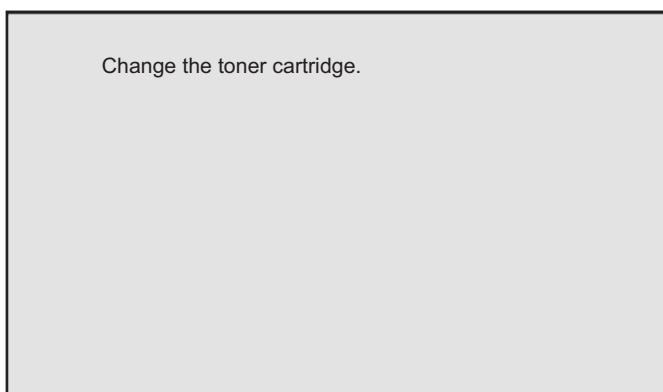



1

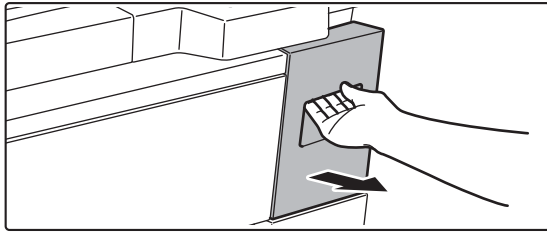

### Pull out the toner tray.

Slowly pull out the toner tray until it stops.



If the keyboard has been pulled out from the operation panel, be sure to store it in the operation panel. If the keyboard is pulled out, the toner tray may come in contact with the keyboard and cause damage.

2

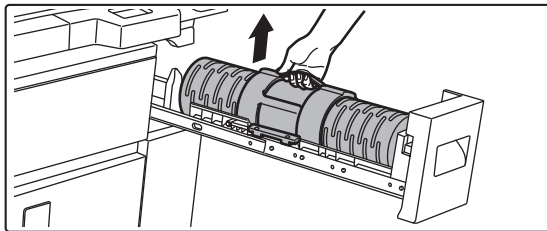

### Remove the toner cartridge.

Slowly pull the toner cartridge straight up and out.  
If the cartridge is pulled out abruptly, toner may spill.

3

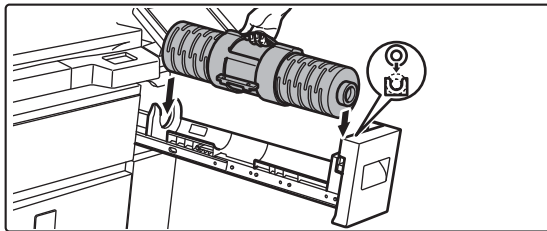

### Insert the new toner cartridge straight down.

The ends of the cartridge must be oriented correctly or it will not be possible to insert the cartridge.

4

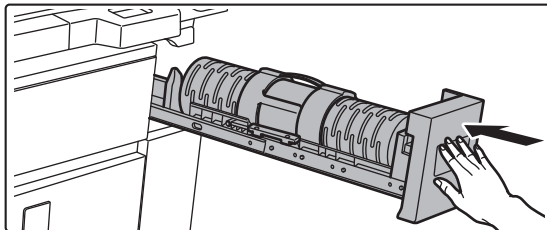

### Close the toner tray.

After the toner cartridge is replaced, toner filling takes place automatically.

If the message prompting you to replace the toner does not appear, do not open the toner tray.



- Do not touch the toner fill hole.

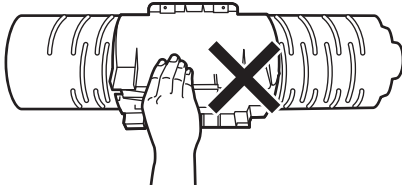

- Do not shake or swing the toner cartridge.
- Do not throw a toner cartridge into a fire. Toner may fly and cause burns.
- Store toner cartridges out of reach of small children.
- If a toner cartridge is stored upright, the toner may harden and become unusable. Always store toner cartridges on their side.
- If a toner cartridge other than a SHARP-recommended toner cartridge is used, the machine may not attain full quality and performance and there is a risk of damage to the machine. Be sure to use a SHARP-recommended toner cartridge.



- Depending on your conditions of use, the color may become light or the image blurred.
- Your service technician will collect used toner cartridges.
- To view the approximate amount of toner remaining (indicated in %), hold down the [Home Screen] key during printing or in standby mode. When the percentage falls to "25-0%", keep a toner cartridge for replacement purposes before toner runs out.
- When toner runs out while the home screen is displayed, the "Toner Empty" message appears in the upper right corner of the screen.



# REPLACING THE WASTE TONER BOTTLE

The waste toner bottle collects excess toner that is produced during printing. When the waste toner bottle becomes full, the message "Replace waste toner bottle." will appear.

When this message appears, tap the guidance key that appears on the touch panel to view the procedure for replacing the waste toner bottle.

When the key is tapped, instructions for replacing the waste toner bottle will appear. Follow the instructions. When the waste toner bottle is replaced, the message will automatically disappear.



- Do not throw the waste toner bottle into a fire. Toner may fly and cause burns.
  - Store the waste toner bottle out of the reach of small children.
-



# REPLACING THE STAMP CARTRIDGE

If a stamp unit (AR-SU1) is installed on the automatic document feeder and the stamp has become light, replace the stamp cartridge (AR-SV1).

## Supplies

Stamp cartridge (2 in package) AR-SV1

1

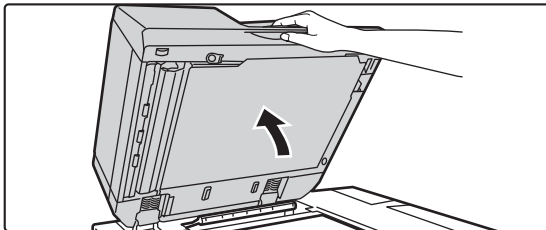

Open the automatic document feeder.

2

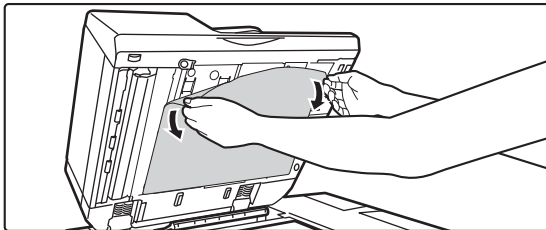

Remove the document backplate sheet from the automatic document feeder.

Remove the sheet slowly. Place the removed sheet with the side that was attached face up on the document glass.

3

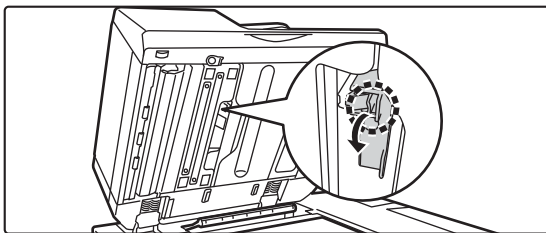

Grasp the tab on the stamp unit and pull the unit out.

4

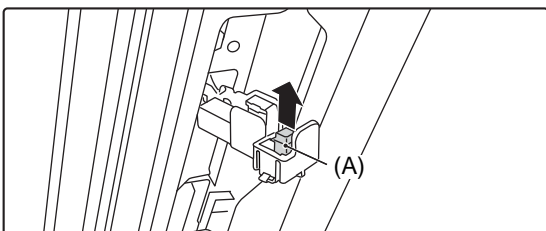

Remove the stamp cartridge (A).

5

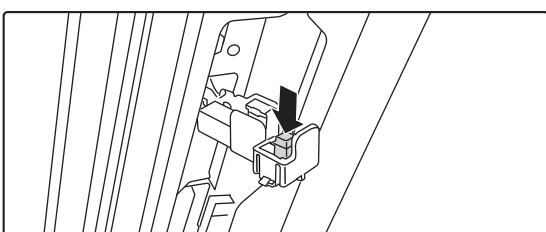

Install a new stamp cartridge.



6

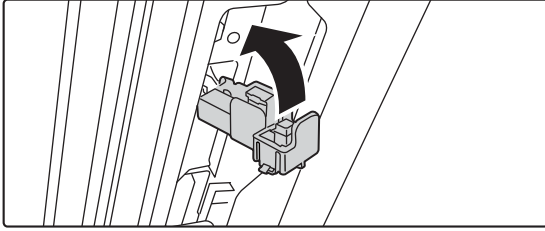

**Push the stamp unit back in.**

Push the stamp unit in until it clicks into place.

7

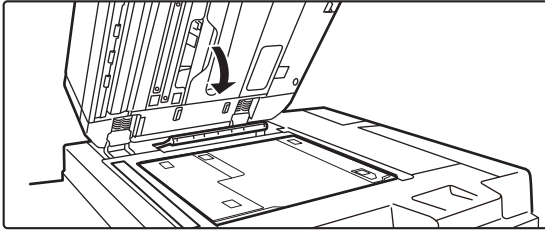

**Close the automatic document feeder to attach the document backplate sheet.**

When the automatic document feeder is closed, the document backplate sheet on the document glass attaches to the automatic document feeder.

8

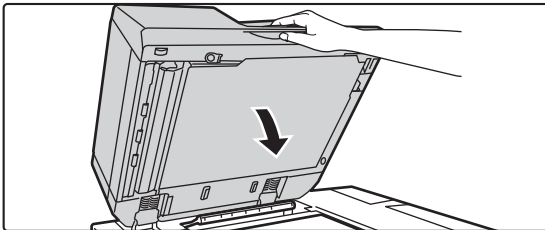

**Make sure that the document backplate sheet is firmly attached to the automatic document feeder and then close the automatic document feeder.**



If the document backplate sheet is not firmly attached, remove the sheet and then close the automatic document feeder again to firmly attach the sheet.





# COPIER

## Icons

-  Functions you can use in Easy Copy mode
-  Eco-friendly functions
-  Functions for copying on special media

## BEFORE USING THE MACHINE AS A COPIER

|   |             |
|---|-------------|
| <b>COPY MODE</b> .....                          | <b>2-3</b>  |
| • EASY MODE .....                               | 2-3         |
| • NORMAL MODE .....                             | 2-4         |
| <b>SELECTING COPY MODE</b> .....                | <b>2-4</b>  |
| <b>COPYING SEQUENCE</b> .....                   | <b>2-5</b>  |
| • Default settings for copying .....            | 2-8         |
| <b>COPY PREVIEW</b> .....                       | <b>2-9</b>  |
| <b>CHECKING THE ORIGINAL SIZE</b> .....         | <b>2-10</b> |
| <b>SELECTING THE PAPER TRAY FOR COPYING</b> ... | <b>2-12</b> |

## BASIC PROCEDURE FOR MAKING COPIES

|   |             |
|---|-------------|
| <b>COPYING</b> .....  | <b>2-13</b> |
| • USING THE AUTOMATIC DOCUMENT FEEDER FOR COPYING .....         | 2-13        |
| • USING THE DOCUMENT GLASS FOR COPYING .....                    | 2-14        |
| <b>AUTOMATIC 2-SIDED COPYING</b> .....                          | <b>2-16</b> |
| • USING THE AUTOMATIC DOCUMENT FEEDER FOR 2-SIDED COPYING ..... | 2-16        |
| • USING THE DOCUMENT GLASS FOR 2-SIDED COPYING .....            | 2-17        |
| <b>CHANGING THE EXPOSURE AND ORIGINAL IMAGE TYPE</b> .....      | <b>2-19</b> |
| • AUTOMATIC ADJUSTMENT OF EXPOSURE AND ORIGINAL TYPE .....      | 2-19        |
| • MANUAL ADJUSTMENT OF EXPOSURE AND ORIGINAL TYPE .....         | 2-19        |
| <b>ENLARGE/REDUCE</b> .....                                     | <b>2-22</b> |
| • AUTO RATIO SELECT .....                                       | 2-22        |
| • MANUAL RATIO SELECTION .....                                  | 2-23        |
| • ENLARGING/REDUCING THE LENGTH AND WIDTH SEPARATELY .....      | 2-26        |
| <b>SELECTING THE ORIENTATION AND SIZE OF THE ORIGINAL</b> ..... | <b>2-29</b> |
| <b>STORING FREQUENTLY USED ORIGINAL SIZES</b> ...               | <b>2-31</b> |

|   |             |
|---|-------------|
| <b>MAKING COPIES USING THE BYPASS TRAY</b> ...                        | <b>2-34</b> |
| • MAKING COPIES USING THE BYPASS TRAY ...                             | 2-34        |
| • SPECIFYING A TYPE AND SIZE OF PAPER LOADED ON BYPASS TRAY .....     | 2-35        |
| <b>OUTPUT</b> .....   | <b>2-36</b> |
| • SORT/GROUP SETTING .....  | 2-36        |
| • STAPLE SETTINGS .....   | 2-37        |
| • PUNCH SETTINGS .....  | 2-41        |
| • FOLD SETTING .....  | 2-43        |
| • INSERTING SEPARATOR PAGES BETWEEN COPIES OR JOBS .....              | 2-44        |
| <b>BATCH COPY FUNCTIONS</b> .....                                     | <b>2-46</b> |
| • COPYING MULTIPLE ORIGINALS AS A SINGLE PAGE (N-Up) .....            | 2-46        |
| • COPYING EACH FACING PAGE OF A BOUND DOCUMENT (DUAL PAGE COPY) ..... | 2-48        |
| • COPYING BOTH SIDES OF A CARD AS A SINGLE PAGE (CARD SHOT) .....     | 2-50        |
| • REPEATING THE SAME IMAGE ON ONE SHEET (REPEAT LAYOUT) .....         | 2-52        |
| • COPYING MULTIPLE BUSINESS CARDS (BUSINESS CARD COPY) .....          | 2-57        |

## OTHER FUNCTIONS

|  |             |
|--|-------------|
| <b>OUTPUT AND LAYOUT EDITING FUNCTIONS</b> ...   | <b>2-59</b> |
| • MAKING COPIES IN PAMPHLET FORMAT (BOOKLET) .....   | 2-59        |
| • COPYING MULTIPLE ORIGINALS ON EACH BOOKLET PAGE (BOOKLET 2-Up/4-Up) ...  | 2-62        |
| • COPYING A PAMPHLET (BOOK COPY) ...   | 2-65        |
| • SPLITTING A PAMPHLET ORIGINAL BY PAGE (BOOK DIVIDE) .....  | 2-67        |
| <b>COPYING AN ORIGINAL IN REVERSE PAGE ORDER (REVERSE ORDER)</b> .....   | <b>2-68</b> |
| • SKIPPING BLANK PAGES IN AN ORIGINAL (BLANK PAGE SKIP) .....  | 2-69        |
| • ADJUSTING THE BACKGROUND BY MAKING LIGHT AREAS OF THE ORIGINAL DARKER OR LIGHTER (BACKGROUND ADJUSTMENT) ..... | 2-71        |
| • MAKING A PROOF COPY (PROOF COPY) ...   | 2-73        |
| • CHECKING THE NUMBER OF SCANNED ORIGINAL SHEETS (ORIGINAL COUNT) ...  | 2-75        |
| • USING TWO MACHINES TO REDUCE THE COPY TIME (TANDEM COPY) .....   | 2-76        |





**SECURITY REINFORCEMENT FUNCTIONS . . . . . 2-78**

- PADDING UNAUTHORIZED COPY PREVENTION DATA (HIDDEN PATTERN PRINT) . . . . . 2-78
- FORCIBLY PRINTING TRACEABLE INFORMATION (TRACKING INFORMATION PRINT) . . . . . 2-80

**OUTPUT POSITION AND MARGIN ADJUSTMENT FUNCTIONS . . . . . 2-81**

- ADDING MARGINS (MARGIN SHIFT) . . . . . 2-81
- ERASING PERIPHERAL SHADOWS FOR COPYING (ERASE) . . . . . 2-83
- COPYING ORIGINALS WITH NO EDGE CUT-OFF (FULL BLEED COPY) . . . . . 2-85
- COPYING IN THE CENTER OF THE PAPER (CENTERING) . . . . . 2-86
- SPECIFYING A PAPER POSITION (POSITION IMAGE) . . . . . 2-87

**SCANNING FUNCTIONS . . . . . 2-89**

- COLLECTIVELY SCANNING A LARGE NUMBER OF ORIGINALS (JOB BUILD) . . . . . 2-89
- SCANNING ORIGINALS OF DIFFERENT SIZES (MIXED SIZE ORIGINAL) . . . . . 2-92
- SCANNING THIN ORIGINALS (SLOW SCAN MODE) . . . . . 2-94
- SCANNING HEAVY ORIGINALS (HEAVY PAPER SCAN) . . . . . 2-95
- ADJUSTING RESOLUTION WHEN SCANNING (RESOLUTION) . . . . . 2-96
- TEXT AND IMAGE ADDITION FUNCTIONS . . . . . 2-97
- ADDING A REGISTERED IMAGE TO AN ORIGINAL (CUSTOM IMAGE) . . . . . 2-100
- INSERTING COVERS IN COPIES (COVERS/INSERTS) . . . . . 2-103
- INSERTING INSERTION SHEETS IN COPIES (COVERS/INSERTS) . . . . . 2-111
- CHECKING, EDITING, AND DELETING THE PAGE LAYOUT OF COVERS AND INSERTION SHEETS (PAGE LAYOUT) . . . . . 2-115
- INSERTING INSERTION SHEETS IN BETWEEN TRANSPARENCY FILMS (TRANSPARENCY INSERTS) . . . . . 2-116

**FUNCTIONS FOR SPECIFIC USES . . . . . 2-118**

- COPYING CAPTIONS ONTO TAB PAPER (TAB COPY) . . . . . 2-118
- MAKING A POSTER-SIZED COPY (MULTI-PAGE ENLARGEMENT) . . . . . 2-121
- COPYING WITH MIRROR IMAGE (MIRROR IMAGE) . . . . . 2-123

**OUTPUT AND DENSITY ADJUSTMENT FUNCTIONS . . . . . 2-124**

- REVERSING WHITE AND BLACK IN A COPY (B/W REVERSE) . . . . . 2-124
- EASY ADJUSTMENT OF THE IMAGE QUALITY (QUICK IMAGE QUALITY ADJUSTMENT) . . . . . 2-125

- ADJUSTING THE SHARPNESS OF AN IMAGE (SHARPNESS) . . . . . 2-126
- ADJUSTING THE SHARPNESS OF AN IMAGE (SHARPNESS) . . . . . 2-126
- ADJUST DENSITY AREA FOR COPY (GRAY BALANCE) . . . . . 2-127

**CONVENIENT COPY FUNCTIONS**

**INTERRUPT COPY . . . . . 2-129**

**SEND DATA WHILE COPYING . . . . . 2-131**

**COPY JOBS . . . . . 2-133**

**PROGRAMS . . . . . 2-134**

- STORING A PROGRAM . . . . . 2-134
- RETRIEVING A PROGRAM . . . . . 2-136
- DELETING AND RENAMING A PROGRAM . . . . . 2-136



# BEFORE USING THE MACHINE AS A COPIER

## COPY MODE

There are two modes for copying: easy mode and normal mode.

Easy mode is limited to frequently used functions that allow you to smoothly perform most copy jobs.

If you need to select detailed settings or special functions, use normal mode. All functions can be used in normal mode.

## EASY MODE

Easy mode makes it easy to select basic settings for copying.

### 1st screen

Show the size of the placed original.

► [SELECTING THE ORIENTATION AND SIZE OF THE ORIGINAL \(page 2-29\)](#)

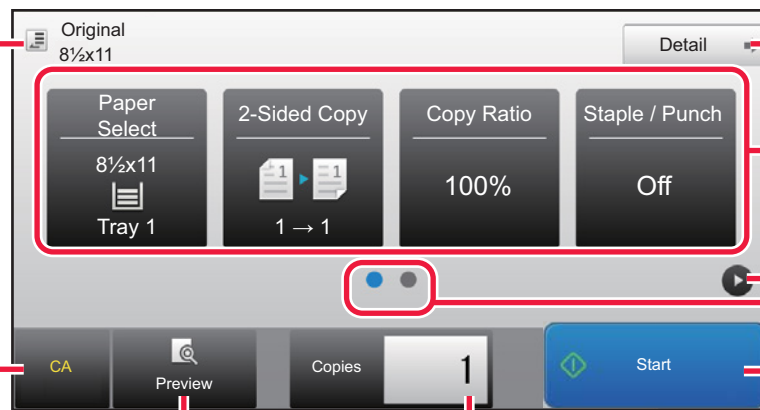

Change to normal mode.

► [NORMAL MODE \(page 2-4\)](#)

Select function to be set up.

Change the function display.

Reset all settings.

Starts copying.

Scans the original and shows a preview image.

Enter the number of copies.

► [PREVIEW SCREEN \(page 1-14\)](#)

### 2nd screen

Select function to be set up.

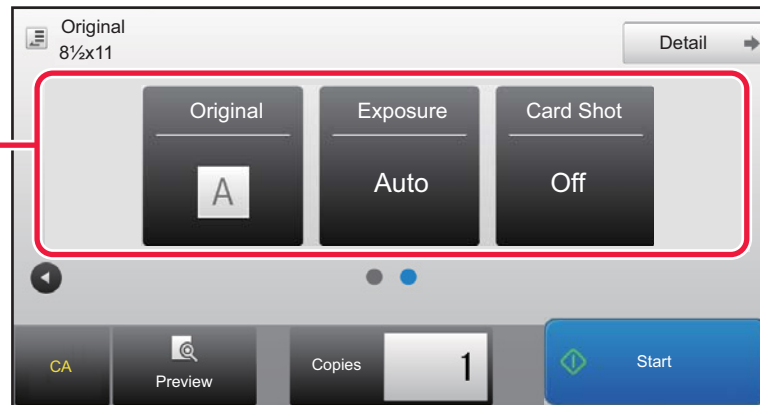

You can select these functions in easy mode.

- Paper Select ► [page 2-12](#)
- 2-Sided Copy ► [page 2-16](#)
- Copy Ratio ► [page 2-22](#)
- Staple / Punch ► [page 2-37](#), ► [page 2-41](#)
- Original ► [page 2-29](#)
- Exposure ► [page 2-19](#)
- N-Up ► [page 2-46](#)
- Card Shot ► [page 2-50](#)



#### • To select a function in easy mode

In "Settings (administrator)", select [System Settings] → [Common Settings] → [Operation Settings] → [Easy Mode Settings] → [Easy Copy].

#### • To cancel the warning message displayed when switching from easy mode to normal mode

In "Settings (administrator)", select [System Settings] → [Common Settings] → [Operation Settings] → [Easy Mode Settings] → [Display a Confirmation Message when Selecting "Detail" in Easy Modes] to disable this setting.



# NORMAL MODE

Normal mode lets you select any function setting that can be used for copying.

Enter the number of copies.

Setting keys used for copying.

Displays the list of function keys. Frequently used [Others], programs, and other settings can be registered.

Check the current settings.

Display keys other than the function keys indicated above.

Indicates the presence or absence of an original and the size of paper loaded in each tray. Tap to open the paper select screen.

Enter the number of copies.

Displays the functions that can be utilized in copy mode.

Scans the original and shows a preview image. [► PREVIEW SCREEN \(page 1-14\)](#)

Reset all settings.

Starts copying.

Starts proof copying.



The displayed contents of the above screen will vary depending on the devices installed.

# SELECTING COPY MODE

Change the copy mode to easy mode or normal mode as explained in "[CHANGING MODES \(page 1-13\)](#)".



# COPYING SEQUENCE

This section explains the basic procedure for copying. Select settings in the order shown below to ensure that the copy operation takes place smoothly.

For detailed procedures for selecting the settings, see the explanation of each setting in this chapter.



## You can also restore the default copy settings before executing copying

In "Settings (administrator)", select [System Settings] → [Copy Settings] → [Condition Settings] → [Auto Clear Before Copy Execution Also].

Enables the Auto Clear function during copy even when a copy job is not completed. This protects the machine from being held due to the incomplete copy job.

1

## Switch to copy mode.

► [SELECTING COPY MODE \(page 2-4\)](#)

2

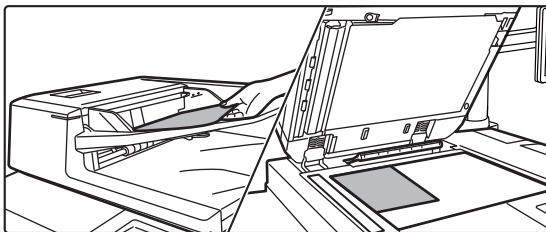

## Place the original.

Place the original in the document feeder tray of the automatic document feeder, or on the document glass.

► [AUTOMATIC DOCUMENT FEEDER \(page 1-116\)](#)

► [DOCUMENT GLASS \(page 1-120\)](#)



## Display Warning Message when Original is not Detected

In "Settings (administrator)", select [System Settings] → [Copy Settings] → [Condition Settings] → [Display Warning Message when Original is not Detected].



## 3

### Select functions.

Specify the original scan size, exposure, resolution, etc.

Tap the [Original] key and specify the orientation of the original to have the orientation be correctly recognized.

► [Specifying the orientation of the original \(page 2-29\)](#)

If necessary, you can refer to the following functions for the setting.

#### In Easy mode



- Paper Select ► [page 2-12](#)
- 2-Sided Copy ► [page 2-16](#)
- Copy Ratio ► [page 2-22](#)
- Staple / Punch ► [page 2-37](#), ► [page 2-41](#)
- Original ► [page 2-29](#)
- Exposure ► [page 2-19](#)
- N-Up ► [page 2-46](#)
- Card Shot ► [page 2-50](#)

#### In Normal mode

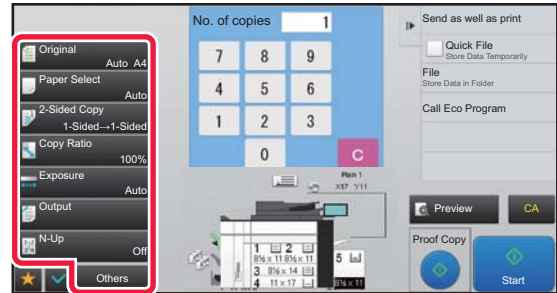

- Original ► [page 2-29](#)
- Paper Select ► [page 2-12](#)
- 2-Sided Copy ► [page 2-16](#)
- Copy Ratio ► [page 2-22](#)
- Exposure ► [page 2-19](#)
- Sort/Group ► [page 2-36](#)
- Others ► [page 2-59](#)

## 4

### Scan the original.

Tap the [Preview] key to scan the original.

#### In Easy mode

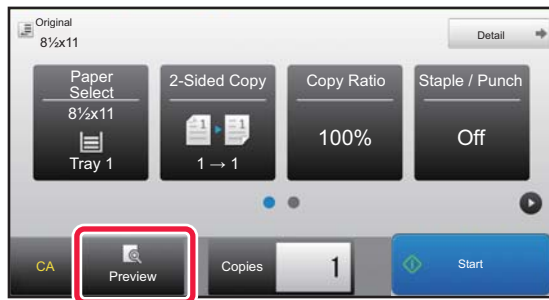

#### In Normal mode

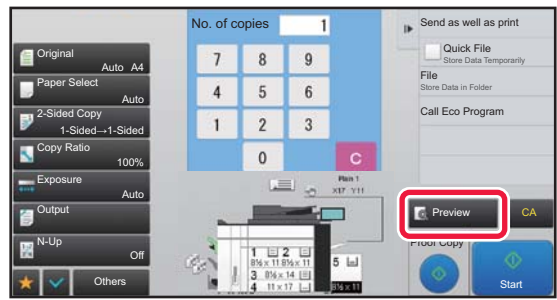

- To make 2-sided copies, configure the 2-sided copy settings before scanning the original.
  - [AUTOMATIC 2-SIDED COPYING \(page 2-16\)](#)
- When not checking the preview image, tap the [Start] key to start copying.



5

**Check the preview image.**

Display the preview image of the scanned original.  
In the preview screen, check the settings such as 2-sided copy.

► [COPY PREVIEW \(page 2-9\)](#)

**In Easy mode**

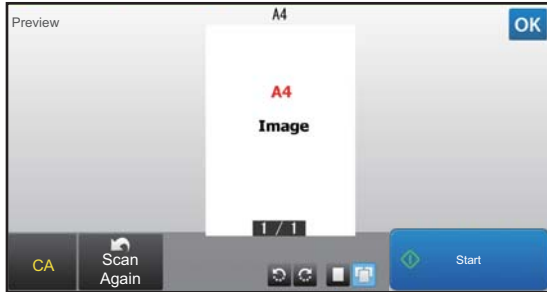

**In Normal mode**

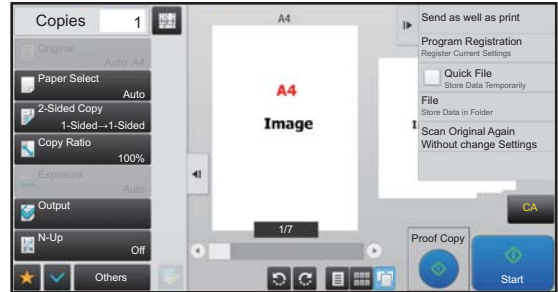

6

**Tap the [Start] key to start copying.**

When making only one set of copies, you do not need to specify the number of copies.



- To cancel all settings, tap the [CA] key.  
When the [CA] key is tapped, all settings selected to that point are cleared and you will return to the base screen.
- To cancel copying, tap the [Cancel Copy] key.



- **To make two or more sets of copies:**  
Tap the copies display key to specify the number of copies.

**In Easy mode**



**In Normal mode**

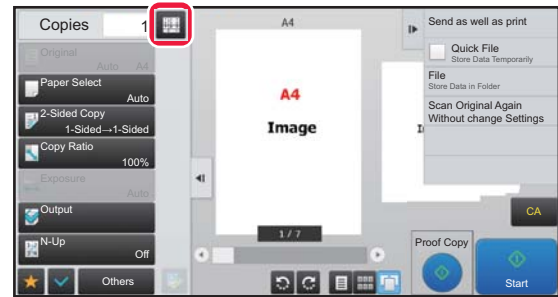

- In normal mode, you can tap [File] or [Quick File] on the action panel before starting the copy job to save the scanned original as a file.  
► [QUICK FILE \(page 5-9\)](#)  
► [FILE \(page 5-10\)](#)



**Setting a Maximum Number of Copies**

In "Settings (administrator)", select [System Settings] → [Copy Settings] → [Condition Settings] → [Setting a Maximum Number of Copies].

This is used to set the maximum number that can be entered for the number of copies (number of continuous copies). Any number from 1 to 9999 can be specified.



## Default settings for copying

Set in "Default Settings" of "Copy Settings" in the System Settings. You can set a default value for each copy setting. Initial Status Settings selected with these settings apply to all functions of the machine (not just the copy function). The copier settings are reset to the initial state when the [Power] button is turned on, when the [CA] key is tapped, or when the auto clear interval has elapsed. These settings are used to change the default settings for copy mode. The following settings can be changed:

| Item   | Description  |
|--|--|
| Image Orientation  | Specify the original orientation.  |
| Paper Tray   | Specify the paper tray that is selected by default.  |
| Exposure Type  | Configure default exposure mode settings.  |
| Copy Ratio   | Specify the copy ratio that is selected by default.  |
| Select magnification automatically according to paper size, when paper tray is selected. | Enable magnification automatically in default when changing the paper tray.  |
| 2-Sided Copy   | Configure the 2-sided mode settings that are selected by default. If this setting is used to change the default setting for the duplex function to any setting other than "1-Side to 1-Side" and the duplex function or automatic document feeder fails or is disabled, the setting will revert to "1-Side to 1-Side". |
| Original Binding   | Set the original binding in 2-Sided copy.  |
| Output Binding   | Set the output binding in 2-Sided copy.  |
| Output   | Set the print output method and output tray that are selected by default.  |
| Output Tray  | Specify the output tray.   |
| Offset   | Set whether or not offset is performed in the default settings.  |
| Separator Page   | Separator pages can be inserted before or after jobs. Set the paper tray used for the separator pages.   |
| Staple   | Configure staple settings  |
| Punch  | Configure punch settings   |
| Fold   | Configure fold settings  |
| Factory defaults   | This returns all items to the factory default settings.  |





# COPY PREVIEW

You can tap the [Preview] key before scanning the original to check a preview of the scanned image.

► [PREVIEW SCREEN \(page 1-14\)](#)



## In normal mode

While viewing the preview screen, you can adjust the exposure, and configure the preview in your image.

You can also drag the preview image to edit it, for example, changing, rotating, or deleting an original page.

► [MANUAL ADJUSTMENT OF EXPOSURE AND ORIGINAL TYPE \(page 2-19\)](#)

## In Easy mode

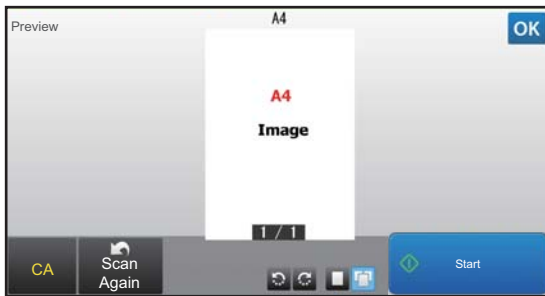

## In Normal mode

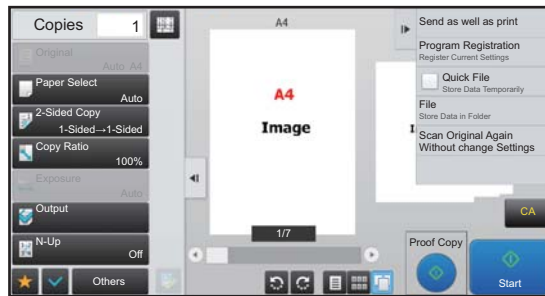



# CHECKING THE ORIGINAL SIZE

## Easy mode

The size of the placed original is displayed in the upper left corner of the screen.

When you place the original in the automatic document feeder, the original icon appears next to the original size.



## Normal mode

Check the size of the placed original on the display of the [Original] key.

If the original size is set to [Auto], the automatically detected size (standard size) is displayed. If the original size is specified manually, the specified original size is displayed.

When you place the original in the automatic document feeder, the original icon appears above the automatic document feeder.

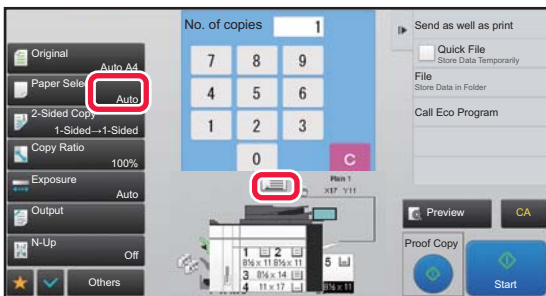

## Standard sizes

Standard sizes are sizes that the machine can automatically detect.

To specify the standard size, select [System Settings] in "Settings (administrator)" → [Common Settings] → [Device Control] → [Condition Settings] → [Original Size Detector Setting].

For standard sizes that can be detected, refer to [Original Size Detector Setting \(page 1-114\)](#).



- Even when [Original] is set to [Auto], some original sizes may be detected as other one that is near the standard size. In this case, manually set the original size.
  - ▶ [SELECTING THE ORIENTATION AND SIZE OF THE ORIGINAL \(page 2-29\)](#)
- When placing a non-standard size original on the document glass, you can make it easier for the size to be detected by placing a blank sheet of 8-1/2" x 11" (A4), 5-1/2" x 8-1/2" (B5), or other standard size of paper on top of the original.



## Orientation of placed original

Place the original as shown below.

If you place the original in an incorrect orientation, it may result in punching at an unexpected position or stapling. On "Preview Screen", view the image orientation or preview image.

► [COPY PREVIEW \(page 2-9\)](#)

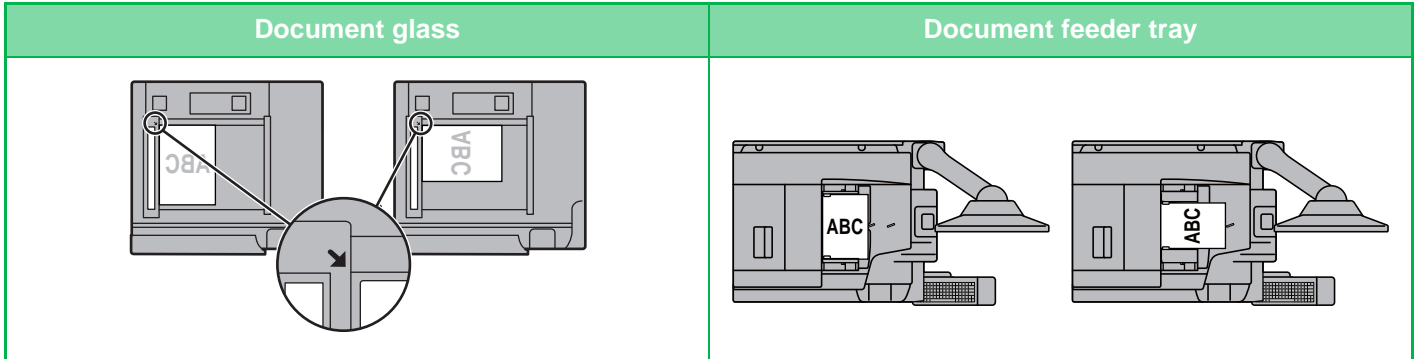

Set the orientation of the image to ensure that the orientation of the placed original is correctly recognized.

For information on the orientation of the original, see "[Specifying the orientation of the original \(page 2-29\)](#)".

## Automatic copy image rotation (Rotation Copy)

If the orientation is different between the original and paper, the original image will be automatically rotated 90 degrees to match the paper.

Orientation of placed original



The original seen from behind

Orientation of paper



The image is rotated 90 degrees



The paper seen from behind



### To set Rotation Copy:

In "Settings (administrator)", select [System Settings] → [Copy Settings] → [Condition Settings] → [Rotation Copy Setting]. When [Rotation Copy] is selected, Rotation Copy operates when Auto Paper Select or Auto Ratio Select is in effect, or when the original and paper are the same size but the orientation is different.

When [Rotation Copy is done only at Auto Paper Select or Auto Ration Select] is selected, Rotation Copy only operates when Auto Paper Select or Auto Ratio Select is in effect.



# SELECTING THE PAPER TRAY FOR COPYING

The machine is set to automatically select a tray that has the same size of paper as the size of the placed original (Auto Paper Select).

If the original size cannot be detected correctly because it is a non-standard size or when you want to change the paper size for copying, you can select the paper tray manually.



- If the selected tray runs out of paper during a copy job and there is another tray that has the same size and type of paper, that tray will be automatically selected and the copy job will continue.
- If a suitable size of copy paper is not loaded, copying may stop.



## • To change the initially selected tray:

In "Settings (administrator)", select [System Settings] → [Copy Settings] → [Initial Status Settings] → [Paper Tray].

## • Stop auto paper selection

In "Settings (administrator)", select [System Settings] → [Copy Settings] → [Common Settings] → [Disabling of Auto Paper Selection]

The same size of paper will not be automatically selected when an original is placed on the document glass or the document tray of the Single Pass Feeder.

## • Automatically select the tray used for paper feeding

In "Settings (administrator)", select [System Settings] → [Copy Settings] → [Common Settings] → [Auto Selection Setting of Tray that is Supplied the Paper]

When this setting is enabled and paper is loaded into a tray while the machine is on standby in copy mode, that tray is automatically selected.

1

## Tap the [Paper Select] key.

► [COPYING SEQUENCE \(page 2-5\)](#)

2

## Tap the required tray key.

After the settings are completed, tap **OK**.

### In Easy mode

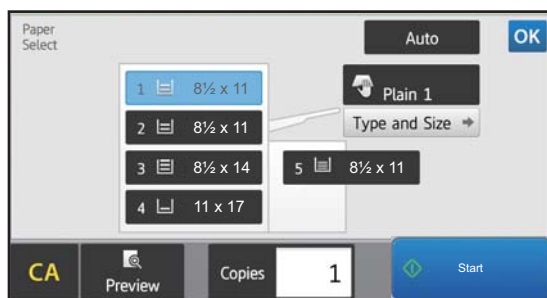

### In Normal mode

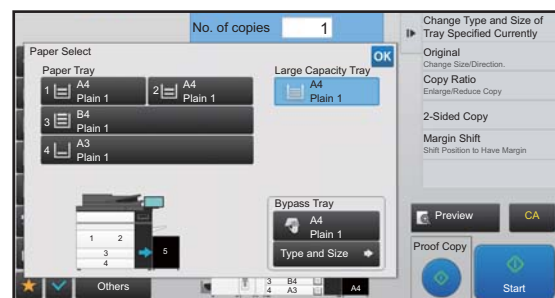

- When the bypass tray is selected, specify the paper type and size based on the paper loaded into the bypass tray.
  - [SPECIFYING A TYPE AND SIZE OF PAPER LOADED ON BYPASS TRAY \(page 2-35\)](#)
- In normal mode, you can also open the [Paper Select] screen by tapping the machine image on the base screen.



To automatically select the tray, tap the [Auto] key.



# BASIC PROCEDURE FOR MAKING COPIES

This section explains how to select settings from the base screen of easy mode.

► [SELECTING COPY MODE \(page 2-4\)](#)

## COPYING

### USING THE AUTOMATIC DOCUMENT FEEDER FOR COPYING

**1**

Place the original in the document feeder tray of the automatic document feeder.

► [AUTOMATIC DOCUMENT FEEDER \(page 1-116\)](#)

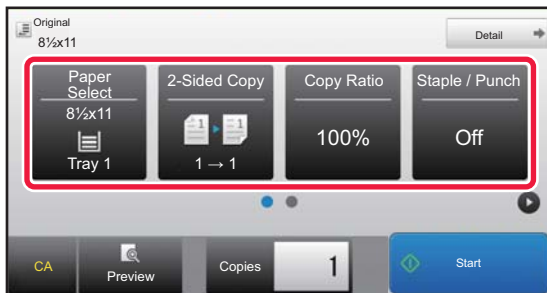
**2**

Check the paper (tray) you want to use for copying, and tap the keys for any other settings you want to select.

- Paper Select ► [page 2-12](#)
- 2-Sided Copy ► [page 2-16](#)
- Copy Ratio ► [page 2-22](#)
- Staple / Punch ► [page 2-37](#), ► [page 2-41](#)
- Original ► [page 2-29](#)
- Exposure ► [page 2-19](#)
- N-Up ► [page 2-46](#)
- Card Shot ► [page 2-50](#)



Depending on the size of the placed original, there may be cases where the same size of paper as the original is not selected automatically. In this event, change the paper tray manually.

**3**

Tap the [Preview] key.

► [PREVIEW SCREEN \(page 1-14\)](#)



4

**Tap the [Start] key to start copying.**

When making only one set of copies, you do not need to specify the number of copies.



**To make two or more sets of copies:**

Tap the number of copies key to specify the number of copies.

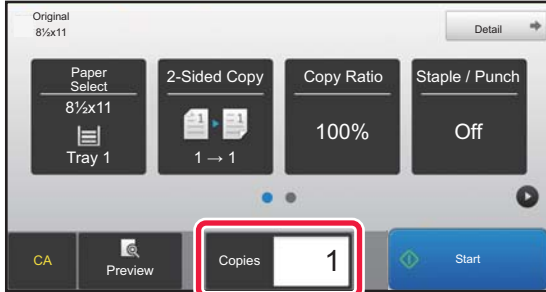

## USING THE DOCUMENT GLASS FOR COPYING

1

**Place the original on the document glass.**

► [DOCUMENT GLASS \(page 1-120\)](#)

2



**Check the paper (tray) you want to use for copying, and tap the keys for any other settings you want to select.**

- Paper Select ► [page 2-12](#)
- 2-Sided Copy ► [page 2-16](#)
- Copy Ratio ► [page 2-22](#)
- Staple / Punch ► [page 2-37](#), ► [page 2-41](#)
- Original ► [page 2-29](#)
- Exposure ► [page 2-19](#)
- N-Up ► [page 2-46](#)
- Card Shot ► [page 2-50](#)

3

**Tap the [Preview] key.**

► [PREVIEW SCREEN \(page 1-14\)](#)



4

**Tap the [Start] key to start copying.**

When making only one set of copies, you do not need to specify the number of copies.



**To make two or more sets of copies:**

Tap the number of copies key to specify the number of copies.

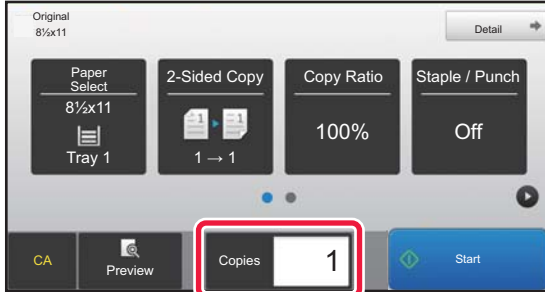



# AUTOMATIC 2-SIDED COPYING

## USING THE AUTOMATIC DOCUMENT FEEDER FOR 2-SIDED COPYING

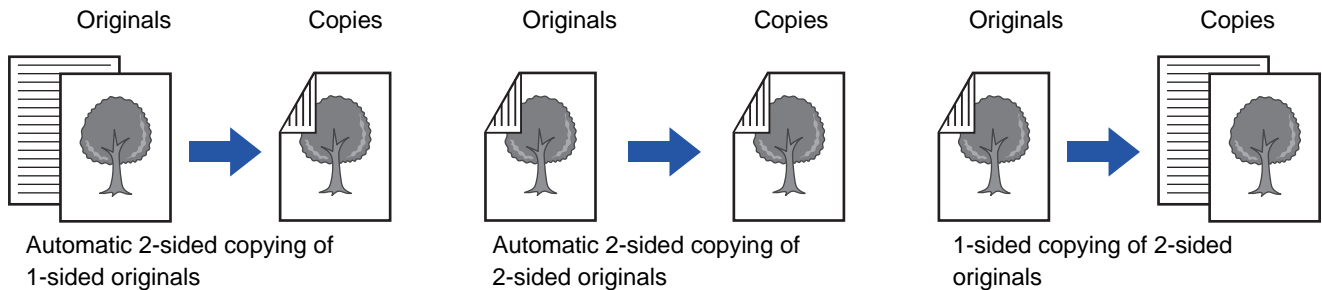

- To make 2-sided copies, configure the 2-sided copy settings before scanning the original.
- Dual-side copy helps to save paper.

1

**Place the original in the document feeder tray of the automatic document feeder.**

► [AUTOMATIC DOCUMENT FEEDER \(page 1-116\)](#)

2

**Tap the [2-Sided Copy] key.**

► [COPYING SEQUENCE \(page 2-5\)](#)

3

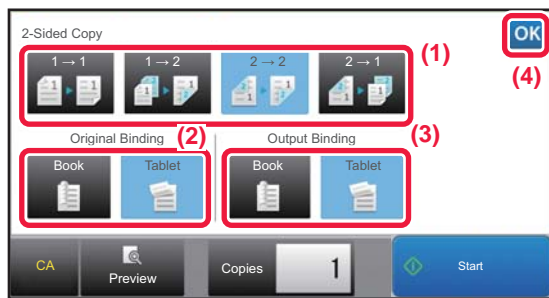

**Select 2-sided copy mode.**

- (1) Select the 2-sided copy type.
- (2) When the original is set to "2-Sided", select "Tablet" or "Book" in "Original Binding".
- (3) When the output is set to "2-Sided", select "Tablet" or "Book" in "Output Binding".
- (4) After the settings are completed, tap **OK**.

4

**Check the paper (tray) you want to use for copying, and tap the keys for any other settings you want to select.**

Tap the [Original] key and specify the orientation of the original to have the orientation be correctly recognized.

► [Specifying the orientation of the original \(page 2-29\)](#)

- Paper Select ► [page 2-12](#)
- Copy Ratio ► [page 2-22](#)
- Staple / Punch ► [page 2-37](#), ► [page 2-41](#)
- Original ► [page 2-29](#)
- Exposure ► [page 2-19](#)
- N-Up ► [page 2-46](#)
- Card Shot ► [page 2-50](#)





5

Tap the [Preview] key.

6

Tap the [Start] key to start copying.

## USING THE DOCUMENT GLASS FOR 2-SIDED COPYING

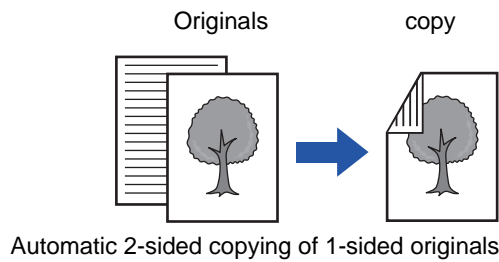

Dual-side copy helps to save paper.



**To change the default 2-sided copy mode:**

In "Settings (administrator)", select [System Settings] → [Copy Settings] → [Initial Status Settings] → [2-Sided Copy].

1

Place the original on the document glass.

► [DOCUMENT GLASS \(page 1-120\)](#)

2

Tap the [2-Sided Copy] key.

► [COPYING SEQUENCE \(page 2-5\)](#)

3

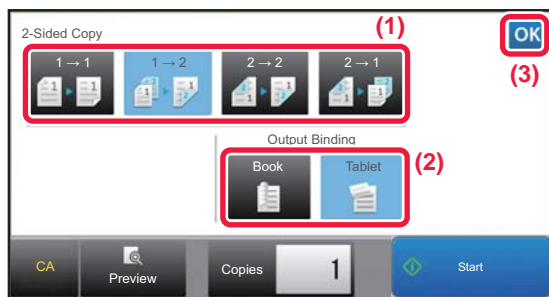

Select the 2-sided copy mode.

(1) Tap the [1 → 2] key.

(2) When the output is set to "2-Sided", select "Tablet" or "Book" in "Output Binding".

(3) After the settings are completed, tap **OK**.



The [2 → 2] key and [1 → 2] key cannot be used when copying from the document glass.



4

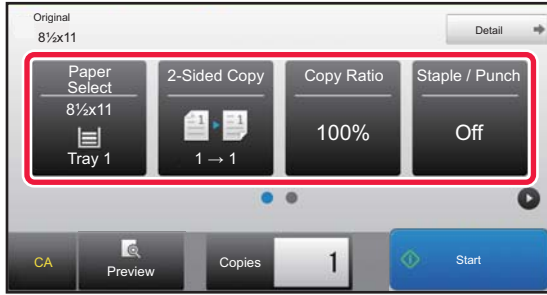

**Check the paper (tray) you want to use for copying, and tap the keys for any other settings you want to select.**

Tap the [Original] key and specify the orientation of the original to have the orientation be correctly recognized.

▶ [Specifying the orientation of the original \(page 2-29\)](#)

- Paper Select ▶ [page 2-12](#)
- Copy Ratio ▶ [page 2-22](#)
- Staple / Punch ▶ [page 2-37](#), ▶ [page 2-41](#)
- Original ▶ [page 2-29](#)
- Exposure ▶ [page 2-19](#)
- N-Up ▶ [page 2-46](#)
- Card Shot ▶ [page 2-50](#)



Depending on the size of the placed original, there may be cases where the same size of paper as the original is not selected automatically. In this event, change the paper tray manually.

5

**Tap the [Start] key.**

6



**Set the next original, and tap the [Start] key to scan the original.**

Tap the same key you tapped in step 5.

Repeat this step until all originals have been scanned.

7

**Tap the [Read-End] key to start copying.**



# CHANGING THE EXPOSURE AND ORIGINAL IMAGE TYPE

## AUTOMATIC ADJUSTMENT OF EXPOSURE AND ORIGINAL TYPE

Automatic exposure adjustment operates by default to automatically adjust the exposure level and original type as appropriate for the original being copied. ([Auto] is displayed.)

This function automatically adjusts the image during copying to obtain the most suitable copy.



- **To change the default exposure:**

In "Settings (administrator)", select [System Settings] → [Copy Settings] → [Initial Status Settings] → [Exposure Type].

- **To adjust the exposure level when [Auto] is used for the copy exposure:**

In "Settings (administrator)", select [System Settings] → [Image Quality Adjustment] → [Copy Image Quality] → [Density Adjustment when [Auto] is selected for Exposure].

## MANUAL ADJUSTMENT OF EXPOSURE AND ORIGINAL TYPE

This section explains how to select the original type depending on the original to be copied or manually adjust the exposure.



- **To change the default exposure:**

In "Settings (administrator)", select [System Settings] → [Copy Settings] → [Initial Status Settings] → [Exposure Type].

1

**Tap the [Exposure] key.**

► [COPY MODE \(page 2-3\)](#)



2

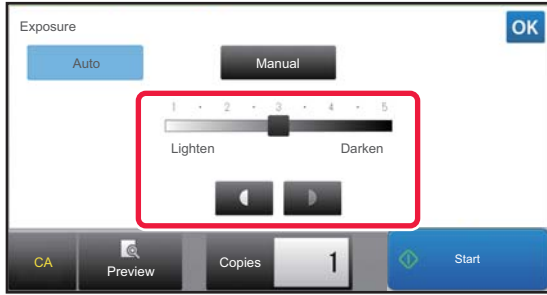

Tap or slide the slider to adjust the copy exposure.

After the adjustment, tap .

This completes the procedure in easy mode.

3

To select more detailed settings, tap the [Detail] key to switch to normal mode.

► [CHANGING MODES \(page 1-13\)](#)

4

Tap the [Exposure] key.

5



Tap the required original image type key to specify the original type.

Tap the key matching the original.

### Original image type select keys

- Text ..... Use this mode for regular text documents.
- Text/Printed Photo ..... This mode provides the best balance for copying an original which contains both text and printed photographs, such as a magazine or catalogue.
- Text/Photo ..... This mode provides the best balance for copying an original which contains both text and photographs, such as a text document with a photo pasted on.
- Printed Photo ..... This mode is best for copying printed photographs, such as photos in a magazine or catalogue.
- Photo ..... Use this mode to copy photos.
- Map ..... This mode is best for copying the light color shading and fine text found on most maps.
- Light Original ..... Use this mode for originals with light pencil writing.



- When using a copy or printed page from the machine as an original:  
When using a copy or printed page from the machine as an original, tap the [Copy of Copy] checkbox so that  appears.  
[Copy of Copy] is available when [Auto], [Text], [Printed Photo], or [Text/Printed Photo] is selected as the original image type.
- When you want to make fluorescent marker parts more visible  
When using a page with highlited lines as an original, tap the [Copy Original with Highlighted Lines] checkbox so that  appears.



- [Copy of Copy] cannot be combined with [Intensity] in "Others".

## 6



**Tap or slide the slider to adjust the copy exposure.**

If you adjust the exposure with the original type selected to [Auto], the original image type is automatically selected to [Text/Printed Photo].

After the adjustment, tap  .



Guidelines for the exposure level when [Text] is selected for "Exposure/Original Type"

- 1 to 2: Dark originals such as a newspaper
- 3: Normal density originals
- 4 to 5: Originals written in pencil or light colored text



# ENLARGE/REDUCE

## AUTO RATIO SELECT

This section explains how to automatically select the appropriate ratio to meet the paper size when manually changing the paper tray to make a copy on paper that has a size different from the original.



For a non-standard size original, the size must be entered in order to use Auto Image.



### To change the default ratio:

In "Settings (administrator)", select [System Settings] → [Copy Settings] → [Initial Status Settings] → [Copy Ratio].

# 1

## Manually select the paper tray, and place the original.

Place the original in the document feeder tray of the automatic document feeder, or on the document glass.

- ▶ [SELECTING THE PAPER TRAY FOR COPYING \(page 2-12\)](#)
- ▶ [AUTOMATIC DOCUMENT FEEDER \(page 1-116\)](#)
- ▶ [DOCUMENT GLASS \(page 1-120\)](#)

# 2

## Tap the [Copy Ratio] key.

- ▶ [COPY MODE \(page 2-3\)](#)

# 3



## Tap the [Auto Image] key.

The reduction or enlargement ratio is automatically selected based on the original size and the selected paper size. The automatically selected ratio will appear in the ratio display.



### To cancel the Auto Ratio Selection setting:

Tap [Auto Image] to deselect it.

### To return the ratio to 100%:

Tap the [100%] key.



## MANUAL RATIO SELECTION

This section explains how to specify any ratio when making a copy on paper that has a size different from the original or changing the image size for copying.

The following three methods can be used to specify the ratio.

### Using the preset ratio key

Specify any ratio by combination of preset ratio key, for which the enlargement and reduction ratio values are pre-registered between the frequently used standard sizes, with the zoom key, which allows you to adjust the ratio in 1% units like .

Up to two ratio values can be added to preset ratio keys, respectively for enlargement and reduction.

### Specifying the paper size

Specify the paper sizes of the original and output to automatically obtain the appropriate ratio.

Original size: 11" x 17"

Copy size: 8-1/2" x 11"

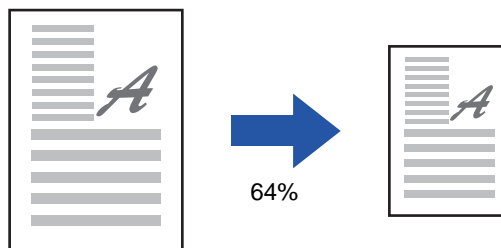

### Specifying the image dimensions

Specify the image sizes of the original and output to automatically obtain the appropriate ratio.

To make a copy with the same ratio between the vertical and horizontal sizes, enter either one of the vertical and horizontal sizes.

Image size: 90mm

Output size: 135mm

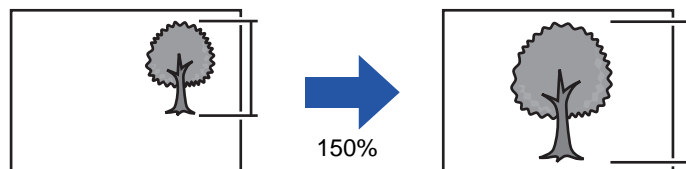

When the automatic document feeder is used, the vertical and horizontal ratio selection ranges are both between 25% to 200%.



#### To return the ratio to 100%:

Tap the [100%] key.



#### To add any ratio as a preset ratio:

You can set two additional preset ratios for both enlargement (101% to 400%) and reduction (25% to 99%). Preset ratios other than the ratios added with "Add or Change Extra Preset Ratios" cannot be changed.

In "Settings (administrator)", select [System Settings] → [Copy Settings] → [Condition Settings] → [Add or Change Extra Preset Ratios]. To select the added preset ratio, tap the [Other Ratio] key.



## Using the preset ratio key

1

Tap the [Copy Ratio] key.

▶ [COPY MODE \(page 2-3\)](#)

2

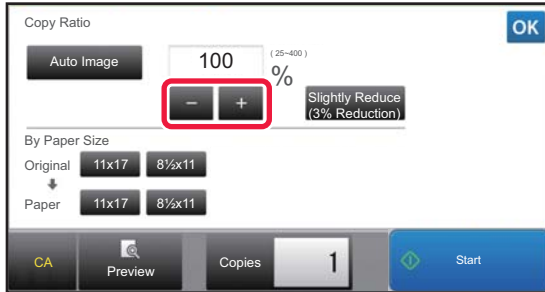

Tap **- +** to set the ratio.

After the settings are completed, tap **OK**.

Check that a paper size suitable for the ratio is selected.



- If you tap the [Slightly Reduce (3% Reduction)] key, the ratio will be set lower than the specified one by 3%.

### In normal mode

- There are two setting screens. Use the [Other Ratio] key to switch between the screens.
- To quickly set the area, first specify a value close to the desired value by the numeric keys, then adjust it with **- +**.
- Up to two frequently used ratio values can be added to the preset ratio key, respectively for enlargement and reduction.



### To cancel all settings:

Tap the [CA] key.

## Specifying the paper size

1

Tap the [Copy Ratio] key.

▶ [COPY MODE \(page 2-3\)](#)

2



Specify the original size (paper size of the loaded original) and the copy size (paper size of the copy output).

After the settings are completed, tap **OK**.



### To cancel all settings:

Tap the [CA] key.





## Specifying the image dimensions

1

Tap the [Detail] key to change to normal mode.

▶ [CHANGING MODES \(page 1-13\)](#)

2

Tap the [Copy Ratio] key.

3

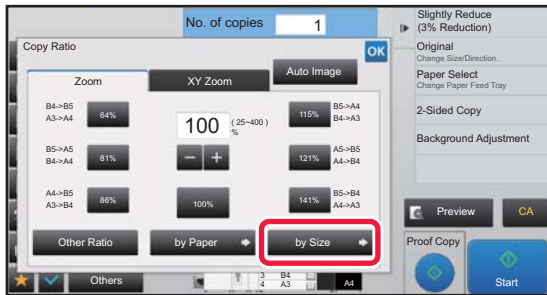

Tap the [by Size] key of the [Zoom] tab.

4

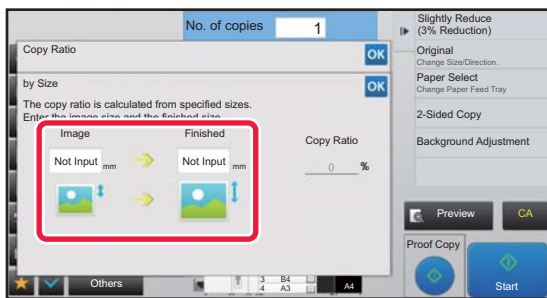

Specify the image size (dimensions of the image to be enlarged or reduced) and the output size (dimensions of the enlarged and reduced images).

Tap the area of image size and output size, and enter the sizes using the numeric keys.

After the settings are completed, tap **OK**.



• **If you have entered an incorrect size:**

Tap the [C] key on the numeric keys that appears when you tap the entry area, and set to the correct size.

• **To cancel all settings:**

Tap the [CA] key.



## ENLARGING/REDUCING THE LENGTH AND WIDTH SEPARATELY

This section explains how to individually specify the horizontal and vertical copy ratios.

**When 50% is selected for the horizontal ratio and 70% is selected for the vertical ratio**

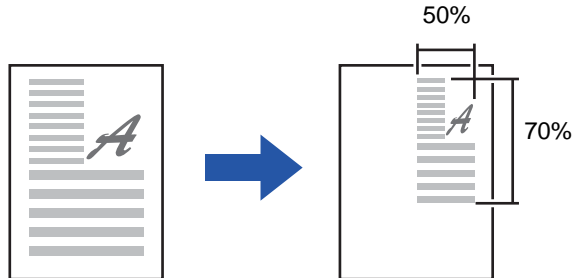

The following two methods can be used to specify the ratio.

### Using the preset ratio key

Specify any ratio by combination of preset ratio key, which is pre-registered, with the **- +** key, which allows you to adjust the ratio in 1% units.

### Specifying the image dimensions

Specify the image sizes of the original and output to automatically obtain the appropriate ratio.

Enter the vertical and horizontal sizes.



When the automatic document feeder is used, the vertical and horizontal ratio selection ranges are both between 25% to 200%.



**To cancel the XY zoom setting:**  
Tap the [Zoom] tab or the [CA] key.



## Using the preset ratio key

1

Tap the [Detail] key to change to normal mode.

► [CHANGING MODES \(page 1-13\)](#)

2

Tap the [Copy Ratio] key, and then tap the [XY Zoom] tab.

3

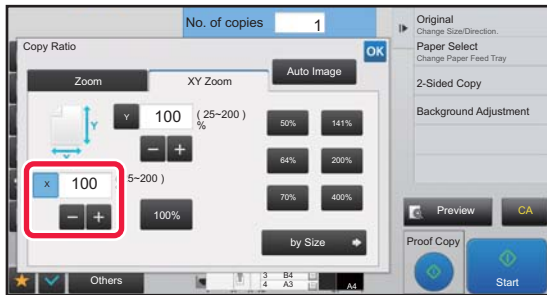

Tap the [X] key, and set the X (horizontal) ratio.



- To quickly set the ratio, first specify a value close to the desired one, then adjust it with **-** **+**.
- Tap each area of the X (horizontal) and Y (vertical) directions, and enter the sizes using the numeric keys.

4

Tap the [Y] key, and set the Y (vertical) ratio in the same way as the [X] key.

After the settings are completed, tap **OK**.

Check that a paper size suitable for the ratio is selected.



## Specifying the image dimensions

1

Perform steps 1 to 2 in [Using the preset ratio key \(page 2-24\)](#).

2

Tap the [by Size] key.

3

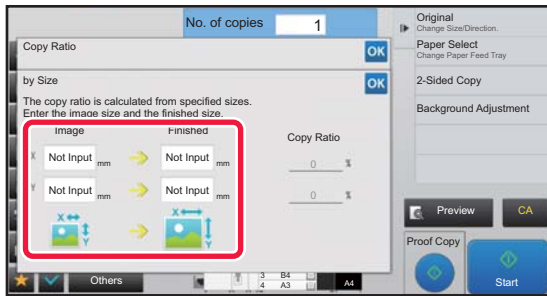

**Specify the X and Y dimensions of the image size and those of the output size.**

Check that a paper size suitable for the ratio is selected. After the settings are completed, tap **OK**.



Tap the image size and output size areas, and enter the sizes using the numeric keys.



- **If you have entered an incorrect size:**  
Tap the [C] key on the numeric keys that appears when you tap the entry area, and set to the correct size.
- **To cancel all settings:**  
Tap the [CA] key.



# SELECTING THE ORIENTATION AND SIZE OF THE ORIGINAL

When the original size is a non-standard size or is not detected correctly, manually specify the original size. Set the orientation of the image to ensure that the orientation of the placed original is correctly recognized.



- Set the orientation and size of the original before scanning the original.
- The original size is set in normal mode.

## Specifying the orientation of the original

By specifying the starting side (top or left side) of the placed original, the orientation of the original will be correctly recognized.

Finishing position settings and N-Up layout settings are specified using the recognized orientation.

### In Easy mode

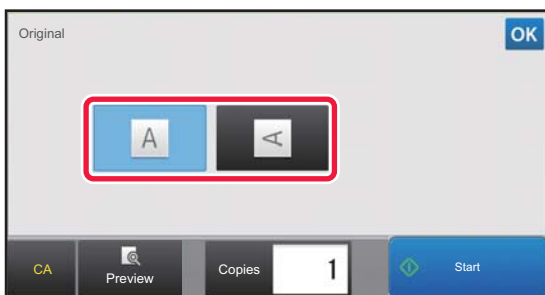

### In Normal mode

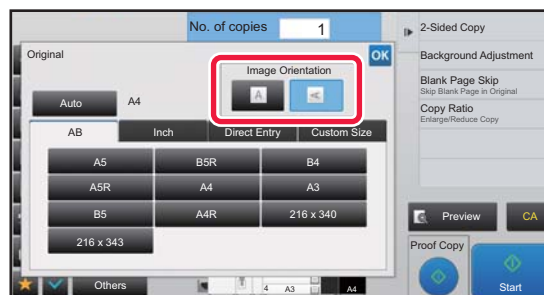

## Specify the orientation and size of the original

**1**

Tap the [Original] key to set the orientation of the original.

► [COPY MODE \(page 2-3\)](#)

**2**

If you want to specify the size, tap the [Detail] key and change to normal mode.

► [CHANGING MODES \(page 1-13\)](#)

**3**

Tap the [Original] key.

**4**

Tap the [AB] tab or the [Inch] tab.



5

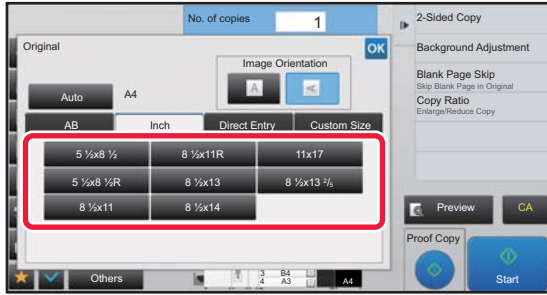

**Tap the appropriate original size key.**

After the settings are completed, tap **OK**.

## Specifying the orientation and size of a non-standard size originals

1

**Tap the [Original] key to set the orientation of the original.**

▶ [COPY MODE \(page 2-3\)](#)

2

**Tap the [Detail] key to change to normal mode.**

▶ [CHANGING MODES \(page 1-13\)](#)

3

**Tap the [Original] key.**

4

**Tap the [Direct Entry] tab.**

5

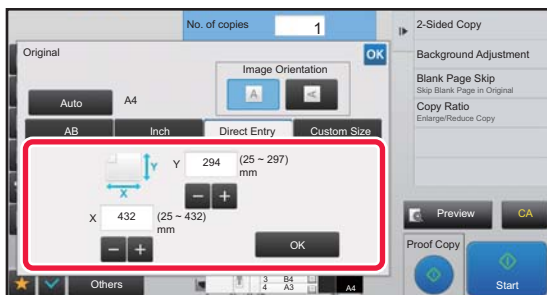

**Specify the original size.**



- Tap the areas displaying width and height sizes respectively, and enter the sizes using the numeric keys.
- It is convenient to use **- +** to finely adjust the entered size.

6

**Tap the [Execute] key.**

On the base screen, check that the specified size is displayed on the [Original] key.

After the settings are completed, tap **OK**.



# STORING FREQUENTLY USED ORIGINAL SIZES

Store the frequently used non-standard original sizes. This section explains how to store, retrieve, change, and delete non-standard original sizes.



- The stored original size will be retained even if the main power is turned off.
- A total of up to 12 non-standard original sizes can be registered for copying and image sending.
- The added original sizes will also appear in other modes.

## Storing original sizes (Modify/Delete)

1

Tap the [Detail] key to change to normal mode.

► [CHANGING MODES \(page 1-13\)](#)

2

Tap the [Original] key.

3

Tap the [Custom Size] tab.

4

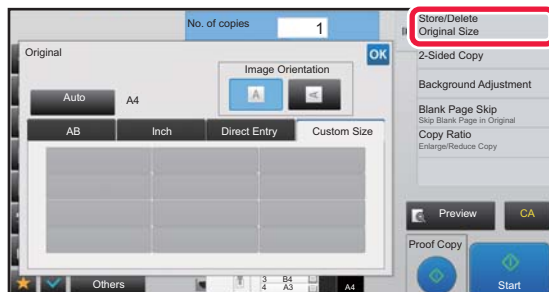

Tap [Store/Delete Original Size] on the action panel.



5

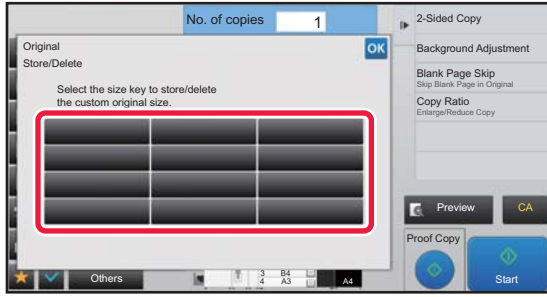

Tap a key ( ) for storing a custom original size.

Tap a key that does not show a size.



**To modify or delete a previously stored key:**

Tap the key that you want to modify or delete. The following screen will appear.

- To modify the key, tap the [Modify] key and go to the next step.
- To delete the key, tap the [Delete] key. Make sure that the original size has been cleared and tap the **OK** key.

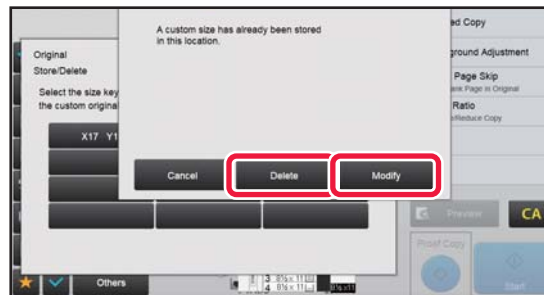

6

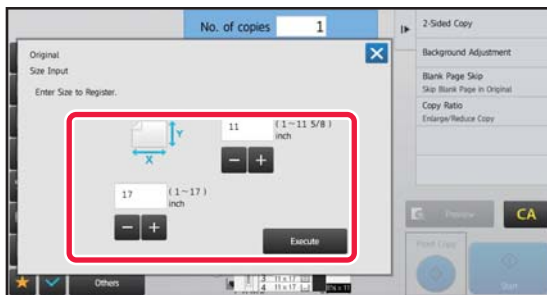

**Specify the original size.**

Tap the areas displaying width and height sizes respectively, and enter the sizes using the numeric keys.



It is convenient to use **- +** to finely adjust the entered size.

7

**Tap the [Execute] key**

After the settings are completed, tap the **X** key, and check that the key of the size stored on the original screen is added properly. After you have checked it, tap **OK**.



**To cancel the operation:**

Tap the [CA] key.





## Retrieving a stored original size

1

Perform steps 1 to 3 in [Storing original sizes \(Modify/Delete\) \(page 2-31\)](#).

2

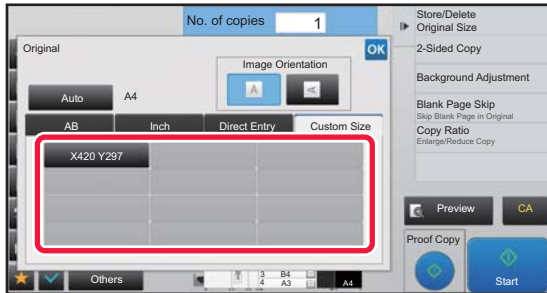

**Tap the key of the original size that you wish to retrieve.**

After selecting the key of the original size, tap the **OK** key. On the base screen, check that the specified size is displayed on the [Original] key.



**To cancel the operation**  
Tap the [CA] key.



# MAKING COPIES USING THE BYPASS TRAY

## MAKING COPIES USING THE BYPASS TRAY

In addition to plain paper, the bypass tray allows you to make copies on transparency film, tab paper, and other special media.



For detailed information on paper that can be loaded into the bypass tray, see "[APPLICABLE PAPER TYPES \(page 1-86\)](#)". For precautions on loading paper into the bypass tray, see "[LOADING PAPER INTO THE BYPASS TRAY \(page 1-104\)](#)".



### Prohibit feeding of paper from the bypass tray when performing duplex copy.

In "Settings (administrator)", select [System Settings] → [Copy Settings] → [Condition Settings] → [Disabling of Bypass-Tray in Duplex Copy].

Disables the use of the bypass tray when making 2-sided copies.

The bypass tray is often used to feed label sheets, transparency film, and other special media for which 2-sided copying is prohibited. If a sheet of one of these special media enters the reversing unit, a misfeed or damage to the unit may result. If special media for which 2-sided copying is prohibited is often used, it is recommended that you enable this setting.

**1**

### Load paper into the bypass tray.

► [LOADING PAPER INTO THE BYPASS TRAY \(page 1-104\)](#)

**2**

### Tap the [Paper Select] key, and tap the bypass tray key.

Each tray key displays the size and type of the loaded paper.

► [SELECTING THE PAPER TRAY FOR COPYING \(page 2-12\)](#)

**3**

### To select more detailed settings, tap the [Detail] key to switch to normal mode.

► [CHANGING MODES \(page 1-13\)](#)

**4**

### Tap the [Paper Select] key.

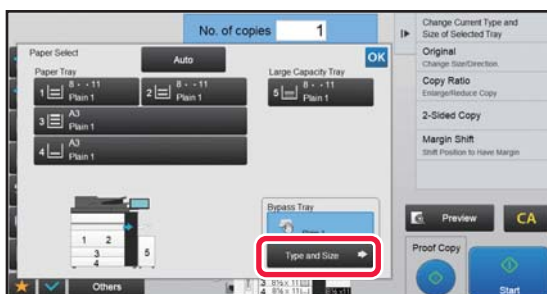
**5**

### Tap the [Type and Size] key, and select the size and type of the paper.

► [SPECIFYING A TYPE AND SIZE OF PAPER LOADED ON BYPASS TRAY \(page 2-35\)](#)

**6**

### Place the original.

Place the original in the document feeder tray of the automatic document feeder, or on the document glass.

► [AUTOMATIC DOCUMENT FEEDER \(page 1-116\)](#)

► [DOCUMENT GLASS \(page 1-120\)](#)



7

Tap the [Start] key to start copying.

## SPECIFYING A TYPE AND SIZE OF PAPER LOADED ON BYPASS TRAY

1

Tap the [Paper Select] key, and tap the bypass tray key.

▶ [SELECTING THE PAPER TRAY FOR COPYING \(page 2-12\)](#)

2

Tap the [Type and Size] key, and tap the key that meets the type of the loaded paper.

3

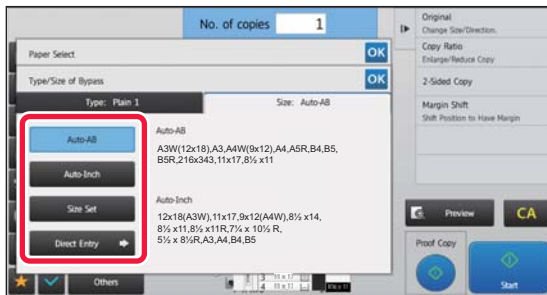

Tap the [Size] tab, and tap the key that meets the size of the loaded paper.

- **[Auto-AB] key:**  
Automatically detects the appropriate AB paper size when loading paper such as A4 or B5.
- **[Auto-Inch] key:**  
Automatically detects the appropriate inch paper size when loading paper such as 8-1/2"x11".
- **[Size Set] key:**  
Tap this key to manually specify the paper size that is not detected automatically.
- **[Direct Entry] key:**  
Tap this key to enter a numeric value for the size of the loaded paper.

After the settings are completed, tap **OK**.



### To directly enter a paper size

Tap the [inch] key to set a paper size in inches, or tap the [AB] key to set it in millimeters.  
After you have entered the paper size using the **- +** key, tap the [Execute] key.

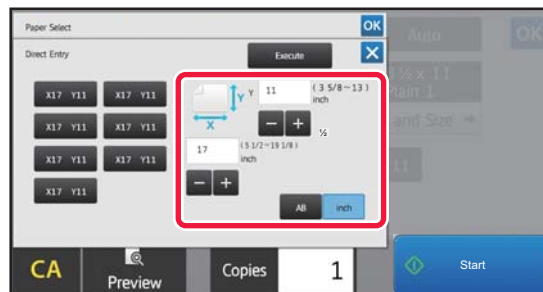



# OUTPUT

## SORT/GROUP SETTING

This section explains how to select the sorting method when outputting the scanned original.

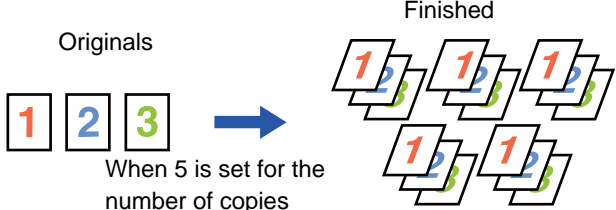
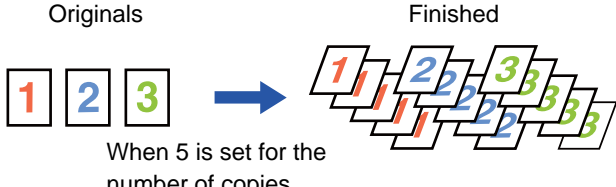
|       |   |  |
|-------|---|--|
| Auto  | Enables the sort mode when the original is placed in the automatic document feeder, and enables the group mode when the original is placed on the document glass. |  |
| Sort  | Sorts the scanned original on a set basis, and outputs them.  |  <p>Originals: 1 2 3<br/>When 5 is set for the number of copies</p> <p>Finished</p>  |
| Group | Groups the scanned original on a page basis, and outputs them.  |  <p>Originals: 1 2 3<br/>When 5 is set for the number of copies</p> <p>Finished</p> |

1

### Tap the [Detail] key to change to normal mode.

► [CHANGING MODES \(page 1-13\)](#)



Tap the [Original] key and specify the orientation of the original to have the orientation be correctly recognized.

► [Specifying the orientation of the original \(page 2-29\)](#)

2

### Tap the [Sort/Group] key.



If a finisher or saddle stitch finisher is installed, tap the [Sort/ Group] key in [Others].

3

### Select the sorting method.

After the settings are completed, tap **OK**.













- You can select the offset output checkbox  to have each set of output be offset from the previous set to enable easy removal from the output tray.
- To change the output tray, tap the [Output Tray] key, and select the output destination.

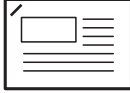
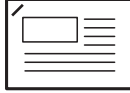

# STAPLE SETTINGS

Specify whether or not the set of output will be stapled.

| Original Orientation  | Staple    | Staple Position   |   |   |
|-----------------------|-----------|---|---|---|
|                       |           | Left  | Top   | Right   |
| -                     | OFF       | Does not staple.  |   |   |
| Portrait orientation  | 1 Staples |    |    |    |
|                       | 2 Staples |    |    |    |
| Landscape orientation | 1 Staples |    |    |    |
|                       | 2 Staples |  |  |  |



- You can view staple positions on the "[PREVIEW SCREEN \(page 1-14\)](#)". Text will be printed at the preset size regardless of the copy ratio or paper size setting.
- To change the default staple position:  
In "Settings (administrator)", select [System Settings] → [Copy Settings] → [Initial Status Settings] → [Staple Position].



- A finisher, finisher (large stacker), or saddle stitch finisher (large stacker) is required to use the staple function.
- A saddle stitch finisher (large stacker) is required to use the saddle stitch function.



## Staple ON (excluding booklet)

1

Tap the [Staple / Punch] key.

▶ [COPY MODE \(page 2-3\)](#)



Tap the [Original] key and specify the orientation of the original to have the orientation be correctly recognized.

▶ [Specifying the orientation of the original \(page 2-29\)](#)

2

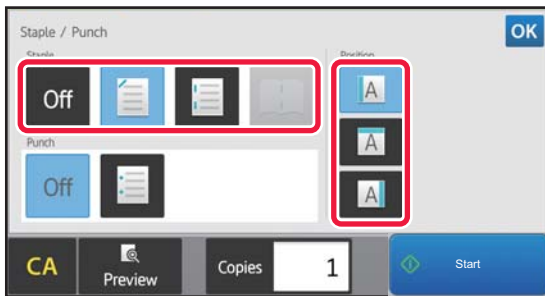

**Select the number of staples and staple position.**

• After the settings are completed, tap **OK**.



**In normal mode**

• Tap the [Output] key, and tap the [Staple] tab.

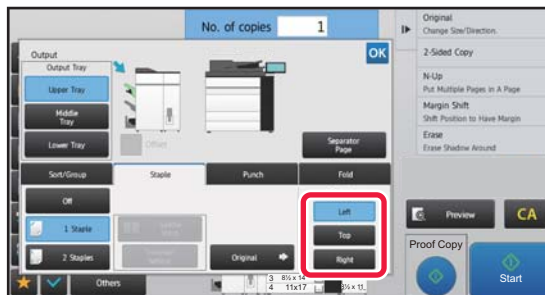

- If you need to change the output tray, select the output destination before selecting stapling.
- If the number of scanned originals exceeds the staple sheet limit, a message is displayed. Tap [Continue] or [Cancel].  
[Continue]: Continues sorting without stapling.  
[Cancel]: Cancels the staple sort setting.



## Saddle Stitch

**1**

### Tap the [Staple / Punch] key.

► [COPY MODE \(page 2-3\)](#)



Tap the [Original] key and specify the orientation of the original to have the orientation be correctly recognized.

► [Specifying the orientation of the original \(page 2-29\)](#)

**2**

### Select .

After the settings are completed, tap .

**3**

### Select binding edge and original settings.

► [MAKING COPIES IN PAMPHLET FORMAT \(BOOKLET\) \(page 2-59\)](#)

After the settings are completed, tap .



#### In normal mode

- If you need to change the output tray, tap the [Output Tray] key and select the output destination before selecting stapling.
- If [Booklet] is already specified in [Others], you do not need configure binding edge and cover settings.
- If [Booklet] is specified in [Others], the saddle stitch screen appears. Confirm the message shown on the screen, and tap the [On] key. (If you select "Settings (administrator)" → [System Settings] → [Copy Settings] → [Condition Settings] or "Settings (administrator)" → [Device Control] → [Condition Settings], then set the [Automatic Saddle Stitch] check box to )
- If the number of scanned originals exceeds the staple sheet limit, a message is displayed. Tap [Divide], [Continue] or [Cancel].  
[Divide]: Divides the pages into sets that can be stapled and sorts them.  
[Continue]: Continues sorting without stapling.  
[Cancel]: Cancels the staple sort setting.



## Trimmer Setting

1

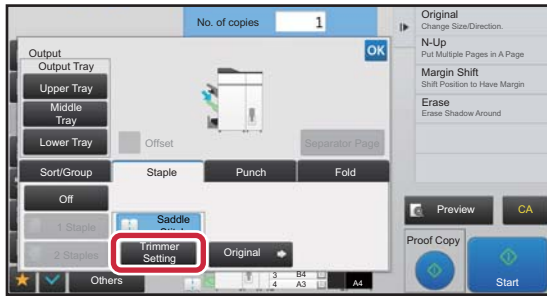

When Saddle Stitch is selected, tap the [Trimmer Setting] key.

2

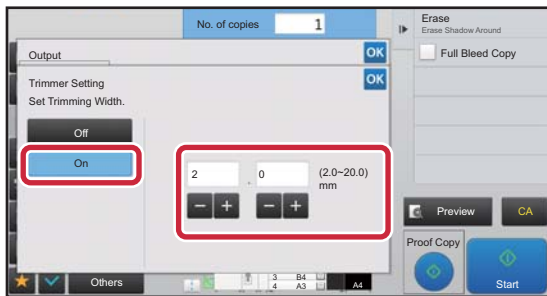

Tap the [On] key, and specify the trimming width.

Tap the numeric value display field of the trimming width, and enter the allowable range using the numeric keys. Otherwise, tap **-** **+**. After the settings are completed, tap **OK**.



**To cancel the Trimmer Setting:**  
Tap the [Off] key.





# PUNCH SETTINGS

This function punches copies and outputs them to the tray.

## Example

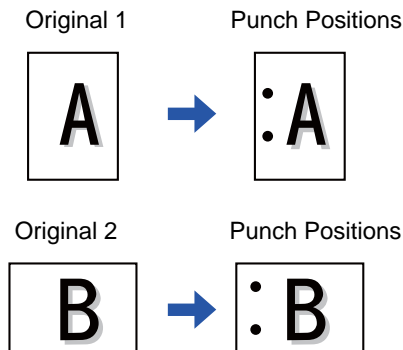

| Original Orientation  | Punch Position  |     |       |
|-----------------------|-----------------|-----|-------|
|                       | Left            | Top | Right |
| OFF                   | Does not punch. |     |       |
| Portrait orientation  |                 |     |       |
| Landscape orientation |                 |     |       |



- To change the default punch settings:  
In "Settings (administrator)", select [System Settings] → [Copy Settings] → [Initial Status Settings] → [Punch].
- Punch positions are linked to staple positions.



- You can view punch positions on the "[PREVIEW SCREEN \(page 1-14\)](#)".
- A punch module is required for paper punch.
- You cannot use 12" x 18" (A3W) size paper or special media such as transparency film and tab paper.
- You cannot use a paper punch together with the staple and paper folding.



1

## Tap the [Staple / Punch] key.

- ▶ [COPY MODE \(page 2-3\)](#)



Tap the [Original] key and specify the orientation of the original to have the orientation be correctly recognized.

- ▶ [Specifying the orientation of the original \(page 2-29\)](#)

2

## Select punching and set the position.

After the settings are completed, tap .



### In normal mode

- You can select the offset output checkbox  to have each set of output be offset from the previous set to enable easy removal from the output tray.
- To change the output tray, tap the [Output Tray] key, and select the output destination.



# FOLD SETTING

This function is used to fold copies before delivery to the output tray.

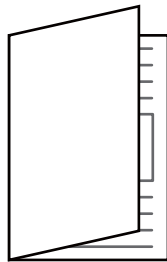

Fold Inside



Fold Outside



- To change the default fold setting:  
In "Settings (administrator)", select [System Settings] → [Copy Settings] → [Initial Status Settings] → [Fold].



- A saddle stitch finisher (large stacker), is required to use the fold function.
- The fold function cannot be used in combination with the staple function and punch function.
- The folding function cannot be combined with the staple function or punch function.
- You can check the selected folding method in "[PREVIEW SCREEN \(page 1-14\)](#)".
- When a saddle stitch finisher (large stacker) is installed, depending on the state of the paper type or printing setting, the saddle fold function in printing may not be used.

1

Tap the [Detail] key to change to normal mode.

► [CHANGING MODES \(page 1-13\)](#)



Tap the [Original] key and specify the orientation of the original to have the orientation be correctly recognized.

► [Specifying the orientation of the original \(page 2-29\)](#)

2

Tap the [Output] key, and tap the [Fold] tab.

3



**Select the folding method.**

After the settings are completed, tap **OK**.



# INSERTING SEPARATOR PAGES BETWEEN COPIES OR JOBS

This function inserts separator pages between each set of copies or between each job.

When you insert separator pages between sets of copies, you can specify whether to insert the separator page before or after each set. You can also specify the number of copies that makes one set.

When you insert separator pages between jobs, you can specify whether to insert a separator page before or after each job.

## Separator page insertion examples

In the following examples, four copies of a two-page original are output.

### Inserting a separator page before each set of two copies

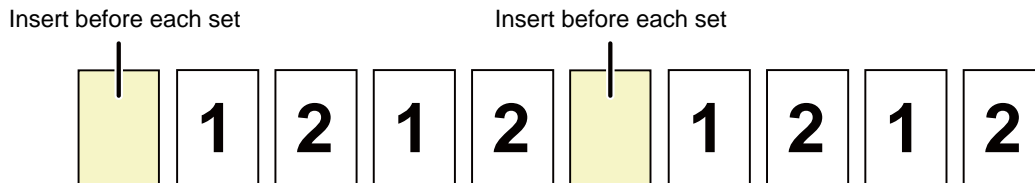

### Inserting a separator page after each set of two copies

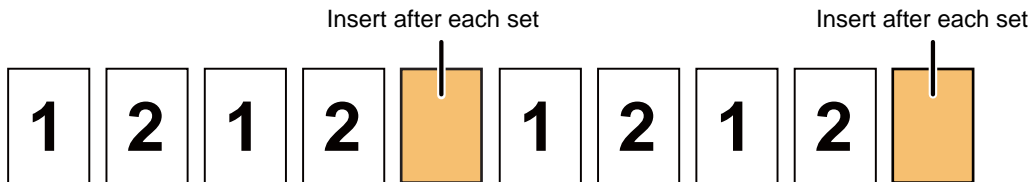

### Inserting separator pages before and after a job



- Even when this function is enabled, the Sort/Group, Staple, Punch, and Half Fold functions are not applied to separator pages.
- Combinations of Saddle Stitch, Saddle Fold, C-Fold, Accordion Fold, Double Fold, and Trimmer cannot be used.
- The Offset function, if enabled, is also applied to separator pages.

1

Tap the [Detail] key to change to normal mode.

▶ [CHANGING MODES \(page 1-13\)](#)



Tap the [Original] key and specify the orientation of the original to have the orientation be correctly recognized.

▶ [Specifying the orientation of the original \(page 2-29\)](#)

2

Tap the [Output] key, and tap the [Separator Page] key.



3

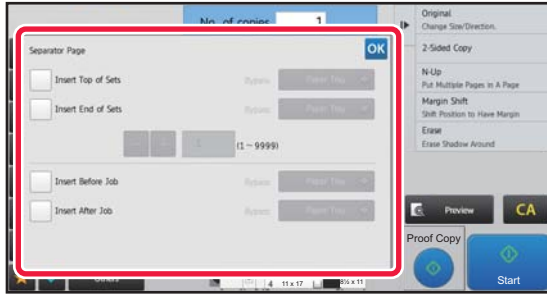

## Specify the separator page insertion mode.

- To insert separator pages between sets of copies, set the [Insert Top of Sets] or [Insert End of Sets] checkbox to . Next, tap **- +** to specify the number of copies in each set.
- To insert separator pages between jobs, set the [Insert Before Job] or [Insert After Job] checkbox to .
- After the settings are completed, tap **OK**.



### To change the separator page tray:

Tap the [Paper Tray] key to display the tray selection screen. Tap the separator page tray in the tray selection screen. For more information, see "[SELECTING THE PAPER TRAY FOR COPYING \(page 2-12\)](#)" and "[SPECIFYING A TYPE AND SIZE OF PAPER LOADED ON BYPASS TRAY \(page 2-35\)](#)".



### To cancel the separator page insertion setting:

Clear the checkmark for separator page insertion mode.



# BATCH COPY FUNCTIONS

## COPYING MULTIPLE ORIGINALS AS A SINGLE PAGE (N-Up)

This function copies multiple original pages onto a single sheet of paper in a uniform layout.

Select 2-Up to copy two original pages onto one sheet, 4-Up to copy four original pages onto one sheet, or 8-Up to copy eight original pages onto one sheet.

This function is convenient when you wish to present multiple pages in a compact format, or show a view of all pages in a document.

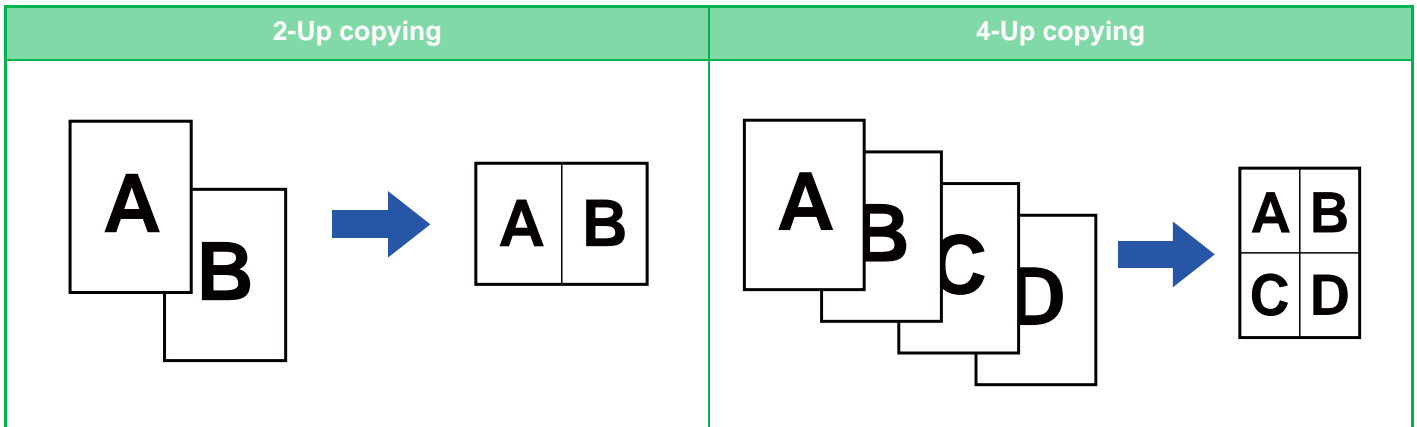

When inserting a cover sheet, select Cover Setting to copy only a front sheet to one page and collectively copy the second and subsequent pages.



### • Configure default settings for N-Up

In "Settings (administrator)", select [System Settings] → [Copy Settings] → [Condition Settings] → [InitialN-Up Setting]. Set the order and borders of N-Up by "Layout" or "Border".

### • To use N-Up in Easy mode (Standard):

In "Settings (administrator)", select [System Settings] → [Common Settings] → [Operation Settings] → [Easy Mode Settings] → [Easy Copy].

**1**

### Place the original.

Place the original in the document feeder tray of the automatic document feeder, or on the document glass.

► [AUTOMATIC DOCUMENT FEEDER \(page 1-116\)](#)

► [DOCUMENT GLASS \(page 1-120\)](#)



- When using the document glass to scan multiple original pages, change the original and tap the [Start] key.
- In Normal mode, go to step 4.

**2**

### Tap the [N-Up] key

► [COPY MODE \(page 2-3\)](#)



Tap the [Original] key and specify the orientation of the original to have the orientation be correctly recognized.

► [Specifying the orientation of the original \(page 2-29\)](#)



3

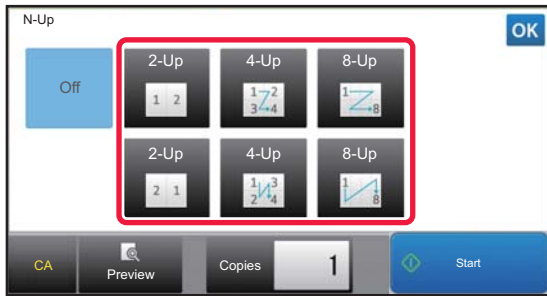

Tap the number of originals you want to copy collectively, and select the layout key.

If needed, the images will be rotated.  
If you have finished selecting settings, go to step 7.

4

To select more detailed settings, tap the [Detail] key to switch to normal mode.

► [CHANGING MODES \(page 1-13\)](#)

5

Tap the [Others] key, and tap the [N-Up] key.

6

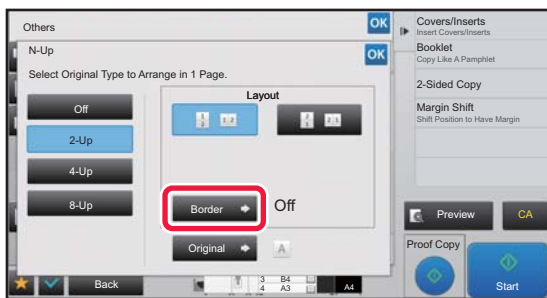

Tap [Border], and select the border.

A line can be inserted between pages arranged on a sheet.  
After the settings are completed, tap **OK** twice, and [Back] keys in sequence.



- **To cancel the N-Up setting:**  
Tap the [Off] key.
- **To cancel all settings:**  
Tap the [CA] key.

7

Tap the [Start] key to start copying.



## COPYING EACH FACING PAGE OF A BOUND DOCUMENT (DUAL PAGE COPY)

This function copies the left and right half of an original successively. This function is useful when making copies of the facing pages of a book or other bound document.

### Copying the facing pages of a book or bound document

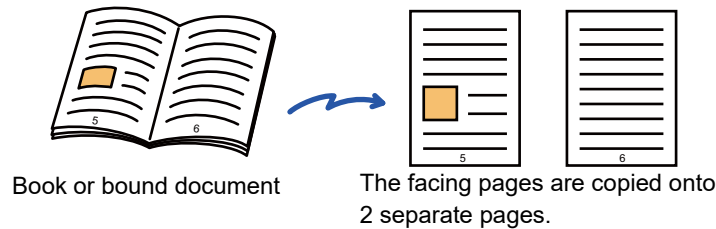

- Specify dual page copy before scanning the original.
- To erase shadows caused by the binding of a book or other bound document, use the erase function. This function cannot be used in combination with Center Erase.
- This function cannot be used in combination with 2-sided Original and Image Orientation: Horizontal.

1

### Tap the [Detail] key to change to normal mode.

▶ [CHANGING MODES \(page 1-13\)](#)

2

### Tap the [Others] key, and tap the [Dual Page Copy] key.

A checkmark appears on the icon.

After the settings are completed, tap the [Back] key.



When dual page copy is selected, A4 size paper is automatically selected.

If you want to use paper in another tray, tap the [Paper Select] key and select the tray containing the desired paper from the paper tray selection screen that appears.

▶ [SELECTING THE PAPER TRAY FOR COPYING \(page 2-12\)](#)



### To cancel the dual page copy setting:

Tap the [Dual Page Copy] key to uncheck it.





3

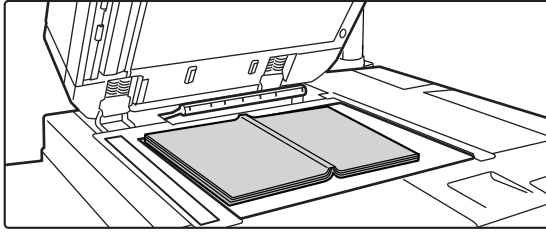

**Place the original on the document glass.**

► [DOCUMENT GLASS \(page 1-120\)](#)

Align the center of the original with the appropriate size mark

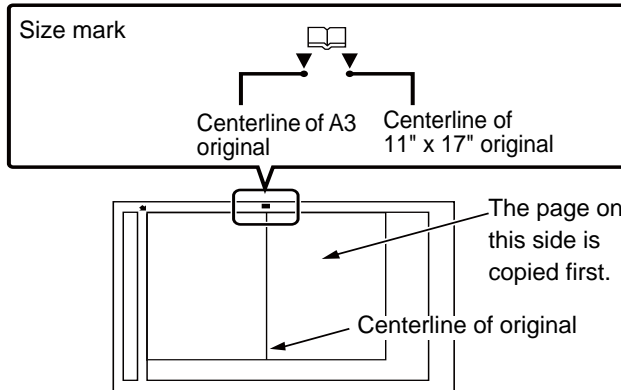

**To cancel all settings:**  
Tap the [CA] key.

4

**Tap the [Start] key to start copying.**



# COPYING BOTH SIDES OF A CARD AS A SINGLE PAGE (CARD SHOT)

This function copies the front and reverse sides of a card on one sheet, not on separate sheets. This function is convenient for making copies for identification purposes and helps save paper.

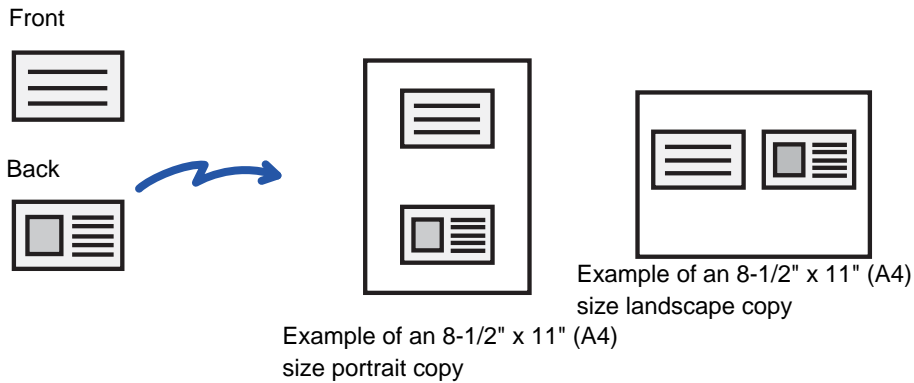

### To change the default original size during Card Shot:

In "Settings (administrator)", select [System Settings] → [Copy Settings] → [Condition Settings] → [Card Shot Settings]. Specify a value from 1" (25 mm) to 8-1/2" (210 mm) in increments of 1/8" (1 mm) for both the X (horizontal) and Y (vertical) dimensions of the original.

1

### Select the paper to be used for card shot.

Set a paper by referring to the "[SELECTING THE PAPER TRAY FOR COPYING \(page 2-12\)](#)".

2

### Tap the [Card Shot] key.

▶ [COPY MODE \(page 2-3\)](#)

3

### Tap the [Others] key, and tap the [Card Shot] key.

4

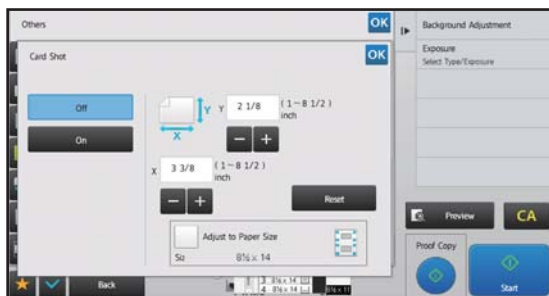

### Tap the [On] key, and specify the original size as required.

After the settings are completed, tap **OK** and [Back] keys in sequence.



- Tap the areas displaying width and height sizes respectively, and enter the sizes using the numeric keys.
- If there is any missing image part, enter a slightly larger size.
- To quickly set the size, first specify a value close to the desired ratio value by the numeric keys, then adjust it by tapping **- +**.
- When you set the [Adjust to Paper Size] checkbox to , the original is enlarged or reduced with the ratio appropriate to the original size.



**To cancel the Card Shot settings:**  
Tap the [Off] key.

5

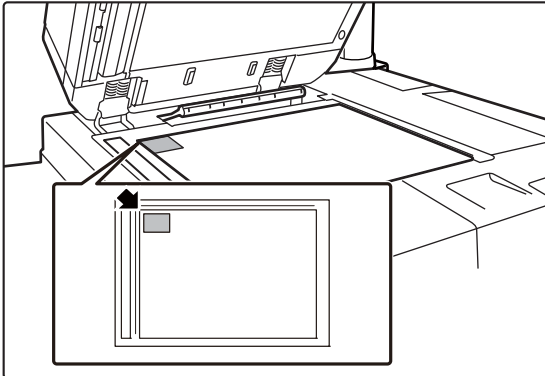

**Place a card face down on the document glass, and tap the [Start] key.**

► [DOCUMENT GLASS \(page 1-120\)](#)



- If there is any missing image part, move the original slightly toward the inside.

6

**Place a card face up on the document glass, and tap the [Start] key to scan the reverse side.**



- Copy settings cannot be changed when scanning additional pages.
- **To cancel all settings:**  
Tap the [CA] key.

7

**Tap the [Read-End] key to start copying.**



# REPEATING THE SAME IMAGE ON ONE SHEET (REPEAT LAYOUT)

This function copies multiple same original images on one sheet.  
You can set any of the following three types of repeat copy.

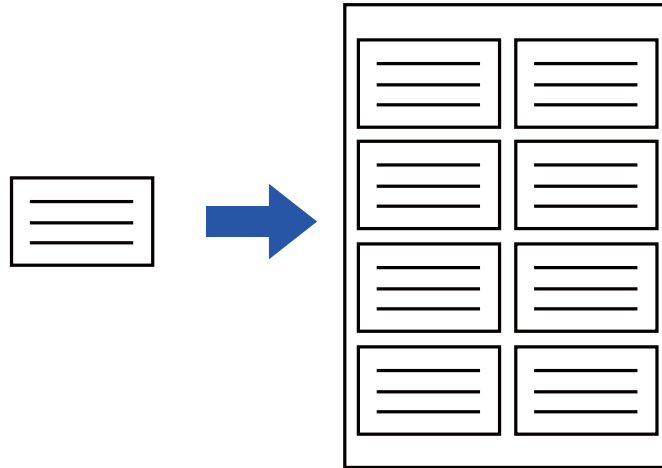

| Repeat method | Description   |
|---------------|---|
| Auto Repeat   | The maximum repeat count to copy images on a sheet is calculated automatically according to the original size, paper size, and copy ratio being selected from the base screen.  |
| Fixed Repeat  | When you select a repeat count, original size, and paper size to copy images on a sheet, the copy ratio is calculated automatically and the original is copied.   |
| Photo Repeat  | This function repeatedly copies on 8-1/2" x 11" (A4) or 11" x 17" (A3) papers without changing the copy ratio of the photo size original. You can select any of the following five types of original size: <ul style="list-style-type: none"> <li>• E/L Size, Postcard (Up to 3" x 5" (148 mm x 105 mm))</li> <li>• Up to 5" x 7" (100 mm x 150 mm)</li> <li>• Card (Up to 2-1/2" x 4" (70 mm x 100 mm))</li> <li>• ID Photo (Up to 2-1/2" x 2-1/2" (65 mm x 70 mm))</li> <li>• Card (Up to 2-1/8" x 2-5/8" (57 mm x 100 mm))</li> </ul> * Reduction will be 95%. |



- Repeat Layout must be specified before scanning the original.
- If the copy ratio automatically obtained in [Fixed Repeat] exceeds 25 to 400% (using document glass) or 25 to 200% (using automatic document feeder), it will result in an error. Select the number of faces to repeat again.
- Always place an original on the document glass for photo repeating.
- Repeat Layout can be combined with Staple / Punch or Saddle Stitch.



- This function cannot be combined with Mixed Size Original or 2-Sided Copy.
- Photo Repeat cannot be combined with Image Orientation.



## Copy by automatically calculating the repeat count (Auto Repeat)

1

### Place the original.

Place the original in the document feeder tray of the automatic document feeder, or on the document glass.

- ▶ [AUTOMATIC DOCUMENT FEEDER \(page 1-116\)](#)
- ▶ [DOCUMENT GLASS \(page 1-120\)](#)

2

### Tap the [Detail] key to change to normal mode.

- ▶ [CHANGING MODES \(page 1-13\)](#)

3

### Tap the [Others] key, and then tap the [Repeat Layout] key.

4

### Tap the [Auto Repeat] key.

5

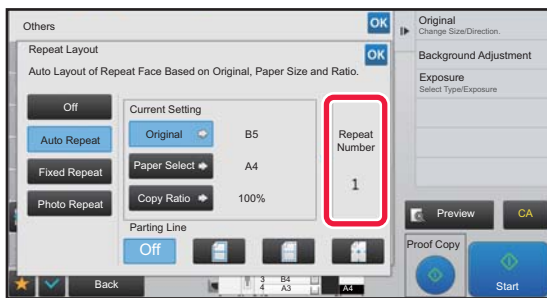

### Check the repeat faces which have been calculated automatically.

Change the original size, paper size, or copy ratio by tapping the respective [Original], [Paper Select], or [Copy Ratio] key when necessary.

- ▶ [SELECTING THE ORIENTATION AND SIZE OF THE ORIGINAL \(page 2-29\)](#)
- ▶ [MANUAL RATIO SELECTION \(page 2-23\)](#)
- ▶ [SELECTING THE PAPER TRAY FOR COPYING \(page 2-12\)](#)



Set so that there are one or more repeat faces.

6

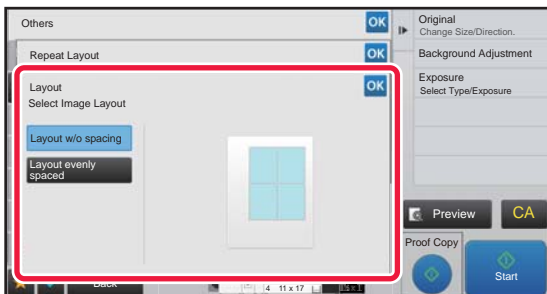

### Tap the [Layout] key.

Tap the [Layout w/o spacing] key and [Layout evenly spaced] key to select the layout.



7

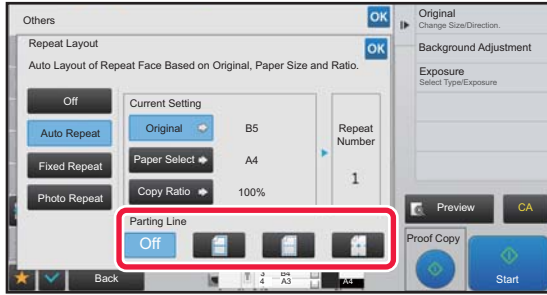

### Specify the repeat partition line.

After the settings are completed, tap **OK** and [Back] keys in sequence.



- To cancel the Auto Repeat setting:  
Tap the [Off] key.
- To cancel all settings:  
Tap the [CA] key.

8

Tap the [Start] key to start copying.

## Copy by specifying a repeat count (Fixed Repeat)

1

Perform steps 1 to 3 in [Copy by automatically calculating the repeat count \(Auto Repeat\) \(page 2-53\)](#).

2

Tap the [Fixed Repeat] key.

3

Tap the [Original] and [Paper Select] keys to select an original size and a paper size, respectively.

- ▶ [SELECTING THE ORIENTATION AND SIZE OF THE ORIGINAL \(page 2-29\)](#)
- ▶ [SELECTING THE PAPER TRAY FOR COPYING \(page 2-12\)](#)

4

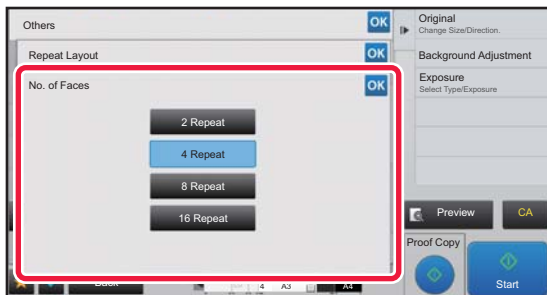

### Tap [No. of Faces] to set a repeat count.

After the settings are completed, tap **OK**.  
The automatic calculation result is shown as the copy ratio.



If the calculated copy ratio exceeds the range from 25% to 400% (using document glass) or 25 to 200% (using automatic document feeder), an error occurs.



5

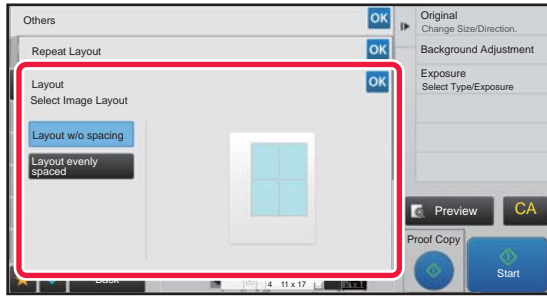

**Tap the [Layout] key.**

Tap the [Layout w/o spacing] key and [Layout evenly spaced] key to select the layout.

6

**Specify the repeat partition line.**

After the settings are completed, tap **OK** and [Back] keys in sequence.



- **To cancel the fixed repeat setting:**  
Tap the [Off] key.
- **To cancel all settings:**  
Tap the [CA] key.

7

**Tap the [Start] key to start copying.**



## Repeat a photo size original in actual size (Photo Repeat)

1

Perform steps 1 to 3 in [Copy by automatically calculating the repeat count \(Auto Repeat\) \(page 2-53\)](#).

2

Tap the [Photo Repeat] key.

3

Place the original on the document glass.

4

Tap the [Original] key and select an original size.

When you tap the original size key, the original direction is indicated in the "How To Set". Place the original to meet the displayed orientation.

After the settings are completed, tap **OK**.

5

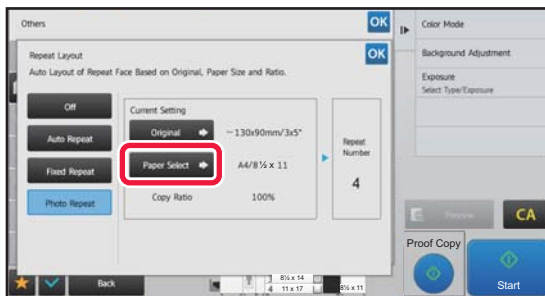

Tap the [Paper Select] key and select a paper size.

After the settings are completed, tap **OK** and [Back] keys in sequence.

The automatic calculation result is shown as the copy ratio.



When you tap the [\*Up to 57x100mm(Card) \*~ 2 1/8 x 2 5/8"] key on the [Original] screen, you can select the A4 paper size only.



• **To cancel the photo repeat setting:**

Tap the [Off] key.

• **To cancel all settings:**

Tap the [CA] key.

6

Tap the [Start] key to start copying.





# COPYING MULTIPLE BUSINESS CARDS (BUSINESS CARD COPY)

Business Card Copy can be used to copy up to 8 business cards on one sheet of paper.

This function can be used when you want to create the list of business cards, and when you want to file business cards.

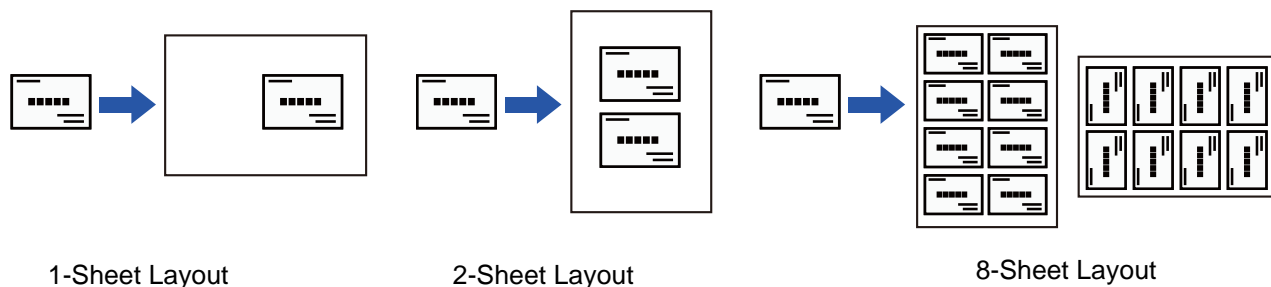
**1**

Tap the [Detail] key to change to normal mode.

► [CHANGING MODES \(page 1-13\)](#)

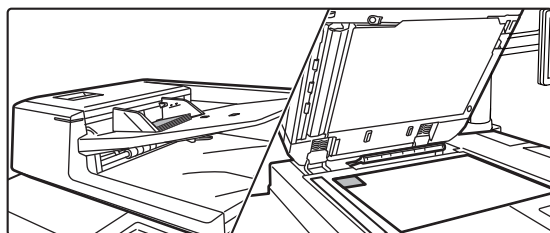
**2**

Place a business card, and select the paper to be used to copy the card.

• Refer to "[SELECTING THE PAPER TRAY FOR COPYING \(page 2-12\)](#)" to select the paper.

For original placement orientations and copy results, see "[Copy results of 8-Sheet Layouts \(page 2-58\)](#)"

**3**

Tap the [Others] key, and then tap the [Business Card Copy] key.

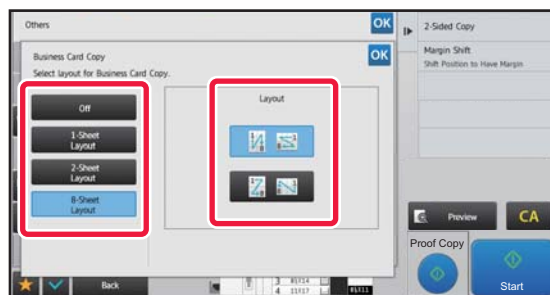
**4**

Specify settings for Business Card Copy.

(1) Specify the number of business cards to be copied and touch the [1-Sheet Layout] key or the [2-Sheet Layout] or the [8-Sheet Layout] key.

(2) When [8-Sheet Layout] is selected, select the desired layout from "Layout".

After the settings are completed, tap **OK** and [Back] keys in sequence.



• To Business Card Copy setting:

Tap the [Off] key.

• To cancel all settings:

Tap the [CA] key.







5

Tap the [Start] key to start copying.

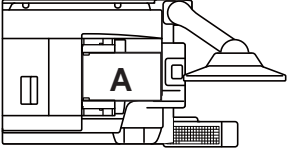

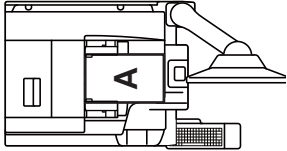
The zoom is fixed at 100%.

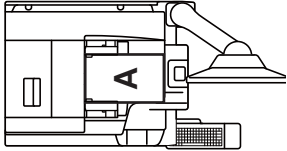
### Copy results of 8-Sheet Layouts

| Originals (Original orientation)   |  | Settings  | Results |   |   |   |   |   |   |   |
|--|--|---|---------|---|---|---|---|---|---|---|
| 1st <b>A</b> 5th <b>E</b><br>2nd <b>B</b> 6th <b>F</b><br>3rd <b>C</b> 7th <b>G</b><br>4th <b>D</b> 8th <b>H</b>  |   | <table border="1"> <tr><td>A</td><td>E</td></tr> <tr><td>B</td><td>F</td></tr> <tr><td>C</td><td>G</td></tr> <tr><td>D</td><td>H</td></tr> </table> | A       | E | B | F | C | G | D | H |
| A  | E  |   |         |   |   |   |   |   |   |   |
| B  | F  |   |         |   |   |   |   |   |   |   |
| C  | G  |   |         |   |   |   |   |   |   |   |
| D  | H  |   |         |   |   |   |   |   |   |   |
| 1st <b>A</b> 2nd <b>B</b> 3rd <b>C</b> 4th <b>D</b><br>5th <b>E</b> 6th <b>F</b> 7th <b>G</b> 8th <b>H</b>        |  | <table border="1"> <tr><td>D</td><td>C</td><td>B</td><td>A</td></tr> <tr><td>H</td><td>G</td><td>F</td><td>E</td></tr> </table>                     | D       | C | B | A | H | G | F | E |
| D  | C  | B   | A       |   |   |   |   |   |   |   |
| H  | G  | F   | E       |   |   |   |   |   |   |   |
| 1st <b>A</b> 2nd <b>B</b> 3rd <b>C</b> 4th <b>D</b><br>5th <b>E</b> 6th <b>F</b> 7th <b>G</b> 8th <b>H</b>        |  | <table border="1"> <tr><td>G</td><td>E</td><td>C</td><td>A</td></tr> <tr><td>H</td><td>F</td><td>D</td><td>B</td></tr> </table>                     | G       | E | C | A | H | F | D | B |
| G  | E  | C   | A       |   |   |   |   |   |   |   |
| H  | F  | D   | B       |   |   |   |   |   |   |   |



# OTHER FUNCTIONS

Other functions are set from the base screen of normal mode.

▶ [SELECTING COPY MODE \(page 2-4\)](#)



Other functions cannot be selected in easy mode.

## OUTPUT AND LAYOUT EDITING FUNCTIONS

### MAKING COPIES IN PAMPHLET FORMAT (BOOKLET)

Copies made by "Booklet" can be folded at the center to create a booklet.  
This function is convenient for arranging copies into an attractive booklet or pamphlet.

#### Booklet copy using 8 original pages

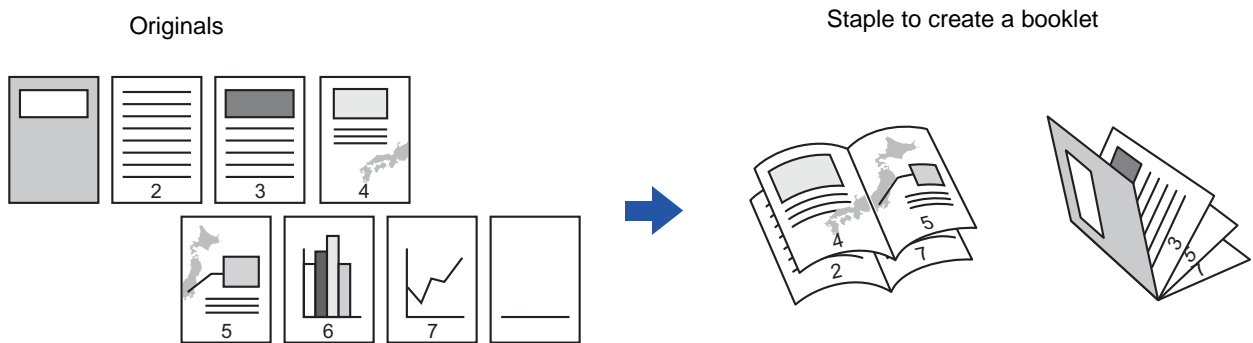

#### Binding side

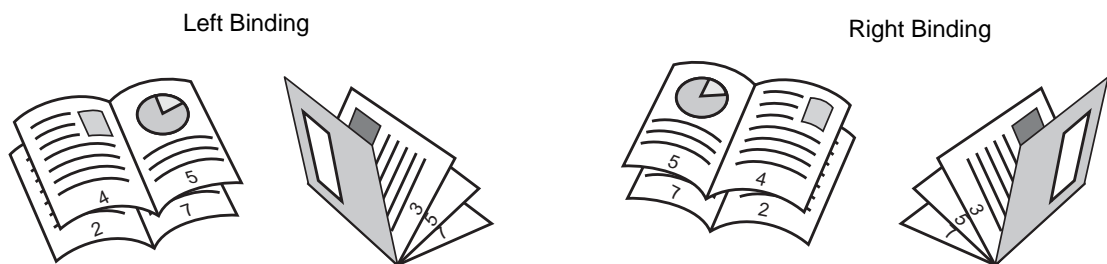



- To make Booklet copies of a book or other bound original, use the book copy function.
  - ▶ [COPYING A PAMPHLET \(BOOK COPY\) \(page 2-65\)](#)
- When Booklet is selected, 2-sided copying mode is automatically selected. When settings are selected that prevent 2-sided copying, the booklet function cannot be used.
- Scan the originals in order from the first page to the last page. The order of copying will be automatically adjusted by the machine. Four original pages will be copied onto each sheet of paper. Blank pages will be automatically produced at the end of pamphlet copies if the number of original pages is not a multiple of four.
- When a saddle stitch finisher is installed, you can select the [Staple] tab of the [Output] key and set the Saddle Stitch (Staple each set of copies at two positions in the center of paper).
  - ▶ [STAPLE SETTINGS \(page 2-37\)](#)



**To staple copies automatically when Booklet is enabled:**

From the "Settings (administrator)", select [System Settings] → [Common Settings] → [Device Control] → [Condition Settings] → [Automatic Saddle Stitch].

This is used to activate Saddle Stitch automatically when Booklet is enabled when a saddle stitch finisher is installed. To make pamphlet copies without stapling when the [Automatic Saddle Stitch] option is ON, tap the [Output] key. Then, select the [Staple] tab and tap the [Off] key on the saddle stitch screen.

**1**

**Place the original.**

Place the original in the document feeder tray of the automatic document feeder, or on the document glass.

- ▶ [AUTOMATIC DOCUMENT FEEDER \(page 1-116\)](#)
- ▶ [DOCUMENT GLASS \(page 1-120\)](#)



If the originals are 2-sided, place them in the document feeder tray.

**2**

**Tap the [Others] key and then the [Booklet] key, or tap the [Staple] tab of the [Output] key and then the [Saddle Stitch] key.**

**3**

**Select the binding edge.**



**To cancel the booklet setting:**

Tap the [Off] key.

**4**

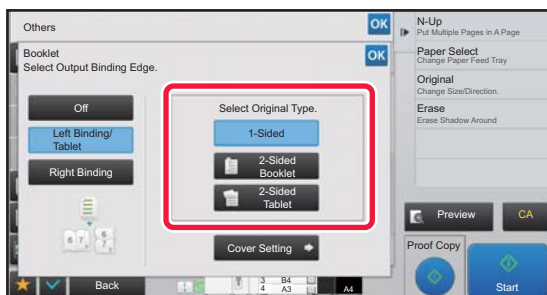

**Tap the [1-Sided], [2-Sided Booklet] or [2-Sided Tablet] key as appropriate for the original.**

When not inserting a cover, go to step 6.



5

**When inserting a cover, tap the [Cover Setting] key, and tap the [On] key.**

After the settings are completed, tap  and [Back] keys in sequence.



**To change the cover input tray:**

Tap the [Paper Tray] key to display the tray selection screen.

Tap the cover input tray on the tray selection screen.

For more information, see "[SELECTING THE PAPER TRAY FOR COPYING \(page 2-12\)](#)".



- If the cover will be copied on, label sheets, transparency film, and tab paper cannot be used.

**To cancel all settings:**

Tap the [CA] key.

6

**Tap the [Start] key to start copying.**



# COPYING MULTIPLE ORIGINALS ON EACH BOOKLET PAGE (BOOKLET 2-Up/4-Up)

This function copies two or four original pages equally on one page of pamphlet copy paper.

This function is convenient for arranging minimum number of copies into an attractive booklet or pamphlet format.



- The following paper sizes and number of sheets are available for booklet 2-Up or 4-Up.

Paper size: 12"x 18", 11"x 17", 8-1/2"x 14", 8-1/2"x 11"R, A3W, A3, B4, A4R, B5R

Number of stapled sheets: Max. 15 sheets

- Scan the originals in order from the first page to the last page. The order of copying will be automatically adjusted by the machine.  
Eight or 16 original pages will be copied onto each sheet of paper. Blank pages will be automatically produced at the end if the number of original pages is not a multiple of eight or 16.

**1**

## Place the original.

Place the original in the document feeder tray of the automatic document feeder, or on the document glass.

- [AUTOMATIC DOCUMENT FEEDER \(page 1-116\)](#)
- [DOCUMENT GLASS \(page 1-120\)](#)



If the originals are 2-sided, place them in the document feeder tray.

**2**

Tap the [Others] key and then the [Booklet] key, or tap the [Staple] tab of the [Output] key and then the [Saddle Stitch] key.

**3**

Select the binding edge.



**To cancel the booklet setting:**  
Tap the [Off] key.



4

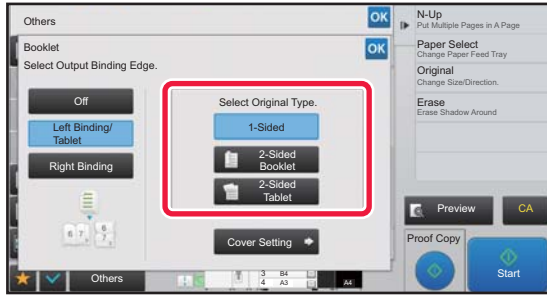

Tap the [1-Sided], [2-Sided Booklet] or [2-Sided Tablet] key as appropriate for the original.

When not inserting a cover, go to step 6.

5

When inserting a cover, tap the [Cover Setting] key, and tap the [On] key.



- To change the cover input tray:  
Tap the [Paper Tray] key to display the tray selection screen.  
Tap the cover input tray on the tray selection screen.  
For more information, see "[SELECTING THE PAPER TRAY FOR COPYING \(page 2-12\)](#)".
- To make a copy on a cover sheet, check the [Make Copy on Cover (Duplex)] box so that  appears.



- If the cover will be copied on, label sheets, transparency film, and tab paper cannot be used.
- To cancel all settings:  
Tap the [CA] key.

6

Tap [N-Up] on the action panel.

7

Tap the key of the N-Up sheets you wish to use.

If needed, the images will be rotated.



- To cancel the N-Up setting  
Tap the [Off] key.

8

Select the layout.



9

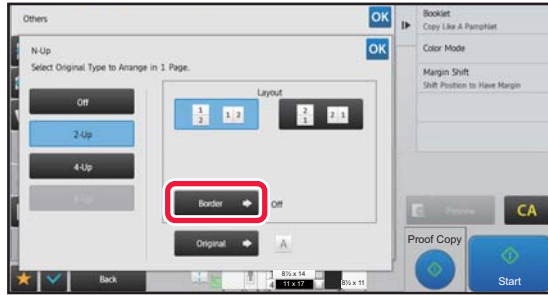

**Tap [Border], and select the border.**

A line can be inserted between pages arranged on a sheet. After the settings are completed, tap **OK** twice, and [Back] keys in sequence.



**To cancel all settings:**  
Tap the [CA] key.

10

**Tap the [Start] key to start copying.**





# COPYING A PAMPHLET (BOOK COPY)

This function makes a copy of the two facing pages of an open book or other bound document.

Copies made with this function can be folded at the center to create a booklet.

This function is convenient for arranging copies into an attractive booklet or pamphlet.

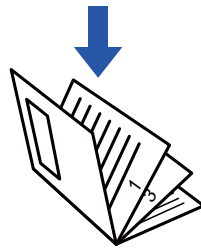
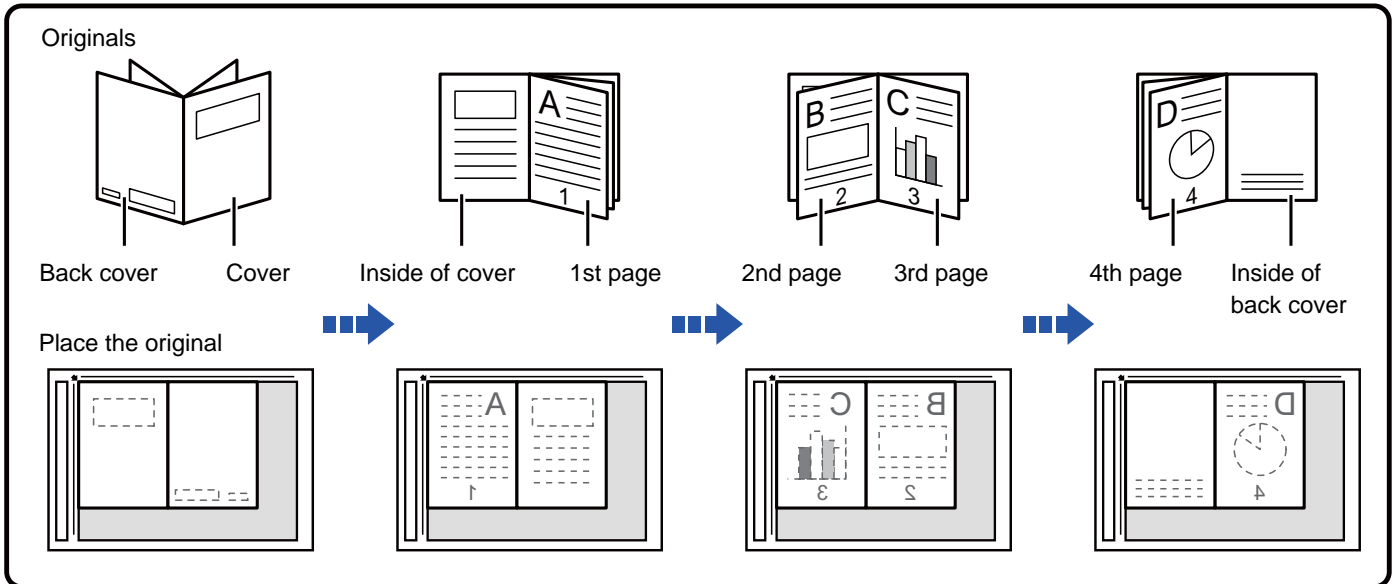

- Book Copy must be specified before scanning the original.
- Four original pages will be copied onto each sheet of paper. Blank pages will be automatically added at the end if the total number of original pages is not a multiple of four.
- This function can be combined with saddle stitch or fold if a saddle stitch finisher is installed.
- When the book copy function is selected, 2-sided copying mode is automatically selected. When settings are selected that prevent 2-sided copying, the book copy function cannot be used.

1

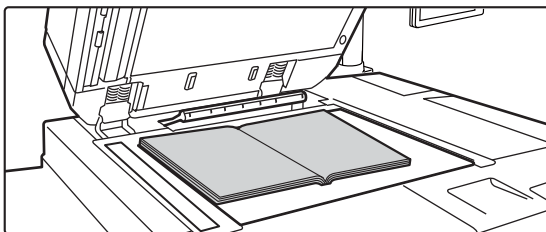

## Place the original on the document glass.

Place the opened pages of the "front and last sheets".

▶ [DOCUMENT GLASS \(page 1-120\)](#)

2

Tap the [Others] key, and tap the [Book Copy] key.



3

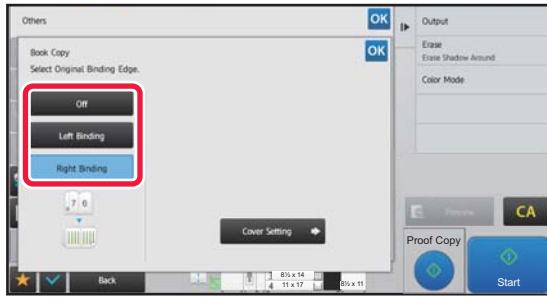

**Select a binding position.**

When not inserting a cover, tap the **OK** and [Back] keys in sequence. Then, go to step 5.



**To cancel the book copy setting:**  
Tap the [Off] key.

4

**When inserting a cover, tap the [Cover Setting] key, and tap the [On] key.**

To make a copy on the inserted cover sheet, check the [Make Copy on Cover (Duplex)] box so that  appears. After the settings are completed, tap **OK** and [Back] keys in sequence.



**To change the cover input tray:**

Tap the [Paper Tray] key to display the tray selection screen. Tap the cover input tray on the tray selection screen. For more information, see "[SELECTING THE PAPER TRAY FOR COPYING \(page 2-12\)](#)".



- If the cover will be copied on, label sheets, transparency film, and tab paper cannot be used.
- This setting is not available when the covers/inserts function is disabled in the setting mode.

5

**Tap the [Start] key to scan the first original page.**

Scanning of the original starts.

6

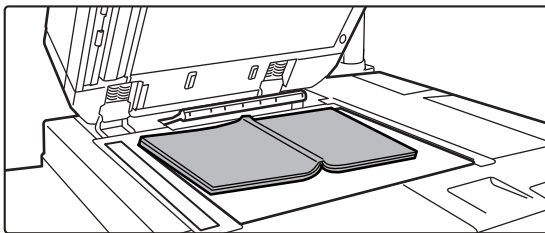

**Place the next opened original pages, and tap the [Start] key.**

Tap the same key you tapped in step 5. Repeat this step until all original pages have been scanned. Scan the remaining original pages in the following order:  
Inside of the front cover and the 1st page (facing pages)  
The 2nd and 3rd pages (facing pages)  
⋮  
The last page and inside of back cover (facing pages)



- Copy settings cannot be changed when scanning additional pages.
- **To cancel all settings:**  
Tap the [CA] key.

7

**Tap the [Read-End] key to start copying.**



# SPLITTING A PAMPHLET ORIGINAL BY PAGE (BOOK DIVIDE)

This function splits a saddle-stitch original such as a catalogue or a pamphlet page by page, and copies in sequence.

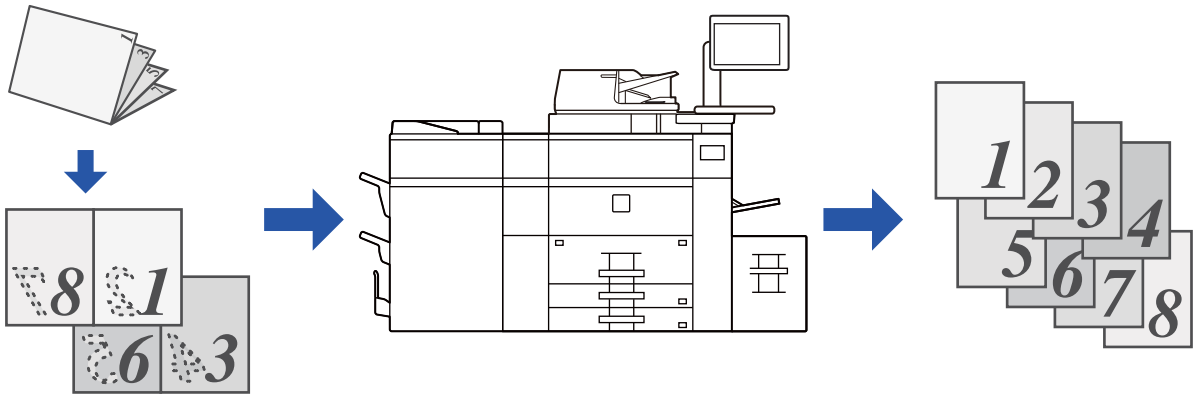

- Book Divide must be specified before scanning the original.
- This function supports three original binding edges: left binding, right binding, and top open.
- The scanned original is split in the center.



The document glass is not available for this function.

**1** Tap the [Others] key, and tap the [Book Divide] key.

**2**

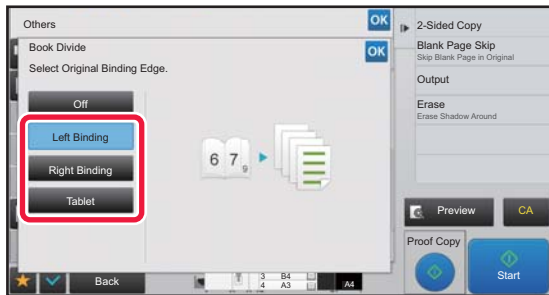

Select the binding edge of the pamphlet original.



Check the preview image displayed in the screen, and make sure that the binding edge is correct.



- **To cancel the Book Divide setting:**  
Tap the [Off] key.
- **To cancel all settings:**  
Tap the [CA] key.

**3**

Tap the [Start] key to start copying.



## COPYING AN ORIGINAL IN REVERSE PAGE ORDER (REVERSE ORDER)

In normal copy operations, printed sheets are output in top-to-bottom order with the printed side facing down, producing a set of copies stacked in the same order as the original. The Reverse Order function outputs printed sheets in top-to-bottom order with the printed side facing up, resulting in a set of copies stacked in the opposite order to the original.

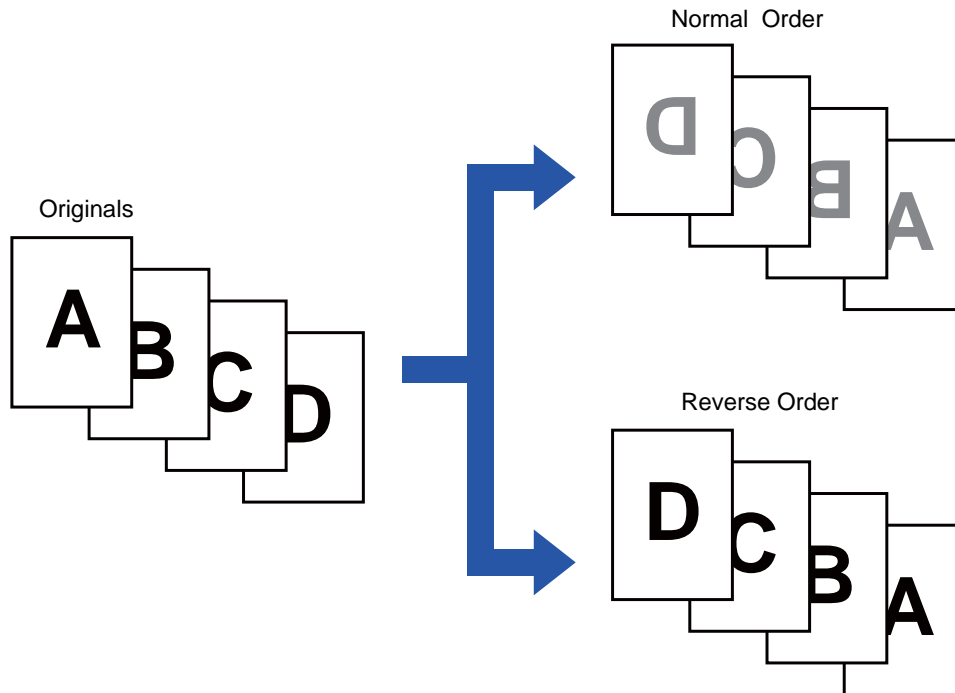
**1**

### Tap the [Others] key, and tap the [Reverse Order] key.

A checkmark appears on the icon.  
After the settings are completed, tap the [Back] key.



**To cancel the reverse order setting:**  
Tap the [Reverse Order] key to clear the checkmark.

**2**

### Place the original.

Place the original in the document feeder tray of the automatic document feeder, or on the document glass.

- ▶ [AUTOMATIC DOCUMENT FEEDER \(page 1-116\)](#)
- ▶ [DOCUMENT GLASS \(page 1-120\)](#)



**To cancel all settings:**  
Tap the [CA] key.

**3**

### Tap the [Start] key to start copying.



# PAPER, AND TIME SAVING FUNCTIONS

## SKIPPING BLANK PAGES IN AN ORIGINAL (BLANK PAGE SKIP)

If the scanned original contains blank pages, this function skips them to copy only non-blank pages. The machine detects blank pages, enabling you to skip useless copies without checking an original.

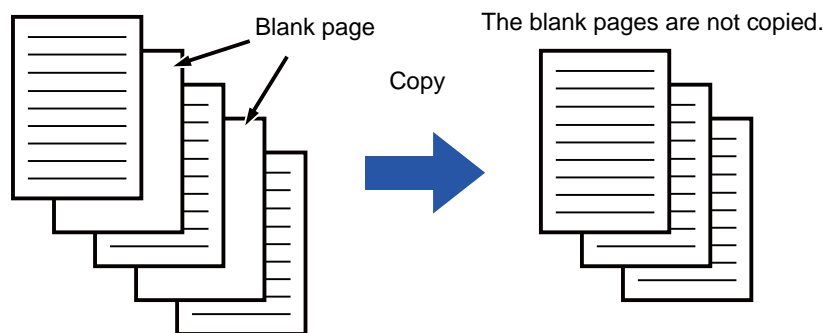

- If an original of which one side is blank is scanned, blank pages are skipped for 2-sided copying.
- Depending on the original, some pages that are not blank may be detected as blank pages and thus not being copied, and some pages that are blank may not be detected as blank and thus copied.

**1**

### Place the original.

Place the original in the document feeder tray of the automatic document feeder, or on the document glass.

- ▶ [AUTOMATIC DOCUMENT FEEDER \(page 1-116\)](#)
- ▶ [DOCUMENT GLASS \(page 1-120\)](#)

**2**

Tap the [Others] key, and tap the [Blank Page Skip] key.



3

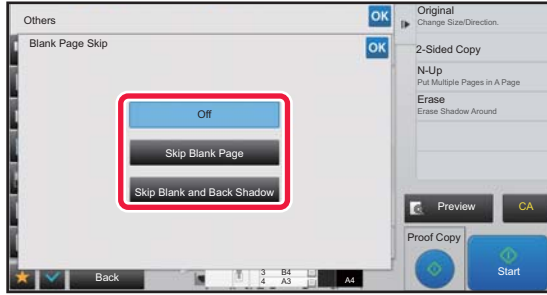

**Tap the [Skip Blank Page] or [Skip Blank and Back Shadow] key.**

After the settings are completed, tap **OK** and [Back] keys in sequence.



**To cancel all settings:**  
Tap the [CA] key.

4

**Tap the [Start] key.**

5

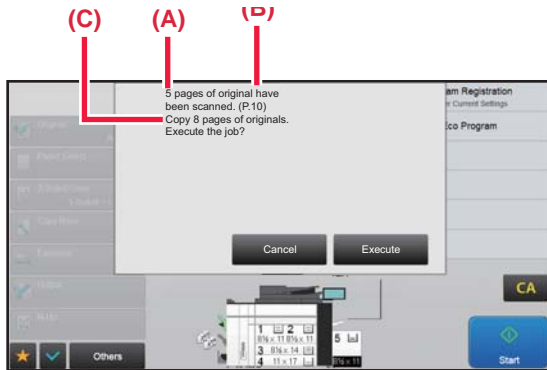

**Check the confirmation message, and tap the [Execute] key to start copying.**

On the confirmation screen, the number of scanned original sheets appears in (A), the number of scanned sides in (B), and the number of copies excluding blank pages in (C). For example, if five original sheets that include two blank pages are scanned by duplex scanning, (A) will show "5", (B) will show "10", and (C) will show "8".



# ADJUSTING THE BACKGROUND BY MAKING LIGHT AREAS OF THE ORIGINAL DARKER OR LIGHTER (BACKGROUND ADJUSTMENT)

You can adjust the background by making light areas of the original darker or lighter.

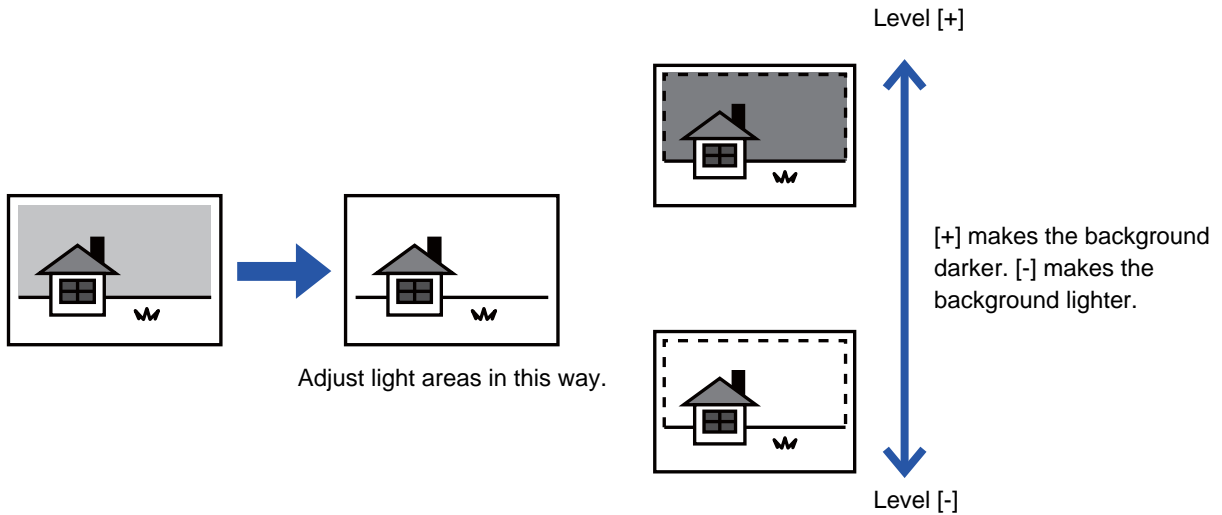

You must select Background Adjustment before scanning the original.

1

Tap the [Others] key, and tap the [Background Adjustment] key.

2

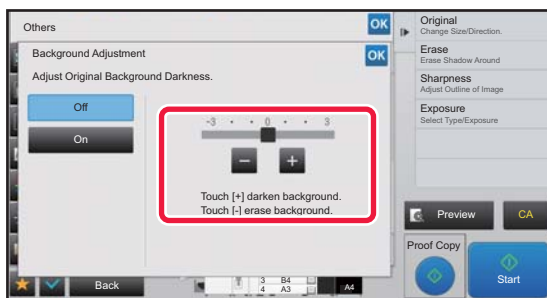

Tap **- +** or move the slider to set the value.

After the settings are completed, tap **OK** and [Back] keys in sequence.



To cancel the Background Adjustment setting:  
Tap the [Off] key.



3

### Place the original.

Place the original in the document feeder tray of the automatic document feeder, or on the document glass.

- ▶ [AUTOMATIC DOCUMENT FEEDER \(page 1-116\)](#)
- ▶ [DOCUMENT GLASS \(page 1-120\)](#)



#### To cancel all settings:

Tap the [CA] key.

4

### Tap the [Start] key to start copying.





## MAKING A PROOF COPY (PROOF COPY)

This function makes a proof copy before printing the specified number of copies. Check the preview image with a proof copy. If necessary, change the settings. Using this function stores the scanned original in the machine, saving you the trouble of re-scanning the original in the changed setting.

### Proof copy flow

Select "Proof Copy" and set 5 sets of copies

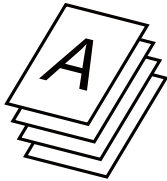

One set of copies is printed for you to check

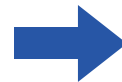
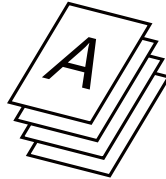

The remaining 4 sets are printed

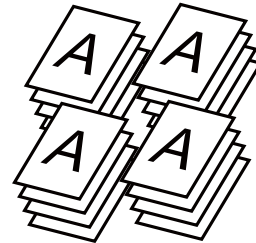

Adjust the settings

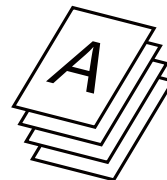

If OK

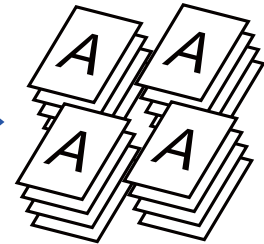

After adjustment, one set is printed for you to check

The remaining 4 sets are printed



- Proof Copy must be specified before scanning the original.
- If Proof Copy is executed while the machine is printing another job, the job in progress is interrupted, and a proof copy is printed preferentially. The interrupted job will resume after proof copying has been completed. However, if proof copy is executed during printing of a job for which both 2-sided printing and staple function are enabled, the proof copy will be printed after the job in progress is finished. If the [Start Print] key is tapped to execute printing of the remaining sets while the machine is printing another job, the remaining sets will be printed after all previously reserved jobs are completed.

1

**As necessary, specify the required functions such as "Exposure" and "Copy Ratio".**

2

**Place the original.**

Place the original in the document feeder tray of the automatic document feeder, or on the document glass.

- ▶ [AUTOMATIC DOCUMENT FEEDER \(page 1-116\)](#)
- ▶ [DOCUMENT GLASS \(page 1-120\)](#)



**To cancel all settings:**

Tap the [CA] key.



3

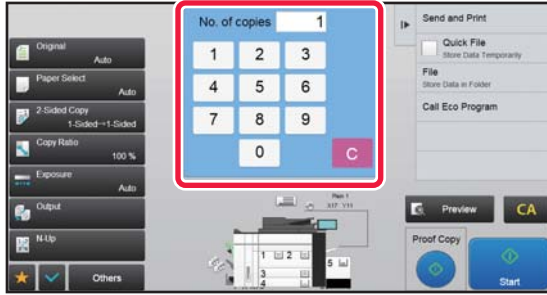

Set the number of copies (number of sets) using the numeric keys.



Up to 9999 copies (sets) can be set.



If an incorrect number of copies is set Tap the [C] key, and enter the correct number.

4

Tap .

Make only one set of copies.

5

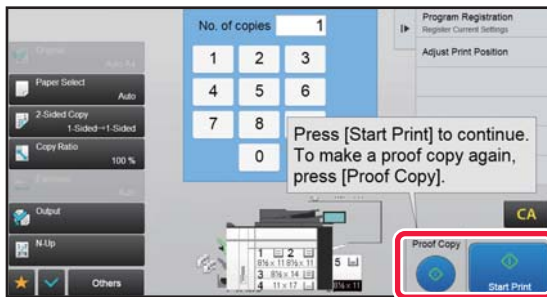

Check the copy result. If no problem is found, tap the [Start Print] key.

As necessary, change the settings and repeat proof copying until you are satisfied with the copy result.



You can also change the number of copies. To change the number of copies, use the numeric keys.



- In Proof Copy, unavailable function keys are not displayed.
- Some available functions may be restricted.
- **To cancel all settings:**  
Tap the [CA] key.

6

Tap .



# CHECKING THE NUMBER OF SCANNED ORIGINAL SHEETS (ORIGINAL COUNT)

This function counts the number of scanned original sheets, and displays the result before making a copy. By allowing you to check the number of original sheets that were scanned, this helps reduce the occurrence of copy mistakes.



- The count result is displayed with the number of scanned original sheets, not the number of scanned original pages. For example, when 2-sided copying is performed using one original, the number "1" will appear to indicate that one original sheet was scanned, not "2" to indicate the front-side page and the reverse side page.
- Original Count must be specified before scanning the original.

**1**

## Tap the [Others] key, and tap the [Original Count] key.

A checkmark appears on the icon.  
After the settings are completed, tap the [Back] key.



**To cancel the Original Count setting:**  
Tap the [Original Count] key to uncheck it.

**2**

## Place the original in the document feeder tray of the automatic document feeder.

► [AUTOMATIC DOCUMENT FEEDER \(page 1-116\)](#)

**3**

## Tap the [Start] key.

**4**

## Check the number of original sheets.

The number that is displayed is the number of scanned original sheets, not the number of scanned original pages. For example, when 2-sided copying is performed using one original, the number "1" will appear to indicate that one original sheet was scanned, not "2" to indicate the front-side page and the reverse side page.



**If the displayed number of original sheets is different from the actual number of sheets**  
Tap the [Cancel] key to stop the job.

**5**

## Tap the [OK] key to start copying.



If this function is combined with [Job Build], the count result is displayed after the [Read-End] key has been tapped.



## USING TWO MACHINES TO REDUCE THE COPY TIME (TANDEM COPY)

This function shares a copy job half-and-half between two machines connected to the network, enabling the reduction of the copy time.

### Master machine and client machine

The master machine performs only scanning, and a client machine registered in the master machine performs only printing without scanning the original.

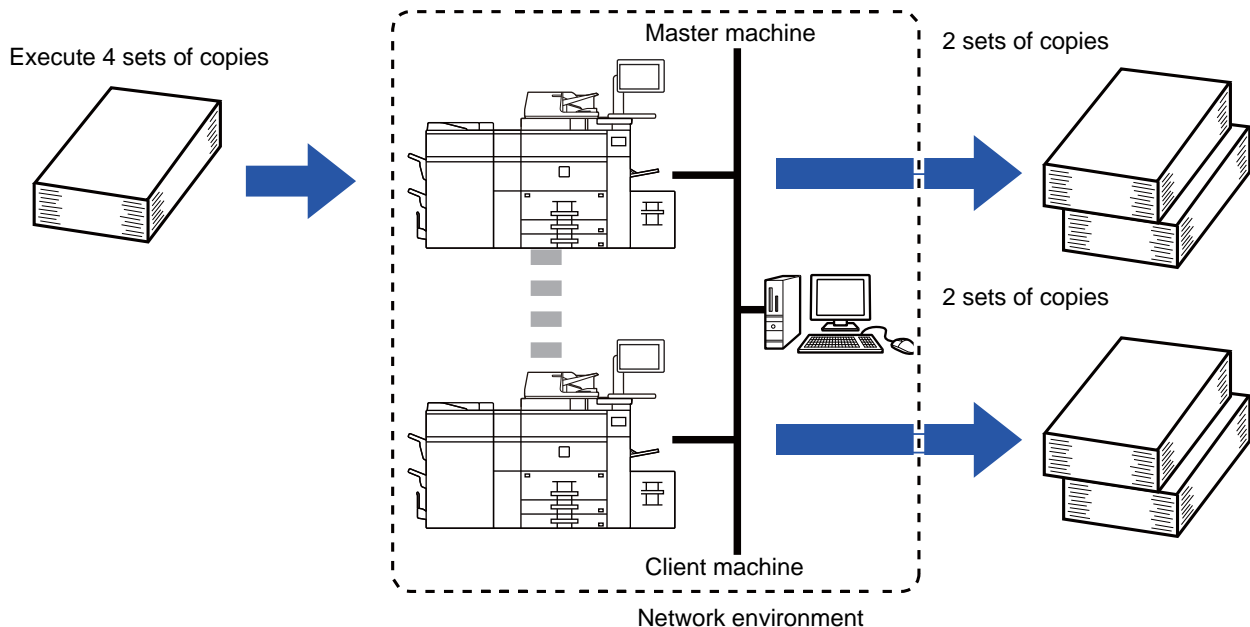

- To use this function, two machines must be connected to your network.
- Even if more machines are connected to the network, this function can only be used to have one other machine share a job.
- To configure the tandem connection setting, register IP address information of the client machine in the master machine. For the port number, it is best to use the initial setting (50001). Unless you experience difficulty with this setting, do not change the port number. The tandem setting should be configured by your administrator. If the master machine and client machine will switch roles, configure the IP address of the master machine in the client machine. The same port number can be used for both machines.
- In this situation:
  - A saddle stitch finisher is installed in the master machine while not installed in a client machine.
  - Tandem Copy is enabled when specifying copies without stapling.
  - Tandem Copy is disabled when specifying copies with stapling.
  - As shown here, if Tandem Copy is enabled using a function provided in the master machine and not provided in a client machine, a message will appear.
- If a machine runs out of paper
  - If either the master machine or the client machine run out of paper, the machine that ran out of paper will hold the job while the machine that still has paper continues the job. When paper is added to the machine that ran out, the job resumes.
- If user authentication is specified
  - Tandem Copy is enabled when user authentication is specified in the master machine.
  - Tandem Copy is disabled when user authentication is specified in the client machine while it is not specified in the master machine.
- If an odd number of sets is being made, one more set is output to the master machine.



### To use Tandem Copy:

In "Settings (administrator)", select [System Settings] → [Common Settings] → [Operation Settings] → [Condition Settings] → [Tandem Connection Setting].



1

**Place the original.**

Place the original in the document feeder tray of the automatic document feeder, or on the document glass. When using the document glass to scan multiple original pages, change the original and tap the [Start] key.

- ▶ [AUTOMATIC DOCUMENT FEEDER \(page 1-116\)](#)
- ▶ [DOCUMENT GLASS \(page 1-120\)](#)

2

**Tap the [Others] key, and tap the [Tandem Copy] key.**

A checkmark appears on the icon.  
After the settings are completed, tap the [Back] key.



**To cancel the Tandem Copy setting:**  
Tap the [Tandem Copy] key to uncheck it.

3

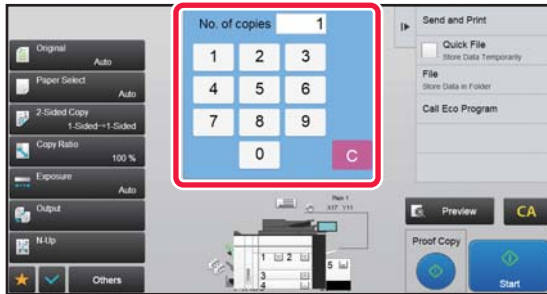

**Tap the number of copies key to specify the number of copies.**

Up to 9999 copies (sets) can be set. The specified number of copies are shared between the master and client machines. If the number of copies is odd, the master machine makes more copies than the client machine.



- **If an incorrect number of copies is set:**  
Tap the [C] key and then enter the correct number.
- **To cancel all settings:**  
Tap the [CA] key.

4

**Tap the [Start] key to start copying.**



- **To cancel Tandem Copy:**  
Tap the [Cancel Copy] keys on both the master and client machines.



# SECURITY REINFORCEMENT FUNCTIONS

## PADDING UNAUTHORIZED COPY PREVENTION DATA (HIDDEN PATTERN PRINT)

Characters to prevent unauthorized copying such as pre-set or customized text are placed as invisible characters in a background pattern.

When an output sheet with a pattern print is copied, the hidden characters will appear.

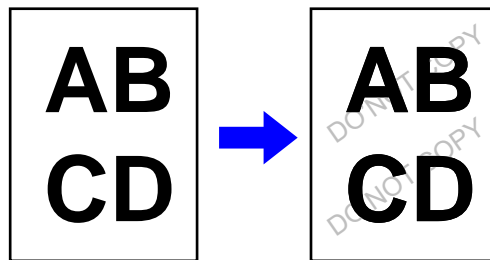

- "Hidden Pattern Print" is a function provided for the purpose of deterring unauthorized copying. It does not guarantee the prevention of information leakage.
- Text may not be completely hidden on an output sheet with a hidden pattern print under certain machine conditions. In such a case, adjust the contrast by selecting the [Hidden Pattern Print Setting] from the "Settings (administrator)".
- When copying an output sheet with a hidden pattern print, the hidden pattern may not emerge depending on settings other than "Hidden Pattern Print".
- The hidden pattern may not emerge on copies with certain types of devices or under certain setting conditions used to copy an output sheet with a hidden pattern print.



### To set a Hidden Pattern Print:

In "Settings (administrator)", select [System Settings] → [Security Settings] → [Hidden Pattern Print Setting].

**1**

### Place the original.

Place the original in the document feeder tray of the automatic document feeder, or on the document glass.

- ▶ [AUTOMATIC DOCUMENT FEEDER \(page 1-116\)](#)
- ▶ [DOCUMENT GLASS \(page 1-120\)](#)

**2**

### Tap the [Others] key, and tap the [Hidden Pattern Print] key.



3

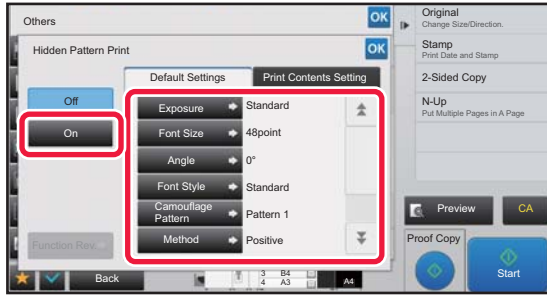

Tap the [On] key, and specify each item in the [Default Settings] tab as required.



We recommend you to select the [Positive] option for the "Method".

4

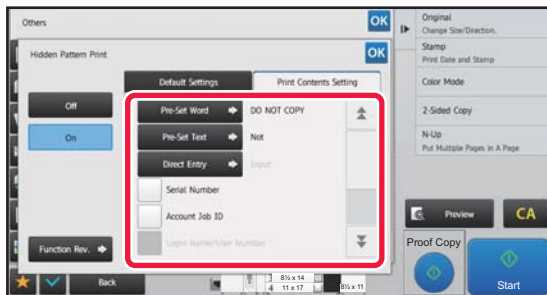

Specify each item in the [Print Contents Setting] tab as required.

To specify print settings, you can select the required one from pre-set text or use the soft keyboard. You can also print serial number and account job ID.

After the settings are completed, tap **OK** and [Back] keys in sequence.



• **To cancel the Hidden Pattern Print setting:**

Tap the [Off] key.

• Tapping the [Function Rev.] key displays the settings of the [Print Contents Setting] tab.

• The hidden pattern print preview may slightly differ from the actual pattern and exposure as the preview is used for simple pattern checking.

• **To cancel all settings:**

Tap the [CA] key.

5

Tap the [Start] key to start copying.



## FORCIBLY PRINTING TRACEABLE INFORMATION (TRACKING INFORMATION PRINT)

This function forcibly prints the pre-specified traceable information to prevent an unauthorized copy.



- If this function is specified together with another image compositing function, trace information is printed at the top.
- Trace information is printed at the top or bottom outside an image frame.
- The information added at printing or the preview image of the account job ID and date/time are displayed as shown below.  
Account job ID: 00000  
Date/time: MM/DD/YYYY hh:mm



### To configure print settings:

In "Settings (administrator)", select [System Settings] → [Security Settings] → [Tracking Information Print] → [Tracking Information Print Setting].





# OUTPUT POSITION AND MARGIN ADJUSTMENT FUNCTIONS



## ADDING MARGINS (MARGIN SHIFT)

This function shifts the copy image right, left or down to adjust the margin.

This is convenient when you wish to bind the copies with a string or in a binder.

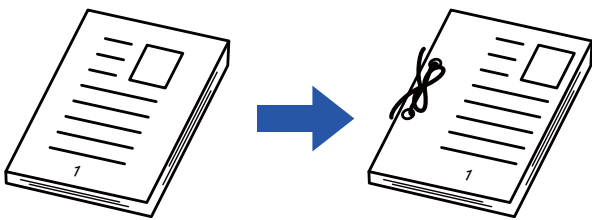
**Shifting the image to the right so the copies can be bound at the left edge**

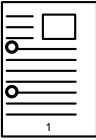

| Not using the Margin Shift   | Using the Margin Shift  |
|--|---|
|  |  |
| The punch holes cut off part of the image  | The image is moved to allow space for the holes so the image is not cut off.        |

### Margin Shift

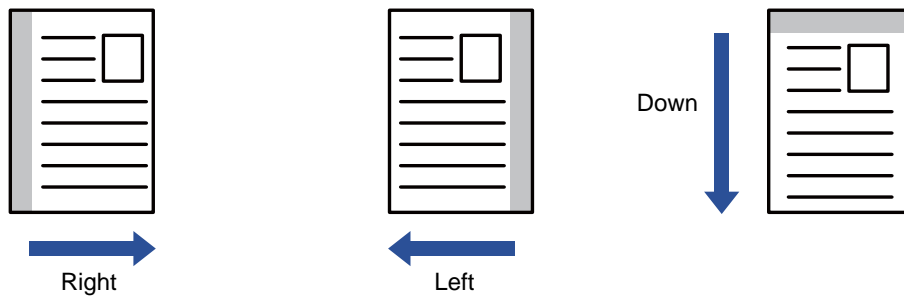

Rotation copy cannot be used in combination with the margin shift function.



#### To change the default margin shift setting:

In "Settings (administrator)", select [System Settings] → [Copy Settings] → [Condition Settings] → [Initial Margin Shift Setting].

Specify a value from 0" (0 mm) to 2" (50 mm) in increments of 1/8" (1 mm) for both the front and reverse sides.

**1**

### Place the original.

Place the original in the document feeder tray of the automatic document feeder, or on the document glass.

► [AUTOMATIC DOCUMENT FEEDER \(page 1-116\)](#)

► [DOCUMENT GLASS \(page 1-120\)](#)

**2**

### Tap the [Others] key, and tap the [Margin Shift] key.



3

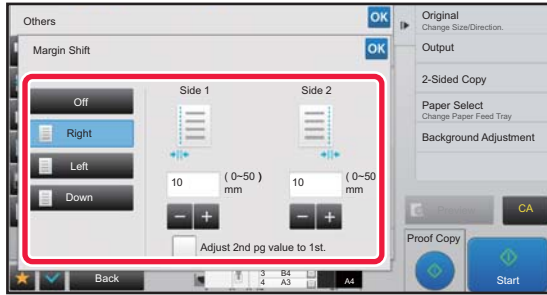

Tap the image shift direction.

4

#### Sets a margin shift width.

Tap the numeric value display indicating the margin shift area on the front side or reverse side, and enter the area using the numeric keys.

After the settings are completed, tap **OK** and [Back] keys in sequence.



If you set the [Adjust 2nd pg value to 1st.] checkbox to ,  goes out and you can set sides 1 and 2 separately.



- **To cancel the margin shift setting:**

Tap the [Off] key.

- **To cancel all settings:**

Tap the [CA] key.

5

Tap the [Start] key to start copying.



# ERASING PERIPHERAL SHADOWS FOR COPYING (ERASE)

The erase function is used to erase shadows around the edges of copies that occur when copying thick originals or books.

**When a thick book is copied**

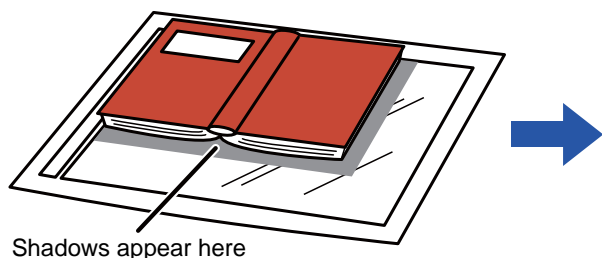

| Not using the Erase        | Using the Erase                   |
|----------------------------|-----------------------------------|
|                            |                                   |
| Shadows appear on the copy | Shadows do not appear on the copy |

## Erase modes

Outer Frame Erase

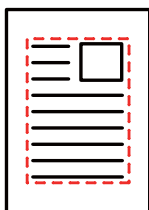

Center Erase

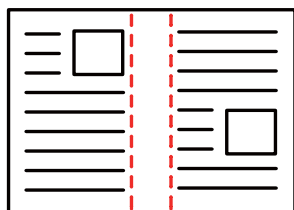

Edge + Center Erase

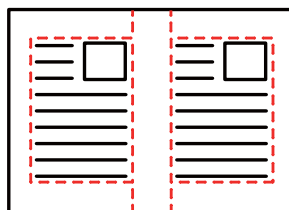

Side Erase

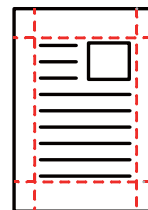

- If a ratio setting is used in combination with an erase setting, the erase width will change according to the selected ratio. If the erase width setting is 1" (20 mm) and the image is reduced to 50%, the erase width will be 1/2" (10 mm).
- This function erases the parts of the image where shadows tend to form, but does not detect shadows and erase only the shadows.
- When Erase is selected, the orientation of the original is automatically set to portrait.



### To change the default erase width setting:

In "Settings (administrator)", select [System Settings] → [Copy Settings] → [Condition Settings] → [Erase Width Adjustment]. Specify a value from 0" (0 mm) to 1" (25 mm) in increments of 1/8" (3 mm) for both edge erase and center erase. The changed setting is also applied to the Setting mode selection of [System Settings] → [Image Send Settings] → [Common Settings] → [Condition Settings] → [Erase Width Adjustment].

**1**

## Place the original.

Place the original in the document feeder tray of the automatic document feeder, or on the document glass.

- ▶ [AUTOMATIC DOCUMENT FEEDER \(page 1-116\)](#)
- ▶ [DOCUMENT GLASS \(page 1-120\)](#)

**2**

## Tap the [Others] key, and tap the [Erase] key.



3

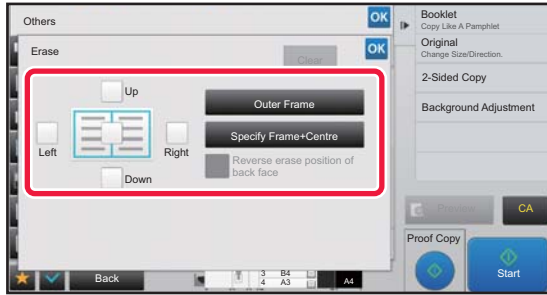

**Tap the checkbox of the edge that you wish to erase, and specify the erase position.**

Check that the tapped checkbox is set to .

If the [Outer Frame] key is tapped, the [Up], [Down], [Left], and [Right] checkboxes are set to .

If the [Specify Frame+Center] key is tapped, all the checkboxes are set to .



Specify the erase edge on the reverse side when erasing edges of one to three sides of Up, Down, Left, and Right on the front side to scan a 2-sided original.

- If the [Reverse erase position of back face] checkbox is set to , the edge in the position opposite to the erased edge on the front side will be erased.
- If the [Reverse erase position of back face] checkbox is set to , the edge in the same position as on the front side will be erased.

4

**Specify the erase width.**

Tap the numeric value display indicating the erase width area on the front side or reverse side, and enter the area using the numeric keys.

After the settings are completed, tap **OK** and [Back] keys in sequence.



To quickly set the area, first specify a value close to the desired value by the numeric keys, then adjust it with **-** **+**.



**To cancel the erase setting:**

Tap the [Clear] key.

**To cancel all settings:**

Tap the [CA] key.

5

**Tap the [Start] key to start copying.**



# COPYING ORIGINALS WITH NO EDGE CUT-OFF (FULL BLEED COPY)

This feature lets you copy an entire original to paper larger than the original size with no image cut-off at the edges.

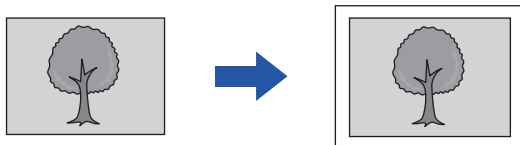

The punch function cannot be used.

**1**

## Tap the [Others] key, and tap the [Full Bleed Copy] key.

"Select larger paper size than output image size of original." is displayed on the page.

Tap [OK].

When you have finished selecting other settings, tap the [Back] key.



### To cancel the full bleed copy setting:

Tap the [Full Bleed Copy] key to uncheck it.

**2**

## Place the original.

► [AUTOMATIC DOCUMENT FEEDER \(page 1-116\)](#)

► [DOCUMENT GLASS \(page 1-120\)](#)

**3**

## Select paper larger than the output image

► [SELECTING THE PAPER TRAY FOR COPYING \(page 2-12\)](#)

► [SPECIFYING A TYPE AND SIZE OF PAPER LOADED ON BYPASS TRAY \(page 2-35\)](#)



### To cancel all settings:

Tap the [CA] key.

**4**



## Tap the [Start] key to start copying.



## COPYING IN THE CENTER OF THE PAPER (CENTERING)

This function centers the copied image on the paper.

This lets you place the image in the center of the paper when the original size is smaller than the paper size or when the image is reduced.

| Not using the centering function  | Using the centering function  |
|---|---|
|  |  |



Centering must be specified before scanning the original.



- When the original size or the paper size is displayed as a special size, this function cannot be used.
- This function cannot be used in combination with an enlargement setting. If enlargement of 101% or more is selected, the enlargement is automatically returned to 100%.

1

### Tap the [Others] key, and tap the [Centering] key.

A checkmark appears on the icon.

After the settings are completed, tap the [Back] key.



- **To cancel the centering setting:**  
Tap the [Centering] key to clear the checkmark.
- **To cancel all settings:**  
Tap the [CA] key.

2

### Tap the [Start] key to start copying.



## SPECIFYING A PAPER POSITION (POSITION IMAGE)

This function moves the scanned original to a specified position to make a copy. You can make a copy in any desired position as you can fine adjust the position. We recommend that you specify the top as the starting side of the original.

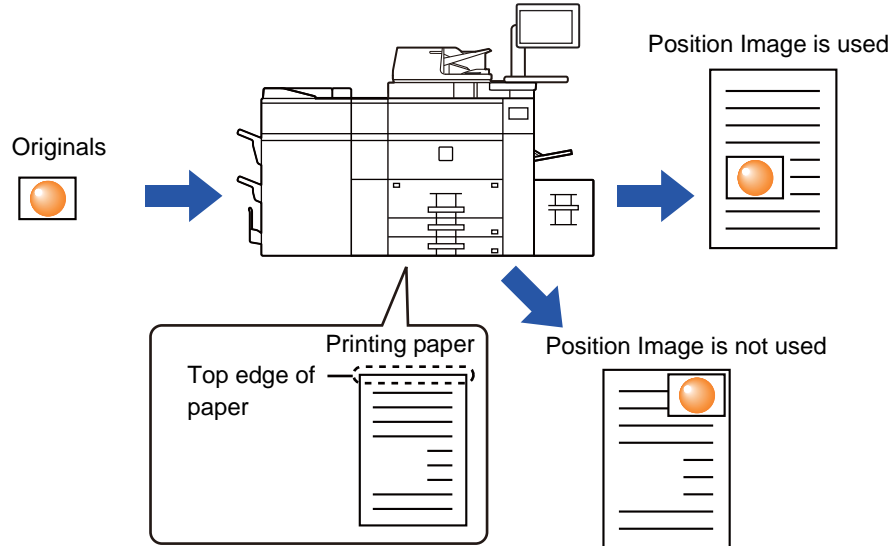
**1**

### Copy the original that you want to use for Move Copy.

Copying is performed without using move copy.

**2**

### Measure the movement amount with the top as the starting side of the output copy.

**3**

### Tap the [Others] key, and tap the [Position Image] key.



Tap the [Original] key and specify the orientation of the original to have the orientation be correctly recognized.

► [Specifying the orientation of the original \(page 2-29\)](#)



4

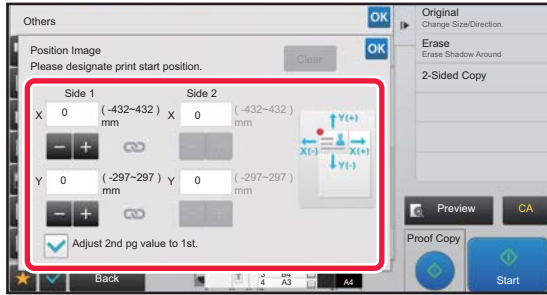

### Sets a movement distance.

Tap the area indicating the movement distance on the front or reverse side, and enter the distance using numeric keys. After the settings are completed, tap **OK** and [Back] keys in sequence.



- To quickly set the area, first specify a value close to the desired value by the numeric keys, then adjust it with **-** **+**.
- If you set the [Adjust 2nd pg value to 1st.] checkbox to ,  goes out and you can set sides 1 and 2 separately.
- If you want to copy in the horizontal orientation, specify "Left" as the starting side of the original. Even if you copied in the horizontal orientation, setting the starting side of the original to the top enables measurement of the movement distance in the same way as in the vertical orientation.



#### To cancel the Position Image setting:

Tap the [Clear] key.

5

### Place the original.

Place the original in the document feeder tray of the automatic document feeder, or on the document glass.

- ▶ [AUTOMATIC DOCUMENT FEEDER \(page 1-116\)](#)
- ▶ [DOCUMENT GLASS \(page 1-120\)](#)



#### To cancel all settings:

Tap the [CA] key.

6

### Tap the [Start] key to start copying.





# SCANNING FUNCTIONS

## COLLECTIVELY SCANNING A LARGE NUMBER OF ORIGINALS (JOB BUILD)

This function divides the originals into sets and feeds each set through the automatic document feeder one set at a time when copying a very large number of originals. This saves you the trouble of sorting the copies.

When scanning originals that are separated into sets, scan the set that has the first page first.

The individual copy settings can be configured for each set of originals to be scanned separately.

Up to 100 sets of originals can be scanned for one job.

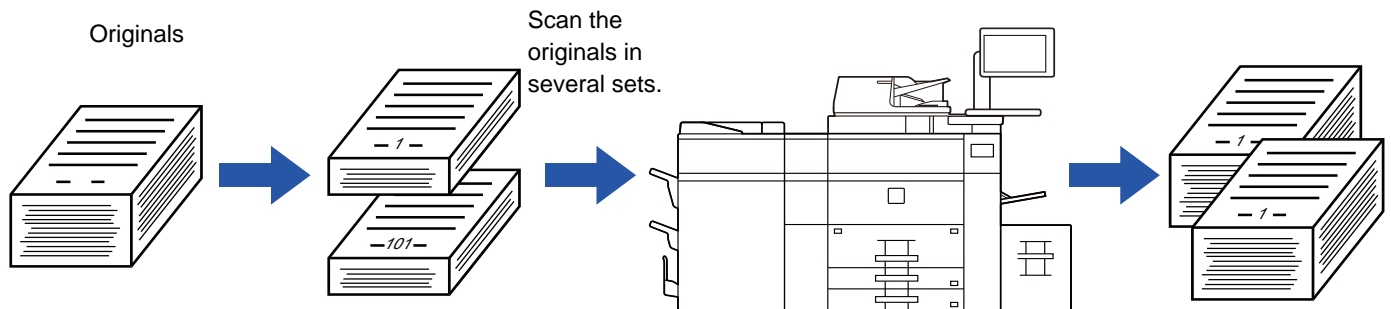

- You must select Job Build mode before scanning the original.
- If you needed to change all original settings, change before scanning the original.
- If the Quick File Folder of document filing mode is full, copying in job build mode will be impeded. Delete unnecessary files from the Quick File Folder.



The Job Build mode cannot be combined with other functions.

- Dual Page Copy
- Book Copy
- Card shot
- Multi-Page Enlargement
- Full Bleed Copy
- Repeat Layout

## Copying in job build mode

**1**

**Tap the [Others] key, and tap the [Job Build] key.**

A checkmark appears on the icon.

After the settings are completed, tap the [Back] key.



**To cancel the job build setting**

Tap the [Job Build] key to uncheck it.



2

Change settings as needed.

3

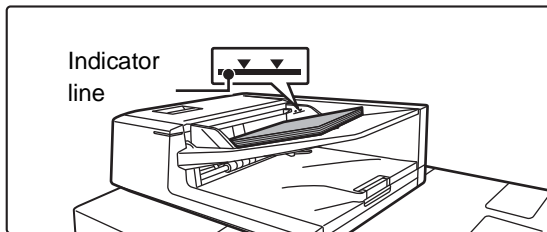

Place the original in the document feeder tray of the automatic document feeder, and tap the [Start] key to scan the first original.

Insert the originals all the way into the document feeder tray. Originals can be stacked up to the indicator line.

► [AUTOMATIC DOCUMENT FEEDER \(page 1-116\)](#)

4



Place the next set of originals and tap the [Start] key.

Repeat this step until all originals have been scanned.



- To change copy settings for each set of originals, tap the [Change Setting] key. For more information, see "[Changing the copy settings for each set of originals \(page 2-91\)](#)".
- If you tap the [Preview] key, you cannot scan additional pages.

5

Repeat until all pages have been scanned and check the preview image in the preview screen.



To cancel all settings:  
Tap the [CA] key.

6

Tap the [Read-End] key to start copying.



## Changing the copy settings for each set of originals

As necessary, change copy settings for each set of originals.

Perform the steps below before scanning the next set of originals in step 4 of "[Copying in job build mode \(page 2-89\)](#)".

---



A [Separator Page] setting cannot be changed for the second and later sets.

---

1

**Tap the [Change Setting] key.**

---

2

**Change copy settings.**

---

3

**Place the next set of originals and tap the [Start] key.**

Repeat this step until all originals have been scanned.

---



## SCANNING ORIGINALS OF DIFFERENT SIZES (MIXED SIZE ORIGINAL)

This feature copies originals in different sizes at the same time even when 8-1/2" x 14" (B4) size originals are mixed with 11" x 17" (A3) size originals.

When scanning the originals, the machine automatically detects the size of each original and uses paper appropriate for that size.

When mixed size original is combined with auto ratio selection, the ratio is adjusted individually for each original according to the selected paper size, enabling printing on a uniform paper size.

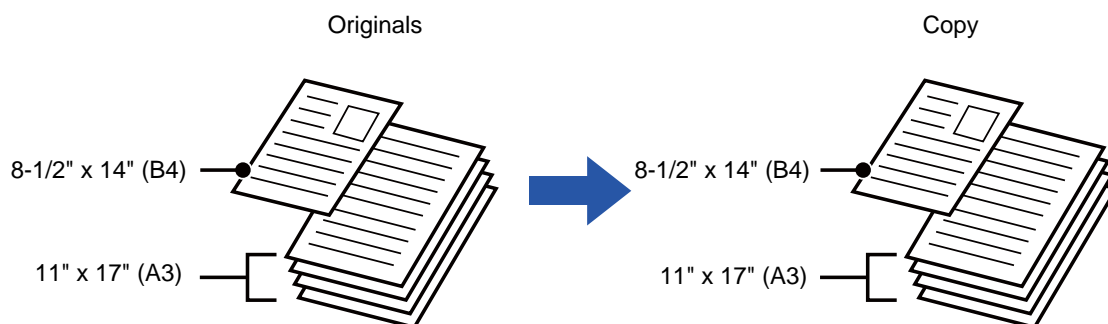

### When mixed size original is combined with auto ratio selection

(Auto ratio selection and 11" x 17" (A3) are selected)

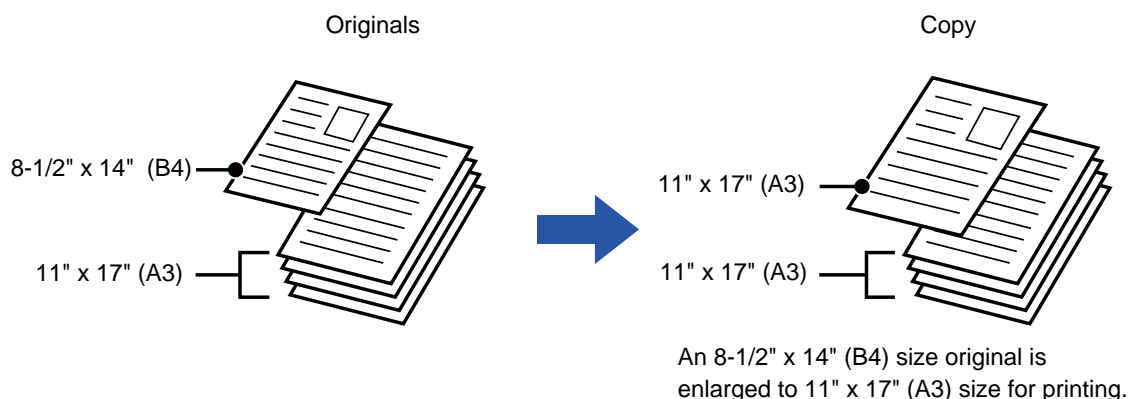

There are two settings for mixed size originals.

|                        |  |
|------------------------|--|
| <b>Same Width</b>      | <p>Use this setting for originals that are different sizes but have sides that are the same length. The originals are inserted in the document feeder tray with the sides that are the same length aligned together on the left.</p> <ul style="list-style-type: none"> <li>• 11" x 17" and 8-1/2" x 11"</li> <li>• 8-1/2" x 14" and 8-1/2" x 11"R      • 8-1/2" x 14" and 5-1/2" x 8-1/2"</li> <li>• 8-1/2" x 13" and 8-1/2" x 11"R</li> <li>• 8-1/2" x 13" and 5-1/2" x 8-1/2"      • 8-1/2" x 11"R and 5-1/2" x 8-1/2"</li> <li>• A3 and A4    • B4 and B5    • A4R and A5</li> </ul> |
| <b>Different Width</b> | <p>Use this setting when the originals are different sizes and do not have sides that are the same length. This setting can only be used for the following combinations of sizes:</p> <ul style="list-style-type: none"> <li>• 11"x17" and 8-1/2"x14"      • 11"x17" and 8-1/2"x13"      • 11"x17" and 5-1/2"x8-1/2"</li> <li>• A3 and B4    • A3 and B5    • B4 and A5    • A4 and B5    • B4 and A4R    • B4 and A5</li> <li>• B5 and A4R    • B5 and A5</li> </ul>  |



Mixed Size Original must be specified before scanning the original.



- When [Different Width] is selected, the staple function cannot be used.
- The mixed size original function cannot be used to copy originals that are the same size but are placed in different orientations (8-1/2" x 11" and 8-1/2" x 11"R (A4 and A4R), etc.).

**To set the machine to always scan mixed originals**

- In "Settings (administrator)", select [System Settings] → [Common Settings] → [Device Control] → [Condition Settings] → [Original Feeding Mode].
- Output, N-Up, and other functions will have the same settings as the first page.

1

Tap the [Others] key, and tap the [Mixed Size Original] key.

2

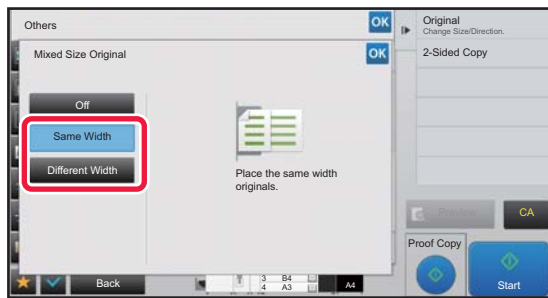

Tap the [Same Width] key or the [Different Width] key as appropriate for the originals.

After the settings are completed, tap **OK** and [Back] keys in sequence.



**To cancel the mixed size original setting**

Tap the [Off] key.

3

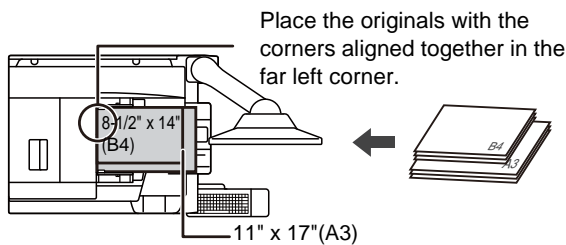

**Place the original face up on the document glass.**

Place the original as shown on the Mixed Size Original screen.



For mixed size originals, set "Original" to "Auto".

4

Tap the [Start] key to start copying.



## SCANNING THIN ORIGINALS (SLOW SCAN MODE)

When you wish to scan thin originals using the automatic document feeder, you can use this function, which helps prevent thin originals from misfeeding.

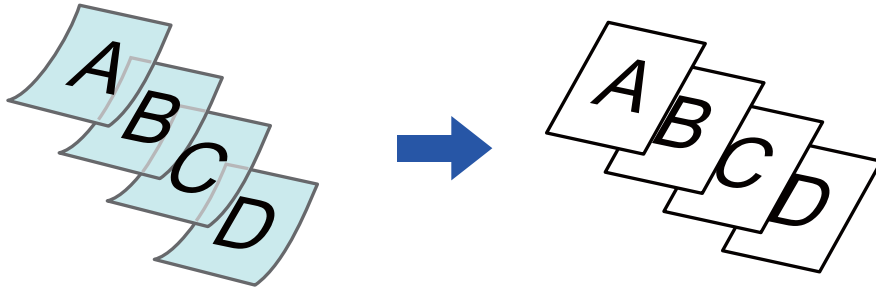

Slow Scan Mode must be specified before scanning the original.



The "2-Sided→2-Sided" and "2-Sided→1-Sided" modes of automatic 2-sided copying cannot be used.



**To always scan the original in the Slow Scan Mode:**

In "Settings (administrator)", select [System Settings] → [Common Settings] → [Device Control] → [Condition Settings] → [Original Feeding Mode].

1

**Tap the [Others] key, and tap the [Slow Scan Mode] key.**

A checkmark appears on the icon.

After the settings are completed, tap the [Back] key.



**To cancel Slow Scan Mode:**

Tap the [Slow Scan Mode] key to clear the checkmark.

2

**Place the original in the document feeder tray of the automatic document feeder.**

► [AUTOMATIC DOCUMENT FEEDER \(page 1-116\)](#)



If the originals are inserted with too much force, they may crumple and misfeed.

3

**Tap the [Start] key to start copying.**



## SCANNING HEAVY ORIGINALS (HEAVY PAPER SCAN)

When you wish to scan heavy originals using the automatic document feeder, you can use this function, which helps prevent heavy originals from misfeeding.

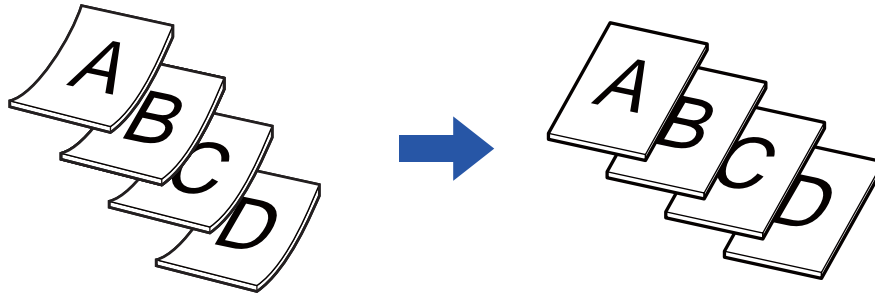

Heavy Paper Scan must be specified before scanning the original.

**1**

### Tap the [Others] key, and tap the [Heavy Paper Scan] key.

A checkmark appears on the icon.  
After the settings are completed, tap the [Back] key.



#### To cancel Heavy Paper Scan:

Tap the [Heavy Paper Scan] key to clear the checkmark.

**2**

### Place the original in the document feeder tray of the automatic document feeder.

► [AUTOMATIC DOCUMENT FEEDER \(page 1-116\)](#)



If the originals are inserted with too much force, they may crumple and misfeed.

**3**

### Tap the [Start] key to start copying.



# ADJUSTING RESOLUTION WHEN SCANNING (RESOLUTION)

This function adjusts the resolution when scanning the original, enabling the high-quality output or speed-priority output according to the application.



- Resolution must be specified before scanning the original.
- The resolution setting is applied when making a full-size copy.

1

Tap the [Others] key, and tap the [Scan Resolution] key.

2

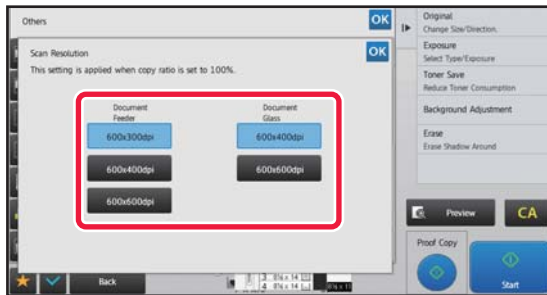

## Select the resolution.

The resolution can be set to both the document feeder and document glass.

After the settings are completed, tap **OK** and [Back] keys in sequence.

3

## Place the original.

Place the original in the document feeder tray of the automatic document feeder, or on the document glass.

- ▶ [AUTOMATIC DOCUMENT FEEDER \(page 1-116\)](#)
- ▶ [DOCUMENT GLASS \(page 1-120\)](#)

4

Tap the [Start] key to start copying.



### • High Quality Scan from Document Feeder

In "Settings (administrator)", select [System Settings] → [Copy Settings] → [Condition Settings] → [High Quality Scan from Document Feeder]. The resolution for copying using the automatic document feeder can be changed from 600 x 300 dpi to 600 x 600 dpi (high quality mode). When high quality mode is used, fine print and thin lines are reproduced with greater clarity, however, the scanning speed is slower. When high quality mode is not selected, the following conditions must be satisfied in order to scan at 600 x 300 dpi and attain the fastest speed.

- The copy ratio must be set to 100%.
- Do not select a special mode that will change the ratio.
- [Copy of Copy] must not be enabled.

### • Quick Scan from Document Glass

In "Settings (administrator)", select [System Settings] → [Copy Settings] → [Condition Settings] → [Quick Scan from Document Glass (disabled by factory default)]. The resolution for copying using the document glass can be changed from 600 x 600 dpi to 600 x 400 dpi (high speed mode). When high speed mode is selected, the first copy time is quicker, however, the copy image is not as clear. When high quality mode is not selected, the following conditions must be satisfied in order to scan at 600 x 400 dpi and attain the fastest speed.

- The copy ratio must be set to 100%.
- Do not select a special mode that will change the ratio.
- [Copy of Copy] must not be enabled.





## TEXT AND IMAGE ADDITION FUNCTIONS

### PRINTING DATES, PAGE NUMBERS, AND WATERMARKS (STAMP)

This function prints information such as the "Date" or "Stamp", which is not shown on the original, on copies. You can print the following six types of information.

- Date
- Page No.
- Stamp
- Copies
- Text
- Watermark

For the stamp or watermark, you can print text such as "CONFIDENTIAL" or "PRIORITY". You can print pre-set text or any characters as the text.

Each of the items above can be printed on the header or footer of each sheet.

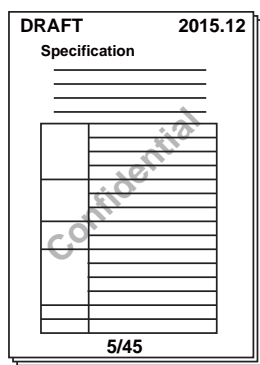

- If the selected stamp content of one position overlaps the stamp content of another position, priority will be given in the following order: watermark, right side, left side, center. Content that is hidden due to overlapping will not be printed.
- Text will be printed at the preset size regardless of the copy ratio or paper size setting.
- Text will be printed at the preset exposure regardless of the exposure setting.
- Depending on the size of the paper, some printed content may be cut off or shifted out of position.



#### Text Setting (Stamp) in Print menu

In "Settings (administrator)", select [System Settings] → [Copy Settings] → [Condition Settings] → [Text /Image Printing] → [Text Settings (Stamp)]

Register preset text to be used in [Stamp].

### When [Stamp] is combined with other functions:

| Combined function name                     | Print operation   |
|--|---|
| Margin Shift                               | Together with the image, the stamp content is shifted the amount of the margin width.       |
| Tab Copy<br>Centering                      | Unlike a copy image that moves, the image will be printed in the position set in the stamp. |
| Dual Page Copy<br>Book Divide<br>Card Shot | Stamp items are printed for each copy sheet.  |
| N-Up                                       | Stamp items are printed for each original page.   |
| Booklet<br>Book Copy                       | Stamp items are printed for each page when compiling.                                       |



| Combined function name | Print operation   |
|------------------------|---|
| Covers/Inserts         | Use the stamp settings to select whether or not the item is printed on inserted covers and inserts. |

1

**Place the original.**

Place the original in the document feeder tray of the automatic document feeder, or on the document glass.

- ▶ [AUTOMATIC DOCUMENT FEEDER \(page 1-116\)](#)
- ▶ [DOCUMENT GLASS \(page 1-120\)](#)

2

**Tap the [Others] key, and tap the [Stamp] key.**

3

**Tap a tab to be printed, and tap the format.**

The format of the [Text] tab can be entered using pre-set text or soft keyboard.

- ▶ [Setting using the \[Text\] tab \(page 2-99\)](#)



When you tap the  tab, the display tab is switched.

4

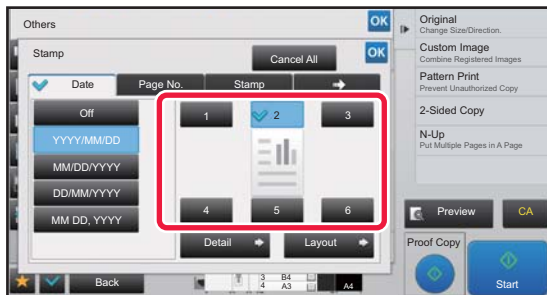

**Tap a key of the desired print position.**

Tap any of [1] to [6] keys.



- Tapping the [Detail] key allows you to configure setting for each setting position.
- Tapping the [Layout] key allows you to check the printing position or detailed settings.



- To cancel the text settings:  
Tap the [Cancel All] key.
- To cancel all settings:  
Tap the [CA] key.

5

**Tap the [Start] key to start copying.**



## Setting using the [Text] tab

Tap the [Direct Entry] key in the [Text] tab to display the soft keyboard.  
Use the soft keyboard to enter any characters.

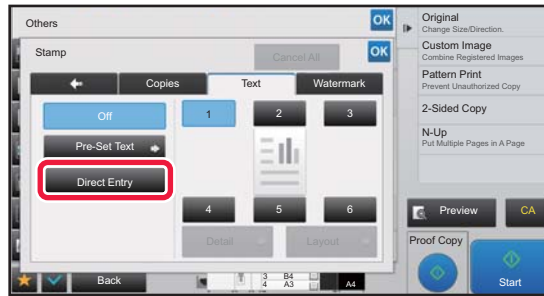

## Selecting the format from pre-set text

Tapping the [Pre-Set Text] key allows you to select the required one of the registered formats for printing.  
Tapping the [Store/Delete] key allows you to edit, delete, or store pre-set text.





## ADDING A REGISTERED IMAGE TO AN ORIGINAL (CUSTOM IMAGE)

This function adds an image registered in the machine to an original to make a copy. Following are two types of custom images.

- Custom stamp (Stamp image)

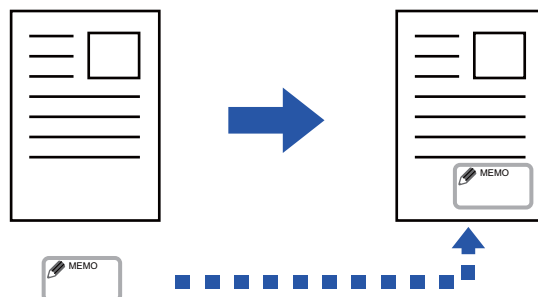

- Custom watermark (Stamp image with gray-scale watermark)

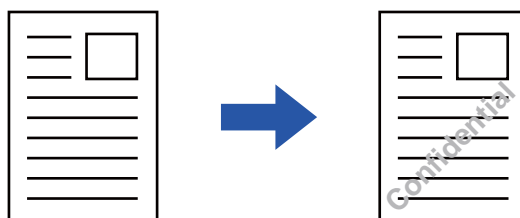

The combination with other functions is described in the table below.

| Combined function    | Custom image operations   |
|----------------------|---|
| Margin Shift         | Shifts in the same way as for an original image.                |
| Erase                | Makes a stamp copy as normal.                                   |
| Dual Page Copy       | Makes a stamp copy by sheet.                                    |
| Booklet              | Makes a stamp copy as normal.                                   |
| Job Build            | Makes a stamp copy as normal.                                   |
| Tandem Copy          | Based on the tandem copy.                                       |
| Covers/Inserts       | Based on the custom image setting.                              |
| Separator Page       | Printing does not take place on separator pages.                |
| Transparency Inserts | Makes a stamp copy as normal.                                   |
| N-Up                 | Makes a stamp copy by sheet.                                    |
| Book Copy            | Makes a stamp copy as normal.                                   |
| Tab Copy             | Makes a stamp copy as normal regardless of image shift setting. |
| Card Shot            | Makes a stamp copy by sheet.                                    |
| Business Card Copy   | Makes Business Card Copy by sheet.                              |
| Mirror Image         | Makes a stamp copy as normal without mirror image reverse.      |



| Combined function          | Custom image operations   |
|----------------------------|---|
| B/W Reverse                | Prints an image as normal without B/W reverse. However, the following condition is set when printed on a dark background.<br>Custom stamp: Printed in white<br>Custom watermark: Printed without being whitened |
| Full Bleed Copy            | Makes a stamp copy as normal.   |
| Centering                  | Makes a stamp copy as normal without centering.   |
| Stamp                      | Makes a stamp copy on the Stamp menu.   |
| Photo Repeat               | Cannot be combined.   |
| Multi-Page Enlargement     | Cannot be combined.   |
| Hidden Pattern Print       | Makes a stamp copy under a pattern print.   |
| Tracking Information Print | Makes a stamp copy under a tracking information print.  |
| Repeat Layout              | Cannot be combined.   |
| Position Image             | Prints an image at the original position regardless of the Position Image setting.  |
| Book Divide                | Makes a stamp copy by sheet.  |



- An image must be registered in advance from the printer driver to the machine.
  - ▶ [REGISTERING A CUSTOM IMAGE \(page 3-47\)](#)
- A custom stamp image is copied by sheet, not by original. If N-Up is enabled, user stamps are copied for each set of pages.
- A custom stamp image is copied with the registered size. The size remains unchanged even when the copy ratio is enlarged or reduced.
- A different custom image cannot be specified for each page.
- If an image runs off of the specified paper depending on the registered size or position, the excess will not be copied.
- Custom Image can be combined with Tandem Copy.  
Stamp copy is performed when a custom image with the same file name is registered in both the master and client machines.  
If it is not registered, a copy will be made without a custom image.



- **Register a Custom Image**  
In "Settings (administrator)", select [System Settings] → [Copy Settings] → [Condition Settings] → [Text /Image Printing] → [Custom Stamp] or [Custom Watermark].
- **Disabling Registration of Custom Image**  
In "Settings (administrator)", select [System Settings] → [Common Settings] → [Enable/Disable Settings] → [Disabling Registration of Custom Image] and configure the setting.

**1****Place the original.**

Place the original in the document feeder tray of the automatic document feeder, or on the document glass.

- ▶ [AUTOMATIC DOCUMENT FEEDER \(page 1-116\)](#)
- ▶ [DOCUMENT GLASS \(page 1-120\)](#)

**2****Tap the [Others] key, and tap the [Custom Image] key.****3****Tap the [Custom Stamp] or [Custom Watermark] key.**



4

**Tap the [Image] key to select an image.**

Select the required thumbnail image(s) from the available selection.

5

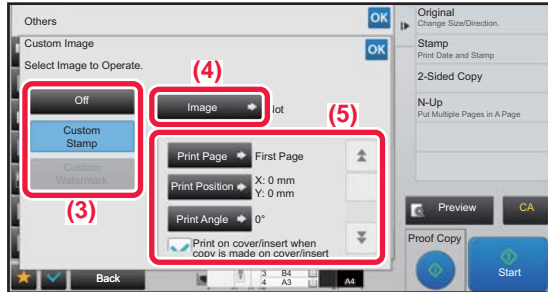

**Set [Print Page] or [Print Position].**

After the settings are completed, tap **OK** and [Back] keys in sequence.



- **To cancel the custom image setting:**  
Tap the [Off] key.
- **To cancel all settings:**  
Tap the [CA] key.

6

**Tap the [Start] key to start copying.**

For settings related to custom stamp and custom water mark, see the following table.

**For custom stamp**

|                |   |
|----------------|---|
| Print Page     | Specify a page(s) for stamp copy. First Page or All Pages                           |
| Print Position | Specify a position for stamp copy.  |
| Print Angle    | Specify the corner of the image. 0 degrees, -90 degrees, 90 degrees, or 180 degrees |

**For custom watermark**

|                |   |
|----------------|---|
| Print Pattern  | Specify the image watermark print pattern.<br>Transparent: Makes an original image transparent for stamp copy.<br>Overlap: Hides a watermark added to an original image for stamp copy. |
| Exposure       | Select the exposure of a watermark from nine levels.  |
| Print Page     | Specify a page(s) for stamp copy.<br>First Page or All Pages  |
| Print Position | Specify a position for stamp copy.  |
| Print Angle    | Specify the corner of the image. 0 degrees, -90 degrees, 90 degrees, or 180 degrees   |



# INSERTING COVERS IN COPIES (COVERS/INSERTS)

This function inserts a different type of paper into the pages corresponding to the front and back covers of a copy job. It is helpful when you want to change cover paper to make resources look better. Configure insertion sheet settings if needed.



- To insert insertion sheets, see "[INSERTING INSERTION SHEETS IN COPIES \(COVERS/INSERTS\) \(page 2-111\)](#)".
- For N-Up, the layout is based on the first page and excludes covers.

## Copying on a front cover and inserting together with a back cover

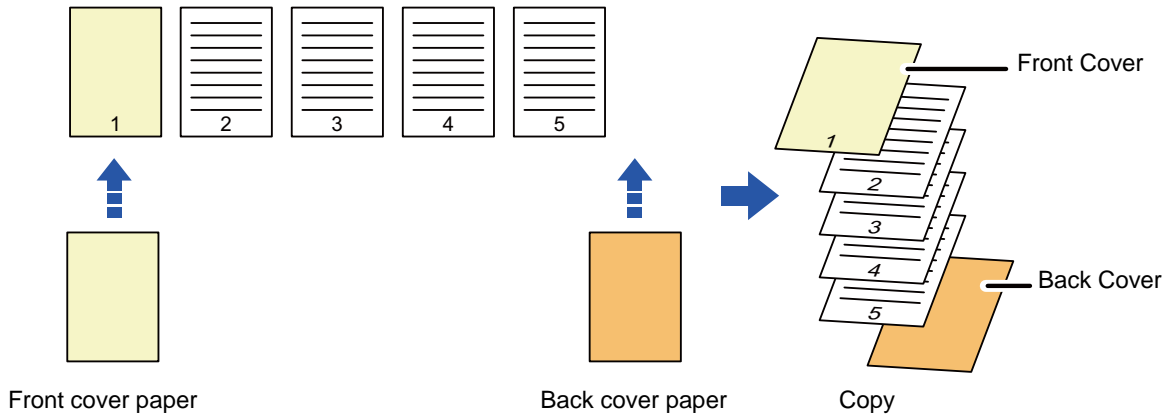

## Cover inserting examples

The following shows the copy results when front and back covers are inserted into six 1-sided original pages or three 2-sided original pages in the four copy modes below.

### 1-sided copying of 1-sided originals

| Setting conditions for each cover |            | Resulting copies   |
|-----------------------------------|------------|--|
| Front Cover                       | Back Cover |  |
| Not copied                        | Not copied | <p>Inserts cover sheets at the beginning and end of copies.</p>  |
| 1-sided copy                      | Not copied | <p>Makes a 1-sided copy on the first original page for front cover, and inserts a back cover at the end of copies.</p>             |
| 2-sided copy                      | Not copied | <p>Makes a 2-sided copy on the first and second original pages for front cover, and inserts a back cover at the end of copies.</p> |



| Setting conditions for each cover |              | Resulting copies  |
|-----------------------------------|--------------|---|
| Front Cover                       | Back Cover   |   |
| Not copied                        | 1-sided copy | <p>Inserts a front cover at the beginning of copies, and makes a 1-sided copy on the sixth original page for back cover.</p>  |
| Not copied                        | 2-sided copy | <p>Inserts a front cover at the beginning of copies, and makes a 2-sided copy on the fifth and sixth original pages for back cover.</p>                                 |
| 1-sided copy                      | 1-sided copy | <p>Makes a 1-sided copy on the first original page for front cover, and also makes a 1-sided copy on the sixth original page for back cover.</p>                        |
| 1-sided copy                      | 2-sided copy | <p>Makes a 1-sided copy on the first original page for front cover, and also makes a 2-sided copy on the fifth and sixth original pages for back cover.</p>             |
| 2-sided copy                      | 1-sided copy | <p>Makes a 2-sided copy on the first and second original pages for front cover, and also makes a 1-sided copy on the sixth original page for back cover.</p>            |
| 2-sided copy                      | 2-sided copy | <p>Makes a 2-sided copy on the first and second original pages for front cover, and also makes a 2-sided copy on the fifth and sixth original pages for back cover.</p> |

**2-sided copying of 1-sided originals**

| Setting conditions for each cover |            | Resulting copies  |
|-----------------------------------|------------|---|
| Front Cover                       | Back Cover |   |
| Not copied                        | Not copied | <p>Inserts cover sheets at the beginning and end of copies.</p> |



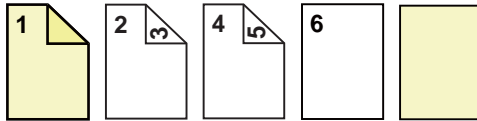
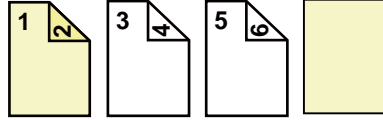
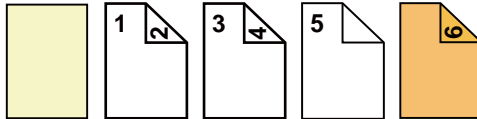
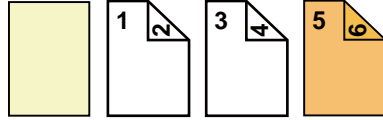
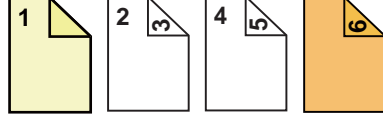
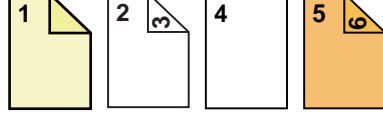
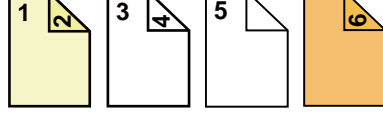

| Setting conditions for each cover |              | Resulting copies   |
|-----------------------------------|--------------|--|
| Front Cover                       | Back Cover   |  |
| 1-sided copy                      | Not copied   |  <p>Makes a 1-sided copy on the first original page for front cover, and also makes a 1-sided copy on the sixth original page. Inserts cover sheets at the end of copies.</p>                                      |
| 2-sided copy                      | Not copied   |  <p>Makes a 2-sided copy on the first and second original pages for front cover, and inserts a back cover at the end of copies.</p>  |
| Not copied                        | 1-sided copy |  <p>Inserts a front cover at the beginning of copies, and makes a 1-sided copy on the sixth original page for back cover. A 1-sided copy is made on the fifth original page.</p>                                   |
| Not copied                        | 2-sided copy |  <p>Inserts a front cover at the beginning of copies, and makes a 2-sided copy on the fifth and sixth original pages for back cover.</p>  |
| 1-sided copy                      | 1-sided copy |  <p>Makes a 1-sided copy on the first original page for front cover, and also makes a 1-sided copy on the sixth original page for back cover.</p>  |
| 1-sided copy                      | 2-sided copy |  <p>Makes a 1-sided copy on the first original page for front cover, and also makes a 2-sided copy on the fifth and sixth original pages for back cover.</p>   |
| 2-sided copy                      | 1-sided copy |  <p>Makes a 2-sided copy on the first and second original pages for front cover, and also makes a 1-sided copy on the sixth original page for back cover. A 1-sided copy is made on the fifth original page.</p> |



| Setting conditions for each cover |              | Resulting copies  |
|-----------------------------------|--------------|---|
| Front Cover                       | Back Cover   |   |
| 2-sided copy                      | 2-sided copy | <p>Makes a 2-sided copy on the first and second original pages for front cover, and also makes a 2-sided copy on the fifth and sixth original pages for back cover.</p> |

**1-sided copying of 2-sided originals**

| Setting conditions for each cover |              | Resulting copies   |
|-----------------------------------|--------------|--|
| Front Cover                       | Back Cover   |  |
| Not copied                        | Not copied   | <p>Inserts cover sheets at the beginning and end of copies.</p>  |
| 1-sided copy                      | Not copied   | <p>Makes a 1-sided copy on the first original page for front cover, and inserts a back cover at the end of copies.</p>                           |
| 2-sided copy                      | Not copied   | <p>Makes a 2-sided copy on the first and second original pages for front cover, and inserts a back cover at the end of copies.</p>               |
| Not copied                        | 1-sided copy | <p>Inserts a front cover at the beginning of copies, and makes a 1-sided copy on the sixth original page for back cover.</p>                     |
| Not copied                        | 2-sided copy | <p>Inserts a front cover at the beginning of copies, and makes a 2-sided copy on the fifth and sixth original pages for back cover.</p>          |
| 1-sided copy                      | 1-sided copy | <p>Makes a 1-sided copy on the first original page for front cover, and also makes a 1-sided copy on the sixth original page for back cover.</p> |

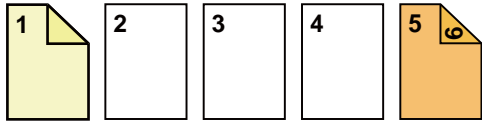
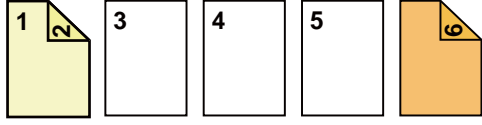
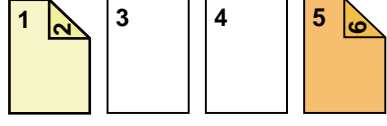

| Setting conditions for each cover |              | Resulting copies   |
|-----------------------------------|--------------|--|
| Front Cover                       | Back Cover   |  |
| 1-sided copy                      | 2-sided copy |  <p>Makes a 1-sided copy on the first original page for front cover, and also makes a 2-sided copy on the sixth original page for back cover.</p>                        |
| 2-sided copy                      | 1-sided copy |  <p>Makes a 2-sided copy on the first and second original pages for front cover, and also makes a 1-sided copy on the sixth original page for back cover.</p>            |
| 2-sided copy                      | 2-sided copy |  <p>Makes a 2-sided copy on the first and second original pages for front cover, and also makes a 2-sided copy on the fifth and sixth original pages for back cover.</p> |



**2-sided copying of 2-sided originals**

| Setting conditions for each cover |              | Resulting copies  |
|-----------------------------------|--------------|---|
| Front Cover                       | Back Cover   |   |
| Not copied                        | Not copied   | <p>Inserts cover sheets at the beginning and end of copies.</p>   |
| 1-sided copy                      | Not copied   | <p>Makes a 1-sided copy on the first original page for front cover, and inserts a back cover at the end of copies.<br/>* The second original page is not copied.</p>                                      |
| 2-sided copy                      | Not copied   | <p>Makes a 2-sided copy on the first and second original pages for front cover, and inserts a back cover at the end of copies.</p>  |
| Not copied                        | 1-sided copy | <p>Inserts a front cover at the beginning of copies, and makes a 1-sided copy on the sixth original page for back cover.<br/>* The fifth original page is not copied.</p>                                 |
| Not copied                        | 2-sided copy | <p>Inserts a front cover at the beginning of copies, and makes a 2-sided copy on the fifth and sixth original pages for back cover.</p>   |
| 1-sided copy                      | 1-sided copy | <p>Makes a 1-sided copy on the first original page for front cover, and also makes a 1-sided copy on the sixth original page for back cover. The second and the fifth original pages are not copied.</p>  |
| 1-sided copy                      | 2-sided copy | <p>Makes a 1-sided copy on the first original page for front cover, and also makes a 2-sided copy on the fifth and sixth original pages for back cover.<br/>* The second original page is not copied.</p> |



| Setting conditions for each cover |              | Resulting copies  |
|-----------------------------------|--------------|---|
| Front Cover                       | Back Cover   |   |
| 2-sided copy                      | 1-sided copy | <p>Makes a 2-sided copy on the first and second original pages for front cover, and also makes a 1-sided copy on the sixth original page for back cover.<br/>* The fifth original page is not copied.</p> |
| 2-sided copy                      | 2-sided copy | <p>Makes a 2-sided copy on the first and second original pages for front cover, and also makes a 2-sided copy on the fifth and sixth original pages for back cover.</p>                                   |



- Before using the covers/inserts function, load insertion sheets in the tray.
- When selecting the covers/inserts function, place the originals in the document feeder tray, select 1-sided or 2-sided copying, and select the number of copies and any other desired copy settings. When these settings have been completed, perform the procedure to select covers/inserts.
- One sheet can be inserted for each of front and back covers.



- When performing 2-sided copying of 2-sided originals, an insertion sheet cannot be inserted between the front and reverse sides of an original.
- This function cannot be used in combination with the saddle stitch function.
- This setting is not available when the "Covers/Inserts" is disabled in "Settings".



### Disabling of Covers/Inserts Mode

Disables the use of the covers and inserts function.

In "Settings (administrator)", select [System Settings] → [Common Settings] → [Operation Settings] → [Condition Settings] → [Disabling of Covers/Inserts Mode].

1

Place the original in the document feeder tray of the automatic document feeder.

▶ [AUTOMATIC DOCUMENT FEEDER \(page 1-116\)](#)

2

Tap the [Others] key, and then tap the [Covers/Inserts] key.

3

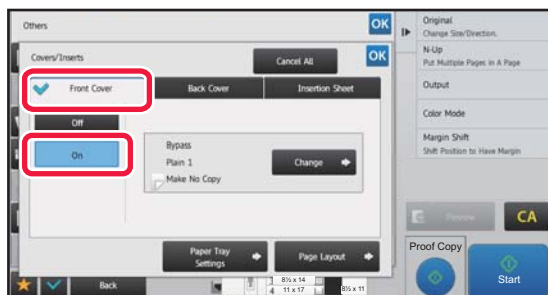

Tap the [Front Cover] key, and then tap the [On] key.

When inserting a back cover, tap the [Back Cover] tab, and then tap the [On] key.



4

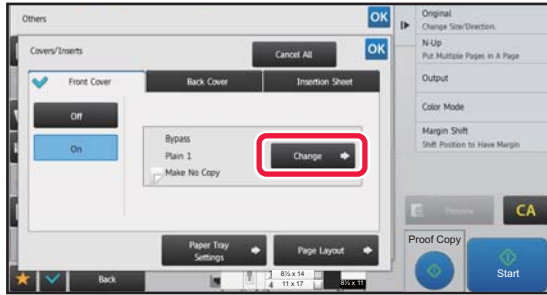

Tap the [Change] key.

5

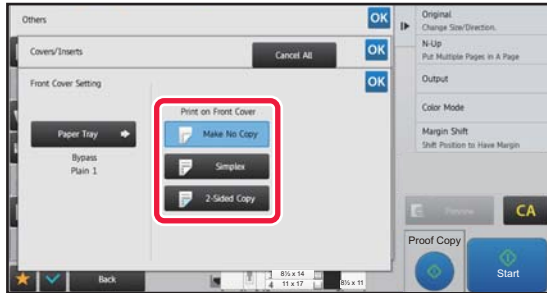

**Configure copy setting of a front cover sheet.**

When only inserting a cover, tap the [Make No Copy] key. If you selected the [2-Sided Copy] key, tap the [Book] or [Tablet] key for the front cover binding. After the settings are completed, tap **OK** and [Back] keys in sequence.



**To change the cover input tray:**

Tap the [Paper Tray Settings] key to display the input tray setting screen. On the input tray setting screen, tap the [Paper Tray] key of [Front Cover] or [Back Cover].  
For more information, see "[SELECTING THE PAPER TRAY FOR COPYING \(page 2-12\)](#)".



- If the cover will be copied on, label sheets, transparency film, and tab paper cannot be used. If not copied on, tab paper can be inserted.
- **To cancel cover sheet insertion:**  
Tap the [Off] key.
- **To cancel the front cover, back cover, and insertion sheet settings at the same time:**  
Tap the [Cancel All] key.
- **To cancel all settings:**  
Tap the [CA] key.

6

Tap the [Start] key to start copying.



# INSERTING INSERTION SHEETS IN COPIES (COVERS/INSERTS)

This function inserts a sheet of paper into a specific page as an insertion sheet. There are two types of insertion sheets. Insertion positions can be specified. Insert covers if needed.



When inserting covers, see "[INSERTING COVERS IN COPIES \(COVERS/INSERTS\) \(page 2-103\)](#)".

**Example: Insert A after page 3 and insert B after page 5.**



## Sheet inserting examples

The following examples show the copy results when insertion sheets are inserted into six 1-sided originals or three 2-sided originals using two copy modes.

### 1-sided original copying

| Insertion sheet setting conditions | Resulting copies  |   |
|------------------------------------|---|---|
|                                    | Insert an insertion sheet in 1-sided copy mode.                                 | Insert an insertion sheet in 2-sided copy mode. |
| Not copied                         | <p>Inserts an insertion sheet between the second and third pages of copies.</p> |   |
| 1-sided copy                       | <p>Makes a 1-sided copy of the third original page on an insertion sheet.</p>   |   |

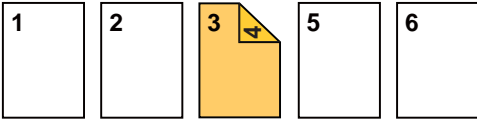
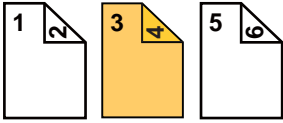

| Insertion sheet setting conditions | Resulting copies  |   |
|------------------------------------|---|---|
|                                    | Insert an insertion sheet in 1-sided copy mode.   | Insert an insertion sheet in 2-sided copy mode.                                     |
| 2-sided copy                       |  <p>Makes a 2-sided copy of the third and fourth original pages on an insertion sheet.</p> |  |

**2-sided original copying**

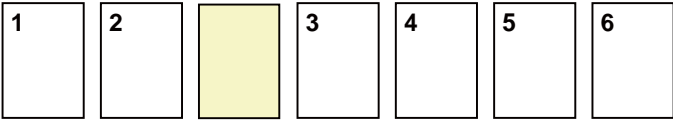
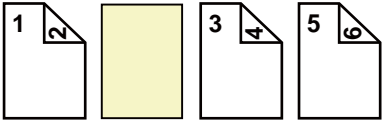
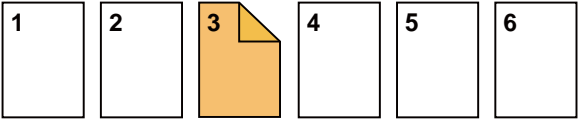
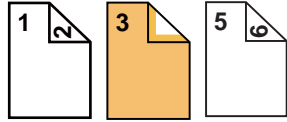
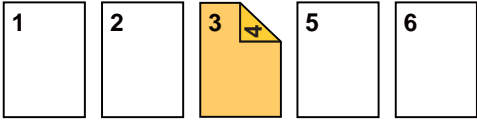
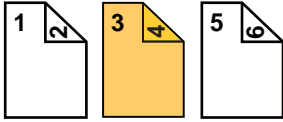
| Insertion sheet setting conditions | Resulting copies  |   |
|------------------------------------|---|---|
|                                    | Insert an insertion sheet in 1-sided copy mode.   | Insert an insertion sheet in 2-sided copy mode.   |
| Not copied                         |  <p>Inserts an insertion sheet between the second and third pages of copies.</p>            |    |
| 1-sided copy                       |  <p>Makes a 1-sided copy of the third original page on an insertion sheet.</p>              |  <p>* The fourth original page is not copied.</p> |
| 2-sided copy                       |  <p>Makes a 2-sided copy of the third and fourth original pages on an insertion sheet.</p> |    |



- Before using the covers/inserts function, load insertion sheets in the tray.
- When selecting the covers/inserts function, place the originals in the document feeder tray, select 1-sided or 2-sided copying, and select the number of copies and any other desired copy settings. When these settings have been completed, perform the procedure to select covers/inserts.
- The insertion sheet size must be the same as the copy size.
- Up to 100 insertion sheets can be inserted.



- The document glass is not available for this function.
- Take care that two insertion sheets cannot be inserted into the same page.
- When performing 2-sided copying of 2-sided originals, an insertion sheet cannot be inserted between the front and reverse sides of an original.
- This function cannot be used in combination with the saddle stitch function.
- This setting is not available when the covers/inserts function is disabled in "Settings (administrator)".



**Disabling of Covers/Inserts Mode**

Disables the use of the covers and inserts function.

In "Settings (administrator)", select [System Settings] → [Common Settings] → [Operation Settings] → [Condition Settings] → [Disabling of Covers/Inserts Mode].





1

Place the original in the document feeder tray of the automatic document feeder.

► [AUTOMATIC DOCUMENT FEEDER \(page 1-116\)](#)

2

Tap the [Others] key, and then tap the [Covers/Inserts] key.

3

Tap the [Insertion Sheet] tab.

4

Tap the [Insertion Type A] key, and tap the insert page display key.

The Insertion Type B to Type H settings are the same as the Insertion Type A settings.

5

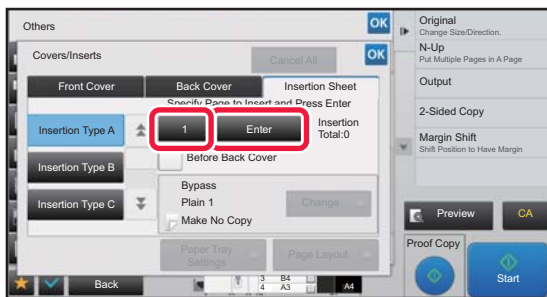

Enter the number of the page you want to insert a sheet into using numeric keys, and then tap the [Enter] key.

The total number of insertion sheets is displayed at the side of [Enter] key. Repeat these steps for the number of insertion sheets.

After the settings are completed, tap **OK** and [Back] keys in sequence.



• If you have entered an incorrect insert page number:

Tap the [Page Layout] key and change the page.

► [CHECKING, EDITING, AND DELETING THE PAGE LAYOUT OF COVERS AND INSERTION SHEETS \(PAGE LAYOUT\) \(page 2-115\)](#)

• To cancel insertion sheets:

Tap the [Cancel All] key.

6

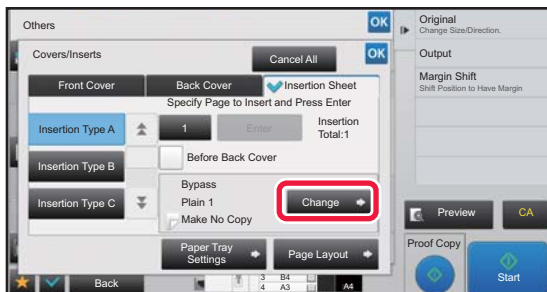

Tap the [Change] key.



7

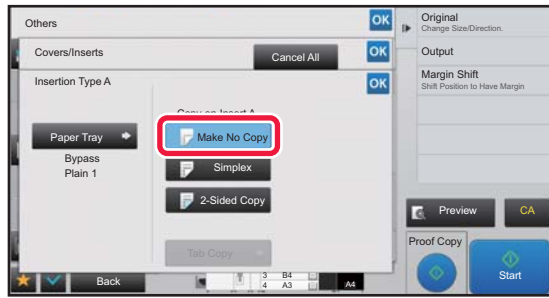

**When only inserting insertion sheet A, tap the [Make No Copy] key.**

When making a copy on insertion sheet A, tap the [Simplex] or [2-Sided Copy] key.

If you selected [2-Sided Copy], tap the [Book] key or [Tablet] key for the insert sheet binding.

After the settings are completed, tap **OK**.



**To change an insertion sheet:**

Tap the [Paper Tray] key, and select the tray with insertion sheets loaded.

To copy on tab paper, tap the [Tab Copy] key.

▶ [COPYING CAPTIONS ONTO TAB PAPER \(TAB COPY\) \(page 2-118\)](#)



When copying on both sides of an insertion sheet, you cannot use label sheets, transparency films, or tab paper for insertion. If not copied on, tab paper can be inserted.

**To cancel all settings:**

Tap the [CA] key.

8

**Tap the [Start] key to start copying.**



# CHECKING, EDITING, AND DELETING THE PAGE LAYOUT OF COVERS AND INSERTION SHEETS (PAGE LAYOUT)



The editing contents are different between the registered covers and insertion sheets as shown below.

- For the "Cover Sheet", you can change settings such as the paper type, copy/do not copy, 1-Sided, and 2-Sided.
- For "Insert Sheet", you can change only the page number you want to insert an insert sheet into.

1

Tap the [Others] key, and then tap the [Covers/Inserts] key.

2

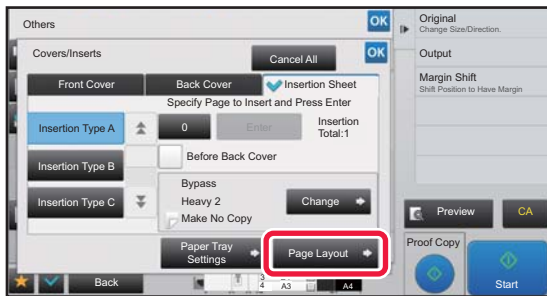

Tap the [Page Layout] key.



If the settings for the covers or insertion sheets are not configured, the [Page Layout] key is disabled.

3

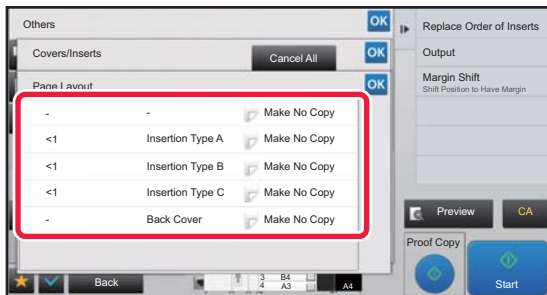

Check the page layout.

To exit this job after checking the page layout, tap the **OK** key.

To edit or delete, tap the required key. When deleting, tap the [Delete] key. When editing, tap the [Modify] key.

When setting consecutive insertion of different types of inserts at the same page, you can tap [Replace Order of Inserts] on the action panel to change the order.

4

Change cover or insertion sheet settings.

For the cover, you can change the copy mode.

You can change the page number you want to insert an insert sheet into.

After the settings are completed, tap the **OK** key multiple times to return to the [Others] screen. Then, tap the [Back] key.



## INSERTING INSERTION SHEETS IN BETWEEN TRANSPARENCY FILMS (TRANSPARENCY INSERTS)

When copying on transparency film, the sheets may stick together due to static electricity.

The transparency inserts function can be used to automatically insert a sheet of paper between each sheet of transparency film, making the sheets easy to handle.

It is also possible to copy on insertion sheets.

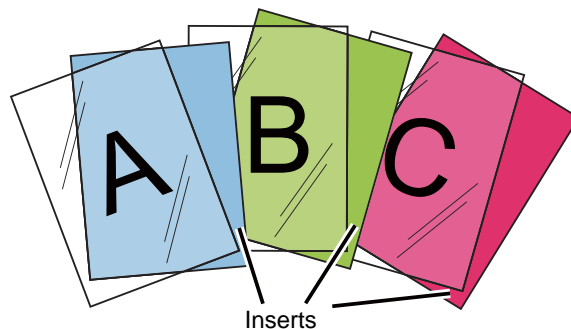

When performing 2-sided copying, only "2-Sided→1-Sided" mode can be used.



- The number of copies cannot be selected in this mode.
- Transparency film can be loaded in the bypass tray, tray 4 and large capacity trays.

**1**

### Load transparency film in the bypass tray, tray 4 or large capacity trays.

When loading paper in the bypass tray or large capacity trays, load with the print side up. In tray 4, load with the print side down.

► [MAKING COPIES USING THE BYPASS TRAY \(page 2-34\)](#)

**2**

### Place the original.

Place the original in the document feeder tray of the automatic document feeder, or on the document glass.

► [AUTOMATIC DOCUMENT FEEDER \(page 1-116\)](#)

► [DOCUMENT GLASS \(page 1-120\)](#)

**3**

### Tap the [Others] key, and then tap the [Transparency Inserts] key.



4

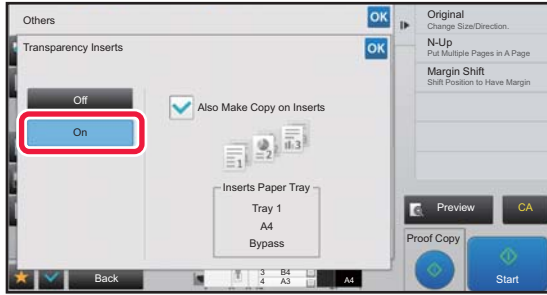

### Tap the [On] key.

When making a copy on insertion sheets, tap the [Also Make Copy on Inserts] checkbox to set to . After the settings are completed, tap  and [Back] keys in sequence.



- **To cancel the transparency inserts setting:**  
Tap the [Off] key.
- **To cancel all settings:**  
Tap the [CA] key.

5

### Tap the [Start] key to start copying.



# FUNCTIONS FOR SPECIFIC USES

## COPYING CAPTIONS ONTO TAB PAPER (TAB COPY)

Load a tab sheet in the bypass tray, and make a copy on a tab.  
Prepare appropriate originals for tab captions.

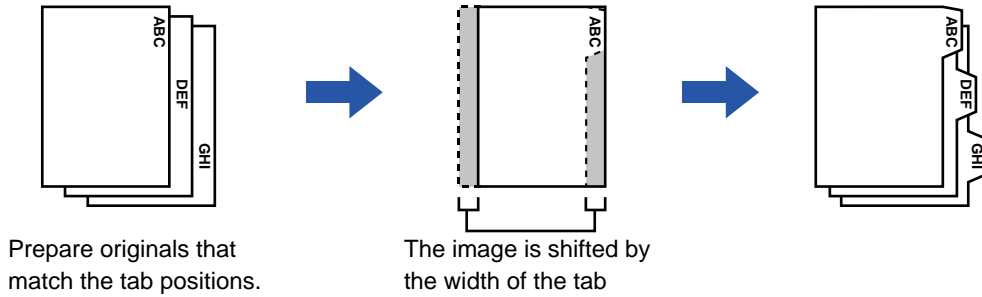

### Relation between the originals and the tab paper

#### Tab copying with a left binding

| Originals                           | Placing the originals   | Loading tab paper  |   |
|-------------------------------------|---|--|---|
| <p>Originals</p> <p>Final image</p> | <p>Document feeder tray</p> <p>Insert the originals so that the side with no tab text enters first.</p> | <p>Bypass tray (on the machine)</p> <p>Place the first sheet of tab paper so that the tab faces away from you.</p> | <p>Tray 4</p> <p>Place the first sheet of tab paper so that the tab faces away from you.</p>                                    |
|                                     | <p>Document glass</p> <p>Place the originals so that the side with the tab text is on the left.</p>     | <p>Large capacity trays</p> <p>Place the first sheet of tab paper so that the tab faces away from you.</p>         | <p>Bypass tray (on the large capacity trays)</p> <p>Place the first sheet of tab paper so that the tab faces away from you.</p> |

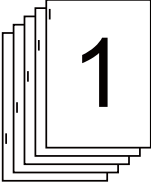
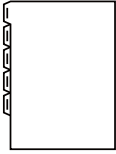
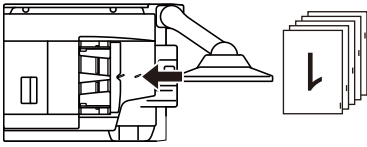
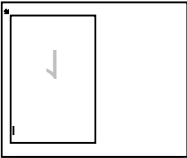
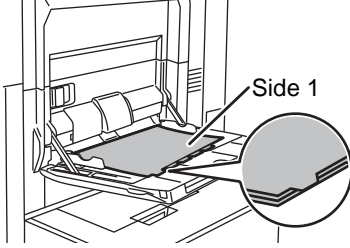
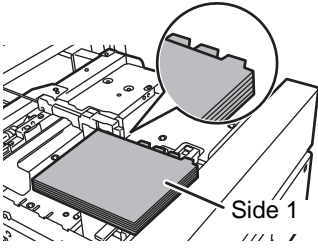
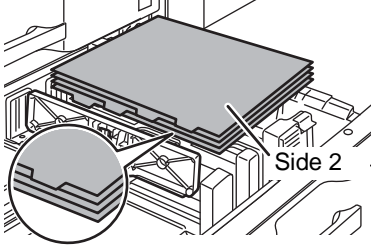
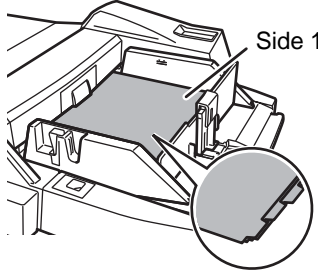

### Tab copying with a right binding

| Originals   | Placing the originals   | Loading tab paper   |   |
|---|---|---|---|
| <p>Originals</p>  <p>Final image</p>  | <p>Document feeder tray</p>  <p>Insert the originals so that the side with no tab text enters first.</p> <p>Document glass</p>  <p>Place the originals so that the side with the tab text is on the left.</p> | <p>Bypass tray (on the machine)</p>  <p>Place the first sheet of tab paper so that the tab faces toward you.</p> <p>Large capacity trays</p>  <p>Place the first sheet of tab paper so that the tab faces toward you.</p> | <p>Tray 4</p>  <p>Place the first sheet of tab paper so that the tab faces toward you.</p> <p>Bypass tray (on the large capacity trays)</p>  <p>Place the first sheet of tab paper so that the tab faces toward you.</p> |

 Tab Copy must be specified before scanning the original.

 **To change the default image shift width for tab copying:**  
In "Settings (administrator)", select [System Settings] → [Copy Settings] → [Condition Settings] → [Initial Tab Copy Setting]. Specify a value from 0" (0 mm) to 1" (20 mm) in increments of 1/8" (1 mm).

**1** Tap the [Others] key, and tap the [Tab Copy] key.

**2** Tap the [On] key.



3

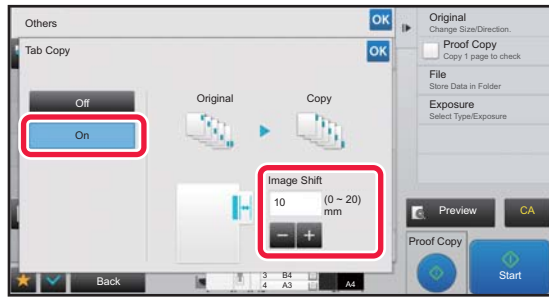

### Sets an image shift width (tab width).

- Tap the numeric value display indicating the image shift width, and enter a shift width using numeric keys.
- After the settings are completed, tap **OK** and [Back] keys in sequence.



**To cancel the tab copy setting:**  
Tap the [Off] key.

4

### Load the tab paper.



The width of the tab paper can be as wide as 8-1/2" x 11" paper (8-1/2") plus 5/8" (or A4 width (210 mm) plus 20 mm).

5

### Place the original and tap the [Preview] key.

Place the original in the document feeder tray of the automatic document feeder, or on the document glass.

- ▶ [AUTOMATIC DOCUMENT FEEDER \(page 1-116\)](#)
- ▶ [DOCUMENT GLASS \(page 1-120\)](#)



**To cancel all settings:**  
Tap the [CA] key.

6

### Tap the [Start] key to start copying.





## MAKING A POSTER-SIZED COPY (MULTI-PAGE ENLARGEMENT)

This function separately copies an enlarged original image on multiple sheets.

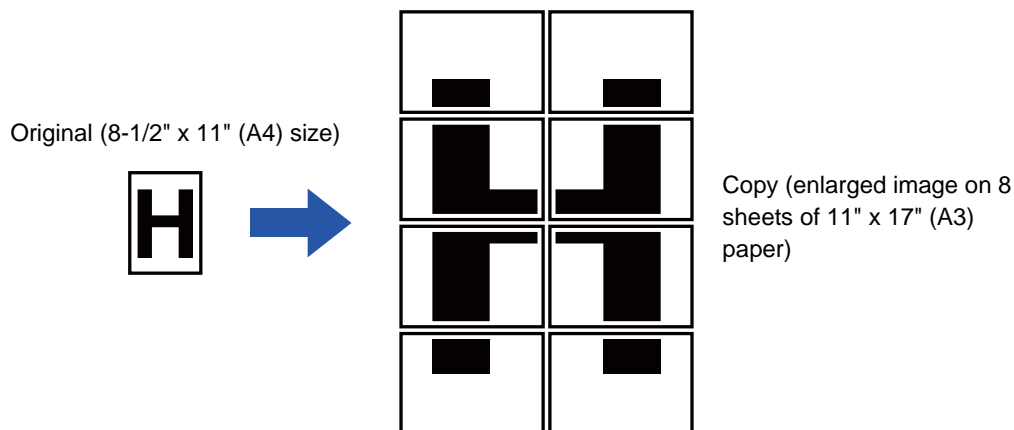

- You must select Multi-Page Enlargement before scanning the original.
- Place an original on the document glass.
- When Multi-Page Enlargement is selected, the image orientation is changed to vertical.
- Overlap of sections of image
  - There will be a margin around the edges of each copy.
  - Areas for overlapping the copies will be created at the leading and trailing edges of each copy.
- The paper size, number of sheets required for the enlarged image, and the ratio are automatically selected based on the selected original size and enlargement size. (The paper size and ratio cannot be selected manually.)

1

Tap the [Others] key, and tap the [Multi-Page Enlargement] key.

2

Select the [AB] or [Inch] tab to meet the original size for poster-sized copy, and tap the key that meets the original size.

Tapping the key of the original size displays the keys that show the available enlargement size, copy paper size, and number of sheets.



3

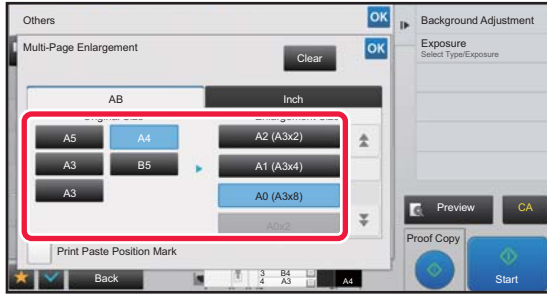

**Tap the key of the size you want to enlarge the original to.**

The image orientation appears.

After the settings are completed, tap **OK** and [Back] keys in sequence.



When printing the copy image and margin border, set the [Print Paste Position Mark] checkbox to .



• **To cancel Multi-Page Enlargement setting:**

Tap the [Clear] key.

Even when the multi-page enlargement setting is canceled, the automatically selected ratio is retained.

• **To return the ratio to 100%:**

Tap the [Copy Ratio] key on the base screen to display the ratio menu, and then tap the [100%] key.

4

**Place the original on the document glass based on the orientation displayed on the screen.**

5

**Tap the [Start] key to start copying.**



## COPYING WITH MIRROR IMAGE (MIRROR IMAGE)

This function makes copies by inverting the original into a mirror image.

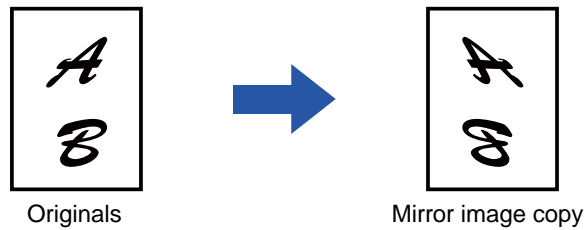

Specify the Mirror Image before scanning an original.

1

### Tap the [Others] key, and tap the [Mirror Image] key.

A checkmark appears on the icon.

After the settings are completed, tap the [Back] key.



### To cancel the mirror image setting:

Tap the [Mirror Image] key to uncheck it.

2

### Place the original.

Place the original in the document feeder tray of the automatic document feeder, or on the document glass.

► [AUTOMATIC DOCUMENT FEEDER \(page 1-116\)](#)

► [DOCUMENT GLASS \(page 1-120\)](#)

3

### Tap the [Start] key to start copying.



# OUTPUT AND DENSITY ADJUSTMENT FUNCTIONS

## REVERSING WHITE AND BLACK IN A COPY (B/W REVERSE)

This function reverses black and white in a copy to create a negative image. This function can only be used for black and white copying.

Originals with large black areas (which use a large amount of toner) can be copied using Black/White Reverse to reduce toner consumption.



Originals

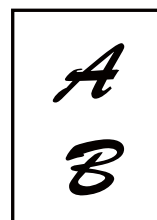

B/W reverse copy



- B/W Reverse must be specified before scanning the original.
- When this function is selected, the "Exposure/Original Type" setting for exposure adjustment automatically changes to "Text".

1

### Tap the [Others] key, and tap the [B/W Reverse] key.

A checkmark appears on the icon.  
After the settings are completed, tap the [Back] key.



**To cancel the B/W reverse setting:**  
Tap the [B/W Reverse] key to uncheck it.

2

### Place the original.

Place the original in the document feeder tray of the automatic document feeder, or on the document glass.

- ▶ [AUTOMATIC DOCUMENT FEEDER \(page 1-116\)](#)
- ▶ [DOCUMENT GLASS \(page 1-120\)](#)



**To cancel all settings:**  
Tap the [CA] key.

3

### Tap the [Start] key to start copying.



# EASY ADJUSTMENT OF THE IMAGE QUALITY (QUICK IMAGE QUALITY ADJUSTMENT)

You can easily adjust the outlines of images and text.



You must select Quick Image Quality Adjustment before scanning the original.

1

Tap the [Others] key, and tap the [Quick Image Quality Adjustment] key.

2

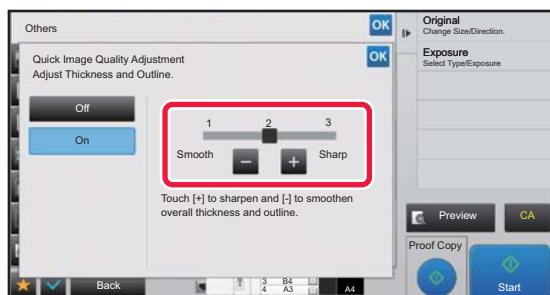

Tap **[-]** **+** or slide the slider to adjust the image quality.

After the settings are completed, tap **OK** and [Back] keys in sequence.



To cancel the quick image quality adjustment setting:

Tap the [Off] key.

3

**Place the original.**

Place the original in the document feeder tray of the automatic document feeder, or on the document glass.

- ▶ [AUTOMATIC DOCUMENT FEEDER \(page 1-116\)](#)
- ▶ [DOCUMENT GLASS \(page 1-120\)](#)



To cancel all settings:

Tap the [CA] key.

4

Tap the [Start] key to start copying.



# ADJUSTING THE SHARPNESS OF AN IMAGE (SHARPNESS)

This function adjusts the sharpness to make a sharper or softer image.

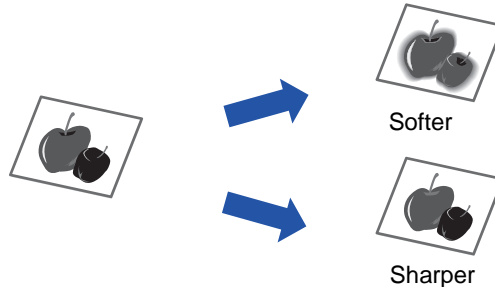

Sharpness must be specified before scanning the original.

1

Tap the [Others] key, and tap the [Sharpness] key.

2

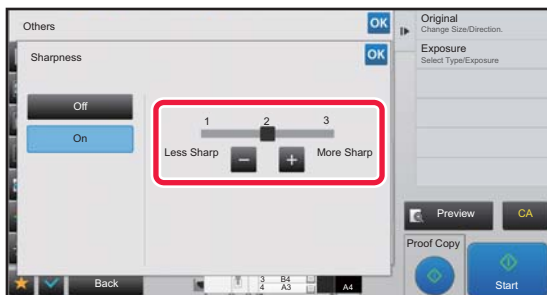

Tap **- +** or slide the slider to adjust the sharpness.

Select [More Sharp] for sharper outlines, or [Less Sharp] for softer outlines.

After the settings are completed, tap **OK** and [Back] keys in sequence.



**To cancel the sharpness setting:**

Tap the [Off] key.

3

**Place the original.**

Place the original in the document feeder tray of the automatic document feeder, or on the document glass.

▶ [AUTOMATIC DOCUMENT FEEDER \(page 1-116\)](#)

▶ [DOCUMENT GLASS \(page 1-120\)](#)



**To cancel all settings:**

Tap the [CA] key.

4

Tap the [Start] key to start copying.



# ADJUST DENSITY AREA FOR COPY (GRAY BALANCE)

You can adjust the tone and density of copies.

The density is divided into three ranges, and you can adjust the density of each range.

If needed, you can also adjust all three density ranges at once.

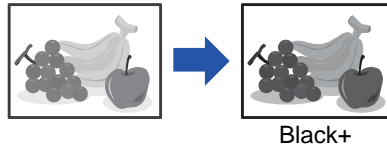

Gray Balance must be specified before scanning the original.



To change the default gray balance setting:

Change the setting in "Settings (administrator)" → [System Settings] → [Image Quality Adjustment] → [Copy Image Quality] → [Gray Balance].

1

Tap the [Others] key, and tap the [Gray Balance] key.

2

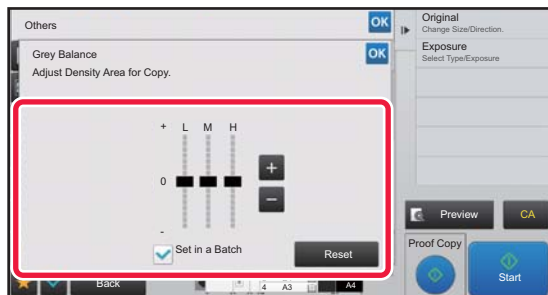

Tap the **- +** key or slide the slider to adjust the gray balance.

- To adjust each range, set the [Set in a Batch] checkbox to .
- To adjust a slider individually with the **- +** keys, tap the slider you want to adjust and tap the **- +** keys.



To return the gray balance of the current tab to the default balance:

Tap the [Reset] key.

The values of all gradations currently being adjusted will return to their default gray balance values.

The default settings are the values set in "Settings (administrator)" → [System Settings] → [Image Quality Adjustment] → [Copy Image Quality] → [Gray Balance].

3

Place the original.

Place the original in the document feeder tray of the automatic document feeder, or on the document glass.

► [AUTOMATIC DOCUMENT FEEDER \(page 1-116\)](#)

► [DOCUMENT GLASS \(page 1-120\)](#)

4

Tap the [Start] key to start copying.



# CONVENIENT COPY FUNCTIONS

## INTERRUPT COPY

This function suspends a job in progress, and preferentially prints the original specified with interrupt copy. When you need to make an urgent copy and the machine is busy with a long copy run or other job, use interrupt copy.



- The [Interrupt] key does not appear while an original is being scanned.
- Depending on the settings of the job in progress, the [Interrupt] key may not appear.
- Interrupt copy cannot be used in combination with the following functions: Job Build, Tandem Copy, Book Copy, Card Shot, Multi-Page Enlargement, Original Count, Proof Copy, Preview Setting, and Book Divide.
- If you use the document glass for interrupt copy, you cannot select the booklet, covers/inserts function, or N-Up setting. If any of these functions are necessary, use the automatic document feeder.

**1****Tap the [Interrupt] key.**

The interrupt mode screen appears.

**If user authentication is specified:**

Tap the [Interrupt] key to display the user authentication screen. Enter the login name and password to perform user authentication.

**2****Place the original.**

Place the original in the document feeder tray of the automatic document feeder, or on the document glass.

- [AUTOMATIC DOCUMENT FEEDER \(page 1-116\)](#)
- [DOCUMENT GLASS \(page 1-120\)](#)

**3****Configure copy settings.**

To cancel interrupt copy, tap the [Cancel] key.





4

**Tap the [Start] key to start interrupt copying.**

When the interrupt copy job is completed, the interrupted job will resume.

---



The interrupt copy function does not display the preview of the scanned original.

---



# SEND DATA WHILE COPYING

This function allows you to send an e-mail with an image attached, or save data in the network folder while making a copy.



You need to store the destination in the address book in advance.

► [User's Manual \(Address Book Registration\)](#)

The image send transmission starts after the copy, and the settings same as the copy are used for transmission. However, the same results as the copy may not be provided by some functions.



## Disabling sending while copying

In "Settings (administrator)", select [System Settings] → [Copy Settings] → [Condition Settings] → [Disabling sending while copying].

### 1

**Tap the [Detail] key to change to normal mode.**

► [CHANGING MODES \(page 1-13\)](#)

### 2

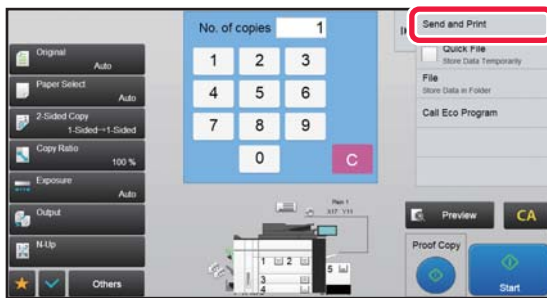

**Tap [Send and Print] on the action panel.**

### 3



**Select a recipient from the address book.**

► [User's Manual \(Address Book Registration\)](#)

After you have selected the recipient, tap the [Enter Address] key.



• You cannot use the soft keyboard to enter an address. If you cannot find the recipient in the address book, enter it in the address book.

### 4

**Place the original.**

Place the original in the document feeder tray of the automatic document feeder, or on the document glass.

► [AUTOMATIC DOCUMENT FEEDER \(page 1-116\)](#)

► [DOCUMENT GLASS \(page 1-120\)](#)



---

**5**

**Set each copy item as required.**



You can preview the scanned original by tapping the [Preview] key.

---

**6**

**Tap the [Start] key to start copying.**

After the copy, the transmission starts.



After the copy, you cannot preview the settings before transmission.

---



# COPY JOBS

When you tap the job management display, jobs are displayed in a list. To check the status of a copy job, tap the [Print] tab.

When you wish to stop or delete jobs or to perform priority processing, read "User's Manual (Touch Panel Operation)".





# PROGRAMS

Programs are set from the base screen of normal mode.

► [SELECTING COPY MODE \(page 2-4\)](#)



Programs cannot be stored in easy mode.



### Disabling of Registration/Deletion of Program

In "Settings (administrator)", select [System Settings] → [Copy Settings] → [Condition Settings] → [Disabling of Registration/Deletion of Program].

This is used to prohibit the deletion and change of copy settings stored in job programs.

## STORING A PROGRAM

This function collectively stores copy settings as one program. The stored program can be retrieved using an easy operation. For information about how to retrieve a program, see "[RETRIEVING A PROGRAM \(page 2-136\)](#)".

For example, suppose 11" x 17" (A3) size CAD drawings are copied once a month for archive purposes using the following settings:

- The 11" x 17" (A3) size CAD drawings are reduced to 8-1/2" x 11" (A4) size.
- To reduce paper use by half, 2-sided copying is used.
- Margin shift is used to allow a margin to punch holes for filing.

A3 (11" x 17") size CAD drawings

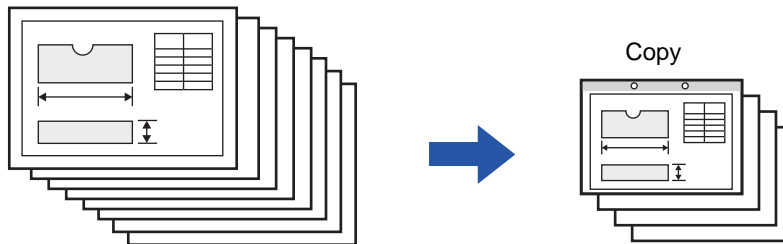

| When a job program is not stored   | When a job program is stored  |
|--|---|
| <p>Set reduction from 11" x 17" (A3) to 8-1/2" x 11" (A4)</p> <p style="text-align: center;">↓</p> <p>Change the exposure setting.</p> <p style="text-align: center;">↓</p> <p>Set 2-sided copying.</p> <p style="text-align: center;">↓</p> <p>Set margins.</p> <p style="text-align: center;">↓</p> <p>Set punch hole settings.</p> <p style="text-align: center;">↓</p> <p>Tap the [Start] key.</p> | <p>Retrieve the stored program.</p> <p style="text-align: center;">↓</p> <p>Tap the [Start] key.</p>  |
| <p>Considerable time is required to copy the drawings each month because the above settings must be selected. In addition, mistakes are occasionally made when selecting the settings, so some copies must be redone.</p>  | <p>The settings are stored in a program, so they can be selected by the touch of a key. This is simple and takes no time. In addition, the settings are all stored so there are no chances for mistakes, and thus no need to redo copies due to setting mistakes.</p> |



- Up to 48 programs can be stored.
- Program settings remains registered even when the main power has been turned off.
- A program can also be stored in the home screen or favorite as a shortcut; therefore, it is helpful when retrieving it.

1

## Specify the copy function to be stored.



In the base screen, display [Program Registration] on the action panel.

2

## Tap [Program Registration] on the action panel.

3

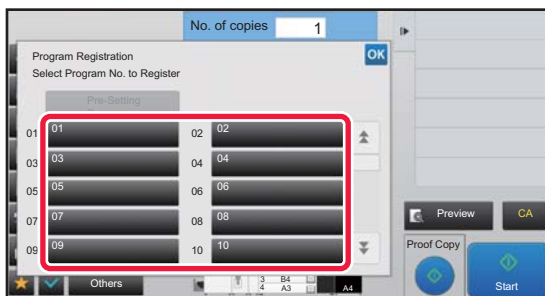

## Tap an unused key.

A key with a program stored is displayed in color. Tap a key with no program stored.



If you do not set a name for the program, a serial number will be automatically assigned as the name.

4

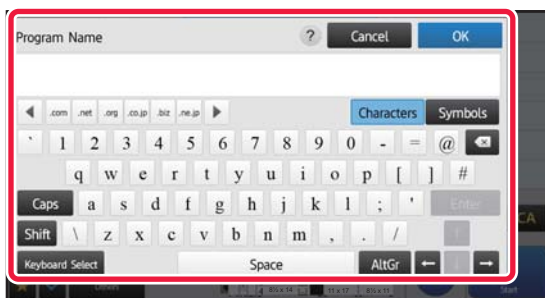

## Set a name for the program and tap the [OK] key.

A registration completion message appears.



5

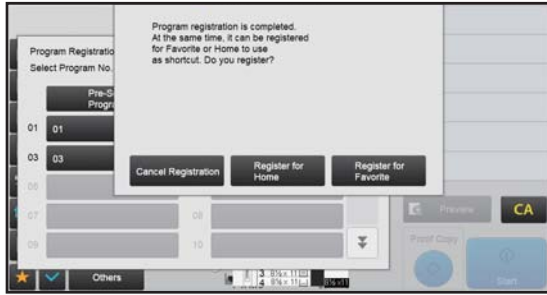

**Select whether or not the program will be added to the home screen or the favorites.**

To specify print settings, you can select the required one from pre-set text or use the soft keyboard. You can also print serial number and account job ID.

When you have completed the settings, tap **OK** and the [Back] keys in sequence.



- If user authentication is enabled, the shortcut key for the program is registered in the user's home screen or favorite.
- If user authentication is disabled, the administrator password entry screen appears. When the administrator password is entered, the registration is completed.



The number of copies cannot be stored.

## RETRIEVING A PROGRAM

1

Tap [Call Program] on the action panel.

2

Tap the key of the program you want to retrieve.



You can select a program key and tap [Register in Favorite] or [Register for Home] on the action panel to register a shortcut key for the selected program in the favorite or home screen.

## DELETING AND RENAMING A PROGRAM

This section explains how to delete copy settings in a program and rename a program.



- A program that is already stored cannot be deleted.
- When "Settings (administrator)" - [System Settings] → [Common Settings] → [Enable/Disable Settings] → [Disabling of Registration/Deletion of Program] is selected, a registered program cannot be deleted or renamed.

### Deleting a program

1

Tap [Call Program] on the action panel.



2

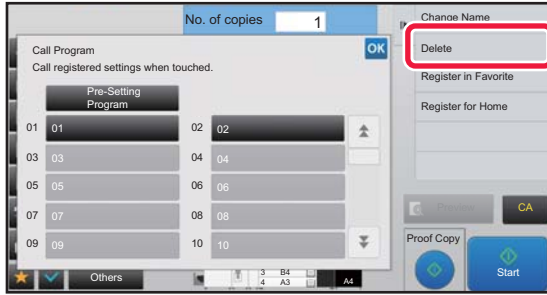

Tap [Delete] on the action panel.

3

Tap the key of the program you want to delete, and tap [Delete].

## Renaming a program

1

Tap [Call Program] on the action panel.

2

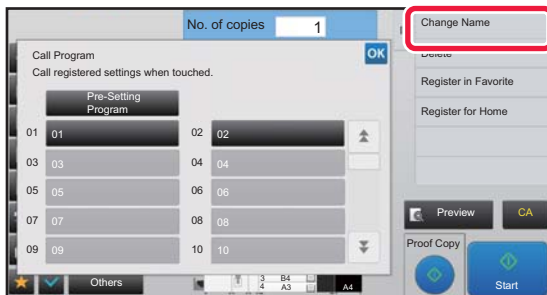

Tap [Change Name] on the action panel.

3

Tap the key of the required program, and rename the program. Then tap the [OK] key.



After the settings are completed, tap **OK**.





# PRINTER

## Icons

-  Eco-friendly functions
-  Functions for printing on special media

## PRINTER FUNCTION OF THE MACHINE



### PRINTING IN A WINDOWS ENVIRONMENT

|  |             |
|--|-------------|
| <b>BASIC PRINTING PROCEDURE</b> .....                                  | <b>3-4</b>  |
| • PRINTER DRIVER SETTINGS SCREEN / REFERRING TO HELP .....             | 3-6         |
| • SELECTING THE PAPER.....   | 3-7         |
| <b>PRINTING WHEN THE USER AUTHENTICATION FUNCTION IS ENABLED</b> ..... | <b>3-8</b>  |
| <b>FREQUENTLY USED FUNCTIONS</b> .....                                 | <b>3-10</b> |
| • SAVING SETTINGS AT THE TIME OF PRINTING .....                        | 3-10        |
| • USING SAVED SETTINGS.....  | 3-11        |
| • CHANGING THE PRINTER DRIVER DEFAULT SETTINGS.....                    | 3-12        |

### PRINTING IN A macOS ENVIRONMENT

|  |             |
|--|-------------|
| <b>BASIC PRINTING PROCEDURE</b> .....                                  | <b>3-13</b> |
| • SELECTING THE PAPER.....   | 3-14        |
| <b>PRINTING WHEN THE USER AUTHENTICATION FUNCTION IS ENABLED</b> ..... | <b>3-15</b> |

### FREQUENTLY USED FUNCTIONS

|  |             |
|--|-------------|
| <b>SELECTING THE RESOLUTION</b> .....  | <b>3-17</b> |
|  <b>2-SIDED PRINTING</b> .....                   | <b>3-18</b> |
| <b>FITTING THE PRINT IMAGE TO THE PAPER</b> ....   | <b>3-19</b> |
|  <b>PRINTING MULTIPLE PAGES ON ONE PAGE</b> ...  | <b>3-21</b> |
|  <b>PRINTING WHILE SKIPPING BLANK PAGES</b> .... | <b>3-23</b> |
| <b>STAPLING OUTPUT/PUNCHING HOLES IN OUTPUT</b> .....  | <b>3-24</b> |

## CONVENIENT PRINTING FUNCTIONS

|  |             |
|--|-------------|
| <b>CONVENIENT FUNCTIONS FOR CREATING PAMPHLETS AND POSTERS</b> .....           | <b>3-26</b> |
| • CREATE A PAMPHLET (BOOKLET/SADDLE STITCH) .....                              | 3-26        |
| • TRIMMING THE EXCESS OF FOLDED PAPER .....                                    | 3-28        |
| • PRINTING WITH MARGIN SHIFT SETTING (MARGIN).....                             | 3-30        |
| • CREATE A LARGE POSTER (POSTER PRINTING).....                                 | 3-32        |
| <b>FUNCTIONS TO ADJUST THE SIZE AND ORIENTATION OF THE IMAGE</b> .....         | <b>3-33</b> |
| • ADJUST PRINT POSITION ON ODD AND EVEN PAGES SEPARATELY (PRINT POSITION)..... | 3-33        |
| • ROTATING THE PRINT IMAGE 180 DEGREES (ROTATE 180 DEGREES) .....              | 3-34        |
| • ENLARGING/REDUCING THE PRINT IMAGE (ZOOM SETTING/ENLARGE OR REDUCE) ...      | 3-35        |
| • ADJUST THE LINE THICKNESS (WIDTH) ...  | 3-37        |
| • PRINT A MIRROR-IMAGE (MIRROR-IMAGE REVERSE/VISUAL EFFECTS) .....             | 3-41        |
| <b>IMAGE ADJUSTING FUNCTION</b> .....  | <b>3-42</b> |
| • ADJUST THE BRIGHTNESS AND CONTRAST OF THE IMAGE (IMAGE ADJUSTMENT) ....      | 3-42        |
| • PRINTING FAINT TEXT AND LINES IN BLACK (TEXT TO BLACK/VECTOR TO BLACK) ....  | 3-43        |
| <b>FUNCTIONS TO COMBINE TEXT AND IMAGES</b> ...                                | <b>3-44</b> |
| • ADDING A WATERMARK TO PRINTED PAGES (WATERMARK) .....                        | 3-44        |
| • PRINTING AN IMAGE OVER THE PRINT DATA (IMAGE STAMP) .....                    | 3-46        |
| • REGISTERING A CUSTOM IMAGE .....   | 3-47        |
| • OVERLAY A FIXED FORM ON THE PRINT DATA (OVERLAYS).....                       | 3-48        |
| • ADDING THE NUMBER OF COPIES (COPIES STAMP).....                              | 3-50        |





**PRINT FUNCTIONS FOR SPECIAL PURPOSES. . . 3-51**



- PRINTING SPECIFIC PAGES ON DIFFERENT PAPER (DIFFERENT PAPER) . . . . . 3-51
- ADDING INSERTS WHEN PRINTING ON TRANSPARENCY FILM (TRANSPARENCY INSERTS) . . . . . 3-53
- INSERTING SEPARATOR PAGES BETWEEN JOBS OR COPIES . . . . . 3-55
- PRINTING A CARBON COPY (CARBON COPY) . . . . . 3-56
- PRINTING TEXT ON TABS OF TAB PAPER (TAB SHIFT/TAB PAPER PRINT) . . . . . 3-57
- TWO-SIDED PRINTING WITH SPECIFIC PAGES PRINTED ON THE FRONT SIDE (CHAPTER INSERTS). . . . . 3-60
- FOLDING PAPER FOR PRINTING (FOLD) . . . . . 3-61
- INSERT PRESET DATA BEFORE OR AFTER EACH PAGE (PAGE INTERLEAVE). . . . . 3-66
- PRINT THE SAME IMAGE IN TILE PATTERN (REPEAT PRINT) . . . . . 3-67
- PRINTING PATTERN DATA (HIDDEN PATTERN PRINT). . . . . 3-68
- CHANGING THE RENDERING METHOD AND PRINTING JPEG IMAGES (USE DRIVER TO RENDER JPEGS) . . . . . 3-70
- MAXIMIZING THE PRINT AREA ON THE PAPER (PRINT AREA) . . . . . 3-71

**CONVENIENT PRINTER FUNCTIONS . . . . . 3-72**

- USING TWO MACHINES TO PRINT A LARGE PRINT JOB (TANDEM PRINT) . . . . . 3-72
- SAVING AND USING PRINT FILES (DOCUMENT FILING). . . . . 3-76
- AUTOMATICALLY PRINT ALL STORED DATA. . . . . 3-79
- PRINTING AND SENDING SIMULTANEOUSLY . . . . . 3-80

**PRINTING WITHOUT THE PRINTER DRIVER**

- EXTENSION OF PRINTABLE FILES. . . . . 3-81**
- DIRECTLY PRINTING A FILE ON AN FTP SERVER. . . . . 3-81**
- DIRECTLY PRINTING A FILE IN USB MEMORY. . . . . 3-83**
- DIRECTLY PRINTING A FILE IN A NETWORK FOLDER. . . . . 3-84**
- DIRECTLY PRINTING FROM A COMPUTER. . . . . 3-87**
  - SUBMIT PRINT JOB . . . . . 3-87
  - FTP PRINT . . . . . 3-88
  - E-MAIL PRINT . . . . . 3-88

**PRINTER JOBS**

- CHECKING THE PRINT STATUS . . . . . 3-90**
- PRINTING AN ENCRYPTED PDF FILE. . . . . 3-90**
- CHANGING TO ANOTHER PAPER SIZE AND PRINTING WHEN PAPER RUNS OUT. . . . . 3-91**

**APPENDIX**

- PRINTER DRIVER SPECIFICATIONS LIST. . . . . 3-92**
- SPECIFYING A BILLING CODE USING THE PRINTER DRIVER. . . . . 3-95**
- AUTHENTICATION BY SINGLE SIGN-ON . . . . . 3-97**



# PRINTER FUNCTION OF THE MACHINE

The machine is equipped with a printing function as standard. To enable printing from your computer, a printer driver must be installed.

See the table below to determine which printer driver to use in your environment.

## Windows environment

| Printer driver type  |
|--|
| <p><b>PCL6</b></p> <p>The machine support the Hewlett-Packard PCL6 printer control languages.</p>  |
| <p><b>PS</b></p> <ul style="list-style-type: none"> <li>• This printer driver supports the PostScript® 3™ page description language developed by Adobe.</li> <li>• If it is desired to use the Windows standard PS printer driver, the PPD driver must be used.</li> </ul> |



- To install the printer driver and configure settings in a Windows environment, see the Software Setup Guide.
- The User's Manual mainly uses PCL6 printer driver screens to explain how to print in a Windows environment. The printer driver screens may differ slightly depending on the printer driver you are using.
- Maximum print area: 12-9/16" x 50-7/8" (319 mm x 1292 mm)

## macOS Environment

| Printer driver type  |
|--|
| <p><b>PS</b></p> <p>PS This printer driver supports the PostScript® 3™ page description language developed by Adobe and uses a PPD file.</p> |



- To install the printer driver and configure settings in a macOS environment, see the Software Setup Guide.
- The explanations of screens and procedures for use in a macOS environment generally assume that macOS 10.12 is being used and a PPD driver is installed. The screens may be different depending on the version of the operating system or the software application.
- Maximum print area: 12-9/16" x 50-7/8" (319 mm x 1292 mm)



### If a notice page is printed

When "Settings (administrator)" – [System Settings] → [Printer Settings] → [Condition Settings] → [Prohibit Notice Page Printing] is enabled, certain conditions may cause a notice page to be printed.

If a print job cannot be printed as specified and the reason is not shown on the operation panel, a notice page indicating the reason will print. Read the message and take appropriate action. For example, a notice page will print if the following occurs:

- There is more print data than can be held in memory.
- You selected a function that has been prohibited by the administrator.



# PRINTING IN A WINDOWS ENVIRONMENT

## BASIC PRINTING PROCEDURE

The following example explains how to print a document from "WordPad", which is a standard accessory application in Windows.



- The menu used to execute printing may vary depending on the application.
- The button that is used to open the printer driver properties window (usually [Property] or [Preferences]) may vary depending on the application.
- The machine name that normally appears in the [Printer] menu is [MX-xxxx]. ("xxxx" is a sequence of characters that varies depending on the machine model.)

1

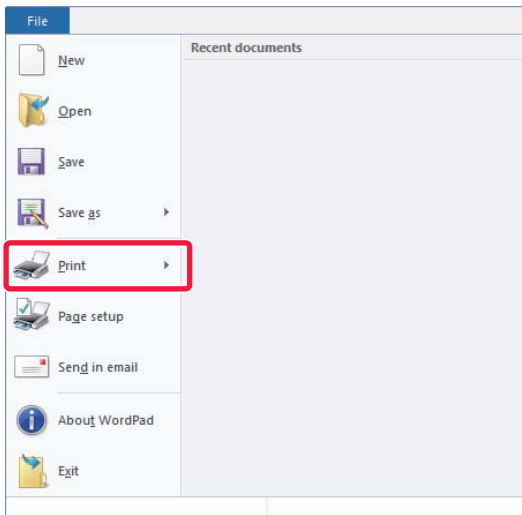

Select [Print] from the [File] menu of WordPad.

2

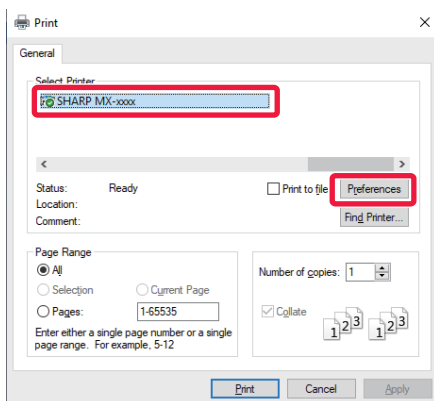

Select the printer driver for the machine and click the [Preferences] button.

The button that is used to open the printer driver properties window (usually [Property] or [Preferences]) may vary depending on the application.



3

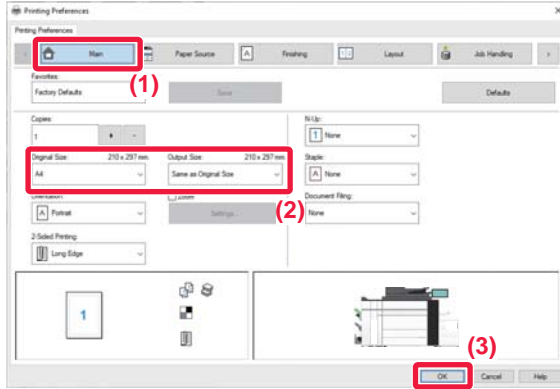

### Select print settings.

(1) Click the [Main] tab.

(2) Select the original size.

- You can register up to seven user-defined sizes in the menu. To store an original size, select [Custom Paper] or one of [User1] to [User7] from the menu, and click the [OK] button.
- To select settings on other tabs, click the desired tab and then select the settings.
  - [PRINTER DRIVER SETTINGS SCREEN / REFERRING TO HELP \(page 3-6\)](#)
- If an original size larger than the largest paper size that the machine supports is set, select the paper size for printing in "Output Size".
- If an "Output Size" different from the "Original Size" is selected, the print image will be adjusted to match the selected paper size.

(3) Click the [OK] button.

4

### Click the [Print] button.

Printing begins.



# PRINTER DRIVER SETTINGS SCREEN / REFERRING TO HELP

The printer driver settings screen consists of 9 tabs. Click a tab to select the settings on that tab.

You can check information on each of the settings in the Help screen. Click the [Help] button at the bottom right of the screen.

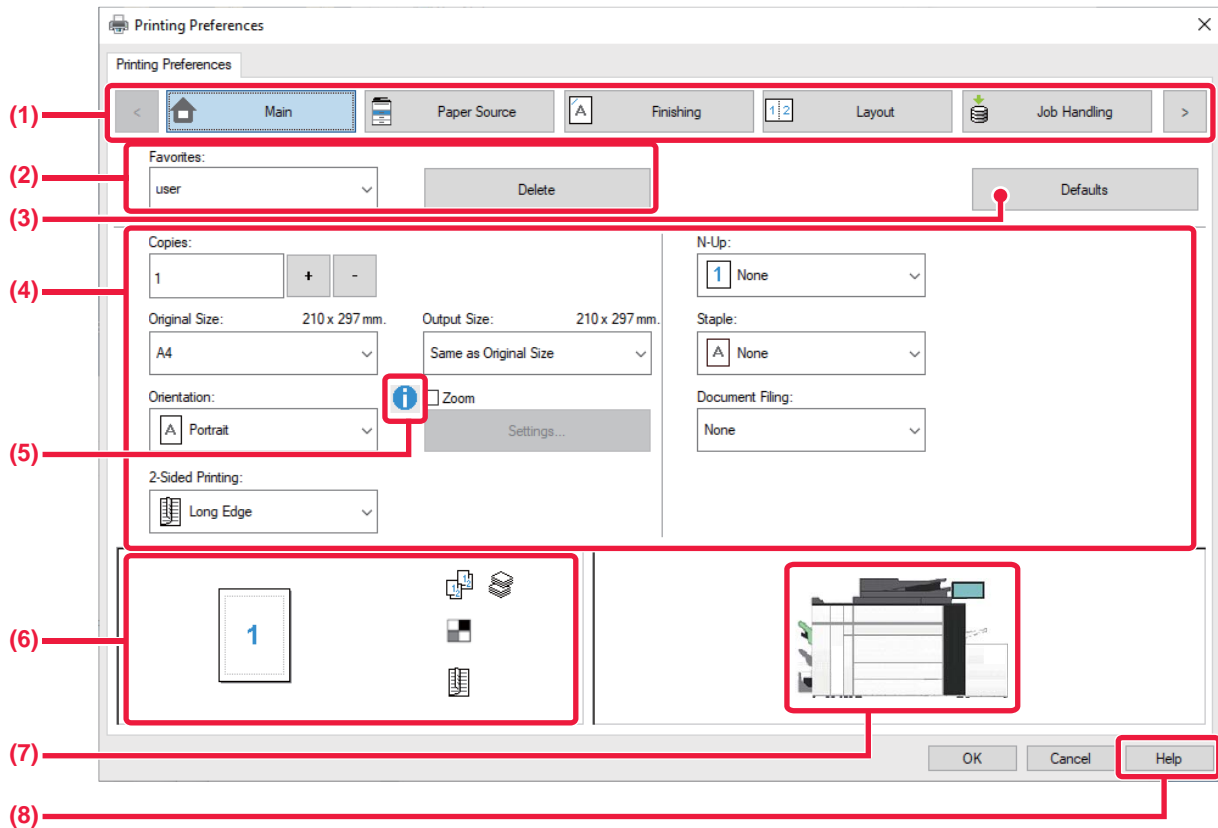

**(1) Tabs:** Click to change the tabs shown.

- [Main]: Frequently used functions are grouped on this tab. The settings are also on other tabs, and each setting on this tab is linked to the corresponding setting on the other tab.
- [Paper Source]: Set the size and type of paper used for printing, and the paper tray.
- [Finishing]: Select a finishing function such as stapling, punch, or folding, and set the output tray.
- [Layout]: Select functions related to the layout such as two-sided printing and booklet.
- [Job Handling]: Set Document Filing and user authentication.
- [Inserts]: Select insertion functions such as covers, inserts, and tab paper.
- [Stamp]: Select the watermark or stamp function.
- [Image Quality]: Select various image quality settings.
- [Detailed Settings]: Select tandem print and other detailed print settings.

**(2) Favorites**

Settings configured on each tab at the time of printing can be saved as Favorite.

▶ [FREQUENTLY USED FUNCTIONS \(page 3-10\)](#)

**(3) Defaults**

Return the settings on the currently selected tab to their default state.

**(4) Setup Items**

Displays the settings on each tab.

**(5) Information icon( )**

Some restrictions exist on the combinations of settings that can be selected in the printer driver properties window. When a restriction exists on a selected setting, an information icon ( ) will appear next to the setting. Click the icon to view an explanation of the restriction.



## (6) Print image

This lets you visually check how the current settings affect the print image. Finishing settings are indicated by icons.

## (7) Machine image

This shows the options that are installed on the machine, and the paper trays and output trays that are used.

## (8) [Help] button

Displays the Help window of the printer driver.



- Help can be displayed for a setting by clicking the setting and pressing the [F1] key.
- You can click the  button in the upper right corner of the settings screen and then click a setting to show Help for that setting in a sub-window.

# SELECTING THE PAPER

Before printing, check the paper sizes, paper types, and paper remaining in the machine's trays. To check the most recent tray information, click the [Tray Status] button in the [Paper Source] tab.

The "Output Size" setting and the "Paper Tray" setting are related as follows:

### • When "Paper Tray" is set to [Auto Select]

The tray that contains paper of the size and type selected in "Output Size" and "Paper Type" is automatically selected.

### • When "Paper Tray" is set to any setting other than [Auto Select]

The specified tray is used for printing regardless of the "Output Size" setting.

When you have set "Paper Type" to [Bypass Tray], be sure to select "Paper Type". Check the paper type that is set for the bypass tray of the machine, check that paper of that type is actually loaded into the bypass tray, and then select the appropriate paper type.

### • When "Paper Type" is set to [Auto Select]

A tray with plain paper or recycled paper of the size specified in "Output Size" is automatically selected. (The factory default setting is plain paper 1 only.)

### • When "Paper Type" is set to anything other than [Auto Select]

A tray with the specified type of paper and the size specified in "Output Size" is used for printing.



Special media can also be placed in the bypass tray.

For the procedure for loading paper in the bypass tray, see "[LOADING PAPER INTO THE BYPASS TRAY \(page 1-104\)](#)".



When [Enable Detected Paper Size in Bypass Tray] (disabled by factory default) or [Enable Selected Paper Type in Bypass Tray] (enabled by factory default), which you can reach by selecting [System Settings] in "Settings (administrator)" → [Printer Settings] → [Condition Settings] → [Bypass Tray Settings] is enabled, printing will not take place if the paper size or paper type specified in the printer driver is different from the paper size or paper type specified in the settings of the bypass tray.



### • To exclude the bypass tray from the trays that can be selected when [Auto Select] is selected:

In "Settings (administrator)", select [System Settings] → [Printer Settings] → [Condition Settings] → [Bypass Tray Settings] → [Exclude Bypass-Tray from Auto Paper Select].

### • When "A4 / Letter Auto Switching" is enabled

If you print an 8-1/2" x 11" (letter) size document and there is no 8-1/2" x 11" size paper, printing will automatically take place on A4 paper.

In "Settings (administrator)", select [System Settings] → [Printer Settings] → [Condition Settings] → [A4/Letter Size Auto Change].



# PRINTING WHEN THE USER AUTHENTICATION FUNCTION IS ENABLED

The user information (such as login name and password) that must be entered varies depending on the authentication method being used, so check with the administrator of the machine before printing.



- If you have configured "Printing Policy" on the [Configuration] tab so that user authentication is always performed, users are required to be authenticated for each print job. This is done by entering authentication information in a dialog box that appears each time printing is performed.
- The machine's user authentication function cannot be used when the PPD driver\* is installed and the Windows standard PS printer driver is used.  
For this reason, the machine can be configured to prohibit users from executing printing unless their user information is stored in the machine.  
\*The PPD driver enables the machine to print using the Windows standard PS printer driver.



**To prohibit printing by users whose user information is not stored in the machine:**

In "Settings (administrator)", select [System Settings] → [Authentication Settings] → [Default Settings] → [Disable Printing by Invalid User].

1

**In the printer driver properties window of the application, select the printer driver of the machine and click the [Preferences] button.**

The button that is used to open the printer driver properties window (usually [Property] or [Preferences]) may vary depending on the application.





2

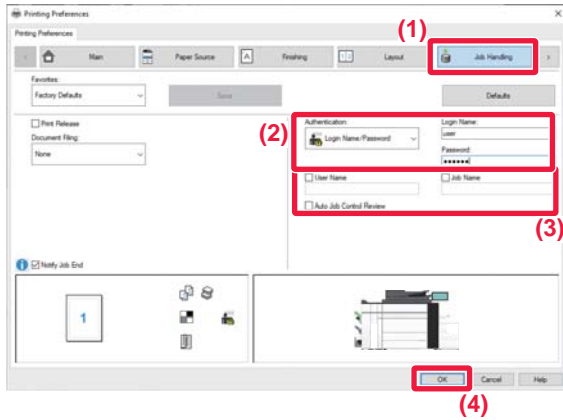

**Enter your user information.**

**(1) Click the [Job Handling] tab.**

**(2) Enter your user information.**

- When authentication is performed by login name, select [Login Name] and enter your login name.
- When authentication is performed by login name/password, click [Login Name/Password] and enter your login name and password. Enter the password using 1 to 32 characters.
- When the machine's authentication destination is Active Directory, [Single Sign-on] can be selected. For information on single sign-on, refer to ["AUTHENTICATION BY SINGLE SIGN-ON \(page 3-97\)"](#).
- When authentication is performed by user number, select [User Number] and enter your 5 to 8 digit user number.

**(3) Enter the user name and job name as necessary.**

- Click the [User Name] checkbox, and enter your user name using up to 32 characters. The entered user name will appear on the touch panel of the machine. If you do not enter a user name, your PC login name will appear.
- Click the [Job Name] checkbox, and enter a job name using up to 30 characters. The entered job name will appear as a file name on the touch panel of the machine. If you do not enter a job name, the file name set in the application will appear.
- To have a confirmation window appear before printing starts, select the [Auto Job Control Review] checkbox.

**(4) Click the [OK] button to execute printing.**



Authentication by Single Sign-on requires that Active Directory authentication be performed on the machine and your computer. This can only be used when your computer is running Windows.



# FREQUENTLY USED FUNCTIONS

## SAVING SETTINGS AT THE TIME OF PRINTING

Settings configured on each of the tabs at the time of printing can be saved as Favorite. Saving frequently used settings under an assigned name makes it easy to select those settings the next time you need to use them. Settings can be saved from any tab of the printer driver properties window. Settings configured on each tab are listed at the time of saving, allowing you to check the settings as you save them.



### Deleting saved settings

In step 2 of "[USING SAVED SETTINGS \(page 3-11\)](#)", select the user settings that you want to delete and click the [Delete] button.

## 1

Select the machine's printer driver from the print window of the application, and click the [Preferences] button.



The button that is used to open the printer driver properties window (usually [Property] or [Preferences]) may vary depending on the application.

## 2



### Register Print Settings.

- (1) Configure the print settings on each tab.
- (2) Click the [Save] button.

## 3

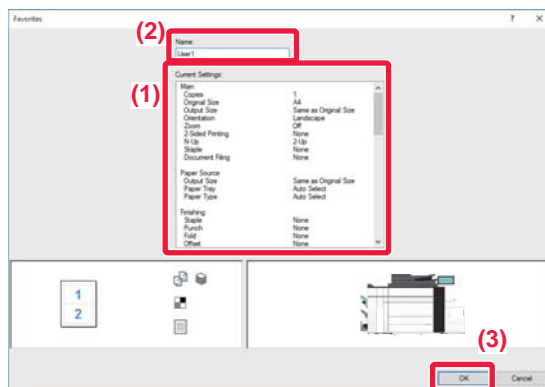

### Check and save the settings.

- (1) Check the displayed settings.
- (2) Enter a name for the settings using up to 20 characters.
- (3) Click the [OK] button.



# USING SAVED SETTINGS

You can specify the saved favorites through just one click to apply frequently used settings to your printing.

1

Select the machine's printer driver from the print window of the application, and click the [Preferences] button.



The button that is used to open the printer driver properties window (usually [Property] or [Preferences]) may vary depending on the application.

2

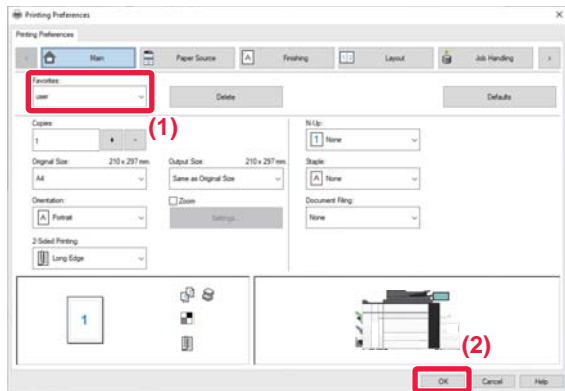

Select favorite settings.

- (1) Select the favorite settings you want to use.
- (2) Click the [OK] button.

3

Start printing.



# CHANGING THE PRINTER DRIVER DEFAULT SETTINGS

You can change the default settings of the printer driver.

Changes you have made in the printer driver properties window when you execute printing from the application are returned to the default settings specified here when you exit the application.

1

Click the [Start] button, select [Settings] → [Device] → [Devices and Printers].



In Windows 8.1/Windows Server 2012, right-click the [Start] button, select [Control Panel] → [View devices and printers] (or [Devices and Printers]).

2

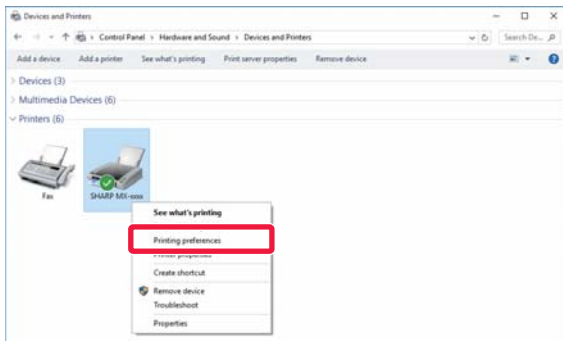

Right-click the printer driver icon of the machine and select [Printing preferences].

3

Configure the settings and click the [OK] button.

For explanations of the settings, see printer driver Help.



# PRINTING IN A macOS ENVIRONMENT

## BASIC PRINTING PROCEDURE

The following example explains how to print a document from the standard accessory application "TextEdit" in macOS.



- To install the printer driver and configure settings in a macOS environment, see the Software Setup Guide.
- The explanations of screens and procedures for use in a macOS environment generally assume that macOS 10.12 is being used and a PPD driver is installed. The screens may be different depending on the version of the operating system or the software application.
- The menu used to execute printing may vary depending on the application.

1

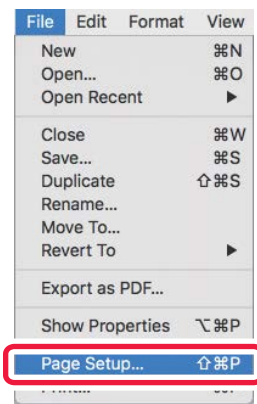

Select [Page Setup] from the [File] menu and select the printer.

If the printer drivers appear as a list, select the name of the printer driver to be used from the list.

2

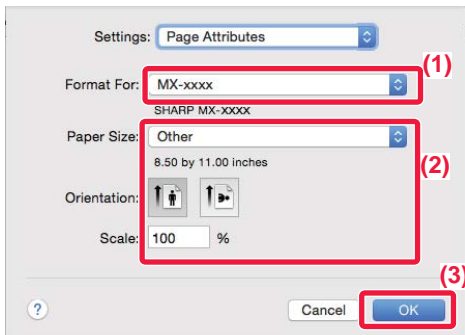

Select paper settings.

(1) Make sure that the correct printer is selected.

(2) Select paper settings.

Paper size, paper orientation, and enlarge/reduce settings can be selected.

(3) Click the [OK] button.

3

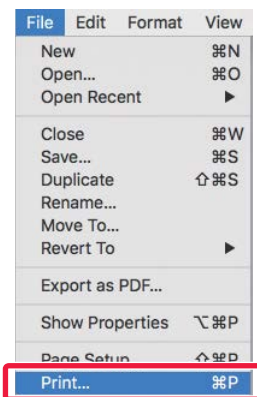

Select [Print] from the [File] menu.



4

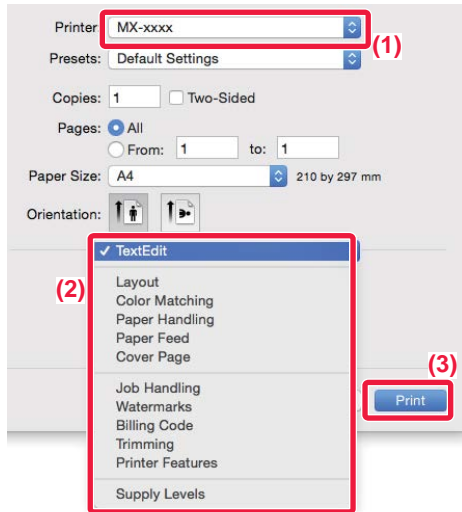

**Select print settings.**

- (1) Make sure that the correct printer is selected.
- (2) Select an item from the menu and configure the settings as needed.
- (3) Click the [Print] button.

## SELECTING THE PAPER

This section explains the [Paper Feed] settings in the print settings window.

• **When [Auto Select] is selected:**

A tray that is set for plain or recycled paper (only plain paper 1 in the factory default setting) of the size specified in "Paper Size" on the page setup screen is automatically selected.

• **When a paper tray is specified:**

The specified tray is used for printing regardless of the "Paper Size" setting on the page setup screen.

For the bypass tray, also specify the paper type. Check that the paper type that is set for the bypass tray of the machine, check that paper of that type is actually loaded into the bypass tray, and then select the appropriate bypass tray (paper type).

• **When a paper type is specified:**

A tray with the specified type of paper and the size specified in "Paper Size" on the page setup screen is used for printing.



Special media can also be placed in the bypass tray.

For the procedure for loading paper in the bypass tray, see "[LOADING PAPER INTO THE BYPASS TRAY \(page 1-104\)](#)".



When [Enable Detected Paper Size in Bypass Tray] (disabled by factory default) or [Enable Selected Paper Type in Bypass Tray] (enabled by factory default), which you can reach by selecting [System Settings] in "Settings (administrator)" → [Printer Settings] → [Condition Settings] → [Bypass Tray Settings] is enabled, printing will not take place if the paper size or paper type specified in the printer driver is different from the paper size or paper type specified in the settings of the bypass tray.



• **To exclude the bypass tray from the trays that can be selected when [Auto Select] is selected:**

In "Settings (administrator)", select [System Settings] → [Printer Settings] → [Condition Settings] → [Bypass Tray Settings] → [Exclude Bypass-Tray from Auto Paper Select].

• **When "A4 / Letter Auto Switching" is enabled**

If you print an 8-1/2" x 11" (letter) size document and there is no 8-1/2" x 11" size paper, printing will automatically take place on A4 paper.

In "Settings (administrator)", select [System Settings] → [Printer Settings] → [Condition Settings] → [A4/Letter Size Auto Change].



# PRINTING WHEN THE USER AUTHENTICATION FUNCTION IS ENABLED

The user information (such as login name and password) that must be entered varies depending on the authentication method being used, so check with the administrator of the machine before printing.



The menu used to execute printing may vary depending on the application.



**To prohibit printing by users whose user information is not stored in the machine:**

In "Settings (administrator)", select [System Settings] → [Authentication Settings] → [Disable Printing by Invalid User].

1

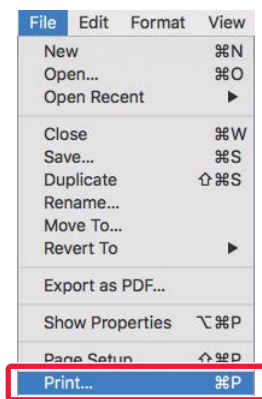

In the application, select [Print] from the [File] menu.



2

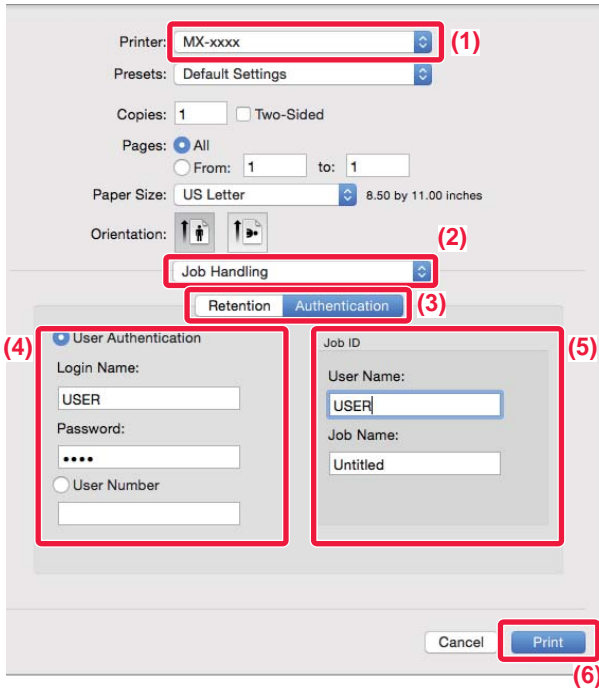

**Enter your user information.**

(1) **Make sure that the machine's printer name is selected.**

(2) **Select [Job Handling].**

(3) **Click the [Authentication] tab.**

(4) **Enter your user information.**

- When authentication is carried out using the login name/password, enter your login name in "Login Name" and your password (1 to 32 characters) in "Password".
- When authentication is carried out using the user number, enter your user number (5 to 8 digits) in "User Number".

(5) **Enter the user name and job name as necessary.**

- **User Name**  
Enter your user name using up to 32 characters. The entered user name will appear on the touch panel of the machine. If you do not enter a user name, your PC login name will appear.
- **Job Name**  
Enter a job name using up to 32 characters. The entered job name will appear as a file name on the touch panel of the machine. If you do not enter a job name, the file name set in the application will appear.

(6) **Click the [Print] button.**





# FREQUENTLY USED FUNCTIONS

## SELECTING THE RESOLUTION

The following three selections are available for "Print Mode" (resolution):

|                        |   |
|------------------------|---|
| 600 dpi                | This mode is suitable for printing data such as regular text or a table.                  |
| 600 dpi (High Quality) | The print quality of photos and text are high.  |
| 1200 dpi               | Select this mode to print photos with higher definition, and to print fine lines clearly. |

### Windows

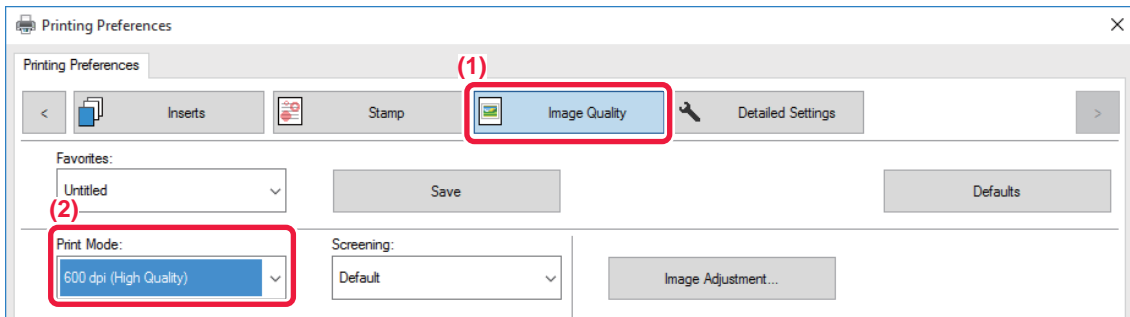

- (1) Click the [Image Quality] tab.
- (2) Select "Print Mode".

### macOS

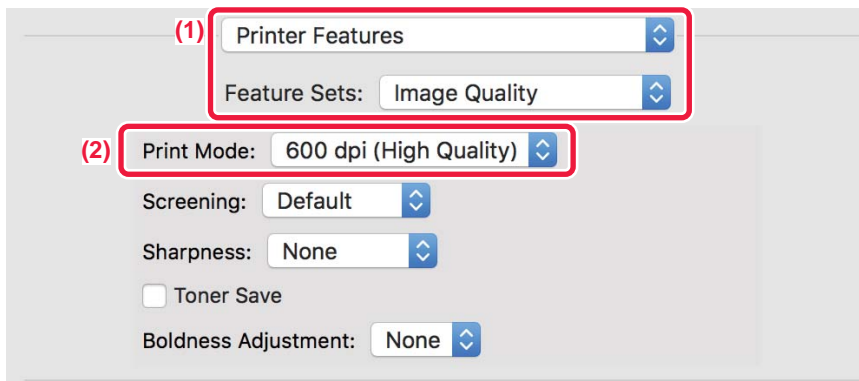

- (1) Select [Image Quality].
- (2) Select "Print Mode".



# 2-SIDED PRINTING

The machine can print on both sides of the paper. This function is useful for many purposes, and is particularly convenient when you want to create a simple pamphlet. 2-sided printing also helps conserve paper.

| Paper orientation | Print results  |   |
|-------------------|--|---|
| Portrait          | Long Edge  | Short Edge  |
|                   |  |   |
| Landscape         | Short Edge   | Long Edge   |
|                   |  |   |
|                   | The pages are printed so that they can be bound at the left or right side. | The pages are printed so that they can be bound at the top. |

## Windows

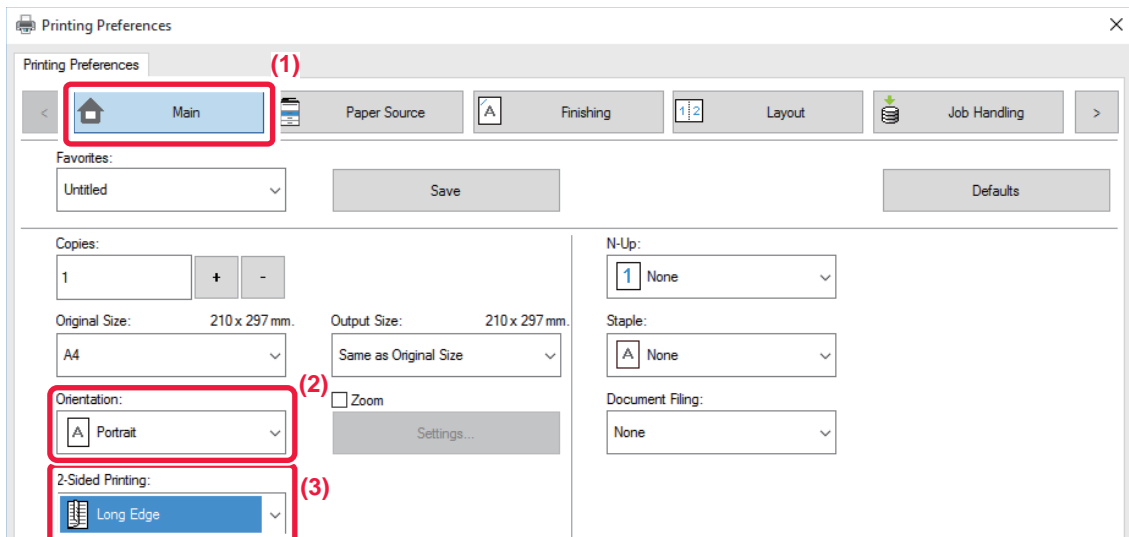

- (1) Click the [Main] tab.
- (2) Select the paper orientation.
- (3) Select [Long Edge] or [Short Edge].



If necessary, you can select the method of implementing 2-sided printing. Click the [Other Settings] button on the [Detailed Settings] tab, and select the mode from "Duplex Style".



macOS

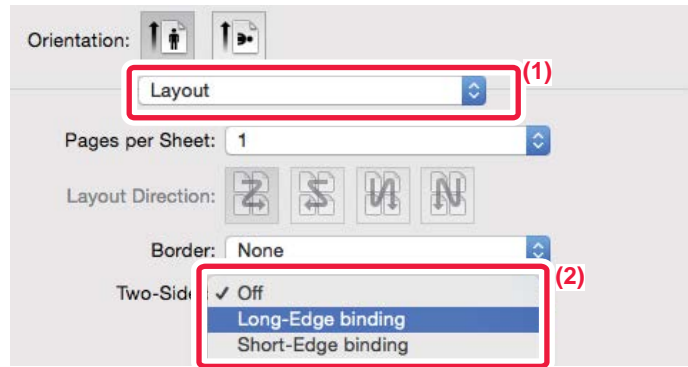

- (1) Select [Layout].
- (2) Select [Long-Edge binding] or [Short-Edge binding].

# FITTING THE PRINT IMAGE TO THE PAPER

This function automatically enlarges or reduces the print image to match the size of the paper loaded in the machine. This function is convenient when enlarging a letter or A4 size document to ledger or A3 size to make it easier to view, or when printing a document on paper that is different in size from the original document.

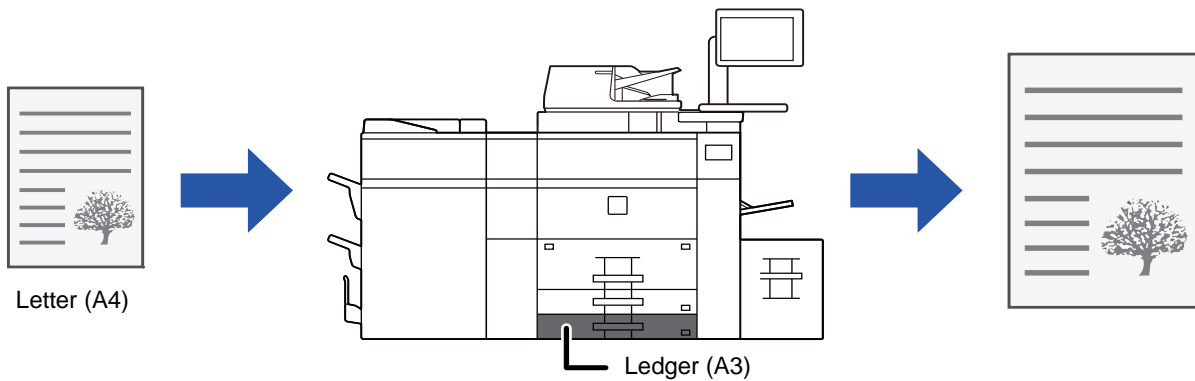

If A0, A1, or A2 size is selected in "Original Size", Letter (or A4) is automatically selected in "Output Size".

The following example explains how to print a letter (or A4) size document on ledger (or A3) size paper.



## Windows

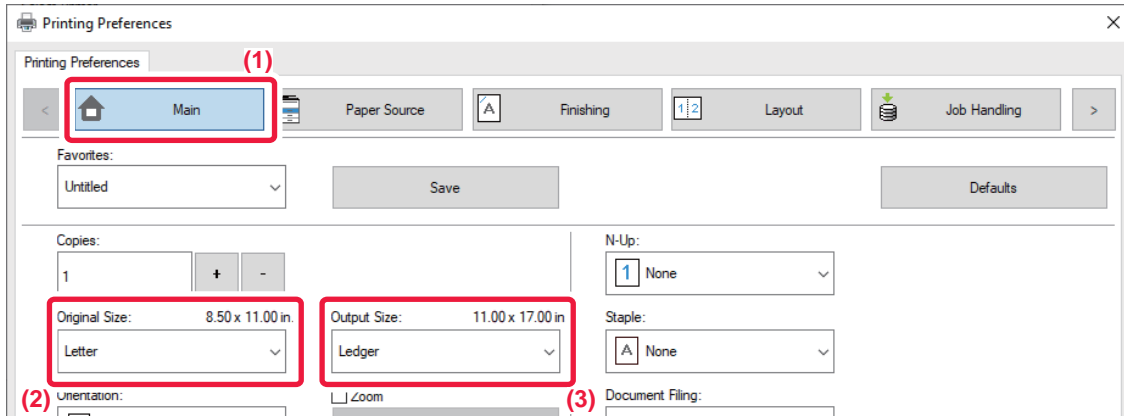

- (1) Click the [Main] tab.
- (2) Select the original size from [Original Size] (for example: Letter).
- (3) Select the actual paper size to be used for printing from [Output Size] (for example: Ledger).
  - If the output size is larger than the original size, the printed image will be automatically enlarged.

## macOS

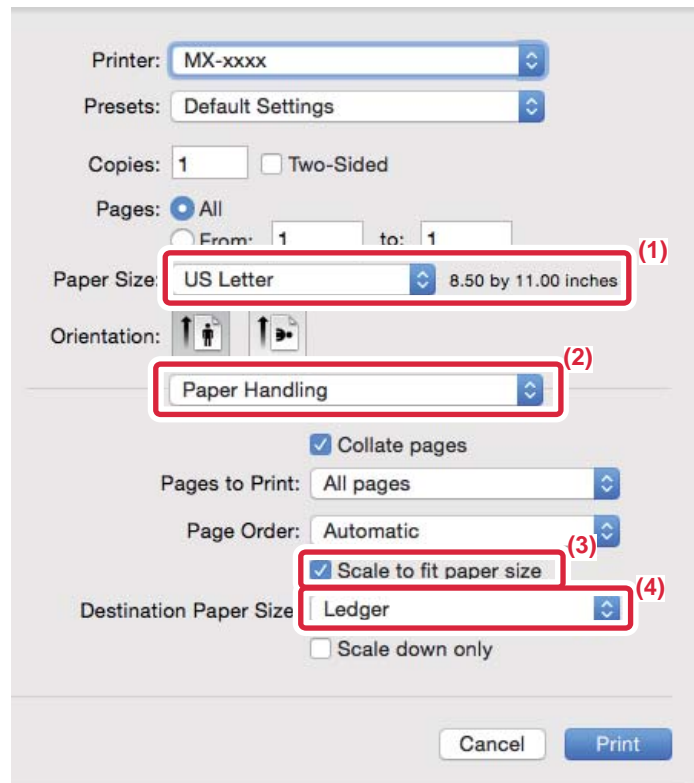

- (1) Check the paper size for the print image (for example: Letter).
- (2) Select [Paper Handling].
- (3) Select [Scale to fit paper size].
- (4) Select the actual paper size to be used for printing (for example: Ledger).



# PRINTING MULTIPLE PAGES ON ONE PAGE

This function reduces the print image and prints multiple pages on a single sheet of paper. You can print only the first page in the original size and print multiple reduced pages on the subsequent sheets.

For example, when [2-Up] (2 pages per sheet) or [4-Up] (4 pages per sheet) is selected, the following print results will be obtained, depending on the selected page order.

This is convenient when you want to print multiple images such as photos on a single sheet of paper, and when you want to conserve paper. When used in combination with 2-sided printing, this function saves more paper.

| N-Up<br>(Pages per sheet)   | Print results |               |  |
|-----------------------------|---------------|---------------|--|
|                             | Left to Right | Right to Left | Top To Bottom<br>(When the print orientation is landscape) |
| 2-Up<br>(2 pages per sheet) |               |               |  |

| N-Up<br>(Pages per sheet)   | Right, and Down | Down, and Right | Left, and Down | Down, and Left |
|-----------------------------|-----------------|-----------------|----------------|----------------|
| 4-Up<br>(4 pages per sheet) |                 |                 |                |                |



- [N-Up] that can be set on the [Layout] tab can also be set on the [Main] tab. ("Order" can only be set in the [Layout] tab.)
- Note the following when printing multiple pages on one sheet:
  - The page orders for 6-Up, 8-Up, 9-Up, and 16-Up are the same as for 4-Up.
  - In a Windows environment, the page order can be viewed in the print image in the printer driver properties window.
  - In a macOS environment, the page orders are displayed as selections.
  - In a macOS environment, the number of pages that can be printed on a single sheet is 2, 4, 6, 9, or 16. Printing 8 pages on one sheet is not supported.
  - For information on the "Repeat" function, see "[PRINT THE SAME IMAGE IN TILE PATTERN \(REPEAT PRINT\) \(page 3-67\)](#)".



The function for printing only the first page normally can only be used in the PCL6 printer driver.



## Windows

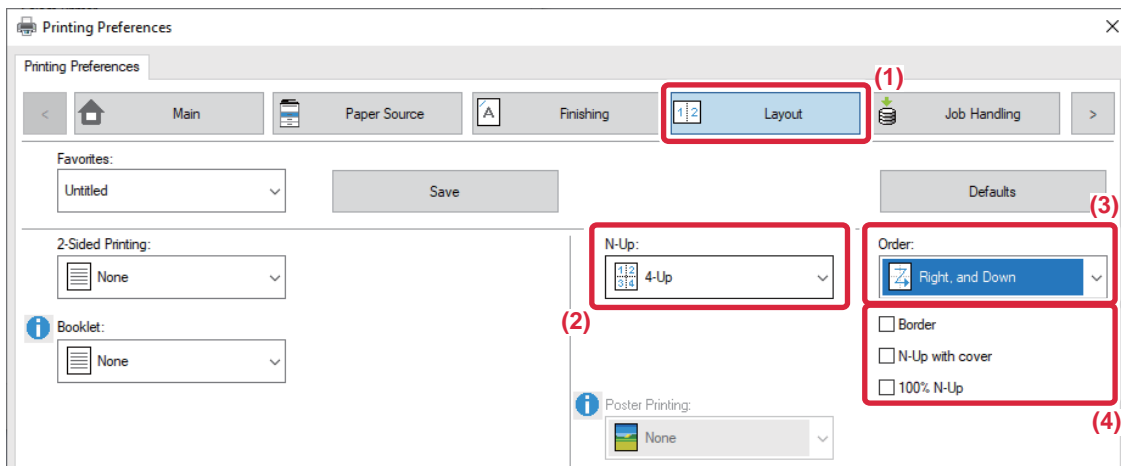

- (1) Click the [Layout] tab.
- (2) Select the number of pages per sheet.
- (3) Select the order of the pages.
- (4) If you wish to print borderlines, click the [Border] checkbox so that the checkmark  appears.
  - To print the first page normally (as a cover), select the [N-Up with cover] checkbox (  ). (PCL6 only)
  - When [100% N-Up] is selected (  ) for jobs such as N-Up copying of two A4 size pages onto one A3 sheet, the pages will be printed at the full size of the original. If you select [Border] at this time, only the border will be printed.

## macOS

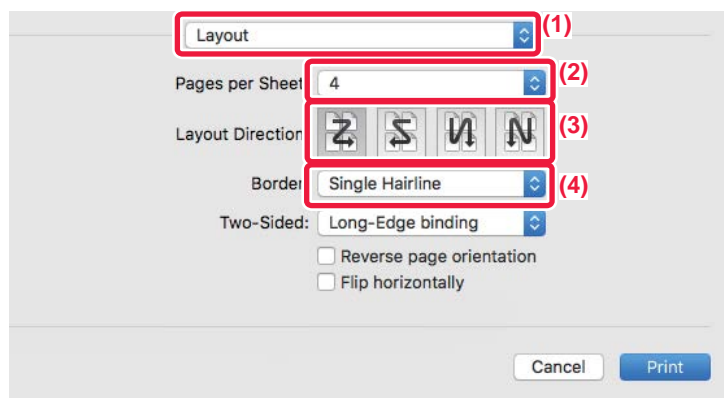

- (1) Select [Layout].
- (2) Select the number of pages per sheet.
- (3) Select the order of the pages.
- (4) If you wish to print borderlines, select the desired type of borderline.



# PRINTING WHILE SKIPPING BLANK PAGES

If the scanned original contains blank pages, the blank pages are skipped during printing. The machine detects blank pages and does not print them. This eliminates unnecessary printing without you having to check for blank pages before printing.

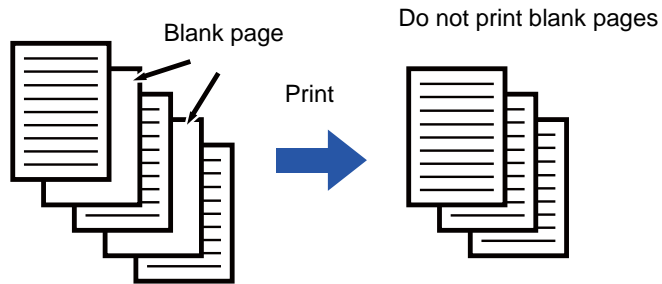

This function is available in a Windows environment.



- Depending on the state of the original, some pages that are not blank may be detected as blank pages and thus not being printed, or some pages that are blank may not be detected as blank and thus printed.
- In N-Up Print, blank pages are not excluded and are printed.

## Windows

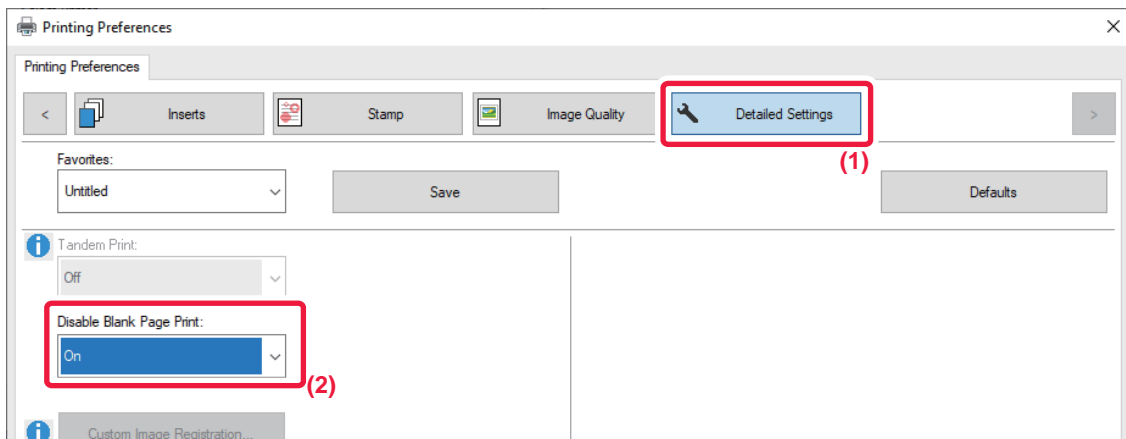

- (1) Click the [Detailed Settings] tab.
- (2) Select [On] in [Disable Blank Page Print].









# STAPLING OUTPUT/PUNCHING HOLES IN OUTPUT

## Staple function

The staple function staples the output. To create materials with more sophisticated appearance, the staple function can be used in combination with 2-sided printing.

This function saves considerable time when preparing handouts for a meeting or other stapled materials.



The stapling positions and the number of staples can be selected to obtain the following stapling results.

| Staple    | Left  | Right  | Top   |
|-----------|---|--|---|
| 1 Staple* |  |  |  |
| 2 Staples |  |  |  |

\* The staple orientation (" | " or " — ") varies depending on the size and orientation of the paper.

## Punch function

The punch function punches holes in the output. The punch hole positions are set by selecting the binding edge.

| Left  | Right   | Top   |
|---|---|---|
|  |  |  |



- A finisher (large stacker), saddle stitch finisher (large stacker) is required to use the staple function.
- To use the punch function, installing a punch module in the finisher (large stacker), or saddle stitch finisher (large stacker).
- For the maximum number of sheets that can be stapled, see "1".
- The maximum number of sheets that can be stapled at once includes any covers and/or inserts that are inserted.
- For information on the saddle stitch function, see "[CREATE A PAMPHLET \(BOOKLET/SADDLE STITCH\) \(page 3-26\)](#)".



- The staple and offset (shifting the position of the paper that is output for each job) functions cannot be used simultaneously.
- When the finisher is disabled in the machine's settings, the staple function and punch function cannot be used.
- When the staple function or the punch function is disabled in the machine's settings, stapling or punching is not possible.





## Windows

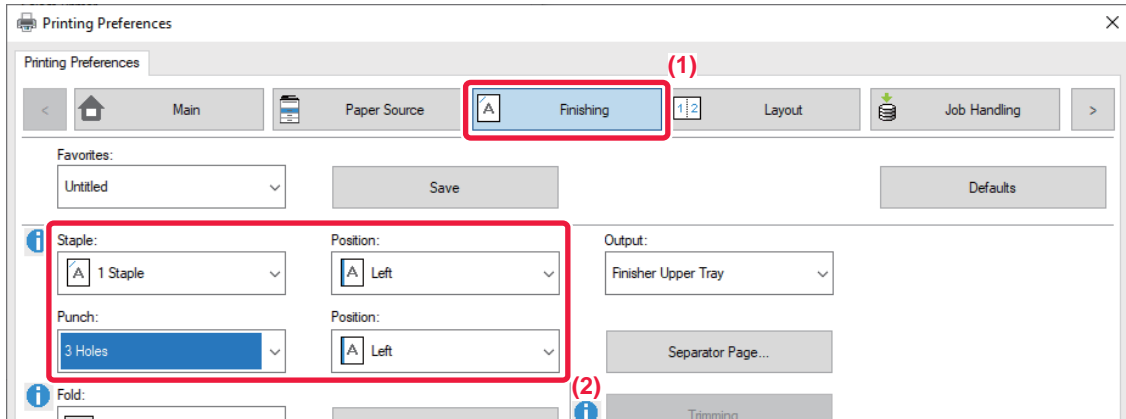

(1) Click the [Finishing] tab.

(2) Select the staple function or the punch function.

- For the staple function, select the number of staples in the "Staple" menu and the staple position in the "Position" menu.
- For the punch function, select the type of punch in the "Punch" menu and the punch position in the "Position" menu.



In addition to the [Finishing] tab, [Staple] can also be set on the [Main] tab.

## macOS

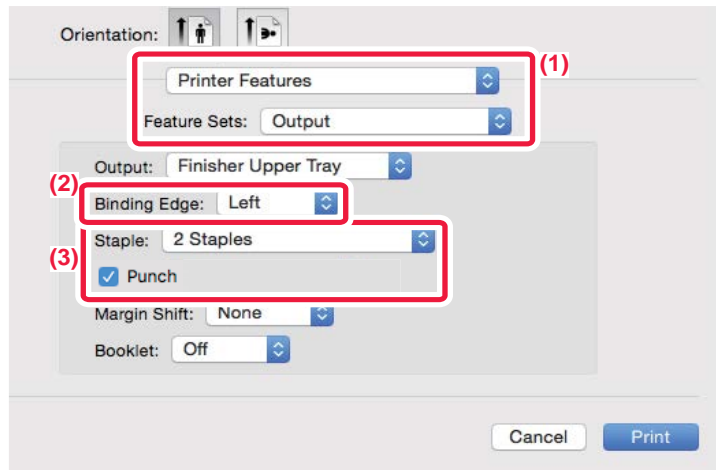

(1) Select [Printer Features] and then select [Output].

(2) Select "Binding Edge".

(3) Select the staple function or the punch function.

- For the staple function, select the number of staples in the "Staple" menu.
- For the punch function, select the type of punch in the "Punch" menu.



# CONVENIENT PRINTING FUNCTIONS

## CONVENIENT FUNCTIONS FOR CREATING PAMPHLETS AND POSTERS

### CREATE A PAMPHLET (BOOKLET/SADDLE STITCH)

The pamphlet function prints on the front and back of each sheet of paper so that the sheets can be folded and bound to create a pamphlet.

If a saddle finisher is installed and if "Booklet" and "Staple" are selected, this function automatically folds and outputs the copies. This is convenient when you wish to compile printed output into a pamphlet.

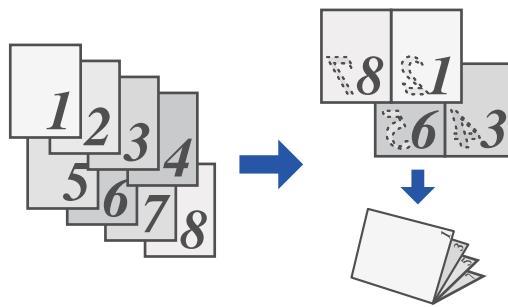

### Windows

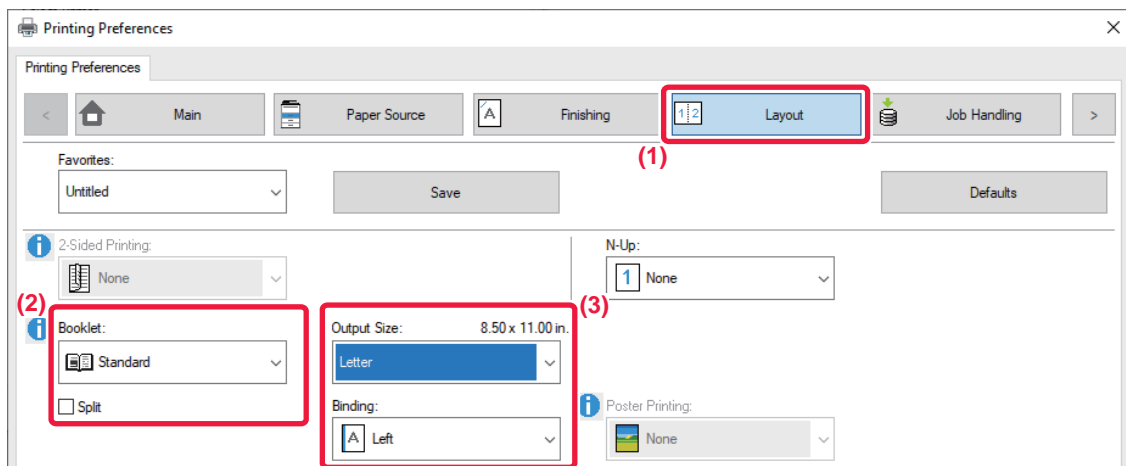

(1) Click the [Layout] tab.

(2) Select [Standard] or [Full Image] in "Booklet".

- When [Standard] is selected, the printed image will be enlarged or reduced to fit the paper selected in "Output Size".
- When [Full Image] is selected, the printed image will be enlarged or reduced to fit the size selected in "Fit To Paper Size". By selecting a paper size that is larger than the print image, you can cut off the edges of the paper after making the booklet to create a booklet with no margins.
- When the number of output pages will exceed the number of sheets that can be stapled, you can select the [Split] checkbox () to divide the output into multiple sub-booklets that can each be stapled. When stacked, the sub-booklets will have the same page order as the original pages.

(3) Select the specified output size and the binding edge.

- When [Standard] is selected, select the output paper size.
- When [Full Image] is selected, select the size to which you want to enlarge or reduce the print image in [Fit To Paper Size], and select the paper size you want to use for printing in "Output Size".



### If a saddle stitch finisher is installed

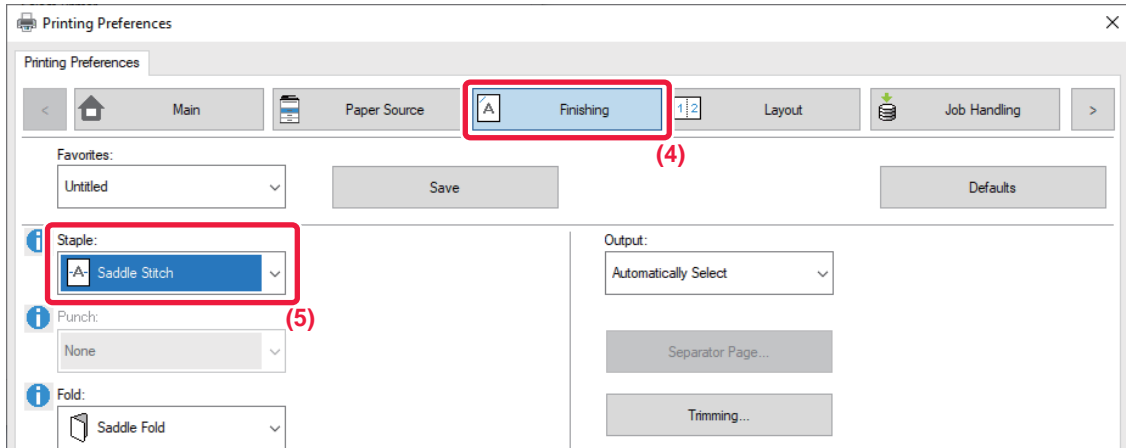

- (4) Click the [Finishing] tab.
- (5) Select [Saddle Stitch] from "Staple".



When a saddle finisher (large capacity) is installed and the job is not output correctly with [Saddle Stitch], select [Saddle Stitch (Reverse)].

## macOS

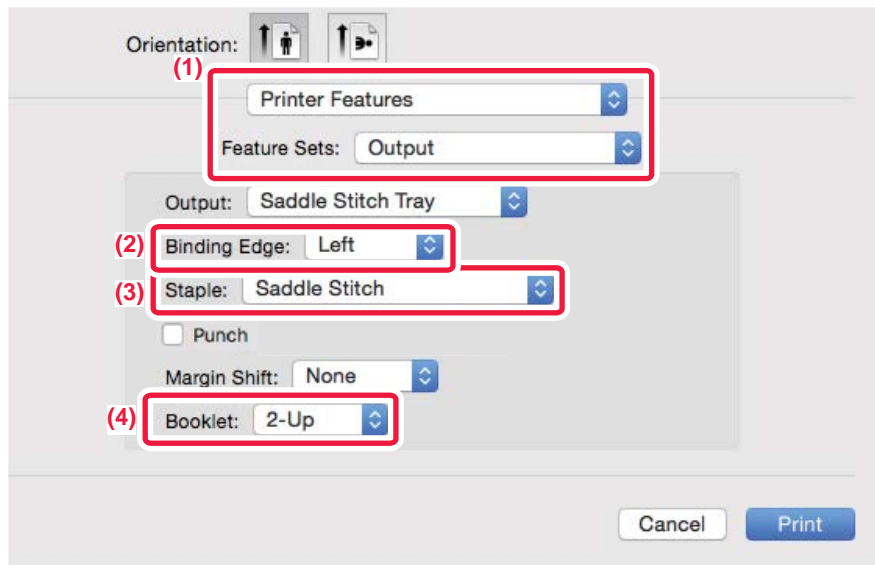

- (1) Select [Printer Features] and then select [Output].
- (2) Select "Binding Edge".
- (3) Select [Saddle Stitch].
- (4) Select [Off] or [2-Up].



# TRIMMING THE EXCESS OF FOLDED PAPER

If a trimmer unit is installed, you can trim off excess edges of paper for a finer finish.

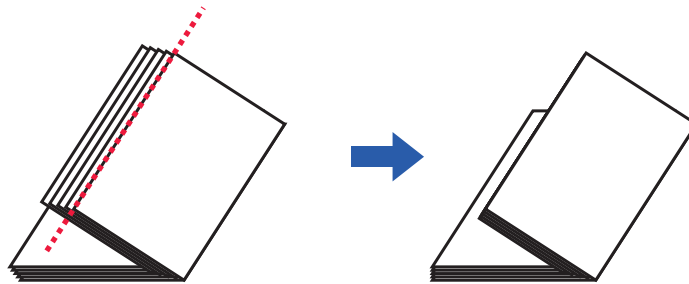

## Windows

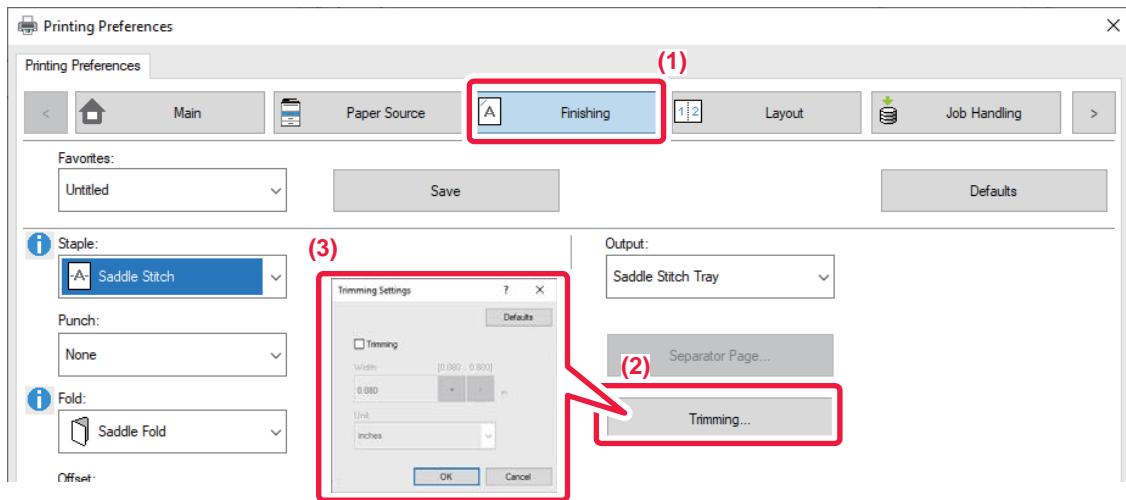

- (1) Click the [Finishing] tab.
- (2) Click the [Trimming] button.
- (3) Set the [Trimming] checkbox to  , and specify "Trimming Width".



macOS

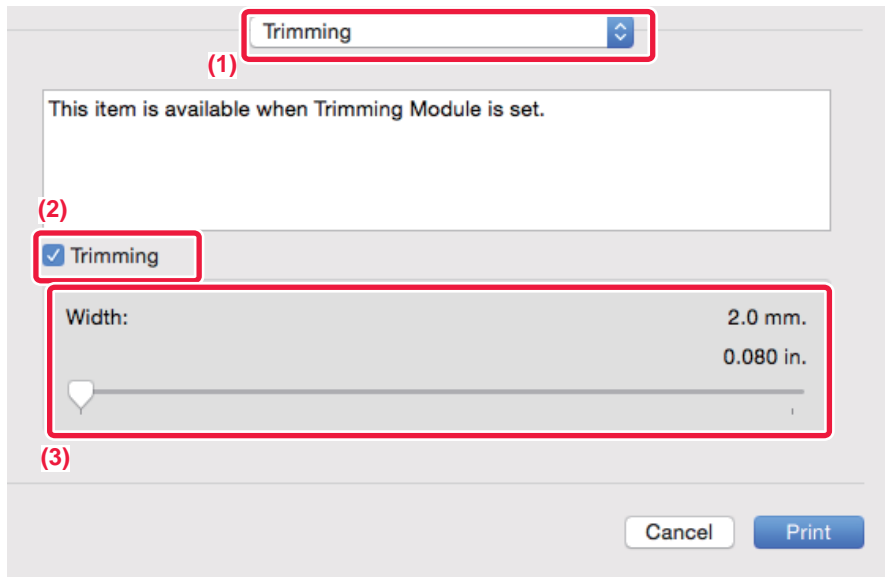

- (1) Select [Trimming].
- (2) Set the [Trimming] checkbox to .
- (3) Specify the trimming width.



## PRINTING WITH MARGIN SHIFT SETTING (MARGIN)

This function shifts the print image to increase the margin at the left, the right, or the top of the paper. If a finisher or saddle finisher is installed, the staple and punch functions of the machine can also be used together. This is convenient when you wish to staple or punch the output but the binding area overlaps the text.

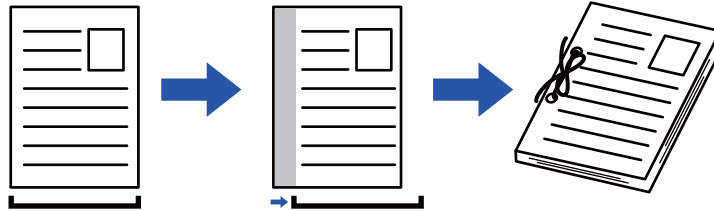

By shifting the image, the part of the image that is outside the print area will not be printed.

### Windows

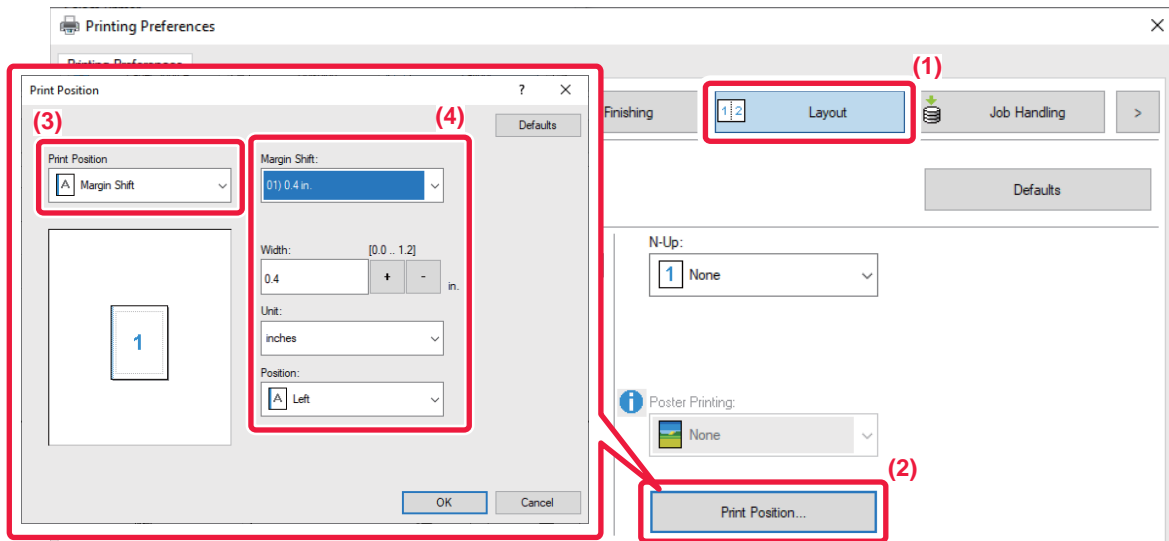

- (1) Click the [Layout] tab.
- (2) Click the [Print Position] button.
- (3) Select [Margin Shift].
- (4) Select the shift width.

Select from the "Margin Shift" menu. If you wish to configure another numeric setting, select the setting and click   buttons or directly enter the number.



macOS

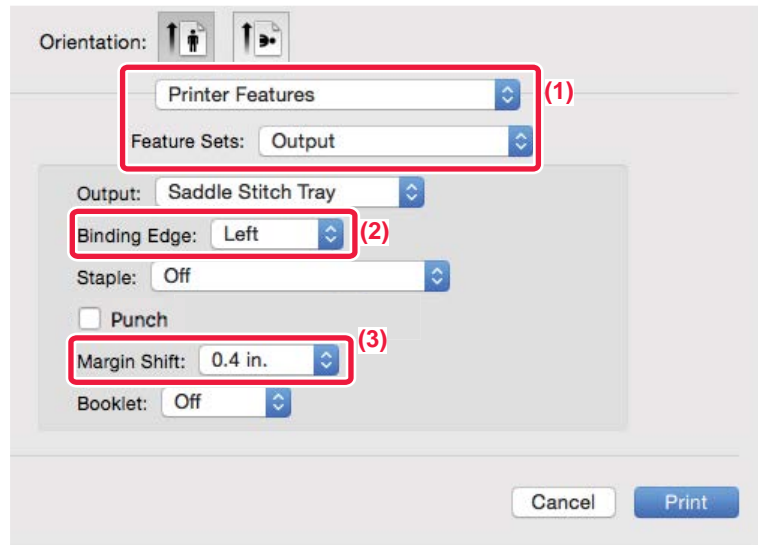

- (1) Select [Printer Features] and then select [Output].
- (2) Select "Binding Edge".
- (3) Select "Margin Shift".



# CREATE A LARGE POSTER (POSTER PRINTING)

One page of print data is enlarged and printed using multiple sheets of paper (4 sheets (2 x 2), 9 sheets (3 x 3) or 16 sheets (4 x 4)). The sheets can then be attached together to create a large poster.

To enable precise alignment of the edges of the sheets during attachment, borderlines can be printed or overlapping edges can be created (overlap function).

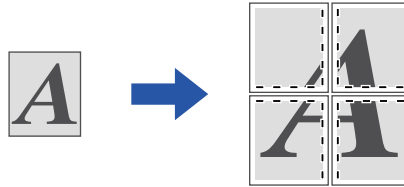

This function is available in a Windows environment.

## Windows

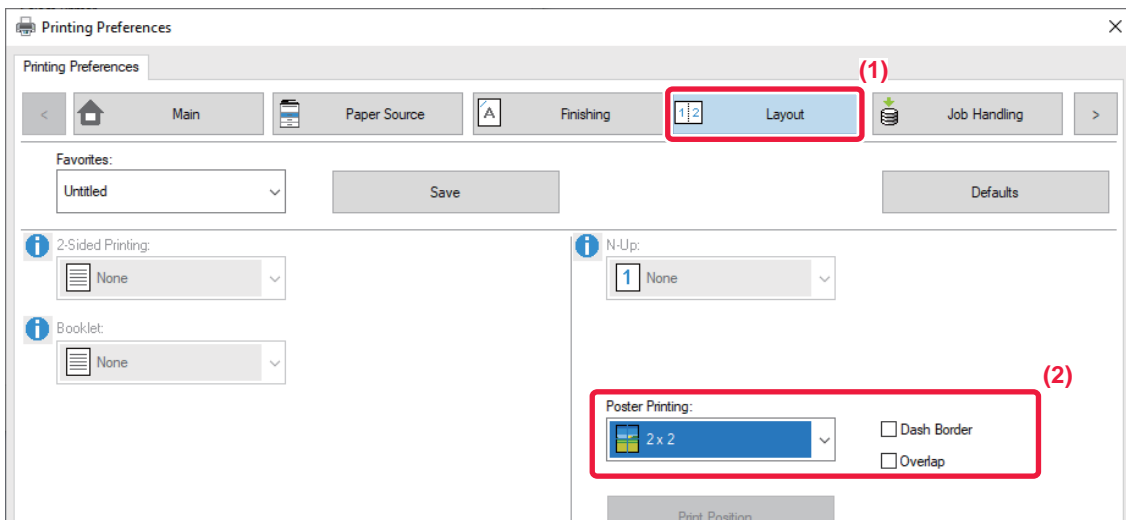

(1) Click the [Layout] tab.

(2) Select the number of sheets to be used in "Poster Printing".

If you wish to print borderlines and/or use the overlap function, click the corresponding checkboxes so that the  appears.





# FUNCTIONS TO ADJUST THE SIZE AND ORIENTATION OF THE IMAGE

## ADJUST PRINT POSITION ON ODD AND EVEN PAGES SEPARATELY (PRINT POSITION)

This function sets different print positions (margins) separately for odd and even pages and prints the pages.



This function is available in a Windows environment.

### Windows

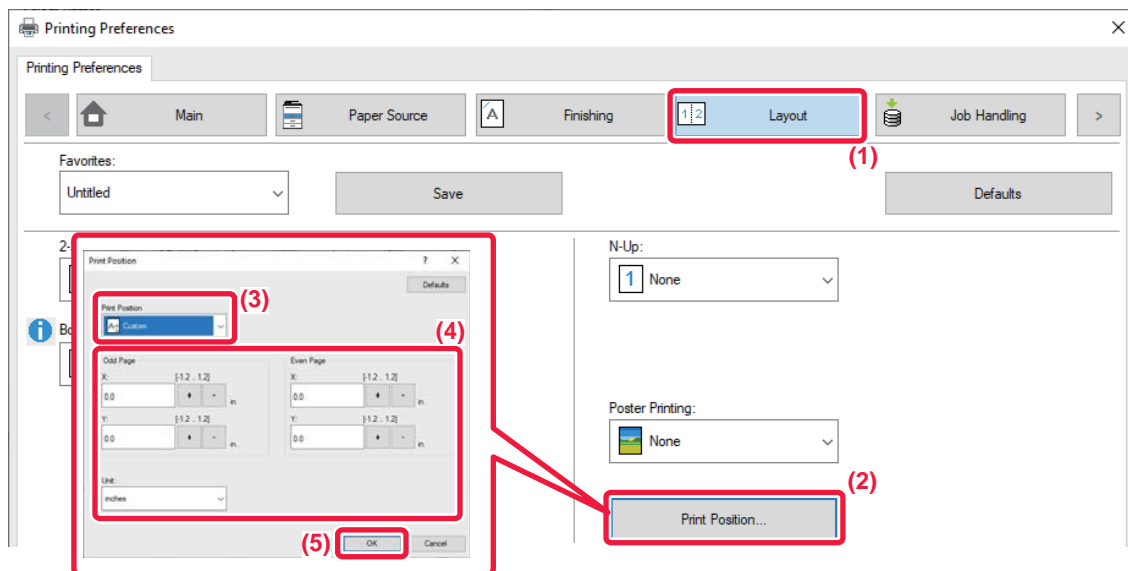

- (1) Click the [Layout] tab.
- (2) Click the [Print Position] button.
- (3) Select [Custom].
- (4) Set the amount of shifting of the print position for odd-numbered pages and even-numbered pages.
- (5) Click the [OK] button.



# ROTATING THE PRINT IMAGE 180 DEGREES (ROTATE 180 DEGREES)

This feature rotates the image 180 degrees so that it can be printed correctly on paper that can be loaded in only one orientation (such as paper with punch holes).

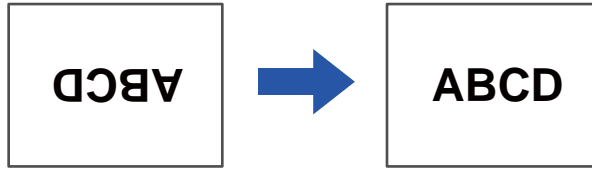

## Windows

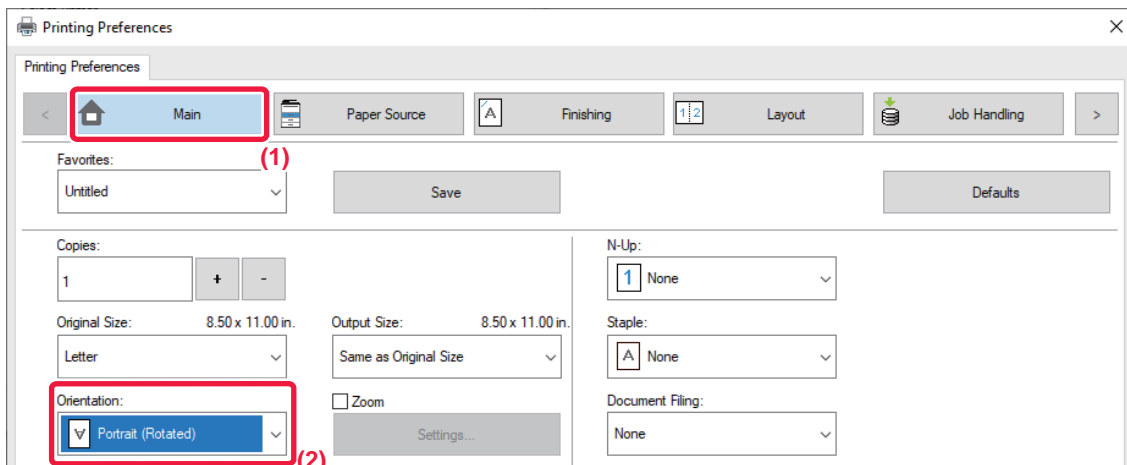

- (1) Click the [Main] tab.
- (2) Select [Portrait (Rotated)] or [Landscape (Rotated)] in "Orientation".

## macOS

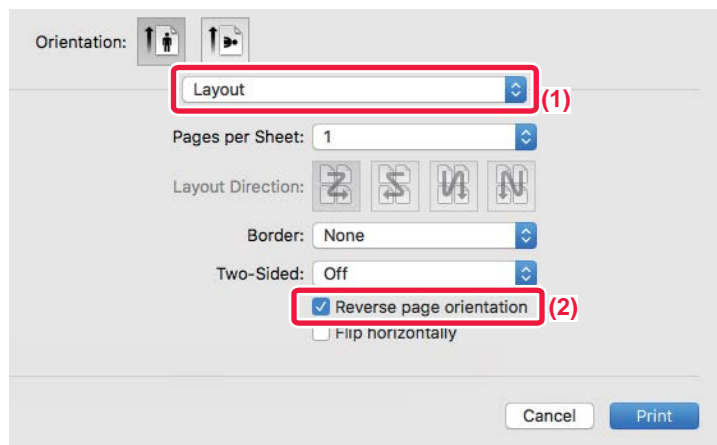

- (1) Select [Layout]
- (2) Select the [Reverse page orientation] checkbox so that  appears.



# ENLARGING/REDUCING THE PRINT IMAGE (ZOOM SETTING/ENLARGE OR REDUCE)

This function enlarges or reduces the image to a selected percentage.

This allows you to enlarge a small image or add margins to the paper by slightly reducing an image.

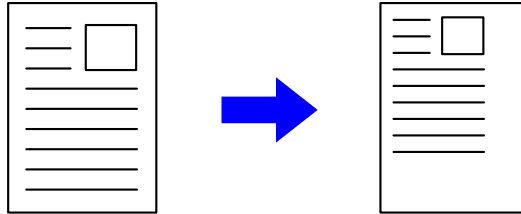

When using the PS printer driver (Windows), you can set the width and length percentages separately to change the proportions of the image.

## Windows

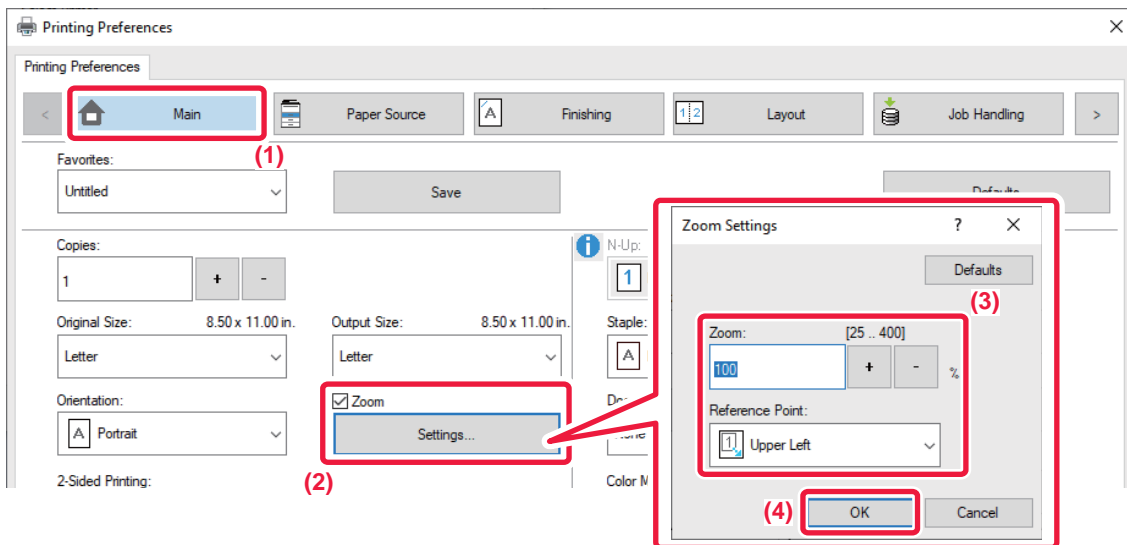

(1) Click the [Main] tab.

(2) Click the [Zoom] checkbox so that  appears, and click the [Settings] button.

(3) Enter the percentage.

By clicking the   button, you can specify the value in increments of 1%. In addition, select [Upper Left] or [Center] for the base point on the paper.

(4) Click the [OK] button.



## macOS

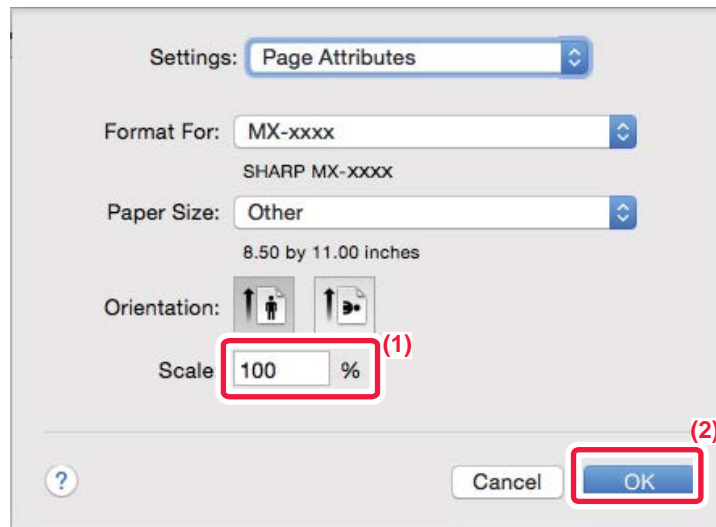

- (1) Select [Page Setup] from the [File] menu and enter the ratio (%).
- (2) Click the [OK] button.



# ADJUST THE LINE THICKNESS (WIDTH)

## Adjusting line widths used in data such as CAD

This function increases the thickness of the entire line when the print lines are not clear in CAD or other special applications.

When the data includes lines of varying widths, you can print all lines at the minimum width as necessary.

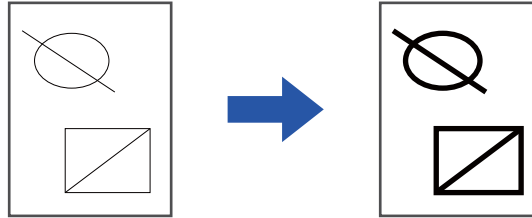

- This function is available in a Windows environment.
- This function can be used when the PCL6 printer driver is used.
- When printing from an application that processes lines as raster graphics, line widths cannot be adjusted.

## Windows

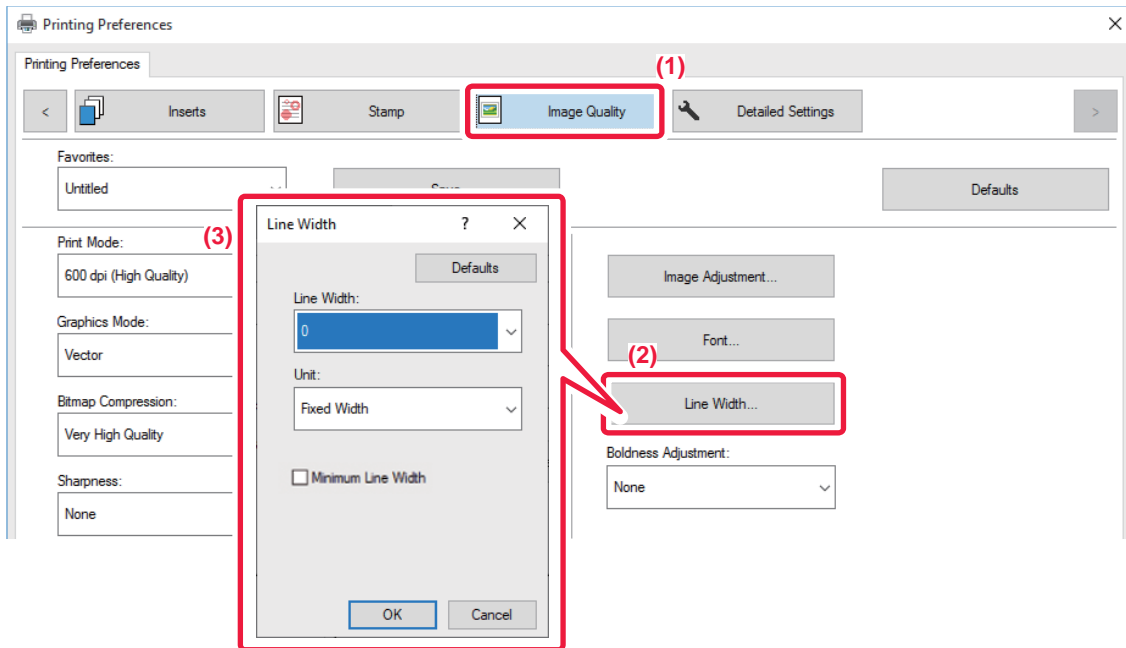

- (1) Click the [Image Quality] tab.
- (2) Click the [Line Width] button.
- (3) Set the line thickness and click the [OK] button.



- The units of line-width adjustment can be set to "Fixed Width" or "Ratio". Select from the "Unit" menu.
- To print all line data in the minimum line width, click the [Minimum Line Width] checkbox.



## Thickening fine lines in Excel

When fine border lines in Excel do not print correctly, you can make the lines thicker.



- This function is available in a Windows environment.
- This function can be used when the PCL6 printer driver is used.
- Normally this setting is not necessary.

### Windows

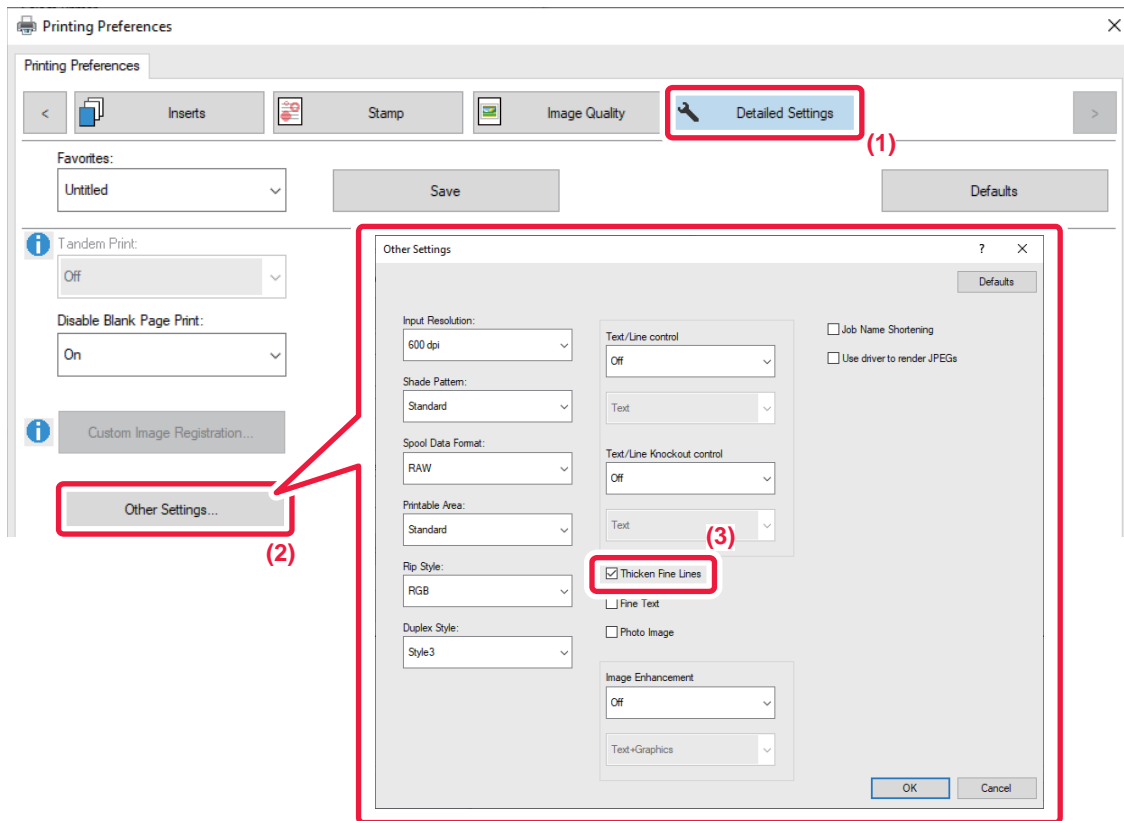

- (1) Click the [Detailed Settings] tab.
- (2) Click the [Other Settings] button.
- (3) Select the [Thicken Fine Lines] checkbox (  ).



# Adjusting the thickness of text and lines

You can make text and lines thicker. You can also make edges smoother or sharper.

## Windows

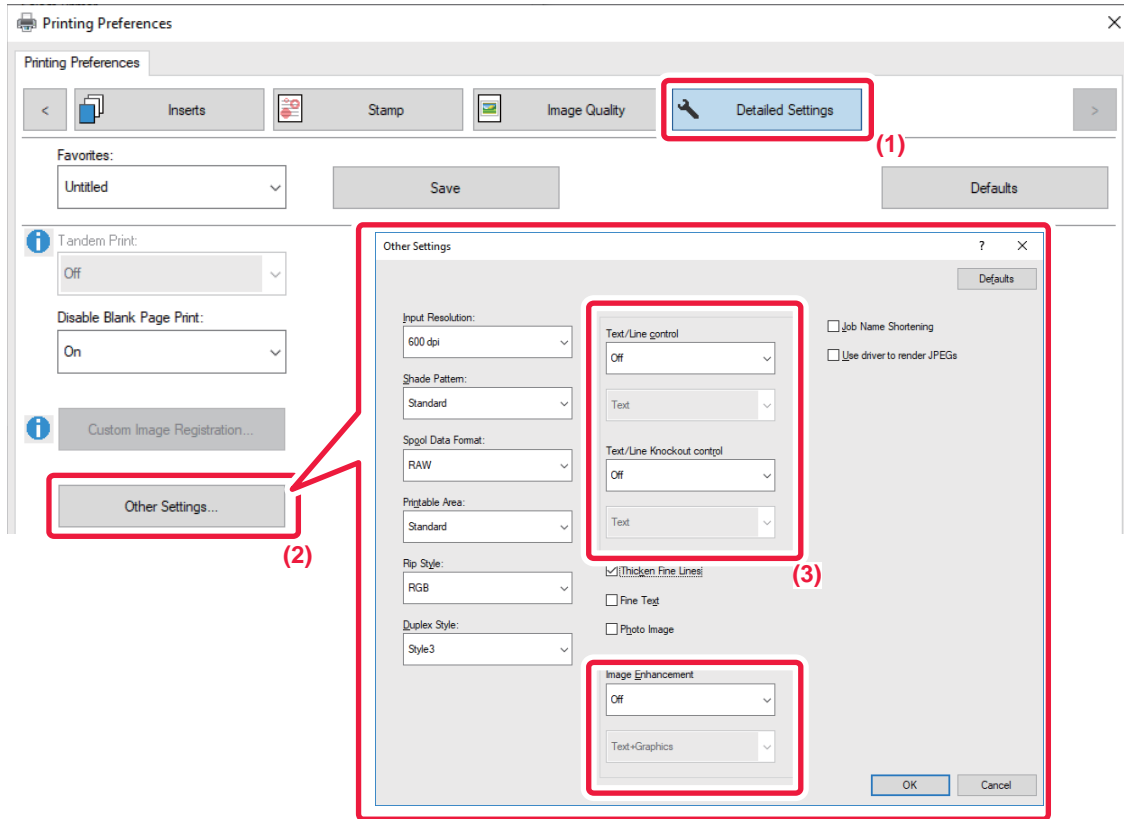

- (1) Click the [Detailed Settings] tab.
- (2) Click the [Other Settings] button.
- (3) Specify the settings.

| Item                       |                             | Description  |
|----------------------------|-----------------------------|--|
| Text/Line control          | Text                        | You can make characters and text thicker.                        |
|                            | Graphics                    |  |
|                            | Text+Graphics               |  |
|                            | Text+Graphics+Photo         |  |
| Text/Line Knockout control | Text                        | You can make knockout text and lines thicker.                    |
|                            | Text+Graphics               |  |
| Image Enhancement          | Text                        | You can make the edges of text and graphics smoother or sharper. |
|                            | Text+Graphics               |  |
|                            | Text+knockout text          |  |
|                            | Text+Graphics+knockout text |  |
|                            | Text+Graphics+knockout      |  |



macOS

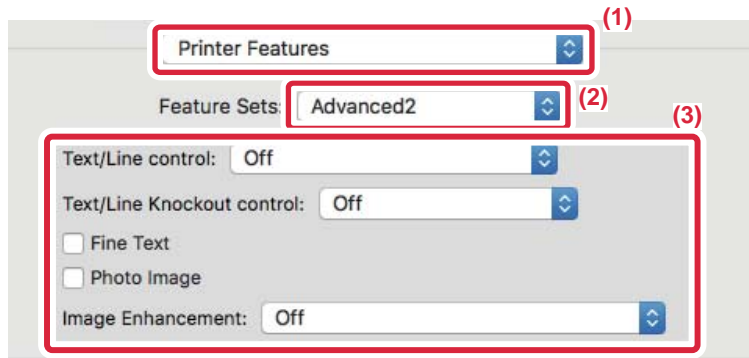

- (1) Select [Printer Features].
- (2) Select [Advanced2].
- (3) Specify the settings.





# PRINT A MIRROR-IMAGE (MIRROR-IMAGE REVERSE/VISUAL EFFECTS)

The image is reversed to create a mirror image. This function is conveniently used to print a design for a woodblock print or other printing medium.

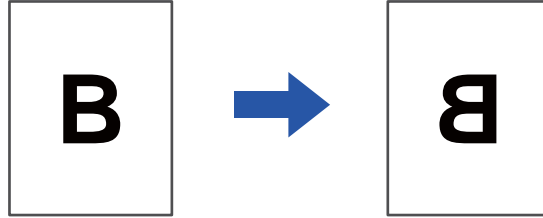

In a Windows environment, this function is only available when using the PS printer driver.

## Windows

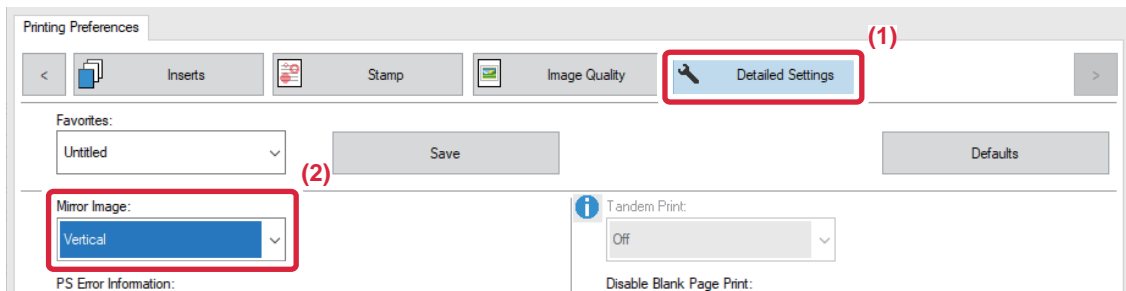

- (1) Click the [Detailed Settings] tab.
- (2) If you wish to reverse the image horizontally, select [Horizontal]. If you wish to reverse the image vertically, select [Vertical].

## macOS

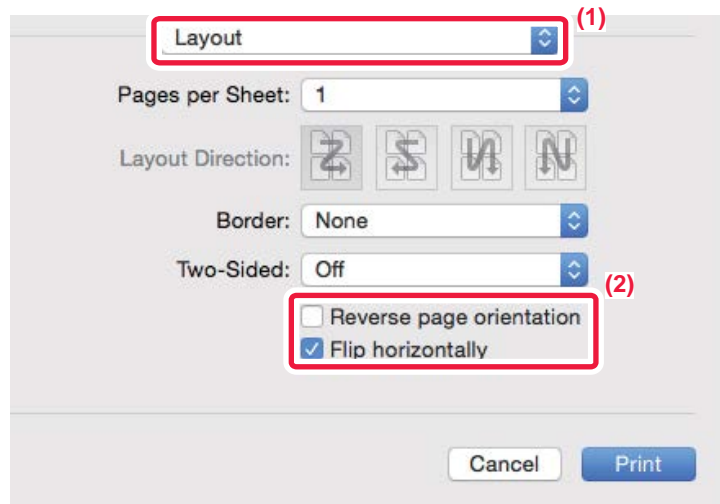

- (1) Select [Layout].
- (2) Select the [Flip horizontally] checkbox (  ).



# IMAGE ADJUSTING FUNCTION

## ADJUST THE BRIGHTNESS AND CONTRAST OF THE IMAGE (IMAGE ADJUSTMENT)

This function adjusts the brightness and contrast in the print settings when a photo or other image is printed. This function makes simple corrections even if image editing software is not installed on your computer.



This function can be used in a Windows environment.

### Windows

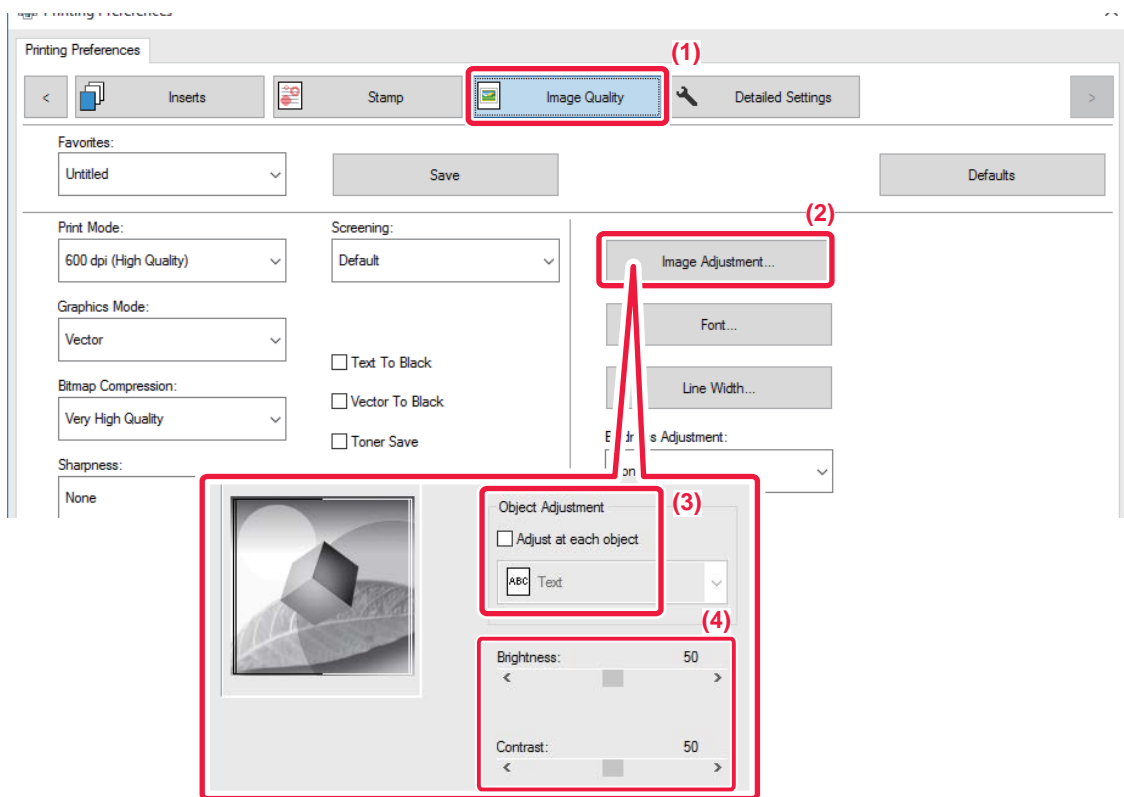

- (1) Click the [Image Quality] tab.
- (2) Click the [Image Adjustment] button.
- (3) To adjust objects (text, graphics, photos) individually, select the [Adjust at each object] checkbox () and select the object.
- (4) Drag the slide bar  or click   buttons to adjust the image.



# PRINTING FAINT TEXT AND LINES IN BLACK (TEXT TO BLACK/VECTOR TO BLACK)

When printing a color image in grayscale, text and lines that are drawn in faint colors are printed in black. This function allows you to bring out color text and lines that are faint and difficult to see when printed in grayscale.

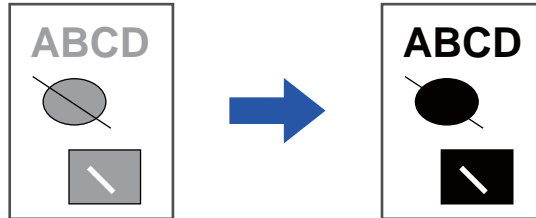

- Raster data such as bitmap images cannot be adjusted.
- This function is available in a Windows environment.

## Windows

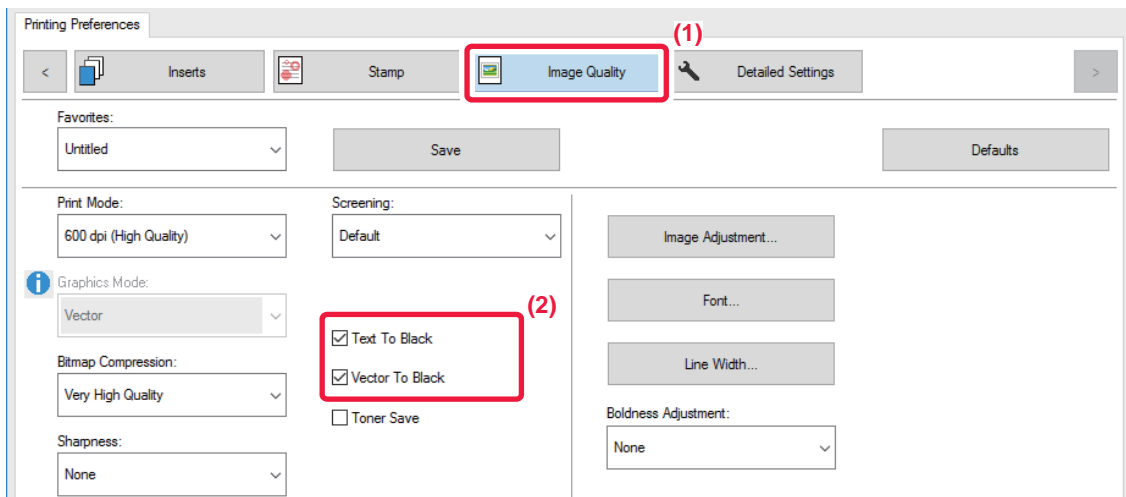

(1) Click the [Image Quality] tab.

(2) Select the [Text To Black] checkbox and/or the [Vector To Black] checkbox so that  appears.

- When [Text To Black] is selected, all text other than white text is printed in black.
- When [Vector To Black] is selected, all vector graphics other than white lines and areas are printed in black.



# FUNCTIONS TO COMBINE TEXT AND IMAGES

## ADDING A WATERMARK TO PRINTED PAGES (WATERMARK)

This function adds faint shadow-like text as a watermark in the background of the printed image. The size and angle of the watermark text can be adjusted.

The watermark text can be selected from the previously registered text in the list. When necessary, you can enter text to create an original watermark.

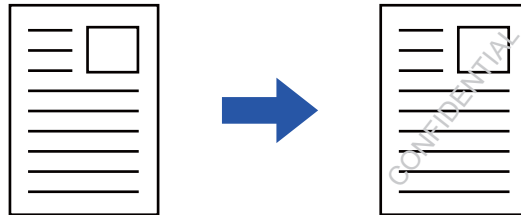

### Windows

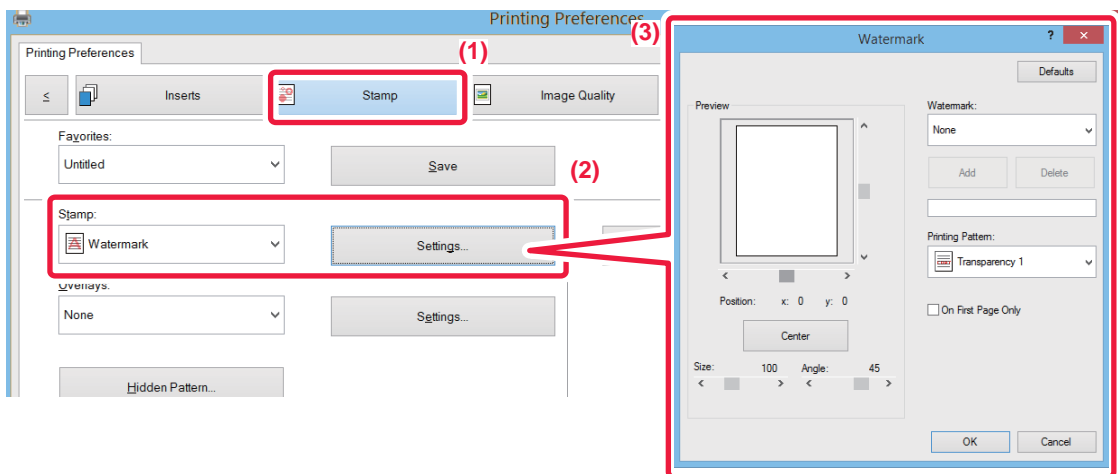

- (1) Click the [Stamp] tab.
- (2) Select [Watermark] from "Stamp" and click the [Settings] button.
- (3) Select the watermark to be used and click the [OK] button.



If you want to create a new watermark, enter the text of the watermark in the text box and click the [Add] button.



Mac OS

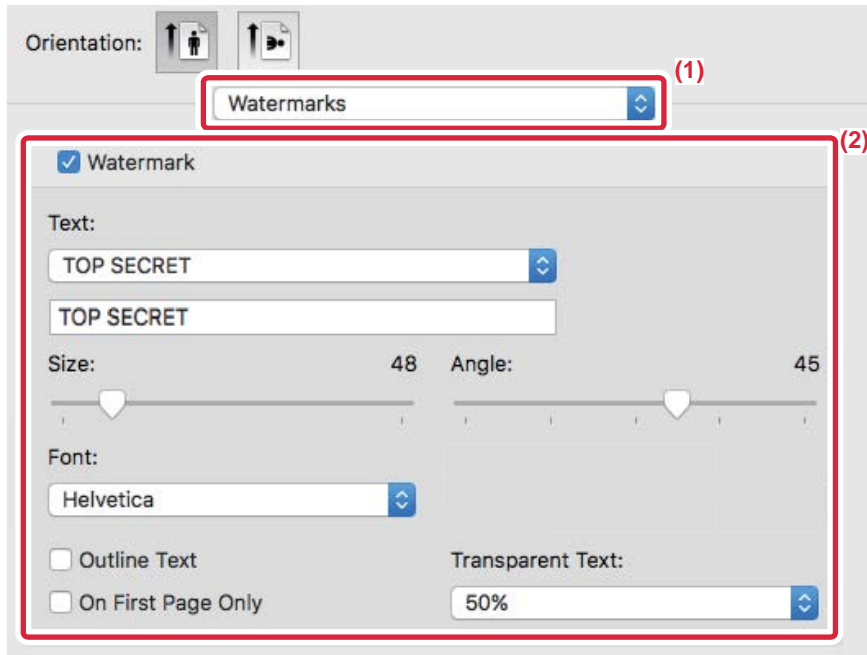

- (1) Select [Watermarks].
- (2) Click the [Watermark] checkbox and configure watermark settings.
  - Configure detailed watermark settings such as selection of the text.
  - Adjust the size and angle of the text by dragging the slide bar .



# PRINTING AN IMAGE OVER THE PRINT DATA (IMAGE STAMP)

This function prints a bitmap or JPEG image stored on your PC over the print data.

This function prints a frequently used image or an icon of your own creation as if it is stamped on the print data. The size, position, and angle of the image can be adjusted.

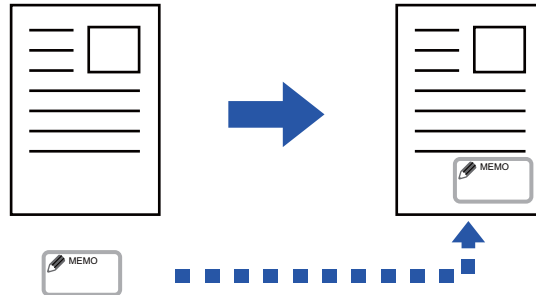

This function is available in a Windows environment.

## Windows

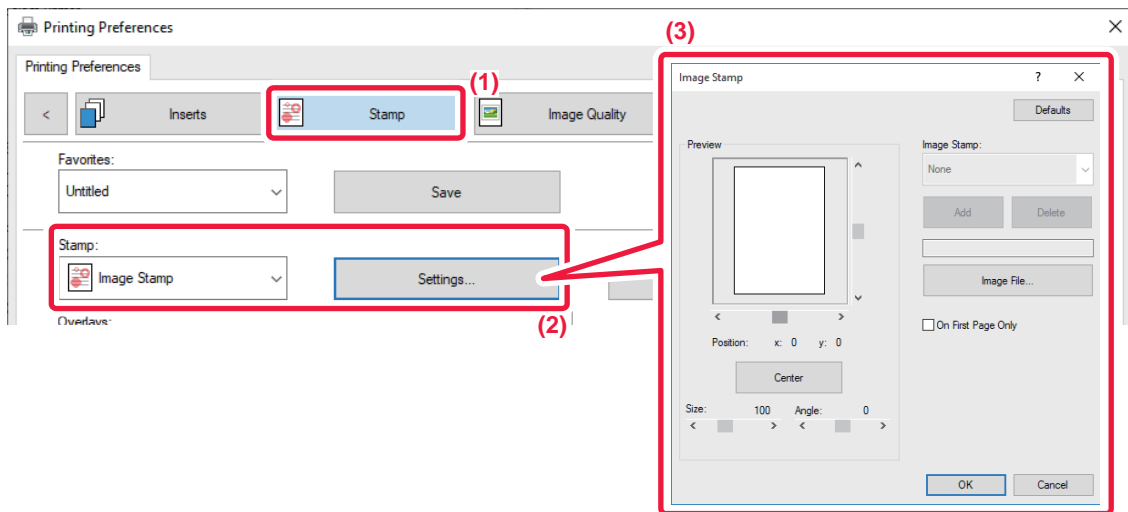

(1) Click the [Stamp] tab.

(2) Select [Image Stamp] from "Stamp" and click the [Settings] button.

(3) Select the image stamp to be used, and click the [OK] button.

- If an image stamp has already been stored, it can be selected from the menu.
- If you have not stored an image stamp, click the [Image File], select the file you wish to use for the image stamp, and click the [Add] button.



# REGISTERING A CUSTOM IMAGE

This function registers images used as custom images from the printer driver to the machine.



- This function is available in a Windows environment.
- This function can be used when the PCL6 printer driver is used.



### To prohibit the registration of custom images:

In "Settings (administrator)", select [System Settings] → [Device Control] → [Common Settings] → [Enable/Disable Settings] → [Disabling Registration of Custom Image] and configure the setting.

## Windows

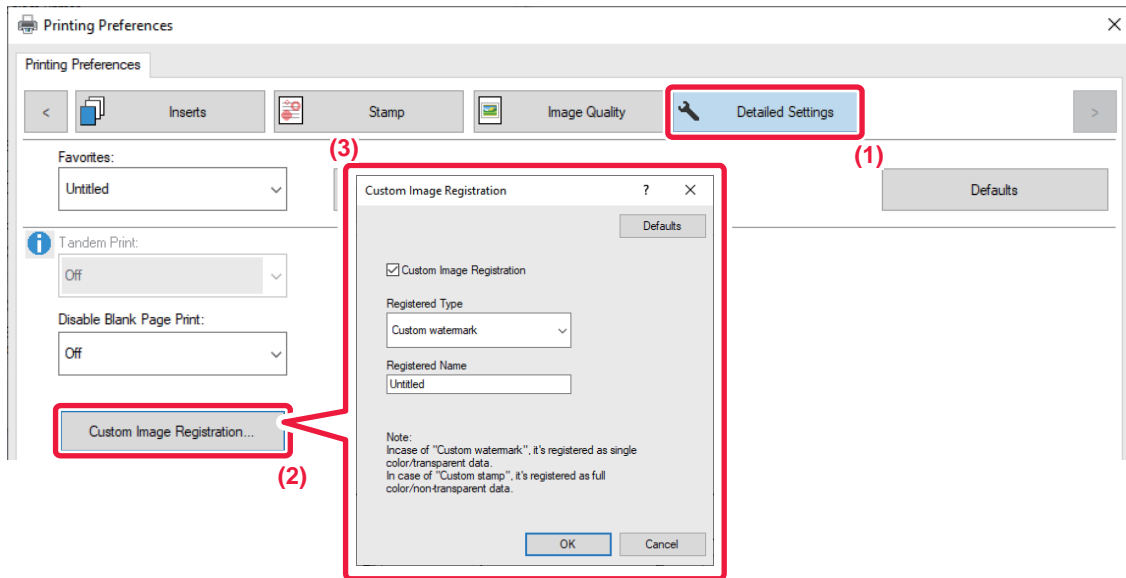

(1) Click the [Detailed Settings] tab.

(2) Click the [Custom Image Registration] button.

(3) Select the registration type and name of the custom image.

When [Custom stamp] is selected in "Registered Type", non-transparent stamp image is registered. When [Custom watermark] is selected, a single-color, transparent watermark image is registered.



If you have attempted to store multiple pages of data, only the first page will be stored.



# OVERLAY A FIXED FORM ON THE PRINT DATA (OVERLAYS)

This function overlays data on a fixed form you have prepared.

By creating table rulings or a decorative frame in an application different from that of the text file and registering the data as an overlay file, an attractive print result can be easily obtained without the need for complex manipulations.

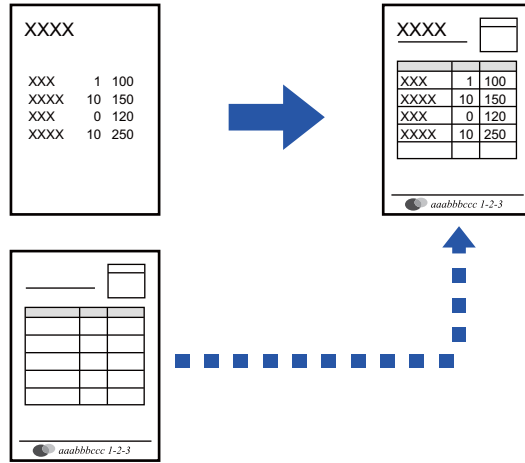

This function is available in a Windows environment.

## Windows

### Creating an overlay file

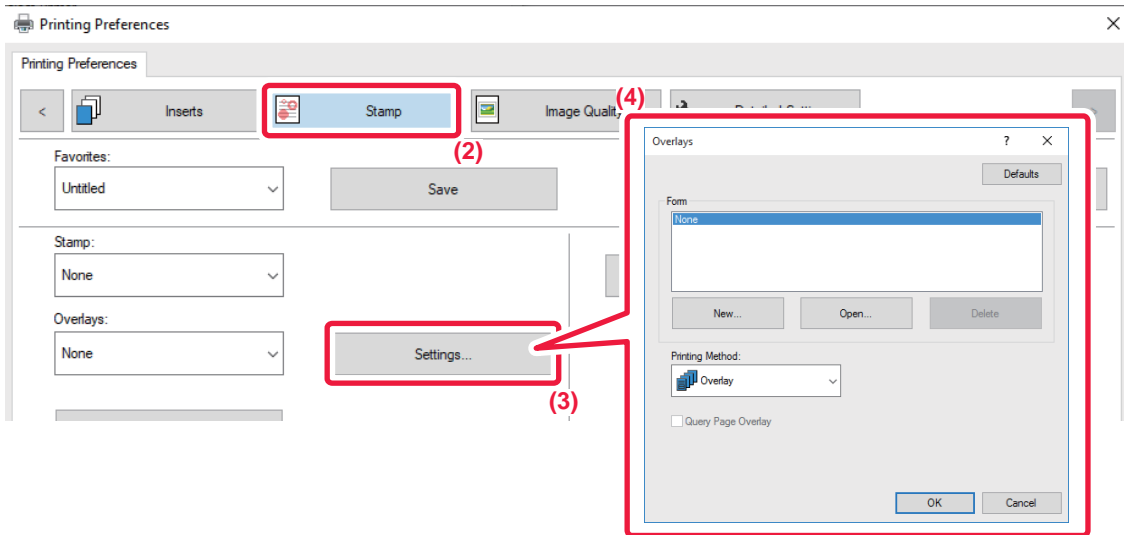

- (1) Open the driver properties window from the application that is used for creating overlay data.
- (2) Click the [Stamp] tab.
- (3) Click the [Settings] button.
- (4) Click the [New] button and specify the name and folder to be used for the overlay file that you wish to create.

The file will be created when the settings are completed and printing is started.





- When printing is started, a confirmation message will appear. The overlay file will not be created until the [Yes] button is clicked.
- When you click the [Open] button, the existing overlay file is registered.

## Printing with an overlay file

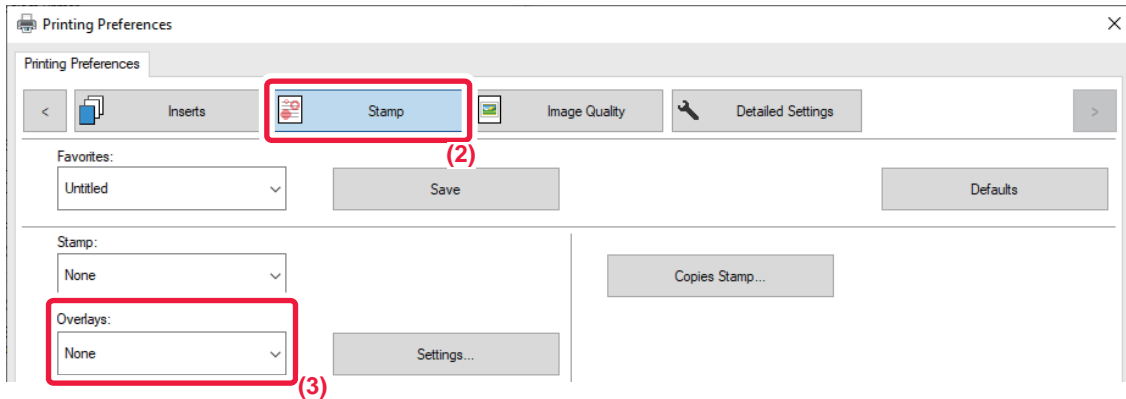

- (1) Open the driver properties window from the application that is used for printing with an overlay file.
- (2) Click the [Stamp] tab.
- (3) Select an overlay file.

A previously created or stored overlay file can be selected from the menu.



# ADDING THE NUMBER OF COPIES (COPIES STAMP)

You can add the number of copies to the header or footer of the print data. You can also set a copies number and print position.



This function is available in a Windows environment.

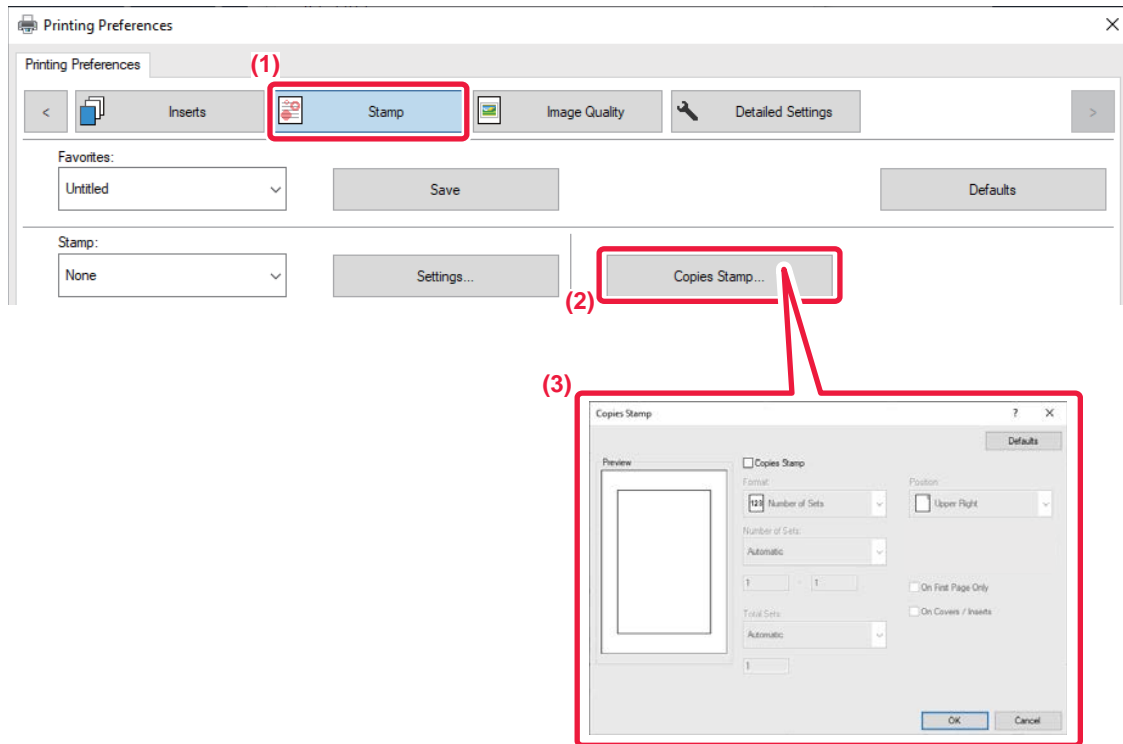

- (1) Click the [Stamp] tab.
- (2) Click the [Copies Stamp] button.
- (3) Select the settings, and click the [OK] button.



# PRINT FUNCTIONS FOR SPECIAL PURPOSES

## PRINTING SPECIFIC PAGES ON DIFFERENT PAPER (DIFFERENT PAPER)

### In a Windows environment

The front and back covers and specified pages of a document are printed on paper that is different from the other pages. Use this function when you wish to print the front and back covers on heavy paper, or insert colored paper or a different paper type at specified pages.

As necessary, paper can be inserted as insertion sheets where nothing is printed.

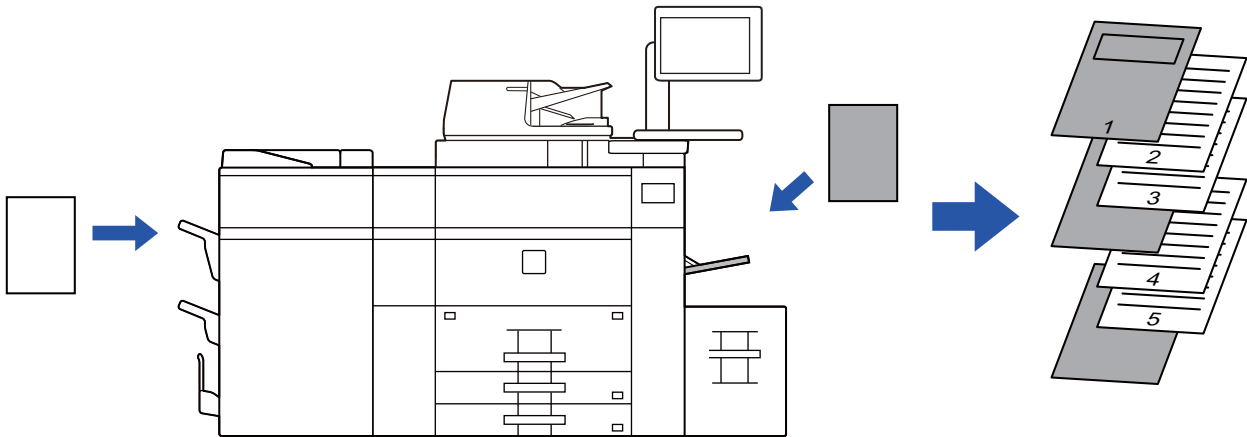

### In a macOS environment

The front and back covers are printed using paper that is different from the other pages. This function can be used, for example, when you want to print only the front cover and last page on thick paper.

### Windows

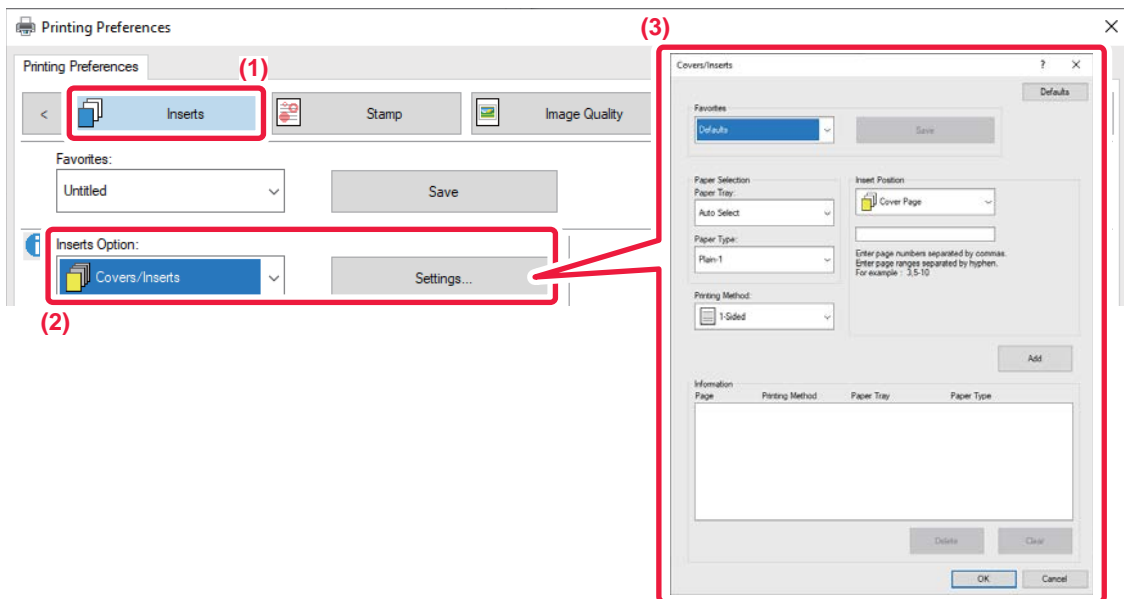

- (1) Click the [Inserts] tab.
- (2) Select [Covers/Inserts] from [Inserts Option], and click the [Settings] button.



**(3) Select the paper insertion settings.**

- Select the insertion position, paper source, and printing method from the corresponding menus.
- Click the [Add] button and your settings will appear in "Information".
- When you have finished selecting settings, click the [Save] button in "Favorites" to save the settings.



- When [Bypass Tray] is selected in "Paper Tray", be sure to select the "Paper Type" and load that type of paper in the bypass tray.
- When [Other Page] is selected for "Insert Position", specify the insert position by directly entering a page number. When "Printing Method" is set to [2-Sided Printing], the specified page and the next page after it will be printed on the front and reverse side of the paper, and thus an insert setting at a page printed on the reverse side will not be effective.

**macOS**

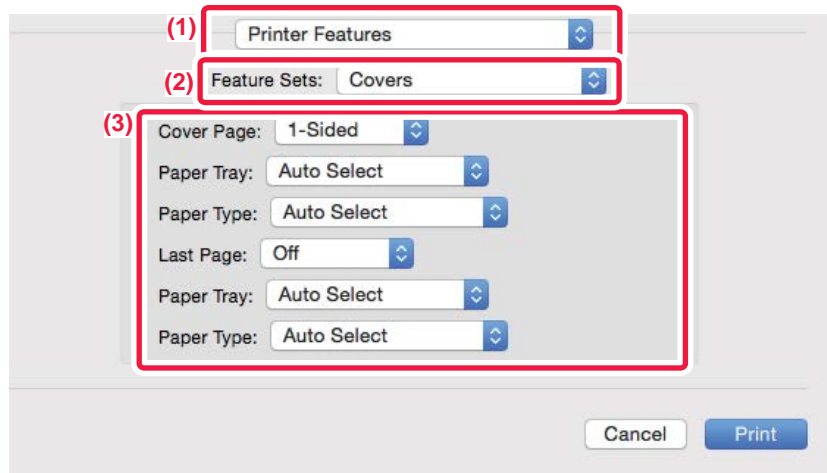

**(1) Select [Printer Features].**

**(2) Select [Covers].**

**(3) Select the cover insertion settings.**

Select the print setting, paper tray, and paper type for the front and back covers.



# ADDING INSERTS WHEN PRINTING ON TRANSPARENCY FILM (TRANSPARENCY INSERTS)

When transparency film is used for printing, this function prevents the sheets of transparency film from sticking together by inserting a sheet of paper between each sheet of film. As necessary, the same content as that printed on each sheet of transparency film is also printed on the corresponding sheet of inserted paper.

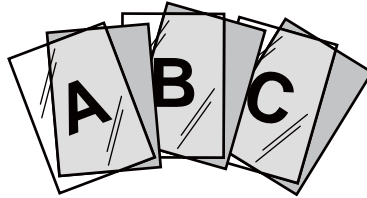

## Windows

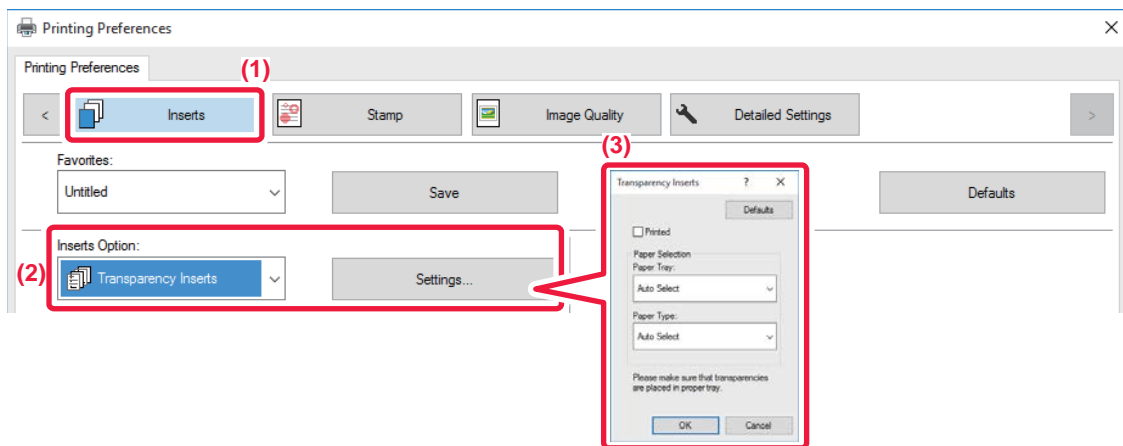

(1) Click the [Inserts] tab.

(2) Select [Transparency Inserts] and click the [Settings] button.

Select the print setting, paper tray, and paper type for the front and back covers.

(3) Select the transparency insert settings.

When the [Printed] checkbox is selected to set to , the same content as that printed on the transparency film is also printed on the insert. Select the paper source and type if needed.



Set the paper type of the bypass tray to [Transparency] and load transparency film into the bypass tray.



## macOS

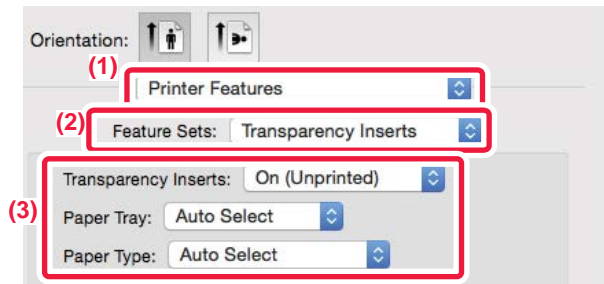

- (1) Select [Printer Features].
- (2) Select [Transparency Inserts] in "Feature Sets".
- (3) Select the transparency insert settings.

When [On (Printed)] is selected from "Transparency Inserts", the same content as that printed on the transparency film is also printed on the insert. Select the paper source and type if needed.



Set the paper type of the bypass tray to [Transparency] and load transparency film into the bypass tray.



# INSERTING SEPARATOR PAGES BETWEEN JOBS OR COPIES

You can insert separator pages between jobs or the specified number of copies.

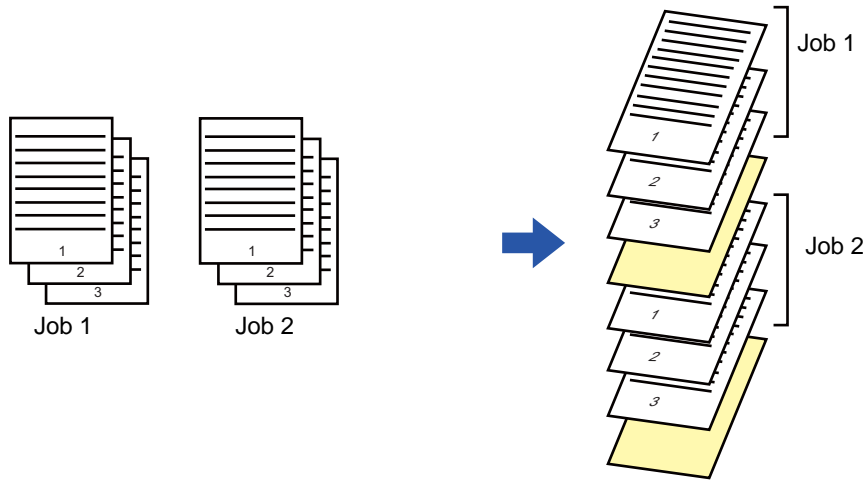

This function is available in a Windows environment.

## Windows

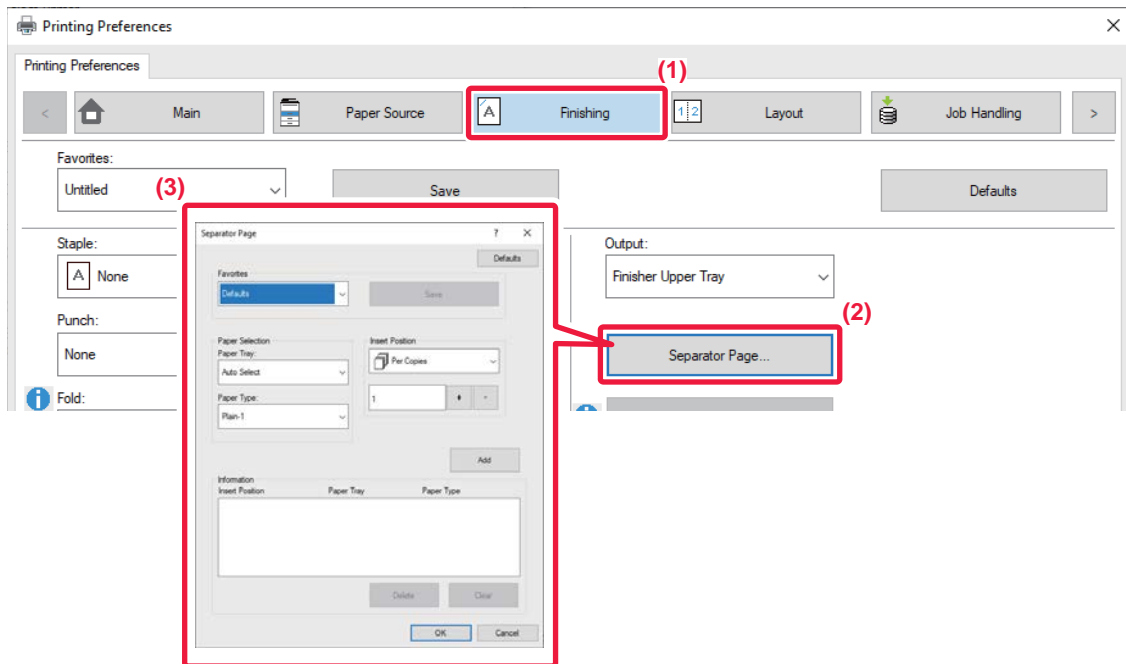

(1) Click the [Finishing] tab.

(2) Click the [Separator Page] button.

(3) Changing the settings

- Select the paper tray and paper type from "Paper Selection", and specify the separator page position in "Insert Position".
- To add a separator page each time printing of the set number of copies is completed, select [Per Copies] in "Insert Position".
- For example, if you are printing 10 copies and you select "5", a separator page will be added after the 5th copy and after the 10th copy.



When the bypass tray is selected, be sure to select the "Paper Type".



## PRINTING A CARBON COPY (CARBON COPY)

This function prints an additional copy of the print image on paper that is of the same size but from a different paper tray. For example, if carbon copy print is selected when plain paper is loaded into tray 1 and colored paper is loaded into tray 2, a print result similar to a carbon copy slip is obtained with a single selection of the print command. If plain paper is loaded into tray 1 and recycled paper is loaded into tray 2 as necessary, selecting Carbon Copy simultaneously prints one copy for presentation and one copy as a duplicate.

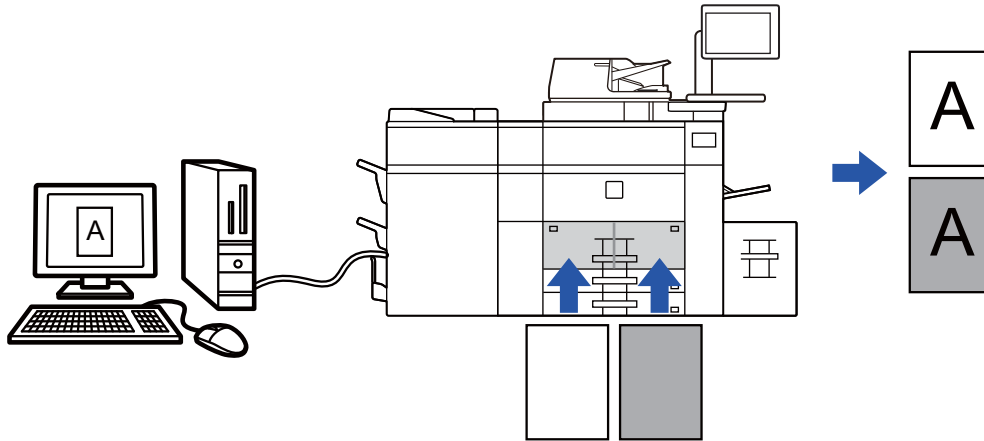

This function is available in a Windows environment.

### Windows

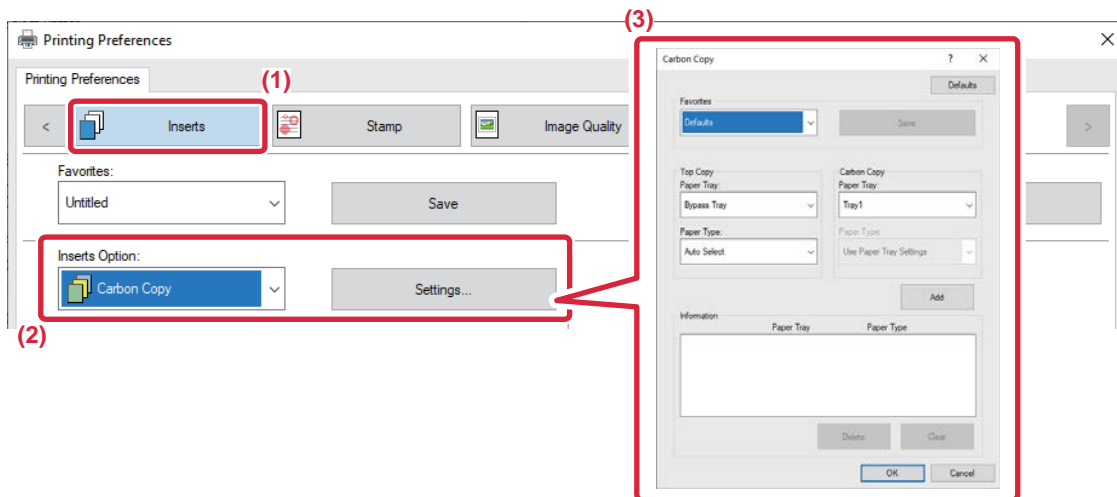

- (1) Click the [Inserts] tab.
- (2) Select [Carbon Copy] from "Inserts Option" and click the [Settings] button.
- (3) Select the tray for the first copy from "Top Copy", and then select the tray for the carbon copy from "Carbon Copy".



When the bypass tray is selected, be sure to select the "Paper Type".





# PRINTING TEXT ON TABS OF TAB PAPER (TAB SHIFT/TAB PAPER PRINT)

There are two methods of printing on the tabs of tab paper: "Tab Shift" and "Tab Paper Print".

## Tab Shift

Create the text to be printed on tab paper in an application, and set the text shifting distance in [Print Position] on the [Layout] tab of the printer driver property window. The text will be printed on the tabs.

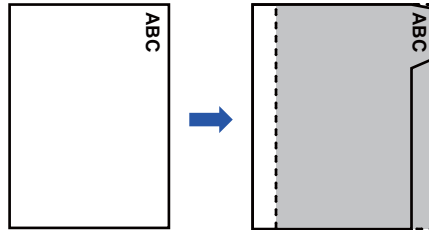

## Tab Paper Print (for PCL6 only)

Tab sheets are printed while they are inserted between the desired pages.

Select [Tab Paper] in [Inserts Option] on the [Inserts] tab of the printer driver properties window, and enter the text that you want to print on the tabs. Specify the detailed settings such as the size of the tabs, the starting position, the distance between tabs, and the page numbers where tab sheets will be inserted.

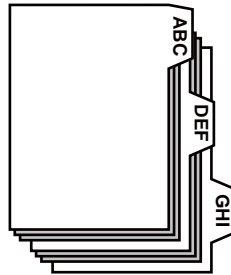

- These functions are available in a Windows environment.
- Tab paper must be loaded into the bypass tray.



## Windows

### Tab Shift

When you have finished preparing the data to be printed on tab papers in an application, take the following steps:

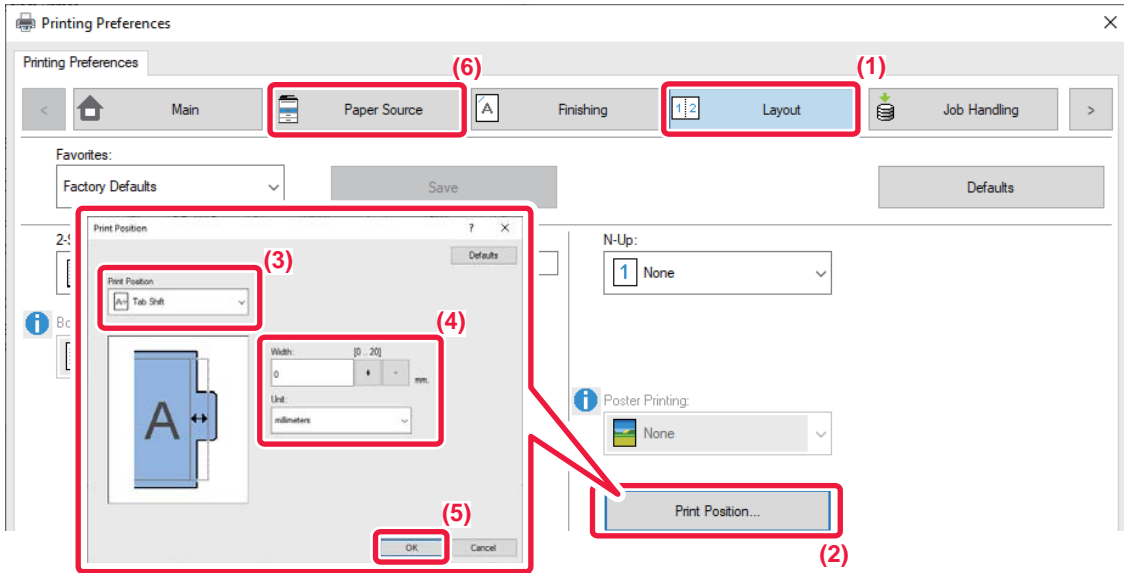

- (1) Click the [Layout] tab.
- (2) Click the [Print Position] button.
- (3) Select [Tab Shift].
- (4) Specify the distance of shifting the image by directly entering a value or by clicking the  button.
- (5) Click the [OK] button.
- (6) Select the paper source and type.  
Click the [Paper Source] tab, and select [Bypass Tray] in "Paper Tray" and [Tab Paper] in "Paper Type".



Set the paper type of the bypass tray to [Tab Paper] and load tab papers into the bypass tray.



## Tab Paper Print (for PCL6 only)

Open the data into which you wish to insert tab paper, and then select the settings.

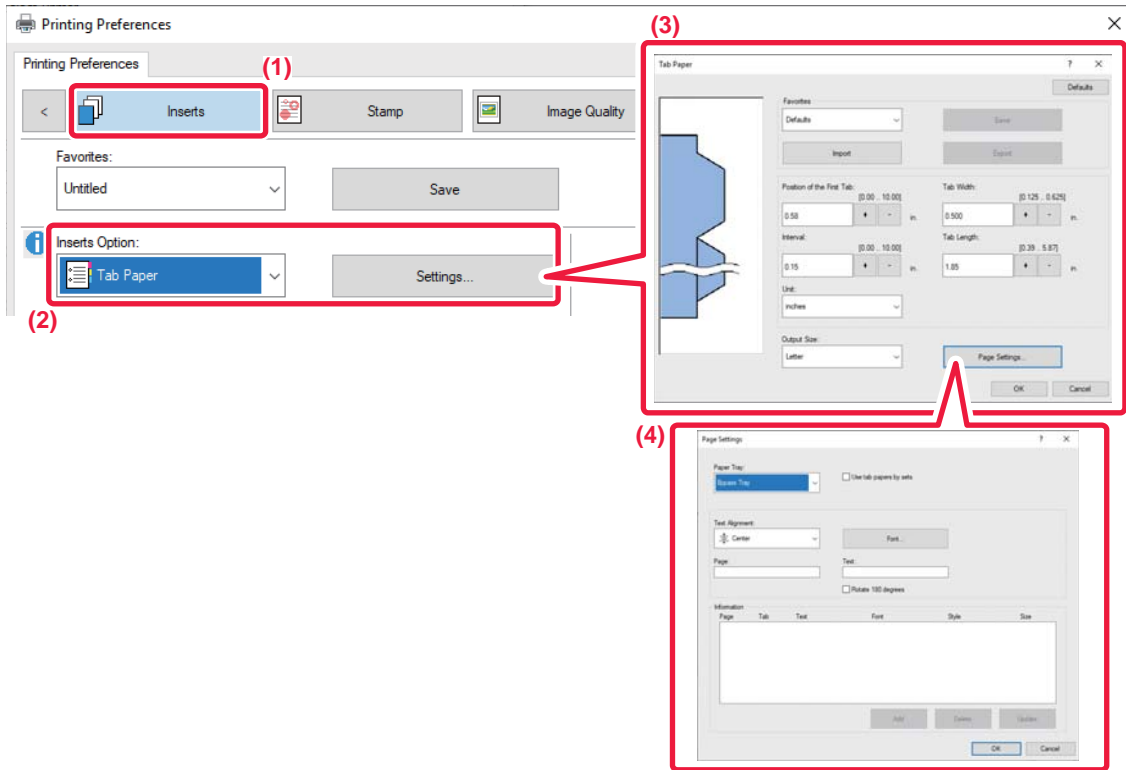

(1) Click the [Inserts] tab.

(2) Select [Tab Paper] from "Inserts Option", and click the [Settings] button.

(3) Select the tab position settings.

For commercially available tab paper, use the existing settings such as [A4-5tab-D] in "Favorites". For other types of tab paper, the position of the first tab, the distance between tabs, and the horizontal and vertical dimensions of the tab can be directly entered or changed using the   button. In addition, select the size of the tab paper from "Output Size".

(4) Select the page settings.

Specify the pages where you wish to insert tab paper and enter the text that you wish to print on the tabs. Also select the font and adjust the layout.



- Set the paper type of the bypass tray to [Tab Paper] and load tab papers into the bypass tray.
- The tab paper settings can be stored and a stored file can be opened from "Favorites".



## TWO-SIDED PRINTING WITH SPECIFIC PAGES PRINTED ON THE FRONT SIDE (CHAPTER INSERTS)

This function prints specific pages on the front side of the paper.

When you specify a page (such as a chapter cover page) to be printed on the front side of the paper, it is printed on the front side of the next sheet even if it would normally be printed on the reverse side of the paper.



Example: When pages 4 and 8 are specified as page settings.  
(Back is blank)



- This function is available in a Windows environment.
- This function can be used when the PCL6 printer driver is used.

### Windows

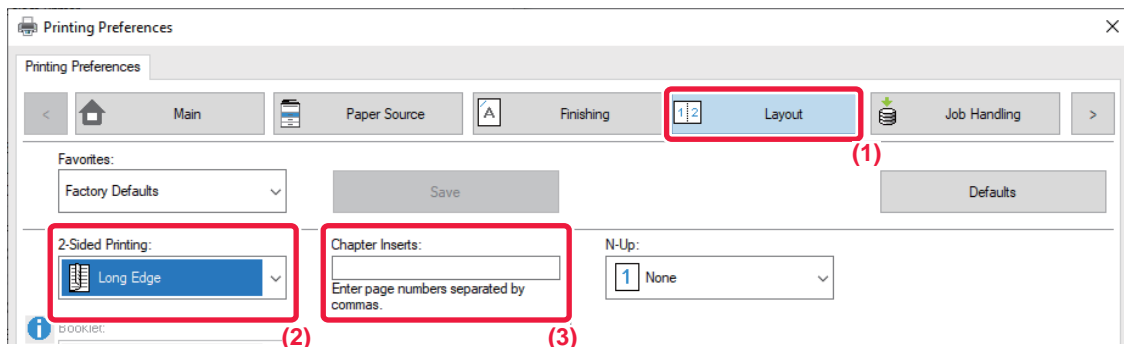

- (1) Click the [Layout] tab.
- (2) Select the 2-Sided Printing.  
For information on the "2-Sided Printing" setting, see ["2-SIDED PRINTING \(page 3-18\)"](#).
- (3) Enter the page numbers of the initial pages of the chapters, separating the numbers with commas.



# FOLDING PAPER FOR PRINTING (FOLD)

If a folding unit is installed, print paper can be folded.

For example, if 8-1/2" x 11" (A4) and 11" x 17" (A3) size print images are mixed, you can fold 11" x 17" (A3) size paper to the 8-1/2" x 11" (A4) size to adjust the width of the actual print paper to the 8-1/2" x 11" (A4) size. When necessary, you can staple folded sheets.



To use the Half Fold and Saddle Fold (Staple) functions, you need to mount a saddle stitch finisher.

## Types of paper folding functions

| Folding types | Print Side | Fold Orientation | Folding results | Description  |
|---------------|------------|------------------|-----------------|--|
| Saddle Fold   | Inside     | -                |                 | Multiple sheets are collectively folded in the center.           |
|               | Outside    | -                |                 |  |
| Half Fold     | Inside     | -                |                 | Paper is folded in the center. Copies are output sheet by sheet. |
|               | Outside    | -                |                 |  |



| Folding types  | Print Side | Fold Orientation | Folding results | Description   |
|----------------|------------|------------------|-----------------|---|
| C-Fold         | Inside     | Open Right       |                 | For example, paper is folded in three so that it can be put into an envelope. Copies are output sheet by sheet. |
|                |            | Open Left        |                 |   |
|                | Outside    | Open Right       |                 |   |
|                |            | Open Left        |                 |   |
| Accordion Fold | -          | Open Right       |                 | For example, paper is folded in three so that it can be put into an envelope. Copies are output sheet by sheet. |
|                | -          | Open Left        |                 |   |



| Folding types | Print Side | Fold Orientation | Folding results | Description   |
|---------------|------------|------------------|-----------------|---|
| Double Fold   | Inside     | Open Right       |                 | For example, paper is folded in four so that it can be put into an envelope. Copies are output sheet by sheet.  |
|               |            | Open Left        |                 |   |
|               | Outside    | Open Right       |                 |   |
|               |            | Open Left        |                 |   |
| Z-Fold        | -          | Open Right       |                 | For example, if 8-1/2" x 11" (A4) and 11" x 17" (A3) size print images are mixed, only the 11" x 17" (A3) size paper is folded and changed to 8-1/2" x 11" (A4) size paper. Copies are output sheet by sheet. |
|               | -          | Open Left        |                 |   |



This function cannot be used when [Common Settings] in "Settings (administrator)" → [Device Control] → [Disabling of Duplex] is selected.



- When printing data in a pamphlet layout, the "Booklet" function can be used to conveniently fold and staple printed output to create a pamphlet. See "[CREATE A PAMPHLET \(BOOKLET/SADDLE STITCH\) \(page 3-26\)](#)".
- The Fold function cannot be used together with the Punch and Staple functions. However, the Z-Fold function can be used together with the punch and staple functions when one of the following paper size is specified.
- Ledger (11" × 17"), B4, A3
- When a saddle stitch finisher (large stacker) is mounted, the Saddle Fold function folds five sheets every set. For example, if an original has 12 A4 size plain sheets, they are folded three times in total: 5 sheets + 5 sheets + 2 sheets. However, some types of paper reduces the number of sheets that are folded every set. For example, heavy paper is folded on a three-sheet basis.
- When a saddle stitch finisher (large stacker) is installed, depending on the state of the paper type or printing setting, the saddle fold function in printing may not be used.

## Windows

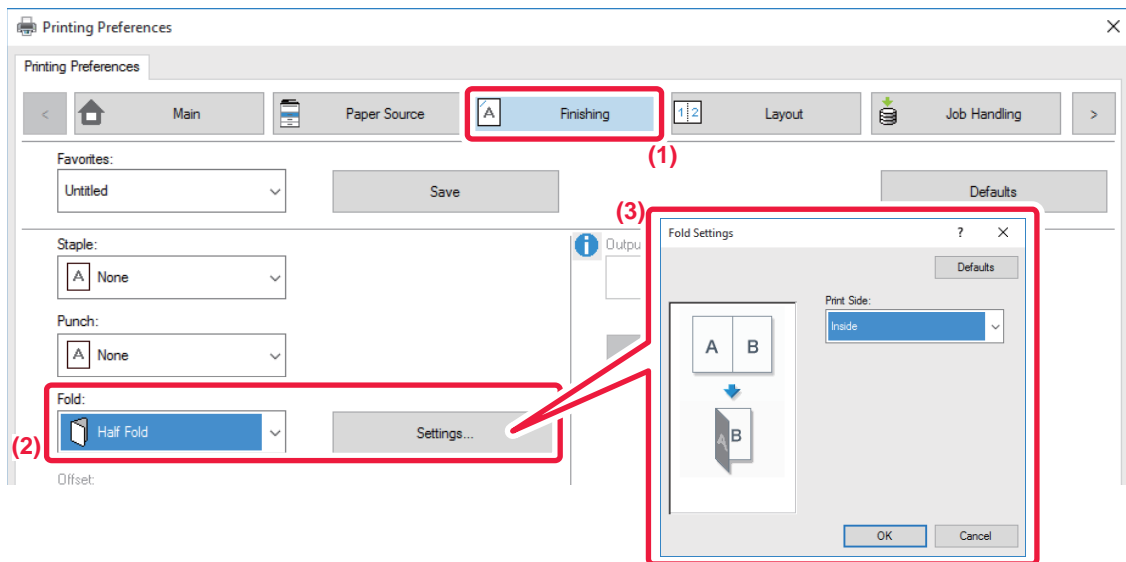

- (1) Click the [Finishing] tab.
- (2) Select the folding method in "Fold", and click the [Settings] button.
- (3) Select the desired folding method.



If you select "Z-Fold", set the checkbox of the paper size for paper folding to .





## macOS

### Folding

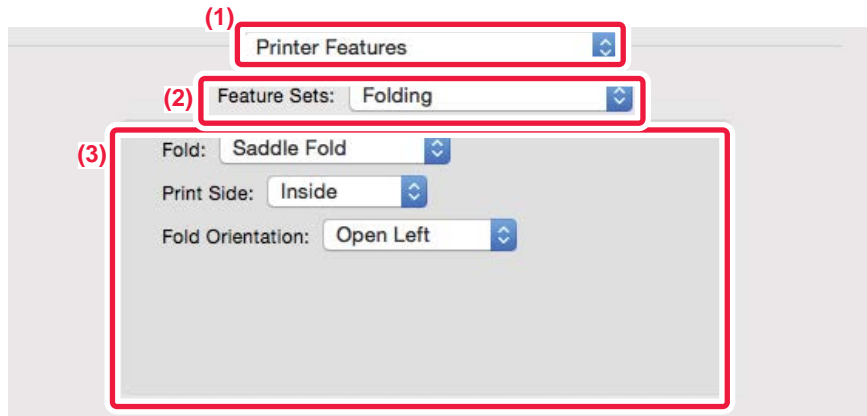

- (1) Select [Printer Features].
- (2) Select [Folding].
- (3) Select the desired folding method.

### Folding(Z-Fold)

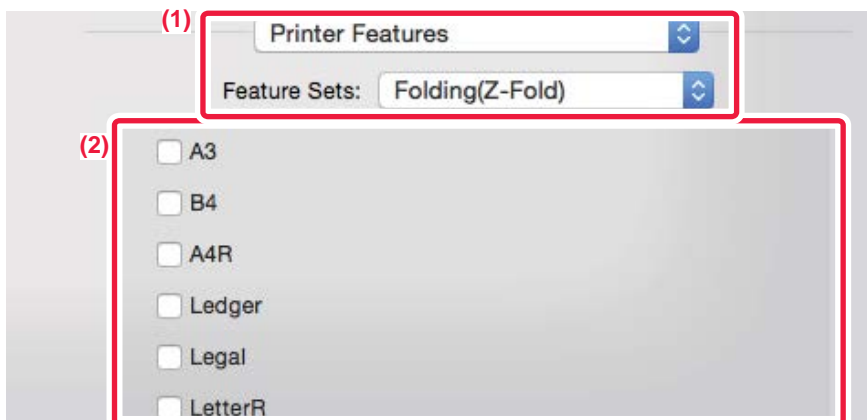

- (1) Select [Printer Features], then select [Folding(Z-Fold)].
- (2) Select a paper size.



# INSERT PRESET DATA BEFORE OR AFTER EACH PAGE (PAGE INTERLEAVE)

This function inserts a preset data item into every page during printing.

You can easily create documents with opened page spread that is made up of text on the left-hand page and a memo space on the right-hand page.

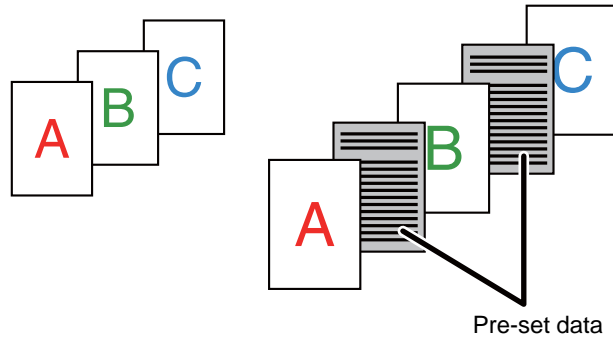

- This function is available in a Windows environment.
- This function can be used when the PCL6 printer driver is used.

## Windows



You have to create page data to be inserted in advance.

For the procedure for creating page data, see "[Creating an overlay file \(page 3-48\)](#)" in "[OVERLAY A FIXED FORM ON THE PRINT DATA \(OVERLAYS\) \(page 3-48\)](#)".

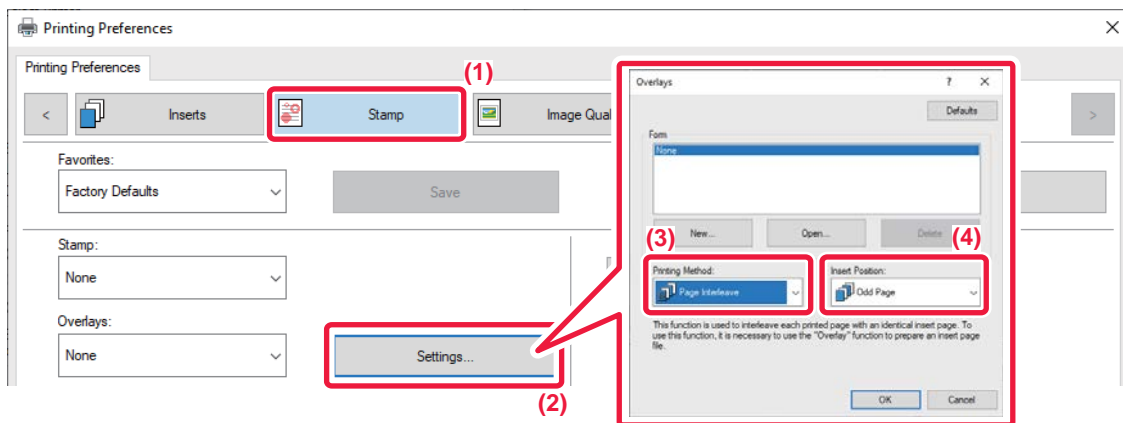

- (1) Click the [Stamp] tab.
- (2) Click the [Settings] button.
- (3) Select [Page Interleave] from the "Printing Method".
- (4) Set the overlay data to be inserted and set its insertion position.



# PRINT THE SAME IMAGE IN TILE PATTERN (REPEAT PRINT)

This function prints the same image in tile pattern on a sheet. This is useful for producing name cards and stickers.

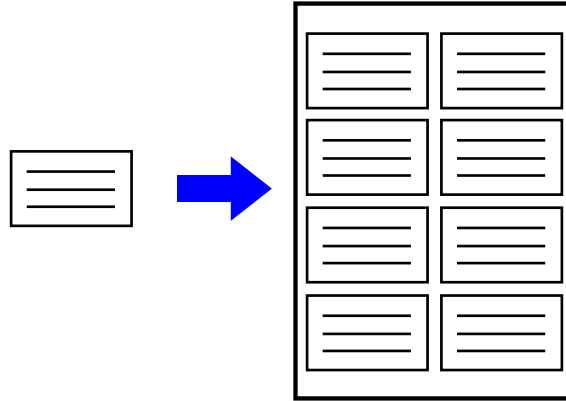

- This function is available in a Windows environment.
- This function can be used when the PCL6 printer driver is used.

## Windows

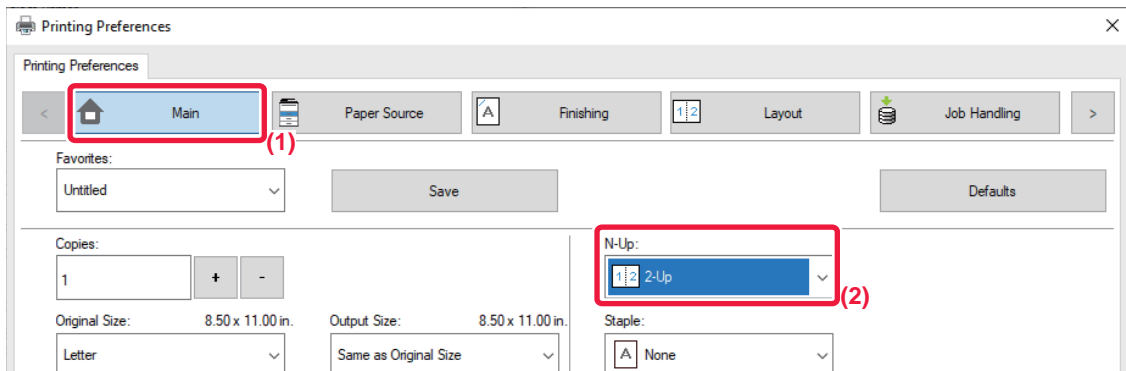

- (1) Click the [Main] tab.
- (2) Select the repeat count in "N-Up".



# PRINTING PATTERN DATA (HIDDEN PATTERN PRINT)

This function prints pattern data such as "DO NOT COPY" behind the print data.

If paper with pattern data is duplicated, the pattern data emerges in the background, which will help to prevent information from being leaked through unauthorized document copying.

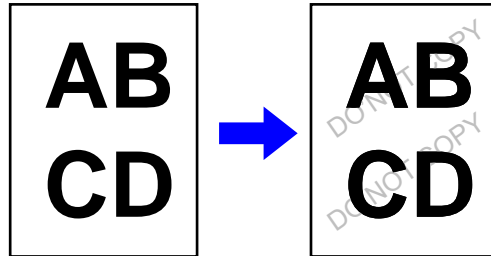

- This function is available in a Windows environment.
- This function can be used when the PCL6 printer driver is used.

## Windows

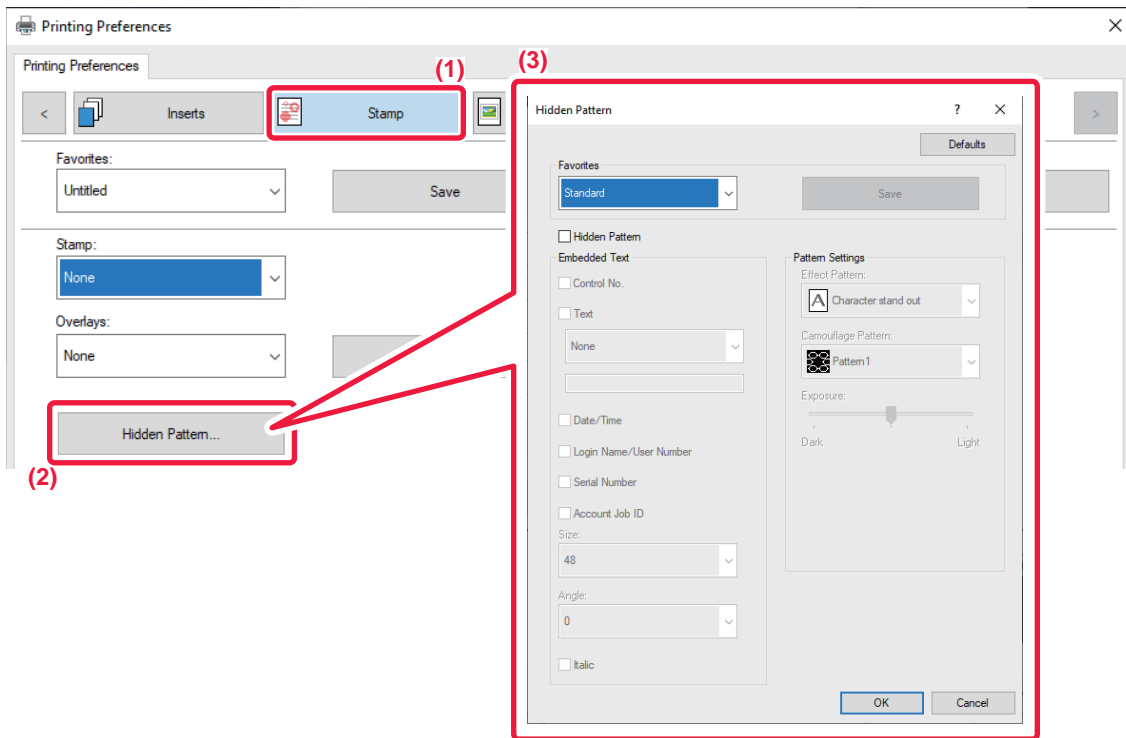

- (1) Click the [Stamp] tab.
- (2) Click the [Hidden Pattern] button.
- (3) Configure the settings for hidden pattern printing and click the [OK] button.



The hidden pattern printing function cannot be used when "Print Mode" is set to [1200 dpi].



- 
- "Hidden Pattern" is a function provided for the purpose of deterring unauthorized printing. It does not guarantee the prevention of information leakage.
  - Text may not be completely hidden on an output sheet with a pattern print under certain machine conditions. In "Settings (administrator)", select [Security Settings] → [Hidden Pattern Print Setting] → [Contrast] if this is the case.
  - The hidden pattern may not emerge on copies with certain types of devices or under certain setting conditions used to copy an output sheet with a pattern print.
-



# CHANGING THE RENDERING METHOD AND PRINTING JPEG IMAGES (USE DRIVER TO RENDER JPEGS)

In some situations, a document containing a JPEG image may not be printed correctly. This can be solved by changing the way the JPEG image is rendered.

When you print an original containing JPEG images, this function allows you to select whether the images are rendered in the printer driver or the machine.



- This function is available in a Windows environment.
- When images are rendered in the printer driver, it may take time until the printing is completed.

## Windows

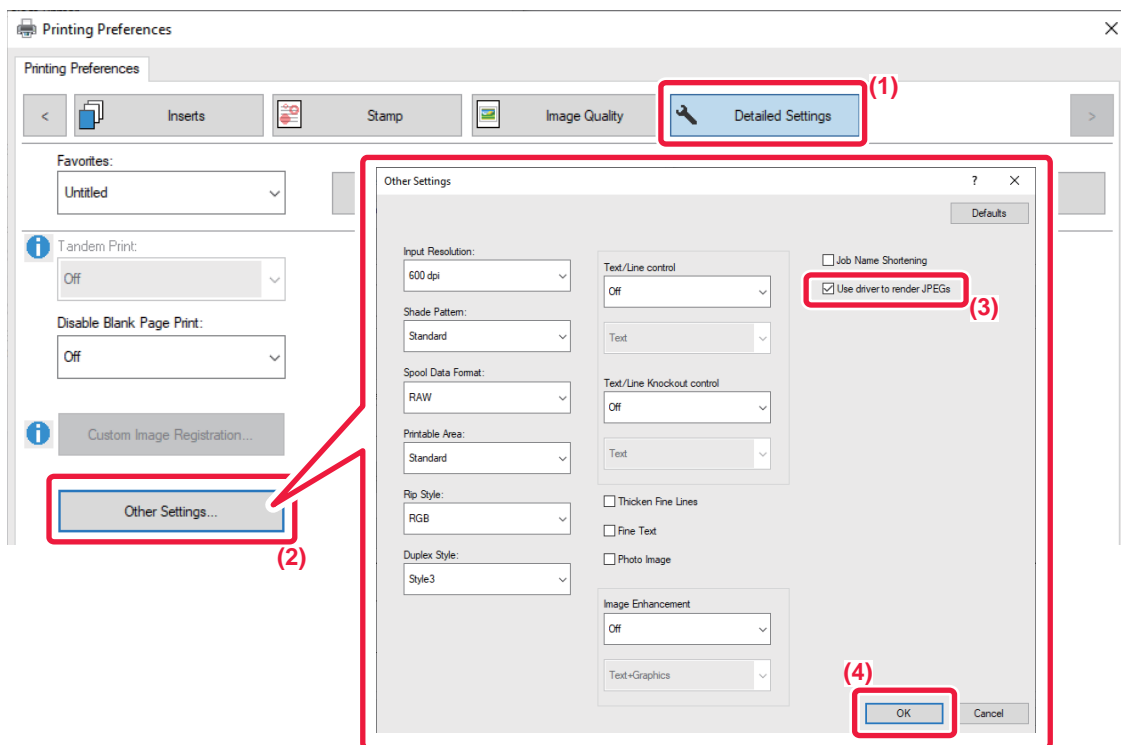

- (1) Click the [Detailed Settings] tab.
- (2) Click the [Other Settings] button.
- (3) Click the [Use driver to render JPEGs] checkbox so that  appears.
- (4) Click the [OK] button.



# MAXIMIZING THE PRINT AREA ON THE PAPER (PRINT AREA)

By maximizing the print area, you can print on the full paper size.



This function is available in a Windows environment.



Even when the print area is maximized, edges may be cut off.

## Windows

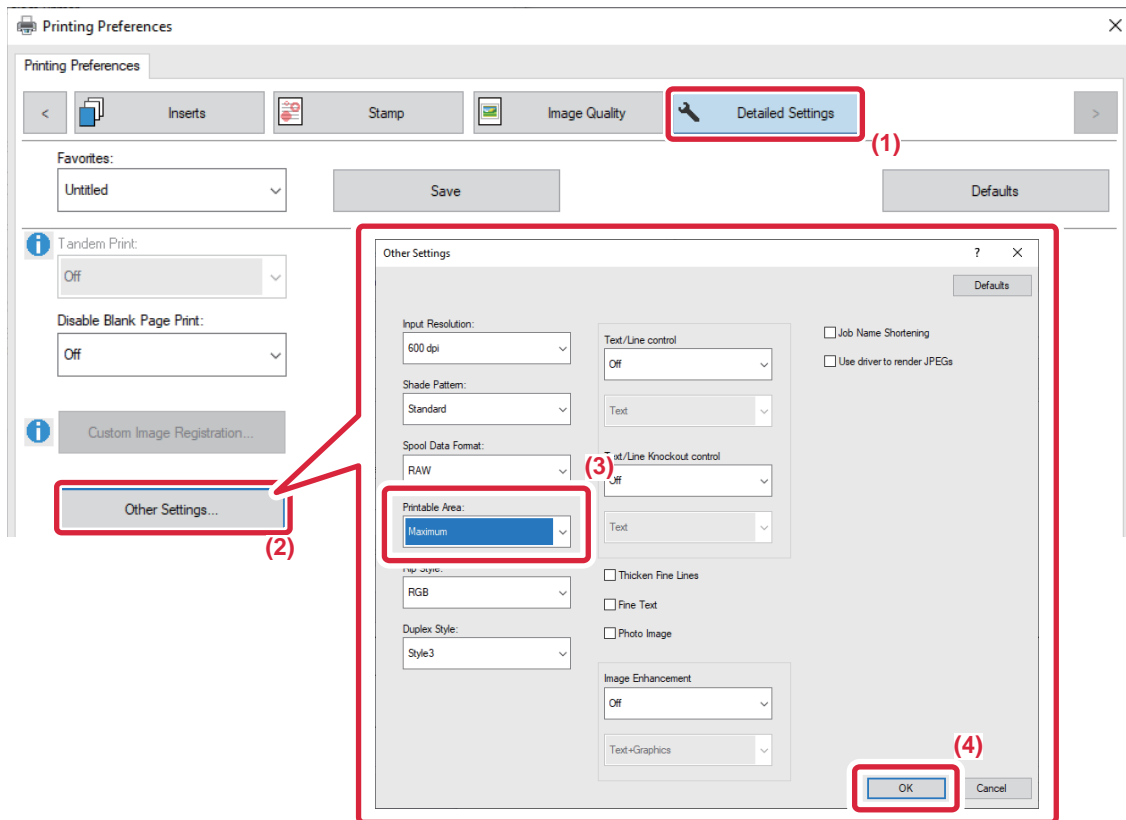

- (1) Click the [Detailed Settings] tab.
- (2) Click the [Other Settings] button.
- (3) Select [Maximum] from the "Printable Area".
- (4) Click the [OK] button.



# CONVENIENT PRINTER FUNCTIONS

## USING TWO MACHINES TO PRINT A LARGE PRINT JOB (TANDEM PRINT)

To use this function, two machines that can perform tandem printing are required.

Two machines connected to the same network are used to run a large print job in parallel. This function reduces the printing time when you handle a large number of prints.

Example: Printing four sets of copies

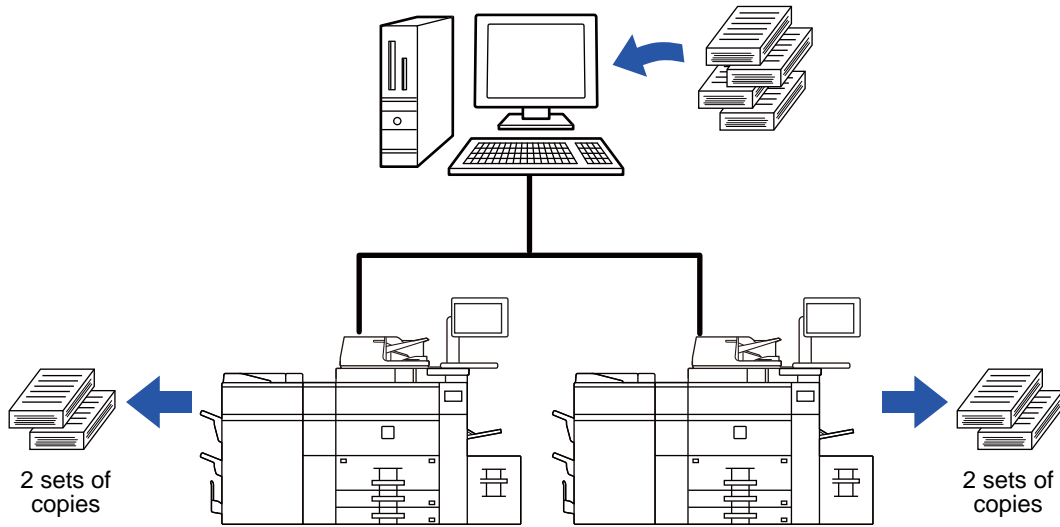

To use the tandem print function, the IP address of the client machine must be registered in the printer driver.

- In a Windows environment, this is accomplished automatically by clicking the [Auto Configuration] button on the [Configuration] tab of the printer driver.
- In macOS 10.9, enter the IP address of the client machine.



This function cannot be used in macOS 10.10 or later.





## Windows

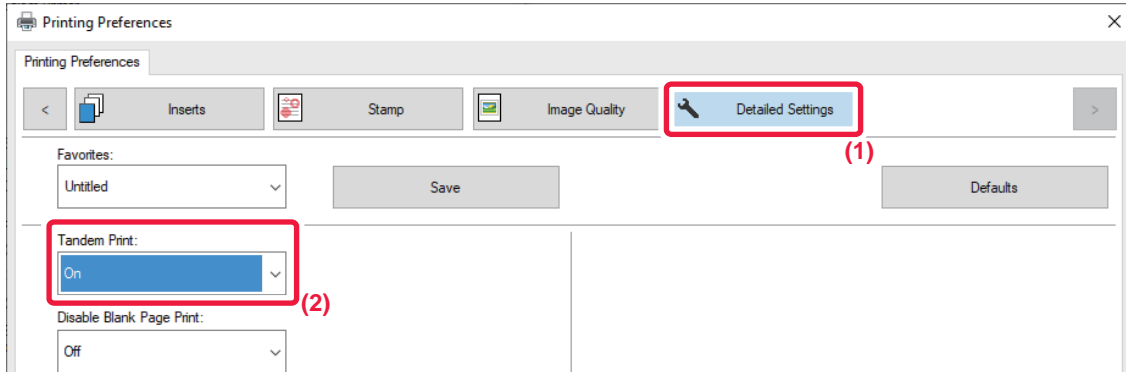

- (1) Click the [Detailed Settings] tab.
- (2) Select [On] in "Tandem Print".



The tandem print function can be used only when the printer driver has been installed using "Custom Installation" with [LPR Direct Print (Specify Address/Auto Search)] selected and with the [Yes] checkbox selected for "Do you want to use Tandem Print function→".

## macOS

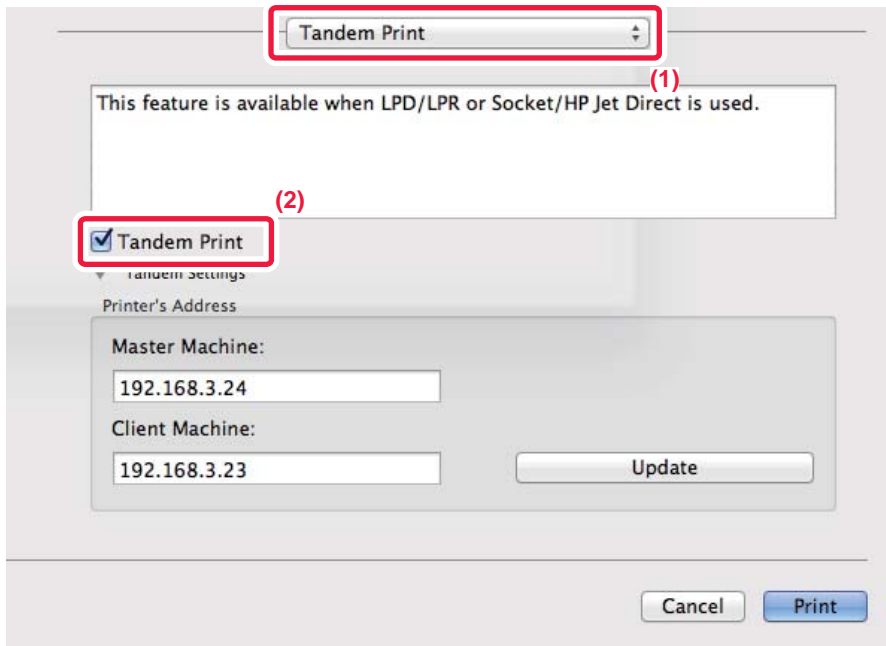

- (1) Select [Tandem Print].
- (2) Click the [Tandem Print] checkbox so that  appears.



To use the tandem print function, you must select the protocol to be used as instructed in the message that appears when you add the printer driver in the "Printer Setup Utility".



# PRINTING AN ORIGINAL IN REVERSE PAGE ORDER (REVERSE ORDER)

In normal print operations, printed sheets are output in top-to-bottom order with the printed side facing down, producing a set of copies stacked in the same order as the original. The Reverse Order function outputs printed sheets in top-to-bottom order with the printed side facing up, resulting in a set of prints stacked in the opposite order to the original.

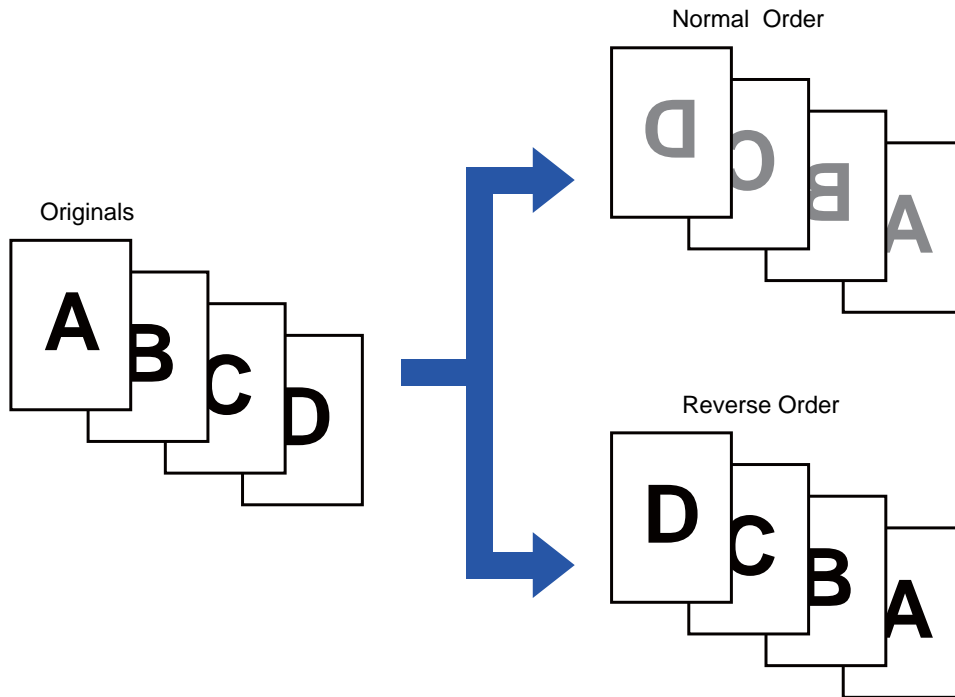

## Windows

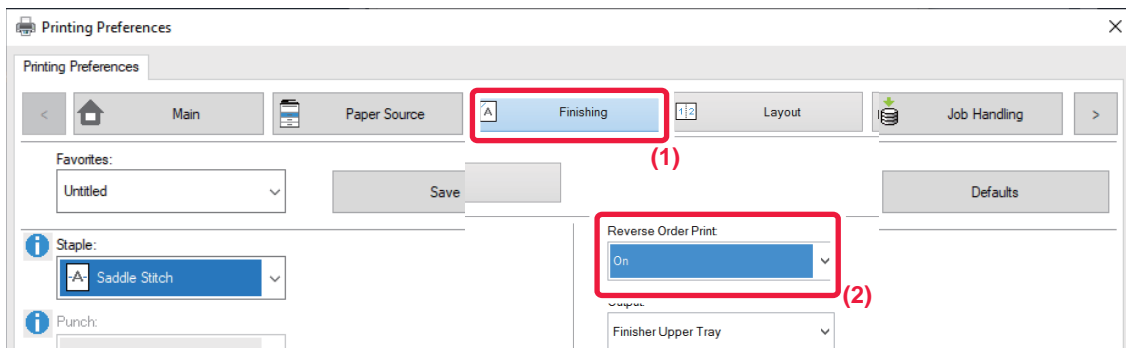

- (1) Click the [Finishing] tab.
- (2) Select [On] in "Reverse Order Print".



## Mac OS

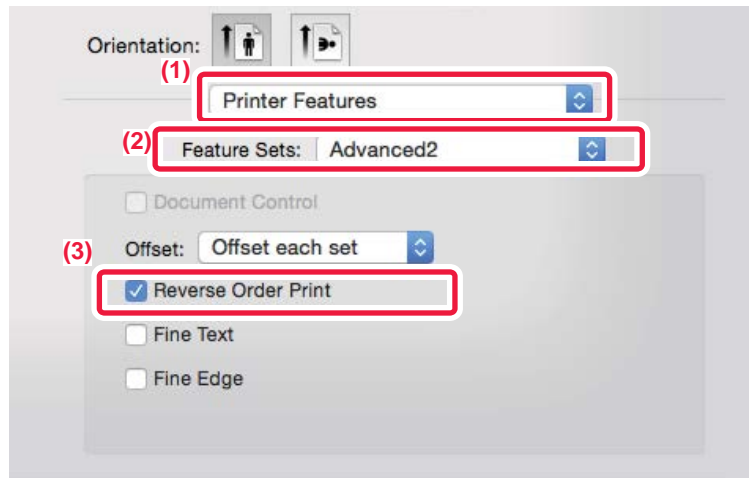

- (1) Select [Printer Features].
- (2) Select [Advanced2].
- (3) Click the [Reverse Order Print] checkbox so that  appears.



# SAVING AND USING PRINT FILES (DOCUMENT FILING)

This function stores a print job as a file on the machine's local drive, allowing the job to be printed from the touch panel when needed. The location for storing a file can be selected to prevent the file from being mixed together with files of other users.

• **Hold Only**

This setting is used to hold a print job on the machine's local drive without printing it.

• **Hold After Print**

This setting is used to hold a print job on the machine's local drive after it is printed.

• **Sample Print**

When a print job is sent to the machine, only the first set of copies is printed. After checking the contents of the first set of copies, you can print the remaining sets from the operation panel of the machine. This prevents the occurrence of excessive misprints.

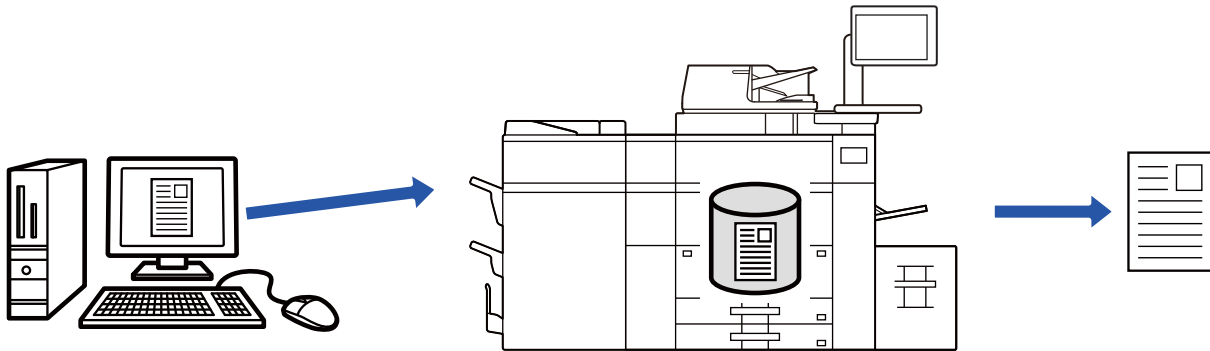

- For the procedure for printing files stored on the machine's local drive, see "[FILE PRINTING \(page 5-25\)](#)" in "Document Filing".
- When printing from a PC, you can set a password (4 to 8 digits) to maintain the confidentiality of information in a stored file. When a password is set, the password must be entered to print data.
- [Document Filing] that can be set on the [Job Handling] tab can also be set on the [Main] tab.

## Windows

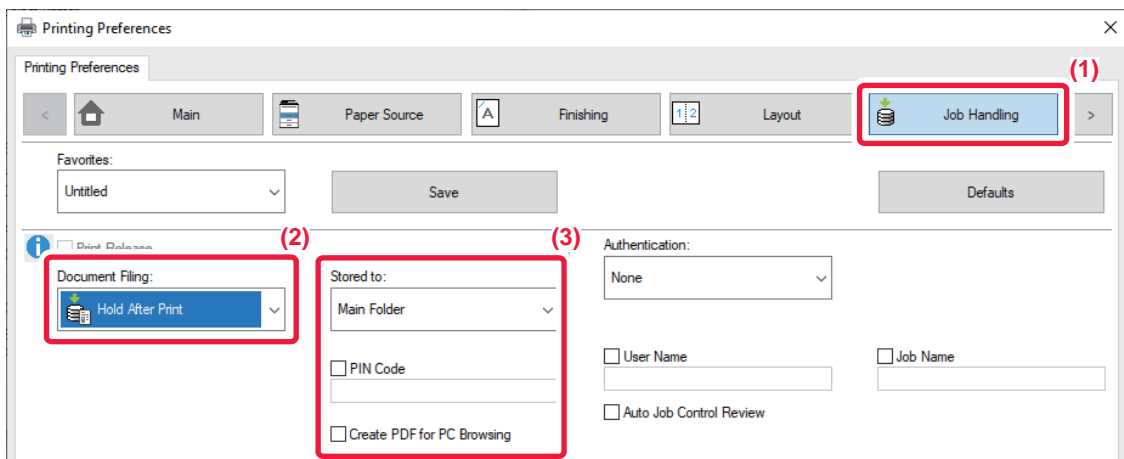

- (1) Click the [Job Handling] tab.
- (2) Select the function from the "Document Filing".
- (3) Select the folder for storing the file in "Stored to".

To enter a password (4 to 8 digit number), click the [PIN Code] checkbox so that the checkmark  appears.  
 To create a public PDF for PC browsing, select the [Create PDF for PC Browsing] checkbox (.



- When [Quick File] is selected, "Document Filing" will be set to [Hold After Print].
- When [Quick File] is selected, the password entered in "Document Filing" is cleared.
- If necessary, you can select the data format from CMYK and RGB for data to be stored in the machine. Click the [Other Settings] button on the [Detailed Settings] tab and select the format from "Rip Style".
- To store a file in a custom folder, you must first create the custom folder using [Document Operations] in "Settings (administrator)" → [Document Filing]. If you have set a password for the custom folder, enter the password (5 to 8 digit number) in "PIN Code" on the stored to screen.



If you have configured to always use the force document filing function in "Printing Policy" on the [Configuration] tab, you cannot clear the [Document Filing] checkbox.



## macOS

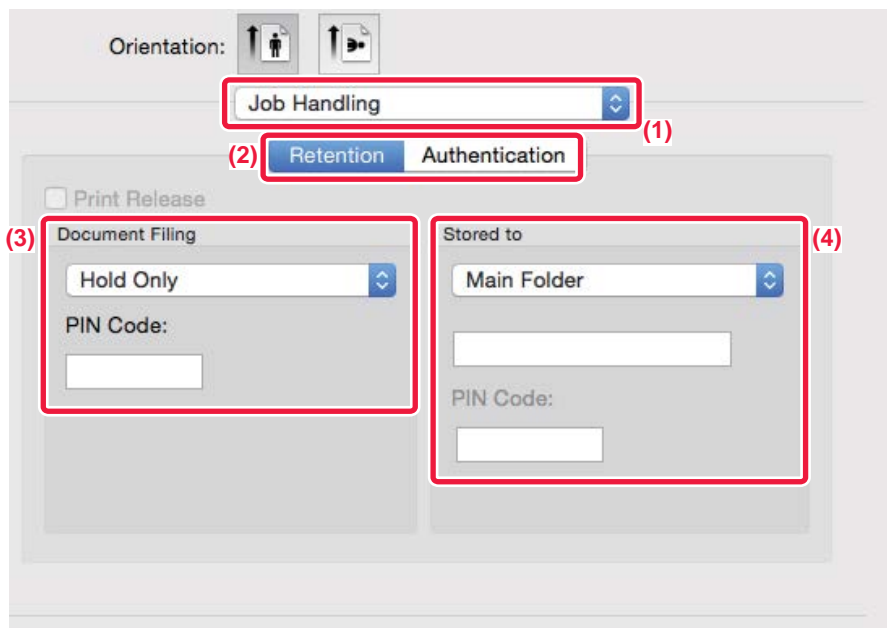

(1) Select [Job Handling].

(2) Select [Retention].

(3) Select how to save the print data in "Document Filing".

After you have entered a password (4 to 8-digit number), click the  button to lock the password. This allows you to readily set the same password the next time you use it.

(4) Select the folder to store the file in "Stored To".

If you selected [Custom Folder], enter the name of the custom folder where you want to save the file.



- When [Quick File] is selected, "Document Filing" will be set to [Hold After Print].
- When [Quick File] is selected, the password entered in "Document Filing" is cleared.
- If necessary, you can select the data format from CMYK and RGB for data to be stored in the machine. Select [Advanced1] in [Printer Features] and select the format from "Rip Style".
- To store a file in a custom folder, you must first create the custom folder using [Document Operations] in "Settings (administrator)" → [Document Filing]. If you have set a password for the custom folder, enter the password (5 to 8 digit number) in "PIN Code" on the folder selection screen.



## AUTOMATICALLY PRINT ALL STORED DATA

When user authentication is enabled on the machine, all document filing (stored) print jobs of the user who logs in are automatically printed. After all jobs are printed, the stored jobs are deleted.



To use the Print All function, the following steps are necessary:

- In "Settings (administrator)", select [System Settings] → [Authentication Settings] → [Default Settings] and enable [Automatically print stored jobs after login].
- When executing document filing print, in addition to the user authentication information, enter the user name stored in the machine in "User Name" of "Default Job ID" in the printer driver.
  - ▶ Using this function in a Windows environment: [PRINTING IN A WINDOWS ENVIRONMENT \(page 3-4\)](#)
  - ▶ Using this function in a macOS environment: [PRINTING IN A macOS ENVIRONMENT \(page 3-13\)](#)



Files with a password and files that are protected by the document filing function of the machine will not be printed. Files in a folder (excluding My Folder) that has a password will also not be printed.

### (1) Select [Job Handling].

At the time of document filing print, in addition to the user authentication information, enter the user name stored in the machine in "User Name" in the printer driver.

### (2) A confirmation prompt will appear. Tap the [OK] key.

The print files stored in the quick file folder, main folder, and custom folder will be printed automatically and then deleted.



# PRINTING AND SENDING SIMULTANEOUSLY

This function prints data created in an application from the machine and simultaneously sends the data to the addresses stored in the machine. This function allows you to complete two tasks, printing and sending, with one operation from the printer driver.



- Addresses must be stored in advance in the machine. For more information, see "User's Manual (Address Book Registration)".
- You must complete the preparatory steps for using each sending function of the machine. For more information, see the explanation of each sending function.



- This function is available in a Windows environment.
- This function can be used when the PCL6 printer driver is used.



You cannot print and send data simultaneously when [System Settings] in "Settings (administrator)" → [Printer Settings] → [Condition Settings] → [Disabling sending while printing] is selected.

## Windows

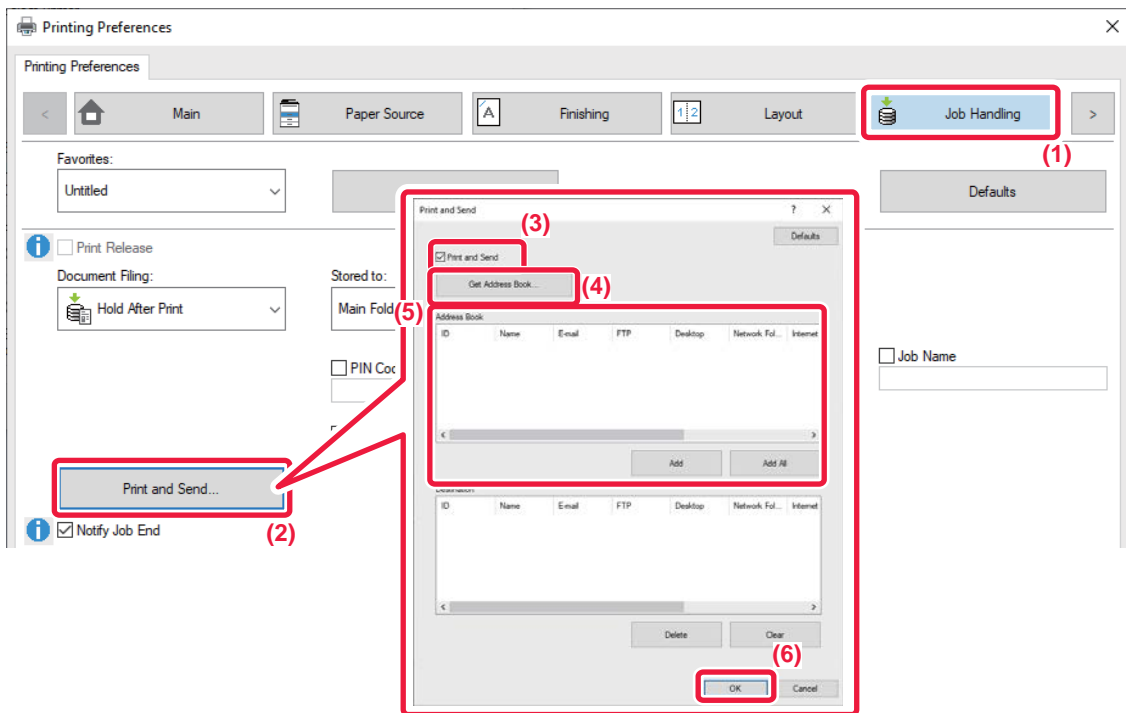

- (1) Click the [Job Handling] tab.
- (2) Click the [Print and Send] button.
- (3) Select the [Print and Send] checkbox so that  appears.
- (4) Click the [Get Address Book] button.
- (5) From the "Address Book" list, select the address to which you wish to send the data, and click the [Add] button to add the address to the "Destination" list.
  - If you wish to send the data to all addresses, click the [Add All] button.
  - To delete an address from the "Destination" list, select the address and click the [Delete] button. If you wish to delete all addresses, click the [Delete All] button.



Up to 50 destinations can be specified.

- (6) Click the [OK] button.

The printer driver settings are applied to sending settings.





# PRINTING WITHOUT THE PRINTER DRIVER

## EXTENSION OF PRINTABLE FILES

When you do not have the printer driver installed on your PC, or when the application used to open a file that you wish to print is not available, you can print directly to the machine without using the printer driver.

The file types (and corresponding extensions) that can be printed directly are shown below.

|           |           |                         |     |                      |         |   |                        |
|-----------|-----------|-------------------------|-----|----------------------|---------|---|------------------------|
| File Type | TIFF      | JPEG                    | PNG | PCL                  | PS      | PDF,<br>Encrypt PDF,<br>Compact PDF,<br>PDF/A,<br>Compact PDF/A | DOCX,<br>XLSX,<br>PPTX |
| Extension | tiff, tif | jpeg, jpg,<br>jpe, jfif | png | pcl,<br>prn,<br>txt* | ps, prn | pdf   | docx, xlsx,<br>pptx    |

\* Not available for E-mail Print.



Some files may not print correctly even if shown in the above table.

## DIRECTLY PRINTING A FILE ON AN FTP SERVER

When an FTP server is configured, you can directly select and print files on the FTP server from the touch panel of the machine. This function eliminates the need for downloading the files from the FTP server to your PC and sending print jobs from the PC to the machine.



To configure an FTP server:

In "Settings (administrator)", select [System Settings] → [Printer Settings] → [Direct Print Settings (FTP)]. (Administrator rights are required.) Up to 20 FTP servers can be configured.



When you select a PDF file that has a password, you must enter the password in the job management screen to begin printing.

▶ [PRINTING AN ENCRYPTED PDF FILE \(page 3-90\)](#)

1

Tap the [File Retrieve] key.



2

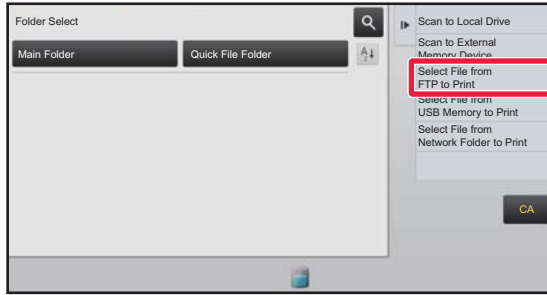

Tap the [Select File from FTP to Print] key on the action panel.



3

### Tap the key of the FTP server that you wish to access.



When a server is selected, entry of a user name and password may be necessary. Enter your user name and password, and tap the [Enter] key.

4

### Tap the key of the file that you wish to print, and tap the [Choose Print Settings] key on the action panel.

- When printing multiple files, tap the keys of the files you wish to print, and tap the [Print] key on the action panel.
- The  icon appears to the left of keys of files that can be printed.
- The  icon is displayed to the left of keys of folders on the FTP server. To display a folder or a file in a folder, tap this key.



- A total of 100 keys of files and folders can be displayed.
- Tap  to move up one folder level.
- When you move down a folder level by tapping a folder key,  appears. Tap this key to return to the file or folder name selection screen.
- Tap  to switch to thumbnails.
- Tap the [File or Folder Name] key to change the order of the files and folders displayed on the screen. Each time the key is tapped, the order changes between ascending and descending.

5

### Select the print conditions.

- If you have selected multiple files in step 4, you can select only the number of prints.
- If you selected a PS or PCL file that includes print conditions in step 4, the print conditions in the file will be given priority.

6

### Tap the [Start] key.

Printing begins after the selected file is downloaded.



# DIRECTLY PRINTING A FILE IN USB MEMORY

Files in a USB memory device connected to the machine are printed from the operation panel of the machine without using the printer driver.

When the printer driver of the machine is not installed on your PC, you can copy a file into a commercially available USB memory device and connect the device to the machine to print the file directly.



Printing from a USB memory device is not possible when [System Settings] in "Settings (administrator)" → [Printer Settings] → [Condition Settings] → [Disabling of USB Memory Direct Print] is selected.



- Use FAT32 or NTFS format for USB memory device.
- When the format of the USB memory device is FAT32, use a 32 GB or less USB memory device.
- When you select a PDF file that has a password, enter the password in the job management screen to begin printing.
  - ▶ [PRINTING AN ENCRYPTED PDF FILE \(page 3-90\)](#)

1

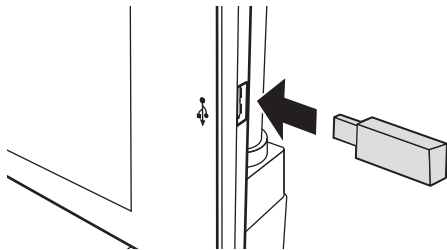

**Connect the USB memory device to the machine.**

2



**When the screen for selecting the action appears, tap [Print from external memory device (USB)].**

If the screen does not appear, follow the steps below.

- (1) Tap the [File Retrieve] key.
- (2) Tap the [Select File from USB Memory to Print] key on the action panel.

3

**Tap the key of the file that you wish to print, and tap the [Choose Print Settings] key on the action panel.**

- When printing multiple files, tap the keys of the files you wish to print, and tap the [Print] key on the action panel.
- The icon appears to the left of keys of files that can be printed.
- The icon is displayed to the left of keys of folders in the USB memory device. To display a folder or a file in a folder, tap this key.



- A total of 500 keys of files and folders can be displayed.
- Tap to move up one folder level.
- When you move down a folder level by tapping a folder key, appears. Tap this key to return to the file or folder name selection screen.
- Tap to switch to thumbnails.
- Tap the [File or Folder Name] key to change the order of the files and folders displayed on the screen. Each time the key is tapped, the order changes between ascending and descending.



4

### Select the print conditions.

- If you have selected multiple files in step 3, you can select only the number of prints.
- If you selected a PS or PCL file that includes print conditions in step 3, the print conditions in the file will be given priority.

5

### Tap the [Start] key.

Printing begins after the selected file is transferred.

6

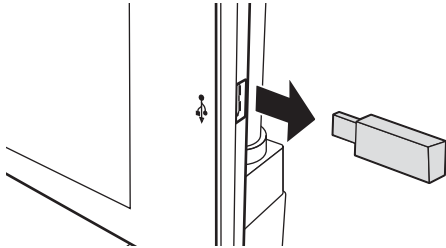

Remove the USB memory device from the machine.



To prohibit direct printing from a USB memory device, enable "Settings (administrator)" – [System Settings] → [Printer Settings] → [Condition Settings] → [Disabling of USB Memory Direct Print].

## DIRECTLY PRINTING A FILE IN A NETWORK FOLDER

You can specify and print a file in a network folder from the touch panel of the machine.

Even if the network folder is not registered, you can access the network folder by directly entering or referring to the path to the folder in the workgroup.



### To register a network folder:

In "Settings (administrator)", select [System Settings] → [Printer Settings] → [Direct Print Settings (Network Folder)]. (Administrator rights are required.) Up to 20 network folders can be registered.

To prohibit direct printing from a network folder, enable "Settings (administrator)" – [System Settings] → [Printer Settings] → [Condition Settings] → [Disabling of Network Folder Direct Print].



Printing from a network folder is not possible when [System Settings] in "Settings (administrator)" → [Printer Settings] → [Condition Settings] → [Disabling of Network Folder Direct Print] is selected.



When you select a PDF file that has a password, you must enter the password in the job management screen to begin printing.

► [PRINTING AN ENCRYPTED PDF FILE \(page 3-90\)](#)



## Printing a file in the network folder you have configured in the machine's settings

**1** Tap the [File Retrieve] key.

**2** Tap the [Select File from Network Folder to Print] key on the action panel.



**3** Tap the [Open Registered Network Folder.] key on the action panel and tap the network folder that you wish to access.

If a screen appears prompting you to enter a user name and password, check with your server administrator and enter the appropriate user name and password.





- When you tap the [Direct Input of Folder Path] key, a screen appears to allow direct input of the network folder path. For more information, see "[Entering the network folder path directly \(page 3-86\)](#)".
- When you select the workgroup, server, and network folder in sequence, you can access the network folder. For more information, see "[Referring to the network folder path \(page 3-86\)](#)".

**4** Tap the key of the file that you wish to print, and tap the [Choose Print Settings] key on the action panel.

- When printing multiple files, tap the keys of the files you wish to print, and tap [Print] on the action panel.
- The  icon appears to the left of keys of files that can be printed.
- The  icon is displayed to the left of keys of folders in the network folder. To display a folder or a file in a folder, tap this key.



- A total of 100 keys of files and folders can be displayed.
- Tap  to move up one folder level.
- To return to the network folder selection screen, tap .
- Tap  to switch to thumbnails.
- Tap the [File or Folder Name] key to change the order of the files and folders displayed on the screen. Each time the key is tapped, the order changes between ascending and descending.

**5** Select the print conditions.

- If you have selected multiple files in step 4, you can select only the number of prints.
- If you selected a PS or PCL file that includes print conditions in step 4, the print conditions in the file will be given priority.

**6** Tap the [Start] key.

Printing begins after the selected file is transferred.



## Entering the network folder path directly

1

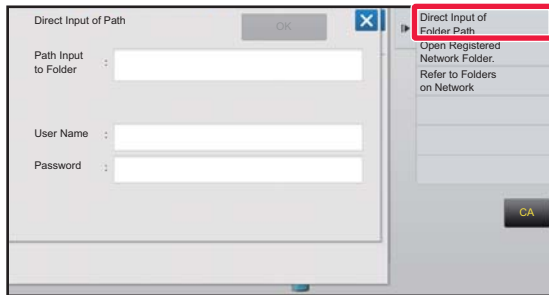

Tap [Direct Input of Folder Path] in step 3 of "[Printing a file in the network folder you have configured in the machine's settings \(page 3-85\)](#)".

2

### Enter the path to the folder, user name and password.

Access the network folder.

For the procedure for printing, see steps 4 to 6 of "Printing a file in the network folder you have configured in the machine's settings".

## Referring to the network folder path

1

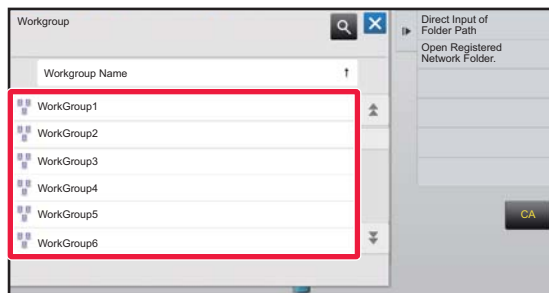

Tap the key of the workgroup that you wish to access in step 3 of "[Printing a file in the network folder you have configured in the machine's settings \(page 3-85\)](#)".

2

### Tap the key of the server or computer that you wish to access.

If a screen appears prompting you to enter a user name and password, check with your server administrator and enter the appropriate user name and password.

3

### Tap the key of the network folder that you wish to access.

Access the network folder.

For the procedure for printing, see steps 4 to 6 of "[Printing a file in the network folder you have configured in the machine's settings \(page 3-85\)](#)".



- Tap the icon and enter a keyword to search for a workgroup, server, or network folder. To enter text, see "User's Manual (Touch Panel Operation)".
- Up to 100 workgroups, 100 servers, and 100 network folders are displayed.
- Tap to move up one folder level.
- To return to the workgroup selection screen, tap .



# DIRECTLY PRINTING FROM A COMPUTER

## SUBMIT PRINT JOB

By selecting [Document Operations] → [Submit Print Job] from "Settings (Web version)" and specifying a file, you can directly print the file without using the printer driver.

In addition to a file on your PC, this procedure can be used to print any file that can be accessed from your PC, such as a file on another PC connected to the same network.

Files that can be printed are PDF, TIFF, JPEG, PCL, PS, XPS, DOCX, PPTX, and XLSX files with extensions pdf, tif, tiff, jpeg, jpg, jpe, jfif, pcl, ps, xps, docx, pptx, and xlsx. Available only if the MFP supports PostScript.

Enter the password for the encrypted PDF data on Spool Queue of the Job Management screen.



- If you selected a PS or PCL file that includes print conditions, the print conditions in the file will be given priority.
- When user authentication is enabled in the settings of the machine, the print function may be restricted. For more information, ask your administrator.

## Print Settings

Select print settings. Select the file you want to print in "Select File", select settings, and then click [Print].

| Item           | Description  |
|----------------|--|
| Copies         | Set the number of copies to be printed.  |
| Paper Size     | Set the print size.  |
| Orientation    | Select portrait or landscape for the print orientation.  |
| 2-Sided Print  | Select one-sided printing, two-sided printing (booklet), or two-sided printing (tablet).   |
| Output         | If printing by set, select the "Print per Unit" checkbox.  |
| Staple         | Select staple settings.  |
| Separator Page | Select to insert separator pages. Specify whether separator pages are to be added in front of or behind each set. Select the paper tray with the paper you want to use from the paper trays. |
| Fit To Page    | Print with the file expanded to the full paper size.   |
| Print What     | Select whether to print a sheet or to print the entire workbook when printing an Excel file.   |
| Output Tray    | Select the output tray for the print job.  |
| Quick File     | Save the print data in the Quick File Folder of the machine.   |
| Print Glossy   | Select this checkbox if the print job will be printed on glossy paper.   |
| Fold           | Set the paper fold.  |
| Trim           | Trim off excess edges of paper for a finer finish.   |
| Billing Code   | Select the checkbox of the Billing Code to assign, and then enter the billing code.  |

Qualcomm® DirectOffice™ is a product of Qualcomm Technologies, Inc. and/or its subsidiaries. Qualcomm® is a trademark of Qualcomm Incorporated, registered in the United States and other countries.

DirectOffice™ is a trademark of CSR Imaging US, LP, registered in the United States and other countries.



## FTP PRINT

You can print a file from your PC by simply uploading the file onto the FTP server of the machine.



To perform FTP print:

In "Settings (administrator)", select [System Settings] → [Printer Settings] → [Print Setting from PC/Mobile Terminal], set [FTP Print] to [Enable], and then configure the port number. (Administrator rights are required.)

### Performing FTP print

Type the IP address of the machine in the server name input box displayed by the FTP client application you are using, and connect to the machine.

When you upload the file that you wish to print into the "lp" folder on the FTP server of the machine, printing of the file begins automatically.



- If you selected a PS or PCL file that includes print conditions, the print conditions in the file will be given priority.
- When user authentication is enabled in the settings of the machine, the print function may be restricted. For more information, ask your administrator.

## E-MAIL PRINT

If you configure your e-mail account in the machine, the machine periodically checks your mail server and automatically prints received e-mail attachments without using the printer driver.



To perform e-mail print:

In "Settings (administrator)", select [System Settings] → [Printer Settings] → [E-mail Print Settings], and register your e-mail account. (Administrator rights are required.)





## Performing e-mail print

Using your PC's e-mail software, specify the e-mail address of the machine in "Address" and send e-mail attached with a file to be printed. Control commands can be entered in the message of the e-mail to specify the number of copies and print format. Commands are entered in the format "command name = value" as shown in the example to the right.

```
COPIES=2
DUPLEX=LEFT
ACCOUNTNUMBER=11111
PAPER=A4
```

As an example, the control commands include the following:

| Function          | Command name   | Values   |
|-------------------|----------------|--|
| Copies            | COPIES         | 1 to 9999                                      |
| Staple*1          | STAPLEOPTION   | NONE, ONE, TWO, SADDLE                         |
| Punch*2           | PUNCH          | OFF, ON  |
| Punch holes       | PUNCH-NUMBER   | TWO, THREE, FOUR, FOURWIDE                     |
| Collate           | COLLATE        | OFF, ON  |
| 2-sided Print     | DUPLEX         | TOP, LEFT, RIGHT, OFF                          |
| Account Number*3  | ACCOUNTNUMBER  | Number (5 to 8 digits)                         |
| File Format       | LANGUAGE       | PCL, PCLXL, POSTSCRIPT, PDF, TIFF, JPG         |
| Paper             | PAPER          | Paper that can be used (LETTER, A4, or others) |
| Fold*4            | V-FOLD         | OFF, INSIDE, OUTSIDE                           |
| Fold (Z-Fold)*5   | FOLD           | OFF, A3, A4, B4, LEDGER, LEGAL, LETTER         |
| Document Filing*6 | FILE           | OFF, ON  |
|                   | FOLDERNAME     | Up to 28 characters                            |
| Quick File*6      | QUICKFILE      | OFF, ON  |
| Output            | OUTTRAY        | CENTER, RIGHT, FINISHER, TOPTRAY               |
| Fit Page          | FITIMAGETOPAGE | OFF, ON  |
| Print Glossy      | MEDIATYPE      | GLOSSY   |
| Print Pages       | PRINTPAGES     | 1-2,5,9-                                       |
| Print What        | ALLSHEETS      | OFF, ON  |

\*1 Enabled only when a finisher (large stacker), saddle stitch finisher (large stacker) is installed.

\*2 Enabled only when a punch module is attached to the finisher (large stacker), saddle stitch finisher (large stacker).

\*3 Can be omitted except when authentication is by user number.

\*4 When the saddle stitch finisher (large stacker) is installed.

\*5 When the folding unit is installed.

\*6 Only enabled when either "Document Filing" or "Quick File" is "ON". When both are "ON", this is disabled.



- The mail text must be in a text format. If entered in Rich Text format (HTML), the commands will have no effect.
- If you enter "Config" in the mail text, a list of control commands is returned.
- If nothing is entered in the body text (message) of the e-mail, printing will take place according to the settings configured in "Settings (administrator)." → [System Settings] → [Printer Settings] → [Initial Status Settings]. If you selected a PS or PCL file that includes print conditions, the print conditions in the file will be given priority.
- Enter a file type only when you wish to specify the page-description language. Normally there is no need to enter a file type.
- Images in the received mail, such as logo marks in the message and signature, may be printed in some cases.



# PRINTER JOBS

## CHECKING THE PRINT STATUS

When you tap the job management display, jobs are displayed in a list. To check the status of a printer job, tap the [Print] tab.

When you wish to stop or delete jobs or to perform priority processing, read "User's Manual (Touch Panel Operation)".

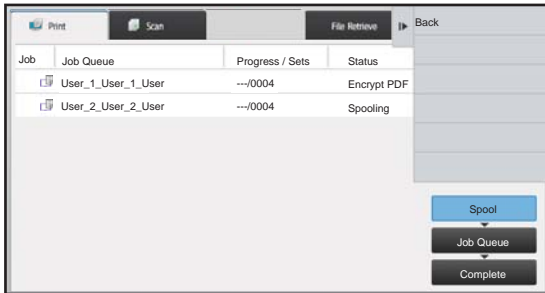

## PRINTING AN ENCRYPTED PDF FILE

PDF encryption is used to protect a PDF file by requiring the entry of a password to print or edit the file. To directly print an encrypted PDF file on an FTP server or in a USB memory device, etc. connected to the machine, reset the password and begin printing.



- To print an encrypted PDF file using the printer driver, enter the password when opening the file on your PC.
- Printing is not possible if you do not know the password for the encrypted PDF file.
- Encrypted PDF versions that can be directly printed are 1.6 (Adobe® Acrobat® 7.0) and earlier.

**(1) Tap the Job Management display and tap the [Print] tab.**

**(2) Tap the [Spool] key.**

When the list contains an encrypted PDF file, a message is displayed to indicate that an encrypted PDF file exists.

**(3) Tap the print job key for the encrypted PDF file.**



You cannot select multiple encrypted PDF files.

**(4) Tap the [Enter Password for Encrypt PDF.] key on the action panel.**

**(5) Enter the password (32 characters or less) and tap the [Yes] key.**



When both a master password and a user password (which is used to open the file) have been set, enter the master password.



# CHANGING TO ANOTHER PAPER SIZE AND PRINTING WHEN PAPER RUNS OUT

If printing stops because the machine ran out of paper, or if the size of paper specified in the printer driver is not loaded in the machine, a message will appear in the touch panel.

Printing will begin automatically when paper is loaded in the machine. If paper of the desired size is not immediately available, you can use paper that is set in a different tray.



If you changed to a different paper size, printing may not take place correctly; for example part of the text or image may run off the paper.

- (1) Tap the job management display.
- (2) Tap the key of the job for which "Paper Empty" appeared.
- (3) Tap the [Reselect Paper] key on the action panel.
- (4) Tap the key for the tray containing the paper that you wish to use, and tap **OK**.



# APPENDIX

## PRINTER DRIVER SPECIFICATIONS LIST

For information on the setting items, refer to printer driver Help.

[PRINTER DRIVER SETTINGS SCREEN / REFERRING TO HELP \(page 3-6\)](#)

| Function        |  |      | PCL6              | PS                | Windows PPD       | macOS PPD         |
|-----------------|--|------|-------------------|-------------------|-------------------|-------------------|
| Tab (Windows)   | Item   | Page |                   |                   |                   |                   |
| Main            | Copies   | -    | 1 - 9999          | 1 - 9999          | 1 - 9999          | 1 - 9999          |
|                 | Collate  | -    | Yes               | Yes               | Yes               | Yes               |
|                 | Original Size                                      | 3-4  | Yes               | Yes               | Yes               | Yes               |
|                 | Output Size  | 3-4  | Yes               | Yes               | Yes               | Yes               |
|                 | Orientation  | 3-34 | Yes               | Yes               | Yes               | Yes               |
|                 | Adjust to Paper Size                               | 3-19 | Yes               | Yes               | No                | Yes               |
|                 | Zoom   | 3-35 | Yes* <sup>1</sup> | Yes               | Yes* <sup>1</sup> | Yes* <sup>1</sup> |
|                 | 2-Sided  | 3-18 | Yes               | Yes               | Yes               | Yes               |
|                 | N-Up   | 3-21 | 2, 4, 6, 8, 9, 16 | 2, 4, 6, 8, 9, 16 | 2, 4, 6, 9, 16    | 2, 4, 6, 9, 16    |
|                 | Staple * <sup>2</sup>                              | 3-24 | Yes               | Yes               | Yes               | Yes               |
| Document Filing | 3-76   | Yes  | Yes               | No                | Yes               |                   |
| Paper Source    | Output Size  | 3-4  | Yes               | Yes               | No                | No                |
|                 | Paper Tray   | 3-7  | Yes               | Yes               | Yes               | Yes               |
|                 | Paper Type   | 3-7  | Yes               | Yes               | Yes               | Yes               |
|                 | Tray Status  | 3-7  | Yes               | Yes               | No                | No                |
| Finishing       | Staple * <sup>2</sup> Saddle Stitch * <sup>3</sup> | 3-24 | Yes               | Yes               | Yes               | Yes               |
|                 | Punch * <sup>2</sup>                               | 3-24 | Yes               | Yes               | Yes               | Yes               |
|                 | Fold * <sup>3</sup>                                | 3-61 | Saddle Fold etc.  | Saddle Fold etc.  | Saddle Fold etc.  | Saddle Fold etc.  |
|                 | Offset   | -    | Yes               | Yes               | Yes               | Yes               |
|                 | Reverse Order Print                                | -    | Yes               | Yes               | Yes               | Yes               |
|                 | Output   | -    | Yes               | Yes               | Yes               | Yes               |
|                 | Separator Page                                     | 3-55 | Yes               | Yes               | No                | No                |
| Trimming        | 3-28   | Yes  | Yes               | No                | Yes               |                   |



| Function      |                            |                 | PCL6 | PS                                | Windows PPD                       | macOS PPD      |                |
|---------------|----------------------------|-----------------|------|-----------------------------------|-----------------------------------|----------------|----------------|
| Tab (Windows) | Item                       | Page            |      |                                   |                                   |                |                |
| Layout        | 2-Sided                    | 3-18            | Yes  | Yes                               | Yes                               | Yes            |                |
|               | Chapter Inserts            | 3-60            | Yes  | No                                | No                                | No             |                |
|               | Booklet                    | 3-26            | Yes  | Yes                               | Yes                               | Yes            |                |
|               | N-Up                       | Page No.        | 3-21 | 2, 4, 6, 8, 9, 16                 | 2, 4, 6, 8, 9, 16                 | 2, 4, 6, 9, 16 | 2, 4, 6, 9, 16 |
|               |                            | Repeat          | 3-67 | Yes                               | No                                | No             | No             |
|               |                            | Order           | 3-21 | Yes                               | Yes                               | Yes            | Yes            |
|               |                            | Border          | 3-21 | Yes                               | Yes                               | Yes            | Yes            |
|               |                            | N-Up with cover | 3-21 | Yes                               | No                                | No             | No             |
|               |                            | 100% N-Up       | 3-21 | Yes                               | Yes                               | No             | No             |
|               | Poster Printing            | 3-32            | Yes  | Yes                               | No                                | No             |                |
|               | Print Position             | Margin Shift    | 3-30 | 0 inch to 1.2 inch (10mm to 30mm) | 0 inch to 1.2 inch (10mm to 30mm) | Yes            | Yes            |
| Tab Shift     |                            | 3-57            | Yes  | Yes                               | No                                | No             |                |
| Custom        |                            | 3-33            | Yes  | Yes                               | No                                | No             |                |
| Job Handling  | Print Release              | -               | Yes  | Yes                               | No                                | Yes            |                |
|               | Document Filing            | 3-76            | Yes  | Yes                               | No                                | Yes            |                |
|               | Create PDF for PC Browsing | 3-76            | Yes  | No                                | No                                | No             |                |
|               | Print and Send             | 3-80            | Yes  | No                                | No                                | No             |                |
|               | Notify Job End             | -               | Yes  | Yes                               | No                                | No             |                |
|               | Authentication             | 3-8             | Yes  | Yes                               | No                                | Yes            |                |
| Inserts       | Covers/Inserts             | 3-51            | Yes  | Yes                               | Yes*4                             | Yes*4          |                |
|               | Transparency Inserts       | 3-53            | Yes  | Yes                               | No                                | Yes            |                |
|               | Carbon Copy                | 3-56            | Yes  | Yes                               | No                                | No             |                |
|               | Tab Paper                  | 3-57            | Yes  | No                                | No                                | No             |                |
| Stamp         | Watermark                  | 3-44            | Yes  | Yes                               | Yes                               | Yes            |                |
|               | Image Stamp                | 3-42            | Yes  | Yes                               | No                                | No             |                |
|               | Overlay                    | 3-48            | Yes  | Yes                               | No                                | No             |                |
|               | Hidden Pattern             | 3-68            | Yes  | No                                | No                                | No             |                |
|               | Document Control           | -               | Yes  | Yes                               | Yes                               | Yes            |                |
|               | Copies Stamp               | 3-50            | Yes  | No                                | No                                | No             |                |
| Image Quality | Print Mode                 | 3-17            | Yes  | Yes                               | Yes                               | Yes            |                |
|               | Graphics Mode              | -               | Yes  | No                                | No                                | No             |                |
|               | Bitmap Compression         | -               | Yes  | Yes                               | No                                | No             |                |
|               | Sharpness                  | -               | Yes  | Yes                               | Yes                               | Yes            |                |
|               | Screening                  | -               | Yes  | Yes                               | Yes                               | Yes            |                |
|               | Text To Black              | 3-43            | Yes  | Yes                               | No                                | No             |                |
|               | Vector To Black            | 3-43            | Yes  | Yes                               | No                                | No             |                |
|               | Toner Save *5              | -               | Yes  | Yes                               | Yes                               | Yes            |                |



| Function                     |                              |      | PCL6 | PS  | Windows PPD | macOS PPD |  |
|------------------------------|------------------------------|------|------|-----|-------------|-----------|--|
| Tab (Windows)                | Item                         | Page |      |     |             |           |  |
| Image Quality                | Font                         | -    | Yes  | Yes | No          | No        |  |
|                              | Line Width                   | 3-37 | Yes  | No  | No          | No        |  |
|                              | Boldness Adjustment          | -    | Yes  | Yes | Yes         | Yes       |  |
| Detailed Settings            | Mirror Image                 | 3-41 | No   | Yes | Yes         | Yes       |  |
|                              | PS Error Information         | -    | No   | Yes | Yes         | No        |  |
|                              | PS Pass-Through              | -    | No   | Yes | No          | No        |  |
|                              | Job Compression              | -    | No   | Yes | No          | No        |  |
|                              | Tandem Print                 | 3-72 | Yes  | Yes | No          | Yes*6     |  |
|                              | Disable Blank Page Print     | 3-23 | Yes  | Yes | No          | No        |  |
|                              | Custom Image Registration    | 3-47 | Yes  | No  | No          | No        |  |
|                              | Other Settings               |      |      |     |             |           |  |
|                              | • Input Resolution           | -    | Yes  | Yes | No          | No        |  |
|                              | • Shade Pattern              | -    | Yes  | No  | No          | No        |  |
|                              | • Spool Data Format          | -    | Yes  | Yes | No          | No        |  |
|                              | • Printable Area             | 3-71 | Yes  | Yes | No          | No        |  |
|                              | • Rip Style                  | 3-76 | Yes  | Yes | No          | Yes       |  |
|                              | • Duplex Style               | 3-18 | Yes  | Yes | No          | No        |  |
|                              | • CMYK Image Enhancement     | -    | No   | Yes | No          | No        |  |
|                              | • Job Name Shortening        | -    | Yes  | Yes | No          | No        |  |
|                              | • Use driver to render JPEGs | 3-70 | Yes  | Yes | No          | No        |  |
|                              | • Thicken Fine Lines         | 3-38 | Yes  | No  | No          | No        |  |
|                              | • Fine Text                  | -    | Yes  | Yes | Yes         | Yes       |  |
|                              | • Text/Line control          | 3-39 | Yes  | Yes | Yes         | Yes       |  |
| • Text/Line knockout control | 3-39                         | Yes  | Yes  | Yes | Yes         |           |  |
| • Photo Image                | -                            | Yes  | Yes  | Yes | Yes         |           |  |
| • Image Enhancement          | 3-39                         | Yes  | Yes  | Yes | Yes         |           |  |

\*1 The horizontal and vertical proportion cannot be set separately.

\*2 If a finisher or a saddle stitch finisher is installed (The punch module is also required in order to use the punch function.)

\*3 If a saddle stitch finisher is installed.

\*4 Only covers can be inserted.

\*5 This setting may not operate in some applications and operating systems.

\*6 This function cannot be used in macOS 10.10 or later.



# SPECIFYING A BILLING CODE USING THE PRINTER DRIVER

You can enter a billing code using the printer of the machine.

For an overview of a billing code, refer to "[BILLING CODE \(page 1-61\)](#)".

## Enable billing code

This setting is required only in the Windows environment. (Always usable under macOS environment)

**1**

Click the [Start] button, select [Settings] → [Device] → [Devices and Printers].



In Windows 8.1/Windows Server 2012, right-click the [Start] button, select [Control Panel] → [View devices and printers] (or [Devices and Printers]).

**2**

Right-click the printer driver icon of the machine and select [Printer Properties].

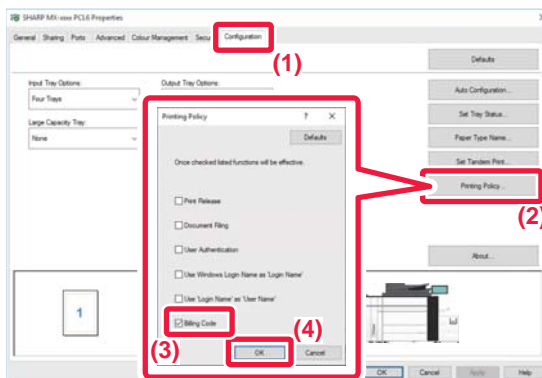
**3**

## Specify a billing code

(1) Click the [Configuration] tab.

(2) Click the [Printing Policy] button.

(3) Set the [Billing Code] check box to ,

(4) Click the [OK] button.



## Windows

When printing starts, the billing code setting screen appears.

Enter the main code and sub code, and click the [OK] button.

To retain the specified billing code, set [Always Use This Billing Code] to .



- You can click [Get Billing Code] to get the machine's billing code list and select the billing code from the list.
- If [Use Billing Code] is set to "Disable" in "Settings (administrator)" → [User Control] → [Billing Code Setting] → [Administration Settings], the entered billing code is disabled and is not recorded in the job log.
- If you have started printing without specifying a billing code, a use code is recorded in the job log.

## macOS

(1) Select [Billing Code].

(2) Enter the main code and sub code.





# AUTHENTICATION BY SINGLE SIGN-ON

When the user authentication is used, you must enter your user name and password to print from a printer driver. The Single Sign-on function can be used when Active Directory authentication is used on both the machine and the computer.

When you use this function and print from the printer driver, the print job is sent to the machine using the authentication information that you used to log in to the computer. This allows easy printing of jobs from the printer driver without the need to enter your user name or password each time you print when user authentication is enabled.



Authentication by Single Sign-on requires that Active Directory authentication be performed on the machine and your computer. This can only be used when your computer is running Windows.

## Settings

Active Directory must be enabled on the machine in advance. For information on Active Directory, refer to "[ACTIVE DIRECTORY LINKING FUNCTION \(page 1-57\)](#)". After enabling Active Directory, configure the settings below in the printer driver.

**(1) Click the [Start] button, select [Settings] → [Device] → [Devices and Printers].**

In Windows 8.1/Windows Server 2012, right-click the [Start] button, select [Control Panel] → [View devices and printers] (or [Devices and Printers]).

**(2) Right-click the machine's printer driver icon and select [Printer Properties].**

The printer properties appear.

**(3) Click the [Configuration] tab.**

**(4) Set the [Single Sign-on] checkbox to .**

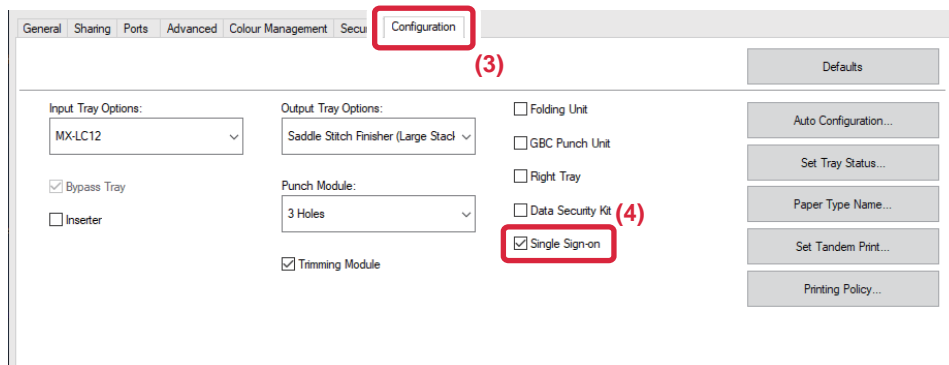

## Authentication Option

For the authentication method, refer to "[PRINTING WHEN THE USER AUTHENTICATION FUNCTION IS ENABLED \(page 3-8\)](#)".

**(1) Click the [Job Handling] tab.**

**(2) In [Authentication], select [Single Sign-on].**



- Single Sign-on authentication is also possible from the Job Handling dialog box and the User Authentication dialog box.
- When Single Sign-on is enabled, [Print and Send] cannot be used.
- If you logged in to the machine in advance before using Single Sign-on, you will have the permissions of the user account you used to log in.  
If you use Single Sign-on without logging in to the machine, the user permissions will be those of "User".  
This may limit the functions that you can use.
- If Single Sign-on is used without logging in to the machine, the user name in the job log will be the name set by printer driver. If the user name is not set by printer driver, the user name in the job log will be the computer login name.





# SCANNER







## Icons

 Functions you can use in Easy Scan mode



## BEFORE USING THE MACHINE AS A NETWORK SCANNER







|  |             |
|--|-------------|
| <b>BEFORE USING THE MACHINE AS A NETWORK SCANNER FUNCTION</b> .....  | <b>4-3</b>  |
| • USES OF THE NETWORK SCANNER.....   | 4-3         |
| • BEFORE USING THE NETWORK SCANNER ...   | 4-4         |
| • STORING DESTINATIONS FOR SCAN TO DESKTOP .....   | 4-6         |
| <b>NETWORK SCANNER MODE</b> .....  | <b>4-7</b>  |
|  • EASY MODE .....                           | 4-7         |
| • NORMAL MODE .....  | 4-8         |
|  <b>SELECTING NETWORK SCANNER MODE</b> ..... | <b>4-8</b>  |
|  <b>IMAGE SEND SEQUENCE</b> .....            | <b>4-9</b>  |
| • Default settings for Scan Save .....   | 4-11        |
| <b>ORIGINAL SIZE</b> .....   | <b>4-13</b> |
| • TRANSMITTABLE ORIGINAL SIZES .....   | 4-13        |
| • THE SIZE OF THE PLACED ORIGINAL.....   | 4-13        |

## ENTERING DESTINATIONS

|  |             |
|--|-------------|
|  <b>ENTERING DESTINATIONS</b> .....                                  | <b>4-14</b> |
|  • RETRIEVING A DESTINATION FROM AN ADDRESS BOOK .....               | 4-14        |
| • MY ADDRESS.....  | 4-17        |
|  • VIEWING A LIST OF THE SELECTED DESTINATIONS .....                 | 4-18        |
| • USING A SEARCH NUMBER TO RETRIEVE A DESTINATION.....   | 4-19        |
|  • ENTERING AN ADDRESS MANUALLY .....                                | 4-20        |
| • SPECIFYING A NETWORK FOLDER.....   | 4-21        |
|  • RETRIEVING A DESTINATION FROM A GLOBAL ADDRESS BOOK.....          | 4-23        |
|  • USING A TRANSMISSION LOG TO RESEND ...                            | 4-25        |
|  • SENDING ONLY THE URL OF A SCANNED FILE TO A SCAN DESTINATION..... | 4-27        |

## TRANSMITTING AN IMAGE

|  |             |
|--|-------------|
|  <b>TRANSMITTING AN IMAGE</b> .....    | <b>4-30</b> |
|  • SENDING AN IMAGE IN SCAN MODE ..... | 4-30        |
| • CHANGING THE SUBJECT, FILE NAME, REPLY-TO, AND BODY TEXT AT THE TIME OF SCAN TRANSMISSION .....                        | 4-33        |

|   |             |
|---|-------------|
|  • SENDING THE SAME IMAGE TO MULTIPLE DESTINATIONS (BROADCAST TRANSMISSION)..... | 4-36        |
| <b>IMAGE SETTINGS</b> .....   | <b>4-39</b> |
|  • AUTOMATICALLY SCANNING BOTH SIDES OF AN ORIGINAL (2-SIDED ORIGINAL).....      | 4-39        |
| • SCAN SIZE AND SEND SIZE (ENLARGE/REDUCE) .....  | 4-40        |
| • SPECIFYING THE ORIGINAL SCAN SIZE IN PAPER SIZE .....   | 4-41        |
| • SPECIFYING THE ORIGINAL SCAN SIZE USING NUMERIC VALUES.....   | 4-42        |
| • STORING FREQUENTLY USED ORIGINAL SIZES .....  | 4-43        |
| • SPECIFYING THE SEND SIZE OF THE IMAGE .....   | 4-46        |
| • CHANGING THE EXPOSURE AND ORIGINAL IMAGE TYPE .....   | 4-48        |
|  • CHANGING THE RESOLUTION .....   | 4-50        |
|  • CHANGING FORMAT IN SCAN OR DATA ENTRY MODE .....                             | 4-51        |
|  • CHANGING COLOR MODE.....  | 4-56        |
|  • SETTING SCAN SETTINGS AUTOMATICALLY (Auto Set) .....                        | 4-57        |
| <b>CHECKING THE IMAGE TO BE TRANSMITTED ...</b>   | <b>4-58</b> |





**OTHER FUNCTIONS**

**STORING SCAN OPERATIONS (PROGRAM) . . . . 4-59**

**SCANNING AND SENDING ORIGINALS COLLECTIVELY. . . . . 4-62**

- SCANNING AND SENDING ORIGINALS COLLECTIVELY . . . . . 4-62
- SCANNING BOTH SIDES OF A CARD ONTO A SINGLE PAGE (CARD SHOT). . . . . 4-64
- SIMULTANEOUSLY SCANNING MULTIPLE CARDS, RECEIPTS OR OTHER SMALL ORIGINALS TO INDIVIDUAL FILES (MULTICROP) . . . . . 4-66
- SCANNING A BUSINESS CARD, READING THE TEXT STRING, CREATING A FILE, AND SENDING THE FILE (BUSINESS CARD SCAN) 4-68
- SCANNING MULTIPLE PHOTOS AT ONCE TO INDIVIDUAL FILES (Image Crop) . . . . . 4-73
- SCANNING MANY ORIGINALS AT ONCE (JOB BUILD) . . . . . 4-75

**SCANNING AND SENDING AN ORIGINAL AS SEPARATE PAGES. . . . . 4-78**

- SCANNING AN ORIGINAL AS TWO SEPARATE PAGES (DUAL PAGE SCAN) . . . . 4-78
- SPLITTING A PAMPHLET BY PAGE AND TRANSMITTING THE PAGES SUCCESSIVELY (BOOK DIVIDE) . . . . . 4-81

**ADJUSTING COLORS AND SHADING. . . . . 4-83**

- ADJUSTING THE BACKGROUND BY MAKING LIGHT AREAS OF THE ORIGINAL DARKER OR LIGHTER (BACKGROUND ADJUSTMENT) . . . . 4-83
- ADDING CONTRAST TO THE SCANNED ORIGINAL BEFORE TRANSMISSION (CONTRAST) . . . . . 4-85
- ENHANCING THE OUTLINE OF THE SCANNED ORIGINAL BEFORE TRANSMISSION (SHARPNESS) . . . . . 4-87
- REMOVING CHROMATIC COLORS FROM THE SCANNED ORIGINAL BEFORE TRANSMISSION (DROP OUT COLOR) . . . . . 4-89
- ADJUSTING RED/GREEN/BLUE (RGB Adjust) . . . 4-91

**SCANNING ORIGINALS . . . . . 4-93**

- ERASING PERIPHERAL SHADOWS ON THE IMAGE (ERASE) . . . . . 4-93
- SCANNING A THIN ORIGINAL (SLOW SCAN MODE) . . . 4-96
- SCANNING A HEAVY ORIGINAL (HEAVY PAPER SCAN) . . . . . 4-98
- ELIMINATING BLANK PAGES FROM A TRANSMISSION (BLANK PAGE SKIP) . . . . . 4-100
- CHECKING THE NUMBER OF SCANNED ORIGINAL SHEETS BEFORE TRANSMISSION (ORIGINAL COUNT) . . . . . 4-102
- STAMPING SCANNED ORIGINALS (VERIFICATION STAMP) . . . . . 4-104

**AUTOMATICALLY ADJUST SKEWED PDF SCAN DATA (PDF SKEW ADJUSTMENT) . . . . . 4-106**

- PDF FORMATS THAT CAN USE PDF SKEW ADJUSTMENT . . . . . 4-106

**SPECIFIC FUNCTIONS . . . . . 4-108**

- ADDING A SIGNATURE WHEN SENDING AN IMAGE (ELECTRONIC SIGNATURE) . . . . . 4-108
- ENCRYPTING THE TRANSMITTED DATA (ENCRYPTION) . . . . . 4-110

**SCANNING FROM A COMPUTER (PC Scan Mode)**

**BASIC SCANNING PROCEDURE . . . . . 4-112**

**METADATA DELIVERY**

**PREPARATIONS FOR METADATA DELIVERY . . . 4-117**

- METADATA DELIVERY (DATA ENTRY) . . . . . 4-117
- SETTINGS REQUIRED IN THE SETTING MODE (WEB VERSION) . . . . . 4-118
- METADATA DELIVERY USING SCAN TO DESKTOP . . . . . 4-118

**TRANSMITTING METADATA. . . . . 4-119**

- TRANSMITTING METADATA . . . . . 4-119
- METADATA FIELDS . . . . . 4-120
- METADATA SETTINGS . . . . . 4-121





# BEFORE USING THE MACHINE AS A NETWORK SCANNER

## BEFORE USING THE MACHINE AS A NETWORK SCANNER FUNCTION

### USES OF THE NETWORK SCANNER

The network scanner allows you to create an image file from the original data scanned by the machine, and send the file over a network to a PC, FTP server, or other destinations. If necessary, it scans the original using a TWAIN-compliant application on your PC. The network scanner function provides the following scanning modes.

#### Scanner mode

The scanner function of the machine sends a scanned original as described below based on the specification of the destination.

- **Scan to E-mail**

You can send a scanned file as an e-mail attachment. You can also save the file to the machine's local drive and send only a URL link (without attaching the file) that allows the recipient to download the file.

- **Scan to FTP**

The scanned file is sent to a specified folder of an FTP server.

When the file is sent, it is also possible to send an e-mail to a previously stored e-mail address to inform the recipient of the location of the file.

- **Scan to Desktop**

The scanned file is sent to a specified folder on your computer.

For information on Scan to Desktop, consult your dealer.

- **Scan to Network Folder**

The scanned file is sent to a network folder on a Windows PC on the same network as the machine.

When the file is sent, it is also possible to send an e-mail to a previously stored e-mail address to inform the recipient of the location of the file.

For the operating procedure, see "[SENDING AN IMAGE IN SCAN MODE \(page 4-30\)](#)".



## Data entry mode

In data entry mode, information entered using the touch panel or automatically generated by the machine is sent to a directory on an FTP server or an application on a PC as a metadata file in XML format.



Installing the application integration module is required to use the metadata delivery function.

The application integration module can be combined with the network scanner to append a metadata file to a scanned image file.

Metadata is information about a file, how it is to be processed, and its relation to other objects.

For the operating procedure, see "[TRANSMITTING METADATA \(page 4-119\)](#)".

## BEFORE USING THE NETWORK SCANNER

To use the machine as a network scanner, you must store sender information, configure server settings, store destinations in the address book, and perform other required operations.

1

### Make sure the main power switch is in the " | " position.

When the main power indicator is lit up, the main power is in the " | " position. If the main power indicator is not lit up, turn the main power switch to the " | " position and press the [POWER] button on the operation panel.

► [TURNING ON THE POWER \(page 1-10\)](#)

2

### Check the date and time.

Verify that the correct date and time are set in the machine.



#### To set the date and time of the machine:

In "Settings", select [System Settings] → [Common Settings] → [Device Control] → [Clock Adjust].



If [Disabling of Clock Adjustment] has been enabled, the date and time cannot be modified.

Select [System Settings] in "Settings (administrator)" → [Common Settings] → [Device Control] → [Enable/Disable Settings] → [Operation Settings] to disable the [Disabling of Clock Adjustment] setting.

3

### Store the sender information.

#### Before using Scan to E-mail:

Store a default sender name in "Sender Name" and a reply e-mail address in "Reply E-mail Address".



- **To store the sender's name and e-mail address that are used when a sender is not selected:**  
In "Settings (administrator)", select [System Settings] → [Image Send Settings] → [Scan Settings] → [Condition Settings] → [Default Reply.Address Set].
- **To store the sender's name and address:**  
In "Settings (administrator)", select [System Settings] → [Image Send Settings] → [Common Settings] → [Own Number and Name Set] → [Sender Data Registration].
  - **Sender Name:**  
Enter the sender name. A maximum of 20 characters can be entered for the sender name.
  - **Registration of Own Name Select:**  
Stores the sender name used in "Own Name Select " of another function. Up to 18 sender names can be stored.
  - **Sender Name:**  
Enter the sender name. A maximum of 20 characters can be entered for the sender name.

## 4

### Configure settings required in the setting mode.

Configure server settings, default settings for the network scanner.



- **To configure server settings:**  
In "Settings (administrator)", select [System Settings] → [Network Settings] → [Services Settings]. (Administrator rights are required.)
- **To configure basic settings for the network scanner:**  
In "Settings (administrator)", select [System Settings] → [Image Send Settings] → [Scan Settings]. (Administrator rights are required.)

## 5

### Store the destination addresses for each scan mode in the address book.

You can send an image by directly entering an address when using Scan to Image. It is convenient to previously store addresses in the address book.

Up to 6000 addresses can be stored in the address book. For information on the address book, see the "User's Manual (Address Book Registration)".

For how to use the address books and how to store addresses, see the following item.

- ▶ [RETRIEVING A DESTINATION FROM AN ADDRESS BOOK \(page 4-14\)](#)
- ▶ [VIEWING A LIST OF THE SELECTED DESTINATIONS \(page 4-18\)](#)
- ▶ [USING A SEARCH NUMBER TO RETRIEVE A DESTINATION \(page 4-19\)](#)
- ▶ [ENTERING AN ADDRESS MANUALLY \(page 4-20\)](#)
- ▶ [SPECIFYING A NETWORK FOLDER \(page 4-21\)](#)
- ▶ [RETRIEVING A DESTINATION FROM A GLOBAL ADDRESS BOOK \(page 4-23\)](#)
- ▶ [USING A TRANSMISSION LOG TO RESEND \(page 4-25\)](#)



## STORING DESTINATIONS FOR SCAN TO DESKTOP

To store your computer in the machine as a destination for Scan to Desktop, Network Scanner Tool must be installed. To scan an image to your computer, Network Scanner Tool must be running on your computer.



To install Network Scanner Tool, see the "Sharpdesk Installation Guide". When a standard installation is performed, Network Scanner Tool is installed with Sharpdesk.



- **Prohibit saving of addresses from Network Scanner Tool Lite**

In "Settings (administrator)", select [System Settings] → [Image Send Settings] → [Common Settings] → [Enable/Disable Settings] → [Settings to Disable Registration] → [Disable Registration Using Network Scanner Tool].

This disables address control from the Network Scanner Tools.

Use this option to suppress to store data of another machine through Inbound Routing of address book.

- **Prohibit network forwarding**

In "Settings (administrator)", select [System Settings] → [Image Send Settings] → [Common Settings] → [Enable/Disable Settings] → [Settings to Disable Transmission] → [Disabling of Forwarding via Network].





# NETWORK SCANNER MODE

Network scanner mode has two modes: easy mode and normal mode.

Easy mode is limited to frequently used functions that allow you to smoothly perform most image send jobs.

If you need to select detailed settings or special functions, use normal mode. All functions can be used in normal mode.

## EASY MODE

Easy mode makes it easy to select basic settings for network scanner mode.

### 1st screen

The original size is displayed.

Set an address.

Reset the address and settings.

Scans the original and shows a preview image.

Tap to display the soft keyboard.

Change to normal mode. ► [NORMAL MODE \(page 4-8\)](#)

Change the function display.

Starts black and white or color transmission.

Automatically set the original placement orientation, resolutionskipping of blank pages, automatically detect mono2/grayscale, and PDF skew adjustment.

► [PREVIEW SCREEN \(page 1-14\)](#)

### 2nd screen

Select the function you want to use.

Original: Auto

Resolution: 200x200dpi

File Format: PDF (Color), PDF (Black & White)

Blank Page Skip: Off

You can select these functions in easy mode.

- Original ► [page 4-48](#)
- Resolution ► [page 4-50](#)

- File Format ► [page 4-51](#)
- Blank Page Skip ► [page 4-100](#)



If able to search for My Address, a [Find My Address] key will be displayed next to the address entry.



• To select a function in easy mode

In "Settings (administrator)", select [System Settings] → [Common Settings] → [Operation Settings] → [Easy Mode Settings] → [Easy Scan].

• To cancel the warning message displayed when switching from easy mode to normal mode

In "Settings (administrator)", select [System Settings] → [Common Settings] → [Operation Settings] → [Easy Mode Settings] → [Display a Confirmation Message when Selecting "Detail" in Easy Modes] to disable this setting.

# NORMAL MODE

Normal mode lets you select any function setting that can be used for network scanner.

This section explains the keys on a base screen, taking as an example the E-mail base screen. Several methods are available in the Image Send mode, including Scan to E-mail and Scan to FTP. The base screen layout slightly differs depending on how image is sent.

Tap to display the soft keyboard. Enter subject, file name, and other items.

Displays the address box to enter addresses.

Setting keys used for image send operations.

Displays the list of function keys. Frequently used [Others], programs, and other settings can be registered.

Check the current settings.

Displays keys other than the function keys indicated above.

Displays the sizes of the original and the data to send.

Searches for the address.

Displays the functions that can be used in image send mode.

Scans the original and shows a preview image. [► PREVIEW SCREEN \(page 1-14\)](#)

Reset the address and settings.

Transmission will start immediately.

Enter reply address and body text.

# SELECTING NETWORK SCANNER MODE

Change the network scanner mode to easy mode or normal mode as explained in "[CHANGING MODES \(page 1-13\)](#)".



# IMAGE SEND SEQUENCE

First, to place the machine in a desired image send mode, tap the appropriate icon in the Home screen.

► [CHANGING MODES \(page 1-13\)](#)

1

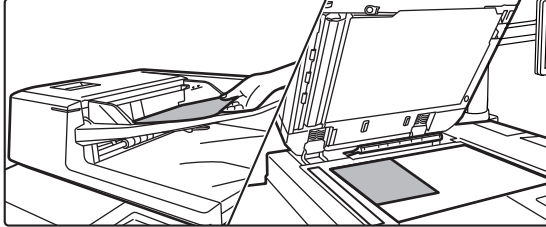

## Place the original.

Place the original in the document feeder tray of the automatic document feeder, or on the document glass.

- [AUTOMATIC DOCUMENT FEEDER \(page 1-116\)](#)
- [DOCUMENT GLASS \(page 1-120\)](#)

2

## Enter the destination.

Tap the address key to directly enter the destination, or search and retrieve the address book or destination.

### In Easy mode

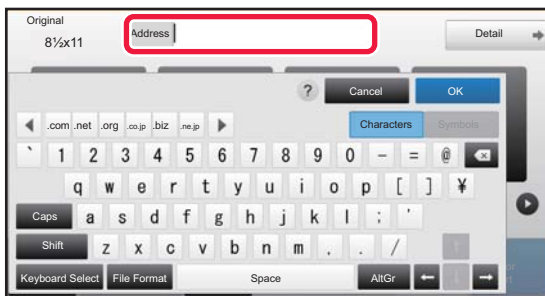

- [ENTERING AN ADDRESS MANUALLY \(page 4-20\)](#)
- [RETRIEVING A DESTINATION FROM AN ADDRESS BOOK \(page 4-14\)](#)
- [USING A TRANSMISSION LOG TO RESEND \(page 4-25\)](#)
- [RETRIEVING A DESTINATION FROM A GLOBAL ADDRESS BOOK \(page 4-23\)](#)

### In Normal mode

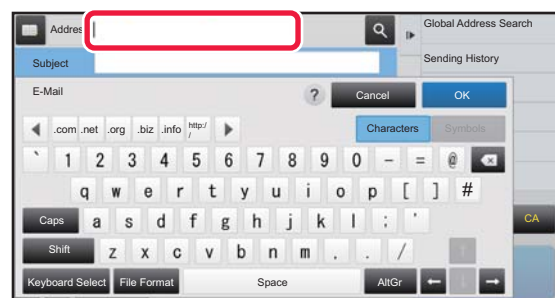

- [ENTERING AN ADDRESS MANUALLY \(page 4-20\)](#)
- [RETRIEVING A DESTINATION FROM AN ADDRESS BOOK \(page 4-14\)](#)
- [USING A SEARCH NUMBER TO RETRIEVE A DESTINATION \(page 4-19\)](#)
- [RETRIEVING A DESTINATION FROM A GLOBAL ADDRESS BOOK \(page 4-23\)](#)
- [USING A TRANSMISSION LOG TO RESEND \(page 4-25\)](#)
- [VIEWING A LIST OF THE SELECTED DESTINATIONS \(page 4-18\)](#)
- [SPECIFYING A NETWORK FOLDER \(page 4-21\)](#)



## 3

**Select functions.**

Specify the original scan size, exposure, file format, and other items. If necessary, you can refer to the following functions for the setting.

**In Easy mode**

- ▶ [AUTOMATICALLY SCANNING BOTH SIDES OF AN ORIGINAL \(2-SIDED ORIGINAL\) \(page 4-39\)](#)
- ▶ [CHANGING THE RESOLUTION \(page 4-50\)](#)
- ▶ [CHANGING FORMAT IN SCAN OR DATA ENTRY MODE \(page 4-51\)](#)
- ▶ [ELIMINATING BLANK PAGES FROM A TRANSMISSION \(BLANK PAGE SKIP\) \(page 4-100\)](#)

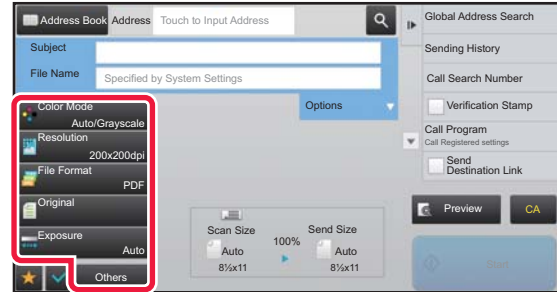
**In Normal mode**

- ▶ [SCANNING AND SENDING ORIGINALS COLLECTIVELY \(page 4-62\)](#)
- ▶ [ADJUSTING COLORS AND SHADING \(page 4-83\)](#)
- ▶ [SCANNING ORIGINALS \(page 4-93\)](#)
- ▶ [AUTOMATICALLY SCANNING BOTH SIDES OF AN ORIGINAL \(2-SIDED ORIGINAL\) \(page 4-39\)](#)
- ▶ [SCAN SIZE AND SEND SIZE \(ENLARGE/REDUCE\) \(page 4-40\)](#)
- ▶ [SPECIFYING THE ORIGINAL SCAN SIZE IN PAPER SIZE \(page 4-41\)](#)
- ▶ [SPECIFYING THE ORIGINAL SCAN SIZE USING NUMERIC VALUES \(page 4-42\)](#)
- ▶ [SPECIFYING THE SEND SIZE OF THE IMAGE \(page 4-46\)](#)
- ▶ [CHANGING THE EXPOSURE AND ORIGINAL IMAGE TYPE \(page 4-48\)](#)
- ▶ [CHANGING THE RESOLUTION \(page 4-50\)](#)
- ▶ [CHANGING FORMAT IN SCAN OR DATA ENTRY MODE \(page 4-51\)](#)
- ▶ [CHANGING COLOR MODE \(page 4-56\)](#)

## 4

**Send the original.**

Tap the [B/W Start] or [Color Start] key ([Start] key in normal mode).



- You can tap the [Preview] key before tapping the [B/W Start] key or the [Color Start] key (the [Start] key in normal mode) to check a preview of the image.
- When the original is placed on the document glass, repeat the placing original and transmission procedures until all originals have been sent. After scanning all originals, tap the [Read-End] key.
- In normal mode, if you tap the [File] or [Quick File] on the action panel before sending image, you can save the scanned original as data.
  - ▶ [USING DOCUMENT FILING IN EACH MODE \(page 5-7\)](#)
- **Always stamp scanned originals**  
 In "Settings (administrator)", select [System Settings] → [Image Send Settings] → [Common Settings] → [Condition Settings] → [Default Verification Stamp].  
 When this is enabled, originals are always stamped without the need to select "Verification Stamp".
- **If the send format is a PDF format, this function automatically adjusts the skew when the original is scanned while skewed.**  
 The automatic skew adjustment function is enabled when enabling auto configuration in easy mode. In normal mode, tap the [Others] key and then the [PDF Skew Adjustment] key to switch.
  - ▶ [AUTOMATICALLY ADJUST SKEWED PDF SCAN DATA \(PDF SKEW ADJUSTMENT\) \(page 4-106\)](#)



## If paper misfeeds in the automatic document feeder

See "[AUTOMATIC DOCUMENT FEEDER \(page 1-116\)](#)" and make sure that the original is loaded correctly. The following two patterns can be set for scanning when a document is misfed.

In "Settings (administrator)", select [System Settings] → [Image Send Settings] → [Scan Settings] → [Condition Settings] → [Quick On Line Sending].

- If enabled  
When an original misfeeds, scanning stops, and scanned data up until that point is sent.
- If disabled  
Even if an original misfeeds, scanning does not stop, the misfed original is set again, and scanning starts again. After all of the original has been scanned, the scanned data is sent.

## Default settings for Scan Save

In "Settings (administrator)", select [System Settings] → [Image Send Settings] → [Scan Settings] → [Default Settings].

### Default Color Mode Settings

Select a default color mode setting for both color and black & white in e-mail address, network folder, FTP and Desktop. Specify "Scanner Common" unless E-mail is specified.

#### Settings

Auto (Mono2, Grayscale\*), Full Color, Grayscale, Mono2

\* When scanning a black and white original with the color mode set to [Auto]

**Disable Change of B/W Setting in Auto Mode:** Disables black & white settings from the base screen when the color mode is set to Auto.

### Initial File Format Setting

Specify the initial file format for sending a file in E-mail, Network Folder, FTP, or Desktop mode. Specify "Scanner Common" unless E-mail is specified.

#### File Type

| Setup Items                      | Remarks  |
|----------------------------------|--|
| PDF                              |  |
| PDF/A-1a                         |  |
| PDF/A-1b                         |  |
| TIFF                             |  |
| JPEG                             | When [Black & White] is selected, the format is [TIFF].        |
| Compact PDF                      | When [Black & White] is selected, the format is [PDF].         |
| Compact PDF (Ultra Fine)         |  |
| Compact PDF/A-1a                 | When [Black & White] is selected, the format is [PDF/A-1a].    |
| Compact PDF/A-1a (Ultra Fine)    |  |
| Compact PDF/A-1b                 | When [Black & White] is selected, the format is [PDF/A-1b].    |
| Compact PDF/A-1b (Ultra Fine)    |  |
| Encrypt PDF                      |  |
| Encrypt/Compact PDF              |  |
| Encrypt/Compact PDF (Ultra Fine) | When [Black & White] is selected, the format is [Encrypt PDF]. |
| XPS                              |  |
| RTF                              |  |
| TXT(UTF-8)                       |  |
| DOCX                             |  |
| XLSX                             |  |
| PPTX                             |  |



**OCR**

When the file format is PDF, characters in a scanned image are recognized and added to the PDF as text information.

| Setup Items              | Settings   |  |
|--------------------------|--|--|
| Black & White            | Compression Mode   | None, MH (G3), MMR (G4)  |
| Color/Grayscale          | Data compression ratio   | Low, Medium, High  |
|                          | Bk Letter Emphasis   | <input type="checkbox"/> (Disabled), <input checked="" type="checkbox"/> (Enabled) |
| Specified Pages per File | <input type="checkbox"/> (Disabled), <input checked="" type="checkbox"/> (Enabled) |  |
|                          | Number of Pages (1 to 99)  |  |



When [JPEG] is selected for the file type, [Specified Pages per File] cannot be selected.

**OCR Setting**

Configure the settings that are required for OCR.

| Setup Items            | Description  |
|------------------------|--|
| Font                   | Set the font used for each recognized character language.          |
| Detect Image Direction | The orientation of the scanned original is automatically detected. |
| File Name Extraction   | Extract the file name.   |

**Easy Scan Settings**

Set the default color mode for Easy Scan.

Set [Color] for when the Color Start key is tapped, and [Black & White] for when the B/W Start key is tapped.

| Setup Items   | Setting          |
|---------------|------------------|
| Color         | Auto, Full Color |
| Black & White | Grayscale, Mono2 |

**Resolution Setting**

The following settings are available for the default resolutions of common scan mode.

**Scanner Common**

100 X 100 dpi, 150 X 150 dpi, 200 X 200 dpi,  
300 X 300 dpi, 400 X 400 dpi, 600 X 600 dpi

**E-mail**

100 X 100 dpi, 150 X 150 dpi, 200 X 200 dpi,  
300 X 300 dpi, 400 X 400 dpi, 600 X 600 dpi

**PDF Skew Adjustment**

This setting can be enabled to use PDF Skew Adjustment function.



# ORIGINAL SIZE

## TRANSMITTABLE ORIGINAL SIZES

The following original sizes can be transmitted

|                                     | Minimum original size  | Maximum original size  |
|-------------------------------------|--|--|
| Using the automatic document feeder | 5-1/8" (height) x 5-1/2" (width)<br>(131 mm (height) x 140 mm (width)) | 11-5/8" (height) x 39-3/8" (width)<br>(297 mm (height) x 1000 mm* (width)) |
| Using the document glass            | -  | 11-5/8" (height) x 17" (width)<br>(297 mm (height) x 432 mm* (width))      |

\*A long original can be transmitted.

## THE SIZE OF THE PLACED ORIGINAL

When a standard size original is placed, the original size is automatically detected and displayed in "Scan Size" on the based screen.

► [SCAN SIZE AND SEND SIZE \(ENLARGE/REDUCE\) \(page 4-40\)](#)

Standard sizes are sizes that the machine can automatically detect. The standard sizes are set in "Original Size Detector Setting" in "Settings".



When the automatic original detection function is operating and the original (of inch or non-standard size) is placed, the closest standard size may be displayed or the original size may not appear. In this event, manually set the correct original size.

► [SPECIFYING THE ORIGINAL SCAN SIZE IN PAPER SIZE \(page 4-41\)](#)

► [SPECIFYING THE ORIGINAL SCAN SIZE USING NUMERIC VALUES \(page 4-42\)](#)



**To specify the size that the machine can automatically detect:**

Select the group of detected original sizes by selecting [System Settings] in "Setting mode (administrator)" → [Common Settings] → [Device Control] → [Condition Settings] → [Original Size Detector Setting].

## List of original size detector settings

► [Detectable original sizes \(page 1-114\)](#)







# ENTERING DESTINATIONS

## ENTERING DESTINATIONS

### RETRIEVING A DESTINATION FROM AN ADDRESS BOOK

In the address book screen, simply tap the one-touch key of a registered destination to retrieve the destination. If necessary, store multiple destinations in a one-touch key. Tapping the key will retrieve all the stored destinations. The address book screen shows all destinations used in each mode. Each one-touch key shows the name of the destination and an icon indicating the mode used for the destination.

|   |                                      |
|---|--------------------------------------|
|    | Scan to E-mail                       |
|    | Scan to FTP                          |
|    | Scan to Network Folder               |
|    | Scan to Desktop                      |
|  | Group key with multiple destinations |

For the Address Book, refer to the "User's Manual (Address Book Registration)".



#### Disable Selection from Address Book

Disables the selection of destinations from the address book. Configure the setting for each of the following items:

- E-Mail
- FTP
- Desktop
- Network Folder





1

### Tap the [Address Book] key.

In Easy mode

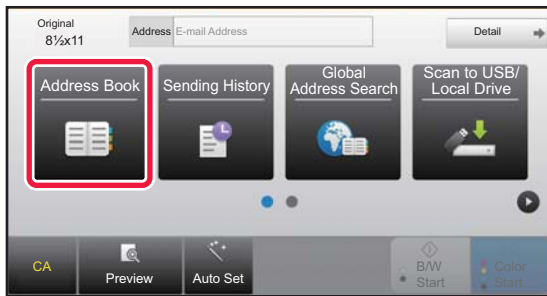

In Normal mode

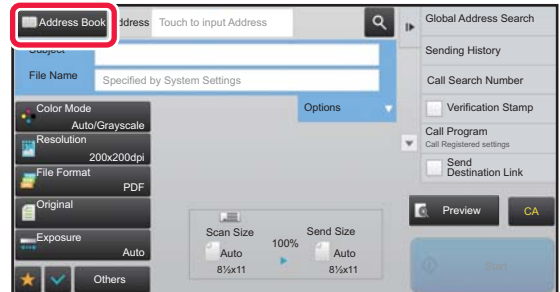

2

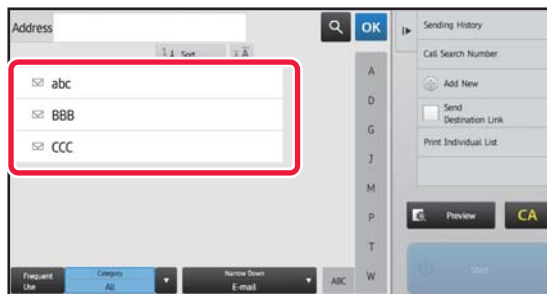

### Tap the one-touch key of contact or group that has a destination.

- The destinations displayed on the list can be narrowed with categories, frequent use, indexes, and keywords. (In normal mode you can narrow down by job type.)
- Tapping the [Sort] key allows you to change the order of destinations displayed in the list.
- When adding a destination, tap another one-touch key.
- If two or more destinations are selected or specified, the total number of addresses appears next to address.
- Even if only a single destination is selected, the number of addresses appears when the destination is a contact or group in which multiple addresses are stored.

For the Address Book, refer to the "User's Manual (Address Book Registration)".

**If you select an incorrect destination:**

Tap the key again to cancel the selection.



- To select a destination from the transmission log, tap the [Sending History] key.
  - ▶ [USING A TRANSMISSION LOG TO RESEND \(page 4-25\)](#)
- To check the entered destinations, tap the [Address Review] key.
  - ▶ [VIEWING A LIST OF THE SELECTED DESTINATIONS \(page 4-18\)](#)
- The destination for transmission can be selected by tapping a stored destination.
- If an address that you do not have permission to use is included in the addresses, a message will appear when you press the [Start] key. To send only to the permitted addresses, press the [OK] key and then the [Enter for send] key.

**In Normal mode**

- Tap the one-touch key, and then tap [Display Registered Information] on the action panel to display the detailed information screen.
- To retrieve a destination by using a search number, tap [Call Search Number] on the action panel.
  - ▶ [USING A SEARCH NUMBER TO RETRIEVE A DESTINATION \(page 4-19\)](#)
- To retrieve a destination from a global address book, tap [Global Address Search] on the action panel.
  - ▶ [RETRIEVING A DESTINATION FROM A GLOBAL ADDRESS BOOK \(page 4-23\)](#)
- Tapping [Select a Subfolder] on the action panel allows you to send to a desired folder in the following instances:
  - When only one network folder is applied to the address box  
When a hyperlink is set for a network folder destination, the document is sent to the network folder destination, however the hyperlink is not sent.
  - When only one desired contact is selected in the address book

**To cancel a specified destination:**

Select the address you want to cancel in the address list screen, and tap the [Delete] key.

**To enable transmission to addresses of modes other than the current mode:**

Remove the checkmark from [System Settings] → [Image Send Settings] → [Common Settings] → [Condition Settings] → [Address Book Default Selection] → [Apply Addresses of Sending Modes Only] in "Settings (administrator)".



## MY ADDRESS

My Address is the user's own e-mail address, and is the e-mail address that has been registered in the user list.

My Address can be used when login by login name / password is enabled in user authentication.

Use this address when you want to send a scanned image to your own e-mail address.

In E-mail mode, [Find My Address] appears on the action panel to let you immediately find and use My Address.

When you use the address book in easy scan screen or E-mail mode, the [Find My Address] button also appears at the top of the user list for easy access from the address book.



- My Address cannot be used in the following instances:
  - When address search from the user list is prohibited in the system settings
  - When user authentication is disabled, or is only by user number
  - When [Apply E-mail address of the user for login.] is enabled in [Default Address]
  - When the e-mail address of the logged in user has not been registered
  - After the [Next Address] key is pressed when [Be sure to press Next Address Key ([+]) before selecting the next address.] is enabled in System Settings - [Image Send Settings] → [Common Settings] → [Condition Settings]
  - When [S/MIME Settings] → [Disable sending to the addresses which cannot be encrypted.] is enabled in the security settings
- You can register [Find My Address] in the home screen. This is convenient when you frequently use My Address.



### Prohibit finding my address

This prohibits Find My Address.

In "Settings (administrator)", select [System Settings] → [Image Send Settings] → [Condition Settings] → [Enable/Disable Settings] → [Disabling of Find My Address].



# VIEWING A LIST OF THE SELECTED DESTINATIONS

When multiple destinations have been selected, you can display and check the destinations. You can also delete a destination from the list (cancel selection of the destination).

## 1 Tap the [Address Review] key.

In Easy mode

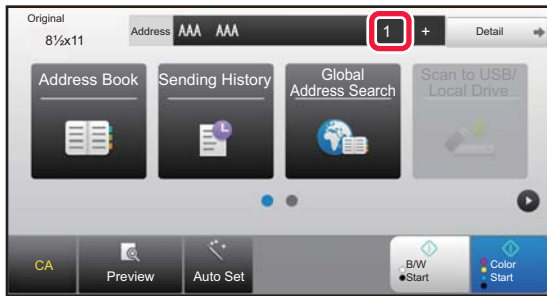

In Normal mode

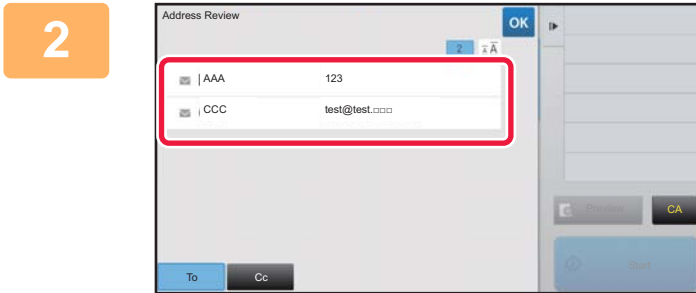
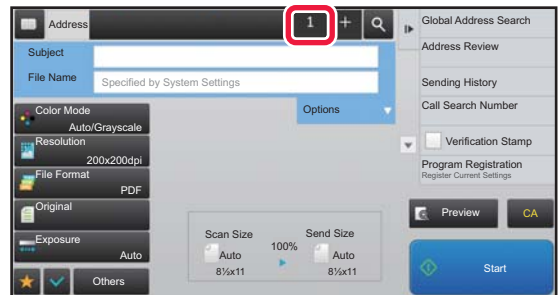

## Confirm the destination.

After the confirmation is completed, tap **OK**.



To confirm detailed information such as the type or name of the specified destination, tap the one-touch key of the target destination, and then tap the [Info.] key.  
In normal mode, you can change the delivery type (To/Cc/Bcc). Tap the address and then tap [Change to To], [Change to Cc], or [Change to Bcc] on the action panel.

## Deleting Specified Destinations

In step 2 of "VIEWING A LIST OF THE SELECTED DESTINATIONS", select the destination and tap the [Delete] key.

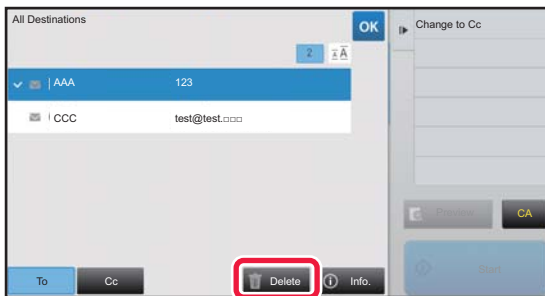

If you placed the original on the document glass and tapped the [Start] key, you cannot delete an address when changing settings.



# USING A SEARCH NUMBER TO RETRIEVE A DESTINATION

The search number can be used to specify a destination stored in an address book.

1

Tap the [Detail] key to change to normal mode.

▶ [CHANGING MODES \(page 1-13\)](#)

2

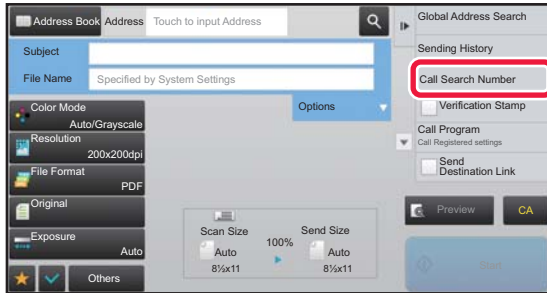

Tap [Call Search Number] on the action panel.

3



Enter a search number (4 digits) using the numeric keys and tap **OK**.

When the search number is entered, the stored address is retrieved and specified as a destination.



**If an incorrect search number is entered:**

Tap the [C] key to clear the number and enter the correct number.



- The search number is programmed when the destination is stored in the address book.
- If you do not know the search number, tap [Print Individual List] on the action panel to print and check the address list.
- When entering search numbers such as "0001" and "0011", "0" can be omitted. For example to enter "0001", enter "1" and tap the [OK] key.



# ENTERING AN ADDRESS MANUALLY



## • Prohibit sending when the address is manually entered

In "Settings (administrator)", select [System Settings] → [Image Send Settings] → [Common Settings] → [Enable/Disable Settings] → [Settings to Disable Transmission] → [Disable Direct Entry].

Prohibit manual entry of addresses.

Configure the setting for each of the following items:

- E-Mail
- Network Folder
- Specify domains to which sending is permitted

In "Settings (administrator)", select [System Settings] → [Image Send Settings] → [Scan Settings] → [Default Settings] → [Preset restriction of E-mail for direct input].

Set the domain that can be sent as the destination for e-mail. When you enter the e-mail address directly, the file will not be sent to any domain other than the specified one.

1

## In the base screen of a mode, tap [Text Box].

In easy mode, only the e-mail addresses can be entered.

### In Easy mode

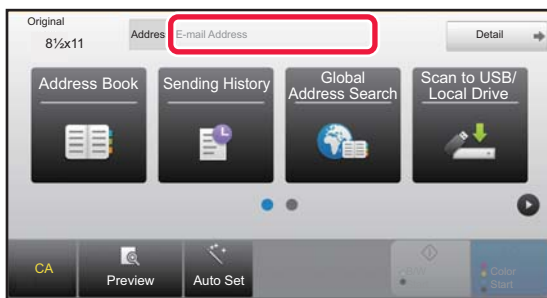

### In Normal mode

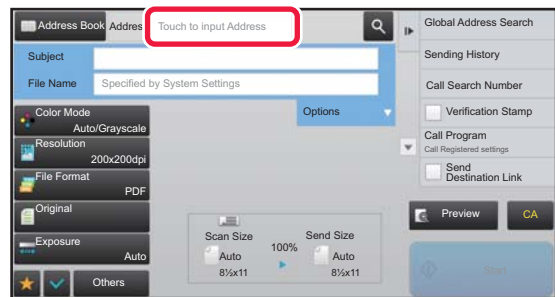

2

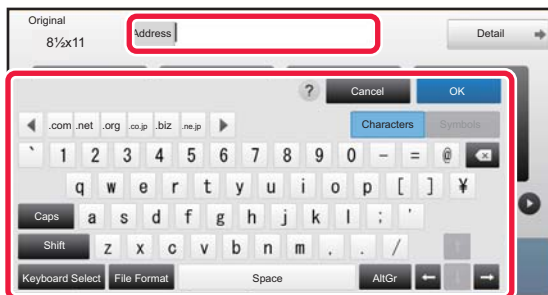

## Enter the destination address on the soft keyboard that appears.

- In data entry mode, select the mode of the destination, and enter the destination address.
- For Scan to Network Folder mode, the network folder entry screen appears. See "[SPECIFYING A NETWORK FOLDER \(page 4-21\)](#)".
- After entering the destination address, tap the [OK] key to close the soft keyboard.



To enter text, see the "User's Manual (Touch Panel Operation)".

- You can select [Bcc] if [Image Send Settings] → [Scan Settings] → [Default Settings] → [Bcc Setting] → [Enable Bcc] is enabled in [System Settings].
- When you want to display Bcc address on the job management screen or address list tab, [Image Send Settings] → [Scan Settings] → [Default Settings] → [Bcc Setting] → [Display Bcc Address on the Job Management Screen] is enabled in [System Settings].

## SPECIFYING A NETWORK FOLDER

1

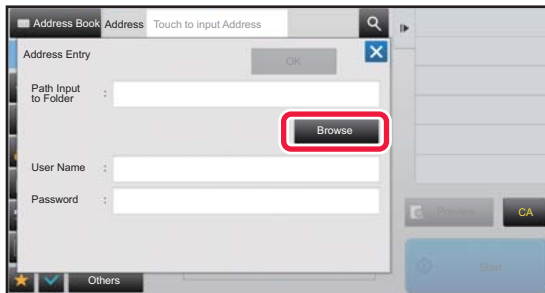

**Tap the [Browse] key in the network folder entry screen.**

- To directly enter a folder, tap the [Folder Path] box. The soft keyboard is displayed.
- If a user name and password are required, check with the administrator of the server and enter the user name and password.



To enter text, see the "User's Manual (Touch Panel Operation)".

- If a user authentication function other than authentication by user number is enabled, the login name of the current user is automatically entered in the user name field.
- Enter a password with up to 255 single-byte characters.

2

**Tap the key of the workgroup that you wish to access.**



- Tap the [Search] key and enter a keyword to search for a workgroup, server, or network folder.
- Up to 100 workgroups, 100 servers, and 100 network folders are displayed.
- Tap the [Cancel] key to return to the screen of step 1.

3

**Tap the key of the server or computer that you wish to access.**

If a screen appears prompting you to enter a user name and password, check with your server administrator and enter the appropriate user name and password.



4

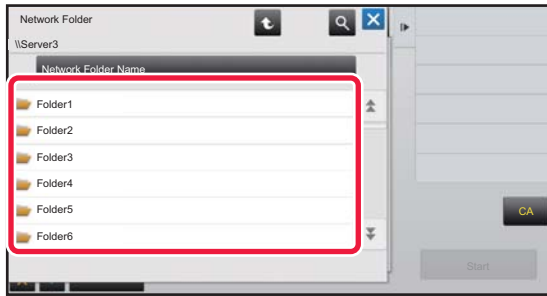

### Tap the key of the network folder.

After the settings are completed, tap the [OK] key. You will return to the screen of step 1. Tap the [OK] key again to accept the destination.





# RETRIEVING A DESTINATION FROM A GLOBAL ADDRESS BOOK

When an LDAP server is configured in the "Settings (Web version)", look up an address in a global address book and retrieve the destination address for Scan to E-mail.

In normal mode, you can add an address retrieved by searching to the address book. However, addresses of the FTP/Desktop transmission cannot be stored from the machine.

## 1 In Easy mode

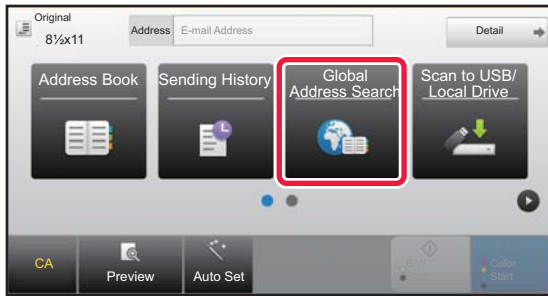

Tap the [Global Address Search] key.

## In Normal mode

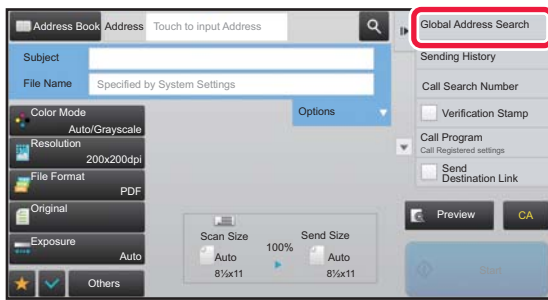

In the base screen or address book screen, tap [Global Address Search] on the action panel.

## 2

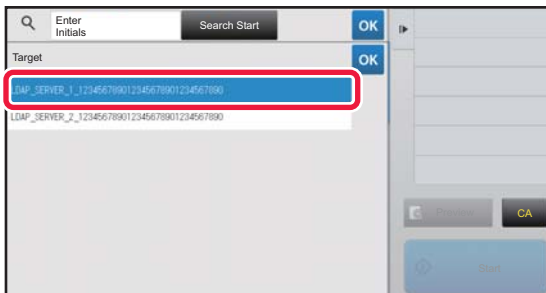

Tap [Destination] and tap the LDAP server to be used.

- If an authentication screen for the LDAP server appears, enter your user name and password.
- If only one LDAP server has been stored, it is not necessary to take step 2. In this case, start from step 3.



3



Tap of [Item], and select an item to be searched from [Name] or [Address].



**How to search**

Enter the search characters (maximum of 64 characters). The system will look for names starting with the entered letters.

An asterisk \* is used as follows:

- XXX\* : Names beginning with "XXX"
- \*XXX : Names that end with "XXX"
- \*XXX\* : Names containing "XXX"
- AA\*XX : Names that start with "AA" and end with "XX".

4

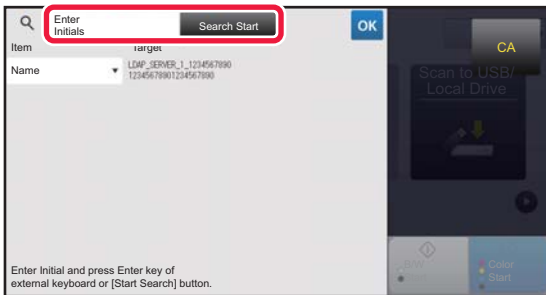

Enter a keyword and tap the [Search Start] key.

When you tap the keyword entry box, the soft keyboard appears.

The search results will appear after a brief interval.



**• If no destination is found:**

Tap the [Search Again] key to add more search letters.

**• To continuously add other destination.**

Tap the destination.



**To check the destination information:**

Tap the one-touch key of the target destination, and then tap the [Info.] key. Tap to close the address information screen.

In normal mode, you can select an address and tap [New Registration with Address Book] on the action panel to add the address to the address book. This is convenient if you have entered a destination directly.



# USING A TRANSMISSION LOG TO RESEND

Select a destination from a transmission log and resend the data.

The destinations of the most recent 50 transmissions by Scan to E-mail are stored. Select one of these to resend to that destination. The destinations of the FTP/Desktop transmission and Scan to Network Folder are also shown in the transmission log.

In normal mode, the addresses shown in the transmission log can also be stored in an address book. This is convenient when storing an address that was manually entered.



- When a destination for retransmission is selected in the transmission log screen, the mode of the selected destination is automatically selected.
- The following types of addresses are not stored for resending.
  - One-touch key for a contact or group in which multiple destinations are stored.
  - Group destinations
  - Broadcasting destinations
- The user name and password are not stored for security reasons. If a screen requiring you to enter such information appears, enter the information again.



### Prohibit using the [Resend] key

This prohibits Find My Address.

In "Settings (administrator)", select [System Settings] → [Image Send Settings] → [Condition Settings] → [Enable/Disable Settings] → [Disable [Resend] on Image Send Mode].

This setting disables the [Resend] key in the base screen of image send mode.

1

### In Easy mode

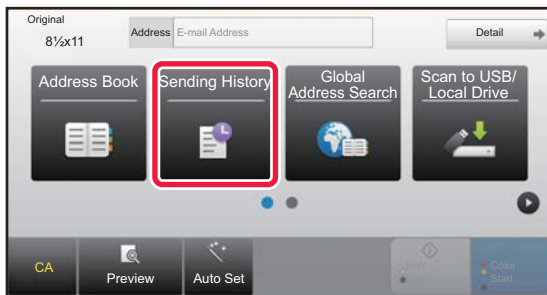

### Tap the [Sending History] key

### In Normal mode

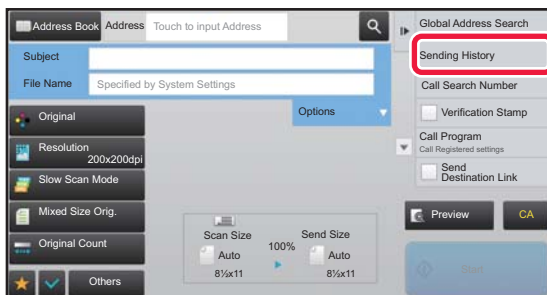

### In the base screen or address book screen, tap [Sending History] on the action panel.



2

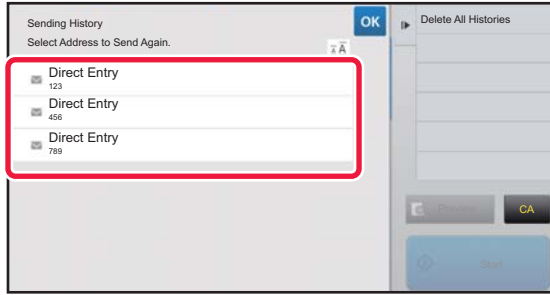

### Tap the key of the destination to resend.

The last 50 addresses used for transmission are displayed. If a screen requiring you to enter the user name and password appears, enter the information.



#### To cancel the resend setting:

Tap the highlighted key.



In normal mode, you can select an address and tap [New Registration with Address Book] on the action panel to add the address to the address book. This is convenient if you have entered a destination directly.



# SENDING ONLY THE URL OF A SCANNED FILE TO A SCAN DESTINATION

When using Scan to E-mail, some originals and/or scan settings may result in a large file.

When the file is large, there is a risk that the e-mail server may reject the file and it will not be sent.

This function saves the scanned file on the machine's local drive, and sends an e-mail providing only the file's URL information to the recipient.

This function helps reduce the load on the e-mail server and prevents non-delivery of scanned files caused by the e-mail server.

Upon receiving the e-mail, the recipient can use the URL in the e-mail to download the scanned file.

## When the scanned file is too large

### Scan to E-mail

Scanned file

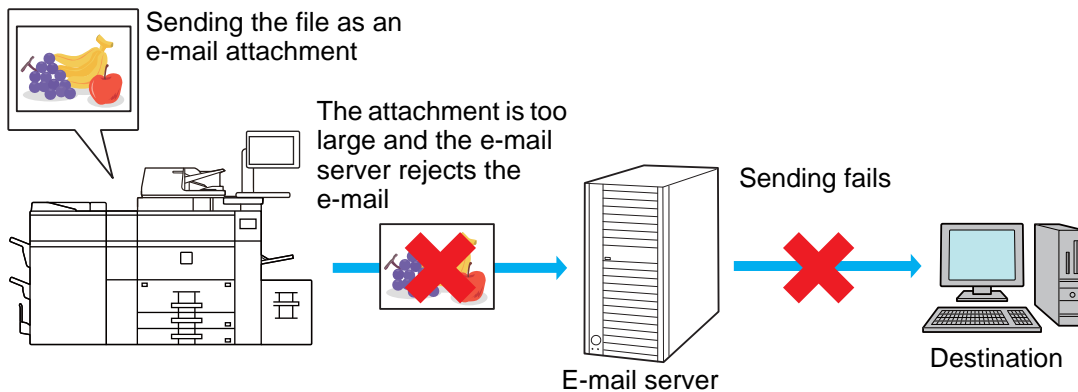

### Sending only a URL to the recipient

Scanned file

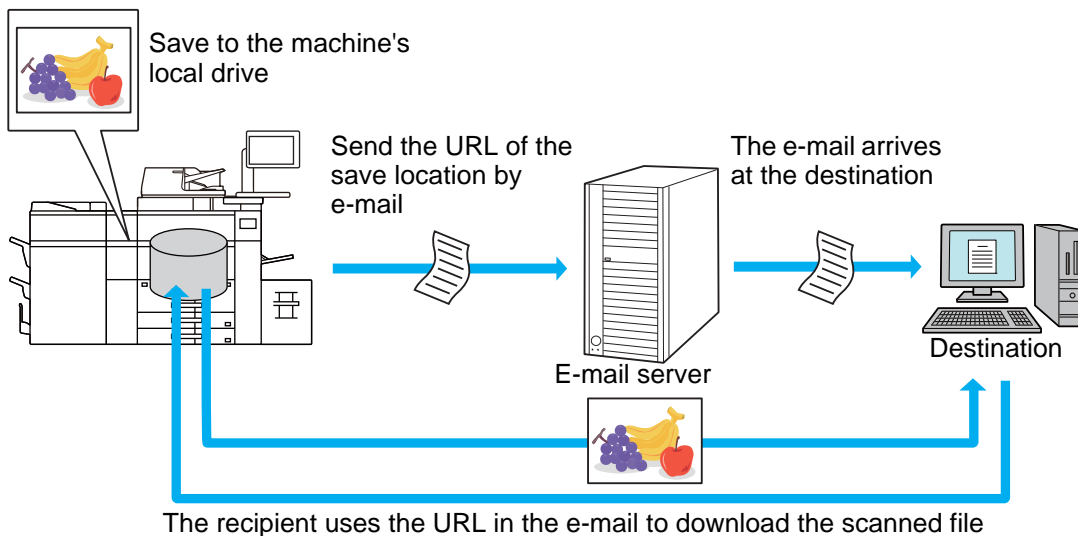



## Sending only a URL to the recipient

### Using easy mode

When [Enable Send Destination Link as Default] is enabled in the settings (administrator), the scanned data is saved in the machine's local drive, and URL information is sent to the e-mail destination. When disabled, scanned data is sent by regular Scan to E-mail. This function enable/disable cannot be changed in the easy mode screen.

### Using normal mode

[Send Destination Link] appears on the action panel of the home screen of Scan to E-mail. By selecting this checkbox , you can use this function.

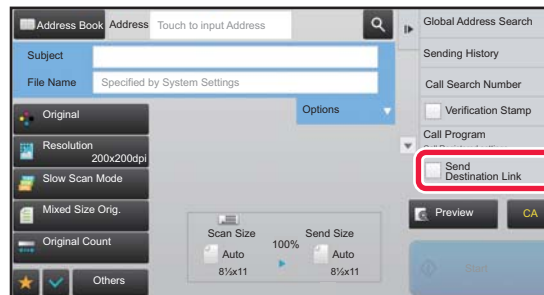

### Number of URLs created

One URL is created per file to be downloaded.

### Using [One Page per File]

Multiple scanned files will be created and saved at once, and a URL will be created for each file and sent to the recipient.

### Using [Programmed]

Files will be created and saved in a format that varies by recipient, and a URL will be created for each file. A URL will be sent to each recipient for the file in the format for that recipient.



- To use this function, [Send Destination Link Settings] must be enabled in the System Settings (administrator).
- This function cannot be used in combination with metadata transmission or resending from document filing.
- Scanned files are saved in the standard folder area.
- Scanned files cannot be browsed by a method other than downloading.
- Scanned files cannot be manually deleted, and are retained for the save period set in the System Settings. However, scanned files will be deleted if Clear All Memory or Initialize Private Data/Data in Machine is executed, or you move to Advanced Security Settings.
- When all destinations in a broadcast transmission are e-mail addresses, URL information is sent to all destinations. If the file format of the saved scan data is the same for all destinations, the same URL will be sent. If the file format varies by destination, separate URLs will be sent.
- If the transmission includes recipients for different jobs (Scan to FTP, Scan to Desktop, etc.), transmission will take place by sending only a URL to the recipient to any e-mail addresses, while the scanned file will be sent directly in the normal way to recipients for other jobs.
- When [Document Administration Function] is enabled in the System Settings (administrator), the scanned file will be sent directly to the administrator, not by URL.
- Even when [Send Destination Link Settings] is disabled in the System Settings (administrator), the URL can be accessed and the scanned file downloaded during the file save period.
- The scanned file will be saved even if a send data limit is set in the System Settings (administrator) and the file exceeds the limit. The scanned file will be saved as a single file even if [If the E-mail attachment(s) exceed maximum size, it will be sent in multiple files.] is enabled in the System Settings (administrator) and the file exceeds the limit. If there is a job other than a Scan to E-mail job in a broadcast transmission and the scanned file exceeds the [Maximum Size of Data Attachments (FTP/Desktop/Network Folder)] setting, transmission will not be possible.



- **To use this function**

Configure in "Settings (administrator)" → [System Settings] → [Image Send Settings] → [Scan Settings] → [Condition Settings] → [Send Destination Link Settings].

- **To always use this function in easy mode**

Configure in "Settings (administrator)" → [System Settings] → [Image Send Settings] → [Scan Settings] → [Condition Settings] → [Enable Send Destination Link as Default].

When this function is enabled and e-mail is sent in normal mode, the [Send Destination Link] checkbox in the action panel is always .

- **Save period for scanned files saved using this function**

Configure in "Settings (administrator)" → [System Settings] → [Image Send Settings] → [Scan Settings] → [Condition Settings] → [File Retention Period].

- **Protecting the URL by SSL**

Configure in "Settings (administrator)" → [System Settings] → [Image Send Settings] → [Scan Settings] → [Condition Settings] → [Enable SSL].

## Setting a data limit for sending

Sometimes an unlimited amount of data cannot be sent due to network conditions or the amount of storage space in the email server or file server. Set a data limit for sending and how the data will be sent if the limit is exceeded.

In "Settings (administrator)" - [System Settings] - [Image Send Settings] - [Scan Settings] - [Condition Settings] - [Maximum Size of E-mail Attachments(E-Mail)], [Maximum Size of Data Attachments(FTP/Desktop/Network Folder)].

### Maximum Size of E-mail Attachments(E-Mail)

To prevent the transmission of excessively large image files by Scan to E-mail, a file size limit can be set from 1 MB to 99 MB in increments of 1 MB. If the total size of the image files created by scanning the original exceeds the limit, the image files are discarded.

If you do not wish to set a limit, select [Unlimited].

#### If the E-mail attachment(s) exceed maximum size, it will be sent in multiple files.

If an E-mail attachment exceeds the maximum size, it will be sent in multiple files. If one of the divided files exceeds the maximum size, it will be sent with the resolution automatically lowered.

When sending files in JPEG format, only one file is attached to one e-mail, regardless of the file size.

If a file scanned in TXT(UTF-8), RTF, DOCX, XLSX, or PPTX format exceeds the file size limit, the file will be discarded without being sent even if this setting is selected.



- When a file scanned to a format other than TXT(UTF-8), RTF, DOCX, XLSX, or PPTX exceeds the size limit, this function reduces the data size below the limit by lowering the resolution or other means, and thereby enables sending without canceling the data.
- When Multicrop, Image Crop, Send Destination Link and Card Shot are used, the scanned data is not divided.
- If the e-mail exceeds the set size limit, a send error occurs.

### Maximum Size of Data Attachments(FTP/Desktop/Network Folder)

A limit can be set for the size of files that can be sent by Scan to FTP, Scan to Desktop, and Scan to Network Folder. Limits that can be selected are 50 MB, 150 MB, and 300 MB. If the total size of the image files created by scanning the original exceeds the limit, the image files are discarded.

If you do not wish to set a limit, select [Unlimited].



# TRANSMITTING AN IMAGE

## TRANSMITTING AN IMAGE

### SENDING AN IMAGE IN SCAN MODE

An image can be sent in scan mode (Scan to E-mail, Scan to FTP, Scan to Desktop, and Scan to Network Folder).



- If the memory becomes full while the originals are being scanned, a message will appear and scanning will stop.
- When performing Scan to E-mail, take care not to send a file that is too large. In particular, multi-page files tend to be large. When sending a multi-page file or other large file, it may be necessary to reduce the number of scanned pages or reduce the send size.



Do not place any objects under the original size detector. Closing the automatic document feeder with an object underneath may damage the original size detector plate and prevent correct detection of the document size.

**1**





#### Place the original.



Place the original in the document feeder tray of the automatic document feeder, or on the document glass.

- ▶ [AUTOMATIC DOCUMENT FEEDER \(page 1-116\)](#)
- ▶ [DOCUMENT GLASS \(page 1-120\)](#)

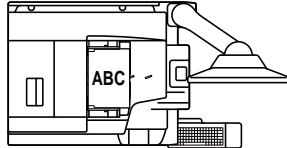
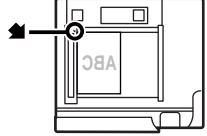

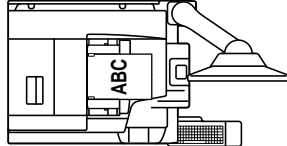
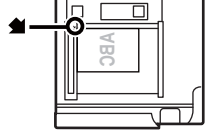
- When placing the originals, orient them as shown below.  
To place a large portrait-oriented original, place it as shown in the figure titled "Landscape orientation" and specify the placement orientation in step 4.

| Originals  | Document feeder tray<br>Place the original face up.                                 | Document glass<br>Place the original face down and align the corner with the tip of the  mark in the top left corner of the document glass scale. |
|--|---|--|
| Portrait orientation<br>  |  |   |
| Landscape orientation<br> |  |   |

- Place 5-1/2" x 8-1/2" (A5) size originals in portrait (vertical) orientation (  ). If placed in landscape (horizontal) orientation (  ), an incorrect size will be detected. For an 5-1/2" x 8-1/2"R (A5R) size original, enter the original size manually.





## 2

**Specify the destination.**

- ▶ [RETRIEVING A DESTINATION FROM AN ADDRESS BOOK \(page 4-14\)](#)
- ▶ [VIEWING A LIST OF THE SELECTED DESTINATIONS \(page 4-18\)](#)
- ▶ [USING A SEARCH NUMBER TO RETRIEVE A DESTINATION \(page 4-19\)](#)
- ▶ [ENTERING AN ADDRESS MANUALLY \(page 4-20\)](#)
- ▶ [SPECIFYING A NETWORK FOLDER \(page 4-21\)](#)
- ▶ [RETRIEVING A DESTINATION FROM A GLOBAL ADDRESS BOOK \(page 4-23\)](#)
- ▶ [USING A TRANSMISSION LOG TO RESEND \(page 4-25\)](#)

The icon on the key indicates the type of destination stored in the key.

- Scan to E-mail
- Scan to FTP
- Scan to Network Folder
- Scan to Desktop



- After a one-touch key is tapped, if the screen is changed without tapping **+**, the destination of the tapped key is automatically specified.
- When performing Scan to E-mail, you can also send Cc or Bcc copies to other destinations. Tap the [Address Review] key to select destinations.
  - ▶ [VIEWING A LIST OF THE SELECTED DESTINATIONS \(page 4-18\)](#)
- Multiple destinations can be specified.
- To change [Subject], [File Name], [Reply-To], or [Body Text] in normal mode, tap a target entry box, or tap [Options].
  - ▶ [CHANGING THE SUBJECT, FILE NAME, REPLY-TO, AND BODY TEXT AT THE TIME OF SCAN TRANSMISSION \(page 4-33\)](#)

## 3

**Tap the [Original] key.**

## 4

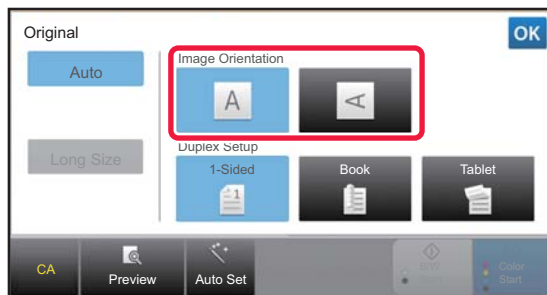
**Tap the appropriate orientation key.**

Specify the orientation of the original placed in step 1. After the settings are completed, tap **OK**.



- You can change exposure, resolution, file format, color mode, and other settings.
  - ▶ [AUTOMATICALLY SCANNING BOTH SIDES OF AN ORIGINAL \(2-SIDED ORIGINAL\) \(page 4-39\)](#)
  - ▶ [SCAN SIZE AND SEND SIZE \(ENLARGE/REDUCE\) \(page 4-40\)](#)
  - ▶ [CHANGING THE EXPOSURE AND ORIGINAL IMAGE TYPE \(page 4-48\)](#)
  - ▶ [CHANGING THE RESOLUTION \(page 4-50\)](#)
  - ▶ [CHANGING FORMAT IN SCAN OR DATA ENTRY MODE \(page 4-51\)](#)
  - ▶ [CHANGING COLOR MODE \(page 4-56\)](#)
- Tapping the [Others] key allows you to configure various functions, for example, collectively sending two original pages as one sheet or original pages with different sizes.



5

**Tap the [B/W Start] or [Color Start] key to start scanning of the original.**

- If the original was inserted in the document feeder tray, a beep will sound when scanning is completed and transmission will take place.
- If the original is placed on the document glass, the [Read-End] key appears in the touch panel. If the original is only one page, go to step 7. To scan more pages, go to step 6.



- You can tap the [Preview] key to check a preview of the image before sending an image. For more information, see "[CHECKING THE IMAGE TO BE TRANSMITTED \(page 4-58\)](#)".
- If the file format is set to [PDF/Encry.], [PDF/Encry./Bk Letter Emphasis], [PDF/Encry./Compact], or [PDF/Encry./Compact/U-Fine], you will be prompted to enter the password when you tap the [B/W Start] or [Color Start] key.  
Tap the password entry box to open the keyboard screen, enter a password using a maximum of 32 characters, and tap the [OK] and [Send] key in sequence. The recipient must use the password entered here to open the Encrypt PDF file.  
To cancel Encrypt PDF, tap the [Cancel] key. The format settings screen will appear to let you change the file type. Select a new file type and tap the [B/W Start] or [Color Start] key to begin transmission.

6

**If the original was placed on the document glass, replace it with the next original and tap the [B/W Start] or [Color Start] key.**

Repeat until all originals have been scanned.

7

**Tap the [Read-End] key.**

A beep will sound to indicate that the operation is completed.



- If no action is taken for one minute after the confirmation screen is displayed, scanning automatically ends and the transmission is reserved.
- Tap the [Change Setting] key to change the exposure, resolution, scan size, and send size for each original page scanned. However, when "Card Shot" is selected in Others, change only the exposure when scanning an even-numbered original page.



- **To change the time until transmission takes place automatically:**  
Select "Settings (administrator)" - [System Settings] → [Image Send Settings] → [Common Settings] → [Condition Settings] → [Job Auto Start Time During Scanning].
- **To set the scan complete sound:**  
In "Settings (administrator)", select [System Settings] → [Sound Settings] → [Beep Sound Settings (Common)] → [Scan Complete Sound (Image Send)].
- **Change the initial screen to the address book**  
In "Settings (administrator)", select [System Settings] → [Image Send Settings] → [Common Settings] → [Condition Settings] → [Default Display Settings].  
If image send mode is enabled, the Address Book is displayed in place of the initial screen of this mode.  
When a default address is set in "Settings (administrator)" - [System Settings] → [Image Send Settings] → [Common Settings] → [Condition Settings] → [Default Address Settings], this function cannot be used.
- **Retain send settings for a set time after transmission**  
In "Settings (administrator)", select [System Settings] → [System Settings] → [Image Send Settings] → [Common Settings] → [Condition Settings] → [Hold settings for a while after scanning has been completed].  
The settings will be retained after the original is scanned (until auto clear mode operates).



# CHANGING THE SUBJECT, FILE NAME, REPLY-TO, AND BODY TEXT AT THE TIME OF SCAN TRANSMISSION

Change the subject, file name, reply-to, and body text when performing a scan transmission. If necessary, directly enter the text.



- When performing Scan to FTP, Scan to Desktop, or Scan to Network Folder, only the file name is used.
- If the subject or file name is not changed, the settings in [System Settings] → [Image Send Settings] → [Scan Settings] → [Subject Name Settings], [File Name Settings], and [Message Body Settings] in "Settings (administrator)" are used.
- If the reply-to address is not changed, the settings in [System Settings] → [Image Send Settings] → [Scan Settings] → [Condition Settings] → [Default Reply.Address Set] in "Settings (administrator)" are used. If this is not configured, the reply address configured in [Network Settings] → [Services Settings] → [SMTP] → [Sender Address] in the "Settings" is used. (Administrator rights are required.)
- To configure the candidates for the subject, file name, and body text, select [System Settings] → [Image Send Settings] → [Scan Settings] in "Settings (administrator)".
- To enter text, see the "User's Manual (Touch Panel Operation)".

1

Tap the [Detail] key to change to normal mode.

► [CHANGING MODES \(page 1-13\)](#)

2

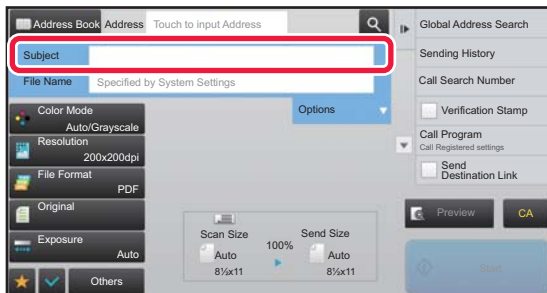

To change the subject, tap the [Subject] entry box.

3

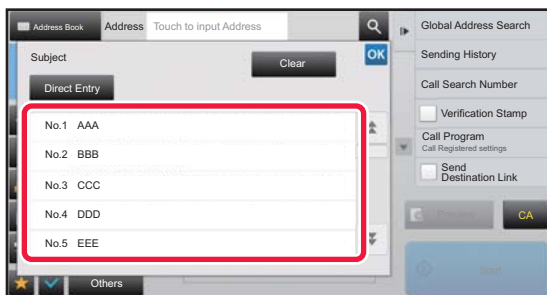

Tap a pre-set text key.

After the settings are completed, tap **OK**.



To cancel the selection of the subject:

Tap the [Clear] key.



If you wish to directly enter the text, tap the [Direct Entry] key to open the soft keyboard.

Enter the text and tap the [OK] key.



4

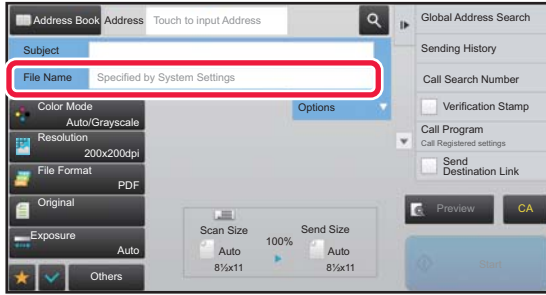

### To change the file name, tap the [File Name] entry box.

After the settings are completed, tap **OK**.

- Tap the key of the file name from the list.
- To directly enter the file name, tap the [Direct Entry] key.
- A prompt is displayed in the file name. The prompt is changed according to the settings. If the settings are not changed, "Following the System Settings" is displayed.
- In [OCR Setting], if [File Name Auto Extraction] is enabled, "File Name Auto Extraction" will be displayed.



When scanning to a shared folder, if you set a file name that is the same as an existing file name in the shared folder, the file name will be changed to prevent overwriting of the existing file.

5

### Tap [Options].

6

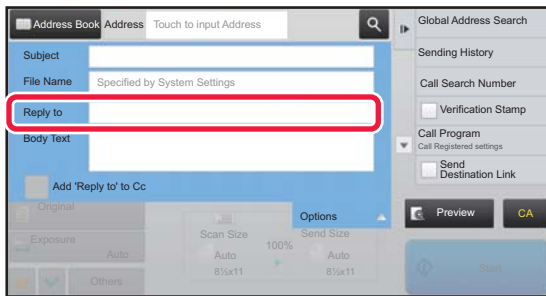

### To change the reply address, tap the [Reply-To] entry box.



If user authentication is being used, the information of the user that logged in will be applied, and thus the reply address cannot be changed.

7

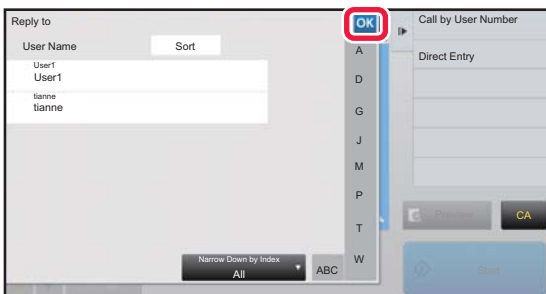

### Tap the key that you wish to use for the reply address.

After the settings are completed, tap **OK**.

- You can select addresses from the user list in the same way as you would select the reply address. You can also tap [Global Address Search] on the action panel to specify a user stored in the global address book as the reply address.
- Tapping [Direct Entry] on the action panel allows you to directly enter the e-mail address.
- Selecting the [Add 'Reply to' to Cc] checkbox to  adds a reply address to the Cc address.



8

To change the body text, tap the [Body Text] entry box.

9

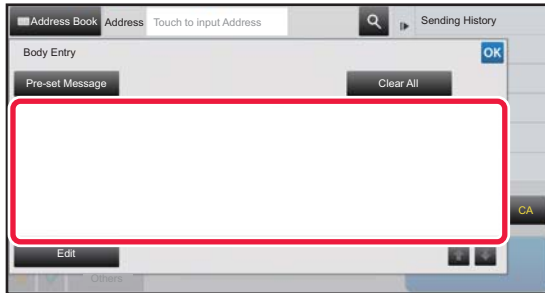

### Enter the body text.

After the settings are completed, tap **OK**.

- To select a pre-set text previously stored in the Setting mode (Web version), tap the [Pre-set Message] key.
- To directly enter the body text, tap the [Edit] key.



#### To clear all entered text:

Tap the [Clear All] key. When this key is tapped, the entire body of the message is erased immediately, not just the selected line.



- Enter up to 1800 characters. (A line break counts as one character.)
- To edit the selected line, tap the [Edit] key. The soft keyboard will appear with the selected text entered.



## SENDING THE SAME IMAGE TO MULTIPLE DESTINATIONS (BROADCAST TRANSMISSION)

Send the same scanned image to multiple scan mode destinations in a single operation.

One operation allows you to send data to up to 500 destinations, including the reserved send jobs. (For example, if broadcast transmission jobs with 450 destinations are already reserved, data can be broadcasted to up to 50 destinations.)

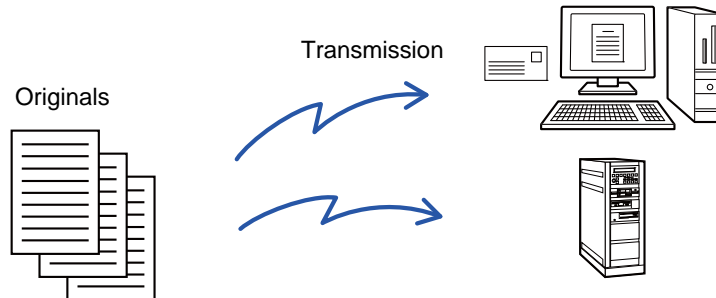

It is convenient to store destinations you frequently use for broadcast transmission as contacts or groups.

A maximum of 500 destinations can be stored in one contact.

For broadcast transmission, the contact or group key can be simply tapped to retrieve multiple numbers.

You can also send scanned images with the one-touch key by setting the [Set as Default used] checkbox to  when addresses are registered. If you wish to temporarily remove a destination from the stored addresses, open the detail confirmation screen and remove the destination in the screen.

► [USING A TRANSMISSION LOG TO RESEND \(page 4-25\)](#)



When the checkbox of "Settings (administrator)" -[System Settings] → [Image Send Settings] → [Common Settings] → [Condition Settings] → [Address Book Default Selection] → [Apply Addresses of Sending Modes Only] is set to  (factory default setting), the image is only sent to those destinations among the destinations that are set to [Set as Default used] which are for the currently selected mode. If the checkmark is removed , the image can also be sent to destinations of other modes.



A transmission is performed, ignoring hyperlinks with Scan to FTP and Scan to Network Folder addresses.



### To register destinations in a contact or group:

In the address book screen, tap [Add New] on the action panel, or tap the [Address Control] icon in the home screen. For the Address Book, refer to the "User's Manual (Address Book Registration)".



1

**Place the original.**

Place the original in the document feeder tray of the automatic document feeder, or on the document glass.

- ▶ [AUTOMATIC DOCUMENT FEEDER \(page 1-116\)](#)
- ▶ [DOCUMENT GLASS \(page 1-120\)](#)

2

**Specify all destinations.**

- ▶ [RETRIEVING A DESTINATION FROM AN ADDRESS BOOK \(page 4-14\)](#)
- ▶ [VIEWING A LIST OF THE SELECTED DESTINATIONS \(page 4-18\)](#)
- ▶ [USING A SEARCH NUMBER TO RETRIEVE A DESTINATION \(page 4-19\)](#)
- ▶ [ENTERING AN ADDRESS MANUALLY \(page 4-20\)](#)
- ▶ [SPECIFYING A NETWORK FOLDER \(page 4-21\)](#)
- ▶ [RETRIEVING A DESTINATION FROM A GLOBAL ADDRESS BOOK \(page 4-23\)](#)
- ▶ [USING A TRANSMISSION LOG TO RESEND \(page 4-25\)](#)



- One-touch keys that cannot be used for broadcast transmission are grayed out to prevent selection.
- If a Scan to FTP or Network Folder address is specified in a broadcast transmission, hyperlink e-mail transmission will not take place.



- If [System Settings] → [Image Send Settings] → [Common Settings] → [Condition Settings] → [Be sure to press Next Address Key ([+]) before selecting the next address.] is enabled in "Settings (administrator)", tap **+** before specifying the next destination.

3

**Tap [Address Review] on the action panel.**

4

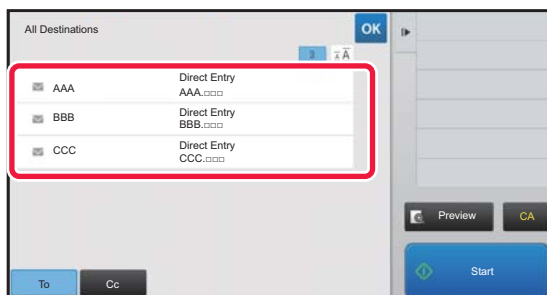
**Confirm the destination.**

- **To cancel a specified destination:**  
Tap the key of the destination that you wish to cancel to release the selection.
- **To switch delivery types (To/Cc/Bcc):**  
Tap the address that you want to change, and tap [Change to To], [Change to Cc], or [Change to Bcc] on the action panel.



5

**Tap the [B/W Start] or [Color Start] key ([Start] key in normal mode) to start scanning of the original.**

- If you inserted the original pages in the document feeder tray, all pages are scanned. A beep will sound to indicate that scanning and transmission have ended.
- When you place the original on the document glass, scan each page at a time. When scanning finishes, place the next original and tap the [B/W Start] or [Color Start] key ([Start] key in normal mode). Repeat until all pages have been scanned and then tap the [Read-End] key. A beep will sound to indicate that transmission has ended.



You can tap the [Preview] key to check a preview of the image before sending an image. For more information, see "[CHECKING THE IMAGE TO BE TRANSMITTED \(page 4-58\)](#)".





# IMAGE SETTINGS

## AUTOMATICALLY SCANNING BOTH SIDES OF AN ORIGINAL (2-SIDED ORIGINAL)

The automatic document feeder is used to automatically scan both sides of an original.

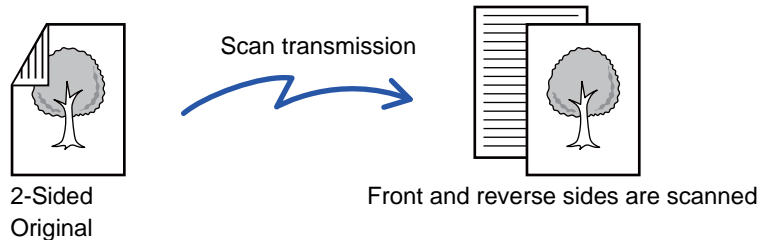

The settings on 2-sided scanning are cleared when transmission has completed.



You cannot use 2-Sided scanning when the original size is set to Long Size.

1

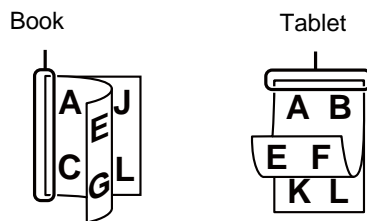

After tapping the [Original] key, tap the [Book] or [Tablet] key.

See the figure on the left to check the binding edge of the original and select the key to be tapped.



In normal mode, tap the [2-Sided Tablet] or [2-Sided Book] key.

2

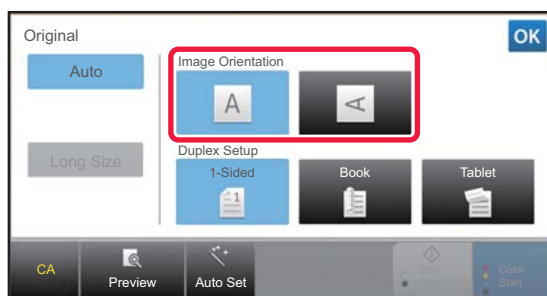

Tap the [Image Orientation] key with the same orientation as the placed original.

If this setting is not correct, a suitable image may not be transmitted.

After the settings are completed, tap **OK**.



**To cancel 2-sided scanning:**

Tap the [1-Sided] key.

In normal mode, tap the [2-Sided Tablet] key or the [2-Sided Book] key that has been forcibly displayed and cancel the display.



# SCAN SIZE AND SEND SIZE (ENLARGE/REDUCE)

When the original is placed, its size is automatically detected.

In normal mode, the size of the placed original is indicated as the "Scan Size", and the size to be transmitted is indicated as the "Send Size".

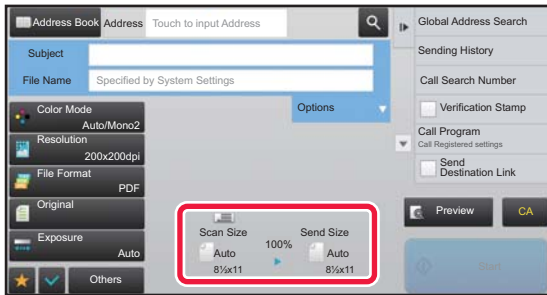

In the above screen, the scan size (the placed original) is 8-1/2" x 11" (A4) and the send size is auto. For example, if the scan size is 8-1/2" x 11" (A4) and the send size is 5-1/2" x 8-1/2" (B5), the image will be reduced before transmission.

Scan Size

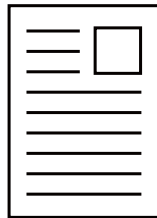

A4

"Send Size" is set to 5-1/2" x 8-1/2" (B5)

Transmission  
→



The image is reduced to 5-1/2" x 8-1/2" (B5) before transmission



- Only standard original sizes can be automatically detected.
  - ▶ [THE SIZE OF THE PLACED ORIGINAL \(page 4-13\)](#)
- When the original size is an inch size or a non-standard size, or if the size is not detected correctly, manually specify the original scan size.
  - ▶ [SPECIFYING THE ORIGINAL SCAN SIZE IN PAPER SIZE \(page 4-41\)](#)
  - ▶ [SPECIFYING THE ORIGINAL SCAN SIZE USING NUMERIC VALUES \(page 4-42\)](#)



# SPECIFYING THE ORIGINAL SCAN SIZE IN PAPER SIZE

When the original size is a non-standard size or is not detected correctly, manually specify the original size.



When [Long Size] is selected, the 2-sided scanning setting and send size cannot be changed. The image is sent in Mono2 only.

1

Tap the [Detail] key to change to normal mode.

► [CHANGING MODES \(page 1-13\)](#)

2

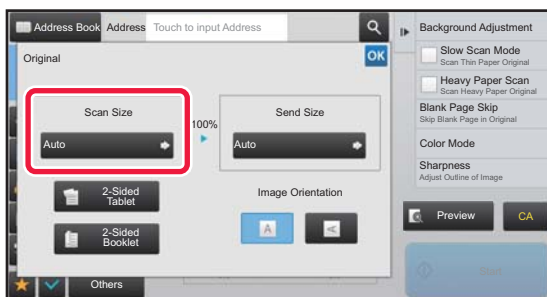

After tapping the [Original] key, tap the [Scan Size] key.

3



Tap the appropriate original size key.

After the settings are completed, tap **OK**.



If you are sending a long original, tap the [Long Size] key.

Use the automatic document feeder to scan a long original. The maximum width that can be scanned is 1,000 mm (39-3/8") (the maximum height is 297 mm (11-5/8")).

► [TRANSMITTABLE ORIGINAL SIZES \(page 4-13\)](#)



# SPECIFYING THE ORIGINAL SCAN SIZE USING NUMERIC VALUES

When scanning a non-standard size original such as a card or postcard, specify the original size using numeric values after placing the original.

The width can be from 1" to 17" (25 mm to 432 mm), and the height can be from 1" to 11-5/8" (25 mm to 297 mm).



When the scan size is specified by numeric values, the send size cannot be specified.

1

Tap the [Detail] key to change to normal mode.

► [CHANGING MODES \(page 1-13\)](#)

2

Tap the [Original] key.

3

After tapping the "Scan Size" key, tap the [Direct Entry] key.

4

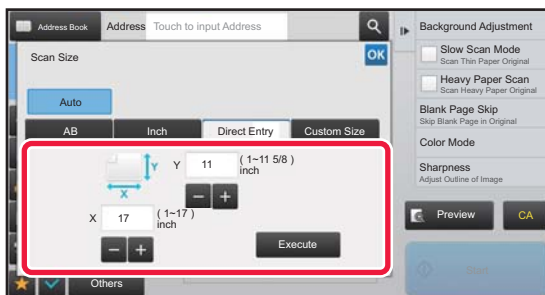

Specify the original size.



- Tap the areas displaying width and height sizes respectively, and enter the sizes using the numeric keys.
- It is convenient to use **- +** to finely adjust the entered size.

5

Tap the [Execute] key.

After the settings are completed, tap **OK** twice.

On the base screen, check that the specified size is displayed on the [Original] key.



**To cancel the specified size settings:**

Tap the [Auto] key.



# STORING FREQUENTLY USED ORIGINAL SIZES

Store the frequently used non-standard original sizes. This section explains how to store, retrieve, change, and delete non-standard original sizes.



- The stored original size will be retained even if the main power is turned off.
- A total of up to 12 non-standard original sizes can be registered for copying, image sending.
- The added original sizes will also appear in other modes.

## Storing original sizes (Modify/Delete)

1

Tap the [Detail] key to change to normal mode.

► [CHANGING MODES \(page 1-13\)](#)

2

Tap the [Original] key.

3

Tap the [Scan Size] key and tap the [Custom Size] tab.

4

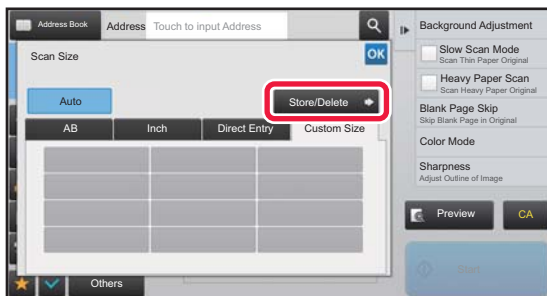

Tap [Store/Delete] key.



5

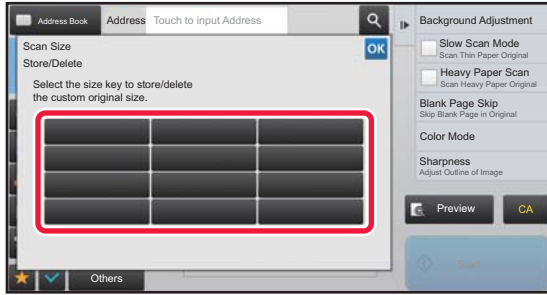

Tap a key ( ) for storing a custom original size.

Tap a key that does not show a size.



**To modify or delete a previously stored key:**

Tap the key that you want to modify or delete. The following screen will appear.

- To modify the key, tap the [Modify] key and go to the next step.
- To delete the key, tap the [Delete] key. Make sure that the original size has been cleared and tap the [OK] key.

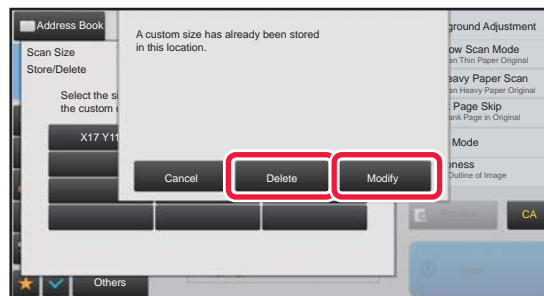

6



**Specify the original size.**

Tap the areas displaying width and height sizes respectively, and enter the sizes using the numeric keys.



It is convenient to use - + to finely adjust the entered size.

7

**Tap the [Execute] key.**

Tap the [OK] key, and check that the key of the size stored on the Scan Size screen is added properly. After you have checked it, tap [OK].



**To cancel the operation:**

Tap the [CA] key.



## Retrieving a stored original size

1

Tap the [Detail] key to change to normal mode.

► [CHANGING MODES \(page 1-13\)](#)

2

Tap the [Original] key.

3

Tap the [Scan Size] key and tap the [Custom Size] tab.

4

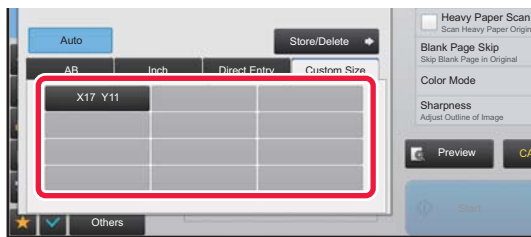

Tap the key of the original size that you wish to retrieve.

After selecting the key of the original size, tap the **OK** key. Check that the specified size is displayed on the Scan Size screen.



**To cancel the operation**

Tap the [CA] key.



## SPECIFYING THE SEND SIZE OF THE IMAGE

Tap this key to specify the send size as a paper size. If the specified send size is larger than the scan size, the image will be enlarged. If the specified send size is smaller than the scan size, the image will be reduced.



The send size cannot be specified when [Long Size] is selected for the scan size, or when the scan size is specified by numeric values.

1

Tap the [Detail] key to change to normal mode.

► [CHANGING MODES \(page 1-13\)](#)

2

Tap the [Original] key.

3

Tap the [Send Size] key.

4

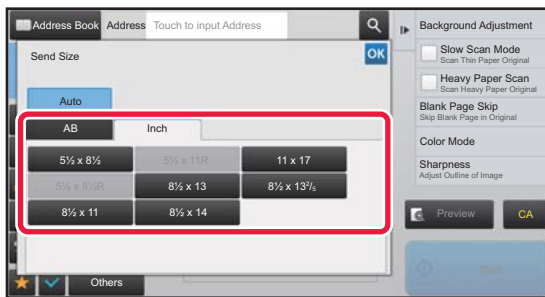

Tap the desired send size key.

After the settings are completed, tap **OK**.



Depending on the paper size specified for the "Scan Size", it may not be possible to select some sizes for the "Send Size". You cannot tap size keys that are unavailable for the "Send Size".





5

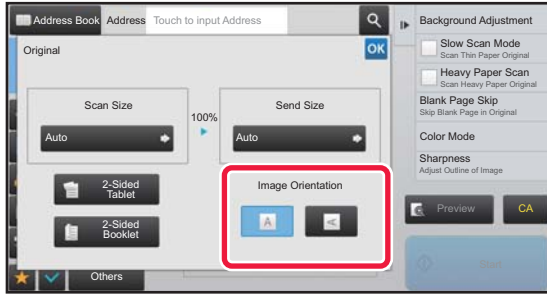

**Tap the [Image Orientation] key with the same orientation as the original image.**

If this setting is not correct, a suitable image may not be transmitted. After the settings are completed, tap **OK**.



To configure the default setting of image orientation, select [System Settings] → [Image Send Settings] → [Common Settings] → [Condition Settings] → [Image Orientation] in "Settings (administrator)".



The ratio used for reduction or enlargement of the original will appear between the "Scan Size" and the "Send Size".



# CHANGING THE EXPOSURE AND ORIGINAL IMAGE TYPE

Optimum scanning is ensured by selecting exposure and original image type based on the original.



When using the document glass to scan multiple original pages, change the exposure setting each time you change pages.



When using the automatic document feeder, the exposure setting cannot be changed once scanning has begun. (If "Job Build" is used in Others, change the exposure each time a new set of originals is inserted.)



## • Set the default contrast

In "Settings (administrator)", select [System Settings] → [Image Send Settings] → [Common Settings] → [Default Settings] → [Default Exposure Settings].

Select [Auto] or [Manual]. When [Manual] is selected, set the contrast to one of five levels. When set to [Auto], the contrast cannot be selected.

## • Set the default document settings

In "Settings (administrator)", select [System Settings] → [Image Send Settings] → [Common Settings] → [Condition Settings] → [Default Original Image Type].

Select the original type beforehand to enable scanning at a resolution suitable for the original (only in scan mode and USB memory device scan mode).

The following settings can be configured.

- Text/Printed Photo
- Text/Photo
- Text
- Photo
- Printed Photo
- Map

## Exposure settings

| Exposure |     | Suggestion  |
|----------|-----|---|
| Auto     |     | This setting automatically adjusts the exposure for light and dark parts of the original. |
| Manual   | 1-2 | Select this setting when the original consists of dark text.                              |
|          | 3   | Select this setting for a normal original (neither dark nor light).                       |
|          | 4-5 | Select this setting when the original consists of light text.                             |

## How to select the original type (Scan mode, Data entry mode)

| Setup Items |                    | Description  |
|-------------|--------------------|--|
| Auto        |                    | The original image type is automatically selected to match the original.   |
| Manual      | Text/Printed Photo | This mode provides the best balance for scanning an original which contains both text and printed photographs, such as a magazine or catalogue.        |
|             | Text/Photo         | This mode provides the best balance for scanning an original which contains both text and photographs, such as a text document with a photo pasted on. |
|             | Text               | Use this mode for regular text documents.  |
|             | Photo              | Use this mode to scan photos.  |
|             | Printed Photo      | This mode is best for scanning printed photographs, such as photos in a magazine or catalogue.   |
|             | Map                | This mode is best for copying maps with light color shading and fine text.   |



## In Scan mode or Data entry mode

1

Tap the [Detail] key to change to normal mode.

► [CHANGING MODES \(page 1-13\)](#)

2

Tap the [Exposure] key.

3

Tap the key assigned to the original type you wish to set based on the original type.

4

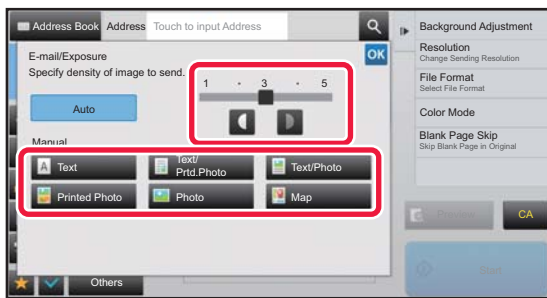

Tap   to adjust the exposure.

After the settings are completed, tap .



When [Auto] is selected, changing the exposure sets the original image type to [Text/Printed Photo] automatically.



# CHANGING THE RESOLUTION

Specify the resolution setting.

## How to select the resolution

For normal text originals, 200 x 200 dpi produces an image that is sufficiently legible.

For photos and illustrations, a high resolution setting (600 x 600 dpi, etc.) will produce a sharp image.

However, a high resolution setting will result in a large file, and if the file is too large, transmission may not be possible. In this event, reduce the number of pages scanned or take other measures to decrease the file size.

► [CHANGING FORMAT IN SCAN OR DATA ENTRY MODE \(page 4-51\)](#)

 When using the automatic document feeder, the resolution setting cannot be changed after scanning has begun. (However, when "Job Build" is used in Others, change the resolution each time a new set of originals is inserted.)

 When using the document glass to scan multiple original pages, change the resolution setting each time you change pages.

1

Tap the [Detail] key to change to normal mode.

► [CHANGING MODES \(page 1-13\)](#)

2

Tap the [Resolution] key.

3

Tap the key of the desired resolution.

After the settings are completed, tap **OK**.

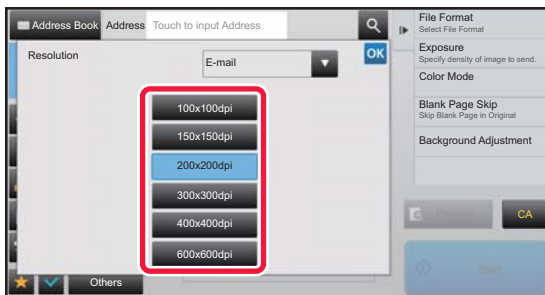

- If there is a mix of destinations in different modes, tap  to switch modes to set the resolution in each mode. However, FTP/Desktop and Network Folder are set to the same mode.
- If the compression ratio is set to [Bk Letter Emphasis], the resolution will be set to [300x300dpi].
- If the file format in [File Format] is set to [Compact PDF], then this will set the resolution set in "Compact PDF Resolution Setting" in system settings.



# CHANGING FORMAT IN SCAN OR DATA ENTRY MODE

Change the file format (file type and compression mode/compression ratio) for sending a scanned image at the time of transmission. In addition, if the scanned originals are divided into separate files, the number of pages per file can be changed.



The file type of [B/W] mode and the file type of [Color/Grayscale] mode are linked. The file type cannot be set separately for each. (When [JPEG] is selected for [Color/Grayscale] mode, [TIFF] is automatically selected for [B/W] mode.)

## File format combinations

| [Color/Grayscale] tab             | [B/W] tab    |
|-----------------------------------|--------------|
| PDF*                              | PDF*         |
| Compact PDF*                      | PDF*         |
| Compact PDF (Ultra Fine)*         | PDF*         |
| PDF/A-1a*                         | PDF/A-1a*    |
| PDF/A-1b*                         | PDF/A-1b*    |
| Compact PDF/A-1a*                 | PDF/A-1a*    |
| Compact PDF/A-1b*                 | PDF/A-1b*    |
| Compact PDF/A-1a (Ultra Fine)*    | PDF/A-1a*    |
| Compact PDF/A-1b (Ultra Fine)*    | PDF/A-1b*    |
| Encrypt PDF*                      | Encrypt PDF* |
| Encrypt/Compact PDF*              | Encrypt PDF* |
| Encrypt/Compact PDF (Ultra Fine)* | Encrypt PDF* |
| TIFF                              | TIFF         |
| JPEG                              | TIFF         |
| XPS                               | XPS          |
| TXT(UTF-8)                        | TXT(UTF-8)   |
| RTF                               | RTF          |
| DOCX                              | DOCX         |
| XLSX                              | XLSX         |
| PPTX                              | PPTX         |

\* When PDF (including encrypted and high compression) is selected for the file format, Flate Compression can be used to reduce the file size.



- The file format for sending a scanned image is specified when the destination is stored in a one-touch key; however, you can change the format at the time of transmission.
- If [PDF/Encry.] is specified for the file format, the password entry screen appears when scanning. Enter a password with up to 32 characters.



Note the following when [PDF/High] is specified in the [Color/Grayscale] file format.

- When broadcasting to an address with [PDF/High] specified, all files for the scanner will be sent as Compact PDF files.
- When broadcasting to an address with [PDF/High] and [PDF/Compact/U-Fine] specified, all files for the scanner will be sent as Compact PDF (Ultra Fine) files.
- If [PDF/High] is specified, the resolution cannot be changed in the scanner mode. The resolution set in "Compact PDF Resolution Setting" in system settings is set.
- If [PDF/High] is set when a resolution setting has been specified in scanner (or other) mode, the resolution setting will be canceled and the Compact PDF resolution will be used for transmission.
- When [PDF/High] is selected, [Resolution] cannot be changed while waiting for the next original or in [Change Setting] in the job build settings.
- If [PDF/High] is set when an original type setting has been specified in scanner (or other) mode, [Photo] will change to [Text/Photo] and [Map] will change to [Text/Printed Photo].
- The condition of the original may prevent the OCR function from correctly recognizing some characters and graphics, and omissions or incorrect recognition of characters may result.
- The OCR function is not guaranteed to completely reproduce all characters, graphics, or other contents of a scanned original.

## Flate Compression

After compressing a PDF file by JPEG compression, this function compresses the file by lossless compression to further reduce the file size by a small amount. When the data contains significant solid color, this increases the effectiveness of compression.

When sending a PDF file, Flate Compression enables greater reduction of the file size than conventional methods.

If the recipient's PDF viewer does not support Flate Compression, the recipient may not be able to view the PDF file. In this case, Flate Compression can be disabled.



### To enable Flate Compression

Enable or disable Flate Compression in [System Settings] → [Image Send Settings] → [Scan Settings] → [Condition Settings] → [PDF Compression Options] in "Settings (administrator)".

1

## Tap the [File Format] key.

If you are in data input mode, start from step 5.

2

## Tap the [Color/Grayscale] or [B/W] key.



- The format setting for [B/W] mode is the file format with the [B/W Start] key is tapped.
- The format setting for [Color/Grayscale] mode is the file format with the [Color Start] key is tapped.



3

**Tap the key of the desired file type.**After the settings are completed, tap **OK**.**Other**

When the [B/W] key is selected



When the [Color/Grayscale] key is selected



4

**To enable OCR, select the [OCR] checkbox (  ) and tap [OCR Setting].**After the settings are completed, tap ( **OK** ).

- When "Long Size" is selected for the original, [OCR] cannot be used.
- Select the scanning language in the language settings. The following languages can be selected. Japanese, English, Spanish, French, German, Italian, Dutch, Swedish, Norwegian, Finnish, Danish, Hungarian, Czech, Polish, Russian, Greek, Portuguese, Turkish, Slovak, Catalan, Chinese, Traditional Chinese, Korean.
- When [RTF], [DOCX], [XLSX], or [PPTX] is selected for the file format, you can set the font of the output text.
- When the [Detect Image Direction] checkbox is selected (  ), the orientation of the original is detected and the image is rotated before transmission.
- When the [File Name Auto Extraction] checkbox is selected (  ), the text string that is read from the file is included in the file name. If a file name is set, the set file name will be used for transmission.
- You can set the accuracy of OCR in [OCR Accuracy]. Select from [Auto] or [Priority Text]. When [Priority Text] is selected, the character reading accuracy is raised before scanning. When [Priority Text] is selected, accuracy in diagram and table areas may be degraded. Only change the setting when you particularly want to increase the accuracy of text areas.
- If the send format is a PDF format, this function automatically corrects the skew when the original is scanned while skewed.
  - ▶ [AUTOMATICALLY ADJUST SKEWED PDF SCAN DATA \(PDF SKEW ADJUSTMENT\) \(page 4-106\)](#)

5

**To select more detailed settings, tap the [Detail] key to switch to normal mode.**▶ [CHANGING MODES \(page 1-13\)](#)

6

**Tap the [File Format] key.**



# 7 Tap the [Color/Grayscale] or [B/W] tab and select the format mode for scanning.



- The format setting for [B/W] mode is the file format with the color mode set to [Mono2].
- The format setting for [Color/Grayscale] mode is the file format with the color mode set to [Full Color] or [Grayscale].

# 8 Tap the key of the desired file type.

When the [B/W] key is selected

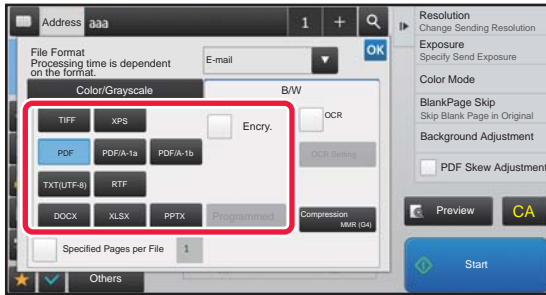

When the [Color/Grayscale] key is selected

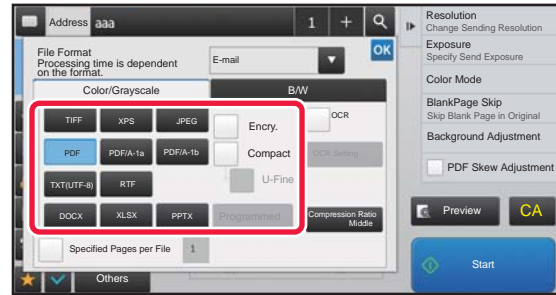

- When [Color/Grayscale] mode is selected, the [Compact] and [U-Fine] checkboxes appear. To suppress image quality deterioration and reduce the data size of a file to be transmitted, select Compact PDF. Select [U-Fine] only when you select Compact PDF.
- If the send format is a PDF format, on the action panel tap [PDF Skew Adjustment] to automatically correct the document skew.
  - ▶ [AUTOMATICALLY ADJUST SKEWED PDF SCAN DATA \(PDF SKEW ADJUSTMENT\) \(page 4-106\)](#)

# 9 Tap the [Compression Mode] key or [Compression Ratio] key.

# 10 Tap the Compression key or Compression Ratio key.

When the [B/W] key is selected

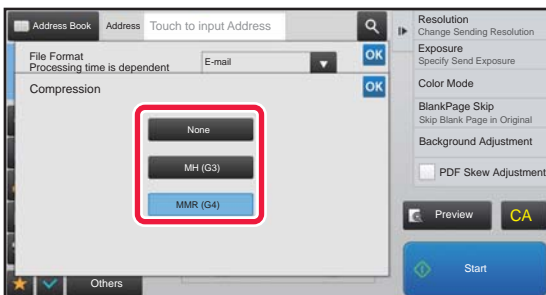

When the [Color/Grayscale] key is selected

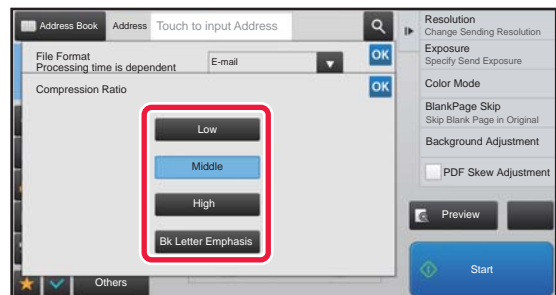

- [Bk Letter Emphasis] in the [Color/Grayscale] tab is a file format that reduces the data size while suppressing deterioration of black text.
- When settings are completed, tap **OK**.





11

To change the number of pages per file, set the [Specified Pages per File] checkbox to , and use numeric keys to specify the number of pages per file.



- When the [Specified Pages per File] checkbox is , one file is created for each of the number of pages at the right. When the checkmark is removed, one file is created for all pages.
- When [Specified Pages per File] is selected, consecutive numbers are added to the created file names.
- When [JPEG] is selected for the file type, one file is created for each page. For this reason, the [Specified Pages per File] checkbox does not appear.



# CHANGING COLOR MODE

Change the color mode used to scan the original.

## In Easy mode

Tap the [B/W Start] or [Color Start] key when scanning the original.



To set the settings used when each key is tapped, select "Settings (administrator)" - [System Settings] → [Image Send Settings] → [Scan Settings] → [Initial Status Settings] → [Easy Scan Settings].

## In Normal mode

| Mode       | Scanning method   |
|------------|---|
| Auto       | The machine detects whether the original is color or black and white and automatically selects full color or black and white (Mono2 or Grayscale) scanning. |
| Full Color | The original is scanned in full color. This mode is best for full color originals such as catalogues.   |
| Mono2      | Colors in the original are scanned as black or white. This mode is best for text-only originals.  |
| Grayscale  | The colors in the original are scanned in black and white as shades of gray (grayscale).  |



### To change the standard to detect Black & White and Color:

In "Settings (administrator)", select [System Settings] → [Common Settings] → [Device Control] → [Detect Standard in Auto Color Mode].

When the color mode is set to auto in image send mode, the discrimination point for detecting whether originals are color or black and white can be set to one of 5 levels. When set to [Closer B/W], the originals are easier to recognize as black and white. When set to [Closer color], the originals are easier to recognize as color.

1

Tap the [Detail] key to switch to the normal mode.

► [CHANGING MODES \(page 1-13\)](#)

2

Tap the [Color Mode] key.

3

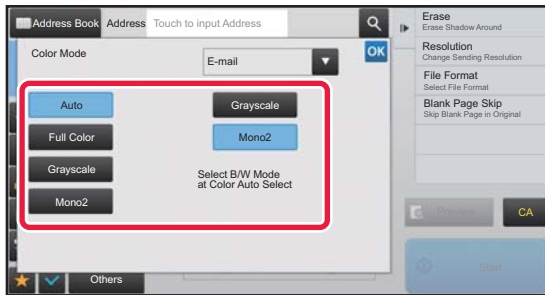

Tap the key of the desired color mode for the original.



If there is a mix of destinations in different send modes, tap  to select a send mode (E-mail, DeskTop/FTP or Data Entry) to set the color mode for each mode.

4

Tap the [Grayscale] or [Mono2] key to set the B/W mode for automatic color selection.

Specify whether Mono2 or grayscale is used when scanning black and white originals. Note that if the file format is set to JPEG, scanning will take place in grayscale.

After the settings are completed, tap .



The B/W mode can be set only when the [Auto] key is selected in the color mode setting (step 3).



# SETTING SCAN SETTINGS AUTOMATICALLY (Auto Set)

To automatically set scan settings appropriate for the original, tap the [Auto Set] key in the base screen of Easy Mode.

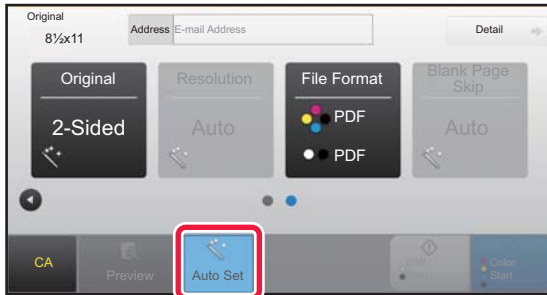

The following functions are set automatically.

- Image Orientation
- 1-Sided/2-Sided
- Resolution
- Blank Page Skip
- Automatically detecting mono2/grayscale
- Automatically adjusting the PDF format skew

Each function setting value/parameter can be changed in setting mode.



When "Auto Set" is enabled, grayed out functions cannot be enabled.



To change the "Auto Set" setting, use "Settings (administrator)" - [System Settings] → [Image Send Settings] → [Scan Settings] → [Condition Settings] → [Auto Scan Setting].

The settings below can be selected.

- **Set Image Orientation Automatically**

The orientation of placed originals can be automatically detected. Set whether the original is scanned by one-sided scanning or two-sided scanning.

- **Set Resolution Automatically**

You can have the machine automatically set the resolution.

- **Blank Page Skip**

Set whether or not blank original pages are automatically skipped during scanning.

- **Automatically determine Mono2/Grayscale**

When scanning a document in B/W Start, this automatically determines from the original which color mode from either mono2 or grayscale to use for scanning.

The criterion whether Black & White is mono2 or grayscale is set with [Detection Standard].

Even if the [Color Start] key is tapped, when the document is detected as Black & White mode, it will automatically selected whether it is mono/2 or grayscale.

However, if full-color scanning setting is always set in the system settings, full color is fixed and automatic detect is not performed.

- **Automatically adjusts PDF format skew**

Automatically adjusts skew in the original when scanning to PDF format.



# CHECKING THE IMAGE TO BE TRANSMITTED

Check the image that will be sent in the touch panel before transmission. You can tap the [Preview] key to check a preview of the image before sending an image. As you can adjust the exposure and resolution to scan the original while checking it in the preview screen, you can send a better quality original to the destination.



- Depending on the size of the transmission data, part of the preview image may not appear in the preview screen in the touch panel.
- The preview function is not available when the original size is set to Long Size.



# OTHER FUNCTIONS

## STORING SCAN OPERATIONS (PROGRAM)

This function collectively stores various settings as one program. The stored program can be retrieved using an easy operation.  
For example, suppose 8-1/2" x 11" (A4) size documents are scanned into a file and sent to each branch office once a month.

- The same documents are sent to each branch office
- Each page of a bound document is successively transmitted
- Smudges on the edges of the documents are erased before transmission

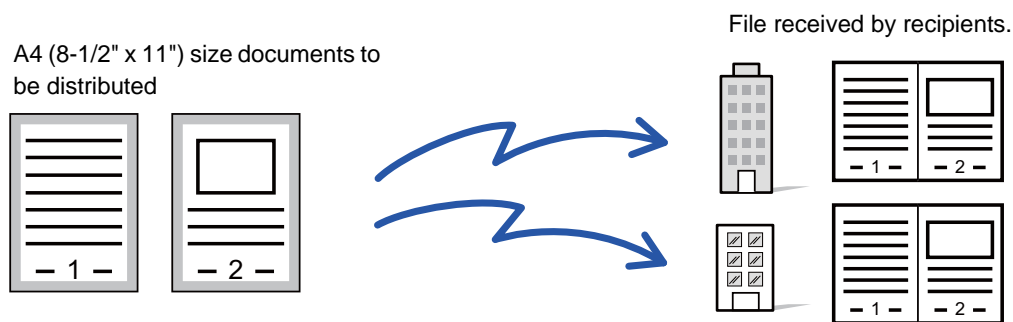

| When a job program is not stored  | When a job program is stored  |
|---|---|
| <p>Enter the address of each branch office.</p> <p style="text-align: center;">↓</p> <p>Select Dual Page Scan.</p> <p style="text-align: center;">↓</p> <p>Specify Erase.</p> <p style="text-align: center;">↓</p> <p>Tap the [Start] key.</p> <p>Scan and send the original.</p> | <p>Tap the key of a stored program.</p> <p style="text-align: center;">↓</p> <p>Tap the [Start] key.</p> <p>Scan and send the original.</p>   |
| <p>Considerable time is required to send the documents each month because the above settings must be selected. In addition, mistakes are occasionally made when selecting the settings.</p>   | <p>When a program is stored, settings are selected with ease by simply tapping the key of the program. In addition, transmission takes place based on the stored settings so there are no chances for mistakes.</p> |



- To configure a program:

Tap [Program Registration - Register Current Settings] on the action panel that appears when you operate any mode screens.

- Prohibit registration of programs / prohibit deleting of registered programs:

In "Settings (administrator)", select [System Settings] → [Image Send Settings] → [Common Settings] → [Enable/Disable Settings] → [Settings to Disable Transmission] → [Disable Registration/Deletion of All Program Items].



- The settings stored in a program will be retained even after the program is used for transmission. The same settings can be used repeatedly for transmission.
- The following contents cannot be stored in programs:
  - Tapping of the [Speaker] key
  - Quick File
  - File
  - Page changes and unspecified erases during preview
  - Reply to/Add 'Reply to' to Cc
  - Metadata Settings
  - Own Name
  - Sign E-mail
  - Encrypt E-mail
- Up to 48 programs can be stored.
- Up to 500 destinations can be stored in one program.
- A program in which sub addresses and passcodes are specified as an F-code destination records all sub addresses and passcodes.
- When registering a program, if the subject name or file name use the pre-set text set in the system, then by changing the pre-set text in system settings the program will call the changed subject name and file name. (If the pre-set text registered in the program is deleted, then the subject name and file name will be blank.)



This function cannot be used in data entry mode.

1

**Tap the [Detail] key to switch to the normal mode.**

► [CHANGING MODES \(page 1-13\)](#)

2

**Place the original and tap [Call Program] on the action panel.**

According to the function stored in the program, place the original in the document feeder tray of the automatic document feeder, or on the document glass.

- [AUTOMATIC DOCUMENT FEEDER \(page 1-116\)](#)
- [DOCUMENT GLASS \(page 1-120\)](#)

3



**Tap the desired program key.**

The normal mode screen at program registration is displayed. If registered in other modes, then switch the screen.

4

**Configure additional settings if needed.**



Some settings cannot be added depending on the contents of the called program.



5

**Tap the [Start] key to start scanning of the original.**

- A beep will sound to indicate that scanning and transmission have ended.
- When you place the original on the document glass, scan each page one at a time.  
When scanning finishes, place the next original and tap the [Start] key.  
Repeat until all pages have been scanned and then tap the [Read-End] key.



You can tap the [Preview] key to check a preview of the image before sending an image. For more information, see "[CHECKING THE IMAGE TO BE TRANSMITTED \(page 4-58\)](#)".



# SCANNING AND SENDING ORIGINALS COLLECTIVELY

## SCANNING ORIGINALS OF DIFFERENT SIZES (MIXED SIZE ORIGINAL)

Scan originals of different sizes at the same time; for example, when 8-1/2" x 14" (B4) size originals are mixed together with 11" x 17" (A3) size originals.

When scanning the originals, the machine automatically detects the size of each original.



This function can only be used with the combinations of original sizes as shown below.

- 11" x 17" and 8-1/2" x 14", 11" x 17" and 8-1/2" x 13", and 11" x 17" and 5-1/2" x 8-1/2"
- A3 and B4, A3 and B5, B4 and A4, and A4 and B5
- A4R and B5, B4 and A4R, B4 and A5, and B5 and A5



- When Mixed Size Original is selected, an original scan size cannot be specified.
- After the original scan size has been selected, Mixed Size Original cannot be specified.
- Rotate cannot be used when Mixed Size Original is enabled.
- This function is not available if [System Settings] → [Common Settings] → [Device Control] → [Condition Settings] → [Original Size Detector Setting] is set to "AB-3" in "Settings (administrator)".

1

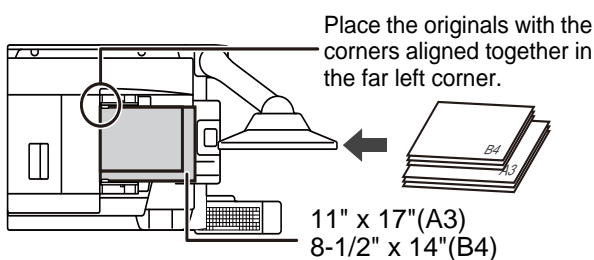

**Place the original in the document feeder tray of the automatic document feeder.**

Insert the originals with the corners aligned together in the far left corner of the document feeder tray.

2

**Tap the mode display to switch to the initial screen of each mode.**

► [CHANGING MODES \(page 1-13\)](#)





3

**Specify the destination.**

- ▶ [RETRIEVING A DESTINATION FROM AN ADDRESS BOOK \(page 4-14\)](#)
- ▶ [VIEWING A LIST OF THE SELECTED DESTINATIONS \(page 4-18\)](#)
- ▶ [USING A SEARCH NUMBER TO RETRIEVE A DESTINATION \(page 4-19\)](#)
- ▶ [ENTERING AN ADDRESS MANUALLY \(page 4-20\)](#)
- ▶ [SPECIFYING A NETWORK FOLDER \(page 4-21\)](#)
- ▶ [RETRIEVING A DESTINATION FROM A GLOBAL ADDRESS BOOK \(page 4-23\)](#)
- ▶ [USING A TRANSMISSION LOG TO RESEND \(page 4-25\)](#)

4

**Tap the [Mixed Size Original] key. Otherwise, tap the [Others] key, and tap the [Mixed Size Original] key.**

A checkmark appears on the icon.

After the settings are completed, tap the [Back] key.



For mixed size originals, set "Original" to "Auto".

**To cancel the mixed size original setting**

Tap the [Mixed Size Original] key to uncheck it.

5

**Tap the [Start] key to start scanning of the original.**

A beep will sound to indicate that scanning and transmission have ended.



Tap the [Preview] key to check the preview of an image. For more information, see "[CHECKING THE IMAGE TO BE TRANSMITTED \(page 4-58\)](#)". However, settings for this function cannot be changed in the preview screen.



# SCANNING BOTH SIDES OF A CARD ONTO A SINGLE PAGE (CARD SHOT)

Send the front and reverse sides of a card as a single page, without the need to send each side separately.

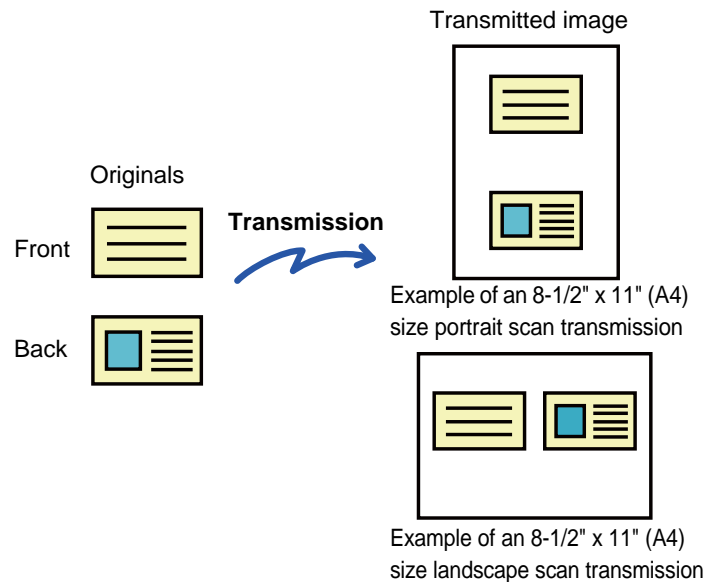

- If the scan size is larger than the send size, it will result in a sending failure.
- The ratio cannot be specified and "Rotation Sending Setting" cannot be selected.

**1**

**Place a card face down on the document glass.**

- ▶ [DOCUMENT GLASS \(page 1-120\)](#)

**2**

**Tap the mode display to switch to the initial screen of each mode.**

- ▶ [CHANGING MODES \(page 1-13\)](#)

**3**

**Specify the destination.**

- ▶ [RETRIEVING A DESTINATION FROM AN ADDRESS BOOK \(page 4-14\)](#)
- ▶ [VIEWING A LIST OF THE SELECTED DESTINATIONS \(page 4-18\)](#)
- ▶ [USING A SEARCH NUMBER TO RETRIEVE A DESTINATION \(page 4-19\)](#)
- ▶ [ENTERING AN ADDRESS MANUALLY \(page 4-20\)](#)
- ▶ [SPECIFYING A NETWORK FOLDER \(page 4-21\)](#)
- ▶ [RETRIEVING A DESTINATION FROM A GLOBAL ADDRESS BOOK \(page 4-23\)](#)
- ▶ [USING A TRANSMISSION LOG TO RESEND \(page 4-25\)](#)



4

Tap the [Others] key, and tap the [Card Shot] key.

5

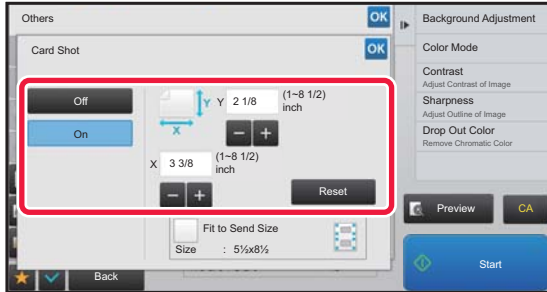

Tap the [On] key, and specify the original size as required.

After the settings are completed, tap **OK** and [Back] keys in sequence.



- Tap the areas displaying width and height sizes respectively, and enter the sizes using the numeric keys.
- To quickly set the size, first specify a value close to the desired ratio value by the numeric keys, then tap [-] or [+] for adjustment.
- To enlarge or reduce the images to fit the paper based on the entered original size, tap the [Fit to Send Size] key.
- After selecting Card Shot, tap the [Original] key in the base screen to change the original scan size or the send size. In this case, the screen of this step appears when you tap the scan size key. For the procedure for setting the send size, see "[SPECIFYING THE SEND SIZE OF THE IMAGE \(page 4-46\)](#)".



**To cancel the Card Shot settings**

Tap the [Off] key.

6

Tap the [Start] key, and scan the front side.

7

Place a card face up on the document glass, and tap the [Start] key to scan the reverse side.



Before scanning the back of the card, tap the [Change Setting] key on the touch panel to change the exposure.

8

Tap the [Read-End] key.



If you will continue by scanning the front of the card, you can tap the [Change Setting] key to change the exposure, resolution, scan size, and send size.



# SIMULTANEOUSLY SCANNING MULTIPLE CARDS, RECEIPTS OR OTHER SMALL ORIGINALS TO INDIVIDUAL FILES (MULTICROP)

This function automatically crops and scans multiple cards, receipts, or other small originals placed on the document glass to individual files.

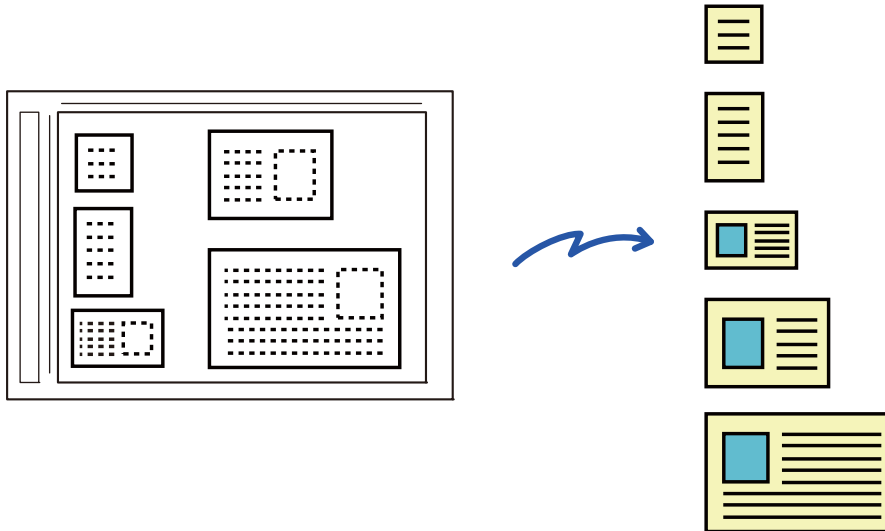

- This function can be used with Scan to E-mail, Scan to FTP/Desktop, Scan to Network Folder, and Save to External Memory Device.
- The e-mail will be sent without being divided if System Settings - [Image Send Settings] → [Scan Settings] → [Condition Settings] → [If the E-mail attachment(s) exceed maximum size, it will be sent in multiple files.] is enabled and [Maximum Size of E-mail Attachments(E-Mail)] is set. If the transmitted e-mail exceeds the limit, a send error occurs.

**1**

## Place the multiple originals that you want to scan on the document glass.

► [DOCUMENT GLASS \(page 1-120\)](#)



### Cautions when placing the originals

- Up to 50 originals can be placed at once.
- Separate the originals by at least 5 mm.
- Available originals sizes are 40 to 297 mm in height and 40 to 432 mm in width.
- If the shape of an original is not square or rectangular, the original may not be cropped correctly.

**2**

## Keep the auto document feeder open, not closed.

If you scan the originals with the auto document feeder closed, it will not be possible to detect the outlines of the originals and scanning will fail. Always use this function with the auto document feeder open. If a light source such as an electric light shines onto the originals during scanning, cropping may not be successful. Adjust the angle of the automatic document feeder so that the light source does not affect the image.



Do not look directly at the light during scanning.



3

**Tap the mode display and change to the base screen of the desired mode.**

- ▶ [CHANGING MODES \(page 1-13\)](#)

4

**Specify the destination.**

- ▶ [RETRIEVING A DESTINATION FROM AN ADDRESS BOOK \(page 4-14\)](#)
- ▶ [VIEWING A LIST OF THE SELECTED DESTINATIONS \(page 4-18\)](#)
- ▶ [USING A SEARCH NUMBER TO RETRIEVE A DESTINATION \(page 4-19\)](#)
- ▶ [ENTERING AN ADDRESS MANUALLY \(page 4-20\)](#)
- ▶ [SPECIFYING A NETWORK FOLDER \(page 4-21\)](#)
- ▶ [RETRIEVING A DESTINATION FROM A GLOBAL ADDRESS BOOK \(page 4-23\)](#)
- ▶ [USING A TRANSMISSION LOG TO RESEND \(page 4-25\)](#)

5

**Tap the [Others] key, and tap the [Multicrop] key.**

A checkmark appears on the icon. When you have completed the setting, tap the [Back] key.



When original count is enabled, the number of scanned originals will appear during scanning.

**To cancel the multicrop setting**

Tap the [Multicrop] key to remove the checkmark.

6

**Tap the [Start] key to start scanning the originals.**

When scanning is completed, place the next originals and tap the [Start] key.

Repeat the above step until you have scanned all originals, and then tap the [Read-End] key.

When transmission is completed, a beep sounds.

**• Restrictions when multicrop is enabled**

The following restrictions apply when multicrop is enabled. Restricted items may change automatically in some cases.

- Resolution: 600 x 600 dpi cannot be used.
- Scan size / send size: Only auto can be used.
- Two-sided original: Only one-sided original is enabled.
- Image Orientation: Cannot be used. (Each cropped original is corrected to the orientation that is least skewed.)
- Format: High compression and ultra-fine cannot be used.
- Compression / compression format: Black text emphasis cannot be used.
- One file per page: Cannot be set when the checkmark is enabled and the number is "1".
- The following functions cannot be used at the same time as multicrop.  
Job Build, Slow Scan Mode, Heavy Paper Scan, Mixed Size Original, Erase, Dual Page Scan, Book Divide, Card Shot, Verif. Stamp, Blank Page Skip, File, Quick File, Preview, Business Card Scan, Image Crop
- When the Multicrop setting is canceled, the following items retain the setting changes that occurred when Multicrop was enabled.  
Resolution, Scan Size, Send Size, 2-Sided Original, File Type, OCR, Compression Mode/Compression Ratio, Specified Pages per File
- Depending on the original, it may not be extracted to the file correctly.



# SCANNING A BUSINESS CARD, READING THE TEXT STRING, CREATING A FILE, AND SENDING THE FILE (BUSINESS CARD SCAN)

You can scan a business card, extract the name and telephone number from the text string read by OCR, and create and send a vCard or other file.

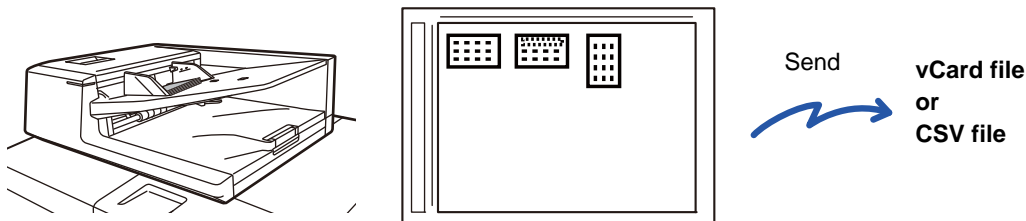

This function can be used with Scan to E-mail, Scan to FTP/Desktop, Scan to Network Folder, and Save to External Memory Device.

The e-mail will be sent without being divided if System Settings - [Image Send Settings] → [Scan Settings] → [Condition Settings] → [If the E-mail attachment(s) exceed maximum size, it will be sent in multiple files.] is enabled and [Maximum Size of E-mail Attachments(E-Mail)] is set. If the transmitted e-mail exceeds the limit, a send error occurs.

For the information that can be extracted and output from a scanned business card, refer to the table below.

| Item               | Description  |
|--------------------|--|
| Name               | The name is extracted.   |
| Kana               | When the language is set to Japanese, you can convert the name to kana.  |
| Pinyin             | When the language is set to Chinese, you can convert the name to pinyin. |
| Postal code        | The postal code is extracted.  |
| Address            | The address is extracted.  |
| Company/group name | The company/organization name is extracted.                              |
| Department         | The department is extracted.   |
| Job title          | The position is extracted.   |
| Telephone number   | The telephone number is extracted.<br>Up to five.                        |
| Fax number         | The fax number is extracted.<br>Up to five.                              |
| URL                | The URL is extracted.<br>Up to five.                                     |
| E-mail address     | The E-mail address is extracted.   |
| Other              | Other is used if none of the above apply.                                |



1

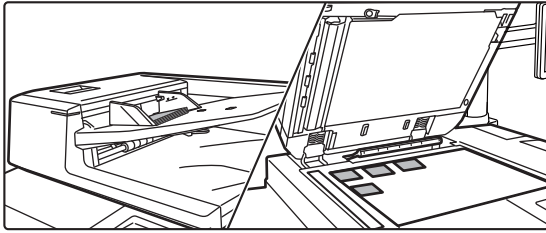

Place the multiple business cards that you want to scan in the document tray of the automatic document feeder, or on the document glass.

- ▶ [AUTOMATIC DOCUMENT FEEDER \(page 1-116\)](#)
- ▶ [DOCUMENT GLASS \(page 1-120\)](#)



#### Cautions when placing business cards on the document glass

- Up to 20 business cards can be placed at once.
- Separate the business cards by at least 5 mm.
- Available business cards sizes are 45 x 85 mm to 110 x 110 mm.
- If the shape of a business card is not square or rectangular, the business card may not be cropped correctly.
- When the document glass is used, place the business cards with the top side of the cards at the far side of the document glass as shown. If the cards are placed in the wrong orientation, it will not be possible to read the cards correctly.

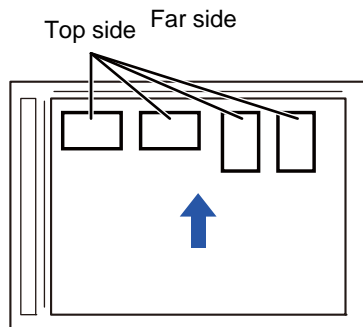

#### Cautions when placing business cards on the document feeder tray

- Up to 150 business cards (or maximum stack height of 1-1/2" (38 mm)) can be placed at once.
- Available business cards sizes are 51 x 89 mm to 55 x 91 mm.
- If the shape of a business card is not square or rectangular, the business card may result in misfeeds.
- Make sure to set the business card direction.

2

### (Using automatic document feeder) Keep the auto document feeder open, not closed.

If you scan the business cards with the auto document feeder closed, it will not be possible to detect the outlines of the business cards and scanning will fail. Always use this function with the auto document feeder open. If a light source such as an electric light shines onto the originals during scanning, cropping may not be successful. Adjust the angle of the automatic document feeder so that the light source does not affect the image.



Do not look directly at the light during scanning.

3

### Tap the mode display and change to the base screen of the desired mode.

- ▶ [CHANGING MODES \(page 1-13\)](#)



## 4

**Specify the destination.**

- ▶ [RETRIEVING A DESTINATION FROM AN ADDRESS BOOK \(page 4-14\)](#)
- ▶ [VIEWING A LIST OF THE SELECTED DESTINATIONS \(page 4-18\)](#)
- ▶ [USING A SEARCH NUMBER TO RETRIEVE A DESTINATION \(page 4-19\)](#)
- ▶ [ENTERING AN ADDRESS MANUALLY \(page 4-20\)](#)
- ▶ [SPECIFYING A NETWORK FOLDER \(page 4-21\)](#)
- ▶ [RETRIEVING A DESTINATION FROM A GLOBAL ADDRESS BOOK \(page 4-23\)](#)
- ▶ [USING A TRANSMISSION LOG TO RESEND \(page 4-25\)](#)

## 5

**Tap the [Others] key, and tap the [Business Card Scan] key.**

## 6

**Tap the [On] key, and change settings as needed.**

When you have completed the settings, tap the **OK** key and then the [Back] key.



- If original count is enabled, the number of scanned originals will appear during scanning.
- Change the language setting to match the language used on the business card. For the language settings, refer to "[CHANGING FORMAT IN SCAN OR DATA ENTRY MODE \(page 4-51\)](#)".
- To use the full name as the file name, enable [Use Full Name on Card as the File Name].
- To send the scanned image file together with the file format selected in [File Format], enable [Also Send Image].
- When setting [Card Information] or [Image and Card Info] using the automatic document feeder, do not scan both vertical and horizontal business cards at the same time.

**To cancel the business card scan setting**

Tap the [Off] key.





7

**Tap the [Start] key to start scanning the originals.**

When scanning is completed, place the next group of originals and tap the [Start] key.

Repeat the above step until you have scanned all originals, and then tap the [Read-End] key.

When transmission is completed, a beep sounds.

The image of the scanned business card is sent together with the VCard or CSV file set in File Format.

**• Restrictions when Business Card Scan is enabled**

The following restrictions apply when Business Card Scan is enabled. Restricted items may change automatically in some cases.

- Resolution: When [Image] is set Only 600x600dpi cannot be used When [Card Information] and [Image and Card Info] are set Available only at 300x300 dpi and 400x400 dpi
- Scan size / send size: Only auto can be used.
- Two-sided original: When using the auto document feeder when [Image] or [Image and Card Info] is set, 2-sided originals are also available.
- Format: High compression and ultra-fine cannot be used.
- Compression / compression format: Black text emphasis cannot be used.
- One file per page: Depending on the setting status, it may or may not be changeable. There are also "1" and "2" for 1-sided/2-sided scanning
- The following functions cannot be used at the same time as multicrop.  
Job Build, Slow Scan Mode, Heavy Paper Scan, Mixed Size Original, Erase, Dual Page Scan, Book Divide, Card Shot, Verif. Stamp, Blank Page Skip, File, Quick File, Preview, Multicrop, Image Crop
- When the Business Card Scan setting is canceled, the following items retain the setting changes that occurred when Business Card Scan was enabled.  
Resolution, Scan Size, Send Size, 2-Sided Original, File Type, OCR, Compression Mode/Compression Ratio, Specified Pages per File
- Depending on the business card, it may not be extracted to the file correctly.



## File names

The user can assign any file name to a file.

When [Use Full Name on Card as the File Name] is enabled, the name on a scanned business card can be assigned as the file name.

If you do not set a file name, the machine will assign an automatically generated file name.

### File name rules

File names are assigned as follows in each setting.

| Setting                   | File          | File name   | Description   |
|---------------------------|---------------|---|---|
| User entry                | vCard         | User_0001.vcf<br>User_0002.vcf  | The name entered by the user ("User" in this case) is inserted at the beginning of the file name.   |
|                           | CSV           | User.csv  |   |
|                           | Scanned image | User_0001.jpg<br>User_0002.jpg  |   |
| File name auto extraction | vCard         | AAAAAA_0001.vcf<br>AAAAAA_0002.vcf<br>BBBBBB_0001.vcf<br>Untitled_0001.vcf<br>Untitled_0002.vcf | Example: The names read from business cards are "AAAAAA", "BBBBB"<br>When there are cards with the same first and last name such as "AAAAAA", the number at the end is a serial number. If the name could not be read, the file name is "Untitled". If there are multiple untitled files, the number at the end is a serial number. |
|                           | CSV           | AAAAAA_0001.csv   |   |
|                           | Scanned image | AAAAAA_0001.jpg<br>AAAAAA_0002.jpg<br>BBBBBB_0001.jpg<br>Untitled_0001.jpg<br>Untitled_0002.jpg |   |
| Automatic generation      | vCard         | MXxxxx_yyyyyy_zzzzzz_0001.vcf<br>MXxxxx_yyyyyy_zzzzzz_0002.vcf                                  | "xxxx" is the model name, "yyyyyy" is the scan date, and "zzzzzz" is the scan time.   |
|                           | CSV           | MXxxxx_yyyyyy_zzzzzz_0001.csv   |   |
|                           | Scanned image | MXxxxx_yyyyyy_zzzzzz_0001.jpg<br>MXxxxx_yyyyyy_zzzzzz_0002.jpg                                  |   |



If the user sets a file name when file name auto extraction is enabled, the user's file name is given priority.



# SCANNING MULTIPLE PHOTOS AT ONCE TO INDIVIDUAL FILES (Image Crop)

This function automatically scans photographs placed on the document glass to individual files.

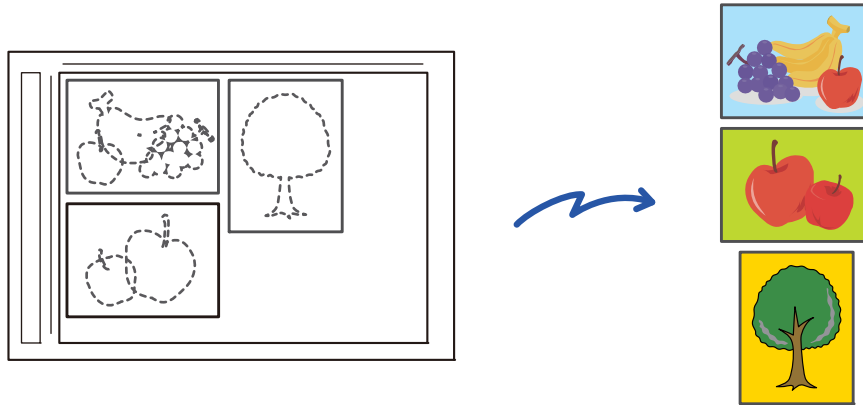

This function can be used with Scan to E-mail, Scan to FTP/Desktop, Scan to Network Folder, and Save to External Memory Device.

Settings (administrator) - "Image Send Settings" → "Scan Settings" → "Condition Settings" → "If the E-mail attachment(s) exceed maximum size, it will be sent in multiple files." is not applied.

If the transmitted e-mail exceeds the limit, a send error will occur.

**1**

## Place the multiple originals that you want to scan on the document glass.

► [DOCUMENT GLASS \(page 1-120\)](#)



### Cautions when placing the originals

- Up to 50 originals can be placed at once.
- Separate the originals by at least 5 mm.
- Available originals sizes are 40 to 297 mm in height and 40 to 432 mm in width.
- If the shape of an original is not square or rectangular, the original may not be cropped correctly.
- The top and bottom of each original cannot be distinguished automatically, so take care to orient the originals appropriately.

**2**

## Close the automatic document feeder.

The scanning method is different from multi-crop. Close the automatic document feeder.

**3**

## Tap the mode display and change to the home screen of the desired mode.

► [CHANGING MODES \(page 1-13\)](#)



## 4

**Specify the destination.**

- ▶ [RETRIEVING A DESTINATION FROM AN ADDRESS BOOK \(page 4-14\)](#)
- ▶ [VIEWING A LIST OF THE SELECTED DESTINATIONS \(page 4-18\)](#)
- ▶ [USING A SEARCH NUMBER TO RETRIEVE A DESTINATION \(page 4-19\)](#)
- ▶ [ENTERING AN ADDRESS MANUALLY \(page 4-20\)](#)
- ▶ [SPECIFYING A NETWORK FOLDER \(page 4-21\)](#)
- ▶ [RETRIEVING A DESTINATION FROM A GLOBAL ADDRESS BOOK \(page 4-23\)](#)
- ▶ [USING A TRANSMISSION LOG TO RESEND \(page 4-25\)](#)

## 5

**Tap the [Others] key, and tap the [Image Crop] key.**

A checkmark appears on the icon. After the settings are completed, tap the [Back] key.



When original count is enabled, the number of scanned originals will appear during scanning.

**To cancel the image crop setting**

Tap the [Image Crop] key to remove the checkmark.

## 6

**Tap the [Start] key to start scanning the originals.**

When scanning is completed, place the next group of originals and tap the [Start] key.

Repeat the above step until you have scanned all originals, and then tap the [Read-End] key.

When transmission is completed, a beep sounds.

**Restrictions when image crop is enabled**

The following restrictions apply when image crop is enabled. Restricted items may change automatically in some cases.

- Scan size / send size: Only auto can be used.
- Two-sided original: Only one-sided original is enabled.
- Image Orientation: Cannot be used. (Each cropped original is corrected to the orientation that is least skewed.)
- Format: High compression and ultra-fine cannot be used.
- Compression / compression format: Black text emphasis cannot be used.
- One file per page: Cannot be set when the checkmark is enabled and the number is "1".
- The following functions cannot be used at the same time as image crop.  
Job Build, Slow Scan Mode, Heavy Paper Scan, Mixed Size Original, Erase, Dual Page Scan, Book Divide, Card Shot, Verif. Stamp, Blank Page Skip, File, Quick File, Preview, Multicrop Business Card Scan
- When the image crop setting is canceled, the following items retain the setting changes that occurred when image crop was enabled.  
Resolution, Scan Size, Send Size, 2-Sided Original, File Type, OCR, Compression Mode/Compression Ratio, Specified Pages per File
- Depending on the photo, it may not be extracted to the file correctly.



## SCANNING MANY ORIGINALS AT ONCE (JOB BUILD)

This function lets you separate an original consisting of numerous pages into sets, scan each set using the automatic document feeder, and transmit the pages in a single transmission. You can also send by placing originals in both the automatic document feeder and on the document glass.

Use this function when there are more original pages than can be placed at once in the automatic document feeder.

When scanning originals that are separated into sets, scan the set that has the first page first.

The settings that you select for the first set can be used for all remaining sets.

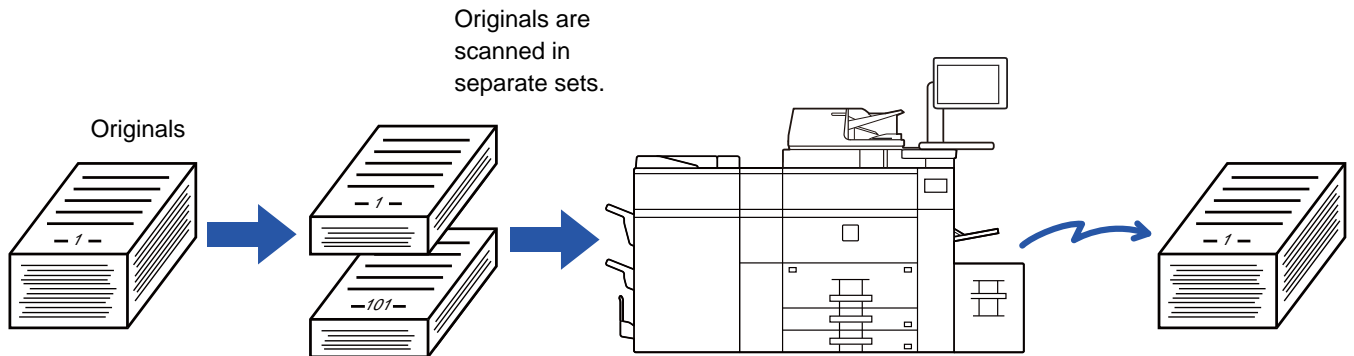

- To change all original settings, configure before scanning the original.
- Up to 9999 pages can be scanned.  
Note that when the memory is being used for other jobs, fewer pages can be scanned.
- If the memory becomes full during scanning, a message will appear and the transmission will be canceled.
- The scan settings can be changed for each set of originals.

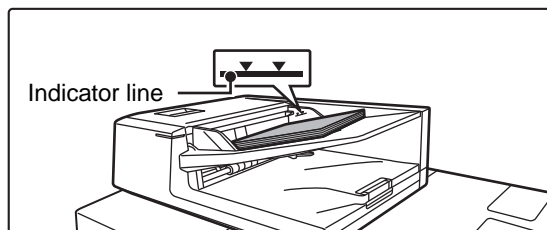
**1**

### Place originals in the automatic document feeder.

Insert the originals all the way into the document feeder tray. Originals can be stacked up to the indicator line.

► [AUTOMATIC DOCUMENT FEEDER \(page 1-116\)](#)

**2**

### Tap the mode display to switch to the initial screen of each mode.

► [CHANGING MODES \(page 1-13\)](#)



3

**Specify the destination.**

- ▶ [RETRIEVING A DESTINATION FROM AN ADDRESS BOOK \(page 4-14\)](#)
- ▶ [VIEWING A LIST OF THE SELECTED DESTINATIONS \(page 4-18\)](#)
- ▶ [USING A SEARCH NUMBER TO RETRIEVE A DESTINATION \(page 4-19\)](#)
- ▶ [ENTERING AN ADDRESS MANUALLY \(page 4-20\)](#)
- ▶ [SPECIFYING A NETWORK FOLDER \(page 4-21\)](#)
- ▶ [RETRIEVING A DESTINATION FROM A GLOBAL ADDRESS BOOK \(page 4-23\)](#)
- ▶ [USING A TRANSMISSION LOG TO RESEND \(page 4-25\)](#)

4

**Tap the [Job Build] key.**

A checkmark appears on the icon.



If you are performing Scan to E-mail, tap the [Others] key and then tap the [Job Build] key.

**To cancel the job build setting:**

Tap the [Job Build] key to uncheck it.

5

**Change settings as needed.**

6

**Tap the [Start] key to scan the first original page.**

7

**Place the next set of originals and tap the [Start] key.**

Repeat until all originals have been scanned.



- If needed, tap [Change Setting] before tapping the [Start] key, and change the original scan settings and send settings for the next original. The setting changes will be applied to the next job.
- If you tap the [Preview] key, you cannot scan additional pages.

**To cancel scanning:**

Tap the [CA] key. All the settings including scanned data will be cleared.



8

## Tap the [Read-End] key.



### To change the time until automatic send:

In "Settings (administrator)", select [System Settings] → [Image Send Settings] → [Common Settings] → [Condition Settings] → [Job Auto Start Time During Scanning].



# SCANNING AND SENDING AN ORIGINAL AS SEPARATE PAGES

## SCANNING AN ORIGINAL AS TWO SEPARATE PAGES (DUAL PAGE SCAN)

The left and right sides of an original are scanned as two separate pages. This function is useful when you wish to successively scan each page of a book or other bound document.

When using dual page scan, the original must be placed on the document glass.

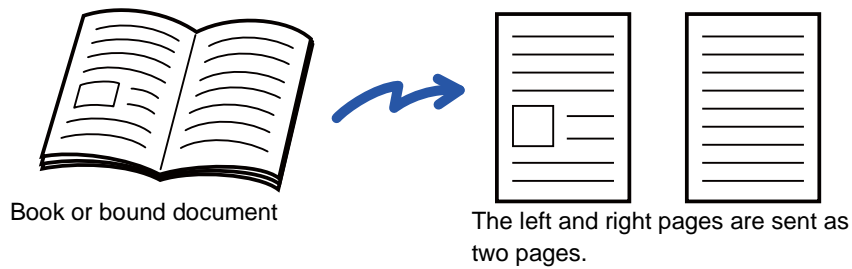

| Original scan size      | Transmitted image           |
|-------------------------|-----------------------------|
| 11" x 17" (A3) x 1 page | 8-1/2" x 11" (A4) x 2 pages |



- This function is available when the original size setting is set to [Auto].
- Note that "Center Erase" and "Edge+Center Erase" cannot be used.





1

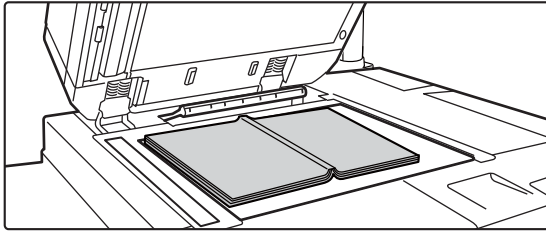

Place the original on the document glass.

► [DOCUMENT GLASS \(page 1-120\)](#)

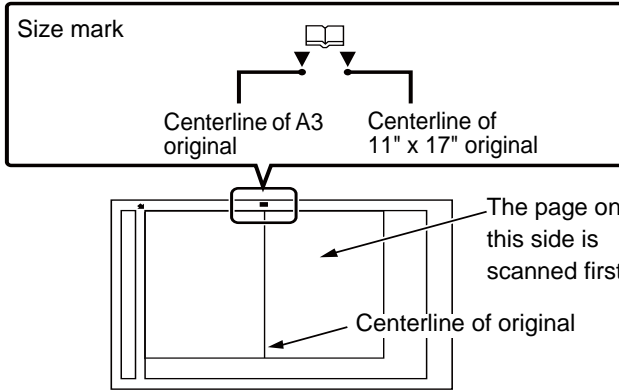

Align the center of the original with the appropriate size mark ▼.

2

Tap the mode display to switch to the initial screen of each mode.

► [CHANGING MODES \(page 1-13\)](#)

3

Specify the destination.

- [RETRIEVING A DESTINATION FROM AN ADDRESS BOOK \(page 4-14\)](#)
- [VIEWING A LIST OF THE SELECTED DESTINATIONS \(page 4-18\)](#)
- [USING A SEARCH NUMBER TO RETRIEVE A DESTINATION \(page 4-19\)](#)
- [ENTERING AN ADDRESS MANUALLY \(page 4-20\)](#)
- [SPECIFYING A NETWORK FOLDER \(page 4-21\)](#)
- [RETRIEVING A DESTINATION FROM A GLOBAL ADDRESS BOOK \(page 4-23\)](#)
- [USING A TRANSMISSION LOG TO RESEND \(page 4-25\)](#)

4



Tap the [Others] key, and tap the [Dual Page Scan] key.

A checkmark appears on the icon.

After the settings are completed, tap the [Back] key.



**To cancel the dual page scan setting**

Tap the [Dual Page Scan] key to uncheck it.

**5**

**Tap the [Start] key to start scanning of the original.**

When scanning finishes, place the next original and tap the [Start] key.  
Repeat until all pages have been scanned and then tap the [Read-End] key.  
A beep will sound to indicate that transmission has ended.



# SPLITTING A PAMPHLET BY PAGE AND TRANSMITTING THE PAGES SUCCESSIVELY (BOOK DIVIDE)

The opened pages of a saddle-stitch pamphlet are split by page according to actual page order before transmission. When using this function, you do not need to sort the original pages to be sent.

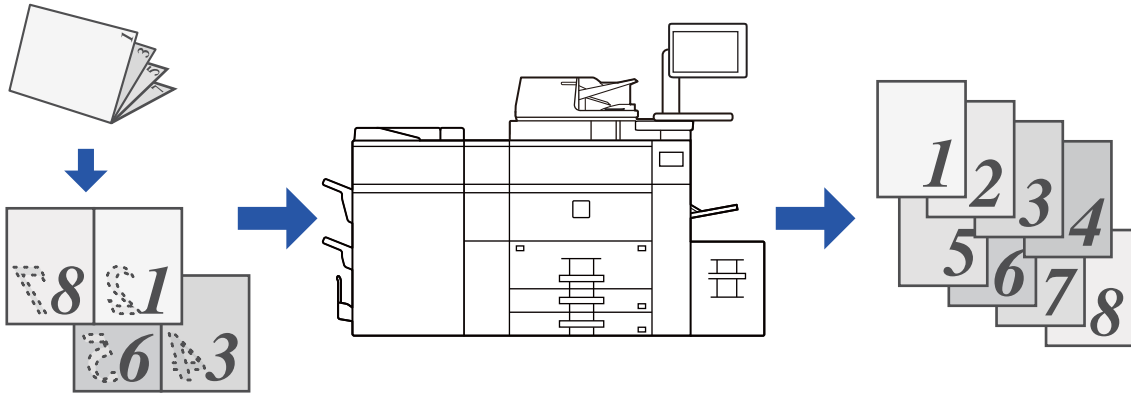

This function can be enabled when the original size setting is set to [Auto].



The document glass is not available for this function.

**1**

**Place the original in the document feeder tray of the automatic document feeder.**

► [DOCUMENT GLASS \(page 1-120\)](#)

**2**

**Tap the mode display to switch to the initial screen of each mode.**

► [CHANGING MODES \(page 1-13\)](#)

**3**

**Specify the destination.**

- [RETRIEVING A DESTINATION FROM AN ADDRESS BOOK \(page 4-14\)](#)
- [VIEWING A LIST OF THE SELECTED DESTINATIONS \(page 4-18\)](#)
- [USING A SEARCH NUMBER TO RETRIEVE A DESTINATION \(page 4-19\)](#)
- [ENTERING AN ADDRESS MANUALLY \(page 4-20\)](#)
- [SPECIFYING A NETWORK FOLDER \(page 4-21\)](#)
- [RETRIEVING A DESTINATION FROM A GLOBAL ADDRESS BOOK \(page 4-23\)](#)
- [USING A TRANSMISSION LOG TO RESEND \(page 4-25\)](#)



4

Tap the [Others] key, and tap the [Book Divide] key.

5

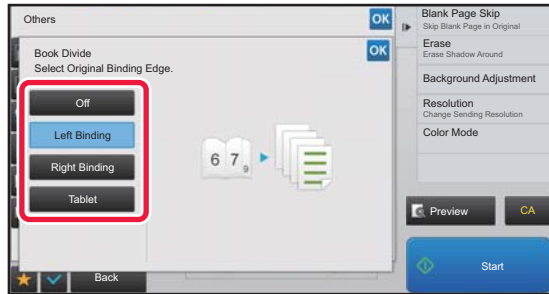

Select the binding edge of the pamphlet original.

After the settings are completed, tap **OK** and [Back] keys in sequence.



Check the preview image displayed in the screen, and make sure that the binding edge is correct.



**To cancel the Book Divide setting:**

Tap the [Off] key.

6

Tap the [Start] key to start scanning of the original.

A beep will sound to indicate that scanning and transmission have ended.



# ADJUSTING COLORS AND SHADING

## ADJUSTING THE BACKGROUND BY MAKING LIGHT AREAS OF THE ORIGINAL DARKER OR LIGHTER (BACKGROUND ADJUSTMENT)

You can adjust the background by making light areas of the original darker or lighter.

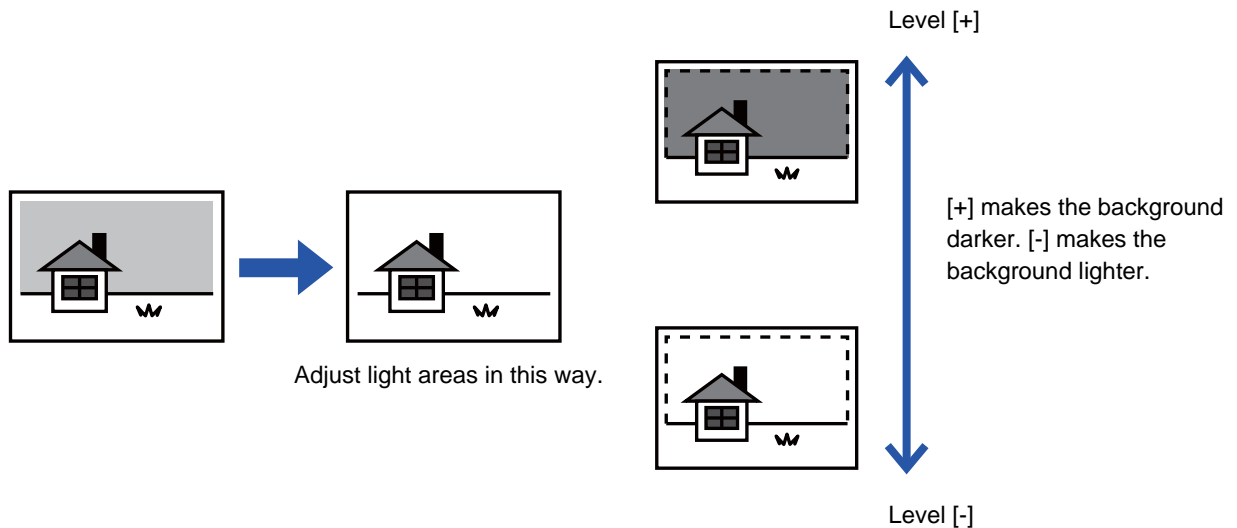
**1**

### Place the original.

Place the original in the document feeder tray of the automatic document feeder, or on the document glass.

- ▶ [AUTOMATIC DOCUMENT FEEDER \(page 1-116\)](#)
- ▶ [DOCUMENT GLASS \(page 1-120\)](#)

**2**

### Tap the mode display to switch to the initial screen of each mode.

- ▶ [CHANGING MODES \(page 1-13\)](#)

**3**

### Specify the destination.

- ▶ [RETRIEVING A DESTINATION FROM AN ADDRESS BOOK \(page 4-14\)](#)
- ▶ [VIEWING A LIST OF THE SELECTED DESTINATIONS \(page 4-18\)](#)
- ▶ [USING A SEARCH NUMBER TO RETRIEVE A DESTINATION \(page 4-19\)](#)
- ▶ [ENTERING AN ADDRESS MANUALLY \(page 4-20\)](#)
- ▶ [SPECIFYING A NETWORK FOLDER \(page 4-21\)](#)
- ▶ [RETRIEVING A DESTINATION FROM A GLOBAL ADDRESS BOOK \(page 4-23\)](#)
- ▶ [USING A TRANSMISSION LOG TO RESEND \(page 4-25\)](#)

**4**

### Tap the [Others] key, and tap the [Background Adjustment] key.



5

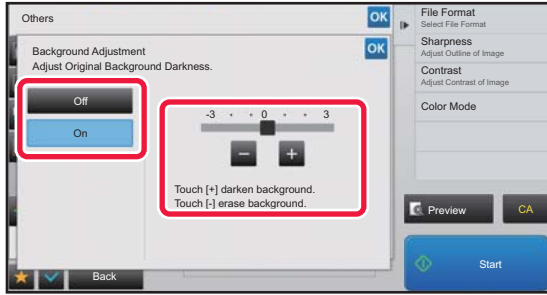

Tap **-** **+** or slide the slider to adjust the range to be suppressed.

After the settings are completed, tap **OK** and [Back] key in sequence.



**To cancel the background adjustment setting:**

Tap the [Off] key.

6

**Tap the [Start] key to start scanning of the original.**

- If you inserted the original pages in the document feeder tray, all pages are scanned. A beep will sound to indicate that scanning and transmission have ended.
- When you place the original on the document glass, scan each page one at a time. When scanning finishes, place the next original and tap the [Start] key. A beep will sound to indicate that transmission has ended.



- You can tap the [Preview] key to check a preview of the image before sending an image. For more information, see "[CHECKING THE IMAGE TO BE TRANSMITTED \(page 4-58\)](#)". However, settings for this function cannot be changed in the preview screen.
- When the color mode setting is [Mono2], the background adjustment function will not operate.

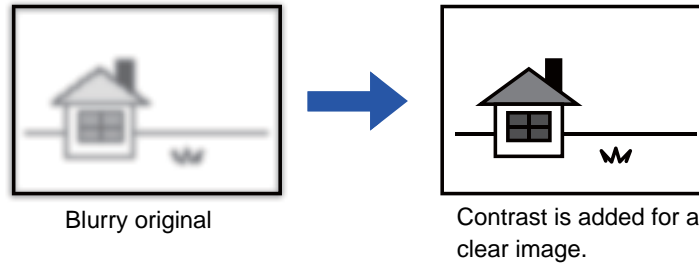

# ADDING CONTRAST TO THE SCANNED ORIGINAL BEFORE TRANSMISSION (CONTRAST)

**1**

## Place the original.

Place the original in the document feeder tray of the automatic document feeder, or on the document glass.

- ▶ [AUTOMATIC DOCUMENT FEEDER \(page 1-116\)](#)
- ▶ [DOCUMENT GLASS \(page 1-120\)](#)

**2**

## Tap the mode display to switch to the initial screen of each mode.

- ▶ [CHANGING MODES \(page 1-13\)](#)

**3**

## Specify the destination.

- ▶ [RETRIEVING A DESTINATION FROM AN ADDRESS BOOK \(page 4-14\)](#)
- ▶ [VIEWING A LIST OF THE SELECTED DESTINATIONS \(page 4-18\)](#)
- ▶ [USING A SEARCH NUMBER TO RETRIEVE A DESTINATION \(page 4-19\)](#)
- ▶ [ENTERING AN ADDRESS MANUALLY \(page 4-20\)](#)
- ▶ [SPECIFYING A NETWORK FOLDER \(page 4-21\)](#)
- ▶ [RETRIEVING A DESTINATION FROM A GLOBAL ADDRESS BOOK \(page 4-23\)](#)
- ▶ [USING A TRANSMISSION LOG TO RESEND \(page 4-25\)](#)

**4**

## Tap the [Others] key, and tap the [Contrast] key.



5

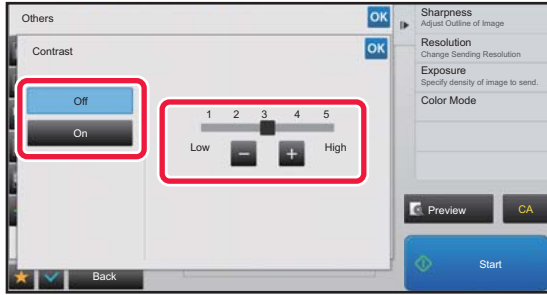

Tap **- +** or slide the slider to adjust the contrast level.

After the settings are completed, tap **OK** and [Back] keys in sequence.



**To cancel the contrast settings:**

Tap the [Off] key.

6

**Tap the [Start] key to start scanning of the original.**

- If you inserted the original pages in the document feeder tray, all pages are scanned. A beep will sound to indicate that scanning and transmission have ended.
- When you place the original on the document glass, scan each page one at a time. When scanning finishes, place the next original and tap the [Start] key. Repeat the procedure until all pages have been scanned and then tap the [Read-End] key. A beep will sound to indicate that scanning and transmission have ended.



You can tap the [Preview] key to check a preview of the image before sending an image. For more information, see "[CHECKING THE IMAGE TO BE TRANSMITTED \(page 4-58\)](#)". However, settings for this function cannot be changed in the preview screen.



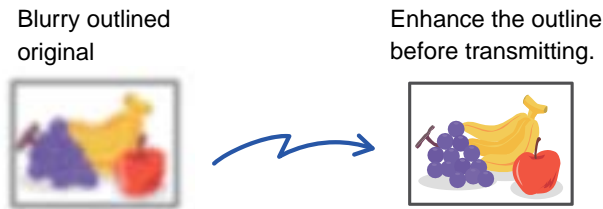

# ENHANCING THE OUTLINE OF THE SCANNED ORIGINAL BEFORE TRANSMISSION (SHARPNESS)

**1**

## Place the original.

Place the original in the document feeder tray of the automatic document feeder, or on the document glass.

- ▶ [AUTOMATIC DOCUMENT FEEDER \(page 1-116\)](#)
- ▶ [DOCUMENT GLASS \(page 1-120\)](#)

**2**

## Tap the mode display to switch to the initial screen of each mode.

- ▶ [CHANGING MODES \(page 1-13\)](#)

**3**

## Specify the destination.

- ▶ [RETRIEVING A DESTINATION FROM AN ADDRESS BOOK \(page 4-14\)](#)
- ▶ [VIEWING A LIST OF THE SELECTED DESTINATIONS \(page 4-18\)](#)
- ▶ [USING A SEARCH NUMBER TO RETRIEVE A DESTINATION \(page 4-19\)](#)
- ▶ [ENTERING AN ADDRESS MANUALLY \(page 4-20\)](#)
- ▶ [SPECIFYING A NETWORK FOLDER \(page 4-21\)](#)
- ▶ [RETRIEVING A DESTINATION FROM A GLOBAL ADDRESS BOOK \(page 4-23\)](#)
- ▶ [USING A TRANSMISSION LOG TO RESEND \(page 4-25\)](#)

**4**

## Tap the [Others] key, and tap the [Sharpness] key.



5

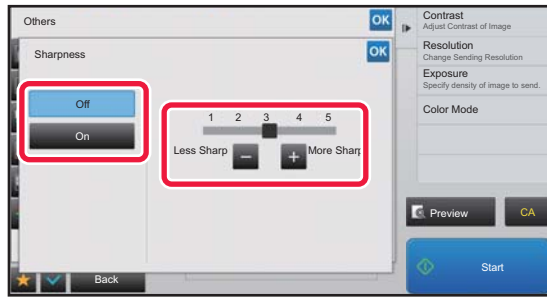

Tap **- +** or slide the slider to adjust the sharpness.

After the settings are completed, tap **OK** and [Back] keys in sequence.



**To cancel the sharpness setting:**

Tap the [Off] key.

6

**Tap the [Start] key to start scanning of the original.**

- If you inserted the original pages in the document feeder tray, all pages are scanned. A beep will sound to indicate that scanning and transmission have ended.
- When you place the original on the document glass, scan each page one at a time. When scanning finishes, place the next original and tap the [Start] key. Repeat the procedure until all pages have been scanned and then tap the [Read-End] key. A beep will sound to indicate that scanning and transmission have ended.



You can tap the [Preview] key to check a preview of the image before sending an image. For more information, see "[CHECKING THE IMAGE TO BE TRANSMITTED \(page 4-58\)](#)". However, settings for this function cannot be changed in the preview screen.



# REMOVING CHROMATIC COLORS FROM THE SCANNED ORIGINAL BEFORE TRANSMISSION (DROP OUT COLOR)

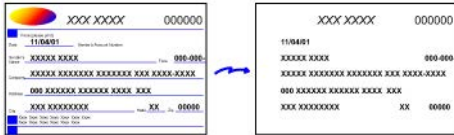

1

## Place the original.

Place the original in the document feeder tray of the automatic document feeder, or on the document glass.

- ▶ [AUTOMATIC DOCUMENT FEEDER \(page 1-116\)](#)
- ▶ [DOCUMENT GLASS \(page 1-120\)](#)

2

## Tap the mode display to switch to the initial screen of each mode.

- ▶ [CHANGING MODES \(page 1-13\)](#)

3

## Specify the destination.

- ▶ [RETRIEVING A DESTINATION FROM AN ADDRESS BOOK \(page 4-14\)](#)
- ▶ [VIEWING A LIST OF THE SELECTED DESTINATIONS \(page 4-18\)](#)
- ▶ [USING A SEARCH NUMBER TO RETRIEVE A DESTINATION \(page 4-19\)](#)
- ▶ [ENTERING AN ADDRESS MANUALLY \(page 4-20\)](#)
- ▶ [SPECIFYING A NETWORK FOLDER \(page 4-21\)](#)
- ▶ [RETRIEVING A DESTINATION FROM A GLOBAL ADDRESS BOOK \(page 4-23\)](#)
- ▶ [USING A TRANSMISSION LOG TO RESEND \(page 4-25\)](#)

4

## Tap the [Others] key, and then tap the [Drop Out Color] key.

A checkmark appears on the icon.

After the settings are completed, tap the [Back] key.



### To cancel the drop out color setting

Tap the [Drop Out Color] key to uncheck it.



5

### Tap the [Start] key to start scanning of the original.

- If you inserted the original pages in the document feeder tray, all pages are scanned. A beep will sound to indicate that scanning and transmission have ended.
- When you place the original on the document glass, scan each page one at a time. When scanning finishes, place the next original and tap the [Start] key. Repeat the procedure until all pages have been scanned and then tap the [Read-End] key. A beep will sound to indicate that scanning and transmission have ended.



You can tap the [Preview] key to check a preview of the image before sending an image. For more information, see "[CHECKING THE IMAGE TO BE TRANSMITTED \(page 4-58\)](#)". Tap the [Change Setting] key in the scan-end confirmation screen to change the exposure, resolution, scan size, and send size. (However, when scanning each even-numbered page of the original, only the exposure can be changed.)



# ADJUSTING RED/GREEN/BLUE (RGB Adjust)

This function heightens or lightens any one of the three color components R (red), G (green), and B (blue).

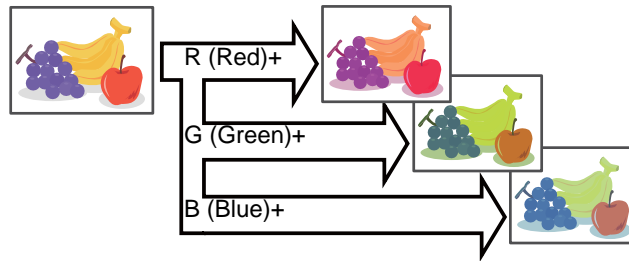

## 1 Place the original.

Place the original in the document feeder tray of the automatic document feeder, or on the document glass.

- ▶ [AUTOMATIC DOCUMENT FEEDER \(page 1-116\)](#)
- ▶ [DOCUMENT GLASS \(page 1-120\)](#)

## 2 Tap the mode display to switch to the initial screen of each mode.

- ▶ [CHANGING MODES \(page 1-13\)](#)

## 3 Specify the destination.

- ▶ [RETRIEVING A DESTINATION FROM AN ADDRESS BOOK \(page 4-14\)](#)
- ▶ [VIEWING A LIST OF THE SELECTED DESTINATIONS \(page 4-18\)](#)
- ▶ [USING A SEARCH NUMBER TO RETRIEVE A DESTINATION \(page 4-19\)](#)
- ▶ [ENTERING AN ADDRESS MANUALLY \(page 4-20\)](#)
- ▶ [SPECIFYING A NETWORK FOLDER \(page 4-21\)](#)
- ▶ [RETRIEVING A DESTINATION FROM A GLOBAL ADDRESS BOOK \(page 4-23\)](#)
- ▶ [USING A TRANSMISSION LOG TO RESEND \(page 4-25\)](#)

## 4 Tap the [Others] key, and tap the [RGB Adjust] key.

## 5

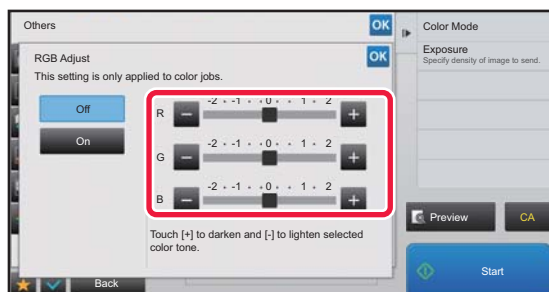

Tap **− +** of the color you want to adjust or slide the slider to adjust the coloring.

After the settings are completed, tap **OK** and [Back] keys in sequence.



**To cancel the RGB Adjust setting:**  
Tap the [Off] key.



6

### Tap the [Start] key to start scanning of the original.

- If you inserted the original pages in the document feeder tray, all pages are scanned. A beep will sound to indicate that scanning and transmission have ended.
- When you place the original on the document glass, scan each page one at a time. When scanning finishes, place the next original and tap the [Start] key. Repeat the procedure until all pages have been scanned and then tap the [Read-End] key. A beep will sound to indicate that scanning and transmission have ended.



You can tap the [Preview] key to check a preview of the image before sending an image. For more information, see "[CHECKING THE IMAGE TO BE TRANSMITTED \(page 4-58\)](#)". Tap the [Change Setting] key in the scan-end confirmation screen to change the exposure, resolution, scan size, and send size. (However, when scanning each even-numbered page of the original, only the exposure can be changed.)



# SCANNING ORIGINALS

## ERASING PERIPHERAL SHADOWS ON THE IMAGE (ERASE)

When scanning thick originals or books, erase any peripheral shadows that may be produced on the image.

### Scanning a thick book

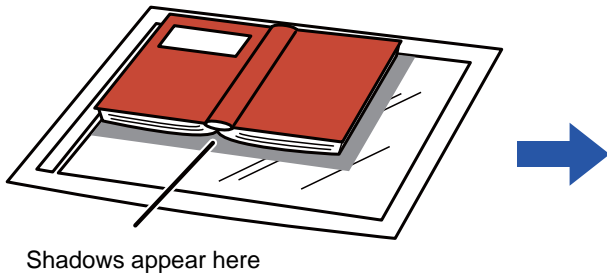

| Not using the erase function | Using the erase function |
|------------------------------|--------------------------|
|                              |                          |
| Shadows appear in the image. | No shadows appear.       |

### Erase modes

Outer Frame Erase

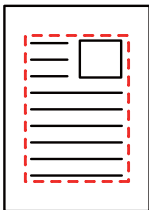

Center Erase

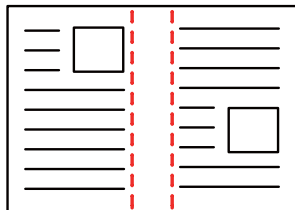

Edge + Center Erase

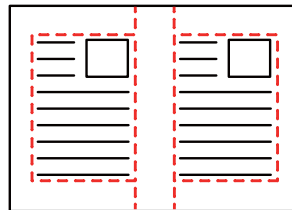

Side Erase

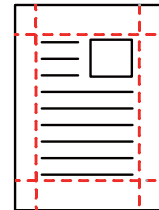

- This function erases the parts of the image where shadows tend to form, but does not detect shadows and erase only the shadows.
- If a ratio setting is used in combination with an erase setting, the erase width will change according to the selected ratio. For example, if you set an erase width of 1/2" (10 mm) and reduce the image to 70% before scanning it, the erase width will be reduced to 3/8" (7 mm).
- When the erase setting is selected, the image orientation will be forcibly portrait.



#### To change the default erase width setting:

In "Settings (administrator)", select [System Settings] → [Image Send Settings] → [Common Settings] → [Condition Settings] → [Erase Width Adjustment].

The width can be set from 0" to 1" (0 mm to 20 mm). The factory default setting is 1/2" (10 mm). The setting changed here will apply to [System Settings] → [Copy Settings] → [Condition Settings] → [Erase Width Adjustment] in "Settings".



1

**Place the original.**

Place the original in the document feeder tray of the automatic document feeder, or on the document glass.

- ▶ [AUTOMATIC DOCUMENT FEEDER \(page 1-116\)](#)
- ▶ [DOCUMENT GLASS \(page 1-120\)](#)

2

**Tap the mode display to switch to the initial screen of each mode.**

- ▶ [CHANGING MODES \(page 1-13\)](#)

3

**Specify the destination.**

- ▶ [RETRIEVING A DESTINATION FROM AN ADDRESS BOOK \(page 4-14\)](#)
- ▶ [VIEWING A LIST OF THE SELECTED DESTINATIONS \(page 4-18\)](#)
- ▶ [USING A SEARCH NUMBER TO RETRIEVE A DESTINATION \(page 4-19\)](#)
- ▶ [ENTERING AN ADDRESS MANUALLY \(page 4-20\)](#)
- ▶ [SPECIFYING A NETWORK FOLDER \(page 4-21\)](#)
- ▶ [RETRIEVING A DESTINATION FROM A GLOBAL ADDRESS BOOK \(page 4-23\)](#)
- ▶ [USING A TRANSMISSION LOG TO RESEND \(page 4-25\)](#)

4

**Tap the [Others] key, and tap the [Erase] key.**

5

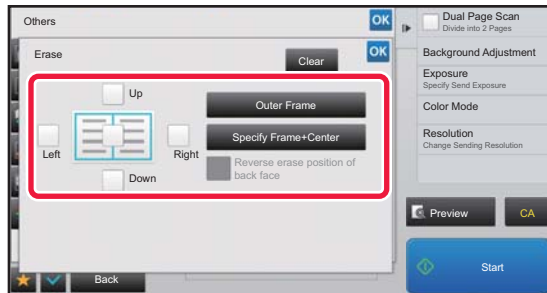
**Tap the checkbox of the edge that you wish to erase, and specify the erase position.**

Check that the tapped checkbox is set to .

If the [Specify Frame] key is tapped, the [Up], [Down], [Left], and [Right] checkboxes are set to .

If the [Specify Frame+Center] key is tapped, all the checkboxes are set to .



Specify the erase edge on the reverse side when erasing edges of one to three sides of Up, Down, Left, and Right on the front side to scan a 2-sided original.

- If the [Reverse Erase Position of The Back Face] checkbox is set to , the edge in the position opposite to the erased edge on the front side will be erased.
- If the [Reverse Erase Position of The Back Face] checkbox is set to , the edge in the same position as on the front side will be erased.







6

**Specify the erase width.**

After the settings are completed, tap  and [Back] keys in sequence.



- Tap the numeric value display indicating the margin shift area on the front side or reverse side, and enter the area using the numeric keys.
- To quickly set the area, first specify a value close to the desired value by the numeric keys, then adjust it with  .

**To cancel the erase setting:**

Tap the [Clear] key.

7

**Tap the [Start] key to start scanning of the original.**

- If you inserted the original pages in the document feeder tray, all pages are scanned. A beep will sound to indicate that scanning and transmission have ended.
- When you place the original on the document glass, scan each page one at a time. When scanning finishes, place the next original and tap the [Start] key. Repeat until all pages have been scanned and then tap the [Read-End] key. A beep will sound to indicate that transmission has ended.



You can tap the [Preview] key to check a preview of the image before sending an image. For more information, see "[CHECKING THE IMAGE TO BE TRANSMITTED \(page 4-58\)](#)"



## SCANNING A THIN ORIGINAL (SLOW SCAN MODE)

Use this function when you wish to scan thin originals using the automatic document feeder. This function helps prevent thin originals from misfeeding.

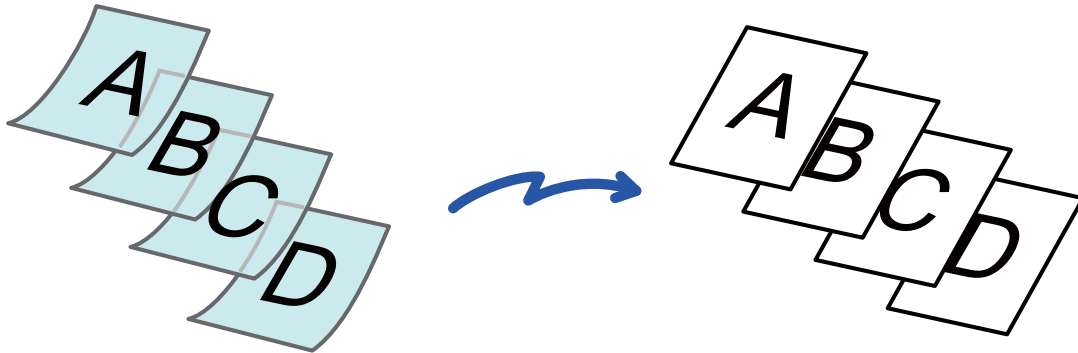

When Slow Scan Mode is selected, 2-sided scanning is not possible.

**1**

**Place the original in the document feeder tray of the automatic document feeder.**

► [AUTOMATIC DOCUMENT FEEDER \(page 1-116\)](#)



If the originals are inserted with too much force, they may crumple and misfeed.

**2**

**Tap the mode display to switch to the initial screen of each mode.**

► [CHANGING MODES \(page 1-13\)](#)

**3**

**Specify the destination.**

- [RETRIEVING A DESTINATION FROM AN ADDRESS BOOK \(page 4-14\)](#)
- [VIEWING A LIST OF THE SELECTED DESTINATIONS \(page 4-18\)](#)
- [USING A SEARCH NUMBER TO RETRIEVE A DESTINATION \(page 4-19\)](#)
- [ENTERING AN ADDRESS MANUALLY \(page 4-20\)](#)
- [SPECIFYING A NETWORK FOLDER \(page 4-21\)](#)
- [RETRIEVING A DESTINATION FROM A GLOBAL ADDRESS BOOK \(page 4-23\)](#)
- [USING A TRANSMISSION LOG TO RESEND \(page 4-25\)](#)



4

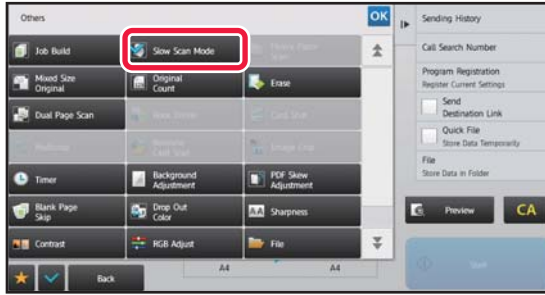

Tap the [Others] key, and tap the [Slow Scan Mode] key.

A checkmark appears on the icon.

After the settings are completed, tap the [Back] key.



**To cancel the Slow Scan Mode setting**

Tap the [Slow Scan Mode] key to uncheck it.

5

**Tap the [Start] key to start scanning of the original.**

A beep will sound to indicate that scanning and transmission have ended.



Tap the [Preview] key to check the preview of an image. For more information, see "[CHECKING THE IMAGE TO BE TRANSMITTED \(page 4-58\)](#)". However, settings for this function cannot be changed in the preview screen.



## SCANNING A HEAVY ORIGINAL (HEAVY PAPER SCAN)

Use this function when you wish to scan heavy originals using the automatic document feeder. This function helps prevent heavy originals from misfeeding.

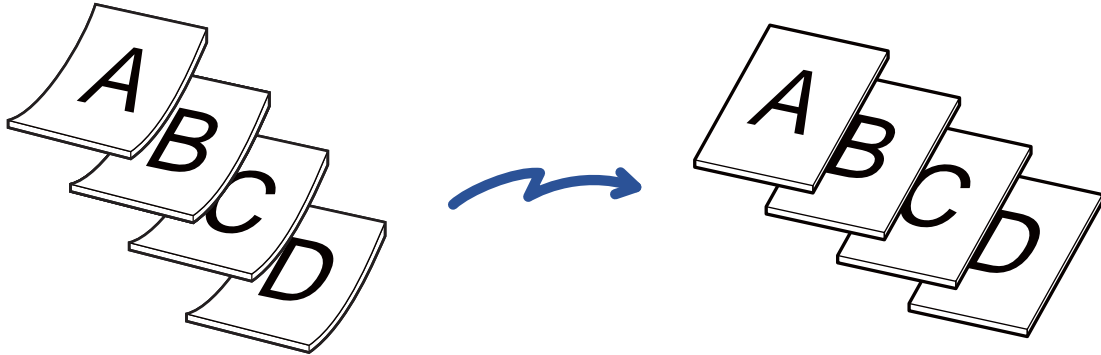
**1**

**Place the original in the document feeder tray of the automatic document feeder.**

► [AUTOMATIC DOCUMENT FEEDER \(page 1-116\)](#)



If the originals are inserted with too much force, they may crumple and misfeed.

**2**

**Tap the mode display to switch to the initial screen of each mode.**

► [CHANGING MODES \(page 1-13\)](#)

**3**

**Specify the destination.**

- [RETRIEVING A DESTINATION FROM AN ADDRESS BOOK \(page 4-14\)](#)
- [VIEWING A LIST OF THE SELECTED DESTINATIONS \(page 4-18\)](#)
- [USING A SEARCH NUMBER TO RETRIEVE A DESTINATION \(page 4-19\)](#)
- [ENTERING AN ADDRESS MANUALLY \(page 4-20\)](#)
- [SPECIFYING A NETWORK FOLDER \(page 4-21\)](#)
- [RETRIEVING A DESTINATION FROM A GLOBAL ADDRESS BOOK \(page 4-23\)](#)
- [USING A TRANSMISSION LOG TO RESEND \(page 4-25\)](#)



4

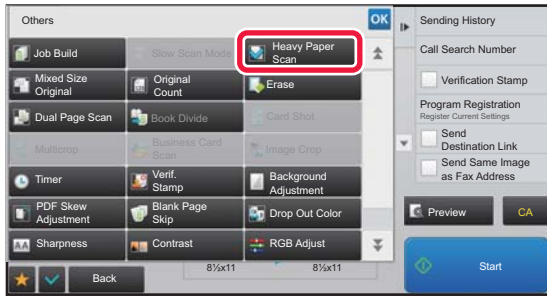

Tap the [Others] key, and tap the [Heavy Paper Scan] key.

A checkmark appears on the icon.

After the settings are completed, tap the [Back] key.



**To cancel the Heavy Paper Scan setting**

Tap the [Heavy Paper Scan] key to uncheck it.

5

**Tap the [Start] key to start scanning of the original.**

A beep will sound to indicate that scanning and transmission have ended.



Tap the [Preview] key to check the preview of an image. For more information, see "[CHECKING THE IMAGE TO BE TRANSMITTED \(page 4-58\)](#)". However, settings for this function cannot be changed in the preview screen.



# ELIMINATING BLANK PAGES FROM A TRANSMISSION (BLANK PAGE SKIP)

If the scanned original contains blank pages, this function skips them to send only non-blank pages. The machine detects blank pages, enabling you to skip useless blank sheets without checking an original.

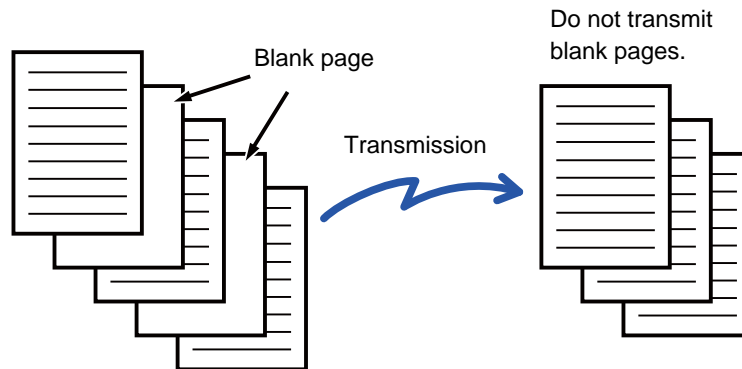

- If an original of which one side is blank is scanned, blank pages are skipped for 2-sided sending.
- In a broadcast transmission to destinations, this function is applied to scan mode destinations only.
- Depending on the original, some pages that are not blank may be detected as blank pages and thus not being sent, and some pages that are blank may not be detected as blank and thus sent.



#### To display the blank page skip confirmation message:

Select [System Settings] → [Common Settings] → [Device Control] → [Condition Settings] → [Display Blank Page Skip Confirmation Message].

**1**

## Place the original.

Place the original in the document feeder tray of the automatic document feeder, or on the document glass.

- ▶ [AUTOMATIC DOCUMENT FEEDER \(page 1-116\)](#)
- ▶ [DOCUMENT GLASS \(page 1-120\)](#)

**2**

## Tap the mode display to switch to the initial screen of each mode.

- ▶ [CHANGING MODES \(page 1-13\)](#)

**3**

## Specify the destination.

- ▶ [RETRIEVING A DESTINATION FROM AN ADDRESS BOOK \(page 4-14\)](#)
- ▶ [VIEWING A LIST OF THE SELECTED DESTINATIONS \(page 4-18\)](#)
- ▶ [USING A SEARCH NUMBER TO RETRIEVE A DESTINATION \(page 4-19\)](#)
- ▶ [ENTERING AN ADDRESS MANUALLY \(page 4-20\)](#)
- ▶ [SPECIFYING A NETWORK FOLDER \(page 4-21\)](#)
- ▶ [RETRIEVING A DESTINATION FROM A GLOBAL ADDRESS BOOK \(page 4-23\)](#)
- ▶ [USING A TRANSMISSION LOG TO RESEND \(page 4-25\)](#)

**4**

## Tap the [Others] key, and tap the [Blank Page Skip] key.



5

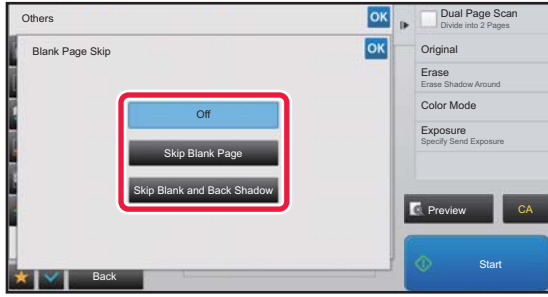

**Tap the [Skip Blank Page] or [Skip Blank and Back Shadow] key.**

After the settings are completed, tap **OK** and [Back] keys in sequence.



**To cancel the Blank Page Skip setting:**  
Tap the [Off] key.

6

**Tap the [Start] key to start scanning of the original.**

A beep will sound to indicate that scanning has ended.



Tap the [Preview] key to check the preview of an image. For more information, see "[CHECKING THE IMAGE TO BE TRANSMITTED \(page 4-58\)](#)".

7

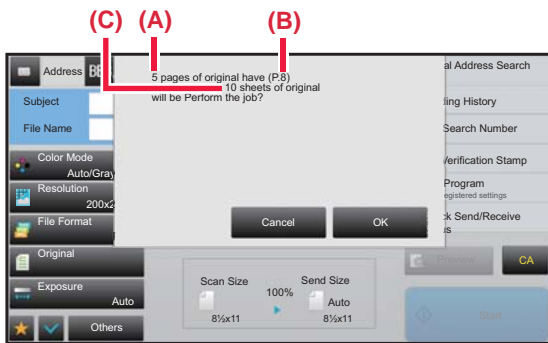

**When scanning ends, check the number of original sheets and the number of sheets to be sent and tap the [OK] key to start transmission.**

- When Job Build mode is used, the confirmation message will appear after the [Start] key is tapped.
  - On the confirmation screen, the number of scanned original sheets appears in (A), the number of scanned sides in (B), and the number of sheets to be sent excluding blank pages in (C).
- For example, if five original sheets that include two blank pages are scanned by duplex scanning, (A) will show "5", (B) will show "10", and (C) will show "8".



If this step is not performed within one minute after the above confirmation screen appears, the scanned image and settings will be cleared and the base screen will reappear. Scanning will not be completed automatically and the image will not be reserved for transmission.



# CHECKING THE NUMBER OF SCANNED ORIGINAL SHEETS BEFORE TRANSMISSION (ORIGINAL COUNT)

Count the number of scanned original sheets and display the count before transmission.

Checking the number of scanned original sheets before transmission helps prevent transmission mistakes.



- The count result is displayed with the number of scanned original sheets, not the number of scanned original pages. For example, when a 2-sided original is transmitted, the number "1" will appear to indicate that one original sheet is transmitted, not "2" to indicate the front-side page and the reverse side page.
- When a broadcast transmission is performed, if the original count function is selected in any of the modes, the function will operate for all destinations.
- The setting should be enabled separately for each mode.

1

## Place originals in the automatic document feeder.

- [AUTOMATIC DOCUMENT FEEDER \(page 1-116\)](#)

2

## Tap the mode display to switch to the initial screen of each mode.

- [CHANGING MODES \(page 1-13\)](#)

3

## Specify the destination.

- [RETRIEVING A DESTINATION FROM AN ADDRESS BOOK \(page 4-14\)](#)
- [VIEWING A LIST OF THE SELECTED DESTINATIONS \(page 4-18\)](#)
- [USING A SEARCH NUMBER TO RETRIEVE A DESTINATION \(page 4-19\)](#)
- [ENTERING AN ADDRESS MANUALLY \(page 4-20\)](#)
- [SPECIFYING A NETWORK FOLDER \(page 4-21\)](#)
- [RETRIEVING A DESTINATION FROM A GLOBAL ADDRESS BOOK \(page 4-23\)](#)
- [USING A TRANSMISSION LOG TO RESEND \(page 4-25\)](#)

4

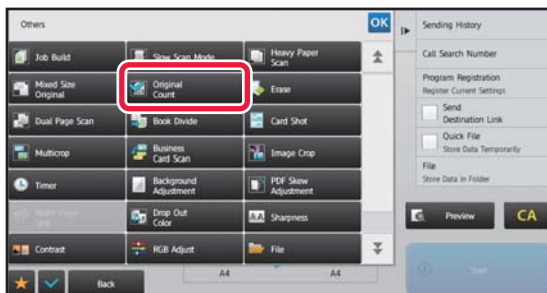

## Tap the [Others] key, and tap the [Original Count] key.

A checkmark appears on the icon.

After the settings are completed, tap the [Back] key.



### To cancel the original count setting:

Tap the [Original Count] key to uncheck it.





5

**Tap the [Start] key to start scanning of the original.**

A beep will sound to indicate that scanning has ended.



Tap the [Preview] key to check the preview of an image. For more information, see "[CHECKING THE IMAGE TO BE TRANSMITTED \(page 4-58\)](#)". However, settings for this function cannot be changed in the preview screen.

6

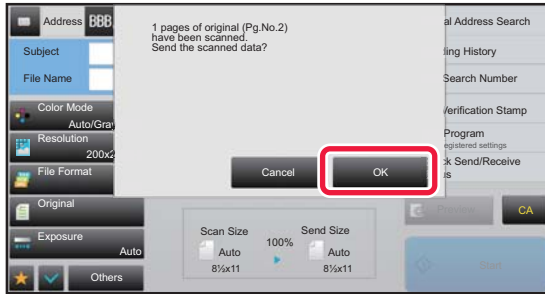
**Check the number of original sheets.**

The number that is displayed is the number of scanned original sheets, not the number of scanned original pages. For example, when 2-sided copying is performed using one original, the number "1" will appear to indicate that one original sheet was scanned, not "2" to indicate the front-side page and the reverse side page.

7

**Tap the [OK] key to start transmission.**

If this function is combined with [Job Build], the count result is displayed after the [Read-End] key has been tapped. If this step is not performed within one minute after the above confirmation screen appears, the scanned image and settings will be cleared and the base screen will reappear. Scanning will not be completed automatically and the image will not be reserved for transmission.

**If the displayed number of original sheets is different from the actual number of sheets:**

Tap the [Cancel] key and then tap the [OK] key in the message screen to clear all scanned data. Scan settings and destination settings will not be cleared. Insert the original sheets in the document feeder tray again and tap the [Start] key to re-scan.



# STAMPING SCANNED ORIGINALS (VERIFICATION STAMP)

This function stamps each original that is scanned using the automatic document feeder, allowing you to verify that all originals were correctly scanned.

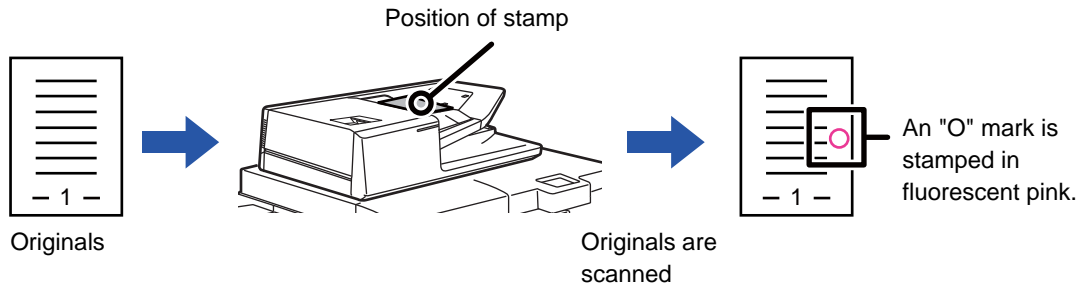

- To use the verification stamp function, the optional stamp unit must be installed.
- When 2-sided originals are used, the front of each original is stamped twice.
- If an error occurs during scanning, an original that was not scanned may be stamped.
- When the "O" mark that is stamped on originals starts to become faint, replace the stamp cartridge.  
For the procedure for replacing the stamp cartridge, see "[REPLACING THE STAMP CARTRIDGE \(page 1-160\)](#)".

**1**

## Place originals in the automatic document feeder.

- ▶ [AUTOMATIC DOCUMENT FEEDER \(page 1-116\)](#)

**2**

## Tap the mode display to switch to the initial screen of each mode.

- ▶ [CHANGING MODES \(page 1-13\)](#)

**3**

## Specify the destination.

- ▶ [RETRIEVING A DESTINATION FROM AN ADDRESS BOOK \(page 4-14\)](#)
- ▶ [VIEWING A LIST OF THE SELECTED DESTINATIONS \(page 4-18\)](#)
- ▶ [USING A SEARCH NUMBER TO RETRIEVE A DESTINATION \(page 4-19\)](#)
- ▶ [ENTERING AN ADDRESS MANUALLY \(page 4-20\)](#)
- ▶ [SPECIFYING A NETWORK FOLDER \(page 4-21\)](#)
- ▶ [RETRIEVING A DESTINATION FROM A GLOBAL ADDRESS BOOK \(page 4-23\)](#)
- ▶ [USING A TRANSMISSION LOG TO RESEND \(page 4-25\)](#)



4

**Tap [Verification Stamp] on the action panel or [Others] key, and tap the [Verif. Stamp] key.**

The appropriate icon or checkbox is selected.

If you tap the [Others] key, tap the [Back] key after the settings have been completed.



**To cancel the verification stamp setting:**

Tap [Verification Stamp] on the action panel or the [Others] key, and tap [Verif. Stamp] to clear the checkmark.

5

**Tap the [Start] key to start scanning of the original.**

A beep will sound to indicate that scanning and transmission have ended.



Tap the [Preview] key to check the preview of an image. For more information, see "[CHECKING THE IMAGE TO BE TRANSMITTED \(page 4-58\)](#)". However, settings for this function cannot be changed in the preview screen.



# AUTOMATICALLY ADJUST SKEWED PDF SCAN DATA (PDF SKEW ADJUSTMENT)

When the original is skewed, or when images within the original are skewed, this automatically corrects the skewing, and saves as a PDF format document.

## PDF FORMATS THAT CAN USE PDF SKEW ADJUSTMENT

All PDF formats can use this function.

### PDF format

PDF, Encrypt PDF, Compact PDF, Compact PDF (Ultra Fine), Encry./Compact PDF, Encrypt/Compact PDF (Ultra Fine), PDF/A-1a, PDF/A-1b, Compact PDF/A-1a, Compact PDF/A-1a (Ultra Fine), Compact PDF/A-1b, Compact PDF/A-1b (Ultra Fine)

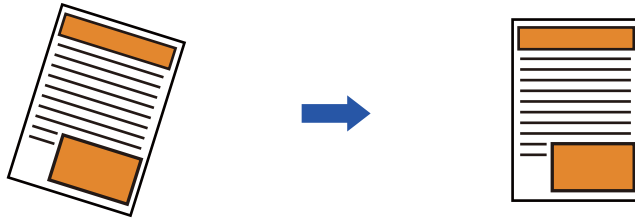

- The post-adjustment image is not shown in preview images, and is displayed as it was scanned.
- If adjustment is not required and text and images are on an angle for design reasons, adjustment may still occur automatically.
- If there is little text or image data in the original, this may not be adjusted regardless of the degree of skewing.
- For card shot, this function cannot be used.
- Depending on the degree of skew, correction may not be possible.

1

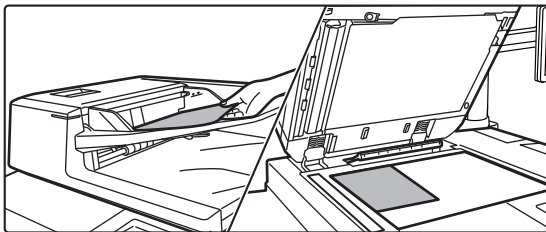

### Place the original.

Place the original in the document feeder tray of the automatic document feeder, or on the document glass.

- [AUTOMATIC DOCUMENT FEEDER \(page 1-116\)](#)
- [DOCUMENT GLASS \(page 1-120\)](#)

2

### Tap the mode display to switch to the initial screen of each mode.

- [CHANGING MODES \(page 1-13\)](#)



## 3

**Specify the destination.**

- ▶ [RETRIEVING A DESTINATION FROM AN ADDRESS BOOK \(page 4-14\)](#)
- ▶ [VIEWING A LIST OF THE SELECTED DESTINATIONS \(page 4-18\)](#)
- ▶ [USING A SEARCH NUMBER TO RETRIEVE A DESTINATION \(page 4-19\)](#)
- ▶ [ENTERING AN ADDRESS MANUALLY \(page 4-20\)](#)
- ▶ [SPECIFYING A NETWORK FOLDER \(page 4-21\)](#)
- ▶ [RETRIEVING A DESTINATION FROM A GLOBAL ADDRESS BOOK \(page 4-23\)](#)
- ▶ [USING A TRANSMISSION LOG TO RESEND \(page 4-25\)](#)

## 4

**Tap the [Others] key, and tap the [PDF Skew Adjustment] key.**

A checkmark appears on the icon. When you have completed the setting, tap the [Back] key.

**To cancel the PDF Skew Adjustment setting**

Tap the [PDF Skew Adjustment] key to remove the checkmark.

## 5

**Tap the [Start] key to start scanning of the original.**

When scanning finishes, place the next original and tap the [Start] key.  
Repeat until all pages have been scanned and then tap the [Read-End] key.  
A beep will sound to indicate that transmission has ended.



# SPECIFIC FUNCTIONS

## ADDING A SIGNATURE WHEN SENDING AN IMAGE (ELECTRONIC SIGNATURE)

You can add a signature when sending a scanned image. This allows the recipient to check your sender information in the electronic signature.



This function is available for Scan to E-mail.



### To add an electronic signature to a scanned image

- In "Settings (administrator)", select [System Settings] → [Security Settings] → [S/MIME Settings] → [Condition Settings].
- When [Select at Sending] is selected in "Sign E-mail" in "Settings (administrator)", you can specify whether or not an electronic signature is added each time you send an image. When [Always Enable] is selected, the setting cannot be changed.

**1**

### Place the original.

Place the original in the document feeder tray of the automatic document feeder, or on the document glass.

- ▶ [AUTOMATIC DOCUMENT FEEDER \(page 1-116\)](#)
- ▶ [DOCUMENT GLASS \(page 1-120\)](#)

**2**

### Tap the mode display to switch to the initial screen of E-mail mode.

- ▶ [CHANGING MODES \(page 1-13\)](#)

**3**

### Specify the destination.

- ▶ [RETRIEVING A DESTINATION FROM AN ADDRESS BOOK \(page 4-14\)](#)
- ▶ [VIEWING A LIST OF THE SELECTED DESTINATIONS \(page 4-18\)](#)
- ▶ [USING A SEARCH NUMBER TO RETRIEVE A DESTINATION \(page 4-19\)](#)
- ▶ [ENTERING AN ADDRESS MANUALLY \(page 4-20\)](#)
- ▶ [SPECIFYING A NETWORK FOLDER \(page 4-21\)](#)
- ▶ [RETRIEVING A DESTINATION FROM A GLOBAL ADDRESS BOOK \(page 4-23\)](#)
- ▶ [USING A TRANSMISSION LOG TO RESEND \(page 4-25\)](#)

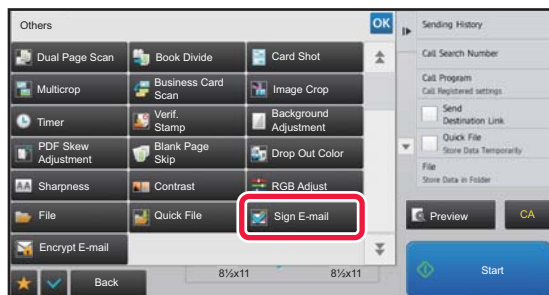
**4**

### Tap the [Others] key, and tap the [Sign E-mail] key.

A checkmark appears on the icon.

After the settings are completed, tap the [Back] key.



### To cancel the sign E-mail setting

Tap the [Sign E-mail] key to uncheck it.



5

### Tap the [Start] key to start scanning of the original.

- If you inserted the original pages in the document feeder tray, all pages are scanned. A beep will sound to indicate that scanning and transmission have ended.
- When you place the original on the document glass, scan each page one at a time. When scanning finishes, place the next original and tap the [Start] key. Repeat the procedure until all pages have been scanned and then tap the [Read-End] key. A beep will sound to indicate that scanning and transmission have ended.



You can tap the [Preview] key to check a preview of the image before sending an image. For more information, see "[CHECKING THE IMAGE TO BE TRANSMITTED \(page 4-58\)](#)".



# ENCRYPTING THE TRANSMITTED DATA (ENCRYPTION)

You can encrypt the transmitted data to strengthen security.



This function is available for Scan to E-mail.



## To encrypt transmitted data

- In "Settings (administrator)", select [System Settings] → [Security Settings] → [S/MIME Settings] → [Condition Settings].
- When [Select at Sending] is selected in "Encrypt E-mail" in "Settings (administrator)", you can specify whether or not the data is encrypted each time you send an image. When [Always Enable] is selected, the setting cannot be changed.

### 1

## Place the original.

Place the original in the document feeder tray of the automatic document feeder, or on the document glass.

- ▶ [AUTOMATIC DOCUMENT FEEDER \(page 1-116\)](#)
- ▶ [DOCUMENT GLASS \(page 1-120\)](#)

### 2

## Tap the mode display to switch to the initial screen of E-mail mode.

- ▶ [CHANGING MODES \(page 1-13\)](#)

### 3

## Specify the destination.

- ▶ [RETRIEVING A DESTINATION FROM AN ADDRESS BOOK \(page 4-14\)](#)
- ▶ [VIEWING A LIST OF THE SELECTED DESTINATIONS \(page 4-18\)](#)
- ▶ [USING A SEARCH NUMBER TO RETRIEVE A DESTINATION \(page 4-19\)](#)
- ▶ [RETRIEVING A DESTINATION FROM A GLOBAL ADDRESS BOOK \(page 4-23\)](#)



- Data encryption is not possible when the address is directly entered.
- Encrypted data can only be sent to an address for which you have registered a user certificate. Register a user certificate for the address in "Settings (Web version)" - [Address Book] → [E-mail] → "User Certificate". Only one E-mail address can be registered for an address that has a user certificate.
- If the "Disable sending to the addresses which cannot be encrypted." checkbox is () in "Settings (administrator)" - [System Settings] → [Security Settings] → [S/MIME Settings] → [Condition Settings] → [Encryption Settings], addresses without a user certificate cannot be selected. When the checkmark is removed () , the data is sent without encryption.

### 4



## Tap the [Others] key, and tap the [Encrypt E-mail] key.

A checkmark appears on the icon.

After the settings are completed, tap the [Back] key.



## To cancel the encryption setting

Tap the [Encrypt E-mail] key to remove the checkmark.





5

### Tap the [Start] key to start scanning of the original.

- If you inserted the original pages in the document feeder tray, all pages are scanned. A beep will sound to indicate that scanning and transmission have ended.
- When you place the original on the document glass, scan each page one at a time. When scanning finishes, place the next original and tap the [Start] key. Repeat the procedure until all pages have been scanned and then tap the [Read-End] key. A beep will sound to indicate that scanning and transmission have ended.



You can tap the [Preview] key to check a preview of the image before sending an image. For more information, see "[CHECKING THE IMAGE TO BE TRANSMITTED \(page 4-58\)](#)".



# SCANNING FROM A COMPUTER (PC Scan Mode)

## BASIC SCANNING PROCEDURE

You can install the scanner driver on your computer and use a TWAIN\* compliant application to scan an image using your computer.

Scanning from your computer is most useful for scanning a single original such as a photo, particularly when you want to adjust scan settings as you scan. By contrast, scanning at the machine is most useful for continuous scanning of multiple originals.

\* An interface standard used for scanners and other image input devices. When the scanner driver is installed on your computer, you can use any TWAIN-compliant application to scan an image.



- For the procedures for installing the scanner driver and configuring settings, see the Software Setup Guide.
- The procedures for selecting the scanner driver and starting scanning vary depending on the TWAIN-compliant application. For more information, see the manual for the application or Help.
- When a large image is scanned at high resolution, the amount of data will be very large and scanning will take a long time. Be sure to select appropriate scan settings for the original (text, photo, etc.).

As an example, the procedure for scanning from the "Sharpdesk" application is explained below.

### [At the machine]



#### Prohibit PC Scan:

To enable the hold setting for received data print  
In "Settings (administrator)", select [System Settings] → [Image Send Settings] → [Common Settings] → [Enable/Disable Settings] → [Settings to Disable Transmission] → [Disabling of PC Scan].  
Prohibit PC Scan.

1

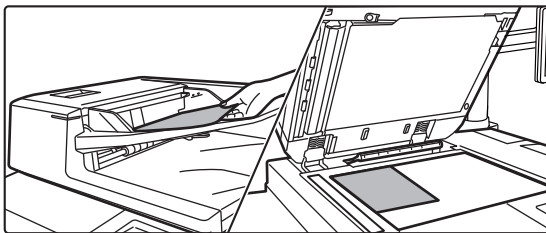

#### Place the original.

Place the original face up in the document feeder tray, or face down on the document glass.



2



**Tap the [PC Scan] mode icon to switch to PC Scan mode.**

If the [PC Scan] mode icon does not appear, tap  to move the screen.



When PC scan mode is selected, only the [Exit] key displayed in the touch panel can be used on the machine; no other keys can be used.

## [At your computer]

3

**Start the TWAIN-compliant application on your computer and select [Select Scanner] from the [File] menu.**

4

**Select the scanner driver of the machine.**

- (1) Select [SHARP MFP TWAIN K].
- (2) Click the [Select] button.

5

**Select [Acquire Image] from the [File] menu.**

The scanner driver opens.



6

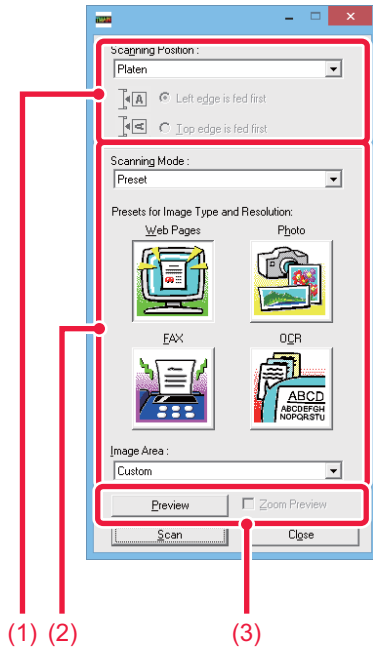

## Preview the image.

### (1) Select the location where the original is placed.

#### "Scanning Position" menu:

- If the original is a one-sided original and is placed in the document feeder tray, select [SPF(Simplex)].
- If the original is a 2-sided original and is placed in the document feeder tray, select [SPF(Duplex - Book)] or [SPF(Duplex - Tablet)] depending on whether the original is a book-style or tablet-style original. In addition, select [Left edge is fed first] or [Top edge is fed first] depending on the orientation of the original.

### (2) Select scan settings.

#### "Scanning Mode" menu:

Switch between the "Preset" screen and the "Custom Settings" screen. In the "Preset" screen, select "Web Pages", "Photo", "FAX" or "OCR" depending on the original type and your scanning purpose. If you wish to change the initial settings of any of the four buttons or select the resolution or other advanced settings, change to the "Custom Settings" screen.

#### "Image Area" menu:

Select the scan area. If "Auto" is selected, the original size detected by the machine will be scanned. You can also set the scanning area in the preview window with your mouse.

### (3) Click the [Preview] button.

The preview image will appear in the scanner driver. If you are not satisfied with the preview image, repeat (2) and (3).

If the [Zoom Preview] checkbox is selected before the [Preview] button is clicked, the selected area will be enlarged in the preview window. If the checkmark is removed, the preview image will return to normal. Note that if SPF is selected in the "Scanning Position" menu, the [Zoom Preview] function cannot be used.



- For further information on the scan settings, click the button in the preview image screen of step 7 to open scanner driver Help.
- If the [Preview] button is clicked when scanning from the document feeder tray, only one original page will be scanned for the preview image. If you wish to include that original in the scan, return it to the document feeder tray.



7

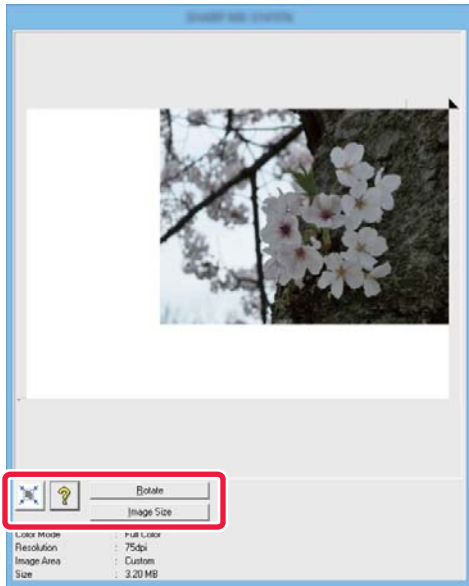

## Select scanning settings while viewing the image.

### [Rotate] button:

Each time this button is clicked, the preview image rotates 90 degrees. This lets you change the orientation of the image without picking up and placing the original again. The image file will be created using the orientation that appears in the preview window.

### [Image Size] button:

Click this button to specify the scan area by entering numerical values. Pixels, mm, or inches can be selected for the units of the numerical values. If a scanning area has already been specified, the entered numbers will change the area relative to the top left corner of the specified area.

### [?] button:

When a preview image is displayed and a scanning area is not specified, you can click the button to automatically set the scanning area to the entire preview image.



- For further information on the scan settings, click button to open scanner driver Help.
- If the originals are placed in the document feeder tray, only the top page will be previewed. The top page will be delivered to the original exit tray. Be sure to return the previewed page to the document feeder tray before previewing again or scanning.

8

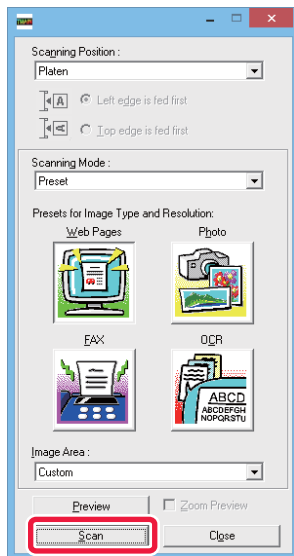

## Click the [Scan] button.

Scanning begins. The image appears in your application. Assign a file name to the scanned image and save it as appropriate in the software application you are using.



[At the machine]

9

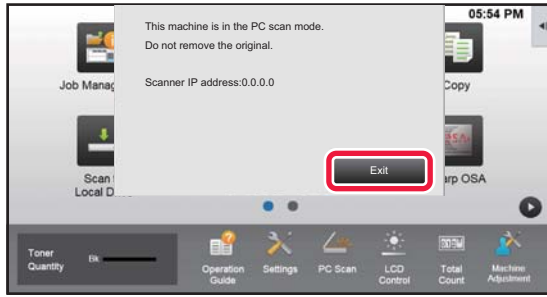

Tap the [Exit] key.

10

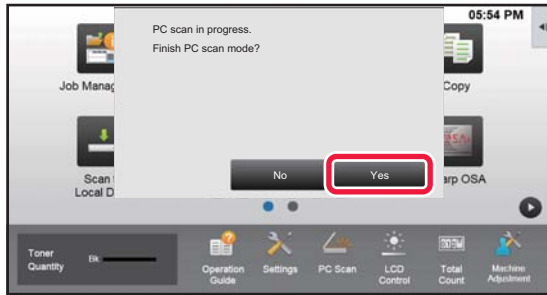

Tap the [Yes] key.



# METADATA DELIVERY

## PREPARATIONS FOR METADATA DELIVERY

### METADATA DELIVERY (DATA ENTRY)

When the application integration module kit is installed, metadata (data indicating the attributes of the image file and how it is to be processed) is generated based on pre-stored information and transmitted separately from an image file that is generated for sending a scanned image. The metadata file is created in XML format. By linking the metadata with applications such as document management software, a workflow application, or an encryption server, a sophisticated document solution environment can be built. Using the application integration module kit, information on a generated image file can be entered at the touch panel and transmitted along with the image as an XML file.

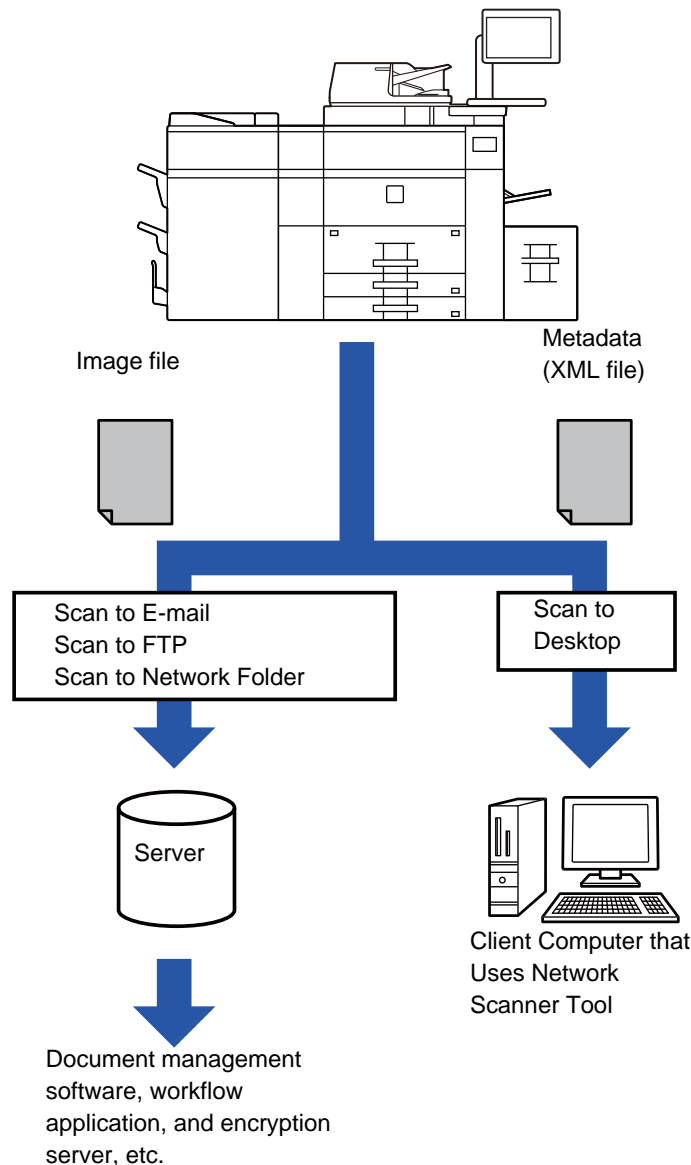



## SETTINGS REQUIRED IN THE SETTING MODE (WEB VERSION)

To configure the settings related to metadata, select [System Settings] → [Image Send Settings] → [Metadata Settings] → [Metadata Entry] in "Settings (administrator)". (Administrator rights are required.)  
Enable metadata delivery.

### Storing Metadata Sets

Store the items (the metadata set) to write to the XML file that will be generated during scanning. Up to 10 metadata items can be configured in a metadata set. A stored metadata set can be selected at the time of transmission.

Addresses specified in "Address Type Allowing Metadata Entry" when a metadata set is stored can be selected as transmission destinations at the time of transmission using one-touch keys, manual entry, or a global address book search. (Addresses for which metadata entry is not allowed cannot be specified as transmission destinations.)

## METADATA DELIVERY USING SCAN TO DESKTOP

When Network Scanner Tool is used in its factory default configuration, a file will be generated with a new file name on the PC.

When Network Scanner Tool is used as a means of sending a metadata file to a third party application, this setting must be disabled to allow cross referencing between the image file and XML file by means of the file name generated by the computer. (When setting the file name in [Options?], to ensure that an existing file on the PC is not overwritten by a transmitted file of the same name, be sure to configure the file name so that name duplication will not occur; for example, by including a unique extension (the date, etc.) in the generated file name. If the file name setting is left blank, the machine will automatically generate a unique file name.)



It is recommended that you use Network Scanner Tool to receive metadata.

#### **Using third party applications**

Various types of third party applications exist. Some applications can start automatically from Network Scanner Tool and some cannot.

When the auto-run function of an application is enabled, Network Scanner Tool will start the application with the ".exe" command using the image file name as a parameter. For example, when Network Scanner Tool is set to start application "APP.EXE", the "APP.EXE IMG.TIF" command is applied. If a file was specified to receive metadata, the metadata file name cannot be specified at the same time using the command to start the application directly. (However, the metadata file is stored in the same folder as IMG.TIF in the computer.)





# TRANSMITTING METADATA

## TRANSMITTING METADATA

Select a metadata set, enter each item, and perform metadata delivery.



Metadata delivery is performed using the document filing function. The [Data Entry] tab appears in the transmission settings screen of document filing mode to allow metadata delivery.

In addition, perform metadata delivery using document filing in [Metadata Entry] in "Settings (Web version)."



- **In data entry mode, configure metadata settings to perform metadata delivery.**

To perform transmission without sending metadata, switch the screen from data entry mode to a different mode and then perform transmission.

- When metadata settings have been configured or an address is specified in data entry mode, it will not be possible to switch to another mode.

- Before configuring metadata settings, specify addresses in all available modes. After metadata settings have been configured, specify only addresses in modes that are allowed in the selected metadata.

1

**Tap the [Data Entry] icon on the [Home Screen], and tap [Metadata Set].**



If a specific metadata set has been specified as the default set, go to step 3.



If no metadata sets have been stored, Metadata Entry is unavailable. Store metadata set in the setting mode (Web version) before performing transmission.

2

**Tap the key for the desired metadata set.**

3

**The keys of the items stored in the metadata set will appear. Tap the key of the item that you wish to enter.**

4

**Tap the key of the value that you wish to enter, and tap the [OK] key.**

To directly enter the metadata value, tap the [Direct Entry] key. On the soft keyboard screen that appears, tap the [OK] key. You will return to the screen shown in step 3.

After the settings are completed, tap **OK**.



To cancel the selection of the metadata value: Tap the [Clear] key.

5

**Configure image or other settings, and perform the scan send procedure.**

- Configure job detail settings and then start transmission using the same operations as in other modes.

- When directly entering an address, tap [Touch to input Address] to display the screen for selecting an address type. If the address type such as E-mail or Network Folder is selected, the address type entry screen appears.



## METADATA FIELDS

The following three types of metadata are included in the XML file that is transmitted.

- Data automatically generated by the machine

These data are always included in the XML file and are automatically stored on your PC.

- Previously defined fields

These fields are automatically recognized by the machine and assigned to appropriate XML tags. These fields can be selected, and can only be included in the XML file if they are enabled in the setting mode (Web version).

- User defined fields

Custom fields are added to the XML file. These fields can be selected and are defined in the setting mode (Web version).

If a defined metadata field is one of the following fields, a message will appear informing you that the field cannot be filled in. Enter appropriate information in the related items of the send settings.

| Name entered in metadata fields | Description   | Where entered  |
|---------------------------------|---|--|
| formName                        | Name of the user who sent the job. If the name is not entered as metadata, the sender name determined by the usual rules for determining the sender name will be applied as metadata. | [Reply-To]<br>(sender name of selected sender)   |
| replyTo                         | E-mail address to which the transmission result will be sent.   | [Reply-To]<br>(E-mail address of selected sender)  |
| documentSubject                 | Job name appearing in the E-mail "Subject" line. When the user enters a [Subject] in the send settings screen in the touch panel, the entered value is applied as metadata.           | [Subject]<br>(Blank until a value is set in the send settings screen.)   |
| fileName                        | Enter the file name of the image to be sent.  | [File Name]<br>(Only when the [Allow Custom Filenames] checkbox is selected in the metadata entry screen in the setting mode (Web version))<br>(Blank until a value is set in the send settings screen.) |



# METADATA SETTINGS

If the Application Integration Kit is installed, you can control the metadata to be used in other applications. The stored metadata is displayed on the metadata settings page. You can add a metadata, and edit or delete an existing metadata.

- **[Add] key**  
Adds a new metadata set.
- **List**  
Lists the currently stored metadata sets.

## Metadata Delivery

Enables or disables the metadata delivery function.

## Metadata Set Registration

When you tap the [Add] key, the registration screen appears. Up to 10 items can be stored. For information on the settings, see "[Settings \(page 4-121\)](#)".

## Edit or Delete Metadata Set

When you tap a title on the list, the edit screen appears for that metadata set. Tap the [Delete] key to delete the metadata set.

## Settings

| Item  | Settings   |
|---|--|
| Metadata Set Name                               | Enter a metadata name.   |
| Metadata Destination                            | Select a destination where you wish to send the image and metadata.  |
| Allow Custom Filenames                          | Enable or disable to edit the name of image file and XML file to be sent by the metadata send job.   |
| Address Type Allowing Metadata Entry            | Set the destination information to be used for metadata transmission.  |
| Name  | Enter a metadata name to be displayed on the touch panel.  |
| XML Tag Name                                    | XML Tag Name   |
| Entry Type                                      | <ul style="list-style-type: none"> <li>• Direct entry: Allows direct entry of each metadata from the soft keyboard or the numeric keypad.</li> <li>• Metadata list: Allows a selection of metadata from the previously entered data list. You must enter optional values for metadata selection in the input area. Entries must be separated by semicolons or commas. Each option can be comprised of up to 70 characters.</li> <li>• Initial entry by default: Uses a default value as the first value of the entered metadata list.</li> </ul> |
| Include MFP Extended Scan Settings in XML File. | When the machine generates metadata automatically, the "metadataSetName", "userLoginId" (if user authentication is used), "pageSize", and "imageMode" are added to the metadata.   |
| To Be Used as Default                           | The current metadata set is used as the default.   |



# DOCUMENT FILING

## Icons



Functions that you can use with Easy Scan

## DOCUMENT FILING

|   |            |
|---|------------|
| <b>DOCUMENT FILING</b> .....                                | <b>5-2</b> |
| • TYPES OF DOCUMENT FILING .....                            | 5-3        |
| • BEFORE USING SCAN TO LOCAL DRIVE IN DOCUMENT FILING ..... | 5-3        |
| • IMPORTANT POINTS WHEN USING DOCUMENT FILING .....         | 5-6        |
| • USING DOCUMENT FILING IN EACH MODE ...                    | 5-7        |
| <b>BASE SCREEN OF DOCUMENT FILING MODE</b> ...              | <b>5-8</b> |

## SAVING FILES WITH DOCUMENT FILING

|  |            |
|--|------------|
| <b>FILING WHILE USING ANOTHER MODE</b> ..... | <b>5-9</b> |
| • QUICK FILE .....                           | 5-9        |
| • FILE .....                                 | 5-10       |



|  |             |
|--|-------------|
| <b>SAVING DOCUMENT DATA ONLY (SCAN TO LOCAL DRIVE)</b> ..... | <b>5-15</b> |
| • SAVE ON LOCAL DRIVE .....                                  | 5-15        |
| • DEFAULT SETTING FOR SCAN SAVE .....                        | 5-17        |
| • SAVE IN EXTERNAL MEMORY DEVICE .....                       | 5-18        |

## USING STORED FILES

|   |             |
|---|-------------|
| <b>SEQUENCE FOR USING A STORED FILE</b> .....                           | <b>5-22</b> |
| <b>FILE SELECTION SCREEN</b> .....                                      | <b>5-24</b> |
| <b>SELECTING A FILE TO RETRIEVE</b> .....                               | <b>5-25</b> |
| <b>FILE PRINTING</b> .....  | <b>5-25</b> |
| <b>MULTI-FILE PRINTING</b> .....  | <b>5-27</b> |
| • MULTI-FILE PRINTING .....   | 5-27        |
| • BATCH PRINTING .....  | 5-28        |
| <b>FILE TRANSMISSION</b> .....  | <b>5-30</b> |
| <b>FILE MOVING</b> .....  | <b>5-31</b> |
| <b>DELETE FILE</b> .....  | <b>5-32</b> |
| • Automatic Deletion of File .....                                      | 5-33        |
| <b>FILE IMAGE CHECKING</b> .....  | <b>5-34</b> |
| <b>FILE MERGING</b> .....   | <b>5-35</b> |
| <b>RETRIEVING AND USING A FILE FROM THE JOB MANAGEMENT SCREEN</b> ..... | <b>5-36</b> |
| <b>FILE SEARCH AND RETRIEVAL</b> .....                                  | <b>5-37</b> |
| <b>PRINTING AN EXTERNAL FILE</b> .....                                  | <b>5-39</b> |
| <b>OPERATION IN THE WEB PAGE</b> .....                                  | <b>5-39</b> |



# DOCUMENT FILING

## DOCUMENT FILING

This function saves the original scanned on the machine, or print data from a computer on the local drive of the machine or an external memory device as data.

The stored files can be printed or transmitted as required. Editing of the stored files, for example combining, is also possible.



A PDF file created for PC browsing can be displayed or printed on a computer.

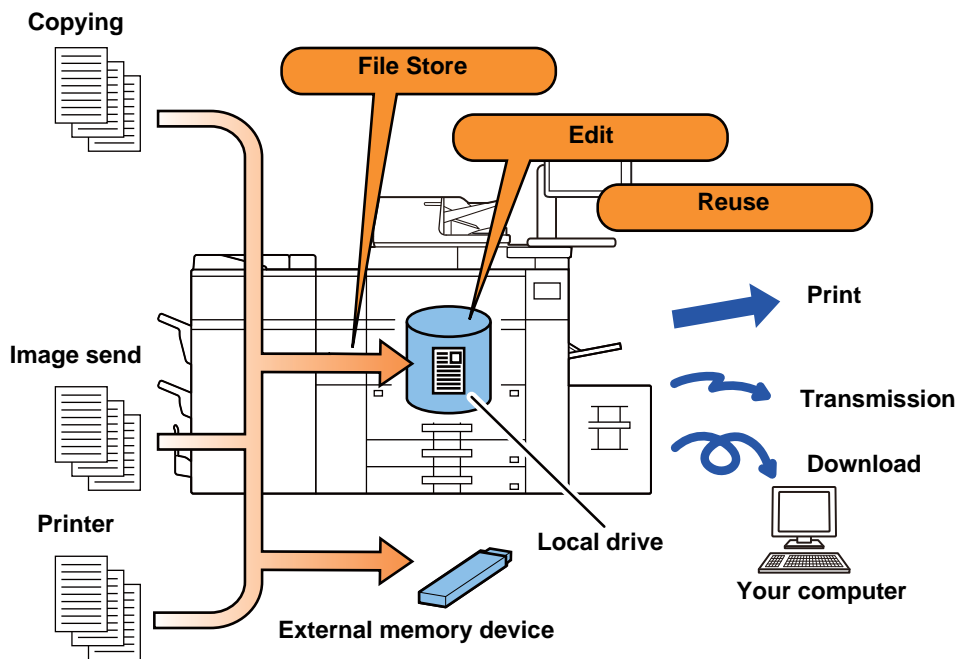

### Uses of document filing

Using the document filing function allows you to additionally print out conference material with the same settings, or print out ledger sheets used for routine tasks as required.

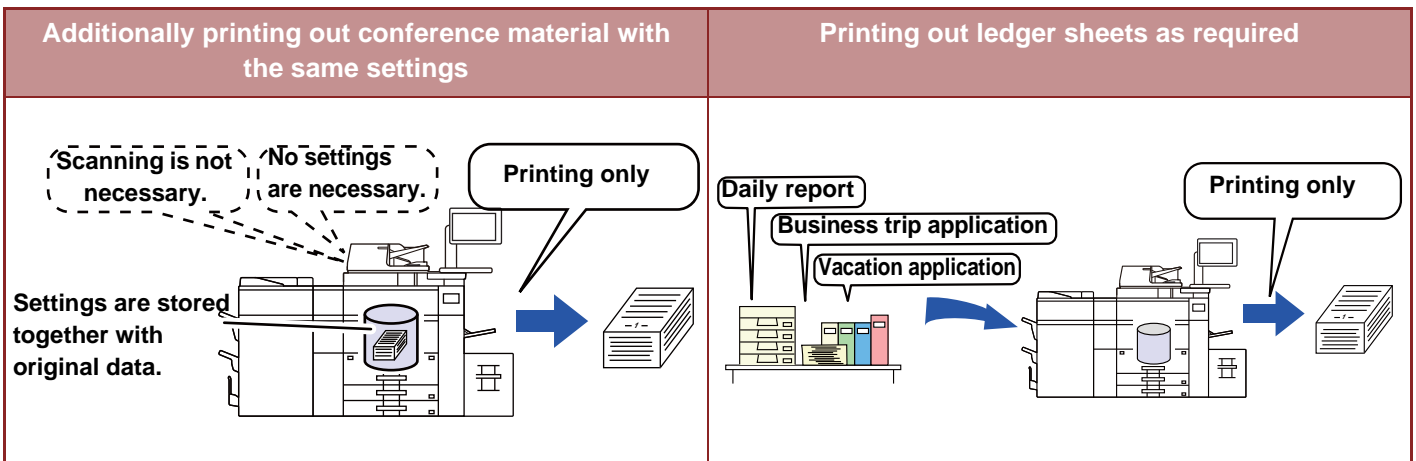



## TYPES OF DOCUMENT FILING

There are the following ways to save a file using document filing: [Quick File] and [File] in copy mode or image send mode, and [Scan to HDD] and [Scan to External Memory Device] in document filing mode.

|                                       |   |
|---------------------------------------|---|
| <b>Quick File</b>                     | As a copy, image send, or other job is performed, this function saves the document data to the local drive. Use this function when you want to quickly and easily store document data without specifying a file name or other information. The stored file can also be used by other people. Do not use this method to save files that you do not want others to use. |
| <b>File</b>                           | As a copy, image send, or other job is performed, this function saves the document data to the local drive. Unlike Quick File, various types of information can be appended to the file when the file is saved to enable efficient file management. A password can also be established.   |
| <b>Scan to HDD</b>                    | This function scans an original and stores it to the local drive. Like File, various types of information can be appended.  |
| <b>Scan to External Memory Device</b> | This function scans an original and stores it in an external memory device such as a USB memory device. Like File, various types of information can be appended.  |

## BEFORE USING SCAN TO LOCAL DRIVE IN DOCUMENT FILING

### Folder types

Three types of folders are used to store files on the local drive using the document filing function.

#### Folders on the local drive

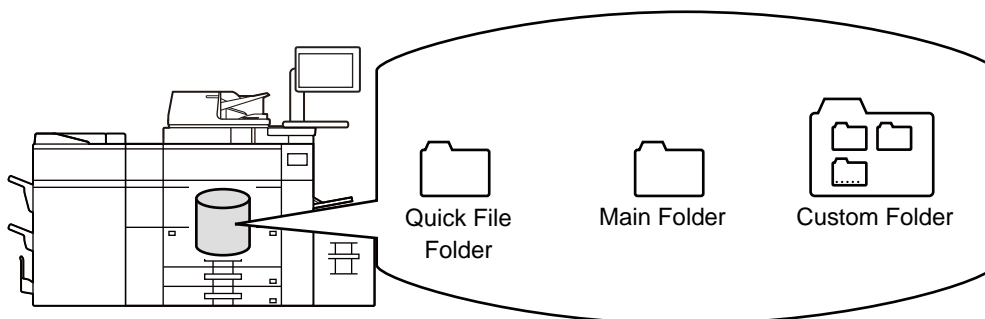

#### Quick File Folder

Documents scanned using [Quick File] on the action panel are stored in this folder. A user name and file name are automatically assigned to each job.

#### Main Folder

Scanned documents are stored in this folder.

When you store a job in the Main folder, you can specify a previously stored user name and assign a file name. A password (4 to 32 characters) can also be set when storing a file ("Confidential" save) as required.

#### Custom Folder

Folders with custom names are stored inside this folder.

Scanned documents are stored in the stored folder.

Like the Main folder, a custom folder allows you to specify a previously stored user name and assign a file name when storing a job.

Passwords (PIN code: 4 to 8 digits number) can be established for custom folders and for files saved in custom folders.



A maximum of 1000 custom folders can be created on the local drive

## Convenient items to store

When storing a job using [File] in copy mode or image send mode, or [Scan to HDD] in document filing mode, it is convenient to store the items below. These settings are not required when storing a job using [Quick File].

|                      |   |
|----------------------|---|
| <b>User Name</b>     | This is necessary if you will be assigning a user name to stored files. A user name is also used as a search condition when searching for a file.   |
| <b>Custom Folder</b> | The Main folder is initially available as a location for storing files by [File] and [File Store]. Store a custom folder and specify it as a location for storing files. Specify a password for the user folder as required. Enter the PIN Code to use the folder. When the folder is set a password, "  " appears in the folder that the password is set. |
| <b>My Folder</b>     | A previously created custom folder can be selected as "My Folder", or a new folder created as "My Folder". When "My Folder" has been configured and user authentication is used, "My Folder" will always be selected as the destination of [File] and [File Store].   |



- **To store a custom folder for document filing:**

On the Web page, select "Settings (administrator)" → [Document Operations] → [Document Filing] → [Custom Folder].

On the machine, select "Settings (administrator)" → [System Settings] → [Document Filing Settings] → [Document Filing Control] → [Custom Folder].



- **To store a user name and specify a folder as "My Folder":**

In "Settings (administrator)", select [User Control] → [User Settings] → [User List].





## Approximate number of pages and files that can be stored

Combined total number of pages and total number of files that can be stored in custom folders and in the Main folder

| Examples of original types  | Number of pages* | Number of files |
|---|------------------|-----------------|
| <b>Full color original</b><br>(Text and photo example)<br><br>Size: A4 | Max. 15000       | Max. 5000       |
| <b>Black &amp; white original</b><br>(Text)<br><br>Size: A4            | Max. 35000       |                 |

## Number of pages and number of files that can be stored in the Quick File folder

| Examples of original types  | Number of pages* | Number of files |
|---|------------------|-----------------|
| <b>Full color original</b><br>(Text and photo example)<br><br>Size: A4 | Max. 700         | Max. 1000       |
| <b>Black &amp; white original</b><br>(Text)<br><br>Size: A4            | Max. 2000        |                 |

\* The indicated numbers are guidelines for the number of pages that can be stored when all pages are full color, and when all pages are black & white.

Copying in sort mode uses the same memory area as the main folder and custom folder. For this reason, when too much data has been stored in the main folder and custom folder, it may not be possible to perform a large copy job using sort mode. Delete unnecessary files from the main folder and custom folder.

The original types above are examples to make the explanation easier to understand. The actual number of pages and number of files that can be stored will vary depending on the contents of the original images and the settings when the files are stored.





## Information added to files

When saving a file using "File", add the following information to distinguish it from other files.

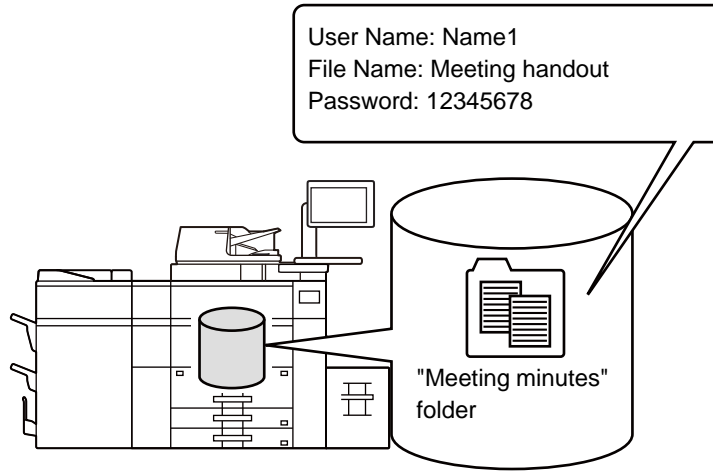

|                  |   |  |
|------------------|---|--|
| <b>User Name</b> | The user name is required to enter a file ownership and other information. The user name must be registered in advance. |  |
| <b>File Name</b> | Names a file.   |  |
| <b>Stored to</b> | Specifies a folder to store files.  |  |
| <b>Property</b>  | Sharing   | Any user can display and operate files having the "Sharing" property.                                  |
|                  | Protect   | Once "Protect" is set, its file cannot be edited, moved, and deleted. No password setting is required. |
|                  | Confidential  | You can set a password (4 to 32 characters) for file protection.                                       |



- The above information cannot be specified when a file is saved with Quick File.
- When you select [Create Downloadable File] in Scan to Local Drive and save as a confidential file, the properties cannot be changed.



### To store a user name:

In "Settings (administrator)", select [User Control] → [User Settings] → [User List].

## IMPORTANT POINTS WHEN USING DOCUMENT FILING

- Files stored using [Quick File] are provided with the "Sharing" property that can be accessed by any person for output and sending. Therefore, do not store sensitive documents or documents that you do not want to be used by others using the [Quick File] function.
- When saving a file with [File], you can save it with the "Confidential" property. Set a password for a "Confidential" file to prevent the file from being used by other people. Exercise care to prevent other people from obtaining the password.
- The property of a stored "Confidential" file can be changed to "Sharing" by "Property Change" as required. Do not store sensitive documents or documents that you do not want to be used by others.
- Except in cases provided for by law, SHARP Corporation bears no responsibility for any damages that result from the disclosure of sensitive information due to manipulation by a third party of any data saved using the Quick File function or File function, or incorrect operation of the Quick File function or File function by the operator who saves the data.



# USING DOCUMENT FILING IN EACH MODE

To use Document Filing, select the action panel for each mode.

To save data simultaneously with a copy tap [File] or [Quick File] on the action panel in each mode.

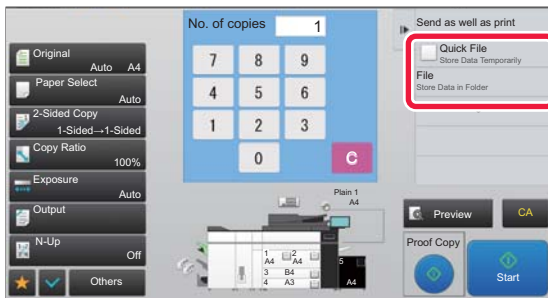

To use Document Filing from the beginning, select the action panel in the Document Filing mode. Tap any one of the keys to scan and save the original.

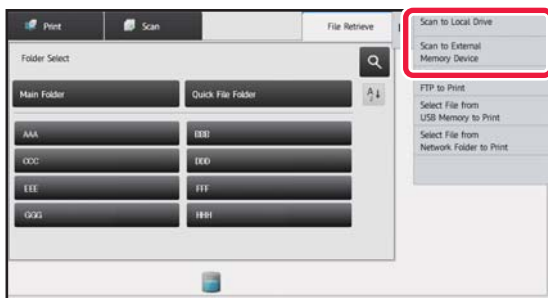

- **[File] and [Quick File]**  
These keys may not appear on the action panel depending on the mode or settings. In this case, tap [Others] on the base screen in each mode, and then tap [Quick File] or [File].
- **Using document filing in print mode**  
To use document filing in print mode, select document filing in the printer driver. For details on document filing, see "[SAVING AND USING PRINT FILES \(DOCUMENT FILING\) \(page 3-76\)](#)" in "PRINTER".



# BASE SCREEN OF DOCUMENT FILING MODE

The screenshot shows the 'Folder Select' screen in Document Filing Mode. At the top, there are buttons for 'Print' and 'Scan'. Below these are two tabs: 'Main Folder' and 'Quick File Folder'. The 'Main Folder' tab is active, displaying a grid of folders: AAA AAA, CCC CCC, EEE EEE, GGG GGG, BBB BBB, DDD DDD, FFF FFF, and HHH HHH. A search icon is located to the right of the folder grid. A dropdown menu is open, showing options: 'Scan to Local Drive', 'Scan to External Memory Device', 'Select File from FTP to Print', 'Select File from USB Memory to Print', and 'Select File from Network Folder to Print'. At the bottom center, there is a small icon representing the local drive usage status.

Use to save originals to be shared among users.

The folder for the registered user.

Use to save a file temporarily.

Use to search for a file in a folder.

Displays the functions available in document filing mode.

Switch the custom folder order between ascending and descending.

Resets all settings.

Displays the usage status of the machine's built-in local drive. Tap the key to display details.



# SAVING FILES WITH DOCUMENT FILING

## FILING WHILE USING ANOTHER MODE

### QUICK FILE

This function allows you to store an original in copy mode or image send mode as an image file in the Quick File folder of the machine.

The image file stored in quick file mode can be retrieved at a later time, allowing you to copy the document or transmit it in image send mode without having to locate the original.

As an example, the procedure for using "Quick File" in copy mode is explained below.



- Quick File can be used in normal mode.
- When a file is stored using Quick File, the following user name and file name are automatically assigned to the file.  
User Name: User Unknown  
File Name: Mode\_Month-Day-Year\_Hour-Minute-Second  
(Example: Copy\_10102020\_112030AM)  
Save location: Quick File Folder  
When user authentication is used, the user name that was used for login is automatically selected.  
Only the file name and location of a file stored in the Quick File folder can be changed.
- You can change the name of the sending file at scanner or resend transmission by system settings.



#### To delete all files in the Quick File folder with the exception of protected files:

In "Settings (administrator)", select [System Settings] → [Document Filing Settings] → [Condition Settings] → [Delete All Quick Files]. Configure settings to have all files deleted when the power is turned on as required.

# 1

### Place the original.

Place the original in the document feeder tray of the automatic document feeder, or on the document glass.

- [SELECTING A PROCEDURE FOR PLACING THE ORIGINAL DEPENDING ON THE TYPE AND STATUS OF THE ORIGINAL \(page 1-114\)](#)

# 2



Change to normal mode and tap [Quick File] on the action panel so that it is selected .



When a message relating to saving confidential information appears, tap the [OK] key.



### 3

#### Start a copy or image sending.

When the function is executed, the image data of the original is stored in the Quick File folder.



To prevent accidental saving of the file, the message "The scanned data is stored in the quick file folder." appears for 6 seconds (default setting) after the [Start] key ([Color Start] key or [B/W Start] key in copy mode) is tapped.

To change the message display time, in "Settings (administrator)" → [System Settings] → [Common Settings] → [Operation Settings] → [Condition Settings] → [Message Time Setting].



#### To cancel Quick File:

Tap [Quick File] to enable .

## FILE

Tapping the [File] key of the document filing function when printing or transmitting an original in each mode allows you to store the original in the Main folder or stored Custom folder as a file simultaneously with printing or transmission. The stored file can be retrieved at a later time, allowing you to recopy or resend the original without having to locate it. As an example, the procedure for using "File" in copy mode is explained below.



- File can be used in normal mode.
- When a file is stored using File without appending file information, the following user name and file name are automatically assigned to the file.  
User Name: User Unknown  
File Name: Mode\_Month-Day-Year\_Hour-Minute-Second  
(Example: Copy\_10102020\_112030AM)  
Save location: Main Folder
- You can change the name of the sending file at scanner or resend transmission by system settings.

### 1

#### Place the original.

Place the original in the document feeder tray of the automatic document feeder, or on the document glass.

- [SELECTING A PROCEDURE FOR PLACING THE ORIGINAL DEPENDING ON THE TYPE AND STATUS OF THE ORIGINAL \(page 1-114\)](#)



There are also cases where settings are required to be made before a preview is carried out.



2

## Change to normal mode and tap [File] on the action panel to specify the file information.

To select the user name, file name, folder, and property setting, see "[File Information \(page 5-12\)](#)".

To save on the local drive:

- ▶ [Changing the property \(page 5-12\)](#)
- ▶ [Specifying a user name \(page 5-13\)](#)
- ▶ [Assigning a file name \(page 5-13\)](#)
- ▶ [Specifying the folder \(page 5-13\)](#)
- ▶ [Creating PDF for PC browsing \(page 5-14\)](#)

To save in an external memory device:

- ▶ [Assigning a file name \(page 5-13\)](#)
- ▶ [Specifying the folder \(page 5-13\)](#)
- ▶ [Creating PDF for PC browsing \(page 5-14\)](#)

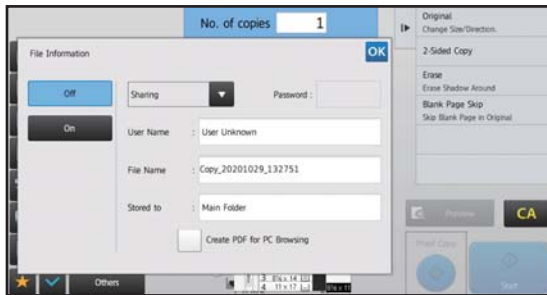

After configuring the above settings, you will return to this screen. Go to the next step.

If you do not wish to assign a user name or other information to the file, go to the next step.

3

## Tap **OK**.

You will return to the base screen of copy mode.

4

## Select copy settings and then tap the [Color Start] key or the [B/W Start] key.

- Simultaneously with starting copy, the original is stored as a file.  
The selected copy settings are also saved.
- For the procedure for placing the original, see "[SELECTING A PROCEDURE FOR PLACING THE ORIGINAL DEPENDING ON THE TYPE AND STATUS OF THE ORIGINAL \(page 1-114\)](#)".



## File Information

The procedure for detail settings is described below.

Specifying a property, user name, file name, and folder makes it easier to manage and search for a file. In addition, when [Confidential] is selected for Property and a password is established, other people will not be able to view the file without permission.

### Changing the property

A protect setting can be selected for files saved with the document filing function. This prevents a file from being moved, or automatically or manually deleted.

Three properties are available for saved files: "Sharing", "Protect", and "Confidential". When saved with the "Sharing" property, a file is not protected. When saved with the "Protect" or "Confidential" property, a file is protected.

Files saved to the Quick File folder are all saved as "Sharing" files. When a file is saved to the Main folder or a custom folder, "Sharing", "Protect" or "Confidential" can be selected.

|                     |  |
|---------------------|--|
| <b>Sharing</b>      | A "Sharing" file can be changed to "Protect" or "Confidential" using "Property Change" in the Job Settings.  |
| <b>Protect</b>      | "Protect" does not require setting of a password, but prevents a file from being moved, deleted or edited. A password cannot be established.   |
| <b>Confidential</b> | To protect a "Confidential" file, a password is set. (The password must be entered to retrieve the file.)<br>When a file is saved in encrypted PDF format, the file property is automatically set to "Confidential". |



#### • Restrictions on changing the property

- A file that is set to "Sharing" can be changed to "Protect" or "Confidential" as required. However, a "Sharing" file that is saved in the Quick File folder can only be changed to "Protect".
- A file that is set to "Protect" can be changed to "Sharing" or "Confidential" as required. However, a "Protect" file that is saved in the Quick File folder can only be changed to "Sharing".
- A file that is saved in the Quick File folder cannot be changed to "Confidential". If the file is moved to the Main folder or a custom folder, the property can be changed to "Confidential".
- Two properties cannot be selected for a single file.

#### • Default property settings for filing

To have "Confidential" be enabled by default when using Filing, select [Confidential Mode] in "Settings (administrator)" – [System Settings] → [Document Filing Settings] → [Condition Settings] → [Default Mode Settings].  
Administrator permission settings for confidential files.

#### • Administrator Authority Setting

For files and user folders that have a password, this setting allows the administrator password to be entered instead of the password when accessing the file or folder.

Also, you can change the preset ratio if necessary.

In "Settings (administrator)", select [System Settings] → [Document Filing Settings] → [Condition Settings] → [Administrator Authority Setting].

**1****Select [Property] in the File Information screen.****2****When you have selected [Confidential], enter a password (4 to 32 characters).**

Every time you enter one digit, " \* " is displayed.



## Specifying a user name

### 1 Tap the [User Name] text box.

When user authentication is used, the user name that was used for login is automatically selected. In this case, this step is not necessary.



The user name must first be stored by selecting [User Control] in "Settings (administrator)" → [User Settings] → [User List].

### 2 Tap the key of the user name.

Alternatively, you can select a user name by tapping the [Call with Registration Number] key and entering the user number. The user number must be first set by selecting [User Control] in "Settings (administrator)" → [User Settings] → [User List].

### 3 Tap **OK**.

The system goes back to the screen of step 1 to display the selected user name.

## Assigning a file name

A file name can be assigned to the file.

### 1 Tap the [File Name] text box and enter the file name.

Enter a file name using up to 30 characters.



#### File Name

- If a file name that already exists is specified, a tilde and a serial number are added after the file name and this file is saved as a different file. The file name is not case-sensitive.  
For example, if the "test.txt" file already exists and you specify the "TEST.TXT" file, the file will be saved as "TEST.TXT~1" file.
- If the length of the file name exceeds the limit, excess characters will be omitted and a serial number will be added to the end of the file name.

## Specifying the folder

Specify the folder for storing the file.

### 1 Tap the [Stored to] text box.

If a user name with a "My Folder" setting is selected, "My Folder" of that user will automatically be selected.

### 2 Tap the key of the folder where you want to store the file, and tap **OK**.

If a password has been set for the folder, a password entry screen appears. Enter the password (5 to 8 digits number) using the numeric keys and tap the **OK**.





## Creating PDF for PC browsing

Tap the [Create PDF for PC Browsing] checkbox to , and a public PDF for PC browsing will be created when the file is saved.



- Even if using the scanner function "[AUTOMATICALLY ADJUST SKEWED PDF SCAN DATA \(PDF SKEW ADJUSTMENT\) \(page 4-106\)](#)", correction results will not be reflected.

## Default Setting of PDF Format for PC Browsing

You can set the initial file format of public PDF or the file for download which is created during execution of each job. In "Settings (administrator)", select [System Settings] → [Document Filing Settings] → [Common Settings] → [Default Setting of PDF Format for PC Browsing].

### **B/W: Compression Mode**

None, MH (G3), MMR (G4)

### **Color / Grayscale: Compression Ratio**

Low, Medium, High

### **Settings during each job execution**

When each of copy, printer, scanner, or stored scan data is executed, you can specify to create a public PDF and to set the resolution of public PDF.



# SAVING DOCUMENT DATA ONLY (SCAN TO LOCAL DRIVE)

## SAVE ON LOCAL DRIVE

### Storing from Easy Scan

1

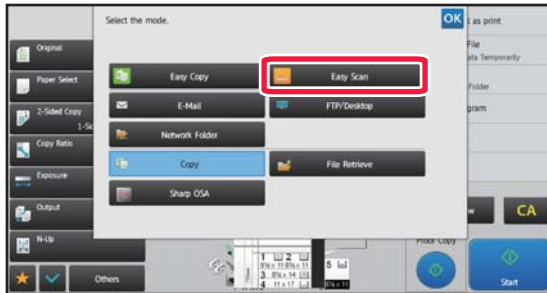

Tap the [Easy Scan] key on the mode display.

2

Tap [Scan to USB/Local Drive].

3

Place the original.

Place the original in the document feeder tray of the automatic document feeder, or on the document glass.

- ▶ [AUTOMATIC DOCUMENT FEEDER \(page 1-116\)](#)
- ▶ [DOCUMENT GLASS \(page 1-120\)](#)

4

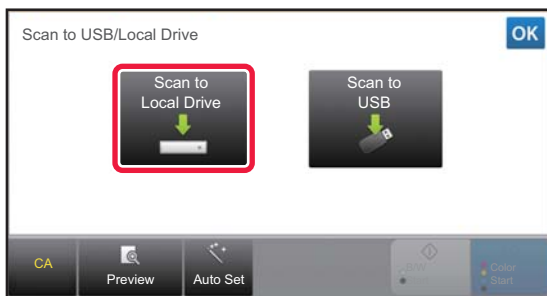

Tap [Scan to Local Drive].

5

To select settings, tap the key of each desired setting.

- ▶ [IMAGE SEND SEQUENCE \(page 4-9\)](#)

6

Tap the [Color Start] or [B/W Start] key to start scanning.

A beep will sound to indicate that scanning and file store have ended.



## Storing from Document Filing

**1**

Tap the [File Retrieve] key on the Home screen.

**2**

Tap [Scan to Local Drive] on the action panel.

**3**

Place the original.

Place the original in the document feeder tray of the automatic document feeder, or on the document glass.

► [AUTOMATIC DOCUMENT FEEDER \(page 1-116\)](#)

► [DOCUMENT GLASS \(page 1-120\)](#)

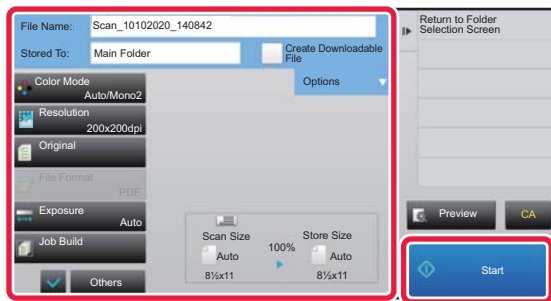
**4**

Check the file name and save location, and tap keys for any settings you want to select.



- When the [Create Downloadable File] checkbox is () , the [File Format] key is grayed out and cannot be used. You will not be able to download scan data in the specified format from the Web page.
- For original scan settings, see the explanation of the copy or image send mode.
- If the original is 2-sided, be sure to tap the [Original] key and then tap the [2-Sided Tablet] key or the [2-Sided Book] key as appropriate for the original.
- To set a user name, file attribute, or password, tap [Options].
- When a file is created with [Create Downloadable File] disabled, this setting cannot be enabled later.

**5**

Tap the [Start] key to start scanning.

A beep will sound to indicate that scanning and file store have ended.



## DEFAULT SETTING FOR SCAN SAVE

In "Settings (administrator)", select [System Settings] → [Document Filing Settings] → [Condition Settings] → [Image Orientation], [Default Color Mode Settings], [Default Exposure Settings], [Default Original Image Type], [Initial Resolution Setting], [Default Output Tray], [Erase Width Adjustment] and [Card Shot Settings].

### Image Orientation

Changes the image orientation.

### Default Color Mode Settings

Selects the default settings for black & white and color when Scan to Local Drive is used.

#### Disable Change of B/W Setting in Auto Mode

This setting disables selection of B/W settings from the base screen when the color mode is set to Auto.

### Default Exposure Settings

Default exposure settings for document filing can be configured.

Select [Auto] or [Manual].

If you select [Manual], set the exposure to one of 5 levels.

### Default Original Image Type

Select the original type beforehand to enable scanning at a resolution suitable for the original.

### Initial Resolution Setting

Resolutions can be selected for the default resolution for transmission.

### Default Output Tray

Selects the default output tray for printing a file stored by Scan to Local Drive.

The items that appear will vary depending the machine configuration.

### Disable Text/Stamp functions for Reprinting

Prohibit using Text/Stamp functions for Reprinting.

### Batch Print Settings

Configure the settings for using Batch Print.

### Print Order Setting for the Batch Print/Multi-File Print

Configure the print order settings when using Batch Print and Multi-File Print.

### Erase Width Adjustment

This is used to set the default erase width for erase function.

Specify a value from 0" (0 mm) to 1" (20 mm) in increments of 1/8" (1 mm) for both edge erase and center erase.

### Card Shot Settings

This is used to set the default original size for the card shot function.

Specify a value from 1" (20 mm) to 8-1/2" (210 mm) in increments of 1/8" (1 mm) for both the X (horizontal) and Y (vertical) dimensions of the original.

#### Fit to Store Size

Always displays the [Fit to Store Size] key on the card shot screen.



## SAVE IN EXTERNAL MEMORY DEVICE



### Prohibit saving to an external memory device

In "Settings (administrator)", select [System Settings] → [Image Send Settings] → [Common Settings] → [Enable/Disable Settings] → [Settings to Disable Transmission] → [Disable Storing to External Memory Device].  
Disables to store to the external memory device.

## Storing from Easy Scan

1



Tap the [Easy Scan] key on the mode display.

2

Tap [Scan to USB/Local Drive].

3

Place the original.

Place the original in the document feeder tray of the automatic document feeder, or on the document glass.

- ▶ [AUTOMATIC DOCUMENT FEEDER \(page 1-116\)](#)
- ▶ [DOCUMENT GLASS \(page 1-120\)](#)

4

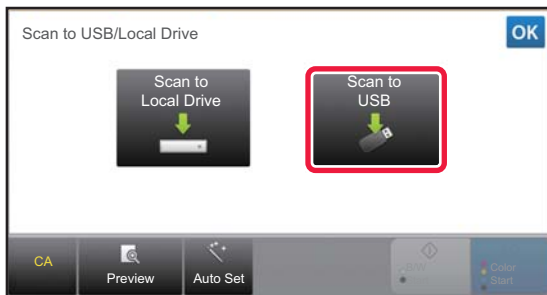

Tap [Scan to USB].

5

To select settings, tap the key of each desired setting.

- ▶ [IMAGE SEND SEQUENCE \(page 4-9\)](#)

6

Tap the [Color Start] or [B/W Start] key to start scanning.

A beep will sound to indicate that scanning and file store have ended.



## Storing from Document Filing

1

Tap the [File Retrieve] key on the Home screen.

2

Tap [Scan to External Memory Device] on the action panel.

3

**Place the original.**

Place the original in the document feeder tray of the automatic document feeder, or on the document glass.

- ▶ [AUTOMATIC DOCUMENT FEEDER \(page 1-116\)](#)
- ▶ [DOCUMENT GLASS \(page 1-120\)](#)

4

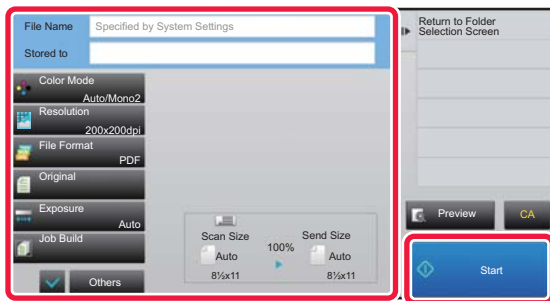

**Check the file name and save location, and tap keys for any settings you want to select.**



- For original scan settings, see the explanation of the copy or image send mode.
- If the original is 2-sided, be sure to tap the [Original] key and then tap the [2-Sided Tablet] key or the [2-Sided Book] key as appropriate for the original.

5

**Tap the [Start] key to start scanning.**

A beep will sound to indicate that scanning and file store have ended.



## Scan to USB memory device

1

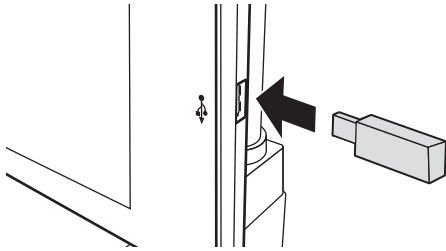

**Connect the USB memory device to the machine.**

- Use FAT32 or NTFS format for USB memory device.
- When the format of the USB memory device is FAT32, use a 32 GB or less USB memory device.

2

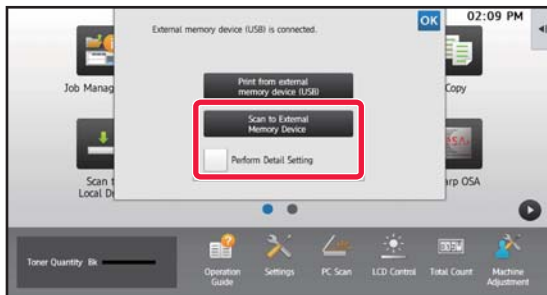

**When a screen for selecting the action appears, tap [Scan to External Memory Device].**

- To select detailed settings in normal mode, select the [Perform Detail Setting] checkbox .
- [NETWORK SCANNER MODE \(page 4-7\)](#)



If the machine/device save screen is open, this screen will not appear.

3

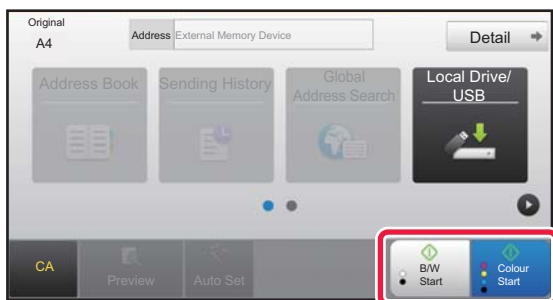

**Tap the [Color Start] key or [B/W Start] key.**

To check a preview of a document, tap the [Preview] key.

- [PREVIEW SCREEN \(page 1-14\)](#)

4

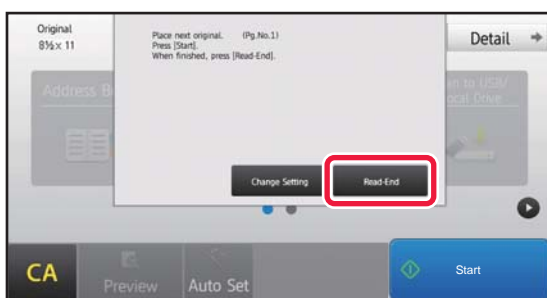

**After scanning all originals, tap the [Read-End] key.**



When you scan the original using the automatic document feeder, this screen does not appear.



5

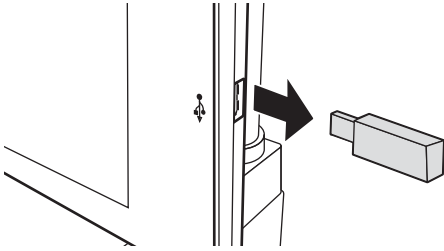

**Check the [Sending data has been completed.] message, and remove the USB memory device from the machine.**





# USING STORED FILES

## SEQUENCE FOR USING A STORED FILE

The screens and procedures differ depending on whether or not user authentication is enabled.

The sequence for using a stored file depending on the situation is explained.

For information on user authentication procedures, see "[USER AUTHENTICATION \(page 1-29\)](#)". For information on enabling user authentication and storing user names, see "[User Control \(page 1-37\)](#)".



Also in setting mode (Web version), you can use document filing. In setting mode (Web version), click [Document Operations] → [Document Filing], and then click the folder that contains the file you wish to use. You can also check a preview of a stored file in setting mode (Web version).

**1**

### Switch to document filing mode.

► [CHANGING MODES \(page 1-13\)](#)

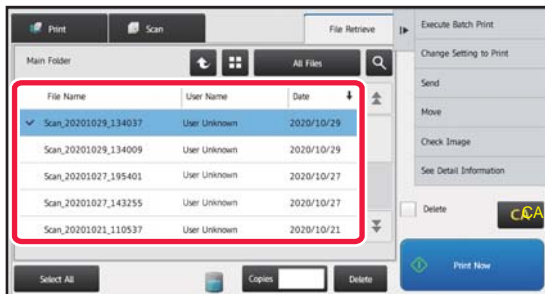
**2**

### Select the file that you wish to retrieve.

When the folder is selected, the files in the folder will appear.

Select the file that you wish to retrieve.

Select a file from the thumbnail images of the stored files.

► [FILE SELECTION SCREEN \(page 5-24\)](#)

► [SELECTING A FILE TO RETRIEVE \(page 5-25\)](#)

Retrieve a file using the search function.

► [FILE SEARCH AND RETRIEVAL \(page 5-37\)](#)

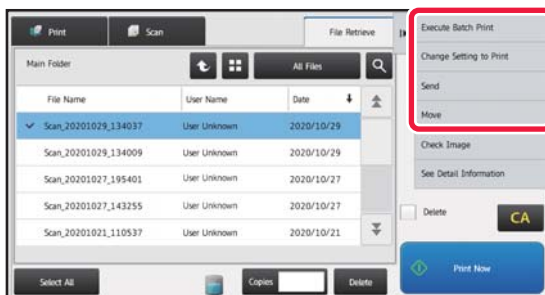
**3**

### Select an operation item.

Select the desired operation and configure settings.

► [FILE SELECTION SCREEN \(page 5-24\)](#)

► [FILE PRINTING \(page 5-25\)](#)

► [FILE TRANSMISSION \(page 5-30\)](#)

► [FILE MOVING \(page 5-31\)](#)

► [DELETE FILE \(page 5-32\)](#)

► [FILE IMAGE CHECKING \(page 5-34\)](#)

► [FILE MERGING \(page 5-35\)](#)



When retention is selected on the printer, reset items that cannot be set for retention do not appear.



## Document Output Options

The use of a stored file can be allowed or prohibited by operation type and by the mode from which the file was stored.

---



The items that appear will vary depending on the functions that have been added to the machine.

---

| Item                | Settings  |
|---------------------|---|
| Copy                | For each mode, select whether or not copying of stored files is allowed.      |
| Print               | For each mode, select whether or not printing of stored files is allowed.     |
| Scan Send           | For each mode, select whether or not transmission of stored files is allowed. |
| Scan to Local Drive | For each mode, select whether or not stored files is allowed.                 |



# FILE SELECTION SCREEN

The file selection screen can be displayed in "List" format or "Thumbnail" format to display thumbnail images of files.

## List display mode

Switch the file display mode between list and thumbnail.

Switch the file key displayed for each job type.

Search for a file saved in a folder.

Displays the functions that can be used.

Reset all settings.

Start printing immediately.

The number of copies set in [Copies] is valid when tapping [Print Now].

Tap this key to display the usage status of the machine's built-in local drive.

Select or clear all files. Tapping this key switches the key display mode between [Select All] and [Cancel All].

Return to the base screen of document filing mode.

Displays the saved files.

| File Name            | User Name    | Date       |
|----------------------|--------------|------------|
| Scan_20201029_134037 | User Unknown | 2020/10/29 |
| Scan_20201029_134009 | User Unknown | 2020/10/29 |
| Scan_20201027_195401 | User Unknown | 2020/10/27 |
| Scan_20201027_143255 | User Unknown | 2020/10/27 |
| Scan_20201021_110537 | User Unknown | 2020/10/21 |

## Thumbnail display mode

Switch the file display mode between list and thumbnail.

Displays thumbnails of the saved files.

## Sorting order

In "Settings (administrator)", select [System Settings] → [Document Filing Settings] → [Condition Settings] → [Sort Method Setting].

Selects an order of display files stored in the Main Folder, Custom Folder, and Quick File Folder. Select one of the following settings:

- File Name
- User Name
- Date



# SELECTING A FILE TO RETRIEVE

**1****Tap the [File Retrieve] key.**

When user authentication is enabled and "My Folder" is configured by selecting [User Control] in "Settings (administrator)" → [User List], the custom folder specified as "My Folder" opens.

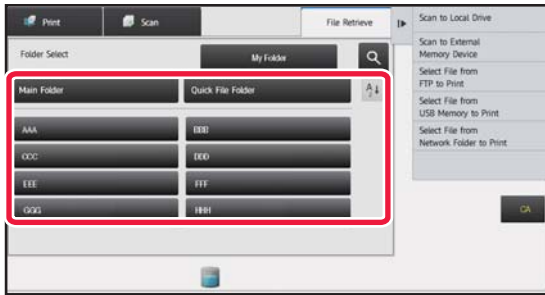
**2****Tap the key of the folder that contains the desired file.**

If the folder with a PIN Code is tapped, a PIN Code entry screen will appear.  
Enter the PIN Code (5 to 8 digits number) using the numeric keys and tap the **OK**.

**3****Tap the key of the desired file.**

If the folder with a PIN Code is tapped, a PIN Code entry screen will appear.  
Enter the PIN Code (5 to 32 characters) and tap the **OK**.



- Tap the [Print Now] key to print out the file with the settings used for its storage.
- Tap the [Filter by Job] key to display the keys of a particular mode such as copy or scanner mode, enabling quick data search.
- Tap the [File Name] key, the [User Name] key, or the [Date] key to change the order of display of the files.
- Select [User Control] in "Settings (administrator)" → [User Settings] → [User List] → [User Registration] → [Authority Group]. Then, in authority group setting for the users who are currently logged in, select [Job Settings] → [Document Filing] and enable [Display only the Files of Logged-in Users] to display only files stored by the users who are currently logged in.

## FILE PRINTING

A file stored using document filing can be retrieved and printed when needed. The settings used when the file was stored are also stored, and thus the file can be printed again using those settings. The file can also be modified before printing by changing the print settings.



- A file saved in black and white or grayscale cannot be printed in color.
- Print settings that are changed by re-manipulation of the file cannot be saved.
- The printing speed may be somewhat slow depending on the resolution and exposure mode settings of the stored file.
- When retention is selected on the printer, reset items that cannot be set for retention do not appear.

**Prohibiting of print system settings when reprinting**

In "Settings (administrator)", select [System Settings] → [Document Filing Settings] → [Condition Settings] → [Disable Text/Stamp functions for Reprinting]

When a stored file is retrieved and printed, the printing functions are disabled.

This function prevents an inconsistency of the date between the original data and output data and others.

**Process data after the file is printed**

In "Settings (administrator)", select [System Settings] → [Document Filing Settings] → [Condition Settings] → [Setting of store/delete after file print]

Select whether or not to save or delete a file after printing.



## Quick printing

Prints a file with the various settings used when it was saved. Select a file and tap the [Print Now] key.

To delete data after printing, set the [Delete] checkbox to .

To change the number of sheets to print, tap the [Copies] key and then use the numeric keys to set the number to print.

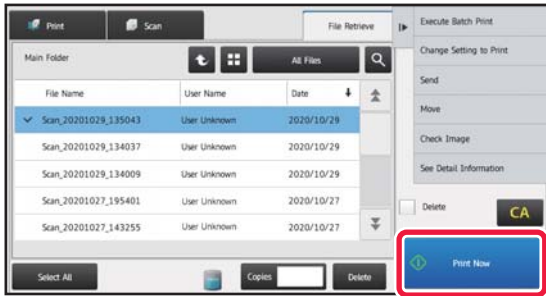

## Changing settings before printing

After selecting the desired file, follow the steps below.

► [SELECTING A FILE TO RETRIEVE \(page 5-25\)](#)

1

Tap [Choose Print Settings] on the action panel.

2

Change the print settings.

3

Select the [Delete] checkbox  when needed.

If you want to check the contents, tap [Proof Print].

4

Tap the [Start] key.

The file will be printed.



# MULTI-FILE PRINTING

## MULTI-FILE PRINTING

1

Select the keys of the multiple files that you wish to print.



- Confidential files cannot be printed simultaneously with other files.
- A file in the currently selected folder cannot be selected simultaneously with a file in a different folder.



- If the job type is changed with the By Job Display key or the screen is changed by  being tapped while a file is selected, the selection of the file will be canceled.

2

Tap [Print] on the action panel.

3

When not printing with the number of copies at data saving, tap the [Apply the Number from Stored Setting of Each Job.] checkbox to set to .

When printing with the number of copies at data saving without specifying copies, go to step 5.

4

Use   to specify the number of copies.

As required, directly tap the numeric value display key and change the value using the numeric keys.

5

To set the order of files to print, change with [Print Order]

6

To delete the file after printing, tap the [Delete] checkbox to set to .

7

Tap the [Start] key to start printing.



# BATCH PRINTING

## Batch Print Settings

In "Settings (administrator)", select [System Settings] → [Document Filing Settings] → [Condition Settings] → [Batch Print Settings].

Set whether or not the [All Users] key and the [User Unknown] key are prohibited in the user name selection screen when printing all files, whether files are sorted by date in newest or oldest order, and whether file names are sorted in ascending or descending order.

**1**

Tap the [Batch Print] key on the action panel

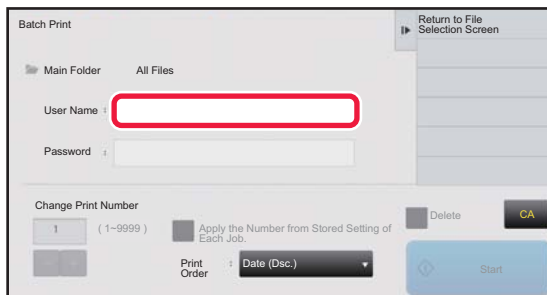
**2**

Tap the [User Name] text box.

**3**

Select the user name.

After selecting the user name, tap **OK**.



If you have selected [System Settings] in "Settings (administrator)" → [Document Filing Settings] → [Condition Settings] → [Batch Print Settings] and disabled the [Selection of [All Users] is not allowed.] checkbox and [Selection of [User Unknown] is not allowed.] checkbox, select the [All Users] key and [User Unknown] key.

If you tap the [All Users] key, all files in the folder (the files of all users) are selected.

If you tap the [User Unknown] key, all files in the folder with no user name specified are selected.

**4**

If a password has been established, tap the [Password] key.

Enter the password (4 to 32 characters) and tap **OK**. Only files that have the same password will be selected.

If you do not wish to enter a password, go to the next step.

**5**

When not printing with the number of copies at data saving, tap the [Apply the Number from Stored Setting of Each Job.] checkbox to set to .

When printing with the number of copies at data saving, go to step 7.

**6**

Use **- +** to specify the number of copies.

As required, directly tap the numeric value display key and change the value using the numeric keys.

**7**

To automatically delete the file after printing, tap the [Delete] key.



8

### Tap the [Start] key to start printing.

If there are no files that match the search conditions, you will return to the file list screen.



If [Delete the Data] on the action panel is tapped, all files that match the current search conditions will be deleted.

## Delete All Quick Files

All files in the Quick Save folder except for protected files can be deleted with “Settings (administrator)” – [System Settings] → [Document Filing Settings] → [Condition Settings] → [Delete All Quick Files].

However, the state of the machine may prevent some files from being deleted.

### Delete

Tap this key to start deletion of all files immediately.

### Delete quick files at power up. (Protected files excluded)

This is used to automatically delete all files in the Quick File Folder (with the exception of protected files) when the [Power] button is turned "On".





# FILE TRANSMISSION

The settings used when the file was stored with document filing are stored, and thus the file can be transmitted using those settings. If needed, you can also change the transmission settings to modify the retrieved file.

After selecting the desired file, follow the steps below.

► [SELECTING A FILE TO RETRIEVE \(page 5-25\)](#)



- A file saved in black and white or grayscale cannot be transmitted in color.
- A stored print job cannot be transmitted. (However, if the job was filed in the printer driver, it can be transmitted if "Rip Style" is set to [RGB]. This settings is accessed by selecting the [Other Settings] button on the [Detailed Settings] tab.)



- These transmission methods require installation of the corresponding options.
- If any of the following other modes were included in the saved file, the file cannot be transmitted. "Photo Repeat", "Multi-Page Enlargement" for copying.
- If any of the following other modes were included in the saved file, the file can be transmitted, but other functions cannot be executed. "Margin Shift", "Transparency Inserts", "Book Copy", "Tab Copy", "Stamp", all "Color Adjust" menu items, "Centering"
- Depending on the reduction or enlargement ratio used when storing a file, it may not be possible to send the stored file using a selected resolution setting. In this event, try changing the resolution.
- When the original job is not a Print Jobs, and the resend format is a PDF format, this function automatically corrects the skew and sends if the original is scanned while skewed. Since this functions is the same as the scanner function, see "[AUTOMATICALLY ADJUST SKEWED PDF SCAN DATA \(PDF SKEW ADJUSTMENT\) \(page 4-106\)](#)".

1

Tap [Send] on the action panel.

2

Select settings for sending.

3

Tap the [Start] key.



# FILE MOVING

Changes the file storage location. (The file is moved to another folder.)



A file whose property is "Protect" cannot be moved. To move a protected file, change its property to "Sharing" or "Confidential".

After selecting the desired file, follow the steps below.

► [SELECTING A FILE TO RETRIEVE \(page 5-25\)](#)

1

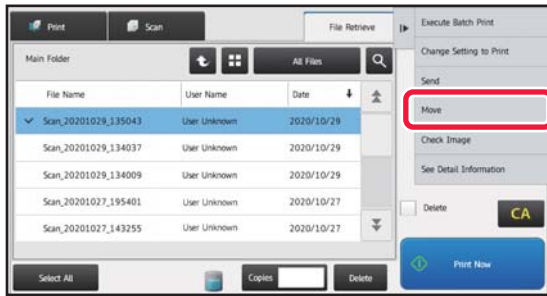

Tap [Move] on the action panel.

2

Tap the [Move to:] key.



- A file cannot be moved to the Quick File folder.
- To change the file name, tap the [File Name] key.

3

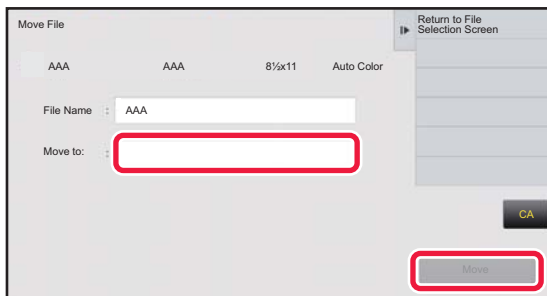

Tap the key of the folder to which you want to move the file.

If the folder with a password is tapped, a password entry screen will appear. Enter the password (5 to 8 digits number) using the numeric keys and tap the **OK**.



When multiple files are moved, file names cannot be changed.

4

Tap the [Move] key.



# DELETE FILE

Stored files that are no longer required can be deleted.



A file whose property is "Protect" cannot be deleted. To delete a protected file, change its property to "Sharing" or "Confidential".

After selecting the desired file, follow the steps below.

► [SELECTING A FILE TO RETRIEVE \(page 5-25\)](#)

1

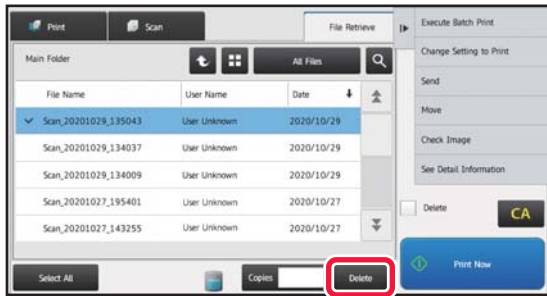

Tap the [Delete] key.

2



Check the file and then tap the [Yes] key.



## Automatic Deletion of File

You can have document filing data in specified folders automatically deleted by specifying the folders and the time. Periodic deletion of files stored in the machine helps to prevent the disclosure of sensitive information and frees space on the local drive.

### Automatic Deletion of File Settings

Document filing settings are described below. Tap the [Document Filing Settings] key to configure the settings. Time and folder settings can be configured to have files in specified folders (stored by document filing) automatically deleted at a specified time. Up to 3 settings can be stored to be automatically deleted.

The procedure for using this function is as follows:

- (1) Select [Setting 1], [Setting 2], or [Setting 3].
- (2) Set the time and date for automatic deletion.
- (3) Select the desired folder.
- (4) Specify whether or not protected files and confidential files are to be deleted.
- (5) Enable the stored settings.

| Item                     | Settings  |
|--------------------------|---|
| Schedule                 | Select an automatic deletion cycle. <ul style="list-style-type: none"><li>• Every Day: Auto deletion every day at the specified time.</li><li>• Every Week: Auto deletion at the specified time on the specified day of the week.</li><li>• Every Month: Auto deletion at the specified time on the specified day of the month.</li></ul> |
| Folders                  | To select the folder separately, select [Folder Select] and select the desired folder. To select all folders, including the folder currently being created, select [All Folders (Including folders registered hereafter)].  |
| Delete Protected File    | Enable this setting to include protected files in the deletion.   |
| Delete Confidential File | Enable this setting to include confidential files in the deletion.  |

### Delete Now

When this is executed with a folder selected, all files in the folder will be immediately deleted regardless of the date and time setting.

### Execute Auto Delete Setting at Auto Power Shut-Off

**(If this is not selected, the files will be deleted after the machine wakes from auto power shutoff mode.)**

Execute Auto Deletion even if Auto Power Shut-Off is enabled. When the checkbox is not selected (  ), the files will be deleted after the machine wakes from auto power shutoff mode.



# FILE IMAGE CHECKING

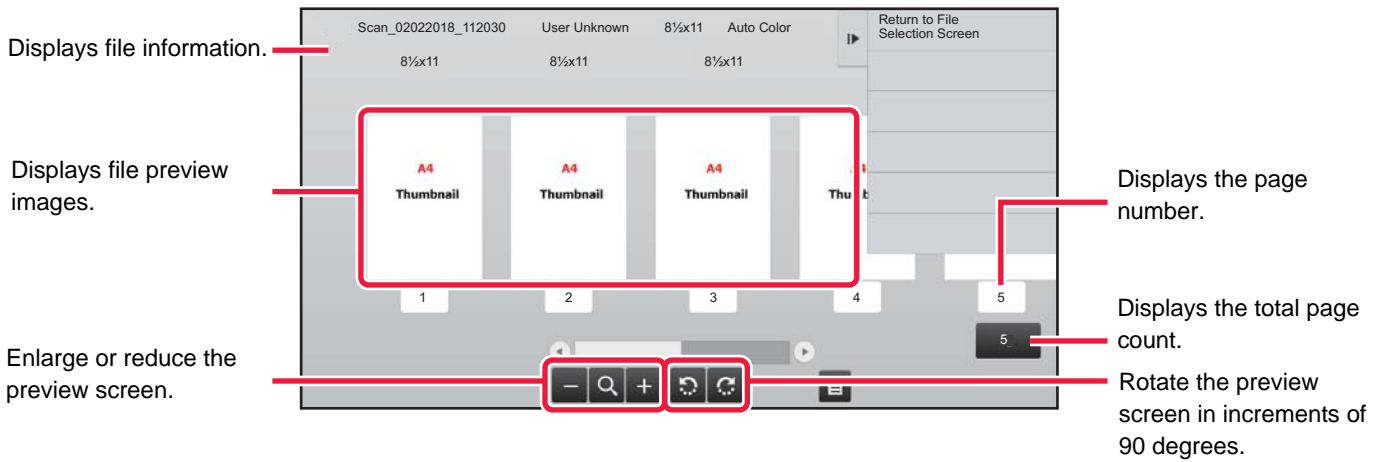

- Depending on the size of the image, part of the image may be clipped off in the image check screen on the touch panel.
- A preview image is an image for display on the touch panel. It will differ from the actual print result.
- The image check screen does not appear when multiple files are selected.

After selecting the desired file, follow the steps below.

▶ [SELECTING A FILE TO RETRIEVE \(page 5-25\)](#)

1

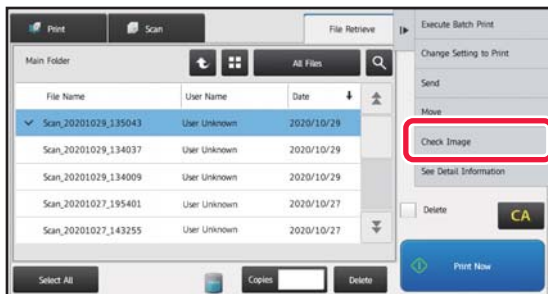

Tap [Check Image] on the action panel.

2

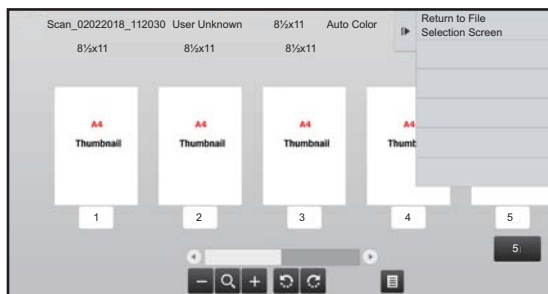

Check the image of the file.



# FILE MERGING

You can combine files that have been saved by Document Filing.



- If you have only selected a single file, the [Combine File] key is not displayed.
- The file name is a combination of "the first file name", "a tilde (~)", and "Serial No.". As required, change the file name at a later time.
- The files are joined in the selected order.

After selecting two desired files, follow the steps below.

► [SELECTING A FILE TO RETRIEVE \(page 5-25\)](#)

1

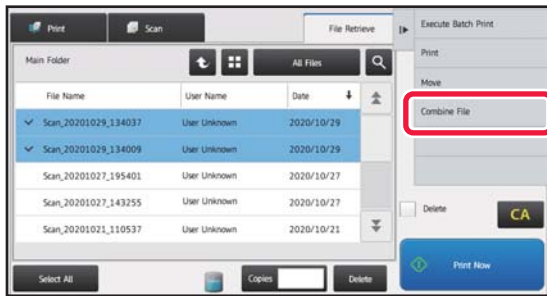

Tap [Combine File] on the action panel.

2

## Append file information.

To select the user name, file name, folder, and property setting, see "[File Information \(page 5-12\)](#)".

- [Changing the property \(page 5-12\)](#)
- [Specifying a user name \(page 5-13\)](#)
- [Assigning a file name \(page 5-13\)](#)
- [Specifying the folder \(page 5-13\)](#)
- [Creating PDF for PC browsing \(page 5-14\)](#)

To delete the original file, select the [Delete Original File] checkbox.

3

## Tap the [Execute] key.

Combining of files starts, and after the processing is finished, the "Combining complete" message appears.



To cancel the operation

Tap the [CA] key. Note that the operation cannot be canceled when the original file is being deleted after the files are combined.



# RETRIEVING AND USING A FILE FROM THE JOB MANAGEMENT SCREEN

Files stored using File and Quick File appear as keys in the job management complete screen. This is convenient when you need to quickly print the saved data of a copy job to another destination.

1

Tap the job management display.

2

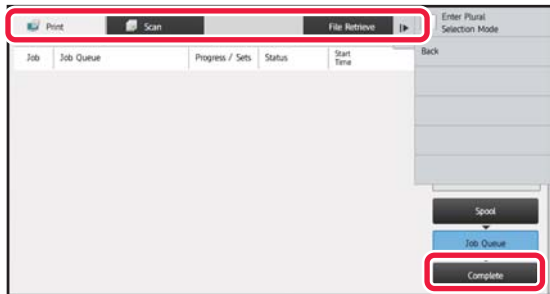

Tap the tab with a file to be retrieved, and tap the [Complete] key.

3

Tap the key of the desired file from the completed job.

A file that has been processed by Quick File or File can be selected for a job in the retrieve operation.

4

Tap [Send] or [Choose Print Settings] on the action panel.

- ▶ [FILE TRANSMISSION \(page 5-30\)](#)
- ▶ [FILE PRINTING \(page 5-25\)](#)



To view detailed information on a file, select the file, and then tap [Check Details of Selected Job] on the action panel.



# FILE SEARCH AND RETRIEVAL

When there are many stored files, it may take some time to locate a file. The search function of document filing mode can be used to find a file quickly.

Searching is possible even when you only know part of the file name or folder name. As required, a folder can also be specified as a search range.

**Example: Only part of a file name is known: "Conference"**

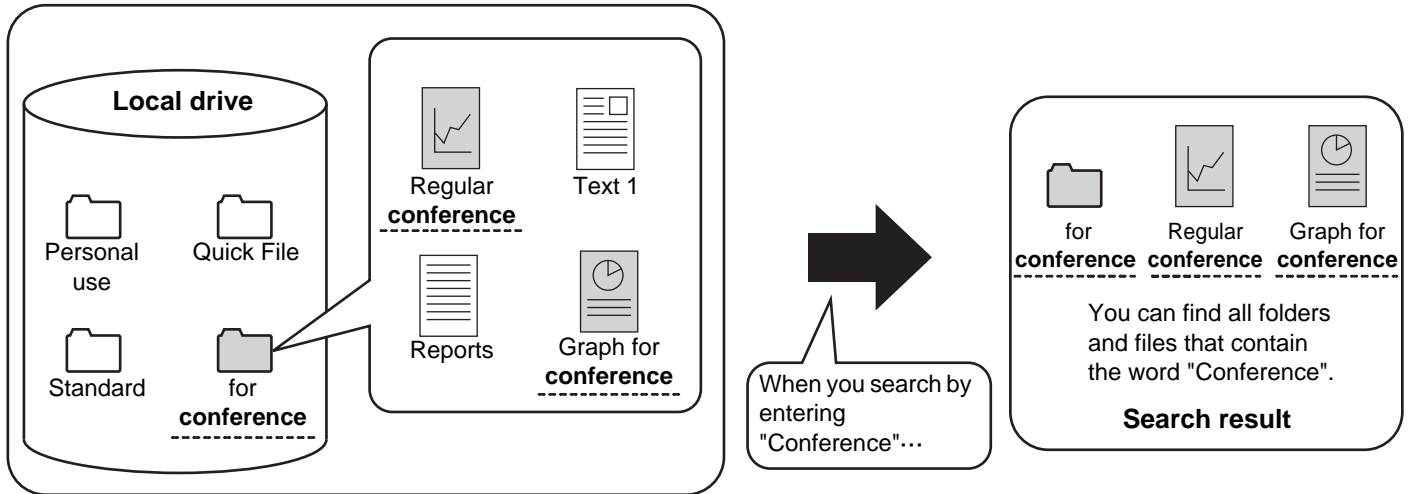

1



To search for a specific folder, tap its key.



If the folder with a password is tapped, a password entry screen will appear. Enter the password (5 to 8 digits number) using the numeric keys.

2

Tap .





3

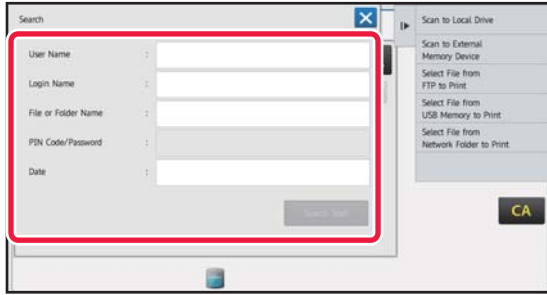

### Select search conditions.

Tap each text box and set the search condition.

To search for the current folder, set the [Search Just Within the Folder] checkbox to .

#### [User Name]

Search using the user name.

Select a user on the user selection screen that appears, and then tap **OK**.

#### [Login Name]

Search using the login name.

Enter the login name on the soft keyboard that appears and tap the [OK] key.

#### [File or Folder Name]

Search using the file name or folder name.

Enter the file name or folder name on the soft keyboard that appears and tap the [OK] key.

#### [PIN Code/Password]

Search for files that have a password set.

Enter the password with the soft keyboard that appears, and tap the [OK] key.

#### [Date]

Search using the date when the file was created.

When you have selected [Today] or [Date Set], set the time and date.

4

### Tap the [Search Start] key.

A list of the files that match your search conditions will appear. Select the desired file from the list. The job settings screen will appear.

To return to the base screen of document filing mode, tap the [CA] key.

To return to the file search screen, tap the [Search Again] key.



- When you search using [File or Folder Name], custom folders that match the search characters will also appear in the list. When a folder key is tapped, a list of the files in the folder appears. Tap the desired file in the list.
- Also in setting mode (Web version), you can use the file search function. Click [Document Operations] in "Settings (Web version)" → [Document Filing] → [Search].



# PRINTING AN EXTERNAL FILE

A file stored in the FTP server, USB memory device, or network folder of a PC can be printed. The file can also be modified before printing by changing the print settings.

On the action panel, tap [Select File from FTP to Print], [Select File from USB Memory to Print] or [Select File from Network Folder to Print].

For more information, see "[PRINTING WITHOUT THE PRINTER DRIVER \(page 3-81\)](#)".

# OPERATION IN THE WEB PAGE

Document Filing operations can be performed from the Web page using "Settings (Web)" - [Document Operations] → [Document Filing].

## Main Folder

The files that are in the Main Folder can be displayed. A specified file can be manipulated by clicking [Print], [Send], [Move], or [Delete]. If the file to be manipulated has a password, enter the password in "PIN Code/Password of File".

| Item               | Description  |
|--------------------|--|
| Display Style      | Saved files can be displayed in list format or thumbnail format. |
| Job Classification | The saved files that are displayed can be filtered by job.       |
| Display Items      | Set the number of files that are displayed.                      |

## Quick File Folder

Files in the Quick File Folder can be displayed. A specified file can be manipulated by clicking [Print], [Send], [Move], or [Delete].

| Item               | Description  |
|--------------------|--|
| Display Style      | Saved files can be displayed in list format or thumbnail format. |
| Job Classification | The saved files that are displayed can be filtered by job.       |
| Display Items      | Set the number of files that are displayed.                      |

## Custom Folder

The files that are in the Custom Folder can be displayed. A specified file can be manipulated by clicking [Print], [Send], [Move], or [Delete]. If the file to be manipulated has a password, enter the password in "PIN Code/Password of File".

| Item          | Description   |
|---------------|---|
| Index         | The displayed Custom Folder names can be filtered by index. |
| Display Items | Set the number of files that are displayed.                 |



## Search

Use these settings to enter search conditions. A specified file can be manipulated by clicking [Print], [Send], [Move], or [Delete]. If the file to be manipulated has a password, enter the password in “PIN Code/Password of File”.

| Item                      | Description   |
|---------------------------|---|
| User Name                 | Enter the user name. (Up to 32 characters)                    |
| Select from User List     | Click the [Setup] button and search for users from the list.  |
| Login Name                | Set the number of files that are displayed.                   |
| Search Folder             | Set the folder.   |
| File Name                 | Enter a file name. (Up to 30 characters)                      |
| PIN Code/Password of File | Enter the password that is set for the file (4 to 32 digits). |
| Stored Date               | Set the date and time the file was saved.                     |

## Search Result

Use these settings to enter search conditions. A specified file can be manipulated by clicking [Print], [Send], [Move], or [Delete]. If the file to be manipulated has a password, enter the password in “PIN Code/Password of File”.

| Item               | Description  |
|--------------------|--|
| Display Style      | The files that were found can be displayed in list format or thumbnail format. |
| Job Classification | The found files can be filtered by job.  |
| Display Items      | Set the number of files that are displayed.                                    |

## File Batch Print

Multiple files can be printed at once by batch printing. Search for the files using search conditions, and then select multiple files from the displayed search results.

If you want to use the number of copies set when each file was saved by Document Filing, select “Apply the Number of Copies Stored in Each File”. If you want to set a different number of copies, enter the desired number in “Enter the Number”. Click [Print] to print the file. To have the file deleted after printing, select the “Print and Delete the Data” checkbox.

| Item                      | Description  |
|---------------------------|--|
| <b>Search Condition</b>   |  |
| User Name                 | Enter the user name. (Up to 32 characters)                                     |
| Select from User List     | Click the [Setup] button and search for users from the list.                   |
| Search Folder             | Set the folder.  |
| File Name                 | Enter a file name. (Up to 30 characters)                                       |
| PIN Code/Password of File | Enter the password that is set for the file. (4 to 32 digits)                  |
| <b>Search Result</b>      |  |
| Job Classification        | The found files can be filtered by job.  |
| <b>Billing Code</b>       |  |
| Main Code                 | Select this checkbox, and then enter the main code.<br>(32 characters or less) |
| Sub Code                  | Select this checkbox, and then enter the sub code.<br>(32 characters or less)  |



# MANUAL FINISHING

## MANUAL FINISHING

|   |            |
|---|------------|
| <b>MANUAL FINISHING</b> .....                   | <b>6-2</b> |
| <b>SELECTING MANUAL FINISHING MODE</b> .....    | <b>6-3</b> |
| <b>BASE SCREEN OF MANUAL FINISHING MODE</b> ... | <b>6-3</b> |

## PAPERS

|  |            |
|--|------------|
| <b>CHECKING TYPE AND SIZE OF PAPER</b> ..... | <b>6-4</b> |
| <b>PAPER LOADING ORIENTATION</b> .....       | <b>6-5</b> |
| • <b>STAPLE</b> .....                        | <b>6-5</b> |
| • <b>PUNCH</b> .....                         | <b>6-6</b> |
| • <b>FOLD</b> .....                          | <b>6-6</b> |

## OPERATION OF MANUAL FINISHING

|   |             |
|---|-------------|
| <b>USING MANUAL FINISHING</b> .....                             | <b>6-8</b>  |
| <b>STAPLE FUNCTION</b> .....                                    | <b>6-10</b> |
| • <b>COPIES/PAGES FUNCTION</b> .....                            | <b>6-11</b> |
| • <b>TRIMMER SETTING</b> .....                                  | <b>6-12</b> |
| <b>PUNCH FUNCTION</b> .....                                     | <b>6-13</b> |
| <b>PAPER FOLDING FUNCTION</b> .....                             | <b>6-14</b> |
| • <b>MULTIPLE FOLD (WHEN SADDLE FOLD IS<br/>SELECTED)</b> ..... | <b>6-15</b> |
| <b>TO CHANGE THE PAPER TRAY</b> .....                           | <b>6-17</b> |
| <b>TO CHANGE THE OUTPUT TRAY</b> .....                          | <b>6-17</b> |



# MANUAL FINISHING

## MANUAL FINISHING

In manual finishing mode, you can set for finish on copied or printed pages.

You can select the manual finishing mode if the inserter is installed. When the finisher (large stacker), saddle stitch finisher (large stacker), punch module, or folding unit is installed, finishing operations, such as stapling, punching or folding can be performed.

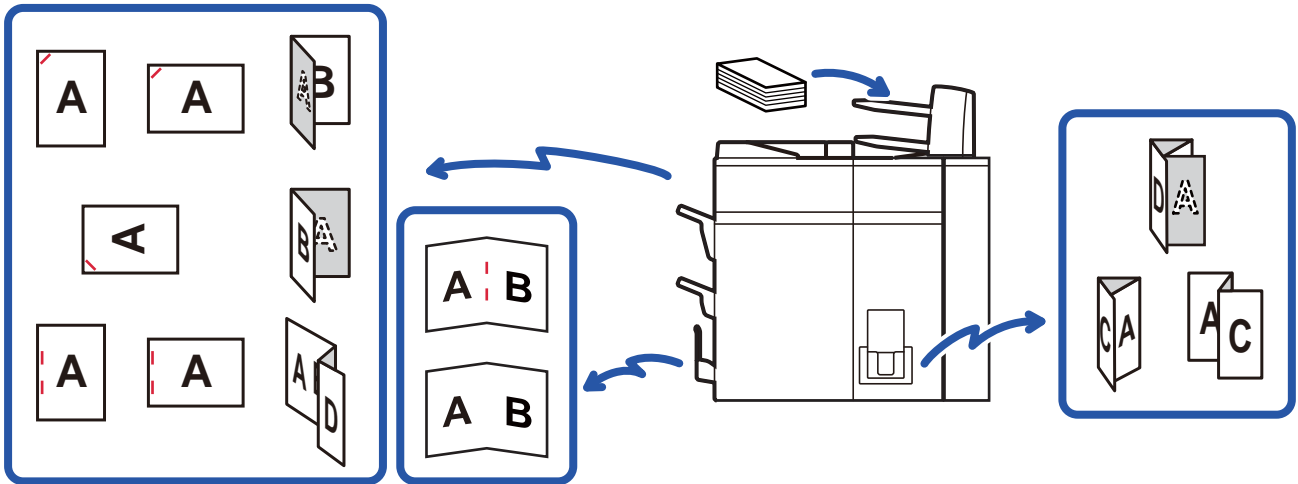

Manual finishing cannot be used if the use of manual finishing or inserter is prohibited in "Settings".



**To specify whether or not to prohibit the use of manual finishing or inserter:**

In "Settings (administrator)", select [System Settings] → [Common Settings] → [Operation Settings] → [Disable Manual Finishing] to set the use of manual finishing. Select [System Settings] → [Common Settings] → [Device Control] → [Disabling of Inserter] to set the use of the inserter.



# SELECTING MANUAL FINISHING MODE

Change the manual finishing mode to simple mode or normal mode as explained in "[CHANGING MODES \(page 1-13\)](#)".

## BASE SCREEN OF MANUAL FINISHING MODE

Shows the selected paper and output trays.

Selects an output tray for finished paper.

Staples each set of output.  
Selects a staple position.

Staples the center of the booklet and folds the booklet along the center.  
Trims the excessive parts of booklet folded along the center.

Punches holes in paper.

Performs paper folding.  
Selects the type of folding.

Selects a paper tray for finishing.  
Tap the [Type and Size] key to set the paper type and paper size.

Sets the number of copies for output and the number of sheets per set.

Resets all settings.

Starts finishing.

The screenshot shows a control panel with the following sections:
 

- Output Tray:** Upper Tray (selected), Middle Tray, Lower Tray.
- Inserter:** Upper Tray (Plain 1 8½x11), Lower Tray (Plain 1 8½x11), Type and Size.
- Staple:** Off, 1 Staple at Back, 1 Staple at Front, 2 Staples, Saddle Stitch.
- Punch:** Off, 2/3-Hole Punch.
- Fold:** Off, Accordion Fold, Saddle Fold, Double Fold, Half Fold, Z-Fold, C-Fold, Detail.
- Other controls:** Copies/Pages, CA (Reset), Start.



The display will vary depending on the devices installed.



# PAPERS

## CHECKING TYPE AND SIZE OF PAPER

You can check the type and size of paper loaded in the inserter on the display to the right of [Upper Tray] or [Lower Tray] key.

The paper size is automatically detected when paper is loaded. To set the paper type and size, tap the [Type and Size] key. Paper types and sizes can be specified for each of the upper and lower trays.

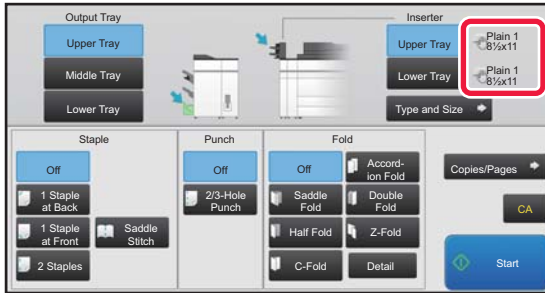

- If the paper loaded is different from the type that is indicated on the right of the key, tap the [Type and Size] key or change the settings in "Settings".
- Special media such as transparency film and tab paper cannot be used.



### To change the paper settings for the paper you load in the inserter:

Tap the [Type and Size] key or in "Settings", select [System Settings] → [Common Settings] → [Paper Settings] → [Paper Tray Settings] → [Inserter(Upper)] or [Inserter(Lower)].











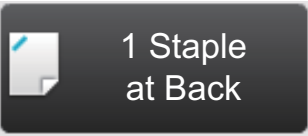
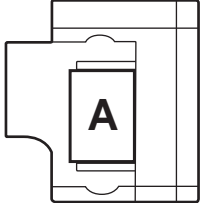

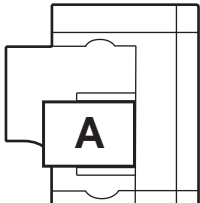
If the paper size is not correctly detected or paper of a non-standard size or type is loaded, specify this setting.

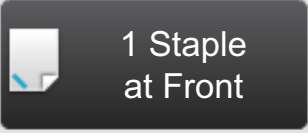
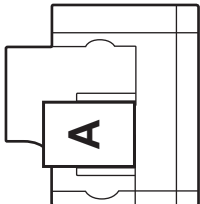

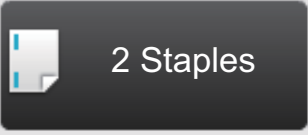
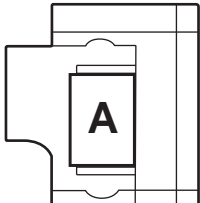
# PAPER LOADING ORIENTATION

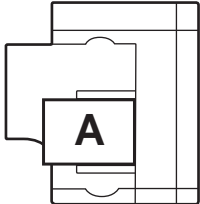
When using the staple, punch or the paper folding function, the original must be placed as shown below to enable stapling or punching in the desired position on the paper.

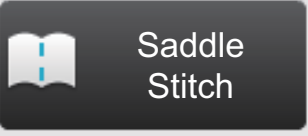
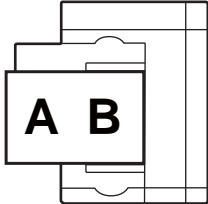
## STAPLE





| Touch panel key   | Orientation   | Result  |
|---|---|---|
|    |    |    |
|   |    |    |
|  |  |  |
|  |  |  |
|   |  |  |
|  |  |  |



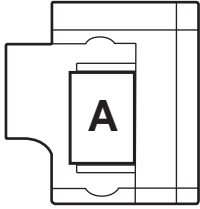

- To use the staple function, you need to mount a finisher (large stacker) or saddle stitch finisher (large stacker).
- To use the saddle stitch function, you need to mount a saddle stitch finisher (large stacker).

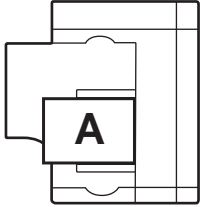



## PUNCH

| Touch panel key   | Orientation   | Result  |
|---|---|---|
|  |  |  |
|   |  |  |



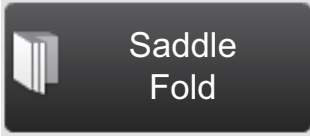
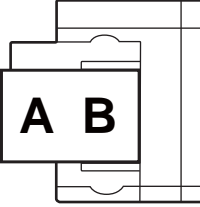

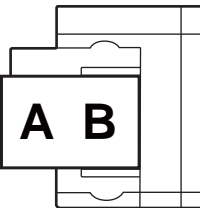



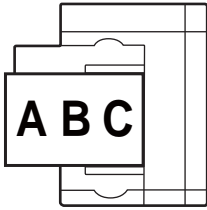

A punch module is required for paper punch.

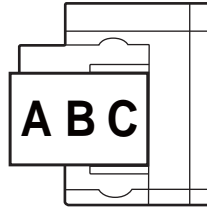
## FOLD

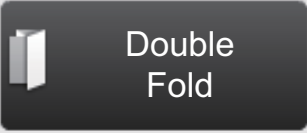
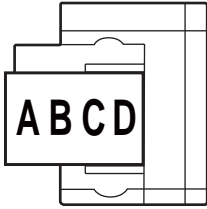
| Touch panel key   | Orientation   | Result  |
|---|---|---|
|  |  |  |
|  |  |  |

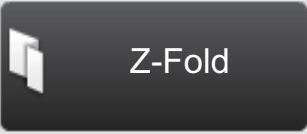
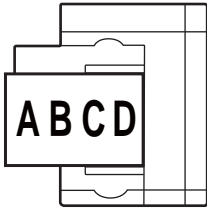

| Touch panel key  | Orientation   | Result  |
|--|---|---|
|  C-Fold         |    |    |
|  Accordion Fold |    |    |
|  Double Fold    |   |   |
|  Z-Fold       |  |  |



- A folding unit is required to be installed in order to use paper folding functions other than saddle folds.
- To use the saddle fold function, you need to mount a saddle stitch finisher (large stacker).



# OPERATION OF MANUAL FINISHING

## USING MANUAL FINISHING

Change from the Home Screen or each mode to manual finishing mode, and carry out the following procedure.

► [SELECTING MANUAL FINISHING MODE \(page 6-3\)](#)

1

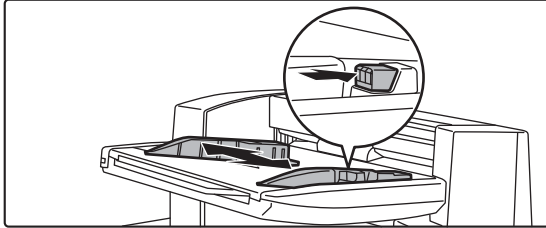

### Set the guides to the size of the paper.

Grasp the guide lock lever to adjust the guide. When you have finished the adjustment, release the lock lever.



When loading paper larger than 8-1/2" × 11"R, or A4R, extend the bypass tray all the way out. If it is not pulled all the way out, the size of the loaded paper will not be detected correctly.

2

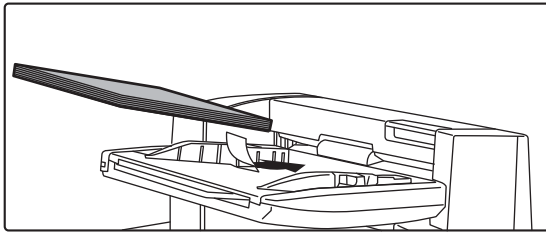

### Load paper into the upper or lower tray.

The paper orientation varies depending on the manual finishing function.

- [CHECKING TYPE AND SIZE OF PAPER \(page 6-4\)](#)
- [PAPER LOADING ORIENTATION \(page 6-5\)](#)



- Up to 200 sheets of paper can be loaded into each of the upper and lower trays.
- Insert the paper along the guides all the way into the tray.
- If the guide width is not correctly adjusted to match the paper width, paper may be jammed, skewed, or crease. Adjust the paper guides to fit the width of the paper.

3

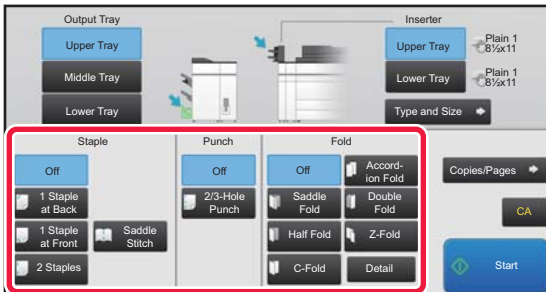

### Select the appropriate finishing method.

- [STAPLE FUNCTION \(page 6-10\)](#)
- [PUNCH FUNCTION \(page 6-13\)](#)
- [PAPER FOLDING FUNCTION \(page 6-14\)](#)



4

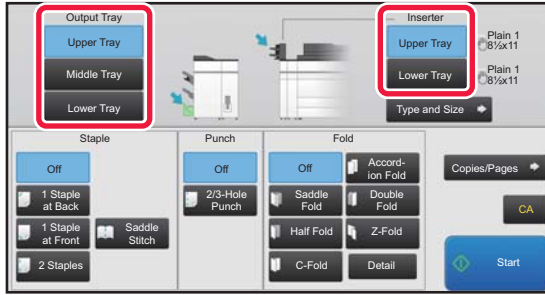

**Change the paper tray or output tray as required.**

- [TO CHANGE THE PAPER TRAY \(page 6-17\)](#)
- [TO CHANGE THE OUTPUT TRAY \(page 6-17\)](#)

5

**Tap the [Start] key to begin manual finishing.**



**To stop manual finishing:**  
Tap the [Stop] key.



# STAPLE FUNCTION

When a finisher (large stacker) is installed, you can staple loaded papers into a sheaf. (Staple function)

When a saddle stitch finisher (large stacker) is installed, you can staple papers in two places on the centerline and fold them before being output. (Saddle stitch function)

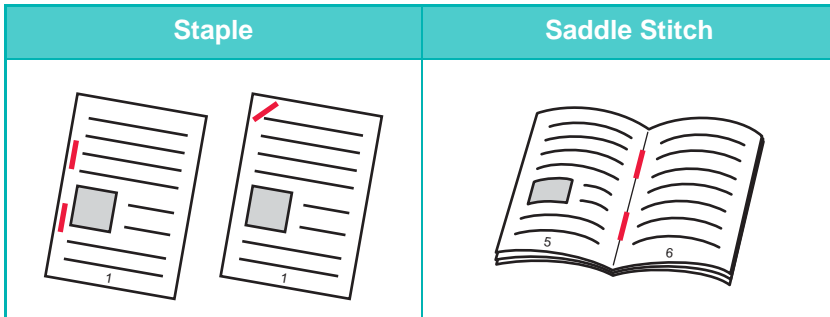

- You can use the saddle stitch function for size 8-1/2 " × 11"R to 12" × 18" (A4R to A3W) papers.
- The saddle stitch function cannot be used with other manual finishing functions.
- If you load only one sheet of paper while the staple function is ON, the staple function is temporarily turned OFF and the sheet is not stapled.

## Selecting staple function

Tap your desired staple key in the [Staple].

The output tray is automatically selected based on the selected staple key.

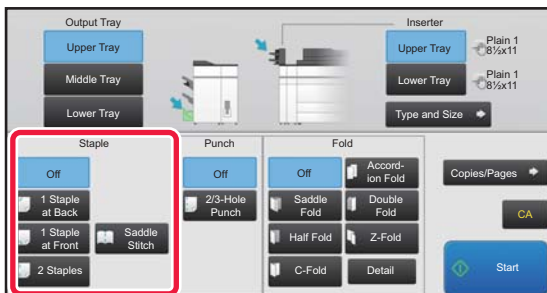

**To cancel the staple function:**  
Tap the [Off] key.



# COPIES/PAGES FUNCTION

If you wish to staple multiple sets at once, use the Copies/Pages.

Load sorted paper and tap the [Copies/Pages] key to enter the number of copies and the number of pages per set.

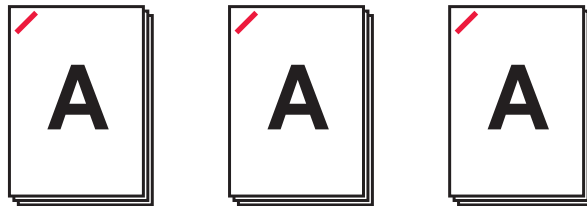
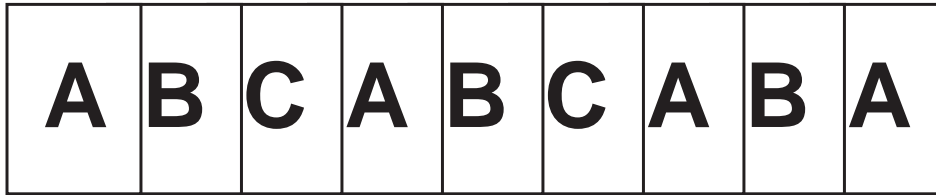

The settings on the Copies/Pages will not be effective for the paper folding and punch functions.

## Setting the number of copies (number of pages)

1

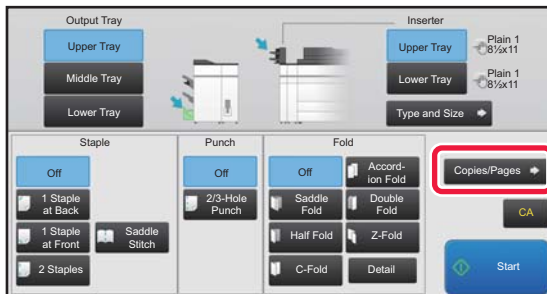

Tap the [Copies/Pages] key.

2

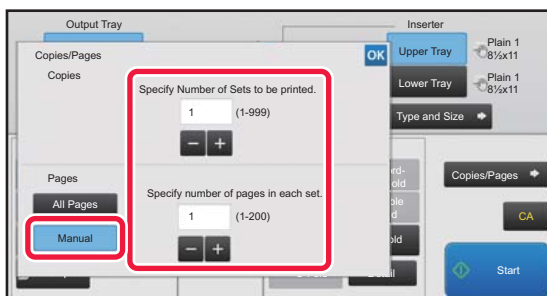

Tap the [Manual] key and specify the number of output copies and the number of pages per set.

Tap the Number of Copies display and the Number of Pages per Set display, and enter the values using the numeric keys. Otherwise, tap the **- +** key to enter the values. After the settings are completed, tap **OK**.



If you select [All Pages] for the number of copies/number of pages, specify "1" for the number of sets to be printed.



If you set more copies or pages than the number of copies or pages that can be stapled, a message is displayed and the [Start] key is disabled.

See "[SPECIFICATIONS \(page 8-2\)](#)" and specify the number of copies or pages that can be stapled.

## TRIMMER SETTING

If a trimmer unit is installed, you can trim off excess edges of paper for a finer finish.

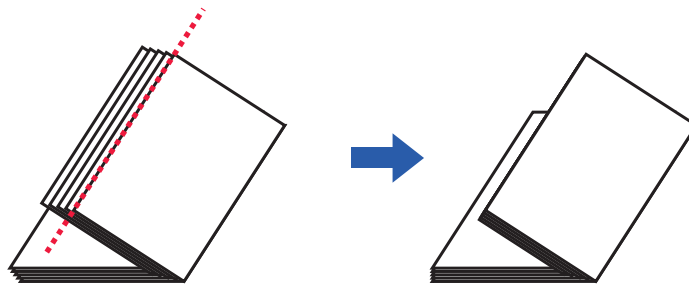

### Trimmer Setting (when Saddle Stitch is selected)

To select the Trimmer Setting, a trimmer unit must be installed.

1

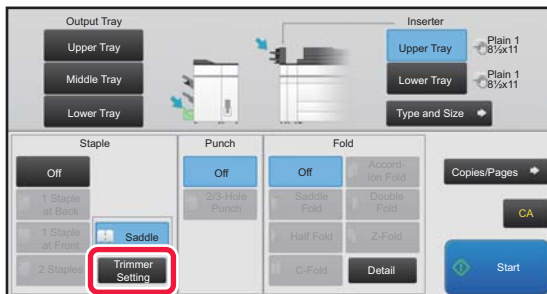

With Saddle Stitch selected, tap the [Trimmer Setting] key.

2

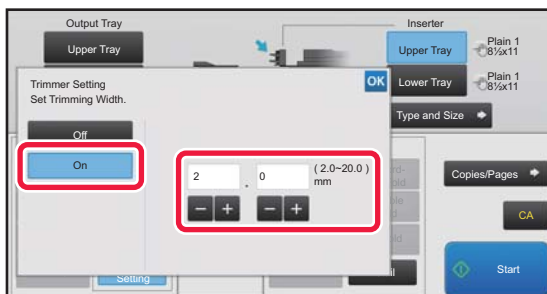

Tap the [On] key, and specify the trimming width.

Tap the numeric value display field of the trimming width, and enter the allowable range using the numeric keys. Otherwise, tap the **- +** key to enter the values. After the settings are completed, tap **OK**.



To cancel the trimmer setting:  
Tap the [Off] key.



# PUNCH FUNCTION

If a punch module is installed, holes can be punched in paper.

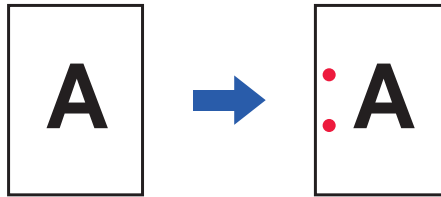

- Paper sizes that are available for the punch function are 8-1/2 " × 11"R to 11" × 17" (B5R to A3).
- You cannot use 12" × 18" (A3W) size papers, and special media such as transparency film.
- The punch function cannot be used with the saddle stitch or paper folding functions. However, it can be used with them if the paper size used is 11" × 17", A3 or B4 for Z-fold.

Tap the [2/3-Hole Punch] key under "Punch".

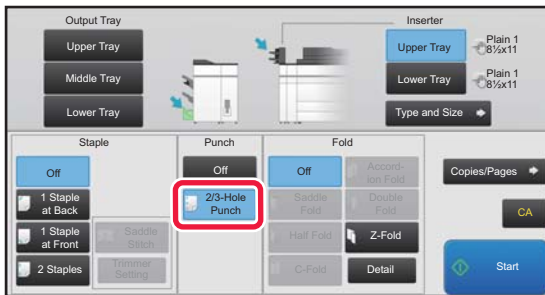

**To cancel the punch function:**

Tap the [Off] key.





# PAPER FOLDING FUNCTION

When a paper folding unit is installed, you can fold papers in Z-fold and C-fold. When a saddle stitch finisher (large stacker) is installed, you can use saddle folds.

The paper sizes that can be selected vary depending on the type of paper fold.

## Types of folds and paper sizes available

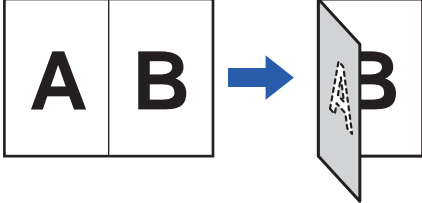
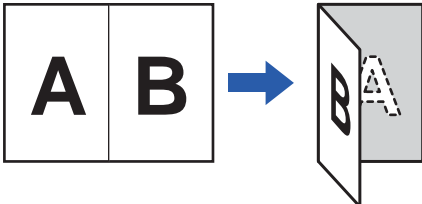
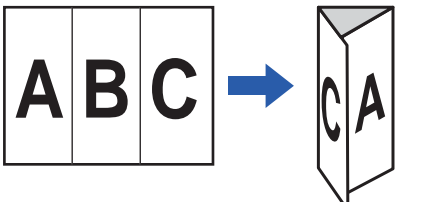
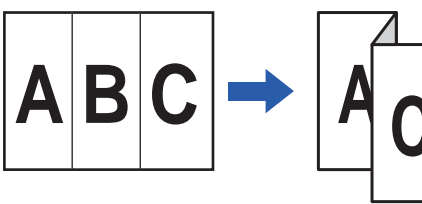
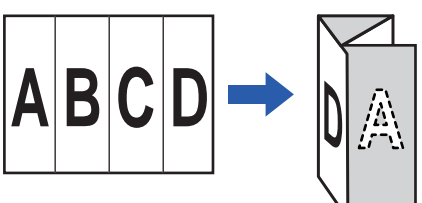
| Types of Folds        | Folding results   | Paper Size  |
|-----------------------|---|---|
| <b>Saddle Fold</b>    |    | 12" x 18", 11" x 17", 8-1/2" x 14", 8-1/2" x 13-1/2", 8-1/2" x 13-2/5", 8-1/2" x 13", 8-1/2" x 11"R, A3W, A3, B4, A4R, SRA3, 8K |
| <b>Half Fold</b>      |   | 8-1/2" x 11"R, A4R  |
| <b>C-Fold</b>         |  | 8-1/2" x 11"R, A4R  |
| <b>Accordion Fold</b> |  | 8-1/2" x 11"R, A4R  |
| <b>Double Fold</b>    |  | 8-1/2" x 11"R, A4R  |



| Types of Folds | Folding results | Paper Size  |
|----------------|-----------------|---|
| <b>Z-Fold</b>  |                 | 11" x 17", 8-1/2" x 14", 8-1/2" x 11"R, A3, B4, A4R |



- Special media such as transparency film and tab paper cannot be used.
- The paper folding function cannot be used with the staple and hole punch function. However, it can be used with them if the paper size for Z-fold is 11" x 17", A3 or B4.

## Selecting the paper folding function

Tap your desired fold key in the "Fold".

The output tray is automatically selected based on the selected fold key.

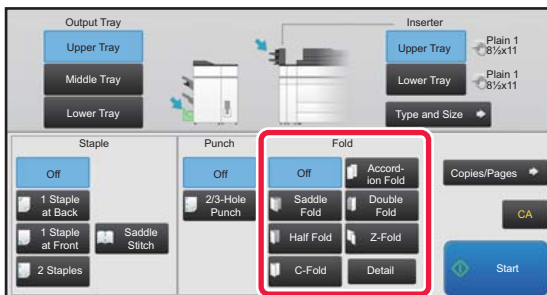

**To cancel the paper folding function:**

Tap the [Off] key.

## MULTIPLE FOLD (WHEN SADDLE FOLD IS SELECTED)

If Saddle Fold is selected, multiple sheets can be folded together. Five sheets of paper are folded at a time.

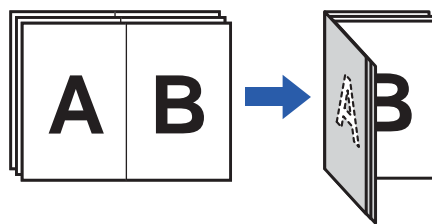

- When four or less papers are set, four or less papers are folded at a time.
- If five or more papers are set and if four or less papers remain, the remaining number of papers are folded at a time.
- Some types of paper reduces the number of sheets that are folded every set. For example, three sheets are folded at a time in the case of heavy paper.



## Setting Multiple Fold (when Saddle Fold is selected)

1

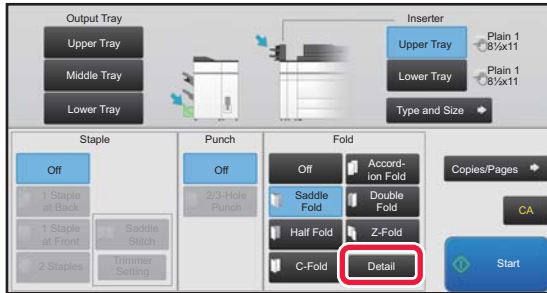

With Saddle Fold selected, tap the [Detail] key.

2

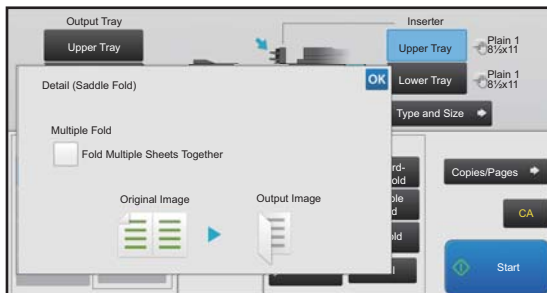

Set the [Fold Multiple Sheets Together] checkbox to .

After the settings are completed, tap **OK**.



**To cancel the multiple fold function:**

Set the [Fold Multiple Sheets Together] checkbox to .



# TO CHANGE THE PAPER TRAY

The paper tray is automatically detected when paper is loaded in the inserter.

If you need to specify a paper tray when, for example, paper has been loaded into both the upper and lower trays on the inserter, tap the [Upper Tray] or [Lower Tray] key to specify the appropriate paper tray.

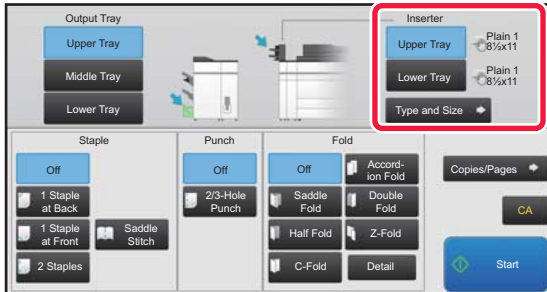

# TO CHANGE THE OUTPUT TRAY

The output tray is automatically selected based on the output function you set. If Z-Fold, Half Fold, or Punch is selected, you can select the upper, middle or lower tray for the output tray.

Tap the [Upper Tray], [Middle Tray] or [Lower Tray] key in "Output Tray" and select the output tray you require.

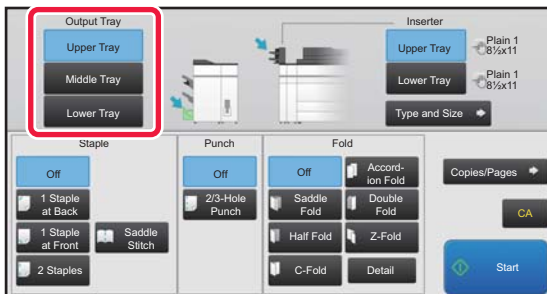

## Relation between output function and output tray

An output tray is automatically selected as shown below based on the output function you set. Depending on the output function that is originally deselected, it may be deselected if you tap the [Upper Tray], [Middle Tray] or [Lower Tray] key to change the output tray.

For example, if you tap the [Upper Tray], [Middle Tray] or [Lower Tray] key with "Saddle Stitch" selected, the setting for "Saddle Stitch" is canceled.

| Output function                   | Deliver to  |  |
|-----------------------------------|---|--|
| Staple                            | Upper Tray (A) or Lower Tray (C)                  |  |
| Z-Fold/Half Fold/Punch            | Upper Tray (A), Middle Tray (B) or Lower Tray (C) |  |
| Saddle Stitch/Saddle Fold         | Saddle Stitch Tray (D)                            |  |
| C-Fold/Accordion Fold/Double Fold | Folding Unit Tray (E)                             |  |



# SETTING MODE

## SETTING MODE

## SETTING MODE LIST

|                                |            |
|--------------------------------|------------|
| <b>SETTING MODE LIST</b> ..... | <b>7-6</b> |
| • Status .....                 | 7-6        |
| • Address Book .....           | 7-6        |
| • Document Operations .....    | 7-7        |
| • User Control .....           | 7-7        |
| • System Settings .....        | 7-9        |

## STATUS

|                                |             |
|--------------------------------|-------------|
| <b>Status</b> .....            | <b>7-52</b> |
| • Machine Identification ..... | 7-52        |
| • Total Count .....            | 7-53        |
| • Device Status .....          | 7-53        |
| • Network Status .....         | 7-54        |
| • Firmware Version .....       | 7-54        |
| • Power Reset .....            | 7-54        |
| • Data List .....              | 7-55        |

## SYSTEM SETTINGS

|  |             |
|--|-------------|
| <b>Printer Settings</b> .....                  | <b>7-57</b> |
| • Interface Settings .....                     | 7-57        |
| • Initial Status Settings .....                | 7-58        |
| • PCL Settings .....                           | 7-59        |
| • PostScript Settings .....                    | 7-60        |
| • OOXML Settings .....                         | 7-60        |
| • Print Release Settings .....                 | 7-60        |
| • E-mail Print Settings .....                  | 7-61        |
| • Direct Print Settings (FTP) .....            | 7-61        |
| • Direct Print Settings (Network Folder) ..... | 7-62        |
| • Print Setting from PC/Mobile Terminal .....  | 7-62        |
| <b>Image Send Settings</b> .....               | <b>7-63</b> |
| • Scan Settings .....                          | 7-63        |

|  |             |
|--|-------------|
| <b>Common Settings</b> .....                 | <b>7-65</b> |
| • Device Control .....                       | 7-72        |
| • Machine Identification Settings .....      | 7-75        |
| • Clock Adjust .....                         | 7-75        |
| • Product Key/Application Number Input ..... | 7-76        |
| • Sound Settings .....                       | 7-77        |
| <b>Network Settings</b> .....                | <b>7-78</b> |
| • Quick Settings .....                       | 7-78        |
| • Network Name Setting .....                 | 7-81        |
| • Interface Settings .....                   | 7-81        |
| • Services Settings .....                    | 7-84        |
| • Print Port Settings .....                  | 7-86        |
| • External Print Services Settings .....     | 7-87        |
| • LDAP Settings .....                        | 7-87        |
| • Proxy Setting .....                        | 7-89        |
| • Device Web Page Setting .....              | 7-90        |
| <b>Security Settings</b> .....               | <b>7-91</b> |
| • Password Change .....                      | 7-91        |
| • Condition Settings .....                   | 7-92        |
| • Port Control .....                         | 7-93        |
| • Filter Setting .....                       | 7-93        |
| • Intrusion/Attack Detection .....           | 7-94        |
| • SSL Settings .....                         | 7-94        |
| • S/MIME Settings .....                      | 7-95        |
| • IPsec Settings .....                       | 7-96        |
| • Document Administration Function .....     | 7-98        |
| • Hidden Pattern Print Setting .....         | 7-99        |
| • Tracking Information Print .....           | 7-100       |
| • Audit Log .....                            | 7-100       |





- System Control . . . . . 7-105**
  - Job Log . . . . . 7-105
  - Data Import/Export (CSV Format) . . . . . 7-105
  - Storage Backup . . . . . 7-105
  - Device Cloning . . . . . 7-106
  - Address Book Forward . . . . . 7-106
  - Filing Data Backup. . . . . 7-106
  - Storing/Calling of System Settings . . . . . 7-107
  - Reset Settings . . . . . 7-107
  - Optimization of Local Drive . . . . . 7-107
  - E-mail Alert and Status . . . . . 7-108
- Image Quality Adjustment . . . . . 7-110**
  - Collective Adjustment . . . . . 7-110
  - Copy Image Quality . . . . . 7-111
  - Print Image Quality . . . . . 7-112
  - Scan Image Quality . . . . . 7-112
  - Common Functions . . . . . 7-113
- Initial Installation Settings . . . . . 7-114**



# SETTING MODE

"Settings" allows management of various functions that will make it easier to use the machine, such as default registration for each function, network connection setting, and log check of operation status.

Setting mode can also be selected using the Web browser by accessing the machine from a PC connected to the same network as the machine.



### Administrator password

To maintain security, the machine administrator should promptly change the password after the machine is purchased. (For the default administrator password, see Start Guide.) To change the password, see "[Change Password \(page 7-91\)](#)".

## Displaying the setting mode on the machine

1

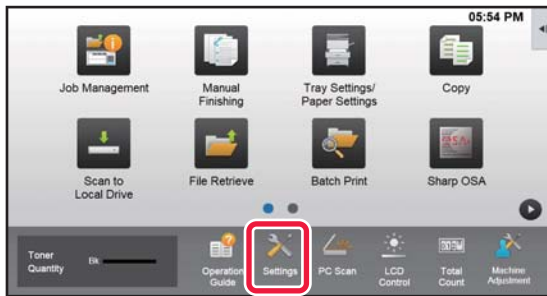

### Tap the [Settings] key.

Tap the [Settings] key on the home screen. The setting mode screen appears on the touch panel. The setting menu appears at the top of the displayed screen. Tap the setting in the menu that you want to configure. For details of the settings, see the explanation for each item.

2

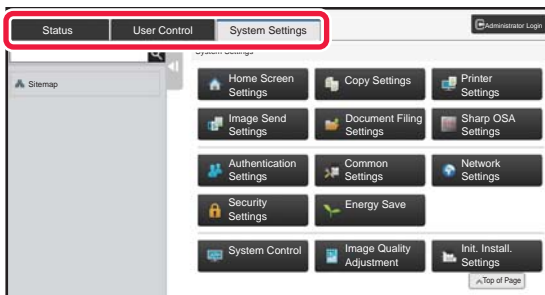

### On the upper tab, tap the item that you want to set.

The setting menu appears on the left side of the displayed screen. Tap the setting in the menu that you want to configure. When you tap the [System Settings] tab, item keys appear on the screen. When you tap the key of an item, a setting item menu appears. (When you tap the [Image Send Settings] key, further item keys appear.)



- To quit the setting mode, tap the [Cancel] key in the upper right corner of the screen.
- For details on login procedures when user authentication is enabled, see "[USER AUTHENTICATION \(page 1-29\)](#)".



## Displaying the setting mode (Web version)

When the machine is connected to the network, access the built-in Web server of the machine using the PC's Web browser.

From the setting mode of the machine, print the IP address of the machine and enter the address on the PC's Web browser.

1

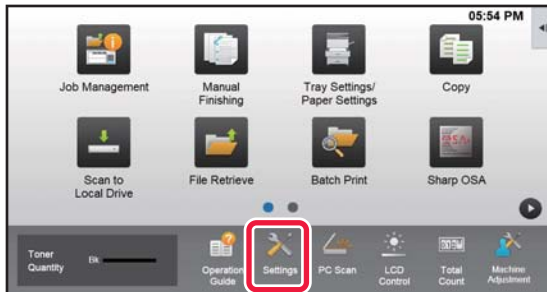

Tap the [Settings] key.

2

Tap [Status] → [Network Status] from the menu.

3

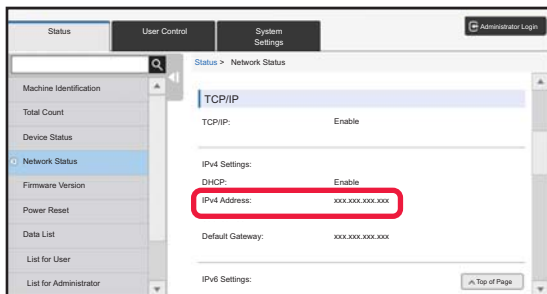

Scroll the screen down and check "IPv4 Address" in IPv4 Settings of TCP/IP.

4

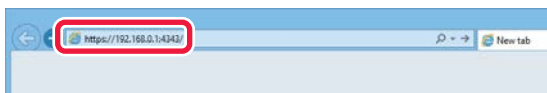

Start the Web browser on the PC, and enter the IP address of the machine.

Start a Web browser on a PC on the same network the machine is on, and enter the IP address of the machine.

**Recommended Web browsers:**

- Internet Explorer: 11 or later (Windows®)
- Microsoft Edge (Windows®),
- Firefox (Windows®), Safari (macOS®),
- Chrome (Windows®):  
Latest version or immediately previous major release

Depending on the machine settings, user authentication may be required to display the setting mode (Web version). For password and other information required for user authentication, contact the administrator of the machine.





## WHERE TO FIND EXPLANATIONS OF SETTINGS

The setting items below are explained in each of the chapters.

To find an explanation of an item, refer to the [SETTING MODE LIST \(page 7-6\)](#).

- **Address Book**
- **Document Operations**
- **User Control**
- **System Settings**
  - Copy Settings
  - Printer Settings → Condition Settings
  - Image Send Settings → Condition Settings
  - Image Send Settings → Scan Settings → Initial Status Settings, Condition Settings
  - Document Filing Settings
  - Sharp OSA Settings
  - Paper Settings. Operation Settings, Keyboard Settings, Enable/Disable Settings
  - Energy Save



- For information on address book items, see "User's Manual (Address Book Registration)".
  - For the home screen settings, see "User's Manual (Touch Panel Operation)".
-



# SETTING MODE LIST

## SETTING MODE LIST

The following is a list of setting mode items, factory default settings and restrictions for each item.



The setting items below are explained in each of the manual.

A→User's Manual (Address Book Registration)

B→User's Manual (Touch Panel Operation)



- Depending on the machine specifications and peripheral devices installed, it may not be possible to use some settings.
- Some setting items can only be configured on the Web page.

## Status

U: General user; A: System administrator/Administrator

| Setup Items              | Factory default setting | U     | A   | Page |
|--------------------------|-------------------------|-------|-----|------|
| <b>■ Status</b>          |                         |       |     |      |
| ● Machine Identification | –                       | Yes*1 | Yes | 7-52 |
| ● Total Count            | –                       | Yes*2 | Yes | 7-53 |
| ● Device Status          | –                       | Yes   | Yes | 7-53 |
| ● Network Status         | –                       | Yes   | Yes | 7-54 |
| ● Firmware Version       | –                       | No    | Yes | 7-54 |
| ● Power Reset            | –                       | No    | Yes | 7-54 |
| ● Data List              | –                       | Yes   | Yes | 7-55 |
| ▶ List for User          | –                       | Yes   | Yes |      |
| ▶ List for Administrator | –                       | No    | Yes |      |

\*1 Some settings can only be configured by the administrator.

\*2 Depending on settings, administrator rights may be required.

## Address Book

For information on address book items, see "User's Manual (Address Book Registration)".



# Document Operations

U: General user; A: System administrator/Administrator

| Setup Items                    | Factory default setting | U   | A   | Page |
|--------------------------------|-------------------------|-----|-----|------|
| <b>■ Document Operations*1</b> |                         |     |     |      |
| ● Document Filing              |                         | Yes | Yes | 5-39 |
| ▶ Main Folder                  | –                       | Yes | Yes |      |
| ▶ Quick File Folder            | –                       | Yes | Yes |      |
| ▶ Custom Folder*2              | –                       | Yes | Yes |      |
| ▶ My Folder*3                  | –                       | Yes | Yes |      |
| ▶ Search                       | –                       | Yes | Yes |      |
| ▶ File Batch Print             | –                       | Yes | Yes |      |
| ● Submit Print Job             | –                       | Yes | Yes | 3-87 |

\*1 This setting is configured in setting mode on the web page.

\*2 Set the Category Setting in [System Settings] → [Document Filing Settings] → [Document Filing Control] of the machine's setting mode.

\*3 This appears when My Folder is set.

# User Control

U: General user; A: System administrator/Administrator

| Setup Items                     | Factory default setting | U  | A   | Page |
|---------------------------------|-------------------------|----|-----|------|
| <b>■ User Control</b>           |                         |    |     |      |
| ● User Settings                 |                         | No | Yes | 1-37 |
| ▶ User List                     | –                       | No | Yes |      |
| ▶ Custom Index                  | –                       | No | Yes | 1-40 |
| ▶ Organization /Group List      | –                       | No | Yes |      |
| ▶ User Information Print        | –                       | No | Yes |      |
| ● Access Control Settings       |                         | No | Yes | 1-48 |
| ▶ Pages Limit Group             | –                       | No | Yes |      |
| ▶ Machine Page Limit Setting    | –                       | No | Yes | 1-49 |
| ▶ Authority Group               | –                       | No | Yes |      |
| ▶ Favorite Operation Group      | –                       | No | Yes | 1-53 |
| ◆ Favorite Operation Group List | –                       | No | Yes |      |
| ◆ Favorite Key List*            | –                       | No | Yes |      |
| ◆ Home Screen List              | –                       | No | Yes |      |
| ● User Count                    |                         | No | Yes | 1-55 |
| ▶ View User Count               | –                       | No | Yes |      |
| ▶ Save User Count*              | –                       | No | Yes | 1-56 |



| Setup Items  | Factory default setting | U  | A   | Page |
|--|-------------------------|----|-----|------|
| ● Billing Code Setting                             |                         | No | Yes | 1-71 |
| ▶ Administration Settings                          | –                       | No | Yes |      |
| ◆ Use Billing Code                                 | Disabled                | No | Yes |      |
| ◆ Default Code Setting                             | usecode                 | No | Yes |      |
| ◆ Remember Billing Code Between Modes              | Disabled                | No | Yes |      |
| ◆ Disable Change of Billing Code                   | Disabled                | No | Yes |      |
| ◆ Apply Default Code when Billing Code not entered | Disabled                | No | Yes |      |
| ◆ Disable Billing Code for Selected Applications   |                         | No | Yes |      |
| • Sharp OSA  | All Invalid             | No | Yes |      |
| ◆ Billing Code Display Name Setting                |                         | No | Yes |      |
| • Main Code Display Name                           | Default                 | No | Yes |      |
| • Sub Code Display Name                            | Default                 | No | Yes |      |
| ▶ Main Code List                                   | –                       | No | Yes |      |
| ▶ Sub Code List                                    | –                       | No | Yes | 1-72 |

\* This setting is configured in setting mode on the web page.



# System Settings

## Home Screen Settings

For information on home screen settings items, see "User's Manual (Touch Panel Operation)".

## Copy Settings

U: General user; A: System administrator/Administrator

| Setup Items                                     | Factory default setting                 | U  | A   | Page  |
|---|---|----|-----|-------|
| ● Copy Settings                                 |   |    |     |       |
| ▶ Condition Settings                            |   |    |     |       |
| ◆ Rotation Copy Setting                         | Rotation Copy                           | No | Yes | 2-11  |
| ◆ Add or Change Extra Preset Ratios             | –                                       | No | Yes | 2-23  |
| ◆ Setting a Maximum Number of Copies            | 9999                                    | No | Yes | 2-8   |
| ◆ Stamp   | –                                       | No | Yes | 2-97  |
| • Font Size                                     | Middle                                  | No | Yes |       |
| ◆ Initial Margin Shift Setting                  |   | No | Yes | 2-81  |
| • Side 1  | 1/2" (10mm)                             | No | Yes |       |
| • Side 2  | 1/2" (10mm)                             | No | Yes |       |
| ◆ Erase Width Adjustment                        |   | No | Yes | 2-83  |
| • Edge Clearance Width                          | 1/2" (10mm)                             | No | Yes |       |
| • Center Clearance Width                        | 1/2" (10mm)                             | No | Yes |       |
| ◆ InitialIN-Up Setting                          | Off                                     | No | Yes | 2-46  |
| • Layout  | Left to Right/Right, and Down           | No | Yes |       |
| • Border  | No Print                                | No | Yes |       |
| ◆ Card Shot Settings                            |   | No | Yes | 2-50  |
| • Original Size                                 | X: 3-3/8" (86 mm),<br>Y: 2-1/8" (54 mm) | No | Yes |       |
| • Fit to Page                                   | Disabled                                | No | Yes |       |
| ◆ Automatic Saddle Stitch <sup>*3</sup>         | Enabled                                 | No | Yes | 2-39  |
| ◆ Initial Tab Copy Setting                      | Image Shift:<br>1/2" (10mm)             | No | Yes | 2-119 |
| ◆ Disabling of Registration/Deletion of Program | Disabled                                | No | Yes | 2-136 |
| ◆ Disabling of Bypass-Tray in Duplex Copy       | Disabled                                | No | Yes | 2-34  |



| Setup Items  | Factory default setting                       | U  | A   | Page  |
|--|---|----|-----|-------|
| ◆ Disabling of Auto Paper Selection  | Disabled                                      | No | Yes | 2-12  |
| ◆ Auto Selection Setting of Tray that is Supplied the Paper                                | Disabled                                      | No | Yes |       |
| ◆ Disabling Registration of Custom Image   | Disabled                                      | No | Yes | 2-100 |
| ◆ Disabling sending while copying  | Disabled                                      | No | Yes | 2-131 |
| ◆ High Quality Scan from Document Feeder   | Enabled                                       | No | Yes | 2-96  |
| ◆ Quick Scan from Document Glass   | Disabled                                      | No | Yes |       |
| ◆ Auto Clear Before Copy Execution Also  | Disabled                                      | No | Yes | 2-5   |
| ◆ Display Warning Message when Original is not Detected                                    | Disabled                                      | No | Yes |       |
| ► Initial Status Settings  |   |    |     |       |
| ◆ Image Orientation  | Portrait                                      | No | Yes | 2-8   |
| ◆ Paper Tray   | Varies depending on the machine configuration | No | Yes |       |
| ◆ Exposure Type  | Auto  | No | Yes |       |
| • Copy of Copy   | Disabled                                      | No | Yes |       |
| ◆ Copy Ratio   | 100%  | No | Yes |       |
| ◆ Select magnification automatically according to paper size, when paper tray is selected. | Disabled                                      | No | Yes |       |
| ◆ 2-Sided Copy   | 1-Sided→1-Sided                               | No | Yes |       |
| ◆ Original Binding   | Book  | No | Yes |       |
| ◆ Output Binding   | Book  | No | Yes |       |
| ◆ Output   | Auto  | No | Yes |       |
| ◆ Output Tray  | Varies depending on the machine configuration | No | Yes |       |
| ◆ Offset   | Enabled                                       | No | Yes |       |
| ◆ Separator Page   |   | No | Yes |       |
| • Insert Before Job  | Disabled                                      | No | Yes |       |
| • Insert After Job   | Disabled                                      | No | Yes |       |
| ◆ Staple Sort* <sup>1</sup>  | –   | No | Yes |       |
| ◆ Staple Position* <sup>1</sup>  | –   | No | Yes |       |
| ◆ Punch* <sup>2</sup>  | –   | No | Yes |       |
| ► Fold* <sup>3</sup>   | Fold inside                                   | No | Yes |       |
| • Fold Multiple Sheets Together* <sup>3</sup>  | Disabled                                      | No | Yes |       |



| Setup Items             | Factory default setting | U  | A   | Page  |
|-------------------------|-------------------------|----|-----|-------|
| ► Text /Image Printing  |                         |    |     |       |
| ◆ Text Settings (Stamp) | –                       | No | Yes | 2-97  |
| ◆ Custom Stamp          | –                       | No | Yes | 2-100 |
| ◆ Custom Watermark      | –                       | No | Yes |       |

\*1 When a finisher (large stacker)/saddle stitch finisher (large stacker) is installed.

\*2 When a finisher (large stacker)/saddle stitch finisher (large stacker) is installed and a punch module is installed.

\*3 When a saddle stitch finisher (large stacker) is installed.

## Printer Settings

U: General user; A: System administrator/Administrator

| Setup Items                                    | Factory default setting | U  | A   | Page |
|--|-------------------------|----|-----|------|
| ● Printer Settings                             |                         |    |     |      |
| ► Condition Settings                           |                         |    |     |      |
| ◆ Prohibit Notice Page Printing                | Enabled                 | No | Yes | 3-3  |
| ◆ Prohibit Test Page Printing                  | Disabled                | No | Yes | 7-55 |
| ◆ A4/Letter Size Auto Change                   | Disabled                | No | Yes | 3-7  |
| ◆ Print A3W (12x18) and 11x17 on A3 Size Paper | Disabled                | No | Yes |      |
| ◆ Bypass Tray Settings                         |                         | No | Yes |      |
| • Enable Detected Paper Size in Bypass Tray    | Disabled                | No | Yes |      |
| • Enable Selected Paper Type in Bypass Tray    | Enabled                 | No | Yes |      |
| • Exclude Bypass-Tray from Auto Paper Select   | Disabled                | No | Yes |      |
| ◆ Job Spool Queuing                            | Enabled                 | No | Yes | B    |
| ◆ Disabling of USB Memory Direct Print         | Disabled                | No | Yes | 3-83 |
| ◆ Disabling of Network Folder Direct Print     | Disabled                | No | Yes | 3-84 |
| ◆ Disabling sending while printing             | Disabled                | No | Yes | 3-80 |
| ► Interface Settings                           |                         | No | Yes | 7-57 |
| ◆ Hexadecimal Dump Mode                        | Disabled                | No | Yes |      |
| ◆ I/O Timeout                                  | 60sec.                  | No | Yes |      |
| ◆ Enable Network Port                          | Enabled                 | No | Yes |      |
| ◆ Network Port Emulation Switching             | Auto                    | No | Yes |      |
| ◆ Port Switching Method                        | Switch at End of Job    | No | Yes |      |



| Setup Items                       | Factory default setting  | U   | A   | Page |
|-----------------------------------|--|-----|-----|------|
| ► Initial Status Settings         |  | Yes | Yes | 7-58 |
| ◆ Copies                          | 1  | Yes | Yes |      |
| ◆ Orientation                     | Portrait   | Yes | Yes |      |
| ◆ Paper Size                      | 8-1/2" x 11" (A4)  | Yes | Yes |      |
| ◆ Output Tray                     | Auto   | Yes | Yes |      |
| ◆ Paper Type                      | Plain Paper 1  | Yes | Yes |      |
| ◆ Resolution Setting              | 600dpi (High Quality)  | Yes | Yes |      |
| ◆ Disable Blank Page Print        | Enabled  | Yes | Yes |      |
| ◆ 2-Sided Print                   | 1-Sided  | Yes | Yes |      |
| ◆ N-Up Print                      | 1-Up   | Yes | Yes |      |
| ◆ Fit To Page                     | Enabled  | Yes | Yes |      |
| ◆ Output                          | Varies depending on the machine configuration  | Yes | Yes |      |
| • Print per Unit                  | Enabled  | Yes | Yes |      |
| ◆ Separator Page                  |  | Yes | Yes |      |
| • Insert Before Job               | Disabled   | Yes | Yes |      |
| • Paper Tray                      | Bypass Tray  | Yes | Yes |      |
| • Insert After Job                | Disabled   | Yes | Yes |      |
| • Paper Tray                      | Bypass Tray  | Yes | Yes |      |
| • Staple Sort*1                   | Disabled   | Yes | Yes |      |
| • Punch*2                         | Disabled   | Yes | Yes |      |
| • Fold*3                          | Disabled   | Yes | Yes |      |
| - Fold Multiple Sheets Together*3 | Disabled   | Yes | Yes |      |
| ◆ Quick File                      | Disabled   | Yes | Yes |      |
| ► PCL Settings                    |  | Yes | Yes | 7-59 |
| ◆ PCL Symbol Set Setting          | PC-8   | Yes | Yes |      |
| ◆ PCL Font Setting                | Internal Font, 0: Courier  | Yes | Yes |      |
| ◆ PCL Line Feed Code              | 0.CR=CR; LF=LF; FF=FF  | Yes | Yes |      |
| ◆ Wide A4                         | Disabled   | Yes | Yes |      |
| ► PostScript Settings             |  | Yes | Yes | 7-60 |
| ◆ Screen Settings                 | Standard   | Yes | Yes |      |
| ◆ Print PS Errors                 | Disabled   | Yes | Yes |      |
| ◆ Binary Processing               | Disabled   | Yes | Yes |      |
| ► Print Release Settings          | For information about each of the print release settings, see "Print Release Guide". | No  | Yes |      |





| Setup Items                              | Factory default setting | U  | A   | Page |
|--|-------------------------|----|-----|------|
| ► E-mail Print Settings                  |                         | No | Yes | 7-61 |
| ◆ E-mail Print                           | Disabled                | No | Yes |      |
| ◆ POP3 Server                            | –                       | No | Yes |      |
| ◆ Port Number                            | 110                     | No | Yes |      |
| ◆ POP Authentication                     | Disabled                | No | Yes |      |
| ◆ User Name                              | –                       | No | Yes |      |
| ◆ Password                               | –                       | No | Yes |      |
| • Change Password                        | Disabled                | No | Yes |      |
| ◆ Check Interval                         | 5 minutes               | No | Yes |      |
| ◆ Enable SSL                             | Disabled                | No | Yes |      |
| ◆ Connection Test                        | –                       | No | Yes |      |
| ► Direct Print Settings (FTP)            |                         | No | Yes |      |
| ► Direct Print Settings (Network Folder) | –                       | No | Yes |      |
| ► Print Setting from PC/Mobile Terminal  |                         | No | Yes |      |
| ◆ FTP Print                              | Enabled                 | No | Yes |      |
| ◆ Port Number                            | 21                      | No | Yes |      |

\*1 When a finisher (large stacker)/saddle stitch finisher (large stacker) is installed.

\*2 When a finisher (large stacker)/saddle stitch finisher (large stacker) is installed and a punch module is installed.

\*3 When a saddle stitch finisher (large stacker) is installed.



## Image Send Settings

### Common Settings

U: General user; A: System administrator/Administrator

| Setup Items  | Factory default setting | U  | A   | Page |
|--|-------------------------|----|-----|------|
| ● Common Settings  |                         |    |     |      |
| ▶ Condition Settings   |                         |    |     |      |
| ◆ Hold settings for a while after scanning has been completed                | Disabled                | No | Yes | 4-32 |
| ◆ Job Auto Start Time During Scanning  | 60sec.                  | No | Yes |      |
| ◆ Default Display Setting  | E-mail                  | No | Yes |      |
| ◆ Address Book Default Selection   |                         | No | Yes | 4-16 |
| • Higher priority is given to the display of address book.                   | Disabled                | No | Yes |      |
| • Apply Addresses of Sending Modes Only                                      | Enabled                 | No | Yes |      |
| • Category Displayed as Default  | None                    | No | Yes | A    |
| • Display all address type regardless of the mode being displayed currently. | Disabled                | No | Yes |      |
| • Enlarge Address Book   | Enabled                 | No | Yes |      |
| ◆ Image Orientation  | Portrait                | No | Yes | 4-47 |
| ◆ Preview Setting  |                         |    |     |      |
| ◆ Default List/Thumbnail Display   |                         | No | Yes | 1-15 |
| ◆ Default Exposure Settings  | Auto                    | No | Yes | 4-48 |
| ◆ Default Original Image Type  | Text                    | No | Yes |      |
| • Be sure to press Next Address Key ([+]) before selecting the next address. | Disabled                | No | Yes | 4-37 |
| • Disable Switching of Display Order   | Disabled                | No | Yes | A    |
| ◆ Default Verification Stamp* <sup>1</sup>                                   |                         | No | Yes | 4-10 |
| • E-mail/Scan/Data Entry   | Disabled                | No | Yes |      |



| Setup Items  | Factory default setting   | U   | A   | Page  |
|--|---|-----|-----|-------|
| ◆ Erase Width Adjustment                                       |   | No  | Yes | 4-93  |
| • Edge Clearance Width   | 1/2" (10mm)   | No  | Yes |       |
| • Center Clearance Width                                       | 1/2" (10mm)   | No  | Yes |       |
| ▶ Enable/Disable Settings                                      |   |     |     |       |
| ◆ Settings to Disable Registration                             |   |     |     |       |
| • Disable Registering Destination from Operation Panel         | All Invalid   | No  | Yes | A     |
| • Disable Registering Destination on Web Page                  | All Invalid   | No  | Yes |       |
| • Disable Registration/Delection of All Program Items          | Disabled  | No  | Yes | 4-59  |
| • Disable Destination Registration Using Global Address Search | All Invalid   | No  | Yes | A     |
| • Disable Registration Using Network Scanner Tool              | Disabled  | No  | Yes | 4-6   |
| • Disabling of Forwarding via Network                          | Disabled  | No  | Yes |       |
| ◆ Settings to Disable Transmission                             |   |     |     |       |
| • Disable [Resend] on Image Send Mode                          | Disabled  | No  | Yes | 4-25  |
| • Disable Selection from Address Book                          | All Invalid   | No  | Yes | 4-14  |
| • Disable Direct Entry   | All Invalid   | No  | Yes | 4-20  |
| ◆ Disabling of PC Scan   | Disabled  | No  | Yes | 4-112 |
| ◆ Disable Storing to External Memory Device                    | Disabled  | No  | Yes | 5-18  |
| ◆ Disabling of Find My Address                                 | Disabled  | No  | Yes | 4-17  |
| ▶ Category Setting*2   | These items are shared with address book items, so see "User's Manual (Address Book Registration)". | Yes | Yes | A     |

\*1 When a stamp unit is installed.

\*2 Set the Category Setting in [System Settings] → [Image Send Settings] → [Common Settings] → [Category Setting] of the machine's setting mode.



## Scan Settings

| Setup Items                                  | Factory default setting       | U  | A   | Page |
|--|-------------------------------|----|-----|------|
| ● Scan Settings                              |                               |    |     |      |
| ▶ Scan Settings                              |                               |    |     |      |
| ▶ Initial Status Settings                    |                               |    |     |      |
| ◆ Default Color Mode Settings                |                               | No | Yes | 4-11 |
| • Scanner Common                             | Auto: Mono2                   | No | Yes |      |
| - Disable Change of B/W Setting in Auto Mode | Disabled                      | No | Yes |      |
| • E-mail                                     | Auto: Mono2                   | No | Yes |      |
| - Disable Change of B/W Setting in Auto Mode | Disabled                      | No | Yes |      |
| ◆ Initial File Format Setting                |                               | No | Yes |      |
| ◆ Scanner Common                             |                               | No | Yes |      |
| • File Type                                  | PDF                           | No | Yes |      |
| - OCR  | Disabled                      | No | Yes |      |
| • Black & White                              | Compression Mode:<br>MMR (G4) | No | Yes |      |
| • Color/Grayscale                            | Compression Ratio:<br>Medium  | No | Yes |      |
| - Compression Ratio                          | Middle                        | No | Yes |      |
| - Bk Letter Emphasis                         | Disabled                      | No | Yes |      |
| • Specified Pages per File                   | Disabled                      | No | Yes |      |
| • OCR Setting                                |                               | No | Yes |      |
| - Font                                       |                               | No | Yes |      |
| + Western Languages                          | Arial                         | No | Yes |      |
| + Japanese                                   | MS Gothic                     | No | Yes |      |
| + Chinese                                    | SimSun                        | No | Yes |      |
| + Traditional Chinese                        | MingLiU                       | No | Yes |      |
| + Korean                                     | Dotum                         | No | Yes |      |
| - Detect Image Direction                     | Enabled                       | No | Yes |      |
| - File Name Extraction                       | Disabled                      | No | Yes |      |
| ◆ E-mail                                     |                               | No | Yes |      |
| • File Type                                  | PDF                           | No | Yes |      |
| - OCR  | Disabled                      | No | Yes |      |
| • Black & White                              | Compression Mode:<br>MMR (G4) | No | Yes |      |
| • Color/Grayscale                            | Compression Ratio:<br>Medium  | No | Yes |      |
| - Bk Letter Emphasis                         | Disabled                      | No | Yes |      |
| • Specified Pages per File                   | Disabled                      | No | Yes |      |



| Setup Items  | Factory default setting | U  | A   | Page |
|--|-------------------------|----|-----|------|
| • OCR Setting                                      |                         | No | Yes | 4-11 |
| - Font   |                         | No | Yes |      |
| + Western Languages                                | Arial                   | No | Yes |      |
| + Japanese   | MS Gothic               | No | Yes |      |
| + Chinese  | SimSun                  | No | Yes |      |
| + Traditional Chinese                              | MingLiU                 | No | Yes |      |
| + Korean   | Dotum                   | No | Yes |      |
| - Detect Image Direction                           | Enabled                 | No | Yes |      |
| - File Name Extraction                             | Disabled                | No | Yes |      |
| ◆ Easy Scan Settings                               |                         | No | Yes | 4-12 |
| • Color  | Auto                    | No | Yes |      |
| • B/W  | Mono2                   | No | Yes |      |
| ◆ Resolution Setting                               |                         | No | Yes |      |
| ◆ Scan   |                         | No | Yes |      |
| • Apply the Resolution Set when Stored             | Disabled                | No | Yes |      |
| • (No item)  | 200x200dpi              | No | Yes |      |
| ◆ E-mail   |                         | No | Yes |      |
| + Apply the Resolution Set when Stored             | Disabled                | No | Yes |      |
| + (No item)  | 200x200dpi              | No | Yes |      |
| ◆ PDF Skew Adjustment                              | Disabled                | No | Yes |      |
| ► Condition Settings                               |                         |    |     | 4-5  |
| ◆ Default Reply.Address Set                        | –                       | No | Yes |      |
| • Disable Selection of Reply-to.                   | Disabled                | No | Yes | 4-21 |
| ◆ Bcc Setting                                      | –                       | No | Yes |      |
| • Enable Bcc                                       | Disabled                | No | Yes |      |
| • Display Bcc Address on the Job Management Screen | Disabled                | No | Yes | 4-11 |
| ◆ Quick On Line Sending                            | Enabled                 | No | Yes |      |
| ◆ PDF Compression Options                          |                         | No | Yes | 4-51 |
| • Flate Compression                                | Enabled                 | No | Yes |      |
| • Compact PDF Resolution Setting                   | 300x300dpi              | No | Yes |      |
| ◆ Compression Mode at Broadcasting                 |                         | No | Yes | 4-53 |
| • Black & White                                    | MH (G3)                 | No | Yes |      |
| • Color/Grayscale                                  | Medium                  | No | Yes |      |
| - Bk Letter Emphasis                               | Disabled                | No | Yes |      |



| Setup Items   | Factory default setting  | U   | A   | Page |
|---|--------------------------|-----|-----|------|
| ◆ Send Destination Link Settings  | Enabled                  | No  | Yes | 4-29 |
| ◆ Enable Send Destination Link as Default   | Disabled                 | No  | Yes |      |
| ◆ File Retention Period   | 4 Hour                   | No  | Yes |      |
| ◆ Enable SSL  | Enabled                  | No  | Yes |      |
| ◆ Maximum Size of E-mail Attachments(E-Mail)  | Unlimited                | No  | Yes |      |
| • If the E-mail attachment(s) exceed maximum size, it will be sent in multiple files. | Disabled                 | No  | Yes |      |
| ◆ Maximum Size of Data Attachments(FTP/Desktop/Network Folder)                        | Unlimited                | No  | Yes |      |
| ◆ Auto Scan Setting   | Disabled                 | No  | Yes | 4-57 |
| • Set Image Orientation Automatically   | Enabled, 1-Sided         | No  | Yes |      |
| • Set Resolution Automatically  | Enabled                  | No  | Yes |      |
| • Blank Page Skip   | Enabled, Skip Blank Page | No  | Yes |      |
| • Automatically Detect Mono2/Grayscale  | Enabled                  | No  | Yes |      |
| - Detection Standard  | 3 (Normal)               | No  | Yes |      |
| • Automatically Adjust Skewed PDFs  | Enabled                  | No  | Yes |      |
| ◆ Preset restriction of E-mail for direct input                                       | –                        | No  | Yes | 4-20 |
| • Domain  | –                        | No  | Yes |      |
| ◆ Default Address   | Disabled                 | No  | Yes | 7-63 |
| • Default Address Setting   | Disabled                 | No  | Yes |      |
| • Add Selected  | Select From Address Book | No  | Yes |      |
| - Apply E-mail address of the user for login.   | –                        | No  | Yes |      |
| - Apply Home Directory of The User for Login  | –                        | No  | Yes |      |
| - Select From Address Book  | –                        | No  | Yes |      |
| + Index   | All Destinations         | No  | Yes |      |
| + Display Items   | 10                       | No  | Yes |      |
| - Allow cancel of the first entered address   | Disabled                 | No  | Yes |      |
| ► Subject Name Settings   | –                        | Yes | Yes | 7-64 |
| ◆ Default Subject   | –                        | Yes | Yes |      |
| ◆ Pre-Set Registration  | –                        | Yes | Yes |      |



| Setup Items  | Factory default setting | U   | A   | Page |
|--|-------------------------|-----|-----|------|
| ► File Name Settings   | –                       | Yes | Yes | 7-64 |
| ◆ Default Settings for File Names                            | –                       | Yes | Yes |      |
| • File Naming  |                         | Yes | Yes |      |
| - Serial Number  | Disabled                | Yes | Yes |      |
| - Text   | Disabled                | Yes | Yes |      |
| - Sender Name  | Enabled                 | Yes | Yes |      |
| - Date   | Enabled                 | Yes | Yes |      |
| - Session Page Counter                                       | Disabled                | Yes | Yes |      |
| - Unique Identifier  | Disabled                | Yes | Yes |      |
| • Direct Entry/Pre-Set Text Selection Settings               | –                       | Yes | Yes |      |
| - Add Date & Time  | Disabled                | Yes | Yes |      |
| ◆ Pre-Set Registration                                       | –                       | Yes | Yes |      |
| ► Message Body Settings                                      | –                       | Yes | Yes |      |
| ◆ Add Job Information Automatically to the Mail Message Body | Enabled                 | Yes | Yes |      |
| ◆ Add a Footer Automatically to the Mail Message Body        | Disabled                | Yes | Yes |      |
| ◆ Mail Footer Registration                                   | –                       | Yes | Yes |      |
| ◆ Pre-Set Registration                                       | –                       | Yes | Yes |      |
| ◆ Body Registration  | –                       | Yes | Yes |      |

### Metadata Settings

| Setup Items                 | Factory default setting | U  | A   | Page  |
|-----------------------------|-------------------------|----|-----|-------|
| ● Device Control            |                         |    |     |       |
| ► Metadata Settings         |                         | No | Yes | 4-121 |
| ◆ Metadata Delivery         | Disabled                | No | Yes | 4-117 |
| ► Metadata Set List         | –                       | No | Yes | 4-121 |
| ► Metadata Set Registration | –                       | No | Yes |       |

### Document Filing Settings

U: General user; A: System administrator/Administrator

| Setup Items             | Factory default setting | U  | A   | Page |
|-------------------------|-------------------------|----|-----|------|
| ● Device Control        |                         |    |     |      |
| ► Condition Settings    |                         |    |     |      |
| ◆ Default Mode Settings | Sharing Mode            | No | Yes | 5-12 |
| ◆ Sort Method Setting   | Date                    | No | Yes | 5-24 |



| Setup Items   | Factory default setting                       | U  | A   | Page |
|---|---|----|-----|------|
| ◆ Administrator Authority Setting                           |   | No | Yes | 5-12 |
| • Delete File   | Disabled                                      | No | Yes |      |
| • Delete Folder   | Disabled                                      | No | Yes |      |
| • Change PIN Code/Password                                  | Disabled                                      | No | Yes |      |
| ◆ Delete All Quick Files                                    |   | No | Yes | 5-9  |
| • Delete  | –   | No | Yes |      |
| • Delete quick files at power up.(Protected files excluded) | Enabled                                       | No | Yes |      |
| ◆ Image Orientation   | Portrait                                      | No | Yes | 5-17 |
| ◆ Default Color Mode Settings                               | Auto, Mono2                                   | No | Yes |      |
| • Disable Change of B/W Setting in Auto Mode                | Disabled                                      | No | Yes |      |
| ◆ Default Exposure Settings                                 | Auto  | No | Yes |      |
| ◆ Default Original Image Type                               | Text  | No | Yes |      |
| ◆ Initial Resolution Settings                               | 200x200dpi                                    | No | Yes |      |
| ◆ Default Output Tray                                       | Varies depending on the machine configuration | No | Yes |      |
| ◆ Disable Text/Stamp functions for Reprinting               | Disabled                                      | No | Yes | 5-25 |
| ◆ Batch Print Settings                                      |   | No | Yes | 5-28 |
| • Selection of [All Users] is not allowed.                  | Enabled                                       | No | Yes |      |
| • Selection of [User Unknown] is not allowed.               | Enabled                                       | No | Yes |      |
| • Print Order Setting for the Batch Print/Multi-File Print  | Date (Dsc.)                                   | No | Yes |      |
| ◆ Erase Width Adjustment                                    |   | No | Yes | 5-17 |
| • Edge Clearance Width                                      | 1/2" (10mm)                                   | No | Yes |      |
| • Center Clearance Width                                    | 1/2" (10mm)                                   | No | Yes |      |
| ◆ Card Shot Settings  |   | No | Yes |      |
| • Original Size   | X: 3-3/8" (86 mm),<br>Y: 2-1/8" (54 mm)       | No | Yes |      |
| • Fit to Store Size   | Disabled                                      | No | Yes |      |
| ◆ Setting of store/delete after file print                  | Store   | No | Yes | 5-25 |





| Setup Items                                     | Factory default setting | U  | A   | Page |
|---|-------------------------|----|-----|------|
| ◆ Default Setting of PDF Format for PC Browsing |                         | No | Yes | 5-14 |
| • B/W   |                         | No | Yes |      |
| - Compression Mode                              | MMR (G4)                | No | Yes |      |
| • Color/Grayscale                               |                         | No | Yes |      |
| - Compression Ratio                             | Medium                  | No | Yes |      |
| • Copies  | Disabled                | No | Yes |      |
| - Apply the resolution at job execution         | Disabled                | No | Yes |      |
| - Resolution                                    | 200x200dpi              | No | Yes |      |
| • Printer                                       | Disabled                | No | Yes |      |
| - Apply the resolution at job execution         | Disabled                | No | Yes |      |
| - Resolution                                    | 200x200dpi              | No | Yes |      |
| • Scan to                                       | Disabled                | No | Yes |      |
| - Apply the resolution at job execution         | Disabled                | No | Yes |      |
| - Resolution                                    | 200x200dpi              | No | Yes |      |
| • Scan to Local Drive                           | Enabled                 | No | Yes |      |
| - Apply the resolution at job execution         | Disabled                | No | Yes |      |
| - Resolution                                    | 200x200dpi              | No | Yes |      |



| Setup Items                           | Factory default setting | U  | A   | Page |
|---------------------------------------|-------------------------|----|-----|------|
| ◆ Document Output Options             |                         | No | Yes | 5-23 |
| • Print                               |                         | No | Yes |      |
| - Copies                              | Enabled                 | No | Yes |      |
| - Printer                             | Enabled                 | No | Yes |      |
| - Scan Send                           | Disabled                | No | Yes |      |
| - Scan to Local Drive                 | Enabled                 | No | Yes |      |
| • Scan Send                           |                         | No | Yes |      |
| - Copies                              | Disabled                | No | Yes |      |
| - Printer                             | Disabled                | No | Yes |      |
| - Scan Send                           | Enabled                 | No | Yes |      |
| - Scan to Local Drive                 | Enabled                 | No | Yes |      |
| ▶ Document Filing Control*1           | –                       | No | Yes |      |
| ▶ Automatic Deletion of File Settings | All Invalid             | No | Yes | 5-33 |

\*1 This setting is configured in setting mode on the machine.



## Sharp OSA Settings

U: General user; A: System administrator/Administrator

| Setup Items  | Factory default setting | U  | A   | Page  |
|--|-------------------------|----|-----|-------|
| ● Sharp OSA Settings                                       |                         |    |     |       |
| ▶ Condition Settings                                       |                         | No | Yes | 1-146 |
| ◆ Sharp OSA version  | –                       | No | Yes |       |
| ◆ Cookie Setting*  | Not hold Cookie         | No | Yes |       |
| ◆ Delete Cookie*   | –                       | No | Yes |       |
| ◆ Accept remote access request from application            | –                       | No | Yes |       |
| ◆ Application allowed to access                            | –                       | No | Yes |       |
| ◆ Approve remote access request on operation panel         | –                       | No | Yes |       |
| ◆ Accept UI operation request from application             | –                       | No | Yes |       |
| ◆ Display dialog of connection in Sharp OSA mode           | –                       | No | Yes |       |
| ◆ Accept secondary send request from Sharp OSA application | –                       | No | Yes |       |
| ▶ Standard Application Settings                            | –                       | No | Yes |       |
| ▶ Receiving Application Setting                            |                         | No | Yes | 1-148 |
| ▶ External Accounting Application Settings                 |                         | No | Yes |       |
| ▶ Embedded Application Settings                            | –                       | No | Yes | 1-148 |
| ▶ Polling Setting  |                         | No | Yes |       |

\* This setting is configured in setting mode on the machine.

## Authentication Settings

U: General user; A: System administrator/Administrator

| Setup Items   | Factory default setting | U  | A   | Page |
|---|-------------------------|----|-----|------|
| ▶ Default Settings  |                         | No | Yes | 1-41 |
| ◆ User Authentication   | Disabled                | No | Yes |      |
| ◆ Authentication Server Settings                              | Local                   | No | Yes |      |
| ◆ Default Network Authentication Server Setting* <sup>1</sup> | Not Set                 | No | Yes |      |
| ◆ Perform network server access control                       | Disabled                | No | Yes | 1-42 |
| ◆ Authentication Method Setting                               | Login Name/Password     | No | Yes | 1-45 |



| Setup Items   | Factory default setting           | U  | A   | Page |
|---|-----------------------------------|----|-----|------|
| • Case sensitivity of login name is enabled.                    | Enabled                           | No | Yes | 1-44 |
| ◆ Enable Quick Login  | Disabled                          | No | Yes |      |
| ◆ Device Account Mode Setting                                   |                                   | No | Yes |      |
| • Device Account Mode   | Disabled                          | No | Yes |      |
| • Allow Login by Different User                                 | Disabled                          | No | Yes |      |
| • Disable Home Edit Mode when in Device Account Mode            | Disabled                          | No | Yes |      |
| ◆ Login User  | –                                 | No | Yes |      |
| • User Selection  | –                                 | No | Yes |      |
| ◆ Settings for Using Authentication Information                 | –                                 | No | Yes |      |
| ◆ Store User Information  | Enabled                           | No | Yes |      |
| • Store Password  | Enabled                           | No | Yes |      |
| • Cache Period  | Unlimited                         | No | Yes |      |
| • Enable Personalization when external authentication is used   | Enabled                           | No | Yes |      |
| ◆ Enable Offline Authentication with stored User Information    | Enabled                           | No | Yes |      |
| • Cache Password for Authentication                             | Enabled                           | No | Yes | 1-45 |
| ◆ Cache Authentication Information for External Service Connect | Enabled                           | No | Yes |      |
| ◆ Card Setting  |                                   | No | Yes | 1-45 |
| • Use IC Card for Authentication                                | Disabled                          | No | Yes |      |
| • Authentication Method Setting                                 | Only Card Authentication Approved | No | Yes |      |
| • Request Password at IC Card Authentication                    | Only Card Authentication Approved | No | Yes |      |
| • Automatic Logout with a Card                                  | Disabled                          | No | Yes |      |
| ◆ Administration Settings                                       | –                                 | No | Yes |      |
| ◆ Authentication Options  | –                                 | No | Yes |      |
| ◆ Disable Printing by Invalid User                              | Disabled                          | No | Yes |      |
| ◆ Automatic Logout Setting                                      | Enabled                           | No | Yes |      |
| ◆ A Warning when Login Fails*2                                  | Disabled                          | No | Yes |      |



| Setup Items  | Factory default setting                                  | U  | A   | Page |
|--|--|----|-----|------|
| ◆ Allow Remote Scanner Using Before Login.                                 | Disabled   | No | Yes | 1-46 |
| ◆ Include Job Management in user authentication                            | Disabled   | No | Yes |      |
| ◆ Enable IPP Authentication Except for Printer Driver                      | Enabled  | No | Yes |      |
| ◆ Actions when the user is authenticated                                   | –  | No | Yes |      |
| ◆ Actions when the Limit of Pages for Output Jobs*2                        | Job is Completed even when the Limit of Pages is Reached | No | Yes |      |
| • Cancel and delete the job during receiving                               | –  | No | Yes |      |
| ◆ Automatically print stored jobs after login                              | Disabled   | No | Yes |      |
| ◆ Reset the counter after sending E-mail status                            | Disabled   | No | Yes |      |
| • Disable display/change of other users' information in the job management | –  | No | Yes |      |
| ◆ Screen Display Settings after the authentication                         | –  | No | Yes |      |
| ◆ Apply login name to the user name of network folder                      | –  | No | Yes |      |
| ◆ Login Name Display   | Display login name                                       | No | Yes |      |
| ◆ Display Usage Status after Login   | Disabled   | No | Yes |      |
| ◆ Edit Help Display of Login Screen  | –  | No | Yes |      |
| ► Card Reader Settings   | –  | No | Yes | 1-47 |
| ◆ Importing from the setup file  | –  | No | Yes |      |
| ◆ Card Scan Test   | –  | No | Yes |      |
| ◆ Card Type / Card Reader  | 200(HID Card)  | No | Yes |      |
| ◆ Check System Code only in FeliCa User Area mode                          | Disabled   | No | Yes |      |
| • Card ID Registration/Change Authority                                    | Disabled   | No | Yes |      |
| • SSFC Card Setting  | –  | No | Yes |      |
| • Check Facility Code in HID mode  | Disabled   | No | Yes |      |
| ◆ Importing from the setup file  | –  | No | Yes |      |

\*1 Appears when [LDAP] is set in "Authentication Settings".

\*2 Disappears when "Settings (administrator)" - [Sharp OSA Settings] → [External Accounting Application Settings] → [Set Authentication Server (Server 1)] is enabled.

\*3 This setting is configured in setting mode on the machine.



## Common Settings

U: General user; A: System administrator/Administrator

| Setup Items   | Factory default setting  | U   | A   | Page  |       |
|---|--|-----|-----|-------|-------|
| ● Common Settings   |  |     |     |       |       |
| ▶ Paper Settings  |  |     |     |       |       |
| ◆ Paper Tray Settings   |  | Yes | Yes | 1-111 |       |
| • Auto Switching of Tray                                      | Enabled  | Yes | Yes |       |       |
| • Display Paper Tray Settings when bypass tray detects paper. | Enabled  | Yes | Yes |       |       |
| - Tray 1  | Plain 1,<br>8-1/2" x 11" (A4)  | Yes | Yes |       |       |
| - Tray 2  | Plain 1,<br>8-1/2" x 11" (A4)  | Yes | Yes |       |       |
| - Tray 3  | Plain 1,<br>Auto-Inch (Auto-AB)  | Yes | Yes |       |       |
| - Tray 4  | Plain 1,<br>Auto-Inch (Auto-AB)  | Yes | Yes |       |       |
| - Tray 5/7*1, 2,  | Plain 1,<br>8-1/2" x 11" (A4)*1,<br>Plain 1,<br>11" x 17" (A3)*2       | Yes | Yes |       |       |
| - Tray 6/8*2  | Plain 1,<br>Auto-Inch (Auto-AB)  | Yes | Yes |       |       |
| - Bypass Tray   | Plain 1,<br>Auto-Inch (Auto-AB)  | Yes | Yes |       |       |
| - Inserter (Upper)  | Plain 1,<br>Auto-Inch (Auto-AB)  | Yes | Yes |       |       |
| - Inserter (Lower)  | Plain 1,<br>Auto-Inch (Auto-AB)  | Yes | Yes |       |       |
| • Paper Weight  | 16 - 23 lbs.<br>(60 - 89 g/m <sup>2</sup> ),                           | Yes | Yes |       | 7-65  |
| • Custom Size Registration (Bypass)                           | Custom 1 to 7<br>Auto-Inch (Auto-AB)<br>X=17" (420mm)<br>Y=11" (297mm) | Yes | Yes |       | 1-113 |
| • Paper Type Registration                                     | –  | Yes | Yes |       |       |



| Setup Items  | Factory default setting         | U  | A   | Page |
|--|---------------------------------|----|-----|------|
| ► Operation Settings   |                                 |    |     |      |
| ◆ Condition Settings   |                                 |    |     |      |
| • Screen Display Settings                                      |                                 | No | Yes | B    |
| - Enlarge Display Mode   | Disabled                        | No | Yes |      |
| - Message Time Setting   | 6 sec.                          | No | Yes |      |
| - Language Setting   | American English                | No | Yes |      |
| - Default Display Setting                                      | Home Screen                     | No | Yes |      |
| - Display Favorite Menus as Default                            | Disabled                        | No | Yes |      |
| - Display Action Panel as default.                             | Enabled                         | No | Yes |      |
| - Icon is displayed when network cable is not connected.       | Enabled                         | No | Yes |      |
| - Display Confirmation Dialog when job is canceled.            | Enabled                         | No | Yes |      |
| - Display Status Notification Message                          | Enabled                         | No | Yes |      |
| - Restrict Total Count display                                 | Disabled                        | No | Yes |      |
| - Switch the Number of Sets to be Displayed for Job Management | Progress                        | No | Yes |      |
| - Display the estimated job start time                         | Disabled                        | No | Yes |      |
| - Alignment Order of 10-Key                                    | Ascending order from upper left | No | Yes |      |
| - Setting Display from Main Unit                               |                                 | No | Yes |      |
| + Display Current Path   | Enabled                         | No | Yes |      |
| + Enable link of current path                                  | Enabled                         | No | Yes |      |
| + MFP Display Pattern Setting                                  | Pattern 1                       | No | Yes |      |
| ◆ Key Operation Setting  |                                 | No | Yes |      |
| • Auto Clear Setting   | 60sec.                          | No | Yes |      |
| - Cancel Timer   | Disabled                        | No | Yes |      |
| • Key Operation Setting  | –                               | No | Yes |      |
| - Time for Accepting Key Entry                                 | 0.0 seconds                     | No | Yes |      |
| - Disable Auto Key Repeat                                      | Disabled                        | No | Yes |      |
| - Time for Accepting Key Entry of Long Touch                   | 0.5 seconds                     | No | Yes |      |
| - Double Tap Interval Setting                                  | 0.5 seconds                     | No | Yes |      |
| • Disabling of Job Priority Operation                          | Disabled                        | No | Yes |      |
| • Disabling of Bypass Printing                                 | Disabled                        | No | Yes |      |
| • Priority of Print Jobs                                       | –                               | No | Yes |      |



| Setup Items   | Factory default setting    | U  | A   | Page  |  |
|---|----------------------------|----|-----|-------|--|
| • Disabling of Covers/Inserts Mode                              | Disabled                   | No | Yes | 2-112 |  |
| • Disable Printing of Operation Manual from the Operation Panel | Disabled                   | No | Yes | 1-84  |  |
| • Initial Original Count Setting                                | All Invalid                | No | Yes | 1-115 |  |
| ◆ Preview Setting   |                            |    |     |       |  |
| • Default List/Thumbnail Display                                |                            | No | Yes | 1-15  |  |
| • File Retrieve of Main Folder/Quick File Folder                | List                       | No | Yes |       |  |
| • File Retrieve of Custom Folder                                | List                       | No | Yes |       |  |
| • File Retrieve of Direct Print                                 | List                       | No | Yes |       |  |
| ◆ Remote Operation Settings                                     |                            | No | Yes |       |  |
| • Remote Software Operation                                     |                            | No | Yes | 1-77  |  |
| - Operational Authority   | Prohibited                 | No | Yes |       |  |
| - View Password Entry Screen                                    | Display in Both PC and MFP | No | Yes |       |  |
| • Operation from Specified PC                                   |                            | No | Yes |       |  |
| - Operational Authority   | Prohibited                 | No | Yes |       |  |
| - Hostname or IP Address of PC                                  | –                          | No | Yes |       |  |
| - View Password Entry Screen                                    | Display in Both PC and MFP | No | Yes |       |  |
| • Operation by User who Has Password                            |                            | No | Yes |       |  |
| - Operational Authority   | Prohibited                 | No | Yes |       |  |
| - View Password Entry Screen                                    | Display in Both PC and MFP | No | Yes |       |  |
| ◆ Data List   |                            |    |     |       |  |
| • Data List   | 1-Sided                    | No | Yes | 7-72  |  |
| ◆ Tandem Connection Setting                                     |                            |    |     |       |  |
| • IP Address of Client Machine                                  | 0.0.0.0                    | No | Yes |       |  |
| • Port Number   | 50001                      | No | Yes |       |  |
| • Tandem Mode   | –                          | No | Yes |       |  |
| - Disabling of Master Machine Mode                              | Disabled                   | No | Yes |       |  |
| - Disabling of Client Machine Mode                              | Disabled                   | No | Yes |       |  |





| Setup Items  | Factory default setting                                | U  | A   | Page       |
|--|--|----|-----|------------|
| ◆ Easy Mode Settings   | –  | No | Yes | 2-3<br>4-7 |
| • Display a Confirmation Message when Selecting "Detail" in Easy Modes   | Enabled  | No | Yes | 2-3<br>4-8 |
| ◆ Favorite Key Setting   | –  | No | Yes | B          |
| ◆ Mode Key Display Setting   |  | No | Yes | 1-13       |
| • Modes to Display   | –  | No | Yes |            |
| • Display Mode Keys on Home  | Enabled  | No | Yes |            |
| ◆ Keyboard Settings  |  | No | Yes | B          |
| • Default Keyboard Setting   |  | No | Yes |            |
| • Keyboard Select  | English (US)   | No | Yes |            |
| • Set Keyboard Priority  | External Keyboard                                      | No | Yes |            |
| • Soft Keyboard Template Setting   | –  | No | Yes |            |
| ◆ Custom Links   | –  | No | Yes | 7-72       |
| ► Device Control   |  |    |     |            |
| ◆ Condition Settings   |  |    |     |            |
| • Original Size Detector Setting   | Inch-1 (AB-1)  | No | Yes | 1-114      |
| • Cancel Detection at Document Glass                                     | Disabled   | No | Yes |            |
| • Original Feeding Mode  | All Off  | No | Yes | 1-115      |
| • Double Feed Detection Setting  | Enabled  | No | Yes |            |
| • Actions When Maximum Number of Sheets that can be Stapled is Reached*3 | Stop the Job and Display Confirmation Message          | No | Yes | 7-72       |
| • Automatic Saddle Stitch*4  | Enabled  | No | Yes | 2-39       |
| • Saddle Fold/Stitch Position Adjust*4                                   | –  | No | Yes | 7-72       |
| • Paper Type for Auto Paper Selection                                    | Plain 1: Enabled, Plain 2: Enabled, Recycled: Disabled | No | Yes | 7-72       |
| • Plain Paper Compatibility Settings                                     | Plain 1  | No | Yes |            |



| Setup Items   | Factory default setting                             | U  | A   | Page  |
|---|---|----|-----|-------|
| • Detect Standard in Auto Color Mode                    | 3 (Normal)  | No | Yes | 7-72  |
| • Total Setting for Finish                              | Specify Finishing Position Based on Paper Selected. | No | Yes |       |
| • Disabling of Duplex                                   | Disabled  | No | Yes |       |
| • Disabling of Offset                                   | Disabled  | No | Yes |       |
| • Disabling of Stapler*3                                | Disabled  | No | Yes |       |
| • Disabling of Punch*4                                  | Disabled  | No | Yes |       |
| • Disabling of Color Mode                               | Disabled  | No | Yes |       |
| • Disabling of Document Feeder                          | Disabled  | No | Yes |       |
| • Disabling of Large Capacity Cassette*1, 2             | Disabled  | No | Yes |       |
| • Disabling of Tray Settings                            | Disabled  | No | Yes |       |
| • Disabling of Inserter*6                               | Disabled  | No | Yes |       |
| • Disabling of Finisher*3                               | Disabled  | No | Yes |       |
| • Disabling of Folding Unit*7                           | Disabled  | No | Yes |       |
| • Disabling of Trimming Module*8                        | Disabled  | No | Yes |       |
| • Disabling of Bypass-Tray                              | Disabled  | No | Yes |       |
| ◆ Status Indicator Setting                              | –   | No | Yes | 1-142 |
| • Data Indicator Setting*9                              | Pattern 1   | No | Yes |       |
| • Status Indicator will blink if data is received*9     | Enabled   | No | Yes |       |
| • Error Light Setting*9                                 | Light & Blink                                       | No | Yes |       |
| • Use Communication Indicator                           | Enabled   | No | Yes |       |
| • Use Preventive Light to Indicate Original Left Behind | Enabled   | No | Yes |       |
| ◆ Machine Identification Settings                       | –   | No | Yes | 7-75  |
| ◆ Clock Adjust  |   | No | Yes | 7-75  |
| • Clock Adjust  |   | No | Yes |       |
| - Current Date  | –   | No | Yes |       |
| - Specify Time Zone                                     | –   | No | Yes |       |
| - Date&Time Settings                                    | –   | No | Yes |       |
| - Synchronize with Internet Time Server                 | Disabled  | No | Yes |       |
| • Daylight Saving Time Setting                          | Disabled  | No | Yes |       |



| Setup Items  | Factory default setting              | U  | A   | Page  |
|--|--------------------------------------|----|-----|-------|
| • Date Format  |                                      | No | Yes | 7-76  |
| - Current Setting                                      | –                                    | No | Yes |       |
| - Format   | [MM/DD/YYYY], [/], [Last], [12-Hour] | No | Yes |       |
| ◆ Enable/Disable Settings                              |                                      |    |     |       |
| • Authentication Settings                              |                                      |    |     |       |
| - Disable Home Edit Mode when in Device Account Mode   | Disabled                             | No | Yes | 1-45  |
| - Disabling of Printing by Invalid User                | Disabled                             | No | Yes |       |
| • Copy Function Settings                               |                                      |    |     |       |
| - Disabling of Registration/Deletion of Program        | Disabled                             | No | Yes | 2-134 |
| - Disabling of Bypass-Tray in Duplex Copy              | Disabled                             | No | Yes | 2-34  |
| - Disabling of Auto Paper Selection                    | Disabled                             | No | Yes | 2-12  |
| - Disabling Registration of Custom Image               | Disabled                             | No | Yes | 2-101 |
| - Disabling sending while copying                      | Disabled                             | No | Yes | 2-131 |
| • Printer Settings                                     |                                      |    |     |       |
| - Prohibit Notice Page Printing                        | Enabled                              | No | Yes | 3-3   |
| - Prohibit Test Page Printing                          | Disabled                             | No | Yes | 7-55  |
| - Exclude Bypass-Tray from Auto Paper Select           | Disabled                             | No | Yes | 3-7   |
| - Disabling of USB Memory Direct Print                 | Disabled                             | No | Yes | 3-83  |
| - Disabling of Network Folder Direct Print             | Disabled                             | No | Yes | 3-84  |
| - Disabling sending while printing                     | Disabled                             | No | Yes | 3-80  |
| - Disable Blank Page Print                             | Disabled                             | No | Yes | 3-23  |
| • Image Send Settings                                  |                                      |    |     |       |
| - Disable Switching of Display Order                   | Disabled                             | No | Yes | A     |
| - Disable Registering Destination from Operation Panel | All Invalid                          | No | Yes | A     |
| - Disable Registering Destination on Web Page          | All Invalid                          | No | Yes | A     |



| Setup Items   | Factory default setting | U  | A   | Page  |
|---|-------------------------|----|-----|-------|
| - Disabling of Registration/Deletion of Program                 |                         | No | Yes | 4-59  |
| + Disable Registration/Deletion of All Program Items            | Disabled                | No | Yes |       |
| - Disable Destination Registration Using Global Address Search  | All Invalid             | No | Yes | A     |
| - Disable Registration Using Network Scanner Tool               | Disabled                | No | Yes | 4-6   |
| - Disabling of Forwarding via Network                           | Disabled                | No | Yes | 4-6   |
| - Settings to Disable Transmission                              |                         |    |     |       |
| + Disable [Resend] on Image Send Mode                           | Disabled                | No | Yes | 4-25  |
| + Disable Selection from Address Book                           | All Invalid             | No | Yes | 4-14  |
| + Disable Direct Entry  | All Invalid             | No | Yes | 4-20  |
| + Disabling of Find My Address                                  | Disabled                | No | Yes | 4-17  |
| • Document Filing Settings                                      |                         |    |     |       |
| - Disable Text/Stamp functions for Reprinting                   | Disabled                | No | Yes | 5-25  |
| - Batch Print Settings  |                         |    |     |       |
| + Selection of [All Users] is not allowed.                      | Enabled                 | No | Yes | 5-28  |
| + Selection of [User Unknown] is not allowed.                   | Enabled                 | No | Yes |       |
| • Operation Settings  |                         |    |     |       |
| - Cancel Timer  | Disabled                | No | Yes | B     |
| - Disabling of Bypass Printing                                  | Disabled                | No | Yes |       |
| - Disable Auto Key Repeat                                       | Disabled                | No | Yes |       |
| - Disabling of Covers/Inserts Mode                              | Disabled                | No | Yes | 2-112 |
| - Disable Printing of Operation Manual from the Operation Panel | Disabled                | No | Yes | 1-84  |



| Setup Items                                 | Factory default setting | U  | A   | Page |
|---|-------------------------|----|-----|------|
| • Device Control                            |                         |    |     |      |
| - Disabling of Document Feeder              | Disabled                | No | Yes | 7-72 |
| - Disabling of Duplex                       | Disabled                | No | Yes |      |
| - Disabling of Large Capacity Cassette*1, 2 | Enabled                 | No | Yes |      |
| - Disabling of Tray Settings                | Disabled                | No | Yes |      |
| - Disabling of Finisher*3                   | Disabled                | No | Yes |      |
| - Disabling of Bypass-Tray                  | Disabled                | No | Yes |      |
| - Disabling of Offset                       | Disabled                | No | Yes |      |
| - Disabling of Stapler*3                    | Disabled                | No | Yes |      |
| - Disabling of Punch*5                      | Disabled                | No | Yes |      |
| - Disabling of Color Mode                   | Disabled                | No | Yes |      |
| - Disabling of Inserter*6                   | Disabled                | No | Yes |      |
| - Disabling of Folding Unit*7               | Disabled                | No | Yes |      |
| - Disabling of Trimming Module*8            | Disabled                | No | Yes |      |
| - Disabling of Master Machine Mode          | Disabled                | No | Yes |      |
| - Disabling of Client Machine Mode          | Disabled                | No | Yes |      |
| • Security Settings                         |                         |    |     |      |
| - Hidden Pattern Print Setting              |                         | No | Yes | 7-99 |
| + Disable Direct Entry                      | Disabled                | No | Yes |      |
| ◆ Product Key                               |                         | No | Yes | 7-76 |
| • Serial Number                             | –                       | No | Yes |      |
| • Font Kit for Barcode                      | –                       | No | Yes |      |
| • E-mail Alert and Status                   | –                       | No | Yes |      |
| • Data Security Kit                         | –                       | No | Yes |      |
| • Application Integration Module            | –                       | No | Yes |      |
| ◆ Application Number Input                  |                         | No | Yes |      |
| • Serial Number                             | –                       | No | Yes |      |
| • Font Kit for Barcode                      | –                       | No | Yes |      |
| • E-mail Alert and Status                   | –                       | No | Yes |      |
| • Data Security Kit                         | –                       | No | Yes |      |
| • Application Integration Module            | –                       | No | Yes |      |



| Setup Items                        | Factory default setting | U  | A   | Page |
|------------------------------------|-------------------------|----|-----|------|
| ► Sound Settings                   |                         |    |     | 7-77 |
| ◆ Beep Sound Settings (Common)     | –                       | No | Yes |      |
| ◆ Keys Touch Sound                 | Middle                  | No | Yes |      |
| ◆ Beep of Invalid Input            | Middle                  | No | Yes |      |
| ◆ Reference Tone                   | No Sound                | No | Yes |      |
| ◆ Copy Complete Sound              | No Sound                | No | Yes |      |
| ◆ Scan Complete Sound (Image Send) | Middle                  | No | Yes |      |
| ◆ Powering Off Sound               | Middle                  | No | Yes |      |
| ► Caution Sound Settings           | –                       | No | Yes |      |
| ◆ Beep Sound Settings (Image Send) | –                       | No | Yes |      |

\*1 When a large capacity tray (MX-LC12) is installed.

\*2 When the large capacity trays are installed.

\*3 When a saddle stitch finisher (large stacker) is installed.

\*4 When a finisher (large stacker)/saddle stitch finisher (large stacker) is installed.

\*5 When a finisher (large stacker)/saddle stitch finisher (large stacker) is installed and a punch module is installed.

\*6 When the inserter is installed.

\*7 When the folding unit is installed.

\*8 When the trimming module is installed.

\*9 When the status indicator is installed.



## Network Settings

U: General user; A: System administrator/Administrator

| Setup Items             | Factory default setting | U  | A   | Page |      |
|-------------------------|-------------------------|----|-----|------|------|
| ● Network Settings      |                         |    |     |      |      |
| ▶ Quick Settings        |                         |    |     |      |      |
| ◆ IPv4 Settings         |                         | No | Yes | 7-78 |      |
| • DHCP                  | Enabled                 | No | Yes |      |      |
| • IPv4 Address          | –                       | No | Yes |      |      |
| • Subnet Mask           | –                       | No | Yes |      |      |
| • Default Gateway       | –                       | No | Yes |      |      |
| ◆ Network Name Settings |                         | No | Yes |      |      |
| • Device Name           | –                       | No | Yes |      |      |
| • Domain Name           | –                       | No | Yes |      |      |
| ◆ DNS Settings          |                         | No | Yes |      |      |
| • Primary Server        | –                       | No | Yes |      |      |
| • Secondary Server      | –                       | No | Yes |      |      |
| • Domain Name           | –                       | No | Yes |      |      |
| ◆ SMTP Settings         |                         | No | Yes |      | 7-79 |
| • Primary Server        | –                       | No | Yes |      |      |
| - Sender Name           | –                       | No | Yes |      |      |
| • Sender Address        | –                       | No | Yes |      |      |
| • Enable SSL            | –                       | No | Yes |      |      |
| • SMTP Authentication   | –                       | No | Yes |      |      |
| • User Name             | –                       | No | Yes |      |      |
| • Password              | –                       | No | Yes |      |      |
| - Change Password       | –                       | No | Yes |      |      |
| • Connection Test       | –                       | No | Yes |      |      |
| ◆ LDAP Settings         |                         | No | Yes | 7-80 |      |
| • Name                  | –                       | No | Yes |      |      |
| • Search Root           | –                       | No | Yes |      |      |
| • LDAP Server           | –                       | No | Yes |      |      |
| • User Name             | –                       | No | Yes |      |      |
| • Password              | –                       | No | Yes |      |      |
| - Change Password       | –                       | No | Yes |      |      |
| • Authentication Type   | –                       | No | Yes |      |      |
| • KDC Server            | –                       | No | Yes |      |      |
| • Realm                 | –                       | No | Yes |      |      |



| Setup Items                      | Factory default setting | U  | A   | Page |
|----------------------------------|-------------------------|----|-----|------|
| • Enable SSL                     | –                       | No | Yes | 7-79 |
| • Connection Test                | –                       | No | Yes |      |
| ◆ Public Folder / NAS Setting    |                         | No | Yes |      |
| • public                         |                         | No | Yes |      |
| - Use of Storage                 | Allowed                 | No | Yes |      |
| • shared                         |                         | No | Yes |      |
| - Use of Storage                 | Allowed                 | No | Yes |      |
| ► Network Name Setting           |                         | No | Yes | 7-81 |
| ◆ Device Name                    | –                       | No | Yes |      |
| ◆ Domain Name                    | –                       | No | Yes |      |
| ◆ Comment                        | –                       | No | Yes |      |
| ► Interface Settings             |                         | No | Yes |      |
| ◆ IPv4 Settings                  |                         | No | Yes |      |
| • DHCP                           | Enabled                 | No | Yes |      |
| • IPv4 Address                   | –                       | No | Yes |      |
| • Subnet Mask                    | –                       | No | Yes |      |
| • Default Gateway                | –                       | No | Yes |      |
| ◆ IPv6 Settings                  |                         | No | Yes |      |
| • IPv6                           | Enabled                 | No | Yes |      |
| • DHCPv6                         | Enabled                 | No | Yes |      |
| • Manual Address / Prefix Length | –                       | No | Yes |      |
| • Default Gateway                | –                       | No | Yes |      |
| ◆ MTU Settings                   |                         | No | Yes | 7-82 |
| • MTU                            | 1500                    | No | Yes |      |
| ◆ Ping Command                   |                         | No | Yes |      |
| • IPv4                           | –                       | No | Yes |      |
| • IPv6                           | –                       | No | Yes |      |
| ◆ DNS Settings                   |                         | No | Yes |      |
| • IPv4 Settings                  |                         | No | Yes |      |
| - Primary Server                 | –                       | No | Yes |      |
| - Secondary Server               | –                       | No | Yes |      |
| • IPv6 Settings                  |                         | No | Yes |      |
| - Primary Server                 | –                       | No | Yes | 7-82 |
| - Secondary Server               | –                       | No | Yes |      |
| - Domain Name                    | –                       | No | Yes |      |
| - DNS Update                     | Disabled                | No | Yes |      |





| Setup Items                         | Factory default setting | U  | A   | Page |
|-------------------------------------|-------------------------|----|-----|------|
| ◆ IEEE802.1X Setting                |                         | No | Yes | 7-83 |
| • IEEE802.1X Authentication (Wired) | Disabled                | No | Yes |      |
| • EAP Authentication Method         | EAP-TLS                 | No | Yes |      |
| • EAP User Name                     | –                       | No | Yes |      |
| • Password                          | –                       | No | Yes |      |
| - Change Password                   | Disabled                | No | Yes |      |
| • Server Authentication             | Enabled                 | No | Yes |      |
| • EAP Timeout                       | 10 seconds              | No | Yes |      |
| • Number of EAP Retries             | 3 times                 | No | Yes |      |
| • Certificate Status                | –                       | No | Yes |      |
| • CA Certificate Status             | –                       | No | Yes |      |
| ► Services Settings                 |                         | No | Yes | 7-84 |
| ◆ SMTP                              | –                       | No | Yes |      |
| • SMTP Settings                     | –                       | No | Yes |      |
| - Primary Server                    | –                       | No | Yes |      |
| - Secondary Server                  | –                       | No | Yes |      |
| - Port Number                       | 25                      | No | Yes |      |
| - Timeout                           | 20 seconds              | No | Yes |      |
| - Sender Name                       | –                       | No | Yes |      |
| - Sender Address                    | –                       | No | Yes |      |
| - Enable SSL                        | Disabled                | No | Yes |      |
| - SMTP Authentication               | Disabled                | No | Yes |      |
| - User Name                         | –                       | No | Yes |      |
| - Password                          | –                       | No | Yes |      |
| - POP before SMTP                   | Disabled                | No | Yes |      |
| - Connection Test                   | –                       | No | Yes |      |



| Setup Items                        | Factory default setting         | U  | A   | Page |
|------------------------------------|---------------------------------|----|-----|------|
| ◆ Kerberos                         | –                               | No | Yes | 7-85 |
| • Kerberos Authentication Settings | –                               | No | Yes |      |
| - KDC Server                       | –                               | No | Yes |      |
| - Port Number                      | 88                              | No | Yes |      |
| - Realm                            | –                               | No | Yes |      |
| ◆ SNTP                             | –                               | No | Yes |      |
| • SNTP Settings                    | –                               | No | Yes |      |
| - SNTP                             | Disabled                        | No | Yes |      |
| - SNTP Server                      | –                               | No | Yes |      |
| - Port Number                      | 123                             | No | Yes |      |
| - Timeout                          | 5 seconds                       | No | Yes |      |
| - Synchronous Interval             | 6 hours                         | No | Yes |      |
| - Synchronize Upon Start           | Disabled                        | No | Yes |      |
| - Synchronize Now                  | –                               | No | Yes |      |
| ◆ mDNS                             | –                               | No | Yes |      |
| • mDNS Settings                    | –                               | No | Yes |      |
| - mDNS                             | Enabled                         | No | Yes |      |
| - Service Name                     | Model Name (Serial Number)      | No | Yes |      |
| - Domain Name                      | Model Name-Serial Number-.Local | No | Yes |      |
| - Highest Priority Service         | LPD                             | No | Yes |      |
| ◆ SNMP                             | –                               | No | Yes |      |
| • SNMP v1 Settings                 | –                               | No | Yes |      |
| - SNMP v1 Settings                 | Enabled                         | No | Yes |      |
| - Access Method                    | Read-write Access               | No | Yes |      |
| - GET Community                    | public                          | No | Yes |      |
| + SET Community                    | private                         | No | Yes |      |
| - Change SET Community             | Disabled                        | No | Yes |      |
| - TRAP Community                   | public                          | No | Yes |      |
| - TRAP Target Address              | –                               | No | Yes |      |
| • SNMP v3 Settings                 | –                               | No | Yes |      |
| - SNMP v3 Settings                 | Disabled                        | No | Yes |      |
| - User Name                        | –                               | No | Yes |      |
| - Authentication Key               | –                               | No | Yes |      |
| - Privacy Key                      | –                               | No | Yes |      |
| - Context Name                     | –                               | No | Yes | 7-86 |



| Setup Items                          | Factory default setting                      | U  | A   | Page |
|--------------------------------------|--|----|-----|------|
| ◆ SMB Settings                       |  | No | Yes | 7-86 |
| • Use SMB1.0                         | Enabled                                      | No | Yes |      |
| • Use SMB2.0                         | Enabled                                      | No | Yes |      |
| • Use SMB2.1                         | Enabled                                      | No | Yes |      |
| • Use SMB3.0                         | Enabled                                      | No | Yes |      |
| ▶ Print Port Settings                |  | No | Yes |      |
| ◆ LPD                                |  | No | Yes |      |
| • LPD Settings                       |  | No | Yes |      |
| - LPD                                | Enabled                                      | No | Yes |      |
| - Timeout                            | 90 seconds                                   | No | Yes |      |
| - Use Banner                         | Disabled                                     | No | Yes |      |
| ◆ RAW                                |  | No | Yes |      |
| • Raw Print Settings                 |  | No | Yes |      |
| - Raw Print                          | Enabled                                      | No | Yes |      |
| - Port Number                        | 9100   | No | Yes |      |
| - Timeout                            | 90 seconds                                   | No | Yes |      |
| - Use Bidirectional                  | Disabled                                     | No | Yes |      |
| ◆ WSD                                |  | No | Yes | 7-87 |
| • WSD Settings                       |  | No | Yes |      |
| - WSD Print                          | Enabled                                      | No | Yes |      |
| - Use Multicast Discovery            | Enabled                                      | No | Yes |      |
| ▶ External Print Services Settings   |  | No | Yes | -    |
| ◆ AirPrint Settings                  | For AirPrint Settings, see "AirPrint Guide". | No | Yes |      |
| ▶ LDAP Settings                      |  | No | Yes | 7-87 |
| ◆ LDAP Settings                      | Enabled                                      | No | Yes |      |
| ◆ Global Address Books List          | -  | No | Yes |      |
| ▶ Active Directory Settings          |  | No | Yes | 1-60 |
| ◆ Domain Name                        | -  | No | Yes |      |
| ◆ Search Attribute:                  | cn   | No | Yes |      |
| ◆ Linkage with User Control Function | -  | No | Yes |      |
| ◆ Pages Limit Group                  | pagelimit                                    | No | Yes |      |
| ◆ Authority Group                    | authority                                    | No | Yes |      |
| ◆ Favorite Operation Group           | favorite                                     | No | Yes |      |
| ◆ My Folder                          | myfolder                                     | No | Yes |      |
| ◆ Device Registration Account        | -  | No | Yes | 1-60 |
| ◆ User Name                          | -  | No | Yes |      |
| ◆ Password                           | -  | No | Yes |      |
| ◆ Status                             | -  | No | Yes |      |
| ◆ Registration in Active Directory   | -  | No | Yes |      |



| Setup Items                                       | Factory default setting | U  | A   | Page |
|---|-------------------------|----|-----|------|
| ▶ Public Folder / NAS Setting                     |                         |    |     | 1-75 |
| ◆ public  |                         | No | Yes |      |
| • Use of Storage                                  | Allowed                 | No | Yes |      |
| ◆ shared  |                         | No | Yes |      |
| • Use of Storage                                  | Allowed                 | No | Yes |      |
| ▶ Proxy Setting                                   |                         | No | Yes |      |
| ◆ Proxy Setting                                   | Disabled                | No | Yes |      |
| ◆ Proxy Server Address                            | –                       | No | Yes |      |
| ◆ User Name                                       | –                       | No | Yes |      |
| ◆ Password  | –                       | No | Yes |      |
| • Change Password                                 | –                       | No | Yes |      |
| ◆ Port Number                                     | 8080                    | No | Yes |      |
| ◆ Address without Using Proxy                     | –                       | No | Yes |      |
| ▶ Easy Connection Setting                         | –                       | No | Yes | -    |
| ▶ Device Web Page Setting                         |                         | No | Yes | 7-90 |
| ◆ HTTP Access Settings                            |                         | No | Yes |      |
| • Number of Users who can Log-in at the Same Time | 32                      | No | Yes |      |
| • Auto Logout Time                                | 60 minutes              | No | Yes |      |
| ◆ View Login User                                 | –                       | No | Yes |      |
| ◆ Updated Time                                    | –                       | No | Yes |      |
| ◆ Current Login User                              | –                       | No | Yes |      |
| ◆ Logout All Users                                | –                       | No | Yes |      |



## Security Settings

U: General user; A: System administrator/Administrator

| Setup Items   | Factory default setting | U  | A   | Page |
|---|-------------------------|----|-----|------|
| ● Security Settings   |                         |    |     |      |
| ▶ Password Change   | –                       | No | Yes | 7-91 |
| ◆ Restrict Device Web Page Access Via Password              | –                       | No | Yes |      |
| ▶ Condition Settings  |                         |    |     |      |
| ◆ Restrict Print Jobs other than the current Print Hold Job | Disabled                | No | Yes | 7-92 |
| • Restrict Operation  | Force Retention         | No | Yes |      |
| ◆ Automatic Deletion of Suspended Print Jobs                | Disabled                | No | Yes |      |
| • Time until Suspended Print Jobs are Automatically Deleted | 5min.                   | No | Yes |      |
| ◆ Reject Requests from External Sites                       | Disabled                | No | Yes |      |
| ◆ If Firmware Corruption is Detected, Restore It            | Disabled                | No | Yes |      |
| ◆ Apply Security Policy                                     | Disabled                | No | Yes |      |
| ◆ Mandatory Access Control                                  | Disabled                | No | Yes |      |
| ▶ Port Control  |                         |    |     |      |
| ◆ Server Port   |                         |    |     |      |
| • HTTP  | Enabled                 | No | Yes | 7-93 |
| - Port Number   | 80                      | No | Yes |      |
| • HTTPS   | Enabled                 | No | Yes |      |
| - Port Number   | 443                     | No | Yes |      |
| • FTP Print   | Enabled                 | No | Yes |      |
| - Port Number   | 21                      | No | Yes |      |
| • Raw Print   | Enabled                 | No | Yes |      |
| - Port Number   | 9100                    | No | Yes |      |
| • LPD   | Enabled                 | No | Yes |      |
| - Port Number   | 515                     | No | Yes |      |



| Setup Items                      | Factory default setting | U  | A   | Page |
|----------------------------------|-------------------------|----|-----|------|
| • IPP                            | Enabled                 | No | Yes | 7-93 |
| - Port Number                    | 631                     | No | Yes |      |
| • IPP-SSL                        | Disabled                | No | Yes |      |
| - Port Number                    | 443                     | No | Yes |      |
| • Tandem Output Receive          | Enabled                 | No | Yes |      |
| - Port Number                    | 50001                   | No | Yes |      |
| • PC Scan                        | Enabled                 | No | Yes |      |
| - Port Number                    | 52000                   | No | Yes |      |
| • Remote Operation Panel         | Enabled                 | No | Yes |      |
| - Port Number                    | 5900                    | No | Yes |      |
| • SNMPD                          | Enabled                 | No | Yes |      |
| - Port Number                    | 161                     | No | Yes |      |
| • SMB                            | Disabled                | No | Yes |      |
| • SMTP                           | Enabled                 | No | Yes |      |
| • WSD                            | Enabled                 | No | Yes |      |
| • Print Release                  | Disabled                | No | Yes |      |
| - Port Number                    | 53000                   | No | Yes |      |
| • Sharp OSA (Expansion Platform) |                         | No | Yes |      |
| • HTTPS                          | Enabled                 | No | Yes |      |
| - Port Number                    | 10080                   | No | Yes |      |
| • HTTPS                          | Enabled                 | No | Yes |      |
| - Port Number                    | 10443                   | No | Yes |      |
| ◆ Client Port                    |                         | No | Yes |      |
| • HTTP                           | Enabled                 | No | Yes |      |
| • HTTPS                          | Enabled                 | No | Yes |      |
| • FTP                            | Enabled                 | No | Yes |      |
| • FTPS                           | Enabled                 | No | Yes |      |
| • SMTP                           | Enabled                 | No | Yes |      |
| • SMTP-SSL                       | Enabled                 | No | Yes |      |
| • POP3                           | Enabled                 | No | Yes |      |
| • POP3-SSL                       | Enabled                 | No | Yes |      |



| Setup Items  | Factory default setting | U  | A   | Page |
|--|-------------------------|----|-----|------|
| • SNMP-TRAP  | Enabled                 | No | Yes | 7-93 |
| - Port Number                                      | 162                     | No | Yes |      |
| • Notify Job End                                   | Enabled                 | No | Yes |      |
| • LDAP   | Enabled                 | No | Yes |      |
| • LDAP-SSL   | Enabled                 | No | Yes |      |
| • SMB  | Enabled                 | No | Yes |      |
| • SNTP   | Disabled                | No | Yes |      |
| • mDNS   | Enabled                 | No | Yes |      |
| • Tandem Output Send                               | Enabled                 | No | Yes |      |
| • Data Backup Send                                 | Enabled                 | No | Yes |      |
| • Print Release                                    | Enabled                 | No | Yes |      |
| • XMPP   | Disabled                | No | Yes |      |
| ► Filter Setting                                   | Disabled                | No | Yes |      |
| ◆ Filter   | Disabled                | No | Yes |      |
| ◆ IP Address Filter Settings                       |                         | No | Yes |      |
| • Filter Mode                                      | Allowed                 | No | Yes |      |
| • Filter Address 1-4                               |                         | No | Yes |      |
| - Start IP Address                                 | 0.0.0.0                 | No | Yes |      |
| - End IP Address                                   | 0.0.0.0                 | No | Yes |      |
| ◆ MAC Address Filter Settings                      |                         | No | Yes |      |
| • Filter Address 1-10                              | -                       | No | Yes |      |
| • MAC Address                                      | 000000000000            | No | Yes |      |
| ► Intrusion/Attack Detection                       |                         |    |     | 7-94 |
| ◆ Intrusion/Attack Detection                       | Disabled                | No | Yes |      |
| • Detection Period                                 | 1 second                | No | Yes |      |
| • Detected Packet Threshold                        | 50 packets              | No | Yes |      |
| ◆ List of Denied IP Addresses                      |                         | No | Yes | 7-94 |
| ► SSL Settings                                     |                         | No | Yes |      |
| ◆ Setting of SSL                                   |                         | No | Yes |      |
| • Server Port                                      |                         | No | Yes |      |
| - HTTPS  | Enabled                 | No | Yes |      |
| - IPP-SSL  | Disabled                | No | Yes |      |
| - Redirect HTTP to HTTPS in Device Web Page Access | Disabled                | No | Yes |      |



| Setup Items   | Factory default setting | U  | A   | Page |
|---|-------------------------|----|-----|------|
| • Client Port   |                         | No | Yes | 7-95 |
| - HTTPS   | Enabled                 | No | Yes |      |
| - FTPS  | Enabled                 | No | Yes |      |
| - SMTP-SSL  | Enabled                 | No | Yes |      |
| - POP3-SSL  | Enabled                 | No | Yes |      |
| - LDAP-SSL  | Enabled                 | No | Yes |      |
| - Verify Signature of Server Certificate of the Other Party   | Disabled                | No | Yes |      |
| - Use only TLS 1.2  | Disabled                | No | Yes |      |
| - syslog-SSL  | Enabled                 | No | Yes |      |
| • Level of Encryption   | Low                     | No | Yes |      |
| • Device Certificate  | –                       | No | Yes |      |
| - Certificate Status  | –                       | No | Yes |      |
| ► S/MIME Settings   |                         | No | Yes |      |
| ◆ S/MIME Settings   |                         | No | Yes |      |
| • Device Certificate  |                         | No | Yes |      |
| - Certificate Status  | –                       | No | Yes |      |
| • Sign Settings   |                         | No | Yes |      |
| - Sign E-mail   | Always Enable           | No | Yes |      |
| - Signature Algorithm   | SHA-1                   | No | Yes |      |
| • Encryption Settings   |                         | No | Yes |      |
| - Encrypt E-mail  | Always Enable           | No | Yes |      |
| - Encrypt   | AES-128                 | No | Yes |      |
| - Disable sending to the addresses which cannot be encrypted. | Disabled                | No | Yes |      |
| ► IPsec Settings  |                         | No | Yes |      |
| ◆ Condition Settings  |                         | No | Yes |      |
| • IPsec Settings  | Disabled                | No | Yes |      |
| • Authentication Method                                       | Pre-Shared              | No | Yes |      |





| Setup Items                                       | Factory default setting | U  | A   | Page |
|---|-------------------------|----|-----|------|
| • IKEv1 Settings                                  |                         | No | No  | 7-96 |
| - Pre-Shared Key                                  | –                       | No | Yes |      |
| - SA Lifetime (time)                              | 28800 seconds           | No | Yes |      |
| - SA Lifetime (size)                              | 28800KB                 | No | Yes |      |
| - IKE Lifetime                                    | 30sec.                  | No | Yes |      |
| • Device Certificate                              | –                       | No | Yes | 7-97 |
| ◆ IPsec Rules                                     | –                       | No | Yes |      |
| ► Document Administration Function                |                         | No | Yes | 7-98 |
| ◆ Forwarding Destination Settings (Send Data)     |                         | No | Yes |      |
| • Forward Send Data                               | Disabled                | No | Yes |      |
| - E-mail  | –                       | No | Yes |      |
| - Network Folder                                  | –                       | No | Yes |      |
| - FTP   | –                       | No | Yes |      |
| - Desktop   | –                       | No | Yes |      |
| • File Format                                     | TIFF(Multi)             | No | Yes |      |
| ◆ Forwarding Destination Settings (Received Data) |                         | No | Yes |      |
| • Forward Received Data                           | Disabled                | No | Yes |      |
| - E-mail  | –                       | No | Yes |      |
| - FTP   | –                       | No | Yes |      |
| - Desktop   | –                       | No | Yes |      |
| • File Format                                     | TIFF(Multi)             | No | Yes |      |
| ► Hidden Pattern Print Setting                    |                         | No | Yes |      |
| ◆ Initial Status Settings                         |                         | No | Yes |      |
| • Default Settings                                |                         | No | Yes |      |
| • Hidden Pattern Print Setting                    | All Invalid             | No | Yes |      |
| - COPY  | Disabled                | No | Yes |      |
| - Document Filing                                 | Disabled                | No | Yes |      |
| • Exposure  | Standard                | No | Yes |      |
| • Size  | 48 points               | No | Yes |      |
| • Angle   | 0°                      | No | Yes |      |



| Setup Items                          | Factory default setting | U  | A   | Page  |
|--------------------------------------|-------------------------|----|-----|-------|
| • Font Style                         | Standard                | No | Yes | 7-99  |
| • Camouflage Pattern                 | Pattern 1               | No | Yes |       |
| • Print Method                       | Positive                | No | Yes |       |
| • Print Contents Setting             |                         | No | Yes |       |
| • Pre-Set Word                       | Enabled, DO NOT COPY    | No | Yes |       |
| • Pre-Set                            | Disabled                | No | Yes |       |
| • Unit Serial Number                 | Disabled                | No | Yes |       |
| • Account Job ID                     | Disabled                | No | Yes |       |
| • Login Name/User Number             | Disabled                | No | Yes |       |
| • Control No.                        | Disabled                | No | Yes |       |
| • Date/Time                          | Disabled                | No | Yes |       |
| • Disable Direct Entry               | Disabled                | No | Yes |       |
| ◆ Contrast                           |                         | No | Yes |       |
| - Black                              | 5                       | No | Yes |       |
| - Magenta                            | 5                       | No | Yes |       |
| - Cyan                               | 5                       | No | Yes |       |
| ◆ Custom Text Registration           | –                       | No | Yes |       |
| ► Tracking Information Print         | –                       | No | Yes | 7-100 |
| ◆ Tracking Information Print Setting | Disabled                | No | Yes |       |
| ◆ Print Information                  |                         | No | Yes |       |
| • Unit Serial Number                 | Enabled                 | No | Yes |       |
| • Text                               | Disabled                | No | Yes |       |
| • Account Job ID                     | Enabled                 | No | Yes |       |
| • Login Name/User Number             | Enabled                 | No | Yes |       |
| • Date/Time                          | Enabled                 | No | Yes |       |
| ◆ Print Position                     |                         | No | Yes |       |
| • Vertical position                  |                         | No | Yes |       |
| - Print Upper Side of Paper          | Disabled                | No | Yes |       |
| - Print Lower Side of Paper          | Enabled                 | No | Yes |       |
| • Horizontal position                |                         | No | Yes |       |
| - Print Left Side of Paper           | Enabled                 | No | Yes |       |
| - Print Right Side of Paper          | Disabled                | No | Yes |       |
| • Position Adjustment                | 1(Outer)                | No | Yes |       |
| ◆ Font Size                          | Middle                  | No | Yes |       |



| Setup Items                                    | Factory default setting | U  | A   | Page  |
|--|-------------------------|----|-----|-------|
| ◆ Select the Job to Print                      |                         | No | Yes | 7-100 |
| • Copy   | Enabled                 | No | Yes |       |
| • Print  | Enabled                 | No | Yes |       |
| • Prints(Doc.Filing)                           | Enabled                 | No | Yes |       |
| • List Prints                                  | Enabled                 | No | Yes |       |
| ▶ Initialize Private Data/Data in Machine*1    | –                       | No | Yes |       |
| ▶ Security code input*1                        | –                       | No | Yes |       |
| ▶ Audit Log                                    |                         | No | Yes |       |
| ◆ Security Control                             |                         | No | Yes |       |
| • Audit Log                                    | Disabled                | No | Yes |       |
| ◆ Storage/Send Settings                        |                         | No | Yes |       |
| • Store Setting                                |                         | No | Yes |       |
| - Stored to Storage                            | Enabled                 | No | Yes |       |
| • Send Settings                                |                         | No | Yes |       |
| - Server Send                                  | Disabled                | No | Yes |       |
| - Hostname or IP Address (Required)            | –                       | No | Yes |       |
| - Enable SSL                                   | Off                     | No | Yes |       |
| - Port Number                                  | 514                     | No | Yes |       |
| - Port Number (Use SSL)                        | 6514                    | No | Yes |       |
| ◆ Save/Delete Audit Log                        |                         | No | Yes |       |
| • Save Audit Log*2                             | –                       | No | Yes |       |
| • Delete Audit Log                             | –                       | No | Yes |       |
| ▶ Certificate Management                       |                         | No | Yes | 7-103 |
| ◆ Device Certificate Management                | –                       | No | Yes | 7-103 |
| ◆ Certificate Signing Request (CSR) Management | –                       | No | Yes | 7-103 |
| ◆ CA Certificate Management                    | –                       | No | Yes | 7-104 |

\*1 This setting is configured in setting mode on the machine.

\*2 This setting is configured in setting mode on the web page.



## Energy Save

U: General user; A: System administrator/Administrator

| Setup Items  | Factory default setting | U  | A   | Page |
|--|-------------------------|----|-----|------|
| ● Energy Save  |                         |    |     |      |
| ▶ Eco Setting  |                         | No | Yes | 1-21 |
| ◆ Eco Recommendation Function Display  | Disabled                | No | Yes |      |
| ◆ Display Message When Extending Transition Time to Preheat/Auto Power Shut-Off Mode | Disabled                | No | Yes |      |
| ◆ Mode Setting   | Custom                  | No | Yes |      |
| ◆ Preheat Mode Setting   | 1min.                   | No | Yes |      |
| • Turn off Panel Display during pre-heat mode  | Enabled                 | No | Yes |      |
| ◆ As soon as the remote job is finished, enter Auto power shut off mode.             | Enabled                 | No | Yes |      |
| ◆ Fix transition time.   | Enabled                 | No | Yes |      |
| • Auto Power Shut-Off Timer  | 1min.                   | No | Yes |      |
| ◆ Change transition time by time of day.   | Disabled                | No | Yes |      |
| ◆ Sleep Mode Power Level   | Low Power               | No | Yes |      |
| ▶ Eco Scan Setting   |                         | No | Yes |      |
| ◆ Eco Scan Setting   | Enabled                 | No | Yes |      |
| ◆ Home Screen  | Disabled                | No | Yes |      |
| ◆ Copy   | Disabled                | No | Yes |      |
| ◆ Image Send   | All Enabled             | No | Yes |      |
| ◆ Document Filing  | All Enabled             | No | Yes |      |
| ◆ System Settings  | Enabled                 | No | Yes |      |
| ◆ Sharp OSA  | All Enabled             | No | Yes |      |
| ▶ Energy Saving Pattern List   |                         | No | Yes |      |
| ◆ Automatic Update Pattern   | –                       | No | Yes |      |
| ◆ Original Eco Pattern   | –                       | No | Yes |      |
| ▶ Specific Date Operation Settings   | –                       | No | Yes |      |
| ▶ Power ON/OFF Schedule Setting  | –                       | No | Yes |      |
| ▶ Toner Save Mode  | All Invalid             | No | Yes |      |



## System Control

U: General user; A: System administrator/Administrator

| Setup Items                                 | Factory default setting | U  | A   | Page  |
|---|-------------------------|----|-----|-------|
| ● System Control                            |                         |    |     |       |
| ▶ Job Log                                   |                         | No | Yes | 7-105 |
| ◆ Job Log Operation                         | –                       | No | Yes |       |
| • Job Log                                   | –                       | No | Yes |       |
| • Save Job Log                              |                         | No | Yes |       |
| - The Number of Job Log to Notify by E-mail | 50000                   | No | Yes |       |
| • Delete Job Log                            | –                       | No | Yes |       |
| • View Job Log                              | –                       | No | Yes |       |
| ▶ Data Import/Export (CSV Format)           | –                       | No | Yes |       |
| ▶ Storage Backup                            | –                       | No | Yes |       |
| ▶ Device Cloning                            | –                       | No | Yes |       |
| ▶ Address Book Forward*                     | –                       | No | Yes |       |
| ▶ Filing Data Backup                        | –                       | No | Yes |       |
| ▶ Storing/Calling of System Settings        |                         | No | Yes | 7-107 |
| ◆ Store Current Configuration               | –                       | No | Yes |       |
| ◆ Restore Configuration                     | –                       | No | Yes |       |
| ▶ Reset Settings                            |                         | No | Yes |       |
| ◆ Restore Factory Defaults                  | –                       | No | Yes |       |
| ◆ Reset the NIC                             | –                       | No | Yes |       |
| ▶ Optimization of a Local Drive*            |                         | No | Yes |       |
| ◆ Optimization of a Local Drive             | –                       | No | Yes |       |
| ▶ E-mail Alert and Status                   |                         | No | Yes | 7-108 |
| ◆ Status Message                            | –                       | No | Yes |       |
| ◆ Alerts Message                            | –                       | No | Yes |       |
| ◆ SMTP Settings                             | –                       | No | Yes |       |

\* This setting is configured in setting mode on the machine.



## Image Quality Adjustment

U: General user; A: System administrator/Administrator

| Setup Items   | Factory default setting                           | U  | A   | Page  |
|---|---|----|-----|-------|
| ● Image Quality Adjustment                                |   |    |     |       |
| ▶ Collective Adjustment                                   |   | No | Yes | 7-110 |
| ◆ Fusing Cleaning Mode*1                                  | –   | No | Yes |       |
| ◆ MC Cleaning Mode*1                                      | –   | No | Yes |       |
| ◆ Black Letter/Black Line Width Adjustment                | 0   | No | Yes |       |
| ◆ Black Streak Reduction                                  | Disabled  | No | Yes |       |
| ▶ Copy Image Quality                                      |   | No | Yes | 7-111 |
| ◆ Quick Image Quality Adjustment                          | 2   | No | Yes |       |
| ◆ Density Adjustment when [Auto] is selected for Exposure | Document Glass,<br>Document Feeder: 5<br>(Normal) | No | Yes |       |
| ◆ Sharpness   | 2   | No | Yes |       |
| ◆ Image Quality Priority                                  |   | No | Yes |       |
| • Auto  | 0   | No | Yes |       |
| • Text/Prtd.Photo   | 0   | No | Yes |       |
| ▶ Print Image Quality                                     |   | No | Yes | 7-112 |
| ◆ Quick Image Quality Adjustment                          |   | No | Yes |       |
| ◆ Exposure Adjustment                                     |   | No | Yes |       |
| ◆ Line Thickness  | 5   | No | Yes |       |
| ▶ Scan Image Quality                                      |   | No | Yes | 7-112 |
| ◆ RGB Adjust  | All 0   | No | Yes |       |
| ◆ Sharpness   | 3 (Normal)  | No | Yes |       |
| ◆ Contrast  | 3 (Normal)  | No | Yes | 7-113 |
| ▶ Common Functions*1                                      | –   | No | Yes |       |
| ◆ Auto Gray Calibration (for Copy)                        | –   | No | Yes |       |
| ◆ Auto Gray Calibration (for Print)                       | –   | No | Yes |       |

\*1 This setting is configured in setting mode on the machine.

\*2 This setting is configured in setting mode on the web page.



## Initial Installation Settings

U: General user; A: System administrator/Administrator

| Setup Items  | Factory default setting | U  | A   | Page  |
|--|-------------------------|----|-----|-------|
| ● Initial Installation Settings  |                         |    |     |       |
| ▶ Condition Settings   |                         | No | Yes | 7-114 |
| ◆ Name   | –                       | No | Yes |       |
| ◆ Machine Code   | –                       | No | Yes |       |
| ◆ Machine Location   | –                       | No | Yes |       |
| ◆ Memo   | –                       | No | Yes |       |
| ◆ Clock Adjust   |                         | No | Yes |       |
| ◆ Current Date   | –                       | No | Yes |       |
| ◆ Specify Time Zone  | –                       | No | Yes |       |
| ◆ Date&Time Settings   | –                       | No | Yes |       |
| ◆ Synchronize with Internet Time Server  | Disabled                | No | Yes |       |
| ◆ Daylight Saving Time Setting   | –                       | No | Yes |       |
| ◆ Preheat Mode Setting   | 1min.                   | No | Yes |       |
| • Turn off Panel Display during pre-heat mode  | Enabled                 | No | Yes |       |
| ◆ Fix transition time.   | Enabled                 | No | Yes |       |
| • Auto Power Shut-Off Timer  | 1min.                   | No | Yes |       |
| ◆ Display Message When Extending Transition Time to Preheat/Auto Power Shut-Off Mode | Disabled                | No | Yes |       |
| ◆ Sleep Mode Power Level   | Low Power               | No | Yes |       |
| ▶ Network Quick Settings   | –                       | No | Yes |       |
| ▶ Paper Tray Settings  | –                       | No | Yes |       |
| ▶ Product Key  | –                       | No | Yes |       |
| ▶ Application Number Input   | –                       | No | Yes |       |



# STATUS

## Status

### Machine Identification

The Machine Identification displays the system information of the machine. It displays the model name, current status, and machine location.

| Item               | Description   |
|--------------------|---|
| [Update] key       | Updates the information displayed.  |
| Unit Serial Number | Indicates the serial number of the machine.   |
| Name               | If [Name] is not set, [Not Set] appears.<br>When you tap the [Not Set] key, the [Machine Identification] screen appears.  |
| Model Name         | Displays the standard model name of the machine.  |
| Machine Location   | The information entered in the [Machine Location] item in [Machine Identification] appears.<br>If no name has been set, [Not Set] appears.  |
| Current Status     | Displays the current status of the machine.<br>If two or more errors occur at the same time, only one status is displayed according to the priority order.<br>The errors and machine conditions are displayed in the following priority order. <ul style="list-style-type: none"> <li>• Printer Error</li> <li>• Account Limit</li> <li>• Incorrect Paper</li> <li>• Overdue service maintenance</li> <li>• Paper jammed</li> <li>• Marker supply missing</li> <li>• No toner</li> <li>• Replace waste toner box.</li> <li>• Cover open</li> <li>• The paper is not available.</li> <li>• Input tray empty</li> <li>• Specified input tray missing</li> <li>• Specified output tray full</li> <li>• Offline</li> <li>• Printer Warning</li> <li>• Toner low</li> <li>• Paper low</li> <li>• Input tray missing</li> <li>• Output Tray Full</li> <li>• Output tray near full</li> <li>• Near to overdue service maintenance</li> <li>• Ready</li> <li>• Auto power shut-off</li> <li>• Warming Up</li> <li>• Busy</li> </ul> |
| Memo               | Displays text that the administrator entered.<br>If you have logged in as an administrator, you can enter a memo.<br>If no name has been set, [Not Set] appears.<br>When you tap the [Not Set] key, the Machine Identification screen appears.  |





| Item                            | Description  |
|---------------------------------|--|
| Supply Status                   | Displays the current status of supplies.                                     |
|                                 | If staples are installed, their status is displayed.                         |
| Paper Input Tray Status         | Displays the current status of the paper trays installed in the machine.     |
| [Reboot the MFP] key            | Displays the restart screen.<br>(Administrator rights are required.)         |
| [Enter the Power Save Mode] key | Displays the power save mode screen.<br>(Administrator rights are required.) |

## Total Count

This function shows the page count in each mode.



- Pages printed directly from the machine such as list prints are included in the "Other Prints" count.
- The items displayed (or printed) will vary depending on the machine specifications and peripheral devices installed.
- Before printing the number of pages used, select "Settings (administrator)" → [Status] → [Data List] → [List for Administrator].
- In All Sending Address List, the following items are handled by 2-sided printing on an item basis.
  - Individual List
  - Group List
- When "Restrict Total Count display" is set, only administrators can confirm this.

## Device Status

This screen shows the device status.

| Item                    | Description  |
|-------------------------|--|
| [Update] button         | Updates the information displayed.                                       |
| Paper Input Tray Status | Displays the current status of the paper trays installed in the machine. |
| Output Tray Status      | Displays the current status of the output tray installed in the machine. |
| Supply Status           | Displays the current status of supplies.                                 |
|                         | If staples are installed, their status is displayed.                     |
| Device Configuration    | Displays the information of options installed in the machine.            |
| Local Drive Status      | Displays the usage status of the local drive.                            |



## Network Status

The Network Status screen shows the general status information and the statuses relevant to, TCP/IP and DNS protocols.

The information displayed here consists of the items that are configured in the Network Settings and their settings. For information on each item, refer to "[Network Settings \(page 7-78\)](#)".

## Firmware Version

Shows the firmware version of the machine as a list.

## Power Reset

The Power Reset screen enables you to restart the machine or enter the power save mode.



This function requires administrator rights.

| Item                      | Description  |
|---------------------------|--|
| Reboot the MFP            | Reboots the machine.<br>Tapping the [Execute] key opens the Restart screen, and then tapping the [Execute] key again restarts the machine. |
| Enter the Power Save Mode | Shifts the machine to power save mode.<br>Tap the [Execute] key to open the power save mode screen.  |



## Data List

Lists showing the settings and information registered in the machine can be printed.



The two-sided or one-sided list printing setting is determined by Operation Settings - Data List - 1-Sided/2-Sided.

## List for User

| List name                   | Description   |
|-----------------------------|---|
| Machine Status List         | This list shows information needed by regular users, such as hardware statuses, software statuses, printer environment settings, and paper tray settings.   |
| Printer Test Page           | This is used to print the PCL Symbol Set List, various font lists, and the NIC page (network interface settings, etc.). <ul style="list-style-type: none"> <li>• PCL Symbol Set List</li> <li>• PCL Internal Font List</li> <li>• PCL Extended Font List</li> <li>• PS Font List</li> <li>• NIC Page</li> </ul> |
| Sending Address List        | Lists can be printed of various addresses stored in the machine. <ul style="list-style-type: none"> <li>• Individual List</li> <li>• Group List</li> </ul>  |
| Document Filing Folder List | This shows the folder names for document filing.  |



### Prohibit Test Page

When "Prohibit Test Page Printing" is enabled, Printer Test Page cannot be used to print test pages.

In "Settings (administrator)", select [System Settings] → [Printer Settings] → [Condition Settings] → [Prohibit Test Page Printing].



## List for Administrator

You can print out the lists and reports that only the administrator can refer to.

- Home Screen List
- Copy Settings List
- Printer Settings List
- Image Send Settings
  - Metadata Set List
  - Common Settings List
  - Scan Settings List
- Document Filing Settings List\*
- Sharp OSA Settings List
- Authentication Settings List

### Common

Lists of the administrator settings for the following modes can be printed.

- Paper Settings List
- Machine Identification Settings List
- Operation Settings List
- Keyboard Settings List
- Device Control List

### Network Settings

- Network Settings List

### Security Settings

- Security Settings List

### Energy Save Setting

- Energy Save List

### Image Quality Adjustment

- Image Quality Adjustment List

### Image Sending Activity Report

The following Image Sending Activity Reports can each be separately printed.

- Image Sending Activity Report (Scan)

### Data Receive/Forward List

The following lists showing reception settings and forwarding settings can be printed.

- Document Admin List

\* This can be used when the corresponding peripheral device is installed.





## Initial Status Settings

If you print data in an environment where the printer driver is not used (that is, if you print data using the MS-DOS system or if you print data using the PC that does not have the provided printer driver installed), set the detailed printing conditions. (However, the "Disable Blank Page Print" function will be effective even when the PCL printer driver is used.)

### Settings

| Setup Items                   | Description   |
|-------------------------------|---|
| Copies                        | 1 - 9999 sets   |
| Orientation                   | <ul style="list-style-type: none"> <li>• Portrait</li> <li>• Landscape</li> </ul>   |
| Paper Size                    | Set the default paper size.   |
| Output Tray                   | Set the default delivery tray.  |
| Paper Type                    | Set the default paper type.   |
| Resolution Setting            | <ul style="list-style-type: none"> <li>• 600dpi</li> <li>• 600dpi (High Quality)</li> <li>• 1200dpi</li> </ul>  |
| Disable Blank Page Print      | <ul style="list-style-type: none"> <li>• <input checked="" type="checkbox"/> (Enabled)</li> <li>• <input type="checkbox"/> (Disabled)</li> </ul>  |
| 2-Sided Print                 | <ul style="list-style-type: none"> <li>• 1-Sided</li> <li>• 2-Sided(Book)</li> <li>• 2-Sided(Tablet)</li> </ul>   |
| N-Up Print* <sup>1</sup>      | <ul style="list-style-type: none"> <li>• 1-Up</li> <li>• 2-Up</li> <li>• 4-Up</li> <li>• 8-Up</li> </ul>  |
|                               | Layout <ul style="list-style-type: none"> <li>• Left to Right*<sup>2</sup></li> <li>• Right to Left*<sup>2</sup></li> <li>• Right, and Down*<sup>3</sup></li> <li>• Down, and Right*<sup>3</sup></li> <li>• Left, and Down*<sup>3</sup></li> <li>• Down, and Left*<sup>3</sup></li> </ul> |
| Fit To Page* <sup>4</sup>     | <ul style="list-style-type: none"> <li>• <input checked="" type="checkbox"/> (Use Fit to Page)</li> <li>• <input type="checkbox"/> (Do not use Fit to Page)</li> </ul>  |
| Output                        | <ul style="list-style-type: none"> <li>• <input checked="" type="checkbox"/> (Use Print per Unit)</li> <li>• <input type="checkbox"/> (Do not use Print per Unit)</li> </ul>  |
| Separator Page                | <ul style="list-style-type: none"> <li>• <input type="checkbox"/> Insert Before Job      Paper Tray</li> <li>• <input type="checkbox"/> Insert After Job      Paper Tray</li> </ul>   |
| Staple Position* <sup>5</sup> | <ul style="list-style-type: none"> <li>• None, 1 Staple at Back, 2 Staples, 2 Staples (Top)</li> </ul>  |
| Punch* <sup>6</sup>           | <ul style="list-style-type: none"> <li>• <input type="checkbox"/> (Use Punch)</li> <li>• <input checked="" type="checkbox"/> (Do not use Punch)</li> </ul>  |



| Setup Items               | Description   |
|---------------------------|---|
| Fold*7, *8                | <ul style="list-style-type: none"> <li><input checked="" type="checkbox"/> Enabled</li> <li><input type="checkbox"/> Disabled</li> </ul>                                  |
|                           | <ul style="list-style-type: none"> <li>Saddle Fold*7</li> <li>Z-Fold*8</li> <li>C-Fold*8</li> <li>Accordion Fold*8</li> <li>Double Fold*8</li> <li>Half Fold*8</li> </ul> |
| Trimming Width Settings*9 | 2.0 to 20.0 mm  |
| Quick File                | <ul style="list-style-type: none"> <li><input type="checkbox"/> (Disabled)</li> <li><input checked="" type="checkbox"/> (Enabled)</li> </ul>                              |

\*1 Paper sizes that can be used with this function are 11" x 17", 8-1/2" x 14", 8-1/2" x 11", A3, B4, and A4. (This function may not take effect with some print methods.)

\*2 Can be selected when 2-Up is selected.

\*3 Can be selected when 4-Up/8-Up is selected.

\*4 Only effective when printing PDF, JPEG, and TIFF files.

\*5 When an finisher (large stacker)/saddle stitch finisher (large stacker) is installed

\*6 When a punch module is installed.

\*7 When a saddle stitch finisher (large stacker) is installed

\*8 When a folding unit is installed.

\*9 When a trimming module is installed.

## PCL Settings

This is used to set the symbol sets, fonts, and line feed code used in a PCL environment.

### Settings

| Setup Items            | Settings   | Setting  |
|------------------------|--|--|
| PCL Symbol Set Setting | Specify the symbol set used for printing.  | <ul style="list-style-type: none"> <li>Select from 35 items.</li> </ul>  |
| PCL Font Setting       | Select a font used for printing.   | <ul style="list-style-type: none"> <li>Internal Font</li> <li>Extended Font</li> <li>(List of internal fonts when extended fonts are not installed.)</li> </ul>                        |
| PCL Line Feed Code     | This setting is used to select how the printer responds when a line feed command is received.  | <ul style="list-style-type: none"> <li>0.CR=CR; LF=LF; FF=FF</li> <li>1.CR=CR+LF; LF=LF; FF=FF</li> <li>2.CR=CR; LF=CR+LF; FF=CR+FF</li> <li>3.CR=CR+LF; LF=CR+LF; FF=CR+FF</li> </ul> |
| Wide A4                | When this is enabled, 80 characters per line are printed on the 8-1/2" x 11" (A4) size paper using a 10-pitch font. (When this setting is disabled, up to 78 characters are printed per line.) | <ul style="list-style-type: none"> <li>(Enabled) <input checked="" type="checkbox"/></li> <li>(Disabled) <input type="checkbox"/></li> </ul>   |



## PostScript Settings

When an error occurs during PostScript printing, these settings determine whether or not an error notice is printed and whether or not the PostScript data is received in binary format. This can only be enabled when the PS3 expansion kit is installed.

| Setup Items       | Settings   | Setting  |
|-------------------|--|--|
| Screen Settings   | Configure image settings for PostScript.   | Standard, Text/Photo, Text, Photo, Dot (High Line Number), Dot (Low Line Number)     |
| Print PS Errors   | When a PS (PostScript) error occurs during PostScript printing, this setting determines whether or not an error notice is printed. | (Enabled) <input checked="" type="checkbox"/><br>(Disabled) <input type="checkbox"/> |
| Binary Processing | Configure image settings for PostScript.   | (Enabled) <input checked="" type="checkbox"/><br>(Disabled) <input type="checkbox"/> |

## OOXML Settings

To print an Excel file by direct print, select a sheet (with the part to be printed selected) or the entire book. The Direct print expansion kit is required.

## Print Release Settings

Select this option to use the E-mail printing. For detailed information, see "Print Release Guide".





## E-mail Print Settings

Select this option to use the E-mail printing.

### E-mail Print

Set whether or not E-mail print is performed.

### POP3 Server

Set the POP3 server used for E-mail.

### Port Number

Set the port number of the E-mail server.

### POP Authentication

Set this to perform POP authentication for E-mail.

### User Name

Set the E-mail user name.

### Password

Set the password used for E-mail.

### Check Interval

Set the automatic e-mail check frequency (polling interval).

### Enable SSL

Use when SSL is used.

## Direct Print Settings (FTP)

Configure these settings if you will be printing files on an FTP server by direct print.

A list of available FTP servers is shown. To add an FTP server, click the [Add] button and configure the settings.

## FTP Server Registration

Configure FTP server settings.

### Name

Set the name to be used for direct print.

### FTP Server

Set the name of the FTP server.

### Directory

Set the directory of the FTP server that has the files.

### User Name

Set the user name used to log in to the FTP server.

### Password

Set the password used to log in to the FTP server.

### Enable SSL

Set to enable SSL.

### Use PASV mode

Set to use PASV mode.



## Direct Print Settings (Network Folder)

Configure these settings if you will be printing files on a network folder by direct print.

A list of available network folders is shown. To add a network folder, click the [Add] button and configure the settings.

### Registration of Network Folder

Configure network folder settings.

#### **Name**

Set the name to be used for direct print.

#### **Folder Path**

Set the folder path that has the files.

#### **User Name**

Set the user name used to log in to the network folder.

#### **Password**

Set the password used to log in to the network folder.

## Print Setting from PC/Mobile Terminal

Configure these settings to print files on a computer or mobile terminal by direct print.

### **FTP Print**

Specify whether or not FTP print settings are used for direct print.

### **Port Number**

Enter the port number used for direct print.



# Image Send Settings

## Scan Settings

### Default Address

#### Default Address Setting

A default address can be stored that makes it possible to transmit by simply pressing the [Color Start] key or the [B/W Start] key without specifying an address. If [Apply E-mail address of the user for login.] is selected, the E-mail address of the login user is set as the default destination. When [Apply Home Directory of The User for Login] is selected, the default address is the home directory of the user that logged in.

When the user logs in by internal authentication (authentication by the machine), the home directory setting of the user that logged in is configured in "User Registration" in "User List" in "User Control". When the user logs in by external authentication (network authentication), the home directory setting is configured in "Global Address Book Settings" in "LDAP Settings" in "Network Settings".



Only a single default address can be set for Scan to E-mail, Scan to FTP, Scan to Desktop, and Scan to Network Folder.

### Add Selected

Select an address that is to be used by default.

#### Apply E-mail address of the user for login.

The E-mail address of the login user is set as the default address.

Select [Allow cancel of the first entered address] based on your intended use.

#### Apply Home Directory of The User for Login

The home directory of the login user is set as the default address.

Select [Allow cancel of the first entered address] based on your intended use.

#### Allow cancel of the first entered address

You can cancel the E-mail address of the login user that is entered automatically. To cancel, tap the [x] button next to the address entry field.

When this setting is disabled, selection of an address other than the entered default address is prohibited.



If an e-mail address is not set for the logged-in user, scanner transmission cannot be used.

### Select From Address Book

- To display your desired address book, narrow the search by alphabet or category with the list of [Index]. You can select the number of addresses that are to be displayed at a time with [Display Items].
- When you select the desired address name and tap the [Store] key, the selected address can be selected for the default address.



## Subject Name Settings

### Default Subject

Set a maximum of 80 full-width/half-width characters for the default subject for E-mail transmission.

### Pre-Set Registration

You can save a preset file name for transmitted files. Click the [Add] key and set a maximum of 80 full-width/half-width characters for the file name.

## File Name Settings

### Default Subject

#### File Naming

You can select the information included in the name of scanned files.

##### Unit Serial Number

You can add the machine's serial number to the file name.

##### Text

You can add any text to the file name. (Up to 64 characters)

##### Date & Time

You can add the date and time of transmission to the file name.

##### Session Page Counter

You can add counter information to the file name.

##### Unique Identifier

An ID number can be created for each file and added to the file name.

### Direct Entry/Pre-Set Text Selection Settings

#### Add Date & Time

You can set the file name to be sent from "Direct Entry" or "Pre-Set Text Selection". When this setting is enabled, you can add a date and time to the end of the file name.

### Pre-Set Registration

You can save a preset file name for transmitted files. Click the [Add] key and set a maximum of 80 full-width/half-width characters for the file name.

## Message Body Settings

### Add Job Information Automatically to the Mail Message Body

You can automatically add job information to the body message of e-mail.

### Add a Footer Automatically to the Mail Message Body

You can add any text as a footer to the body message of e-mail.

### Mail Footer Registration

When [Add a Footer Automatically to the Mail Message Body] is enabled, set a maximum of 900 full-width/half-width characters for the footer.

### Pre-Set Registration

You can save a preset e-mail subject and body message (fixed text). Click the [Add] key and set a maximum of 80 full-width/half-width characters for the subject, and a maximum of 1800 full-width/half-width characters for the body message (fixed text).



# Common Settings

## Paper Settings

### Paper Tray Settings

#### Paper Weight

These are used to control the toner fusing temperature according to the weight of the paper.

These settings apply to recycled paper, punched paper, pre-printed paper, letterhead paper, colored paper, and user type paper.

You can select "16 - 23 lbs." or "23+ - 28 lbs." ("60 - 89 g/m<sup>2</sup>" or "90 - 105 g/m<sup>2</sup>").



This can only be set on the machine's operation panel.

Be sure to use only paper that is in the same weight range as the weight range set here. Do not mix plain or other paper that is outside the range with the paper in the tray.

When settings are changed, the changes will take effect after the machine is restarted. To restart the machine, see "[TURNING ON THE POWER \(page 1-10\)](#)".

## Paper Settings

When [Add] is tapped in Paper Settings selection in the paper tray settings, the Paper Settings registration screen appears. By selecting advanced settings in Paper Properties for the paper to be used, you can print using the most suitable conditions for the printed mater.

A maximum of 1000 properties can be registered.



The Paper Settings can also be set from Tray Settings/Paper Settings screen. Select User Type for the paper type selection, and tap "Add/Edit Paper Settings" in the action panel.

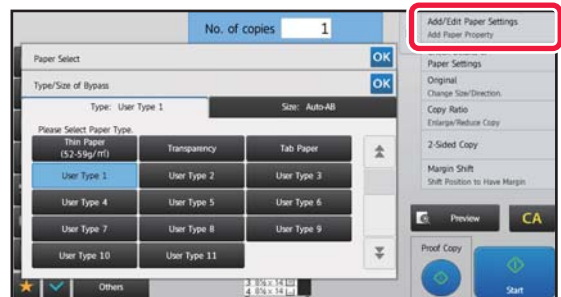
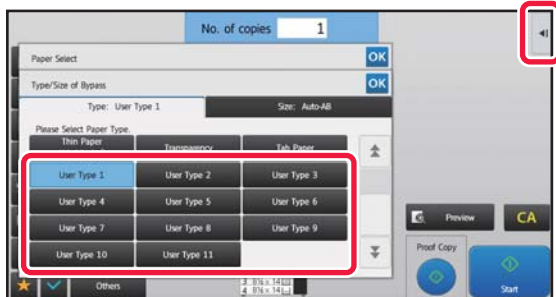



| Item                                  | Description   |
|---------------------------------------|---|
| [Default Settings] tab                |   |
| Name                                  | Enter a name for the Paper Settings (maximum of 50 half or full width characters).  |
| Search Number                         | Set a search number.  |
| Paper Weight Setting                  | Set the paper weight to be used.  |
| Paper Type                            | Set the paper type.<br>Select the paper type based on the surface finish of the paper.<br>The following types can be selected. <ul style="list-style-type: none"> <li>• Uncoated Paper</li> <li>• Coated Paper (Gloss)</li> <li>• Coated Paper (Matte)</li> </ul> |
| Paper information                     | Set when Color paper, Tab Paper, or Pre-Punched paper is used.  |
| Paper Property                        | Set the properties of the paper to be used.<br>For the properties, refer to the settings in "Paper Type Registration".  |
| [Detail] tab                          |   |
| Fusing Temperature Settings           | Set the appropriate fusing unit temperature for the paper to be used.   |
| Double Feed Detection Setting         | Specify whether double feeds are detected. This function cannot be used when paper heavier than 68 lbs. (256 g/m <sup>2</sup> ) is used.  |
| Transfer Current Value Setting        | Set the current of the transfer unit that is used to transfer toner to the transfer belt. By adjusting the current of the transfer unit, transfer problems such as insufficient transfer to the transfer belt can be improved.                                    |
| Transfer Condition Adjustment Setting | Select ON/OFF of moisture absorption compensation.  |
| Motor Speed Setting                   | You can adjust the motor speed and the speed change timing.   |
| Maximum Density Setting               | This performs the adjustment of maximum density.  |
| Side 1/2, XY Ratio Settings           | Configure settings to equalize the size of the image in duplex printing. This adjusts the size of the image on the Side 1 and Side 2 sides of the paper.  |
| Side 1/2, XY Print Position           | Configure settings to make the Side 1 and Side 2 centres match in duplex printing. This corrects Side 1 and Side 2 misalignment.  |



- Depending on the tray being used, there may be restrictions on the setting options that can be selected, or a setting may not be possible.
- The parameters that can be set vary depending on the peripheral devices that are installed.
- The Side1/2, XY Ratio Settings can only be selected when the machine is used as a printer.
- The characteristics of some paper types may not provide a suitable printing result.



### Side1/2, XY Ratio Settings / Side1/2, XY Print Position

#### Side1/2, XY Ratio Settings

The Side1/2, XY Ratio Settings are used to eliminate print deviation by changing the Side 1/Side 2 ratio so that the print sizes match.

Tap [Change] in the Side1/2, XY Ratio Settings to display the advanced settings screen of the Side1/2, XY Ratio Settings

#### (1) Print a test pattern

Before starting, print a test pattern from [Test Print] in Side1/2, XY Ratio Settings. One page of patterns for settings are printed by duplex printing.

For the measurement patterns, refer to “Measurement patterns for Side1/2, XY Ratio Settings / Side1/2, XY Print Position”.

#### (2) Calculate the values from the pattern and enter the values.

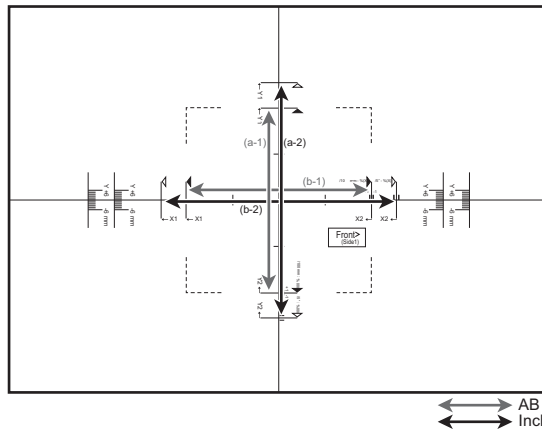

#### [AB sizes]

Measure the length of (a-1) in mm. Divide 10000 by the measured length of (a-1), and enter that value in [Y] for the Side 1. Measure the length of (b-1) in mm. Divide 10000 by the measured length of (b-1), and enter that value in [X] for the Side 1.

#### [Inch sizes]

Measure the length of (a-2) in inches. Divide 500 by the measured length of (a-2), and enter that value in [Y] for the Side 1. Measure the length of (b-2) in inches. Divide 500 by the measured length of (b-2), and enter that value in [X] for the Side 1.

| Measurement Line<br>(Measurement Marker) | Length specified by measurement line interval |
|--|---|
| Assistant Line                           | 50 mm (1.969 inch)                            |
|  | 100 mm  |
|  | 5 inch  |

#### (3) Tap [OK].

#### (4) Return to step 1 and check the result of adjustment.

If the size has deviated as a result of adjustment, repeat adjustment until the deviation is eliminated.



- If the print position has shifted due to these settings, configure the Side1/2, XY Print Position Settings.
- The Side1/2, XY Ratio Settings can only be used when the machine is used as a printer.



### Side1/2, XY Print Position Settings

The Side1/2, XY Print Position Settings are used to make the centers of the Side 1 and Side 2 print positions match to remove printing misalignment.

Tap the [Change] button in Side1/2, XY Print Position Settings to display the advanced settings screen of Side1/2, XY Print Position Settings.

#### (1) Select the units used in the Side1/2, XY Print Position Settings

Tap [mm] to select the units used for the settings.

#### (2) Print a test pattern

Before starting, print a test pattern from [Test Print] in Side 1/2, XY Print Position. One page of patterns for settings are printed by duplex printing.

For information on the measurement patterns, refer to "[Measurement patterns for Side1/2, XY Ratio Settings / Side1/2, XY Print Position Settings](#)".

#### (3) Read the scale from the patterns and enter the values.

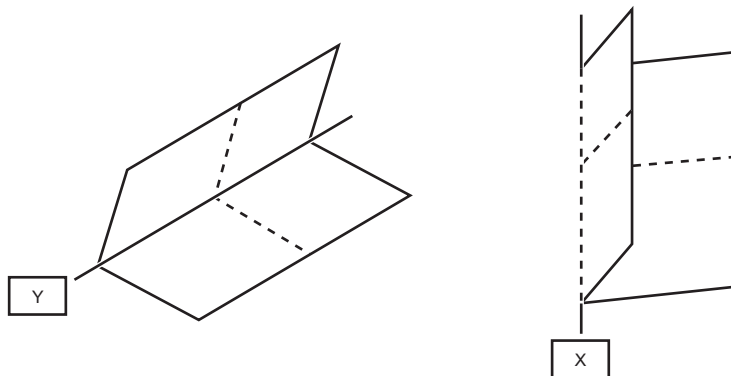

Fold the sheet in half with the center in the horizontal and vertical direction as folding lines respectively and put creases at both ends, then unfold to return.

Measure the crease position of X and Y by scale for Side1 and Side2 respectively and input the values.

If the values of both ends are different, the average value should be input.



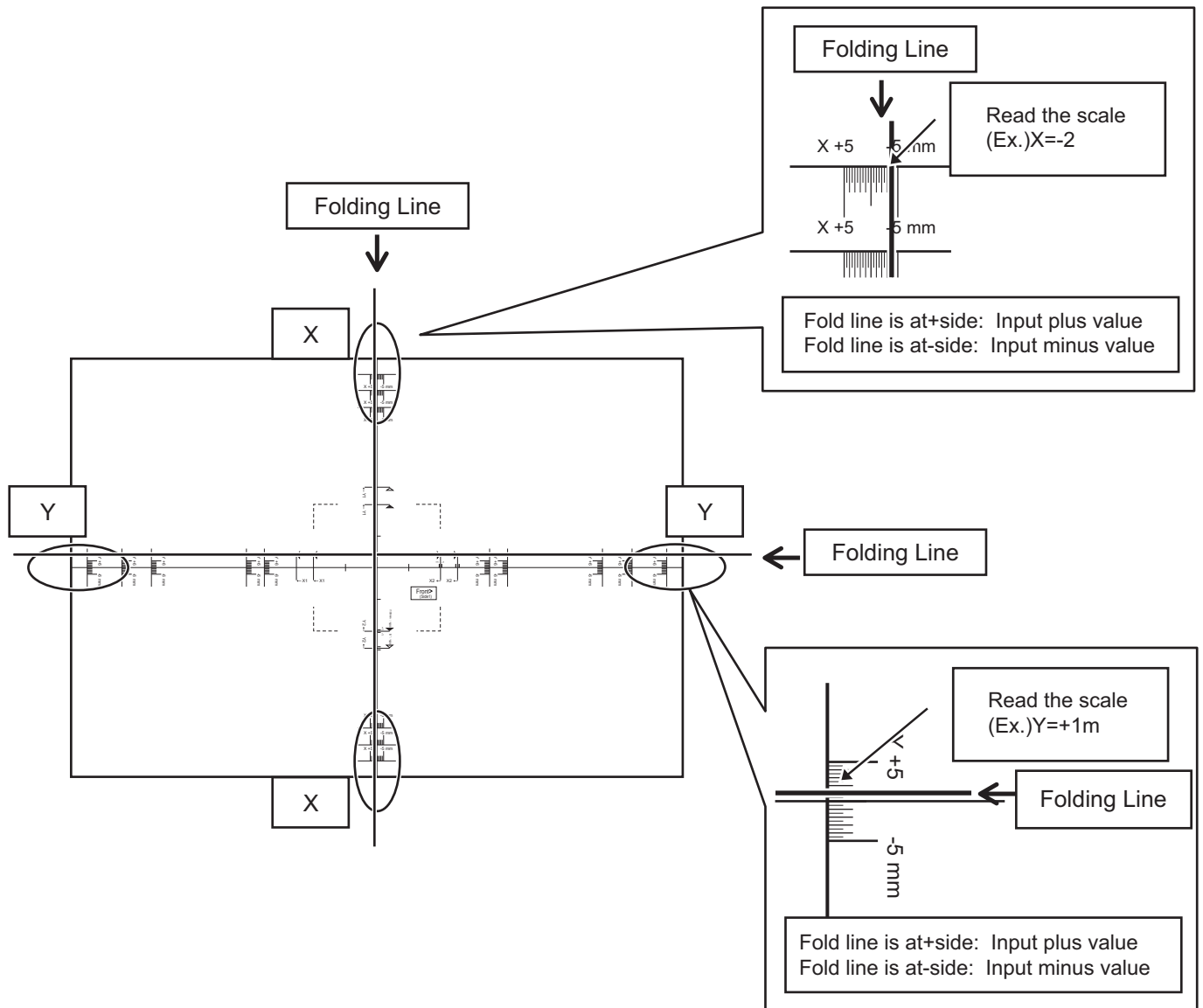

(4) Tap [OK].

(5) Return to step 2 and check the result of adjustment.

If the size has deviated as a result of adjustment, repeat adjustment until the deviation is eliminated.



- The measurement line content of the measurement pattern varies depending on the paper size. Measure from the measurement line closest to the edge of the paper.
- It may not be possible to guarantee the operation adjustment range in the Y direction of ( $\pm 3$  mm) depending on the machine settings or paper size.
- When the vertical or horizontal width is 100 mm or less, measure from the assistant line.
- If you need to use this setting together with the Side1/2, XY Ratio Settings, specify the Side1/2, XY Ratio Settings first.
- Changes in the environment of the machine, such as humidity and temperature, may cause a deviation of about 1 mm in the Side1/2, XY Print Position.



### Measurement patterns for Side1/2, XY Ratio Settings / Side1/2, XY Print Position Settings

To specify Side1/2, XY Print Position Settings and Side1/2, XY Ratio Settings, print a pattern for measurement.

#### Content of the measurement pattern

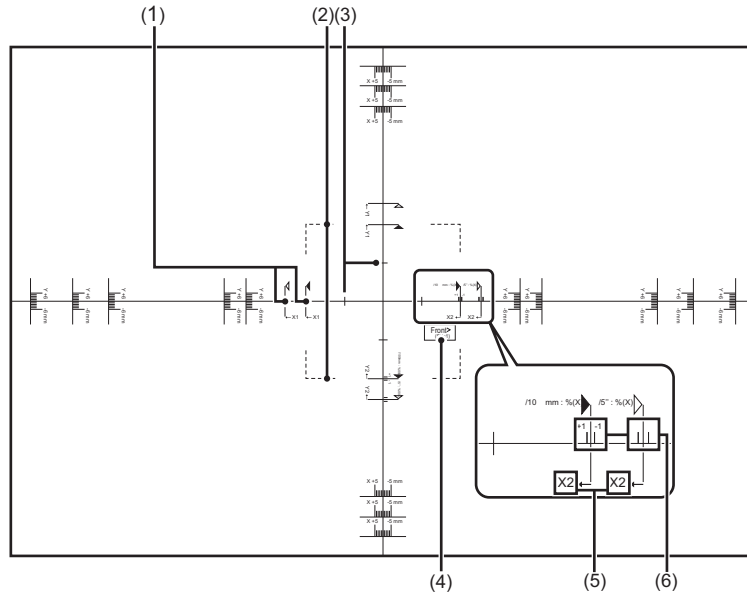

| No. | Item                           | Description  |
|-----|--------------------------------|--|
| 1   | Measurement Line               | Reference line for measurement.<br>Measurement lines for AB sizes and inch sizes have been created.  |
| 2   | Dot Line                       | This line is visible through the Side 1 and Side 2 to let you visually check for misalignment. The line is printed at the same position on the Side 1 and Side 2. If visual inspection reveals that the lines are not aligned, the print positions on the Side 1 and Side 2 are not aligned. |
| 3   | Assistant Line                 | Assistant line located 25 mm from the center of the paper.<br>When the paper size is 100 mm or less, use this line for measurement.  |
| 4   | Notes (Side 1/Side 2)          | These indicate the Side 1 and Side 2.  |
| 5   | Notes (X/Y axis)               | When entering the settings, these indicate the X and Y axes of the paper.  |
| 6   | Assistant Line (Magnification) | Indicates a position that is $\pm 1\%$ of the measured distance.   |

The same measurement pattern content is printed at the same size, regardless of the paper size. The outer perimeter of the measurement pattern is trimmed to match the paper size.



**Example: Content trimmed for an AB size**

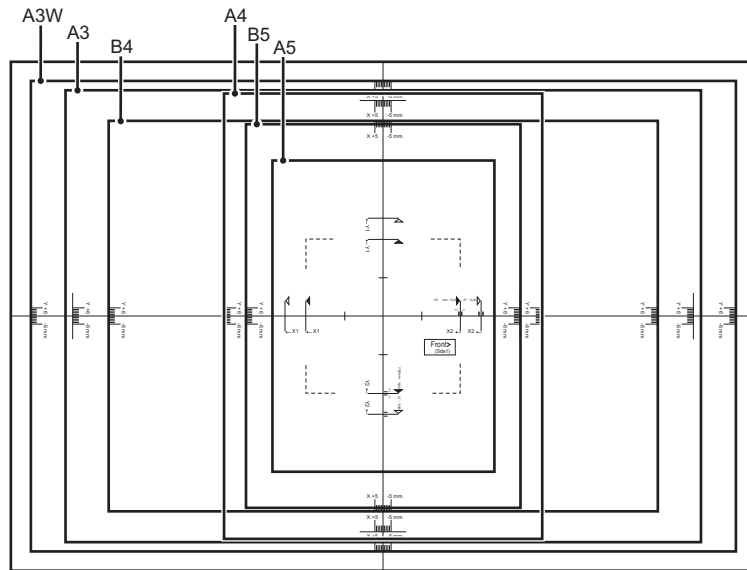

**Example: Content trimmed for an inch size**

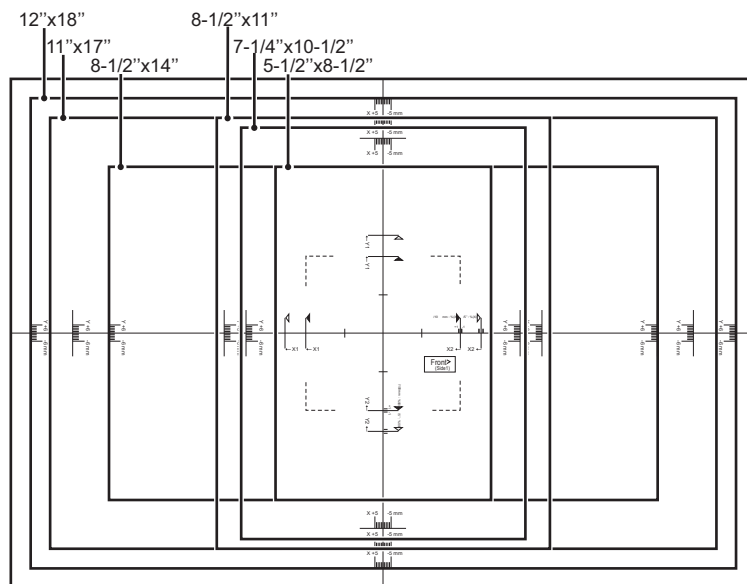



# Operation Settings

## Condition Settings

### Data List

To specify [One Sided] or [Two Sided] printing in Data List.

### Tandem Connection Setting

When two machines are used as network printers using TCP/IP protocol, use this setting to configure the port number and IP address of the machine used as the tandem client machine.

#### Disabling of Master Machine Mode

To prohibit tandem transmission, enable this setting. (Normally this setting is not necessary.)

#### Disabling of Client Machine Mode

To prohibit tandem reception, enable this setting. (Normally this setting is not necessary.)



- To use the tandem function when user authentication is enabled, the same login name and password must be used on both the master machine and client machine. If the same login name and password are not used, the page count may not be added to the appropriate user count or only the master machine may print.
- The factory default setting for the port number is [50001]. Unless you experience difficulty with this setting, do not change the port number.

## Custom Link Setting

The stored Web addresses can be displayed in the display area of the setting menu.

Click a custom link to jump to the website of the stored address.

# Device Control

Various devices mounted on the machine can be set.

## Condition Settings

### Actions When Maximum Number of Sheets that can be Stapled is Reached

Sets whether to display a message to select a remedy when the maximum number of staples has been reached.

### Saddle Fold/Stitch Position Adjust

Adjust the folding or staple position when saddle stitching.

### Paper Type for Auto Paper Selection

The paper types\* that the Auto Paper Selection function will select can be specified. Select one of the following settings:

- Plain 1
- Plain 2
- Recycled

The Auto Paper Selection function will not select any paper types other than the paper types specified with this setting.

\* The paper type set for each paper tray by selecting [System Settings] in "Settings" → [Paper Tray Settings].

### Plain Paper Compatibility Settings

If you use a printer driver that does not support plain paper 1 or 2, specify the plain paper to be used for printing with the printer driver.

The weight of Plain Paper 1 is 16 to 24 lbs bond (60 to 89 g/m<sup>2</sup>). The weight of Plain Paper 2 is 24 to 28 lbs bond (90 to 105 g/m<sup>2</sup>). Check the weight of the plain paper that you regularly use, and set accordingly.

### Detect Standard in Auto Color Mode

When the color mode is set to auto in scanner mode, the discrimination point for detecting whether originals are color or black and white can be set to one of 5 levels. When set to [Closer to B/W ], the originals are easier to recognize as black and white. When set to [Closer color], the originals are easier to recognize as color.



## Total Setting for Finish

Select the finish setting. Set whether finishing positions are specified on the specified paper or on the original.

## Disabling of Duplex

This is used to disable 2-sided printing, such as when the duplex module malfunctions.

## Disabling of Offset

Disable offset output.

## Disabling of Stapler

This setting is used to prohibit the use of staple, such as when the staple of finisher or saddle finisher malfunctions.

## Disabling of Punch

This setting is used to prohibit the use of punch, such as when the punch module of finisher or saddle finisher malfunctions.

## Disabling of Document Feeder

Use this setting to prohibit the use of the automatic document feeder, such as when the feeder malfunctions. (When the setting is enabled, scanning is still possible using the document glass.)

## Disabling of Inserter

Disables use of the inserter.

## Disabling of Folding Unit

This setting is used to disable the folding unit.



You can use the saddle folding with the saddle finisher even if the folding unit is disabled.

---

## Disabling of Trimming Module

This setting is used to disable the trimming module.

## Disabling of Large Capacity Cassette

This setting is used to disable the large capacity cassette, such as when it malfunctions.

## Disabling of Optional Paper Drawer

This setting is used to disable the optional paper drawer, such as when it malfunctions.

## Disabling of Tray Settings

This setting is used to prohibit tray settings (except for the bypass tray).

## Disabling of Bypass-Tray

This setting is used to prohibit the use of bypass tray, such as when it malfunctions.

## Disabling of Finisher

This setting is used to prohibit the use of finisher or saddle finisher, such as when it malfunctions.

## Status Indicator Setting

## Data Indicator Setting



## Error Light Setting

The status indicator on the back of the machine lights up or blinks according to the status of the machine.

You can change this setting to specify the machine status that causes the green indicator (status indicator) to light up or blink. The indicator goes off when Auto Power Shut-Off is enabled.

Green indicator (Status indicator) : You can specify which job status and original scanning status respectively cause the indicator to light up and blink.

Red indicator (Error indicator) : This indicator lights up or blinks when an error occurs on the machine.

Red indicator (Error indicator) lights up and blinks the same way regardless of the pattern you select.

| Status                             |   | Pattern 1       | Pattern 2       | Pattern 3       |
|------------------------------------|---|-----------------|-----------------|-----------------|
| Green indicator (Status indicator) | Job in progress, such as paper feeding or output.                       | Green: Light up | -               | -               |
|                                    | Ready state or other state where jobs can be accepted.                  | -               | Green: Light up | -               |
|                                    | An original has been placed in the document feeder.                     | -               | -               | Green: Light up |
|                                    | The machine is in a status other than the above.                        | Green: Off      | Green: Off      | Green: Off      |
| Red indicator (Error indicator)    | Errors that do not stop machine operation, such as almost out of toner. | Red: Light up   | Red: Light up   | Red: Light up   |
|                                    | Errors that stop machine operation, such as misfeeds and out of toner.  | Red: Blink      | Red: Blink      | Red: Blink      |
|                                    | The machine is in a status other than the above.                        | Red: Off        | Red: Off        | Red: Off        |

### Use Original Detection Light for Document Feeder

Specify whether to use the original setting indicator on the automatic document feeder.

### Use Preventive Light to Indicate Original Left Behind

Specify whether to use the preventive light to indicate original left behind on the automatic document feeder.



## Machine Identification Settings

Enter a name or code to identify the machine.

## Clock Adjust

Use this to set the date and time in the machine's built-in clock.

| Item                                  | Description   |
|---------------------------------------|---|
| Specify Time Zone                     | If your region is ahead of GMT (Greenwich Mean Time), select [+]. If your region is behind GMT, select [-]. Next, specify the time difference between your region and GMT in hours and minutes. (Example: If your region is Japan, + 9 hours 00 minutes.) |
| Date&Time Settings                    | Select and set the year, month, day, hour, and minute.  |
| Synchronize with Internet Time Server | This can be used when the machine is connected to the Internet. The machine's time is automatically adjusted to the time of an Internet time server.  |

## Daylight Saving Time Setting

Enable daylight saving time.

| Item                         | Description   |
|------------------------------|---|
| Daylight Saving Time Setting | Select whether or not the Daylight Saving Time Setting is enabled. If disabled, the following settings will not be possible.  |
| Select Setting Type          | Specify whether the starting and ending day of daylight saving time are to be set using the day of the week or the date.  |
| Start Time                   | Set the starting time of daylight saving time. If you selected "Day of the Week" in "Select Setting Type", set the starting week of daylight saving time and then the starting day. If you selected "Date" in "Select Setting Type", set the starting date. Set the hour and minute and the UTC (Coordinated Universal Time) setting. |
| End Time                     | Set the ending time of daylight saving time in the same way as you set the starting time.   |
| Adjustment Time              | Set the time to be adjusted when daylight saving time begins.   |

## Date Format

The format used to print the date on lists and other output can be changed.

| Item              | Description  |
|-------------------|--|
| Current Setting   | The current time appears in the format set in Date Format.   |
| Format            | Set the order of display of the year, month, and day (YYYY/MM/DD).   |
| Separator         | Select one of three symbols or a blank space for the separator used in the date.   |
| Day-Name Position | Select whether the day name appears before or after the date.  |
| Time Display      | Select 12-hour format or 24-hour format for the time.<br>24-Hour Display: 00:00 to 23:59<br>12-Hour Display: 00:00 AM to 11:59 AM/00:00 PM to 11:59 PM |



## Product Key/Application Number Input

You must enter the machine product key to use the following advanced functions.

**Font Kit for Barcode**

**Application Integration Module**

**Application Communication Module**

**External Account Module**

**Enhanced Compression Kit**

Enter the product key and application number of the above function.



- Depending on the activation status of the extended function of the machine, the items displayed will change.
  - For the product key to be entered, contact your dealer.
-





# Sound Settings

Configure machine notification sounds and their volume.

## Beep Sound Settings (Common)

### Keys Touch Sound

Control the key touch sound level, or turns the sound off.

### Beep of Invalid Input

Control the volume of the sound, or turn the sound off at an invalid setting, such as when a number that cannot be specified is entered.

## Reference Tone

This turns the sound on when changing the copy ratio or exposure, and the setting reaches the standard value (copy ratio 100%, exposure 3). Control the reference tone sound level, or turns the sound off.

### Copy Complete Sound

Control the copy completed notification sound level, or turns the sound off.

### Scan Complete Sound (Image Send)

Control the scanner scanning completed notification sound level, or turns the sound off.

### Powering Off Sound

Control the machine power off notification sound level, or turns the sound off.

## Caution Sound Settings

Set whether to play a notification sound when the machine is in the following status.

Paper Empty, No Original, Jam, Toner Empty (Black), Toner Empty (Color), Waste Toner Full, Output Tray Full, Stapler Empty, Maximum Number of Sheets that can be Stapled is Reached



# Network Settings

## Quick Settings

Select the minimum required settings for the machine connection to the network.

### IPv4 Settings

When using the machine on a TCP/IP (IPv4) network, use this setting to configure the IP address of the machine.

#### DHCP

Use this setting to have the IP address obtained automatically using DHCP (Dynamic Host Configuration Protocol)/BOOTP (Bootstrap Protocol). When this setting is enabled, it is not necessary to manually enter an IP address.



If DHCP/BOOTP is used, the IP address assigned to the machine may change automatically. If the IP address changes, printing will not be possible.

#### IPv4 Address

Enter the IP address of the machine.

#### Subnet Mask

Enter the IP subnet mask.

#### Default Gateway

Enter the default gateway address.

## Network Name Setting

#### Device Name

Enter a device name.

#### Domain Name

Enter the domain name.

#### Comment

Enter a comment.

## DNS Settings

#### Primary Server

Enter the IP address of primary DNS server.

#### Secondary Server

Enter the IP address of secondary DNS server.

#### Domain Name

Enter the domain name where the selected DNS server exists.



## SMTP Settings

### Primary Server

Enter the IP address or the host name of the primary SMTP server.

### Sender Name

Enter the sender name.

### Sender Address

If data transmission has failed, the undelivered e-mail may be returned from the server. Enter an e-mail address (a single address only) to receive such undelivered mails. Usually, enter the e-mail address of system administrator.

### Enable SSL

If  is selected, the SMTP-over-TLS encryption communication can be used by STARTTLS command. This requires the server to support the STARTTLS command.

To allow SSL communication, set the "Port Number" to the same port number as the normal SMTP.

### SMTP Authentication

If  is set, the SMTP server authentication is carried out.

### User Name

Enter the user name.

### Password

Enter the password.

### Change Password

To change the password, set .

### Connection Test

Tap the [Execute] button to test the connection to the SMTP server.



## LDAP Settings

### Name

Enter the address book name.

### Search Root

Enters the search defaults to search for a specific area of the LDAP directory information tree.

Example: o = ABC, ou = NY, cn = Everyone

Entries must be separated from each other by semicolons or commas.

### LDAP Server

Enter the IP address or host name of the LDAP server.

### User Name

Enter the account name for LDAP setting.

### Password

Enter the password.

### Change Password

To change the password, set .

### Authentication Type

Select the authentication server from the drop-down list.

### KDC Server

Enter the IP address or host name of the Kerberos authentication server.

### Realm

Enter the Kerberos realm.

### Enable SSL

If  is set, the SSL encryption communication is enabled.

### Connection Test

Tap the [Execute] button to test the connection to the LDAP server.

## Public Folder / NAS Setting

Set each option to [Prohibited] if the storage is not used.



When settings are changed, the changes will take effect after the machine is restarted. To restart the machine, see "[TURNING ON THE POWER \(page 1-10\)](#)".

---



## Network Name Setting

### Device Name

Enter a device name.

### Domain Name

Enter the domain name.

### Comment

Enter a comment.

## Interface Settings

Select the general network settings.  
The TCP/IP information can be set.

### IPv4 Settings

When using the machine on a TCP/IP (IPv4) network, use this setting to configure the IP address of the machine.

#### DHCP

Use this setting to have the IP address obtained automatically using DHCP (Dynamic Host Configuration Protocol) v6.  
When this setting is enabled, it is not necessary to manually enter an IP address.



If DHCP/BOOTP is used, the IP address assigned to the machine may change automatically. If the IP address changes, printing will not be possible.

#### IPv4 Address

Enter the IP address of the machine.

#### Subnet Mask

Enter the IP subnet mask.

#### Default Gateway

Enter the default gateway address.

### IPv6 Settings

When using the machine on a TCP/IP (IPv6) network, use this setting to configure the IP address of the machine.

#### IPv6

Enable this setting.



## DHCPv6

Use this setting to have the IP address obtained automatically using DHCP (Dynamic Host Configuration Protocol) v6. When this setting is enabled, it is not necessary to manually enter an IP address.

### Manual Address / Prefix Length

Enter the IP address and the prefix length (0 to 128) of the machine.

### Default Gateway

Enter the default gateway address.



- If DHCPv6 is used, the IP address assigned to the machine may change automatically. If the IP address changes, printing will not be possible.
- In an IPv6 environment, the machine can use LPD or IPP protocol.

## MTU Settings

Set the maximum data size that can be forwarded.

## Ping Command

Checks if the machine can communicate with the PC of the network.

Specify the IP address of the desired PC and tap the [Execute] key. A message indicating a response by the PC or not is displayed.

## DNS Settings

### IPv4 Settings

#### Primary Server

Enter the IP address of primary DNS server.

#### Secondary Server

Enter the IP address of secondary DNS server.

### IPv6 Settings

#### Primary Server

Enter the IP address of primary DNS server.

#### Secondary Server

Enter the IP address of secondary DNS server.

#### Timeout

Enter a timeout. The default setting is 2 seconds.

This time is used until the connection to the DNS server is established according to the standard specifications.

#### Domain Name

Enter the domain name where the selected DNS server exists.

#### DNS Update

Set this option to use the dynamic updating of DNS server.

#### Update Interval

Enter an interval to update the DNS server.



## IEEE802.1X Setting

IEEE802.1X can be used to authenticate a user to allow use of the machine.

IEEE802.1X protocol defines port-based authentication for both wired and wireless networks.

Use IEEE802.1X authentication to allow only authenticated devices to use network, and protect against network abuse by third parties.

You can enable or disable IEEE802.1X authentication with this setting. The IEEE802.1X details can be set with Setting mode (Web version). Depending on the Web page settings, connection to the machine may not be allowed, or the settings may not allow printing, scanning, or Setting mode (Web version) display. In this case, deselect this setting and change the Setting mode (Web version) settings.

### IEEE802.1X Authentication

Set whether IEEE802.1X authentication is used.

### EAP Authentication Method

Set the EAP authentication method in IEEE802.1X.

### EAP User Name

Enter a maximum of 64 full-width/half-width characters for the EAP user name used for authentication.

### Password

Enter a maximum of 64 half-width characters for the EAP password used for authentication.

### Server Authentication

Set whether server authentication is used.

### EAP Timeout

Set the EAP Timeout.

### Number of EAP Retries

Set the number of EPS re-access times when transmission fails.

### Certificate Status

Shows the status of the certificate required for transmission using IEEE802.1X. To install a certificate, click [Select].

### CA Certificate Status

Shows the status of the CA certificate required for transmission using IEEE802.1X. To install a certificate, click [Select].



# Services Settings

Configure the general network settings.

Configure the DNS, SMTP, Kerberos authentication, SNMP, mDNS, SNMP, and SMB settings.

## SMTP

### SMTP Settings

#### Primary Server

Enter the IP address or the host name of the primary SMTP server.

#### Secondary Server

Enter the IP address or the host name of the secondary SMTP server.

#### Port Number

Enter a port number. The default setting is port 25.

#### Timeout

Enter a timeout. The default setting is 20 seconds. This value is used for connection to the SMTP server and for data transmission according to the e-mail system specifications.

#### Sender Name

Enter a maximum of 20 full-width/half-width characters for the sender name.

#### Sender Address

Enter a maximum of 64 half-width characters for the sender address.

#### Enable SSL

If  the SSL is enabled, the SMTP-over-TLS encryption communication can be used by STARTTLS command.

This requires the server to support the STARTTLS command.

To allow SSL communication, set the "Port Number" to the same port number as the normal SMTP.

#### SMTP Authentication

Carries  out the SMTP server authentication.

If you use the Kerberos authentication, set the KDC server, port number, and realm on the Kerberos authentication settings page.

#### User Name

Enter the user name.

#### Password

Enter the password.

To change the password, set [Change Password] to .

#### POP before SMTP

If  is set, you are authenticated to the POP server before using the SMTP communication.

- POP3 Server: Enter the IP address or the host name of the secondary SMTP server.
- Port Number: Enter the POP3 port number for POP before SMTP communication. The default setting is port 110.
- POP Authentication: If  is set, the authentication protocol (including APOP) is used for authentication to the POP3 server.
- User Name: Enter the user name for POP before SMTP communication.
- Password: Enter the password required for POP before SMTP communication. To change the password, set [Change Password] to .
- Enable SSL: If set to , the POP over SSL communication or the POP over TLS communication by STLS command is enabled.

This requires the server to support the POP over SSL communication or the STLS command.

To allow SSL communication, set the "Port Number" to the POP over SSL communication port number.

To allow POP over TLS communication, set the "Port Number" to the same port number as for the normal POP3 communication.

#### Connection Test

Tap the [Execute] button to test the connection to the SMTP server.





## Kerberos

### Kerberos Authentication Settings

**KDC Server**

Enter the IP address or host name of the Kerberos authentication server.

**Port Number**

Enter the port number of the Kerberos authentication server. The default setting is port 88.

**Realm**

Enter the Kerberos realm.

## SNTP

### SNTP Settings

**SNTP**

Set this option to use the SNTP protocol.

**SNTP Server**

Enter the IP address or host name of the SNTP server.

**Port Number**

Enter a port number. The default setting is port 123.

**Timeout**

Enter a timeout. The default setting is 5 seconds.

**Synchronous Interval**

Enter an interval to synchronize to the SNTP server.

**Synchronize Upon Start**

To establish synchronization during machine startup, set to .

**Synchronize Now**

When tapped, the machine is synchronized with the SNTP server time.

## mDNS

### mDNS Settings

**mDNS**

Set this option to use the mDNS settings.

**Service Name**

Enter a service name.

**Domain Name**

Display the domain name.

**Highest Priority Service**

Select a service you use with the priority.

## SNMP

### SNMP v1 Settings

**SNMP v1 Settings**

Set this option to use the SNMPv1 settings.

**Access Method**

Set an access method.

**GET Community**

Enter the GET community name to fetch the device information using SNMP.

**SET Community**

Enter the SET community name required for SNMP setting.

**Change SET Community**

To change the SET community, set .



### TRAP Community

Enter the community name to be used for the SNMP TRAP sent from the device.

### TRAP Target Address

Enter the IP address of the destination computer for SNMP TRAP communication.

## SNMP v3 Settings

### SNMP v3 Settings

Set this option to use the SNMPv3 settings.

#### User Name

Enter the user name.

#### Authentication Key

Enter the authentication key.

#### Privacy Key

Enter the privacy key.

#### Context Name

Display the context name.

## SMB Settings

Set the version of SMB protocol that is used for functions such as Scan to Network Folder.

Use this setting to connect to a device that cannot automatically change the SMB protocol version, or when there is a problem in the connection with another device due to different versions.

Set the version to SMB2.0, SMB2.1, or SMB3.0.



- One of the settings is SMB1.0, however, this is always enabled and cannot be disabled.
- When a version is disabled, version settings higher than that version are all disabled. When a version is enabled, all version settings lower than that version are enabled.

## Print Port Settings

### LPD

Enter a profile expiring date.

### LPD Settings

#### LPD

Set this option to use LPD.

#### Timeout

Enter a timeout. The default setting is 90 seconds.

#### Use Banner

Set this option to use the banner. The default setting is "Invalid".

### RAW

### Raw Print Settings

#### Raw Print

Set this option to use Raw printing. The default setting is "Valid".

#### Port Number

Enter a port number. The default setting is port 9100.

#### Timeout

Enter a timeout. The default setting is 90 seconds.

#### Use Bidirectional

To use bidirectional communication, set to .



## WSD

### WSD Settings

#### WSD Print

Set this option to use WSD printing.

#### Use Multicast Discovery

Set this option to use multicast discovery.

## External Print Services Settings

For AirPrint Settings, see the "AirPrint Guide".

## LDAP Settings

The following explains the LDAP settings.

When you tap the [Store] key, the LDAP settings are updated with your entries.

The default address book is set to .

### Add

To add the global address book, tap the [Add] key.

### Delete

To delete the global address book, select it and tap the [Delete] key.

### Settings

| Setup Items                | Setting  |
|----------------------------|--|
| Name                       | Enter the address book name.   |
| Search Root                | Enters the search defaults to search for a specific area of the LDAP directory information tree.<br>Example: o = ABC, ou = NY, cn = Everyone<br>Entries must be separated from each other by semicolons or commas. |
| LDAP Server                | Enter the IP address or host name of the LDAP server.  |
| Server Type                | Select the Default or Custom from the service type list. The default setting is Default.   |
| User Identity Attribute    | Set the user ID property. The default setting is "uid".  |
| Search Attribute           | Set the LDAP search property. The default setting is "cn".   |
| Obtain E-mail address from | Set the e-mail address search. The default setting is "mail".  |
| Public Key Search          | Sets the open key search. The default setting is "userCertificate".  |
| Pages Limit Group          | Set the Storing Page Limit Group Search. The default setting is "pagelimit".   |
| Authority Group            | Set the Storing Authority Group Search. The default setting is "authority".  |
| Favorite Operation Group   | Set the Favorite Operation Group Search. The default setting is "favorite".  |
| My Folder                  | Set the My Folder Search. The default setting is "myfolder".   |
| Card ID                    | Sets the card ID search. The default setting is "cardid".  |
| Home Directory             | Enter a path of your Home Directory with a maximum of 64 characters.   |
| User Name                  | Enter a user name for authentication for Home Directory path with a maximum of 127 characters.   |
| Password                   | Enter a password for authentication to the Home Directory path with a maximum of 255 digits.   |
| Custom Property 1-10       | Enter each custom property.  |
| Port Number                | Enter a port number. The default setting is port 389.  |
| Timeout                    | Enter a timeout. The default setting is 5 seconds.   |
| User Name                  | Enter the account name for LDAP setting.   |



| Setup Items                                  | Setting   |
|--|---|
| Password                                     | Enter the password.<br>To change the password, set [Change Password] to <input checked="" type="checkbox"/> . |
| Authentication Type                          | Select the authentication server from the drop-down list.   |
| Bind Prefix                                  | Set the Bind prefix. The default setting is "uid".  |
| Server Usage                                 | Set the server application.<br>Set the address book and user authentication.                                  |
| Applicable Destination Type                  | Select the applicable destination type from E-mail Address.   |
| Allow selection on operation panel.          | Specify whether or not enable the global address to be selected on the operation panel of the machine.        |
| To Be Used as Default                        | Specify whether or not to use the selected global address as default.   |
| Authenticate a User in Global Address Search | Select whether or not authenticate a user when a global address is searched for.                              |
| Enable SSL                                   | Enables the SSL encryption communication.   |
| Connection Test                              | Tap the [Execute] button, and the connection test is executed and its result is displayed.                    |



When settings are changed, the changes will take effect after the machine is restarted. To restart the machine, see "[TURNING ON THE POWER \(page 1-10\)](#)".



# Proxy Setting

Access the network through a proxy server.

## Settings

| Item                        | Description   |
|-----------------------------|---|
| Proxy Setting               | Set whether proxy settings are used.  |
| Proxy Server Address        | Enter the proxy server address.   |
| User Name                   | Enter a user name to access the proxy server.   |
| Password                    | Enter a password to allow access to the proxy server.   |
| Port Number                 | Enter the proxy server port number.   |
| Address without Using Proxy | <p>Specify exception addresses for a proxy that is used in the external service connect function, Sharp OSA.</p> <p>[Entry method]</p> <ol style="list-style-type: none"><li>1) Can be set using a host name or an IP address.</li><li>2) When using a host name, you can use a wildcard (*) at the beginning of the domain name.<br/>(Example: "*example.□□□" (equivalent to "example.□□□", "sub.example.□□□", "subexample.□□□", etc.)</li><li>3) When using an IP address, you can use a wildcard (*) at the end of the address.<br/>(Example: "10*" (equivalent to 100.nnn.nnn.nnn to 109.nnn.nnn.nnn)<br/>If the Sharp OSA application using "HTML Browser 3.5" is set to an exception address, rule (3) cannot be used.</li><li>4) You can use a separator (semicolon (:)) to enter multiple addresses.<br/>(Example: "99.99.99.99;example.□□□")</li></ol> |



# Device Web Page Setting

The following explains the access settings to Setting mode (Web version).

## HTTP Access Settings

### Number of Users who can Log-in at the Same Time

Enter a number of users who can access Setting mode (Web version) simultaneously.

### Auto Logout Time

Enter a time to automatically log out when no communication continues with the machine.



When settings are changed, the changes will take effect after the machine is restarted. To restart the machine, see "[TURNING ON THE POWER \(page 1-10\)](#)".

---

## View Login User

The user or users who have logged in this machine are displayed.

## Current Login User

The currently logged in users are displayed.

## Logout All Users

The current login users are logged out.



When settings are changed, the changes will take effect after the machine is restarted. To restart the machine, see "[TURNING ON THE POWER \(page 1-10\)](#)".

---



# Security Settings

---



When settings are changed, the changes will take effect after the machine is restarted. To restart the machine, see "[TURNING ON THE POWER \(page 1-10\)](#)".

---

## Password Change

### Restrict Device Web Page Access Via Password

Use this setting to display the login screen and require login in order to access the Web server.

### Change Password

The administrator password can be changed.

When changing the password, be sure to remember the new password.

(It is recommended that you periodically change the administrator password.)

Enter a password consisting of 1 to 255 characters (administrator password: 5 to 255 characters), and tap the [Store] key.

Your setting is made valid only when the machine is turned On again.

- The user-level authentication password is required to add, edit or delete the destination. When you log on, enter "users" as the user name. Then, enter the user password that you have registered with this option.  
The administrator-level authentication password is required to select all settings and the same functions as those available with the user-level password. When you log on, enter "admin" as the user name. Then, enter the administrator password that you have registered with this option.
  - If you tap the [Store] key without entering a password, the previously set value is assumed. Password protection is enabled by default.
- 



In the factory default state, the user password must be entered.  
(For the default password, see "Start Guide".)

---



## Condition Settings

### Restrict Print Jobs other than the current Print Hold Job

You can select settings to cancel print jobs that are not print hold jobs, or force all print jobs to be held. When [Restrict Print Jobs other than the current Print Hold Job] is turned ON, the settings below can be selected.

| Item            | Settings  |
|-----------------|---|
| Force Retention | This setting forcibly sets all print jobs as print hold jobs, even jobs for which print hold is not selected. |
| Disable Job     | Prohibit all print jobs other than print hold jobs.   |

### Automatic Deletion of Suspended Print Jobs

If a job is interrupted because of a paper jam or similar, then after the time set in "Time until Suspended Print Jobs are Automatically Deleted", the job will be automatically deleted.

### Time until Suspended Print Jobs are Automatically Deleted

Set the time after stopping a job to automatically deleting the job.

### Reject Requests from External Sites

You can reject the request from external sites.

### If Firmware Corruption is Detected, Restore It

When the machine is started up, it checks the firmware and if damage is found, it will automatically recover to the state before the damage.

### Apply Security Policy

The default administrator is displayed at login. Set whether to apply security policy on this machine.

### Mandatory Access Control

Set whether to perform mandatory access control. You can force access control to all the files inside the machine.





## Port Control

Enable or disable main system ports, set the port numbers, and tap the [Store] key.  
The following ports can be configured.

| Server Port   | Client Port  |
|---|--|
| <ul style="list-style-type: none"> <li>• HTTP</li> <li>• HTTPS</li> <li>• FTP Print</li> <li>• Raw Print</li> <li>• LPD</li> <li>• IPP</li> <li>• IPP-SSL</li> <li>• Tandem Output Receive</li> <li>• PC Scan</li> <li>• Remote Operation Panel</li> <li>• SNMPD</li> <li>• SMB</li> <li>• SMTP</li> <li>• WSD</li> <li>• Print Release</li> <li>• Sharp OSA (Expansion Platform)               <ul style="list-style-type: none"> <li>• HTTP</li> <li>• HTTPS</li> </ul> </li> </ul> | <ul style="list-style-type: none"> <li>• HTTP</li> <li>• HTTPS</li> <li>• FTP</li> <li>• FTPS</li> <li>• SMTP</li> <li>• SMTP-SSL</li> <li>• POP3</li> <li>• POP3-SSL</li> <li>• SNMP-TRAP</li> <li>• Notify Job End</li> <li>• LDAP</li> <li>• LDAP-SSL</li> <li>• SMB/WINS</li> <li>• SNTF</li> <li>• mDNS</li> <li>• Tandem Output Send</li> <li>• Data Backup (Send)</li> <li>• Print Release</li> <li>• XMPP</li> </ul> |

## Filter Setting

You can set the filter by an IP or MAC address to prevent an unauthorized access to the machine via a network.  
Set the IP or MAC address filter and tap the [Store] key.

### IP Address Filter Settings

This option sets an IP address.

You can specify whether to allow or prohibit access to the machine from the IP address you set.

### MAC Address Filter Settings

This option sets a MAC address.

It allows access to the machine from the MAC address you set.



# Intrusion/Attack Detection

## Intrusion/Attack Detection

If the same IP address is accessed more than the specified number of times during a certain period, access from that IP address is prohibited. In addition, IP addresses for which access is prohibited are managed as a reception refusal list, and the reception refusal status is released (deleted) with administrator authority.

The IP addresses subject to the rejection are recorded in the audit log and sent to E-mail alert address lists 1 and 2 and E-mail alert dealer address list.



- When you want to send e-mail to the E-mail alert address list or E-mail alert dealer address list, enable [Security Alert] in [E-mail Alert] ([page 7-108](#)).
- If sending the e-mail fails, it will not be resent.

## List of Denied IP Addresses

| Item                                  | Settings  |
|---------------------------------------|---|
| IP Address                            | Displays the rejected IP addresses. The default setting is "OFF". |
| Start Time of Incoming Packet Denials | Displays the date and time when reception rejection started.      |
| Total                                 | Displays the number registered in the reject list.                |

## SSL Settings

SSL can be used for data transmission over a network.

SSL is a protocol that enables the encryption of information communicated over a network. Encrypting data makes it possible to transmit and receive sensitive information safely.

Data encryption can be set by the following protocols.

### Server Port

- **HTTPS:** Apply SSL encryption to HTTP communication.
- **IPP-SSL:** Apply SSL encryption to IPP communication.
- **Redirect HTTP to HTTPS in Device Web Page Access:**  
When this setting is enabled, all communication that attempts to access the machine by HTTP is redirected to HTTPS.



## Client Port

- **HTTPS:** Apply SSL encryption to HTTP communication.
- **FTPS:** Apply SSL encryption to FTP communication.
- **SMTP-SSL:** Apply SSL encryption to SMTP communication.
- **POP3-SSL:** Apply SSL encryption to POP3 communication.
- **LDAP-SSL:** Apply SSL encryption to LDAP communication.
- **syslog-SSL:** Apply SSL encryption when sending the Audit Log.
- **Verify Signature of Server Certificate of the Other Party:**  
Check the certificate of the communication destination server.
- **Use only TLS 1.2:** Only use TLS 1.2.

## Level of Encryption

The encryption strength can be set to one of three levels.

## Device Certificate

### Certificate Status

Shows the status of the certificate required for transmission using SSL. To install a certificate, click [Select].

### Certificate Information

When a device certificate is installed, click the [Show] key to display the certificate information.

### Select Device Certificate

When the [Select] key is clicked, the already registered device certificate will be displayed and select from registered device certificates.

# S/MIME Settings

## Condition Settings

Set whether S/MIME is used for transmission.

## Device Certificate

### Certificate Status

Shows the status of the certificate required for transmission using S/MIME. To install a certificate, click [Select].

## Sign Settings

### Sign E-mail

Enable "Sign E-mail" to use a signature.

### Signature Algorithm

Set the algorithm for the signature.



## Encryption Settings

### Sign E-mail

Enable "Sign E-mail" to use a signature.

### Encrypt

Enable encryption.

### Disable sending to the addresses which cannot be encrypted.

Prohibit transmission to addresses that cannot be encrypted.

### Certificate Information

When a device certificate is installed, click the [Show] key to display the certificate information.

### Select Device Certificate

When the [Select] key is clicked, the already registered device certificate will be displayed and select from registered device certificates.

## IPsec Settings

IPsec can be used for data transmission/reception on a network.

When IPsec is used, data can be sent and received safely without the need to configure settings for IP packet encryption in a Web browser or other higher-level application.

When enabling this settings, take the following notes.

- It may take some time to reflect on the machine settings, and you cannot connect to the machine during this time.
- If the Setting mode (Web version) settings are not correctly selected, connection to the machine may not be allowed, or the settings may not allow printing, scanning, or Setting mode (Web version) display. In this case, deselect this setting and change the System Settings (on Web pages).

## Condition Settings

### IPsec Settings

Specify whether or not IPsec is used for transmission.

### IKEv1 Settings

#### Pre-Shared Key

Enter the Pre-Shared Key to be used for IKEv1.

#### SA Lifetime (time)

Set the SA lifetime.

#### SA Lifetime (size)

Set the SA lifetime size.

#### IKE Lifetime

Set the IKE lifetime.



## IPsec Rules

The registered IPsec rules are displayed.

To add a new rule, click the [Add] key.

To delete a rule, select the rule you want to delete and click the [Delete] key.

## IPsec Rule Registration

### Rule Name

Enter a name for the IPsec rule.

### Priority

Set the priority level.

### Select the Rule Name to be the Registration Model

If there is a previously registered rule that is similar to the rule you want to create, you can create the new rule based on the registered rule.

### Device Address

Set the type of IP address to be used on the machine and the port number (for IPv6, set the port number / prefix length).

### Client Address

Set the destination IP address type and port number (for IPv6, set the port number / prefix length).

### Protocol

Set the protocol to be used.

### Filter Mode

Set the filter to be used for IPsec.

### IPsec Encryption

Configure settings for the authentication method used for IPsec.

#### ESP

Select to use ESP authentication.

#### Allow Communication not using ESP

Specify whether or not communication that does not use ESP is allowed.

#### AH

Select to use AH authentication.

#### Allow Communication not using AH

Specify whether or not communication that does not use AH is allowed.



## Document Administration Function

All of the transmitted image data (sent or received by e-mail transfer) can be forwarded to any destination.

| List name  | Settings   |
|--|--|
| <b>Forwarding Destination Settings (Send Data)</b> |  |
| Forward Send Data                                  | Set a destination to forward the send data.  |
| E-mail/Network<br>Folder/FTP/Desktop               | Select a forwarding type of the send or received image data. When determined, select the destination from the address book.<br>You can enter an e-mail directly.<br>• Format: Select a format for data forwarding. |
| Clear Setting                                      | Releases the destination settings.   |
| File Format  | Select the file format for inbound routing.  |



Even if using the scanner function "[AUTOMATICALLY ADJUST SKEWED PDF SCAN DATA \(PDF SKEW ADJUSTMENT\)](#) (page 4-106)", correction results will not be reflected.



# Hidden Pattern Print Setting

Select Hidden Pattern Print Setting.

The hidden pattern print function is effective at preventing unauthorized copying as the specified text emerges in the background on output sheets.

## Initial Status Settings

### Default Settings

| Item                         | Settings   |
|------------------------------|--|
| Hidden Pattern Print Setting | A pattern print can be printed with this settings.   |
| Print Color                  | Select a print color.  |
| Exposure                     | Select an exposure.  |
| Font Size                    | Select a font size.  |
| Angle                        | Select a character angle.  |
| Font Style                   | Select the standard or italic character settings.  |
| Camouflage Pattern           | Set a camouflage pattern.  |
| Print Method                 | Select a character display pattern. <ul style="list-style-type: none"> <li>• Positive</li> <li>• Negative</li> </ul> |

### Print Contents Setting

| Item                 | Settings  |
|----------------------|---|
| Pre-Set Word         | Allows you to select a preset character string.<br>The following character strings can be selected. <ul style="list-style-type: none"> <li>• DO NOT COPY, Copy Ban, Internal Use Only, Handle with Care, CONFIDENTIAL, Copy Invalid, IMPORTANT, COPY</li> </ul> |
| Fixed Phrase         | Select a stored preset character string.<br>This setting is ignored if [Direct Entry] is enabled. <ul style="list-style-type: none"> <li>• DO NOT COPY, Copy Ban, Internal Use Only, Handle with Care, CONFIDENTIAL, Copy Invalid, IMPORTANT, COPY</li> </ul>   |
| Information Printing | Enables simultaneous printing of the following information sets. <ul style="list-style-type: none"> <li>• Serial number, account job ID, login name/user number, number of copy control, date and time</li> </ul>   |
| Disable Direct Entry | Set whether to enable printing characters of Hidden Pattern Print directly in each mode.  |

### Contrast

Set a character contrast in any of 9 levels.

### Custom Text Registration

Stores the user-created print characters. Up to 30 characters can be stored.



## Tracking Information Print

Prints the tracking information at the top or bottom of output pages when copy or print job is executed.

| Item                               | Settings   |
|------------------------------------|--|
| Tracking Information Print Setting | Set this option to print the tracking information.   |
| Print Information                  | The following information can be printed. <ul style="list-style-type: none"> <li>Serial number, characters, account job ID, login name/user number, date and time</li> </ul> |
| Position                           | Set a print position on each page.   |
| Font Size                          | Set a font size.   |
| Select the Job to Print            | Set a job to print the tracking information.   |

## Audit Log

Logs are created and saved for various events relating to security functions and settings.

Audit logs are created and saved in English. However, setting values such as filenames which are input from external sources are saved as-is.

Audit logs which have been saved in the internal storage can be exported by an administrator to a PC as TSV files.

You can select either the internal storage or an external server as the destination for saving audit logs.



When the space for saving audit logs internally becomes full, the logs are overwritten starting from the oldest ones.

## Audit Log

"Audit Log" can be carried out as follows.

In "Settings (administrator)", select [System Settings] → [Security Settings] → [Audit Log].

Select "Security Control", "Storage/Send Settings" or "Save/Delete Audit Log".

## Storage/Send Settings

"Storage/Send Settings" can be carried as follows.

In "Settings (administrator)", select [System Settings] → [Security Settings] → [Audit Log] → [Storage/Send Settings]

Then make the storage and transmission settings.

## Save/Delete Audit Log

"Save/Delete Audit Log" can be carried out as follows.

In "Settings (administrator)", select [System Settings] → [Security Settings] → [Audit Log] → [Save/Delete Audit Log]

Select "Save Audit Log" or "Delete Audit Log".



- "Save Audit Log" can only be carried out from the web page.
- This is not displayed when a high level of security has been set, when audit logs have been disabled, or when storage saving has been disabled.





## Audit Log Specification

When the storing destination of the audit log is specified as an external server, the audit log is saved in the prepared buffer inside the internal storage temporarily until the sending to the external server is completed successfully.

- After the sending to the external server is completed successfully, the audit log in the buffer will be deleted.
- If the sending to the external server is failed, a warning message will be displayed on the operation panel or the web page, and resending to the external server is performed periodically until the sending is completed successfully.

The audit event and information stored in the audit log are as shown in the table below.



If the machine is shut down due to a method other than the procedure described in the "User's Manual" bundled with the machine or power failure, the [Audit End] event may not be recorded. The machine should be powered off by the proper procedure. For the unexpected situation such as power failure, it is recommended to use the uninterruptible power-supply system (UPS).

| Event name   | Date and time*1 | Operation I/F*2 | Login name  | Result *3 | Additional information   |
|--|-----------------|-----------------|---|-----------|--|
| Audit Start  | Yes             | N/A             | N/A   | Yes       | N/A  |
| Audit End  | Yes             | N/A             | N/A   | Yes       | N/A  |
| Job Completion   | Yes             | Yes             | Job owner (If it is the system, then "SYSTEM".)                           | Yes       | Completed job name   |
| I&A Failure  | Yes             | Yes             | Character string entered as a login name                                  | N/A       | N/A  |
| Add User   | Yes             | Yes             | User who performed the addition   | Yes       | Added login name   |
| Change Password  | Yes             | Yes             | User who performed the change   | Yes       | Login name of the user whose password is changed   |
| Change Login Name  | Yes             | Yes             | User who performed the change   | Yes       | Login name after change  |
| Delete user  | Yes             | Yes             | User who performed the deletion   | Yes       | Deleted login name (In the case of "All User Deletion", "ALL".)  |
| Add Auth Group   | Yes             | Yes             | User who performed the addition   | Yes       | Added authority group name   |
| Change Role  | Yes             | Yes             | User who performed the change   | Yes       | <ul style="list-style-type: none"> <li>• Login name of the user whose authority group the belongs is changed</li> <li>• Authority group name after change</li> </ul> |
| Change Auth Group Setting  | Yes             | Yes             | User who performed the change   | Yes       | Authority group name of which setting is changed   |
| Change Time Setting  | Yes             | Yes             | User who performed the change   | Yes       | N/A  |
| Change Setting   | Yes             | Yes             | User who performed the change ("By Policy" when the AD policy is applied) | Yes       | <ul style="list-style-type: none"> <li>• Setting item of which setting value is changed</li> <li>• Setting value after change</li> </ul>                             |
| Comm Failure<br>* The communication counterpart is the audit server. | Yes             | N/A             | SYSTEM  | N/A       | Reason of failure  |



| Event name   | Date and time*1 | Operation I/F*2 | Login name                    | Result *3 | Additional information  |
|--|-----------------|-----------------|-------------------------------|-----------|---|
| Comm Failure<br>*The communication counterpart is except for the audit server. | Yes             | Net             | N/A                           | N/A       | <ul style="list-style-type: none"> <li>• IP address of the starter of the communication</li> <li>• IP address of the communication counterpart</li> <li>• Communication direction</li> <li>• Reason of failure</li> </ul> |
| Modify Addr Book   | Yes             | Yes             | User who performed the modify | Yes       | Add: Internal control ID and address name of the added entry<br>Delete/Change: Internal control ID of the deleted/changed entry   |
| Firm Update  | Yes             | Yes             | User who performed the update | Yes       | <ul style="list-style-type: none"> <li>• Firmware name</li> <li>• Firmware version before update</li> <li>• Firmware version after update</li> </ul>  |
| Firm Recovery  | Yes             | N/A             | N/A                           | Yes       | <ul style="list-style-type: none"> <li>• Firmware name</li> <li>• Firmware version after recovery</li> </ul>  |
| Exec Rejection   | Yes             | N/A             | N/A                           | Yes       | Identification name of the firmware or built-in OSA application   |

\*1 The event occurrence date and time is notated in the expansion format of ISO 8601.

\*2 Any of Ope/Web/Net is notated as an operation interface. However, "N/A" is described in the table, "N/A" is notated.

\*3 Any of Success/Failure is notated as an event execution result. However, "N/A" is described in the table, "N/A" is notated.



# Certificate Management

## Device Certificate Management

### Import

Import the certificate/private key.

### Export

Export the certificate/private key.

### Certificate Information

Shows the status of the certificate.

### Creation of Certificate and Private Key

#### Common Name (Required)

Enter the name to be used.

#### Organization

Enter the name of the organization.

#### Organizational Unit

Enter the name of the unit within the organization.

#### City/Locality

Enter the city or locality.

#### State/Province

Enter the state or province.

#### Country/Region (Required)

Enter the country code.

#### Sender Address

Enter the sender's E-mail address.

#### Certificate Start Date

Enter the start date and time for the certificate.

#### Certificate Validity Period

Enter the expiration date of the certificate.

#### Certificate Information

Enter the Certificate Information.

## Certificate Signing Request (CSR) Management

### Install

Install the certificate. Select the certificate file.

### Certificate Information

Shows the status of the certificate.



## **Make of Certificate Signing Request(CSR)**

### **Common Name (Required)**

Enter the name to be used.

### **Organization**

Enter the name of the organization.

### **Organizational Unit**

Enter the name of the unit within the organization.

### **City/Locality**

Enter the city or locality.

### **State/Province**

Enter the state or province.

### **Country/Region (Required)**

Enter the country code.

### **Sender Address**

Enter the sender's E-mail address.

### **Certificate Start Date**

Enter the start date and time for the certificate.

### **Certificate Validity Period**

Enter the expiration date of the certificate.

### **Certificate Information**

Enter the Certificate Information.

## **CA Certificate Management**

### **Import Certificate**

Import the certificate.

### **Certificate Information**

Shows the status of the certificate.



# System Control

## Job Log

### Job Log Operation

Deletes or stores log of a job executed on the machine.

Set the number of jobs for [The Number of Job Log to Notify by E-mail] and click [Store].

Tap the [Delete] key to delete the job log.



You can save the job log by selecting the [Job Log] in Setting mode (Web version).

### View Job Log

Views log of a job executed on the machine.

Select a view item and period, and tap the [Show] key.

## Data Import/Export (CSV Format)

You can import or export data.

### Export Settings

#### Export Settings Type

Select the data to be exported from the address book or registered user information. Once you have selected the data, click the [Execute] key. The data will be exported in CSV format.

### Import Settings

#### Import settings from file

You can import data that was exported in CSV format into the machine.

## Storage Backup

Address book information and user information stored in the machine can be saved to and retrieved from a USB memory device. To use the machine to manipulate a file, first insert the USB memory device in the machine. If you need to select settings on the Web page, use your computer to manipulate the file.

### Export

Exports data.

### Import

Imports data into the machine.



## Device Cloning

Saves the machine setting information in XML format and copies the information to another machine. This function saves you the trouble of repeatedly configuring the same settings in multiple machines. To use the machine to manipulate a file, first insert the USB memory device in the machine. If you need to select settings on the Web page, use your computer to manipulate the file.

### Export

Exports data.

### Import

Imports data into the machine.



- For models that can be imported, consult your dealer.
- The following data is not copied when device cloning is performed:
  - List print forwarding items.
  - Count and device status display items.
  - IP address of the machine, device name, administrator password, sender names for image send, and other information that is specific to the machine.
  - The settings specific to each hardware such as screen contrast, and saddle stitch position adjustment

## Address Book Forward

Forward the data stored in the address book of the machine to another machine.

To forward the address book contents, enter the IP address of the destination machine and the password of the administrator of that machine, and tap the [Execute] key.

## Filing Data Backup

You can back up a file saved with Document Filing, and restore a backed up file to the machine.



Use setting mode (Web) to create backups of filed data.

## Export Settings

Select the folder you want to back up and click [Execute]. The files are saved to your computer.

| Item          | Description  |
|---------------|--|
| Index         | The displayed Folder names can be filtered by index. |
| Display Items | Set the number of files that are displayed.          |

## Import Settings

You can restore a file to the machine that was saved with "Export Settings". Enter a maximum of 200 characters for the path of the saved file in "Import settings from file", and click [Execute].



# Storing/Calling of System Settings

You can reset the current Setting mode settings to the previously stored settings or to the factory default settings.

## Store Current Configuration

Stores the currently configured Setting mode in the machine memory.

The stored settings will be retained even if the [Power] button is turned off. To retrieve the stored settings, use "Restore Configuration" below.

### Items not stored

- Network Settings: These are not stored as unexpected settings may cause damage to the network.
- Product Keys: Product Keys are not stored as reissue of keys may be necessary.

## Restore Configuration

Restores the settings stored with "Store Current Configuration".

The current settings are replaced by the retrieved settings.

# Reset Settings

## Restore Factory Defaults

Restores the current settings (you have selected in Setting mode) to the factory default settings. If you wish to create a record of the current settings before restoring, print the current settings by selecting [Status] in "Settings (administrator)" → [Data List] → [List for Administrator].



When settings are changed, the changes will take effect after the machine is restarted. To restart the machine, see "[TURNING ON THE POWER \(page 1-10\)](#)".

## Reset the NIC

This returns all "Network Settings" to the factory default settings.

# Optimization of Local Drive

Various devices mounted on the machine can be set.

This function optimizes the local drive of the machine by defragmenting data. If a job is in progress, a message will appear and optimization will not begin until the job is finished. During optimization, the following operations are not possible:

- Access to Setting mode (Web version), and reception of print data
- Use of keys on the operation panel
- Turning off the power with the main power switch of the machine.
- Auto Power Shut-Off

When optimization is completed, the machine will automatically restart.



When the document filing function is frequently used and output of files seems somewhat slow, optimizing the local drive may improve performance.



# E-mail Alert and Status

## Status Message

Selects the Standard E-mail Status function or Advanced E-mail Status function settings.

The E-mail Status function can periodically transmit the machine status information to the stored address.

### Standard

Sets the E-mail status address list 1, E-mail status address list 2, and E-mail status dealer address list separately.

| Item               | Description  |
|--------------------|--|
| E-mail Address     | Enter the destination E-mail address for transmission of machine status information. When you enter multiple addresses, separate them by a semicolon (;) or a comma (,). |
| Send Now           | When tapped, the status message is sent to the destination of the E-mail address list.   |
| Send on Schedule 1 | If checked as <input checked="" type="checkbox"/> , an E-mail is sent periodically according to the preset schedule.   |
| Send on Schedule 2 | If checked as <input checked="" type="checkbox"/> , an E-mail is sent periodically according to the preset schedule.   |
| Time Schedule      | Select a schedule to send E-mails.   |

### Advanced

Bi-directional status message

Select whether or not bi-directional messages are enabled.

| Item               | Description   |
|--------------------|---|
| POP3 Server        | Enter the IP address or host name of the POP3 server.   |
| Port Number        | Enter the port number of the POP3 server. The default setting is port 110.  |
| POP Authentication | The authentication protocol (including APOP) is used for authentication to the POP3 server.   |
| User Name          | Enter the user name. The special user account is required for bi-directional E-mail status transmission.  |
| Password           | Enter the password.<br>To change the password, set [Change Password] to <input checked="" type="checkbox"/> .   |
| Check Interval     | Enter the polling interval for the POP3 server. The default setting is five minutes.  |
| Enable SSL         | <input checked="" type="checkbox"/> Allows the POP over SSL communication or the POP over TLS communication by STLS command.<br>This requires the server to support the POP over SSL communication or the STLS command.<br>To allow SSL communication, set the "Port Number" to the POP over SSL communication port number.<br>To allow POP over TLS communication, set the "Port Number" to the same port number as for the normal POP3 communication. |
| Connection Test    | Tap the [Execute] button to test the connection to the POP3 server.   |

## Alerts Message

Selects the E-mail Alert function settings.

The E-mail Alert function can report a trouble of the machine to the administrator or dealer using E-mail.

Sets the E-mail Alert Message List 1, E-mail Alert Message List 2, and Dealer E-mail Alert Message List separately.

### E-mail Address

Enter the destination E-mail address for alert message transmission. You can enter multiple addresses by separating them by a semicolon or comma.

Example: aaa@xxxx.□□□; bbb@xxxx.□□□

Select the status to send alerts from the following contents. You can individually set whether or not alerts are sent for each E-mail Alert Message List. When this machine enters the selected state, E-mail is sent to the set address.

Jam, Toner Low, Toner Empty, Paper Empty, Service Request, PM Request, Waste Toner Almost Full, Waste Toner Full, Job Log Full, Security Alert





## SMTP Settings

### Use SMTP Server in [Network Settings].

Set the SMTP server settings used for e-mail status and E-mail alert to the same settings as SMTP Settings ([page 7-79](#)) of network setting.

## SMTP Settings

Use this setting when not using "Use SMTP Server in [Network Settings].".

### Primary Server

Enter the IP address or the host name of the primary SMTP server.

### Secondary Server

Enter the IP address or the host name of the secondary SMTP server.

### Port Number

Enter a port number. The default setting is port 25.

### Timeout

Enter a timeout. The default setting is 20 seconds. This value is used for connection to the SMTP server and for data transmission according to the e-mail system specifications.

### Sender Name

Enter a maximum of 20 full-width/half-width characters for the sender name.

### Sender Address

Enter a maximum of 64 half-width characters for the sender address.

### Enable SSL

If  the SSL is enabled, the SMTP-over-TLS encryption communication can be used by STARTTLS command. This requires the server to support the STARTTLS command.

To allow SSL communication, set the "Port Number" to the same port number as the normal SMTP.

### SMTP Authentication

Carries  out the SMTP server authentication.

If you use the Kerberos authentication, set the KDC server, port number, and realm on the Kerberos authentication settings page.

### User Name

Enter the user name.

### Password

Enter the password.

To change the password, set [Change Password] to .

### POP before SMTP

If  is set, you are authenticated to the POP server before using the SMTP communication.

•POP3 Server: Enter the IP address or the host name of the secondary SMTP server.

•Port Number: Enter the POP3 port number for POP before SMTP communication. The default setting is port 110.

•POP Authentication: If  is set, the authentication protocol (including APOP) is used for authentication to the POP3 server.

•User Name: Enter the user name for POP before SMTP communication.

•Password: Enter the password required for POP before SMTP communication. To change the password, set [Change Password] to .

•Enable SSL: If set to , the POP over SSL communication or the POP over TLS communication by STLS command is enabled.

This requires the server to support the POP over SSL communication or the STLS command.

To allow SSL communication, set the "Port Number" to the POP over SSL communication port number.

To allow POP over TLS communication, set the "Port Number" to the same port number as for the normal POP3 communication.

### Connection Test

Tap the [Execute] button to test the connection to the SMTP server.



# Image Quality Adjustment

---



Registration Adjustment or Fusing Cleaning Mode (including "MC Cleaning Mode") in [Collective Adjustment], all Common Functions, and removal of a toner cartridge can only be executed in setting mode on the machine.

---

## Collective Adjustment

Various devices mounted on the machine can be set.

### Fusing Cleaning Mode

Use this function to clean the machine's fusing unit when dots or other dirt appear on the printed side of the paper. When this function is executed, "V" printed paper is output and the fusing unit is cleaned.

---



If improvement is not noticed after the first time you use the function, try executing the function again.

---

### MC Cleaning Mode

This machine periodically executes automatic cleaning and normally it is not necessary to execute this mode. Only in case, however, that black lines appear on the printed paper, execute this mode.

---



Do not use this function when no black lines appear. Using this function under the normal condition may cause deterioration of the cleaner.

---

### Black Letter/Black Line Width Adjustment

Adjust black text and the width of black lines. After using this function to perform adjustment, perform [System Settings] - [Common Functions] - [Auto Gray Calibration (for Copy)], [Auto Gray Calibration (for Print)].



## Dark Streak Reduction

Specify to use the black streak reduction or not.

The dark streak reduction can be used for Scan Original, Copy, Image Send, and Scan to Local Drive functions.

If the dark streak reduction is enabled, select any of the following options.

- **Treat Thin Dark Streaks:** Use this setting to make thin dark streaks less apparent. (Low level)
- **Normal:** Use this setting to make dark streaks less apparent. (Medium level)
- **Treat Up to Thick Dark Streaks:** Use this setting to make thick dark streaks less apparent. (High level)



Increasing the level of dark streak treatment may result in faint text and poor reproduction of lines.

## Display warning message for dark streaks detection.

Set this option to display a warning message when dark streaks are detected by the document feeder.

## Copy Image Quality

### Quick Image Quality Adjustment

You can easily perform copy quality adjustment in the default state.

You can change the default setting ([2]) to [1 (Smooth)] or [3 (Sharp)].

### Gray Balance

You can adjust the gradation, and density of copies.

The density is divided into 3 ranges and you can adjust the level of each.

### Density Adjustment when [Auto] is selected for Exposure

Configure settings for copying when [Auto] is selected for the copy exposure. The exposure can be adjusted separately for copying using the document glass and copying using the auto document feeder.

### Sharpness

You can make copy images in the default state sharper or softer.

### Image Quality Priority

Specify image quality priority. Set this for the auto copy exposure and text / printed photo settings.



# Print Image Quality

## Quick Image Quality Adjustment

Perform quick adjustment of print quality.

You can change the default setting ([2]) to [1 (Smooth)] or [3 (Sharp)].

## Gray Balance

You can adjust the tone and density of printing.

The density is divided into 3 ranges and you can adjust the level of each.

## Exposure Adjustment

Set the density of printing.

## Line Thickness

This setting is used to adjust the line width of vector graphics. Except for CAD and other specialized uses, there is normally no need to change this setting.

# Scan Image Quality

## RGB Adjust

Set the color tone (RGB) for scanning.

## Sharpness

Use this setting to obtain a sharp image when scanning an original.

## Contrast

You can adjust the contrast of scanned images.



## Common Functions

### Auto Gray Calibration (for Copy)

### Auto Gray Calibration (for Print)

Performs automatic grayscale correction.

For copying, adjust with [Auto Gray Calibration (for Copy)]. For printing, adjust with [Auto Gray Calibration (for Print)]. .

The machine prints a test patch, the test patch is scanned, and the grayscale is automatically corrected.

After the [Execute] key is tapped and a test patch is printed, a message appears prompting you to begin automatic calibration.

Follow the instructions in the message to perform gray adjustment.



If the grayscale is still off after performing Auto Gray Calibration, repeating Auto Gray Calibration once again may improve the grayscale.

---



# Initial Installation Settings

This groups together the items that were set initially when the machine was installed. The initial installation setting items are the same as the regular setting items that have the same name. For information on a setting item, see the explanation of the regular item.

| Item   | Description  |
|--|--|
| Condition Settings   |  |
| Name   |  |
| Machine Code   |  |
| Machine Location   |  |
| Memo   |  |
| Clock Adjust   |  |
| Daylight Saving Time Setting   | System Settings - Common Settings - <a href="#">Machine Identification Settings (page 7-75)</a>      |
| Preheat Mode Setting   |  |
| Auto Power Shut-Off  |  |
| Display Message When Extending Transition Time to Preheat/Auto Power Shut-Off Mode | System Settings - Energy Save - Eco Settings ( <a href="#">Eco (page 1-21)</a> )                     |
| Sleep Mode Power Level   |  |
| Network Quick Settings   | System Settings - Network Settings - <a href="#">Quick Settings (page 7-78)</a>                      |
| Tray Settings  | System Settings - Common Settings - Paper Settings- <a href="#">Paper Tray Settings (page 1-110)</a> |
| Product Key/Application Number Input   | System Settings - Common Settings - <a href="#">Product Key/Application Number Input (page 7-76)</a> |



# APPENDIX

## SPECIFICATIONS

SPECIFICATIONS ..... 8-2

## LICENSE INFORMATION

LICENSE INFORMATION ..... 8-6



# SPECIFICATIONS

## Basic Specifications / Copier Specifications

|  |   |                 |
|--|---|-----------------|
| Name   | MX-M1056/MX-M1206   |                 |
| Type   | Console   |                 |
| Copier system  | Laser electrostatic copier  |                 |
| Resolution   | Read: 600 x 600 dpi, 600 x 400 dpi, 600 x 300 dpi<br>Write: 1200 x 1200dpi, 600 x 600 dpi   |                 |
| Gradation  | Scan: equivalent to 256 levels<br>Print: equivalent to 256 levels   |                 |
| Original paper sizes   | Max. 11" x 17" (A3) for sheets and bound documents  |                 |
| Copy sizes   | SRA3, 12" x 18" (A3 wide) to 5-1/2" x 8-1/2"R (A5R)<br>Tray 1: 8-1/2" x 11", A4, B5<br>Tray 2: 8-1/2" x 11", A4<br>Tray 3: 12" x 18" (A3 wide), 11" x 17", 8-1/2" x 14",<br>8-1/2" x 13-1/2", 8-1/2" x 13-2/5", 8-1/2" x 13",<br>8-1/2" x 11", 8-1/2" x 11"R, 7-1/4 x 10-1/2"R, A3,<br>B4, A4W, A4, A4R, B5, B5R<br>Tray 4: 12" x 18" (A3 wide), 11" x 17", 8-1/2" x 14",<br>8-1/2" x 13-1/2", 8-1/2" x 13-2/5", 8-1/2" x 13",<br>8-1/2" x 11", 8-1/2" x 11"R, 7-1/4 x 10-1/2"R,<br>5-1/2" x 8-1/2"R, A3, B4, A4W, A4, A4R, B5, B5R,<br>A5R, Custom (5.875" to 18" x 4.0" to 12" (148 to<br>457 mm x 100 to 305 mm))<br>Lost margin<br>Leading edge: 3/32" ± 13/64" (2 mm to 5 mm)<br>Trailing edge: 3/32" ± 13/64" (2 mm to 5 mm)<br>Leading edge / Trailing edge: total 21/64" (8 mm) or less<br>Left edge / Right edge: total 11/64" ± 3/32" (4 mm ± 2 mm) |                 |
| Paper type   | Tray 1/2: Plain<br>Tray 3: Plain, Heavy paper (28 lbs. bond to 80 lbs.<br>Cover (106 g/m <sup>2</sup> to 220 g/m <sup>2</sup> ))<br>Tray 4: Plain, Heavy paper (28 lbs. bond to 80 lbs.<br>Cover (106 g/m <sup>2</sup> to 220 g/m <sup>2</sup> )), Transparency<br>film, Label, Tab paper, Custom<br>Paper weight:<br>Tray 1/2: 16 lbs. bond to 28 lbs. bond (60 g/m <sup>2</sup> to 105 g/m <sup>2</sup> )<br>Tray 3/4: 16 lbs. bond to 80 lbs. Cover (60 g/m <sup>2</sup> to 220 g/m <sup>2</sup> )<br>• Some usage conditions or paper types may prevent<br>correct printing.  |                 |
| Warm-up time   | MX-M1056:200 seconds*1 / 213 seconds*2<br>MX-M1206:170 seconds*1 / 183 seconds*2<br>• This may vary depending on the ambient conditions.<br>*1 From the power button.<br>*2 From the main power switch.   |                 |
| First-copy time  | Document glass 3.2 seconds<br>DSPF 5.5 seconds<br>This may vary depending on the state of the machine.<br>* Portrait feeding of 8-1/2" x 11" (A4) sheets.   |                 |
| Continuous copying speeds* (when shifter is not in operation)  | MX-M1056  | MX-M1206        |
| 8-1/2" x 11", A4, B5, A5   | 105 copies/min.   | 120 copies/min. |
| 8-1/2" x 11"R, 7-1/4" x 10-1/2"R, A4R, B5R   | 67 copies/min.  | 76 copies/min   |
| 8-1/2" x 14", 8-1/2" x 13", 8-1/2" x 13-2/5", 8-1/2" x 13-1/2", B4   | 58 copies/min.  | 66copies/min.   |
| 11" x 17" (A3)   | 52 copies/min.  | 54copies/min.   |
| 12" x 18", A3 wide   | 49 copies/min.  | 51copies/min.   |
| * Continuous speed for same original source. Output may be temporarily interrupted to stabilize image quality. |   |                 |

|                                 |  |
|---------------------------------|--|
| Copy ratios                     | Same size: 1: 1 ± 0.5 %<br>Enlarge (Inch size): 121 %, 129 %, 200 %, 400 %<br>(AB size: 115 %, 122 %, 141 %, 200 %, 400 %)<br>Reduce (Inch size): 25 %, 50 %, 64 %, 77 %<br>(AB size: 25 %, 50 %, 70 %, 81 %, 86 %)<br>Zoom range: 25 to 400 % in 1 % increments, total 376 increments. Can calculate zoom rate when mm is specified. (25 - 200 % using automatic document feeder) |
| Paper feed / capacity           | • 1200 plus 800 plus 500 plus 500 (= 3000) sheets in 4 trays<br>• Using 20 lbs. bond (80 g/m <sup>2</sup> ) weight paper   |
| Max. paper feed / max. capacity | 1200 plus 800 plus 500 plus 500 (= 3000) sheets in 4 trays plus 500-sheet multi-bypass tray plus 5000 sheets in large capacity trays plus 5000 sheets in large capacity trays (total 13500 sheets)<br>• Using 20 lbs. bond (80 g/m <sup>2</sup> ) weight paper   |
| Continuous copy                 | Max. 9999 copies   |
| Memory                          | Standard: 6 GB HDD: 1 TB<br>• 1 GB = One billion bytes when referring to hard drive capacity. Actual format capacity is less.  |

## Automatic Document Feeder

|                        |   |
|------------------------|---|
| Document feeder types  | Duplex Single Pass Feeder (DSPF)  |
| Original paper sizes   | 11" x 17" to 5-1/2" x 8-1/2" (A3 to A5), business card sizes  |
| Original paper types   | Paper weight<br>Thin paper 9 lbs bond to 13 lbs bond (35 g/m <sup>2</sup> to 49 g/m <sup>2</sup> )<br>Plain paper 13 lbs bond to 40 lbs bond (50 g/m <sup>2</sup> to 157 g/m <sup>2</sup> )<br>Heavy paper 40 lbs bond to 120 lbs index (158 g/m <sup>2</sup> to 220 g/m <sup>2</sup> )<br>Business card 0.1 to 0.2 mm<br>Two-sided<br>Plain paper 13 lbs bond to 40 lbs bond (50 g/m <sup>2</sup> to 157 g/m <sup>2</sup> )<br>Heavy paper 40 lbs bond to 120 lbs index (158 g/m <sup>2</sup> to 220 g/m <sup>2</sup> )<br>Business card 0.1 to 0.2 mm |
| Paper storage capacity | 300 sheets (20 lbs. (80 g/m <sup>2</sup> ))<br>(or maximum stack height of 1-1/2" (38 mm))<br>Business card: 150 sheets<br>(or maximum stack height of 1-1/2" (38 mm))  |
| Scan speed             | Copy mode B/W: 120 one-sided sheets/minute (600 x 300 dpi)<br>When scanning one-sided, 8-1/2" x 11" (A4) vertical documents<br>Scan mode B/W: 120 sheets/minute (one-sided), (300 dpi) 240 pages/minute (two-sided),<br>Color: 120 sheets/minute (one-sided), 240 pages/minute (two-sided),<br>When in standard mode using Sharp standard paper (8-1/2" x 11" (A4) size with 6% coverage) and the auto color detector is turned off. The speed varies depending on the data volume of the original.   |





## Multi Bypass Tray

|                       |   |
|-----------------------|---|
| Name                  | Multi Bypass Tray<br>(MX-MF11)<br>(For large capacity trays)  |
| Paper sizes           | 12" x 18" (A3W) to 5-1/2" x 8-1/2"R (A5R),<br>SRA3, SRA4  |
| Useable paper         | 16 lbs bond to 80 lbs cover (52 to 220 g/m <sup>2</sup> )   |
| Paper capacity        | 500 sheets (20 lbs (80 g/m <sup>2</sup> ))  |
| Required power supply | Supplied from large capacity trays  |
| Dimensions            | When paper tray is closed<br>27-3/4" (W) x 21-57/64" (D) x 8" (H)<br>(705 mm (W) x 556 mm (D) x 203 mm (H))<br>When paper tray is pulled out<br>34-9/16" (W) x 21-57/64" (D) x 8" (H)<br>(878 mm (W) x 556 mm (D) x 203 mm (H)) |
| Weight                | Approx. 39.7 lbs (18 kg)  |

## Large Capacity Tray

|                       |   |
|-----------------------|---|
| Name                  | Large Capacity Tray (MX-LC12)   |
| Paper sizes           | 8-1/2" x 11", A4, B5  |
| Useable paper         | 16 lbs bond to 80 lbs cover (60 to 220 g/m <sup>2</sup> )                             |
| Paper capacity        | 3500 sheets (20 lbs (80 g/m <sup>2</sup> ))   |
| Required power supply | Supplied from the machine   |
| Dimensions            | 14-13/16" (W) x 22-43/64" (D) x 20-5/8" (H)<br>(376 mm (W) x 576 mm (D) x 524 mm (H)) |
| Weight                | Approx. 64 lbs (29 kg)  |

## Large Capacity Trays

|                       |  |
|-----------------------|--|
| Name                  | Large Capacity Trays (MX-LC13 N)   |
| Paper sizes           | 12" x 18" (A3W) to 8-1/2" x 11" (B5R), SRA3, SRA4                                    |
| Useable paper         | 13 lbs bond to 110 lbs cover (52 to 300 g/m <sup>2</sup> )                           |
| Paper capacity        | 5000 sheets (2500 x 2 20 lbs (80 g/m <sup>2</sup> ))                                 |
| Required power supply | AC 120V 60Hz   |
| Dimensions            | 35-1/4" (W) x 30-1/32" (D) x 38-13/16" (H)<br>(895 mm (W) x 763 mm (D) x 986 mm (H)) |
| Weight                | Approx. 288 lbs (131 kg)   |

## Finisher (large stacker)

|   |  |  |
|---|--|--|
| Name  | Finisher (MX-FN21)   |  |
| Paper sizes   | Depends on feeder specifications   |  |
| Useable paper   | 13 lbs bond to 110 lbs cover (52 to 300 g/m <sup>2</sup> )   |  |
| No. of trays  | 3  |  |
| Tray capacity<br>(20 lbs (80 g/m <sup>2</sup> )) *            | Upper tray   | 12" x 18" (A3W) / 9" x 12" (A4W) / 11" x 17" (A3) / 8-1/2" x 14" (B4) / SRA3 / SRA4: 750 sheets<br>8-1/2" x 11" (A4) / 8-1/2" x 11"R (A4R, B5) / 7-1/4" x 10-1/2"R (B5R) / 5-1/2" x 8-1/2"R (A5R): 1,500 sheets  |
|   | Non-stapled  |  |
|   | Staple function  | 11" x 17" (A3) / 8-1/2" x 14" (B4): 50 units or 750 sheets<br>8-1/2" x 11" (A4) / 8-1/2" x 11"R (A4R, B5): 100 units or 1,500 sheets   |
|   | Center tray  |  |
|   | Non-stapled  | 12" x 18" (A3W) / 9" x 12" (A4W) / 11" x 17" (A3) / 8-1/2" x 14" (B4) / SRA3 / SRA4: 125 sheets<br>8-1/2" x 11" (A4) / 8-1/2" x 11"R (A4R, B5) / 7-1/4" x 10-1/2"R (B5R) / 5-1/2" x 8-1/2"R (A5R): 250 sheets  |
|   | Lower tray   |  |
|   | Non-stapled  | 12" x 18" (A3W) / 9" x 12" (A4W) / 11" x 17" (A3) / 8-1/2" x 14" (B4) / SRA3 / SRA4: 750 sheets<br>8-1/2" x 11" (A4) / 8-1/2" x 11"R (A4R, B5) / 7-1/4" x 10-1/2"R (B5R) / 5-1/2" x 8-1/2"R (A5R): 1,500 sheets<br>8-1/2" x 11" / A4/B5 Non offset: 2,500 sheets |
|   | Staple function  | 11" x 17" (A3) / 8-1/2" x 14" (B4): 50 units or 750 sheets<br>8-1/2" x 11" (A4) / 8-1/2" x 11"R (A4R, B5): 100 units or 1,500 sheets   |
| Max. no. of stapled sheets<br>(20 lbs (80 g/m <sup>2</sup> )) | Max. no. of 100 sheets (8-1/2" x 11" (A4), B5) (A3) / 8-1/2" x 14" (B4), 8-1/2" x 14" (B4), 8-1/2" x 11"R (A4R))   |  |
| Staple position   | 1 bottom, 1 top, 2 middle  |  |
| Required power supply   | AC 120V 60Hz   |  |
| Weight  | Approx. 134.5 lbs (61 kg)  |  |
| Dimensions  | When output paper tray is stored<br>25-3/4" (W) x 30-1/8" (D) x 40-15/16" (H)<br>(654 mm (W) x 765 mm (D) x 1040 mm (H))<br>When output paper tray is extended<br>30-51/64" (W) x 30-1/8" (D) x 40-15/16" (H)<br>(782 mm (W) x 765 mm (D) x 1040 mm (H)) |  |

\* Output capacity may vary depending on environmental conditions at the installation location, the type of paper used, and the storage condition of the paper.



## Saddle Stitch Finisher (large stacker)

|   |  |   |
|---|--|---|
| Name  | Saddle Stitch Finisher (MX-FN22)   |   |
| Paper sizes   | Depends on feeder specifications   |   |
| Useable paper   | 13 lbs bond to 110 lbs cover (52 to 300 g/m <sup>2</sup> )   |   |
| No. of trays  | 4  |   |
| Tray capacity<br>(20 lbs (80 g/m <sup>2</sup> )) *            | Upper tray   | 12" x 18" (A3W) / 9" x 12" (A4W) / 11" x 17" (A3) / 8-1/2" x 14" (B4) / SRA3 / SRA4: 750 sheets   |
|   | Non-stapled  | 8-1/2" x 11" (A4) / 8-1/2" x 11"R (A4R, B5) / 7-1/4" x 10-1/2"R (B5R) / 5-1/2" x 8-1/2"R (A5R): 1,500 sheets  |
|   | Staple function  | 11" x 17" (A3) / 8-1/2" x 14" (B4): 50 units or 750 sheets<br>8-1/2" x 11" (A4) / 8-1/2" x 11"R (A4R, B5): 100 units or 1,500 sheets  |
|   | Center tray  |   |
|   | Non-stapled  | 12" x 18" (A3W) / 9" x 12" (A4W) / 11" x 17" (A3) / 8-1/2" x 14" (B4) / SRA3 / SRA4: 125 sheets   |
|   |  | 8-1/2" x 11" (A4) / 8-1/2" x 11"R (A4R, B5) / 7-1/4" x 10-1/2"R (B5R) / 5-1/2" x 8-1/2"R (A5R): 250 sheets<br>(Offset output is not available)  |
|   | Lower tray   |   |
|   | Non-stapled  | 12" x 18" (A3W) / 9" x 12" (A4W) / 11" x 17" (A3) / 8-1/2" x 14" (B4) / SRA3 / SRA4: 750 sheets   |
|   |  | 8-1/2" x 11"R (A4R) / 7-1/4" x 10-1/2"R (B5R) / 5-1/2" x 8-1/2"R (A5R): 1,500 sheets  |
|   |  | 8-1/2" x 11" / (A4/B5): 2,500 sheets<br>(Offset output is not available)  |
|   | Staple function  | 11" x 17" (A3) / 8-1/2" x 14" (B4): 50 units or 750 sheets<br>8-1/2" x 11" (A4) / 8-1/2" x 11"R (A4R, B5): 100 units or 1,500 sheets  |
|   | Saddle stitch tray   |   |
|   | Non-stapled  | 16 lbs bond to 28 lbs bond (60 to 105 g/m <sup>2</sup> ): 5 sheets  |
|   | Staple function  | 16 lbs bond to 21 lbs bond (60 to 81.4 g/m <sup>2</sup> ): 5 units (16 to 20 sheets), 10 units (11 to 15 sheets), 15 units (6 to 10 sheets), 25 units (1 to 5 sheets)<br>21 lbs bond over to 28 lbs bond (81.4 g/m <sup>2</sup> over to 105 g/m <sup>2</sup> ): 15 units (6 to 10 sheets), 25 units (1 to 5 sheets) |
|   | Staple function<br>in cover mode   | 16 lbs bond to 21 lbs bond (60 to 81.4 g/m <sup>2</sup> ): 5 units (16 to 20 sheets), 10 units (1 to 15 sheets)<br>21 lbs bond over to 28 lbs bond (81.4 g/m <sup>2</sup> over to 105 g/m <sup>2</sup> ): 10 units (1 to 10 sheets)   |
|   |  | • Offset output is not available for 12" x 18" (A3W) / 7-1/4" x 10-1/2"R (B5R) / 5-1/2" x 8-1/2"R (A5R).  |
| Max. no. of stapled sheets<br>(20 lbs (80 g/m <sup>2</sup> )) | Max. no. of 100 sheets (8-1/2" x 11" (A4), B5)   | Max. no. of 50 sheets (11" x 17" (A3), 8-1/2" x 14" (B4), 8-1/2" x 11"R (A4R))  |
| Staple position   | 1 bottom, 1 top, 2 middle  |   |
| Staple method<br>(for saddle stitch)                          | Centered fold with stapling in 2 center places   |   |
| Saddle stitch<br>fold position                                | Centered fold  |   |
| Saddle usable<br>sizes  | 11" x 17" (A3) / 8-1/2" x 14" (B4) / 8-1/2" x 11"R (A4R) / 12" x 18" (A3W) / SRA3  |   |
| Saddle usable<br>paper weight                                 | 16 lbs bond (60 g/m <sup>2</sup> ) to 110 lbs cover (300 g/m <sup>2</sup> )<br>Paper weighting 28 lbs bond (106 g/m <sup>2</sup> ) to 110 lbs cover (300 g/m <sup>2</sup> ) is only able to be used in cover mode and for single sheet fold. |   |
| Max. no. of<br>saddle-stitched<br>sheets                      | Max. no. of 20 sheets (20 lbs (80 g/m <sup>2</sup> )): 19 sheets (20 lbs bond (80 g/m <sup>2</sup> )) + 1 sheet (140 lbs index (256 g/m <sup>2</sup> ))  |   |
| Required power<br>supply                                      | AC 120V 60Hz   |   |
| Weight  | Approx. 238.1 lbs (108 kg)   |   |

|            |                                    |  |
|------------|------------------------------------|--|
| Dimensions | When output paper tray is stored   | 30-13/64" (W) x 30-1/8" (D) x 40-15/16" (H)<br>(767 mm (W) x 765 mm (D) x 1040 mm (H)) |
|            | When output paper tray is extended | 35-9/32" (W) x 30-1/8" (D) x 40-15/16" (H)<br>(896 mm (W) x 765 mm (D) x 1040 mm (H))  |

\* Output capacity may vary depending on environmental conditions at the installation location, the type of paper used, and the storage condition of the paper.

## Punch Module

|                                |   |
|--------------------------------|---|
| Name                           | Punch module (MX-PN13B)   |
| Paper size for<br>punch module | 11" x 17" (A3) to 7-1/4" x 10-1/2"R (B5R)   |
| Holes                          | 2 holes / 3 holes (Auto select)   |
| Required power<br>supply       | Supplied from finisher/saddle stitch finisher                                       |
| Dimensions                     | 3-47/64" (W) x 28-5/32" (D) x 9-13/32" (H)<br>(95 mm (W) x 715 mm (D) x 392 mm (H)) |
| Weight                         | Approx. 8.6 lbs (3.7 kg)  |

## Relay Unit

|            |   |
|------------|---|
| Name       | Relay Unit (MX-RB13)  |
| Dimensions | 8-7/16" (W) x 29-59/64" (D) x 38-13/16" (H)<br>(214 mm (W) x 760 mm (D) x 986 mm (H)) |
| Weight     | Approx. 31 lbs (14 kg)  |

## Curl Correction Unit

|                          |   |
|--------------------------|---|
| Name                     | Curl Correction Unit (MX-RB18)  |
| Paper sizes              | Depends on feeder specifications  |
| Useable paper            | Depends on feeder specifications  |
| Required power<br>supply | Supplied from the machine   |
| Dimensions               | 8-7/16" (W) x 29-59/64" (D) x 38-13/16" (H)<br>(214 mm (W) x 760 mm (D) x 986 mm (H)) |
| Weight                   | Approx. 42 lbs (19 kg)  |

## Trimming Module

|  |   |
|--|---|
| Name                                   | Trimming module (MX-TM10)   |
| Useable size for<br>trimming<br>module | 12" x 18" (A3W), 11" x 17", 8-1/2" x 14", 8-1/2" x 13-1/2", 8-1/2" x 13-2/5", 8-1/2" x 13", 8-1/2" x 11"R, SRA3, A3, B4, A4R  |
| Max. no. of<br>sheets to be<br>trimmed | 2 to 20 sheets (16 lbs bond to 20 lbs bond (60 g/m <sup>2</sup> to 81.4 g/m <sup>2</sup> ))<br>2 to 10 sheets (21 lbs bond over to 28 lbs bond (81.4 g/m <sup>2</sup> over to 105 g/m <sup>2</sup> ))<br>2 to 3 sheets (28 lbs bond over to 80 lbs cover (105 g/m <sup>2</sup> over to 220 g/m <sup>2</sup> ))<br>When plain paper trimmed. Including one front cover of 110 lbs cover (300 g/m <sup>2</sup> ) or less. |
| Required power<br>supply               | Supplied from saddle stitch finisher  |
| Dimensions                             | 9-7/8" (W) x 24-15/32" (D) x 15-7/8" (H)<br>(251 mm (W) x 625 mm (D) x 403 mm (H))  |
| Weight                                 | Approx. 70.6 lbs (32 kg)  |



## Folding Unit

|   |  |
|---|--|
| Name  | Folding unit (MX-FD10)   |
| Folding types                                   | Z-Fold, C-Fold, Accordion Fold, Double Fold, Half Fold.  |
| Useable size for folding unit                   | Z-Fold: 11" x 17", 8-1/2" x 14", 8-1/2" x 11"R, A3, B4, A4R<br>C-Fold, Accordion Fold, Double Fold, Half Fold: 8-1/2" x 11"R, A4R  |
| Useable paper                                   | 13 lbs bond to 28 lbs bond (52 g/m <sup>2</sup> to 105 g/m <sup>2</sup> )  |
| Tray capacity (20 lbs (80 g/m <sup>2</sup> )) * | C-Fold/Accordion Fold/Double Fold<br>2-23/64" (60 mm) (Equivalent to 40 sheets. (Equivalent to 25 sheets for Double Fold))<br>Copies made in Z-Fold or Half Fold are output to the tray of the finisher (large stacker) or saddle stitch finisher (large stacker). |
| Required power supply                           | Supplied from finisher/saddle stitch finisher  |
| Dimensions                                      | 13-15/64" (W) x 31-15/64" (D) x 41-11/32" (H)<br>(336 mm (W) x 793 mm (D) x 1050 mm (H))   |
| Weight  | Approx. 145.5 lbs (66 kg)  |

## Inserter

|   |   |
|---|---|
| Name  | Inserter (MX-CF11)  |
| Useable size for inserter                       | 12" x 18" (A3W), 9" x 12" (A4W), 11" x 17", 8-1/2" x 14", 8-1/2" x 13-1/2", 8-1/2" x 13-2/5", 8-1/2" x 13", 8-1/2" x 11", 8-1/2" x 11"R, 7-1/4" x 10-1/2"R, 5-1/2" x 8-1/2"R, A3, B4, A4, A4R, B5, B5R, A5R, SRA3, SRA4 |
| Useable paper                                   | 16 lbs bond to 80 lbs cover (60 g/m <sup>2</sup> to 220 g/m <sup>2</sup> )  |
| No. of trays                                    | 2   |
| Tray capacity (20 lbs (80 g/m <sup>2</sup> )) * | Upper tray: 200 sheets<br>Lower tray: 200 sheets  |
| Required power supply                           | Supplied from the machine   |
| Dimensions                                      | 21-1/4" (W) x 29-7/8" (D) x 50-1/4" (H)<br>(540 mm (W) x 760 mm (D) x 1276 mm (H))  |
| Weight  | Approx. 99.2 lbs (45 kg)  |

## Network Printer Specifications

|                            |  |
|----------------------------|--|
| Type                       | Built-in type  |
| Continuous print speed     | Same as continuous copy speed  |
| Resolution                 | Data processing: 600 x 600 dpi, 1,200 x 1,200 dpi<br>Print: 600 x 600 dpi, 1,200 x 1,200 dpi<br>equivalent to 9600 dpi x 600 dpi   |
| Page description language* | PCL6 emulation, Adobe® PostScript®3™*1, XPS*2  |
| Compatible protocols       | TCP/IP (IPv4/IPv6), IPX/SPX, IPP, EtherTalk  |
| Compatible OS              | Windows 8.1, Windows 8.1x64, Windows 10, Windows 10x64, Windows Server 2012x64, Windows Server 2012 R2x64, Windows Server 2016x64, Windows Server 2019x64, Mac OS (10.9, 10.10, 10.11, 10.12, 10.13, 10.14, 10.15, 11) |
| Internal fonts             | 80 fonts for PCL, 139 fonts for Adobe® PostScript®3™*1   |
| Memory                     | Machine system memory and hard disk  |
| Interface                  | 10BASE-T/100BASE-TX/1000BASE-T<br>USB 2.0 (High-Speed mode)  |

\*1: There are cases when a connection cannot be established. Please contact your local dealer for more information.

\*2: XPS stands for XML Paper Specification. When equipped with the XPS expansion kit. (MX-PUX1) A memory (1 GB) is required.

## Network Scanner Specifications

|                                   |  |
|-----------------------------------|--|
| Type                              | Color scanner  |
| Scan resolution (main x vertical) | 100 x 100 dpi, 150 x 150 dpi, 200 x 200 dpi, 300 x 300 dpi, 400 x 400 dpi, 600 x 600 dpi (push scan)<br>50 to 9600 dpi *1 (pull scan)  |
| Scan speed (8-1/2" x 11" (A4))    | 120 sheets/minute (200 x 200 dpi) (one-sided),<br>240 pages/minute (200 x 200 dpi) (two-sided)<br>• When in standard mode using Sharp standard paper (8-1/2" x 11" (A4) size with 6% coverage) and the auto color detector is turned off. The speed varies depending on the data volume of the original.   |
| Interface                         | 10BASE-T/100BASE-TX/1000BASE-T,<br>USB 2.0 (when an external memory device is used)  |
| Compatible protocols              | TCP/IP   |
| Compatible OS *2                  | Pull scan (TWAIN), Windows 8.1, Windows 8.1x64, Windows 10, Windows 10x64, Windows Server 2012x64, Windows Server 2012 R2x64, Windows Server 2016x64, Windows Server 2019x64   |
| Output format                     | (B/W)<br>TIFF, PDF, PDF/A, encrypted PDF, XPS*3, Searchable PDF, Office file (pptx, xlsx, docx), TXT, UTF-8, RTF<br>Compression method: decompression, G3 (MH), G4 (MMR) (Gray scale/color)<br>Color TIFF, JPEG, PDF, PDF/A, encrypted PDF, high compression PDF, XPS*3, Searchable PDF, Office file (pptx, xlsx, docx), TXT, UTF-8, RTF<br>Compression method: JPEG (high, mid, and low compression), Emphasis black letter, high compression PDF |
| Driver                            | TWAIN compliant  |

\*1: You must decrease the scan size when increasing the resolution.

\*2: There are cases when a connection cannot be established. Please contact your local dealer for more information.

\*3: XPS stands for XML Paper Specification.



# LICENSE INFORMATION

## Information on the Software License for This Product

### Software composition

The software included in this product is comprised of various software components whose individual copyrights are held by SHARP or by third parties.

### Software developed by SHARP and open source software

The copyrights for the software components and various relevant documents included with this product that were developed or written by SHARP are owned by SHARP and are protected by the Copyright Act, international treaties, and other relevant laws. This product also makes use of freely distributed software and software components whose copyrights are held by third parties. These include software components covered by a GNU General Public License (hereafter GPL), a GNU Lesser General Public License (hereafter LGPL) or other license agreement.

### Obtaining source code

Some of the open source software licensors require the distributor to provide the source code with the executable software components. GPL and LGPL include similar requirements. For information on obtaining the source code for the open source software and for obtaining the GPL, LGPL, and other license agreement information, visit the following website:

<http://sharp-world.com/products/copier/source/download/index.html>

We are unable to answer any questions about the source code for the open source software. The source code for the software components whose copyrights are held by SHARP is not distributed.

## Software Copyrights

### Copyright (c) 2000 Carnegie Mellon University. All rights reserved.

Redistribution and use in source and binary forms, with or without modification, are permitted provided that the following conditions are met:

- 1.Redistributions of source code must retain the above copyright notice, this list of conditions and the following disclaimer.
- 2.Redistributions in binary form must reproduce the above copyright notice, this list of conditions and the following disclaimer in the documentation and/or other materials provided with the distribution.
- 3.The name "Carnegie Mellon University" must not be used to endorse or promote products derived from this software without prior written permission. For permission or any other legal details, please contact  
Office of Technology Transfer Carnegie Mellon University 5000 Forbes Avenue Pittsburgh, PA 15213-3890  
(412) 268-4387, fax: (412) 268-7395  
[tech-transfer@andrew.cmu.edu](mailto:tech-transfer@andrew.cmu.edu)
- 4.Redistributions of any form whatsoever must retain the following acknowledgment:  
"This product includes software developed by Computing Services at Carnegie Mellon University  
(<http://www.cmu.edu/computing/>)."

CARNEGIE MELLON UNIVERSITY DISCLAIMS ALL WARRANTIES WITH REGARD TO THIS SOFTWARE, INCLUDING ALL IMPLIED WARRANTIES OF MERCHANTABILITY AND FITNESS, IN NO EVENT SHALL CARNEGIE MELLON UNIVERSITY BE LIABLE FOR ANY SPECIAL, INDIRECT OR CONSEQUENTIAL DAMAGES OR ANY DAMAGES WHATSOEVER RESULTING FROM LOSS OF USE, DATA OR PROFITS, WHETHER IN AN ACTION OF CONTRACT, NEGLIGENCE OR OTHER TORTIOUS ACTION, ARISING OUT OF OR IN CONNECTION WITH THE USE OR PERFORMANCE OF THIS SOFTWARE.



**Copyright (c) 1995 - 2008 Kungliga Tekniska Högskolan (Royal Institute of Technology, Stockholm, Sweden). All rights reserved.**

All rights reserved. Export of this software from the United States of America may require a specific license from the United States Government. It is the responsibility of any person or organization contemplating export to obtain such a license before exporting.

WITHIN THAT CONSTRAINT, permission to use, copy, modify, and distribute this software and its documentation for any purpose and without fee is hereby granted, provided that the above copyright notice appear in all copies and that both that copyright notice and this permission notice appear in supporting documentation, and that the name of M.I.T. not be used in advertising or publicity pertaining to distribution of the software without specific, written prior permission. Furthermore if you modify this software you must label your software as modified software and not distribute it in such a fashion that it might be confused with the original MIT software. M.I.T. makes no representations about the suitability of this software for any purpose. It is provided "as is" without express or implied warranty.

THIS SOFTWARE IS PROVIDED "**AS IS**" AND WITHOUT ANY EXPRESS OR IMPLIED WARRANTIES, INCLUDING, WITHOUT LIMITATION, THE IMPLIED WARRANTIES OF MERCHANTABILITY AND FITNESS FOR A PARTICULAR PURPOSE.

Individual source code files are copyright MIT, Cygnus Support, OpenVision, Oracle, Sun Soft, FundsXpress, and others.

Project Athena, Athena, Athena MUSE, Discuss, Hesiod, Kerberos, Moira, and Zephyr are trademarks of the Massachusetts Institute of Technology (MIT). No commercial use of these trademarks may be made without prior written permission of MIT.

"Commercial use" means use of a name in a product or other for-profit manner. It does NOT prevent a commercial firm from referring to the MIT trademarks in order to convey information (although in doing so, recognition of their trademark status should be given).

OpenSSL License

-----

**Copyright (c) 1998-2004 The OpenSSL Project. All rights reserved.**

Redistribution and use in source and binary forms, with or without modification, are permitted provided that the following conditions are met:

- 1.Redistributions of source code must retain the above copyright notice, this list of conditions and the following disclaimer.
- 2.Redistributions in binary form must reproduce the above copyright notice, this list of conditions and the following disclaimer in the documentation and/or other materials provided with the distribution.
- 3.All advertising materials mentioning features or use of this software must display the following acknowledgment: "This product includes software developed by the OpenSSL Project for use in the OpenSSL Toolkit. (<http://www.openssl.org/>)"
- 4.The names "OpenSSL Toolkit" and "OpenSSL Project" must not be used to endorse or promote products derived from this software without prior written permission. For written permission, please contact [openssl-core@openssl.org](mailto:openssl-core@openssl.org).
- 5.Products derived from this software may not be called "OpenSSL" nor may "OpenSSL" appear in their names without prior written permission of the OpenSSL Project.
- 6.Redistributions of any form whatsoever must retain the following acknowledgment: "This product includes software developed by the OpenSSL Project for use in the OpenSSL Toolkit. (<http://www.openssl.org/>)"



THIS SOFTWARE IS PROVIDED BY THE OpenSSL PROJECT "AS IS" AND ANY EXPRESSED OR IMPLIED WARRANTIES, INCLUDING, BUT NOT LIMITED TO, THE IMPLIED WARRANTIES OF MERCHANTABILITY AND FITNESS FOR A PARTICULAR PURPOSE ARE DISCLAIMED. IN NO EVENT SHALL THE OpenSSL PROJECT OR ITS CONTRIBUTORS BE LIABLE FOR ANY DIRECT, INDIRECT, INCIDENTAL, SPECIAL, EXEMPLARY, OR CONSEQUENTIAL DAMAGES (INCLUDING, BUT NOT LIMITED TO, PROCUREMENT OF SUBSTITUTE GOODS OR SERVICES; LOSS OF USE, DATA, OR PROFITS; OR BUSINESS INTERRUPTION) HOWEVER CAUSED AND ON ANY THEORY OF LIABILITY, WHETHER IN CONTRACT, STRICT LIABILITY, OR TORT (INCLUDING NEGLIGENCE OR OTHERWISE) ARISING IN ANY WAY OUT OF THE USE OF THIS SOFTWARE, EVEN IF ADVISED OF THE POSSIBILITY OF SUCH DAMAGE.

This product includes cryptographic software written by Eric Young ([eyay@cryptsoft.com](mailto:eyay@cryptsoft.com)). This product includes software written by Tim Hudson ([tjh@cryptsoft.com](mailto:tjh@cryptsoft.com)).

Original SSLeay License  
-----

**Copyright (C) 1995-1998 Eric Young ([eyay@cryptsoft.com](mailto:eyay@cryptsoft.com)) All rights reserved.**

This package is an SSL implementation written by Eric Young ([eyay@cryptsoft.com](mailto:eyay@cryptsoft.com)). The implementation was written so as to conform with Netscapes SSL.

This library is free for commercial and non-commercial use as long as the following conditions are aheared to. The following conditions apply to all code found in this distribution, be it the RC4, RSA, lhash, DES, etc., code; not just the SSL code. The SSL documentation included with this distribution is covered by the same copyright terms except that the holder is Tim Hudson ([tjh@cryptsoft.com](mailto:tjh@cryptsoft.com)).

Copyright remains Eric Young's, and as such any Copyright notices in the code are not to be removed. If this package is used in a product, Eric Young should be given attribution as the author of the parts of the library used. This can be in the form of a textual message at program startup or in documentation (online or textual) provided with the package.

Redistribution and use in source and binary forms, with or without modification, are permitted provided that the following conditions are met:

- 1.Redistributions of source code must retain the copyright notice, this list of conditions and the following disclaimer.
- 2.Redistributions in binary form must reproduce the above copyright notice, this list of conditions and the following disclaimer in the documentation and/or other materials provided with the distribution.
- 3.All advertising materials mentioning features or use of this software must display the following acknowledgement:  
"This product includes cryptographic software written by Eric Young ([eyay@cryptsoft.com](mailto:eyay@cryptsoft.com))" The word 'cryptographic' can be left out if the rouines from the library being used are not cryptographic related :-).
- 4.If you include any Windows specific code (or a derivative thereof) from the apps directory (application code) you must include an acknowledgement: "This product includes software written by Tim Hudson ([tjh@cryptsoft.com](mailto:tjh@cryptsoft.com))"

THIS SOFTWARE IS PROVIDED BY ERIC YOUNG "AS IS" AND ANY EXPRESS OR IMPLIED WARRANTIES, INCLUDING, BUT NOT LIMITED TO, THE IMPLIED WARRANTIES OF MERCHANTABILITY AND FITNESS FOR A PARTICULAR PURPOSE ARE DISCLAIMED. IN NO EVENT SHALL THE AUTHOR OR CONTRIBUTORS BE LIABLE FOR ANY DIRECT, INDIRECT, INCIDENTAL, SPECIAL, EXEMPLARY, OR CONSEQUENTIAL DAMAGES (INCLUDING, BUT NOT LIMITED TO, PROCUREMENT OF SUBSTITUTE GOODS OR SERVICES; LOSS OF USE, DATA, OR PROFITS; OR BUSINESS INTERRUPTION) HOWEVER CAUSED AND ON ANY THEORY OF LIABILITY, WHETHER IN CONTRACT, STRICT LIABILITY, OR TORT (INCLUDING NEGLIGENCE OR OTHERWISE) ARISING IN ANY WAY OUT OF THE USE OF THIS SOFTWARE, EVEN IF ADVISED OF THE POSSIBILITY OF SUCH DAMAGE.





The licence and distribution terms for any publically available version orderivative of this code cannot be changed. i.e. this code cannot simply becoped and put under another distribution licence [including the GNU Public Licence.]

D3DES License  
-----

**Copyright (c) 1988,1989,1990,1991,1992 by Richard Outerbridge. (GEnie : OUTER; CIS : [71755,204]) Graven Imagery, 1992.**

**GNU GENERAL PUBLIC LICENSE  
Version 2, June 1991**

Copyright (C) 1989, 1991 Free Software Foundation, Inc., 51 Franklin Street, Fifth Floor, Boston, MA 02110-1301 USA Everyone is permitted to copy and distribute verbatim copies of this license document, but changing it is not allowed.

Preamble

The licenses for most software are designed to take away your freedom to share and change it. By contrast, the GNU General Public License is intended to guarantee your freedom to share and change free software--to make sure the software is free for all its users. This General Public License applies to most of the Free Software Foundation's software and to any other program whose authors commit to using it. (Some other Free Software Foundation software is covered by the GNU Lesser General Public License instead.) You can apply it to your programs, too.

When we speak of free software, we are referring to freedom, not price. Our General Public Licenses are designed to make sure that you have the freedom to distribute copies of free software (and charge for this service if you wish), that you receive source code or can get it if you want it, that you can change the software or use pieces of it in new free programs; and that you know you can do these things.

To protect your rights, we need to make restrictions that forbid anyone to deny you these rights or to ask you to surrender the rights. These restrictions translate to certain responsibilities for you if you distribute copies of the software, or if you modify it.

For example, if you distribute copies of such a program, whether gratis or for a fee, you must give the recipients all the rights that you have. You must make sure that they, too, receive or can get the source code. And you must show them these terms so they know their rights.

We protect your rights with two steps: (1) copyright the software, and (2) offer you this license which gives you legal permission to copy, distribute and/or modify the software.

Also, for each author's protection and ours, we want to make certain that everyone understands that there is no warranty for this free software. If the software is modified by someone else and passed on, we want its recipients to know that what they have is not the original, so that any problems introduced by others will not reflect on the original authors' reputations.



Finally, any free program is threatened constantly by software patents. We wish to avoid the danger that redistributors of a free program will individually obtain patent licenses, in effect making the program proprietary. To prevent this, we have made it clear that any patent must be licensed for everyone's free use or not licensed at all.

The precise terms and conditions for copying, distribution and modification follow.

### GNU GENERAL PUBLIC LICENSE TERMS AND CONDITIONS FOR COPYING, DISTRIBUTION AND MODIFICATION

0. This License applies to any program or other work which contains a notice placed by the copyright holder saying it may be distributed under the terms of this General Public License. The "Program", below, refers to any such program or work, and a "work based on the Program" means either the Program or any derivative work under copyright law: that is to say, a work containing the Program or a portion of it, either verbatim or with modifications and/or translated into another language. (Hereinafter, translation is included without limitation in the term "modification".) Each licensee is addressed as "you".

Activities other than copying, distribution and modification are not covered by this License; they are outside its scope. The act of running the Program is not restricted, and the output from the Program is covered only if its contents constitute a work based on the Program (independent of having been made by running the Program). Whether that is true depends on what the Program does.

1. You may copy and distribute verbatim copies of the Program's source code as you receive it, in any medium, provided that you conspicuously and appropriately publish on each copy an appropriate copyright notice and disclaimer of warranty; keep intact all the notices that refer to this License and to the absence of any warranty; and give any other recipients of the Program a copy of this License along with the Program.

You may charge a fee for the physical act of transferring a copy, and you may at your option offer warranty protection in exchange for a fee.

2. You may modify your copy or copies of the Program or any portion of it, thus forming a work based on the Program, and copy and distribute such modifications or work under the terms of Section 1 above, provided that you also meet all of these conditions:

- a) You must cause the modified files to carry prominent notices stating that you changed the files and the date of any change.
- b) You must cause any work that you distribute or publish, that in whole or in part contains or is derived from the Program or any part thereof, to be licensed as a whole at no charge to all third parties under the terms of this License.
- c) If the modified program normally reads commands interactively when run, you must cause it, when started running for such interactive use in the most ordinary way, to print or display an announcement including an appropriate copyright notice and a notice that there is no warranty (or else, saying that you provide a warranty) and that users may redistribute the program under these conditions, and telling the user how to view a copy of this License. (Exception: if the Program itself is interactive but does not normally print such an announcement, your work based on the Program is not required to print an announcement.)

These requirements apply to the modified work as a whole. If identifiable sections of that work are not derived from the Program, and can be reasonably considered independent and separate works in themselves, then this License, and its





terms, do not apply to those sections when you distribute them as separate works. But when you distribute the same sections as part of a whole which is a work based on the Program, the distribution of the whole must be on the terms of this License, whose permissions for other licensees extend to the entire whole, and thus to each and every part regardless of who wrote it.

Thus, it is not the intent of this section to claim rights or contest your rights to work written entirely by you; rather, the intent is to exercise the right to control the distribution of derivative or collective works based on the Program.

In addition, mere aggregation of another work not based on the Program with the Program (or with a work based on the Program) on a volume of a storage or distribution medium does not bring the other work under the scope of this License.

3. You may copy and distribute the Program (or a work based on it, under Section 2) in object code or executable form under the terms of Sections 1 and 2 above provided that you also do one of the following:

- a) Accompany it with the complete corresponding machine-readable source code, which must be distributed under the terms of Sections 1 and 2 above on a medium customarily used for software interchange; or,
- b) Accompany it with a written offer, valid for at least three years, to give any third party, for a charge no more than your cost of physically performing source distribution, a complete machine-readable copy of the corresponding source code, to be distributed under the terms of Sections 1 and 2 above on a medium customarily used for software interchange; or,
- c) Accompany it with the information you received as to the offer to distribute corresponding source code. (This alternative is allowed only for noncommercial distribution and only if you received the program in object code or executable form with such an offer, in accord with Subsection b above.)

The source code for a work means the preferred form of the work for making modifications to it. For an executable work, complete source code means all the source code for all modules it contains, plus any associated interface definition files, plus the scripts used to control compilation and installation of the executable. However, as a special exception, the source code distributed need not include anything that is normally distributed (in either source or binary form) with the major components (compiler, kernel, and so on) of the operating system on which the executable runs, unless that component itself accompanies the executable.

If distribution of executable or object code is made by offering access to copy from a designated place, then offering equivalent access to copy the source code from the same place counts as distribution of the source code, even though third parties are not compelled to copy the source along with the object code.

4. You may not copy, modify, sublicense, or distribute the Program except as expressly provided under this License. Any attempt otherwise to copy, modify, sublicense or distribute the Program is void, and will automatically terminate your rights under this License. However, parties who have received copies, or rights, from you under this License will not have their licenses terminated so long as such parties remain in full compliance.

5. You are not required to accept this License, since you have not signed it. However, nothing else grants you permission to modify or distribute the Program or its derivative works. These actions are prohibited by law if you do not accept this License. Therefore, by modifying or distributing the Program (or any work based on the Program), you indicate your acceptance of this License to do so, and all its terms and conditions for copying, distributing or modifying the Program or works based on it.



6. Each time you redistribute the Program (or any work based on the Program), the recipient automatically receives a license from the original licensor to copy, distribute or modify the Program subject to these terms and conditions. You may not impose any further restrictions on the recipients' exercise of the rights granted herein. You are not responsible for enforcing compliance by third parties to this License.

7. If, as a consequence of a court judgment or allegation of patent infringement or for any other reason (not limited to patent issues), conditions are imposed on you (whether by court order, agreement or otherwise) that contradict the conditions of this License, they do not excuse you from the conditions of this License. If you cannot distribute so as to satisfy simultaneously your obligations under this License and any other pertinent obligations, then as a consequence you may not distribute the Program at all. For example, if a patent license would not permit royalty-free redistribution of the Program by all those who receive copies directly or indirectly through you, then the only way you could satisfy both it and this License would be to refrain entirely from distribution of the Program.

If any portion of this section is held invalid or unenforceable under any particular circumstance, the balance of the section is intended to apply and the section as a whole is intended to apply in other circumstances.

It is not the purpose of this section to induce you to infringe any patents or other property right claims or to contest validity of any such claims; this section has the sole purpose of protecting the integrity of the free software distribution system, which is implemented by public license practices. Many people have made generous contributions to the wide range of software distributed through that system in reliance on consistent application of that system; it is up to the author/donor to decide if he or she is willing to distribute software through any other system and a licensee cannot impose that choice.

This section is intended to make thoroughly clear what is believed to be a consequence of the rest of this License.

8. If the distribution and/or use of the Program is restricted in certain countries either by patents or by copyrighted interfaces, the original copyright holder who places the Program under this License may add an explicit geographical distribution limitation excluding those countries, so that distribution is permitted only in or among countries not thus excluded. In such case, this License incorporates the limitation as if written in the body of this License.

9. The Free Software Foundation may publish revised and/or new versions of the General Public License from time to time. Such new versions will be similar in spirit to the present version, but may differ in detail to address new problems or concerns.

Each version is given a distinguishing version number. If the Program specifies a version number of this License which applies to it and "any later version", you have the option of following the terms and conditions either of that version or of any later version published by the Free Software Foundation. If the Program does not specify a version number of this License, you may choose any version ever published by the Free Software Foundation.

10. If you wish to incorporate parts of the Program into other free programs whose distribution conditions are different, write to the author to ask for permission. For software which is copyrighted by the Free Software Foundation, write to the Free Software Foundation; we sometimes make exceptions for this. Our decision will be guided by the two goals of preserving the free status of all derivatives of our free software and of promoting the sharing and reuse of software generally.

### NO WARRANTY

11. BECAUSE THE PROGRAM IS LICENSED FREE OF CHARGE, THERE IS NO WARRANTY FOR THE PROGRAM, TO THE EXTENT PERMITTED BY APPLICABLE LAW. EXCEPT WHEN OTHERWISE STATED IN



WRITING THE COPYRIGHT HOLDERS AND/OR OTHER PARTIES PROVIDE THE PROGRAM "AS IS" WITHOUT WARRANTY OF ANY KIND, EITHER EXPRESSED OR IMPLIED, INCLUDING, BUT NOT LIMITED TO, THE IMPLIED WARRANTIES OF MERCHANTABILITY AND FITNESS FOR A PARTICULAR PURPOSE. THE ENTIRE RISK AS TO THE QUALITY AND PERFORMANCE OF THE PROGRAM IS WITH YOU. SHOULD THE PROGRAM PROVE DEFECTIVE, YOU ASSUME THE COST OF ALL NECESSARY SERVICING, REPAIR OR CORRECTION.

12. IN NO EVENT UNLESS REQUIRED BY APPLICABLE LAW OR AGREED TO IN WRITING WILL ANY COPYRIGHT HOLDER, OR ANY OTHER PARTY WHO MAY MODIFY AND/OR REDISTRIBUTE THE PROGRAM AS PERMITTED ABOVE, BE LIABLE TO YOU FOR DAMAGES, INCLUDING ANY GENERAL, SPECIAL, INCIDENTAL OR CONSEQUENTIAL DAMAGES ARISING OUT OF THE USE OR INABILITY TO USE THE PROGRAM (INCLUDING BUT NOT LIMITED TO LOSS OF DATA OR DATA BEING RENDERED INACCURATE OR LOSSES SUSTAINED BY YOU OR THIRD PARTIES OR A FAILURE OF THE PROGRAM TO OPERATE WITH ANY OTHER PROGRAMS), EVEN IF SUCH HOLDER OR OTHER PARTY HAS BEEN ADVISED OF THE POSSIBILITY OF SUCH DAMAGES.

### END OF TERMS AND CONDITIONS

#### How to Apply These Terms to Your New Programs

If you develop a new program, and you want it to be of the greatest possible use to the public, the best way to achieve this is to make it free software which everyone can redistribute and change under these terms.

To do so, attach the following notices to the program. It is safest to attach them to the start of each source file to most effectively convey the exclusion of warranty; and each file should have at least the "copyright" line and a pointer to where the full notice is found.

<one line to give the program's name and a brief idea of what it does.> Copyright (C) <year> <name of author>

This program is free software; you can redistribute it and/or modify it under the terms of the GNU General Public License as published by the Free Software Foundation; either version 2 of the License, or (at your option) any later version.

This program is distributed in the hope that it will be useful, but WITHOUT ANY WARRANTY; without even the implied warranty of MERCHANTABILITY or FITNESS FOR A PARTICULAR PURPOSE. See the GNU General Public License for more details.

You should have received a copy of the GNU General Public License along with this program; if not, write to the Free Software Foundation, Inc., 51 Franklin Street, Fifth Floor, Boston, MA 02110-1301 USA.

Also add information on how to contact you by electronic and paper mail.

If the program is interactive, make it output a short notice like this when it starts in an interactive mode:

Gnomovision version 69, Copyright (C) year name of author Gnomovision comes with ABSOLUTELY NO WARRANTY; for details type `show w'. This is free software, and you are welcome to redistribute it under certain conditions; type `show c' for details.



The hypothetical commands ``show w'` and ``show c'` should show the appropriate parts of the General Public License. Of course, the commands you use may be called something other than ``show w'` and ``show c'`; they could even be mouse-clicks or menu items--whatever suits your program.

You should also get your employer (if you work as a programmer) or your school, if any, to sign a "copyright disclaimer" for the program, if necessary. Here is a sample; alter the names:

Yoyodyne, Inc., hereby disclaims all copyright interest in the program ``Gnomovision'` (which makes passes at compilers) written by James Hacker.

<signature of Ty Coon>, 1 April 1989  
Ty Coon, President of Vice

This General Public License does not permit incorporating your program into proprietary programs. If your program is a subroutine library, you may consider it more useful to permit linking proprietary applications with the library. If this is what you want to do, use the GNU Lesser General Public License instead of this License.

## **GNU LESSER GENERAL PUBLIC LICENSE**

### **Version 2.1, February 1999**

Copyright (C) 1991, 1999 Free Software Foundation, Inc. 51 Franklin Street, Fifth Floor, Boston, MA 02110-1301 USA Everyone is permitted to copy and distribute verbatim copies of this license document, but changing it is not allowed.

[This is the first released version of the Lesser GPL. It also counts as the successor of the GNU Library Public License, version 2, hence the version number 2.1.]

#### Preamble

The licenses for most software are designed to take away your freedom to share and change it. By contrast, the GNU General Public Licenses are intended to guarantee your freedom to share and change free software--to make sure the software is free for all its users.

This license, the Lesser General Public License, applies to some specially designated software packages--typically libraries--of the Free Software Foundation and other authors who decide to use it. You can use it too, but we suggest you first think carefully about whether this license or the ordinary General Public License is the better strategy to use in any particular case, based on the explanations below.

When we speak of free software, we are referring to freedom of use, not price. Our General Public Licenses are designed to make sure that you have the freedom to distribute copies of free software (and charge for this service if you wish); that you receive source code or can get it if you want it; that you can change the software and use pieces of it in new free programs; and that you are informed that you can do these things.

To protect your rights, we need to make restrictions that forbid distributors to deny you these rights or to ask you to surrender these rights. These restrictions translate to certain responsibilities for you if you distribute copies of the library or if you modify it.



For example, if you distribute copies of the library, whether gratis or for a fee, you must give the recipients all the rights that we gave you. You must make sure that they, too, receive or can get the source code. If you link other code with the library, you must provide complete object files to the recipients, so that they can relink them with the library after making changes to the library and recompiling it. And you must show them these terms so they know their rights.

We protect your rights with a two-step method: (1) we copyright the library, and (2) we offer you this license, which gives you legal permission to copy, distribute and/or modify the library.

To protect each distributor, we want to make it very clear that there is no warranty for the free library. Also, if the library is modified by someone else and passed on, the recipients should know that what they have is not the original version, so that the original author's reputation will not be affected by problems that might be introduced by others.

Finally, software patents pose a constant threat to the existence of any free program. We wish to make sure that a company cannot effectively restrict the users of a free program by obtaining a restrictive license from a patent holder. Therefore, we insist that any patent license obtained for a version of the library must be consistent with the full freedom of use specified in this license.

Most GNU software, including some libraries, is covered by the ordinary GNU General Public License. This license, the GNU Lesser General Public License, applies to certain designated libraries, and is quite different from the ordinary General Public License. We use this license for certain libraries in order to permit linking those libraries into non-free programs.

When a program is linked with a library, whether statically or using a shared library, the combination of the two is legally speaking a combined work, a derivative of the original library. The ordinary General Public License therefore permits such linking only if the entire combination fits its criteria of freedom. The Lesser General Public License permits more lax criteria for linking other code with the library.

We call this license the "Lesser" General Public License because it does Less to protect the user's freedom than the ordinary General Public License. It also provides other free software developers Less of an advantage over competing non-free programs. These disadvantages are the reason we use the ordinary General Public License for many libraries. However, the Lesser license provides advantages in certain special circumstances.

For example, on rare occasions, there may be a special need to encourage the widest possible use of a certain library, so that it becomes a de-facto standard. To achieve this, non-free programs must be allowed to use the library. A more frequent case is that a free library does the same job as widely used non-free libraries. In this case, there is little to gain by limiting the free library to free software only, so we use the Lesser General Public License.

In other cases, permission to use a particular library in non-free programs enables a greater number of people to use a large body of free software. For example, permission to use the GNU C Library in non-free programs enables many more people to use the whole GNU operating system, as well as its variant, the GNU/Linux operating system.



Although the Lesser General Public License is Less protective of the users' freedom, it does ensure that the user of a program that is linked with the Library has the freedom and the wherewithal to run that program using a modified version of the Library.

The precise terms and conditions for copying, distribution and modification follow. Pay close attention to the difference between a "work based on the library" and a "work that uses the library". The former contains code derived from the library, whereas the latter must be combined with the library in order to run.

### GNU LESSER GENERAL PUBLIC LICENSE TERMS AND CONDITIONS FOR COPYING, DISTRIBUTION AND MODIFICATION

0. This License Agreement applies to any software library or other program which contains a notice placed by the copyright holder or other authorized party saying it may be distributed under the terms of this Lesser General Public License (also called "this License"). Each licensee is addressed as "you".

A "library" means a collection of software functions and/or data prepared so as to be conveniently linked with application programs (which use some of those functions and data) to form executables.

The "Library", below, refers to any such software library or work which has been distributed under these terms. A "work based on the Library" means either the Library or any derivative work under copyright law: that is to say, a work containing the Library or a portion of it, either verbatim or with modifications and/or translated straightforwardly into another language. (Hereinafter, translation is included without limitation in the term "modification".)

"Source code" for a work means the preferred form of the work for making modifications to it. For a library, complete source code means all the source code for all modules it contains, plus any associated interface definition files, plus the scripts used to control compilation and installation of the library.

Activities other than copying, distribution and modification are not covered by this License; they are outside its scope. The act of running a program using the Library is not restricted, and output from such a program is covered only if its contents constitute a work based on the Library (independent of the use of the Library in a tool for writing it). Whether that is true depends on what the Library does and what the program that uses the Library does.

1. You may copy and distribute verbatim copies of the Library's complete source code as you receive it, in any medium, provided that you conspicuously and appropriately publish on each copy an appropriate copyright notice and disclaimer of warranty; keep intact all the notices that refer to this License and to the absence of any warranty; and distribute a copy of this License along with the Library.

You may charge a fee for the physical act of transferring a copy, and you may at your option offer warranty protection in exchange for a fee.

2. You may modify your copy or copies of the Library or any portion of it, thus forming a work based on the Library, and copy and distribute such modifications or work under the terms of Section 1 above, provided that you also meet all of these conditions:



- a) The modified work must itself be a software library.
- b) You must cause the files modified to carry prominent notices stating that you changed the files and the date of any change.
- c) You must cause the whole of the work to be licensed at no charge to all third parties under the terms of this License.
- d) If a facility in the modified Library refers to a function or a table of data to be supplied by an application program that uses the facility, other than as an argument passed when the facility is invoked, then you must make a good faith effort to ensure that, in the event an application does not supply such function or table, the facility still operates, and performs whatever part of its purpose remains meaningful.

(For example, a function in a library to compute square roots has a purpose that is entirely well-defined independent of the application. Therefore, Subsection 2d requires that any application-supplied function or table used by this function must be optional: if the application does not supply it, the square root function must still compute square roots.)

These requirements apply to the modified work as a whole. If identifiable sections of that work are not derived from the Library, and can be reasonably considered independent and separate works in themselves, then this License, and its terms, do not apply to those sections when you distribute them as separate works. But when you distribute the same sections as part of a whole which is a work based on the Library, the distribution of the whole must be on the terms of this License, whose permissions for other licensees extend to the entire whole, and thus to each and every part regardless of who wrote it.

Thus, it is not the intent of this section to claim rights or contest your rights to work written entirely by you; rather, the intent is to exercise the right to control the distribution of derivative or collective works based on the Library.

In addition, mere aggregation of another work not based on the Library with the Library (or with a work based on the Library) on a volume of a storage or distribution medium does not bring the other work under the scope of this License.

3. You may opt to apply the terms of the ordinary GNU General Public License instead of this License to a given copy of the Library. To do this, you must alter all the notices that refer to this License, so that they refer to the ordinary GNU General Public License, version 2, instead of to this License. (If a newer version than version 2 of the ordinary GNU General Public License has appeared, then you can specify that version instead if you wish.) Do not make any other change in these notices.

Once this change is made in a given copy, it is irreversible for that copy, so the ordinary GNU General Public License applies to all subsequent copies and derivative works made from that copy.

This option is useful when you wish to copy part of the code of the Library into a program that is not a library.

4. You may copy and distribute the Library (or a portion or derivative of it, under Section 2) in object code or executable form under the terms of Sections 1 and 2 above provided that you accompany it with the complete corresponding machine-readable source code, which must be distributed under the terms of Sections 1 and 2 above on a medium customarily used for software interchange.





If distribution of object code is made by offering access to copy from a designated place, then offering equivalent access to copy the source code from the same place satisfies the requirement to distribute the source code, even though third parties are not compelled to copy the source along with the object code.

5. A program that contains no derivative of any portion of the Library, but is designed to work with the Library by being compiled or linked with it, is called a "work that uses the Library". Such a work, in isolation, is not a derivative work of the Library, and therefore falls outside the scope of this License.

However, linking a "work that uses the Library" with the Library creates an executable that is a derivative of the Library (because it contains portions of the Library), rather than a "work that uses the library". The executable is therefore covered by this License. Section 6 states terms for distribution of such executables.

When a "work that uses the Library" uses material from a header file that is part of the Library, the object code for the work may be a derivative work of the Library even though the source code is not. Whether this is true is especially significant if the work can be linked without the Library, or if the work is itself a library. The threshold for this to be true is not precisely defined by law.

If such an object file uses only numerical parameters, data structure layouts and accessors, and small macros and small inline functions (ten lines or less in length), then the use of the object file is unrestricted, regardless of whether it is legally a derivative work. (Executables containing this object code plus portions of the Library will still fall under Section 6.)

Otherwise, if the work is a derivative of the Library, you may distribute the object code for the work under the terms of Section 6. Any executables containing that work also fall under Section 6, whether or not they are linked directly with the Library itself.

6. As an exception to the Sections above, you may also combine or link a "work that uses the Library" with the Library to produce a work containing portions of the Library, and distribute that work under terms of your choice, provided that the terms permit modification of the work for the customer's own use and reverse engineering for debugging such modifications.

You must give prominent notice with each copy of the work that the Library is used in it and that the Library and its use are covered by this License. You must supply a copy of this License. If the work during execution displays copyright notices, you must include the copyright notice for the Library among them, as well as a reference directing the user to the copy of this License. Also, you must do one of these things:

a) Accompany the work with the complete corresponding machine-readable source code for the Library including whatever changes were used in the work (which must be distributed under Sections 1 and 2 above); and, if the work is an executable linked with the Library, with the complete machine-readable "work that uses the Library", as object code and/or source code, so that the user can modify the Library and then relink to produce a modified executable containing the modified Library. (It is understood that the user who changes the contents of definitions files in the Library will not necessarily be able to recompile the application to use the modified definitions.)

b) Use a suitable shared library mechanism for linking with the Library. A suitable mechanism is one that (1) uses at run time a copy of the library already present on the user's computer system, rather than copying library functions into





the executable, and (2) will operate properly with a modified version of the library, if the user installs one, as long as the modified version is interface-compatible with the version that the work was made with.

c) Accompany the work with a written offer, valid for at least three years, to give the same user the materials specified in Subsection 6a, above, for a charge no more than the cost of performing this distribution.

d) If distribution of the work is made by offering access to copy from a designated place, offer equivalent access to copy the above specified materials from the same place.

e) Verify that the user has already received a copy of these materials or that you have already sent this user a copy.

For an executable, the required form of the "work that uses the Library" must include any data and utility programs needed for reproducing the executable from it. However, as a special exception, the materials to be distributed need not include anything that is normally distributed (in either source or binary form) with the major components (compiler, kernel, and so on) of the operating system on which the executable runs, unless that component itself accompanies the executable.

It may happen that this requirement contradicts the license restrictions of other proprietary libraries that do not normally accompany the operating system. Such a contradiction means you cannot use both them and the Library together in an executable that you distribute.

7. You may place library facilities that are a work based on the Library side-by-side in a single library together with other library facilities not covered by this License, and distribute such a combined library, provided that the separate distribution of the work based on the Library and of the other library facilities is otherwise permitted, and provided that you do these two things:

a) Accompany the combined library with a copy of the same work based on the Library, uncombined with any other library facilities. This must be distributed under the terms of the Sections above.

b) Give prominent notice with the combined library of the fact that part of it is a work based on the Library, and explaining where to find the accompanying uncombined form of the same work.

8. You may not copy, modify, sublicense, link with, or distribute the Library except as expressly provided under this License. Any attempt otherwise to copy, modify, sublicense, link with, or distribute the Library is void, and will automatically terminate your rights under this License. However, parties who have received copies, or rights, from you under this License will not have their licenses terminated so long as such parties remain in full compliance.

9. You are not required to accept this License, since you have not signed it. However, nothing else grants you permission to modify or distribute the Library or its derivative works. These actions are prohibited by law if you do not accept this License. Therefore, by modifying or distributing the Library (or any work based on the Library), you indicate your acceptance of this License to do so, and all its terms and conditions for copying, distributing or modifying the Library or works based on it.

10. Each time you redistribute the Library (or any work based on the Library), the recipient automatically receives a license from the original licensor to copy, distribute, link with or modify the Library subject to these terms and conditions. You may not impose any further restrictions on the recipients' exercise of the rights granted herein. You are not responsible for enforcing compliance by third parties with this License.



11. If, as a consequence of a court judgment or allegation of patent infringement or for any other reason (not limited to patent issues), conditions are imposed on you (whether by court order, agreement or otherwise) that contradict the conditions of this License, they do not excuse you from the conditions of this License. If you cannot distribute so as to satisfy simultaneously your obligations under this License and any other pertinent obligations, then as a consequence you may not distribute the Library at all. For example, if a patent license would not permit royalty-free redistribution of the Library by all those who receive copies directly or indirectly through you, then the only way you could satisfy both it and this License would be to refrain entirely from distribution of the Library.

If any portion of this section is held invalid or unenforceable under any particular circumstance, the balance of the section is intended to apply, and the section as a whole is intended to apply in other circumstances.

It is not the purpose of this section to induce you to infringe any patents or other property right claims or to contest validity of any such claims; this section has the sole purpose of protecting the integrity of the free software distribution system which is implemented by public license practices. Many people have made generous contributions to the wide range of software distributed through that system in reliance on consistent application of that system; it is up to the author/donor to decide if he or she is willing to distribute software through any other system and a licensee cannot impose that choice.

This section is intended to make thoroughly clear what is believed to be a consequence of the rest of this License.

12. If the distribution and/or use of the Library is restricted in certain countries either by patents or by copyrighted interfaces, the original copyright holder who places the Library under this License may add an explicit geographical distribution limitation excluding those countries, so that distribution is permitted only in or among countries not thus excluded. In such case, this License incorporates the limitation as if written in the body of this License.

13. The Free Software Foundation may publish revised and/or new versions of the Lesser General Public License from time to time. Such new versions will be similar in spirit to the present version, but may differ in detail to address new problems or concerns.

Each version is given a distinguishing version number. If the Library specifies a version number of this License which applies to it and "any later version", you have the option of following the terms and conditions either of that version or of any later version published by the Free Software Foundation. If the Library does not specify a license version number, you may choose any version ever published by the Free Software Foundation.

14. If you wish to incorporate parts of the Library into other free programs whose distribution conditions are incompatible with these, write to the author to ask for permission. For software which is copyrighted by the Free Software Foundation, write to the Free Software Foundation; we sometimes make exceptions for this. Our decision will be guided by the two goals of preserving the free status of all derivatives of our free software and of promoting the sharing and reuse of software generally.

### NO WARRANTY

15. BECAUSE THE LIBRARY IS LICENSED FREE OF CHARGE, THERE IS NO WARRANTY FOR THE LIBRARY, TO THE EXTENT PERMITTED BY APPLICABLE LAW. EXCEPT WHEN OTHERWISE STATED IN WRITING THE COPYRIGHT HOLDERS AND/OR OTHER PARTIES PROVIDE THE LIBRARY "AS IS" WITHOUT WARRANTY OF ANY KIND, EITHER EXPRESSED OR IMPLIED, INCLUDING, BUT NOT LIMITED TO, THE IMPLIED WARRANTIES



OF MERCHANTABILITY AND FITNESS FOR A PARTICULAR PURPOSE. THE ENTIRE RISK AS TO THE QUALITY AND PERFORMANCE OF THE LIBRARY IS WITH YOU. SHOULD THE LIBRARY PROVE DEFECTIVE, YOU ASSUME THE COST OF ALL NECESSARY SERVICING, REPAIR OR CORRECTION.

16. IN NO EVENT UNLESS REQUIRED BY APPLICABLE LAW OR AGREED TO IN WRITING WILL ANY COPYRIGHT HOLDER, OR ANY OTHER PARTY WHO MAY MODIFY AND/OR REDISTRIBUTE THE LIBRARY AS PERMITTED ABOVE, BE LIABLE TO YOU FOR DAMAGES, INCLUDING ANY GENERAL, SPECIAL, INCIDENTAL OR CONSEQUENTIAL DAMAGES ARISING OUT OF THE USE OR INABILITY TO USE THE LIBRARY (INCLUDING BUT NOT LIMITED TO LOSS OF DATA OR DATA BEING RENDERED INACCURATE OR LOSSES SUSTAINED BY YOU OR THIRD PARTIES OR A FAILURE OF THE LIBRARY TO OPERATE WITH ANY OTHER SOFTWARE), EVEN IF SUCH HOLDER OR OTHER PARTY HAS BEEN ADVISED OF THE POSSIBILITY OF SUCH DAMAGES.

### END OF TERMS AND CONDITIONS

#### How to Apply These Terms to Your New Libraries

If you develop a new library, and you want it to be of the greatest possible use to the public, we recommend making it free software that everyone can redistribute and change. You can do so by permitting redistribution under these terms (or, alternatively, under the terms of the ordinary General Public License).

To apply these terms, attach the following notices to the library. It is safest to attach them to the start of each source file to most effectively convey the exclusion of warranty; and each file should have at least the "copyright" line and a pointer to where the full notice is found.

<one line to give the library's name and a brief idea of what it does.> Copyright (C) <year> <name of author>

This library is free software; you can redistribute it and/or modify it under the terms of the GNU Lesser General Public License as published by the Free Software Foundation; either version 2.1 of the License, or (at your option) any later version.

This library is distributed in the hope that it will be useful, but WITHOUT ANY WARRANTY; without even the implied warranty of MERCHANTABILITY or FITNESS FOR A PARTICULAR PURPOSE. See the GNU Lesser General Public License for more details.

You should have received a copy of the GNU Lesser General Public License along with this library; if not, write to the Free Software Foundation, Inc., 51 Franklin Street, Fifth Floor, Boston, MA 02110-1301 USA

Also add information on how to contact you by electronic and paper mail.

You should also get your employer (if you work as a programmer) or your school, if any, to sign a "copyright disclaimer" for the library, if necessary. Here is a sample; alter the names:

Yoyodyne, Inc., hereby disclaims all copyright interest in the library `Frob' (a library for tweaking knobs) written by James Random Hacker.

<signature of Ty Coon>, 1 April 1990  
Ty Coon, President of Vice

That's all there is to it!



## GNU GENERAL PUBLIC LICENSE

### Version 3, 29 June 2007

Copyright (C) 2007 Free Software Foundation, Inc. <<http://fsf.org/>>

Everyone is permitted to copy and distribute verbatim copies of this license document, but changing it is not allowed.

#### Preamble

The GNU General Public License is a free, copyleft license for software and other kinds of works.

The licenses for most software and other practical works are designed to take away your freedom to share and change the works. By contrast, the GNU General Public License is intended to guarantee your freedom to share and change all versions of a program--to make sure it remains free software for all its users. We, the Free Software Foundation, use the GNU General Public License for most of our software; it applies also to any other work released this way by its authors. You can apply it to your programs, too.

When we speak of free software, we are referring to freedom, not price. Our General Public Licenses are designed to make sure that you have the freedom to distribute copies of free software (and charge for them if you wish), that you receive source code or can get it if you want it, that you can change the software or use pieces of it in new free programs, and that you know you can do these things.

To protect your rights, we need to prevent others from denying you these rights or asking you to surrender the rights. Therefore, you have certain responsibilities if you distribute copies of the software, or if you modify it: responsibilities to respect the freedom of others.

For example, if you distribute copies of such a program, whether gratis or for a fee, you must pass on to the recipients the same freedoms that you received. You must make sure that they, too, receive or can get the source code. And you must show them these terms so they know their rights.

Developers that use the GNU GPL protect your rights with two steps:

(1) assert copyright on the software, and (2) offer you this License giving you legal permission to copy, distribute and/or modify it.

For the developers' and authors' protection, the GPL clearly explains that there is no warranty for this free software. For both users' and authors' sake, the GPL requires that modified versions be marked as changed, so that their problems will not be attributed erroneously to authors of previous versions.

Some devices are designed to deny users access to install or run modified versions of the software inside them, although the manufacturer can do so. This is fundamentally incompatible with the aim of protecting users' freedom to change the software. The systematic pattern of such abuse occurs in the area of products for individuals to use, which is precisely where it is most unacceptable. Therefore, we have designed this version of the GPL to prohibit the practice for those products. If such problems arise substantially in other domains, we stand ready to extend this provision to those domains in future versions of the GPL, as needed to protect the freedom of users.

Finally, every program is threatened constantly by software patents. States should not allow patents to restrict development and use of software on general-purpose computers, but in those that do, we wish to avoid the special danger that patents applied to a free program could make it effectively proprietary. To prevent this, the GPL assures that patents cannot be used to render the program non-free.

The precise terms and conditions for copying, distribution and modification follow.

#### TERMS AND CONDITIONS



### 0. Definitions.

"This License" refers to version 3 of the GNU General Public License.

"Copyright" also means copyright-like laws that apply to other kinds of works, such as semiconductor masks.

"The Program" refers to any copyrightable work licensed under this License. Each licensee is addressed as "you". "Licensees" and "recipients" may be individuals or organizations.

To "modify" a work means to copy from or adapt all or part of the work in a fashion requiring copyright permission, other than the making of an exact copy. The resulting work is called a "modified version" of the earlier work or a work "based on" the earlier work.

A "covered work" means either the unmodified Program or a work based on the Program.

To "propagate" a work means to do anything with it that, without permission, would make you directly or secondarily liable for infringement under applicable copyright law, except executing it on a computer or modifying a private copy. Propagation includes copying, distribution (with or without modification), making available to the public, and in some countries other activities as well.

To "convey" a work means any kind of propagation that enables other parties to make or receive copies. Mere interaction with a user through a computer network, with no transfer of a copy, is not conveying.

An interactive user interface displays "Appropriate Legal Notices" to the extent that it includes a convenient and prominently visible feature that (1) displays an appropriate copyright notice, and (2) tells the user that there is no warranty for the work (except to the extent that warranties are provided), that licensees may convey the work under this License, and how to view a copy of this License. If the interface presents a list of user commands or options, such as a menu, a prominent item in the list meets this criterion.

### 1. Source Code.

The "source code" for a work means the preferred form of the work for making modifications to it. "Object code" means any non-source form of a work.

A "Standard Interface" means an interface that either is an official standard defined by a recognized standards body, or, in the case of interfaces specified for a particular programming language, one that is widely used among developers working in that language.

The "System Libraries" of an executable work include anything, other than the work as a whole, that (a) is included in the normal form of packaging a Major Component, but which is not part of that Major Component, and (b) serves only to enable use of the work with that Major Component, or to implement a Standard Interface for which an implementation is available to the public in source code form. A "Major Component", in this context, means a major essential component (kernel, window system, and so on) of the specific operating system (if any) on which the executable work runs, or a compiler used to produce the work, or an object code interpreter used to run it.

The "Corresponding Source" for a work in object code form means all the source code needed to generate, install, and (for an executable work) run the object code and to modify the work, including scripts to control those activities. However, it does not include the work's System Libraries, or general-purpose tools or generally available free programs which are used unmodified in performing those activities but which are not part of the work. For example, Corresponding Source includes interface definition files associated with source files for the work, and the source code for shared libraries and dynamically linked subprograms that the work is specifically designed to require, such as by intimate data communication or control flow between those subprograms and other parts of the work.



The Corresponding Source need not include anything that users can regenerate automatically from other parts of the Corresponding Source.

The Corresponding Source for a work in source code form is that same work.

### 2. Basic Permissions.

All rights granted under this License are granted for the term of copyright on the Program, and are irrevocable provided the stated conditions are met. This License explicitly affirms your unlimited permission to run the unmodified Program. The output from running a covered work is covered by this License only if the output, given its content, constitutes a covered work. This License acknowledges your rights of fair use or other equivalent, as provided by copyright law.

You may make, run and propagate covered works that you do not convey, without conditions so long as your license otherwise remains in force. You may convey covered works to others for the sole purpose of having them make modifications exclusively for you, or provide you with facilities for running those works, provided that you comply with the terms of this License in conveying all material for which you do not control copyright. Those thus making or running the covered works for you must do so exclusively on your behalf, under your direction and control, on terms that prohibit them from making any copies of your copyrighted material outside their relationship with you.

Conveying under any other circumstances is permitted solely under the conditions stated below. Sublicensing is not allowed; section 10 makes it unnecessary.

### 3. Protecting Users' Legal Rights From Anti-Circumvention Law.

No covered work shall be deemed part of an effective technological measure under any applicable law fulfilling obligations under article 11 of the WIPO copyright treaty adopted on 20 December 1996, or similar laws prohibiting or restricting circumvention of such measures.

When you convey a covered work, you waive any legal power to forbid circumvention of technological measures to the extent such circumvention is effected by exercising rights under this License with respect to the covered work, and you disclaim any intention to limit operation or modification of the work as a means of enforcing, against the work's users, your or third parties' legal rights to forbid circumvention of technological measures.

### 4. Conveying Verbatim Copies.

You may convey verbatim copies of the Program's source code as you receive it, in any medium, provided that you conspicuously and appropriately publish on each copy an appropriate copyright notice; keep intact all notices stating that this License and any non-permissive terms added in accord with section 7 apply to the code; keep intact all notices of the absence of any warranty; and give all recipients a copy of this License along with the Program.

You may charge any price or no price for each copy that you convey, and you may offer support or warranty protection for a fee.

### 5. Conveying Modified Source Versions.

You may convey a work based on the Program, or the modifications to produce it from the Program, in the form of source code under the terms of section 4, provided that you also meet all of these conditions:

- a) The work must carry prominent notices stating that you modified it, and giving a relevant date.
- b) The work must carry prominent notices stating that it is released under this License and any conditions added under section

7. This requirement modifies the requirement in section 4 to "keep intact all notices".





c) You must license the entire work, as a whole, under this License to anyone who comes into possession of a copy. This License will therefore apply, along with any applicable section 7 additional terms, to the whole of the work, and all its parts, regardless of how they are packaged. This License gives no permission to license the work in any other way, but it does not invalidate such permission if you have separately received it.

d) If the work has interactive user interfaces, each must display Appropriate Legal Notices; however, if the Program has interactive interfaces that do not display Appropriate Legal Notices, your work need not make them do so.

A compilation of a covered work with other separate and independent works, which are not by their nature extensions of the covered work, and which are not combined with it such as to form a larger program, in or on a volume of a storage or distribution medium, is called an "aggregate" if the compilation and its resulting copyright are not used to limit the access or legal rights of the compilation's users beyond what the individual works permit. Inclusion of a covered work in an aggregate does not cause this License to apply to the other parts of the aggregate.

### 6. Conveying Non-Source Forms.

You may convey a covered work in object code form under the terms of sections 4 and 5, provided that you also convey the machine-readable Corresponding Source under the terms of this License, in one of these ways:

a) Convey the object code in, or embodied in, a physical product (including a physical distribution medium), accompanied by the Corresponding Source fixed on a durable physical medium customarily used for software interchange.

b) Convey the object code in, or embodied in, a physical product (including a physical distribution medium), accompanied by a written offer, valid for at least three years and valid for as long as you offer spare parts or customer support for that product model, to give anyone who possesses the object code either (1) a copy of the Corresponding Source for all the software in the product that is covered by this License, on a durable physical medium customarily used for software interchange, for a price no more than your reasonable cost of physically performing this conveying of source, or (2) access to copy the Corresponding Source from a network server at no charge.

c) Convey individual copies of the object code with a copy of the written offer to provide the Corresponding Source. This alternative is allowed only occasionally and noncommercially, and only if you received the object code with such an offer, in accord with subsection 6b.

d) Convey the object code by offering access from a designated place (gratis or for a charge), and offer equivalent access to the Corresponding Source in the same way through the same place at no further charge. You need not require recipients to copy the Corresponding Source along with the object code. If the place to copy the object code is a network server, the Corresponding Source may be on a different server (operated by you or a third party) that supports equivalent copying facilities, provided you maintain clear directions next to the object code saying where to find the Corresponding Source. Regardless of what server hosts the Corresponding Source, you remain obligated to ensure that it is available for as long as needed to satisfy these requirements.

e) Convey the object code using peer-to-peer transmission, provided you inform other peers where the object code and Corresponding Source of the work are being offered to the general public at no charge under subsection 6d.

A separable portion of the object code, whose source code is excluded from the Corresponding Source as a System Library, need not be included in conveying the object code work.

A "User Product" is either (1) a "consumer product", which means any tangible personal property which is normally used for personal, family, or household purposes, or (2) anything designed or sold for incorporation into a dwelling. In determining whether a product is a consumer product, doubtful cases shall be resolved in favor of coverage. For a particular product received by a particular user, "normally used" refers to a typical or common use of that class of product, regardless of the status of the particular user or of the way in which the particular user actually uses, or expects or is expected to use, the product. A product is a consumer product regardless of whether the product has substantial



commercial, industrial or non-consumer uses, unless such uses represent the only significant mode of use of the product.

"Installation Information" for a User Product means any methods, procedures, authorization keys, or other information required to install and execute modified versions of a covered work in that User Product from a modified version of its Corresponding Source. The information must suffice to ensure that the continued functioning of the modified object code is in no case prevented or interfered with solely because modification has been made.

If you convey an object code work under this section in, or with, or specifically for use in, a User Product, and the conveying occurs as part of a transaction in which the right of possession and use of the User Product is transferred to the recipient in perpetuity or for a fixed term (regardless of how the transaction is characterized), the Corresponding Source conveyed under this section must be accompanied by the Installation Information. But this requirement does not apply if neither you nor any third party retains the ability to install modified object code on the User Product (for example, the work has been installed in ROM).

The requirement to provide Installation Information does not include a requirement to continue to provide support service, warranty, or updates for a work that has been modified or installed by the recipient, or for the User Product in which it has been modified or installed. Access to a network may be denied when the modification itself materially and adversely affects the operation of the network or violates the rules and protocols for communication across the network.

Corresponding Source conveyed, and Installation Information provided, in accord with this section must be in a format that is publicly documented (and with an implementation available to the public in source code form), and must require no special password or key for unpacking, reading or copying.

### 7. Additional Terms.

"Additional permissions" are terms that supplement the terms of this License by making exceptions from one or more of its conditions. Additional permissions that are applicable to the entire Program shall be treated as though they were included in this License, to the extent that they are valid under applicable law. If additional permissions apply only to part of the Program, that part may be used separately under those permissions, but the entire Program remains governed by this License without regard to the additional permissions.

When you convey a copy of a covered work, you may at your option remove any additional permissions from that copy, or from any part of it. (Additional permissions may be written to require their own removal in certain cases when you modify the work.) You may place additional permissions on material, added by you to a covered work, for which you have or can give appropriate copyright permission.

Notwithstanding any other provision of this License, for material you add to a covered work, you may (if authorized by the copyright holders of that material) supplement the terms of this License with terms:

- a) Disclaiming warranty or limiting liability differently from the terms of sections 15 and 16 of this License; or
- b) Requiring preservation of specified reasonable legal notices or author attributions in that material or in the Appropriate Legal Notices displayed by works containing it; or
- c) Prohibiting misrepresentation of the origin of that material, or requiring that modified versions of such material be marked in reasonable ways as different from the original version; or
- d) Limiting the use for publicity purposes of names of licensors or authors of the material; or
- e) Declining to grant rights under trademark law for use of some trade names, trademarks, or service marks; or





f) Requiring indemnification of licensors and authors of that material by anyone who conveys the material (or modified versions of it) with contractual assumptions of liability to the recipient, for any liability that these contractual assumptions directly impose on those licensors and authors.

All other non-permissive additional terms are considered "further restrictions" within the meaning of section 10. If the Program as you received it, or any part of it, contains a notice stating that it is governed by this License along with a term that is a further restriction, you may remove that term. If a license document contains a further restriction but permits relicensing or conveying under this License, you may add to a covered work material governed by the terms of that license document, provided that the further restriction does not survive such relicensing or conveying.

If you add terms to a covered work in accord with this section, you must place, in the relevant source files, a statement of the additional terms that apply to those files, or a notice indicating where to find the applicable terms.

Additional terms, permissive or non-permissive, may be stated in the form of a separately written license, or stated as exceptions; the above requirements apply either way.

### 8. Termination.

You may not propagate or modify a covered work except as expressly provided under this License. Any attempt otherwise to propagate or modify it is void, and will automatically terminate your rights under this License (including any patent licenses granted under the third paragraph of section 11).

However, if you cease all violation of this License, then your license from a particular copyright holder is reinstated (a) provisionally, unless and until the copyright holder explicitly and finally terminates your license, and (b) permanently, if the copyright holder fails to notify you of the violation by some reasonable means prior to 60 days after the cessation.

Moreover, your license from a particular copyright holder is reinstated permanently if the copyright holder notifies you of the violation by some reasonable means, this is the first time you have received notice of violation of this License (for any work) from that copyright holder, and you cure the violation prior to 30 days after your receipt of the notice.

Termination of your rights under this section does not terminate the licenses of parties who have received copies or rights from you under this License. If your rights have been terminated and not permanently reinstated, you do not qualify to receive new licenses for the same material under section 10.

### 9. Acceptance Not Required for Having Copies.

You are not required to accept this License in order to receive or run a copy of the Program. Ancillary propagation of a covered work occurring solely as a consequence of using peer-to-peer transmission to receive a copy likewise does not require acceptance. However, nothing other than this License grants you permission to propagate or modify any covered work. These actions infringe copyright if you do not accept this License. Therefore, by modifying or propagating a covered work, you indicate your acceptance of this License to do so.

### 10. Automatic Licensing of Downstream Recipients.

Each time you convey a covered work, the recipient automatically receives a license from the original licensors, to run, modify and propagate that work, subject to this License. You are not responsible for enforcing compliance by third parties with this License.

An "entity transaction" is a transaction transferring control of an organization, or substantially all assets of one, or subdividing an organization, or merging organizations. If propagation of a covered work results from an entity transaction, each party to that transaction who receives a copy of the work also receives whatever licenses to the work the party's predecessor in interest had or could give under the previous paragraph, plus a right to possession of the Corresponding Source of the work from the predecessor in interest, if the predecessor has it or can get it with reasonable efforts.



You may not impose any further restrictions on the exercise of the rights granted or affirmed under this License. For example, you may not impose a license fee, royalty, or other charge for exercise of rights granted under this License, and you may not initiate litigation (including a cross-claim or counterclaim in a lawsuit) alleging that any patent claim is infringed by making, using, selling, offering for sale, or importing the Program or any portion of it.

#### 11. Patents.

A "contributor" is a copyright holder who authorizes use under this License of the Program or a work on which the Program is based. The work thus licensed is called the contributor's "contributor version".

A contributor's "essential patent claims" are all patent claims owned or controlled by the contributor, whether already acquired or hereafter acquired, that would be infringed by some manner, permitted by this License, of making, using, or selling its contributor version, but do not include claims that would be infringed only as a consequence of further modification of the contributor version. For purposes of this definition, "control" includes the right to grant patent sublicenses in a manner consistent with the requirements of this License.

Each contributor grants you a non-exclusive, worldwide, royalty-free patent license under the contributor's essential patent claims, to make, use, sell, offer for sale, import and otherwise run, modify and propagate the contents of its contributor version.

In the following three paragraphs, a "patent license" is any express agreement or commitment, however denominated, not to enforce a patent (such as an express permission to practice a patent or covenant not to sue for patent infringement). To "grant" such a patent license to a party means to make such an agreement or commitment not to enforce a patent against the party.

If you convey a covered work, knowingly relying on a patent license, and the Corresponding Source of the work is not available for anyone to copy, free of charge and under the terms of this License, through a publicly available network server or other readily accessible means, then you must either (1) cause the Corresponding Source to be so available, or (2) arrange to deprive yourself of the benefit of the patent license for this particular work, or (3) arrange, in a manner consistent with the requirements of this License, to extend the patent license to downstream recipients. "Knowingly relying" means you have actual knowledge that, but for the patent license, your conveying the covered work in a country, or your recipient's use of the covered work in a country, would infringe one or more identifiable patents in that country that you have reason to believe are valid.

If, pursuant to or in connection with a single transaction or arrangement, you convey, or propagate by procuring conveyance of, a covered work, and grant a patent license to some of the parties receiving the covered work authorizing them to use, propagate, modify or convey a specific copy of the covered work, then the patent license you grant is automatically extended to all recipients of the covered work and works based on it.

A patent license is "discriminatory" if it does not include within the scope of its coverage, prohibits the exercise of, or is conditioned on the non-exercise of one or more of the rights that are specifically granted under this License. You may not convey a covered work if you are a party to an arrangement with a third party that is in the business of distributing software, under which you make payment to the third party based on the extent of your activity of conveying the work, and under which the third party grants, to any of the parties who would receive the covered work from you, a discriminatory patent license (a) in connection with copies of the covered work conveyed by you (or copies made from those copies), or (b) primarily for and in connection with specific products or compilations that contain the covered work, unless you entered into that arrangement, or that patent license was granted, prior to 28 March 2007.

Nothing in this License shall be construed as excluding or limiting any implied license or other defenses to infringement that may otherwise be available to you under applicable patent law.

#### 12. No Surrender of Others' Freedom.



If conditions are imposed on you (whether by court order, agreement or otherwise) that contradict the conditions of this License, they do not excuse you from the conditions of this License. If you cannot convey a covered work so as to satisfy simultaneously your obligations under this License and any other pertinent obligations, then as a consequence you may not convey it at all. For example, if you agree to terms that obligate you to collect a royalty for further conveying from those to whom you convey the Program, the only way you could satisfy both those terms and this License would be to refrain entirely from conveying the Program.

### 13. Use with the GNU Affero General Public License.

Notwithstanding any other provision of this License, you have permission to link or combine any covered work with a work licensed under version 3 of the GNU Affero General Public License into a single combined work, and to convey the resulting work. The terms of this License will continue to apply to the part which is the covered work, but the special requirements of the GNU Affero General Public License, section 13, concerning interaction through a network will apply to the combination as such.

### 14. Revised Versions of this License.

The Free Software Foundation may publish revised and/or new versions of the GNU General Public License from time to time. Such new versions will be similar in spirit to the present version, but may differ in detail to address new problems or concerns.

Each version is given a distinguishing version number. If the Program specifies that a certain numbered version of the GNU General Public License "or any later version" applies to it, you have the option of following the terms and conditions either of that numbered version or of any later version published by the Free Software Foundation. If the Program does not specify a version number of the GNU General Public License, you may choose any version ever published by the Free Software Foundation.

If the Program specifies that a proxy can decide which future versions of the GNU General Public License can be used, that proxy's public statement of acceptance of a version permanently authorizes you to choose that version for the Program.

Later license versions may give you additional or different permissions. However, no additional obligations are imposed on any author or copyright holder as a result of your choosing to follow a later version.

### 15. Disclaimer of Warranty.

THERE IS NO WARRANTY FOR THE PROGRAM, TO THE EXTENT PERMITTED BY APPLICABLE LAW. EXCEPT WHEN OTHERWISE STATED IN WRITING THE COPYRIGHT HOLDERS AND/OR OTHER PARTIES PROVIDE THE PROGRAM "AS IS" WITHOUT WARRANTY OF ANY KIND, EITHER EXPRESSED OR IMPLIED, INCLUDING, BUT NOT LIMITED TO, THE IMPLIED WARRANTIES OF MERCHANTABILITY AND FITNESS FOR A PARTICULAR PURPOSE. THE ENTIRE RISK AS TO THE QUALITY AND PERFORMANCE OF THE PROGRAM IS WITH YOU. SHOULD THE PROGRAM PROVE DEFECTIVE, YOU ASSUME THE COST OF ALL NECESSARY SERVICING, REPAIR OR CORRECTION.

### 16. Limitation of Liability.

IN NO EVENT UNLESS REQUIRED BY APPLICABLE LAW OR AGREED TO IN WRITING WILL ANY COPYRIGHT HOLDER, OR ANY OTHER PARTY WHO MODIFIES AND/OR CONVEYS THE PROGRAM AS PERMITTED ABOVE, BE LIABLE TO YOU FOR DAMAGES, INCLUDING ANY GENERAL, SPECIAL, INCIDENTAL OR CONSEQUENTIAL DAMAGES ARISING OUT OF THE USE OR INABILITY TO USE THE PROGRAM (INCLUDING BUT NOT LIMITED TO LOSS OF DATA OR DATA BEING RENDERED INACCURATE OR LOSSES SUSTAINED BY YOU OR THIRD PARTIES OR A FAILURE OF THE PROGRAM TO OPERATE WITH ANY OTHER PROGRAMS), EVEN IF SUCH HOLDER OR OTHER PARTY HAS BEEN ADVISED OF THE POSSIBILITY OF SUCH DAMAGES.



## 17. Interpretation of Sections 15 and 16.

If the disclaimer of warranty and limitation of liability provided above cannot be given local legal effect according to their terms, reviewing courts shall apply local law that most closely approximates an absolute waiver of all civil liability in connection with the Program, unless a warranty or assumption of liability accompanies a copy of the Program in return for a fee.

## END OF TERMS AND CONDITIONS

### How to Apply These Terms to Your New Programs

If you develop a new program, and you want it to be of the greatest possible use to the public, the best way to achieve this is to make it free software which everyone can redistribute and change under these terms.

To do so, attach the following notices to the program. It is safest to attach them to the start of each source file to most effectively state the exclusion of warranty; and each file should have at least the "copyright" line and a pointer to where the full notice is found.

```
<one line to give the program's name and a brief idea of what it does.>  
Copyright (C) <year> <name of author>
```

This program is free software: you can redistribute it and/or modify it under the terms of the GNU General Public License as published by the Free Software Foundation, either version 3 of the License, or (at your option) any later version.

This program is distributed in the hope that it will be useful, but WITHOUT ANY WARRANTY; without even the implied warranty of MERCHANTABILITY or FITNESS FOR A PARTICULAR PURPOSE. See the GNU General Public License for more details.

You should have received a copy of the GNU General Public License along with this program. If not, see <http://www.gnu.org/licenses/>.

Also add information on how to contact you by electronic and paper mail.

If the program does terminal interaction, make it output a short notice like this when it starts in an interactive mode:

```
<program> Copyright (C) <year> <name of author>  
This program comes with ABSOLUTELY NO WARRANTY; for details type `show w'.  
This is free software, and you are welcome to redistribute it under certain conditions; type `show c' for details.
```

The hypothetical commands `show w' and `show c' should show the appropriate parts of the General Public License. Of course, your program's commands might be different; for a GUI interface, you would use an "about box".

You should also get your employer (if you work as a programmer) or school, if any, to sign a "copyright disclaimer" for the program, if necessary.

For more information on this, and how to apply and follow the GNU GPL, see <http://www.gnu.org/licenses/>.

The GNU General Public License does not permit incorporating your program into proprietary programs. If your program is a subroutine library, you may consider it more useful to permit linking proprietary applications with the library. If this is what you want to do, use the GNU Lesser General Public License instead of this License. But first, please read <http://www.gnu.org/philosophy/why-not-lgpl.html>.



-----libtiff-----

Copyright (c) 1988-1997 Sam Leffler  
Copyright (c) 1991-1997 Silicon Graphics, Inc.

Permission to use, copy, modify, distribute, and sell this software and its documentation for any purpose is hereby granted without fee, provided that (i) the above copyright notices and this permission notice appear in all copies of the software and related documentation, and (ii) the names of Sam Leffler and Silicon Graphics may not be used in any advertising or publicity relating to the software without the specific, prior written permission of Sam Leffler and Silicon Graphics.

THE SOFTWARE IS PROVIDED "AS-IS" AND WITHOUT WARRANTY OF ANY KIND, EXPRESS, IMPLIED OR OTHERWISE, INCLUDING WITHOUT LIMITATION, ANY WARRANTY OF MERCHANTABILITY OR FITNESS FOR A PARTICULAR PURPOSE.

IN NO EVENT SHALL SAM LEFFLER OR SILICON GRAPHICS BE LIABLE FOR ANY SPECIAL, INCIDENTAL, INDIRECT OR CONSEQUENTIAL DAMAGES OF ANY KIND, OR ANY DAMAGES WHATSOEVER RESULTING FROM LOSS OF USE, DATA OR PROFITS, WHETHER OR NOT ADVISED OF THE POSSIBILITY OF DAMAGE, AND ON ANY THEORY OF LIABILITY, ARISING OUT OF OR IN CONNECTION WITH THE USE OR PERFORMANCE OF THIS SOFTWARE.

-----libjpeg-----

This software is based in part on the work of the Independent JPEG Group.



# SOFTWARE LICENSE

**PLEASE READ THIS LICENSE CAREFULLY BEFORE USING THE SOFTWARE. BY USING THE SOFTWARE, YOU ARE AGREEING TO BE BOUND BY THE TERMS OF THIS LICENSE.**

## 1. License

The application, demonstration, system and other software accompanying this License, whether on disk, in read only memory, or on any other media (the "Software") and related documentation are licensed to you by SHARP. You own the disk on which the Software is recorded but SHARP and/or SHARP's Licensors retain title to the Software and related documentation. This License allows you to use the Software on one or more computers connected to a single printer and make one copy of the Software in machine-readable form for backup purposes only. You must reproduce on such copy the SHARP copyright notice, the copyright notice of SHARP's Licensors and any other proprietary legends of SHARP and/or its Licensors that were on the original copy of the Software. You may also transfer all your license rights in the Software, the backup copy of the Software, the related documentation and a copy of this License to another party, provided the other party reads and agrees to the terms and conditions of this License.

## 2. Restrictions

The Software contains copyrighted material, trade secrets and other proprietary material which is owned by SHARP and/or its Licensors and in order to protect them you may not decompile, reverse engineer, disassemble or otherwise reduce the Software to a human-perceivable form. You may not modify, network, rent, lease, loan, distribute or create derivative works based upon the Software in whole or in part. You may not electronically transmit the Software from one computer to another or over a network.

## 3. Termination

This license is effective until terminated. You may terminate this License at any time by destroying the Software and related documentation and all copies thereof. This License will terminate immediately without notice from SHARP and/or SHARP's Licensors if you fail to comply with any provision of this License. Upon termination you must destroy the Software and related documentation and all copies thereof.

## 4. Export Law Assurances

You agree and certify that neither the Software nor any other technical data received from SHARP, nor the direct product thereof, will be exported outside the United States except as authorized and as permitted by the laws and regulations of the United States. If the Software has been rightfully obtained by you outside of the United States, you agree that you will not re-export the Software nor any other technical data received from SHARP, nor the direct product thereof, except as permitted by the laws and regulations of the United States and the laws and the regulation of the jurisdiction in which you obtained the Software.

## 5. Government End Users

If you are acquiring the Software on behalf of any unit or agency of the United States Government, the following provisions apply. The Government agrees:

- (i) if the Software is supplied to the Department of Defense (DoD), the Software is classified as "Commercial Computer Software" and the Government is acquiring only "restricted rights" in the Software and its documentation as that term is defined in Clause 252.227-7013 (c)(1) (Oct., 1988) of the DFARS; and
- (ii) if the Software is supplied to any unit or agency of the United States Government other than DoD, the Software is classified as "Commercial" that term is defined at 48 C.F.R. 2.101 and as "Commercial Computer Software" that term is defined in 48 C.F.R. 12.212, and the Government's rights in the Software and its documentation will be as defined in Clause 52.227-19 (c)(2) of the FAR or, in the case of NASA, in Clause 18-52.227-86 (d) of the NASA Supplement to the FAR.





**6. Limited Warranty on Media.**

SHARP warrants the disks on which the Software is recorded to be free from defects in materials and workmanship under normal use for a period of ninety (90) days from the date of purchase as evidenced by a copy of the receipt. The entire liability of SHARP and/or its Licensors and your exclusive remedy will be replacement of the disk which fails to meet the limited warranty provided by this Clause 6. A disk will be replaced when it is returned to SHARP or a SHARP authorized representative with a copy of the receipt. SHARP will have no responsibility to replace a disk damaged by accident, abuse or misapplication.

ANY IMPLIED WARRANTIES ON THE DISKS, INCLUDING THE IMPLIED WARRANTIES OF MERCHANTABILITY AND FITNESS FOR A PARTICULAR PURPOSE, ARE LIMITED IN DURATION TO NINETY (90) DAYS FROM THE DATE OF DELIVERY. THIS WARRANTY GIVES YOU SPECIFIC LEGAL RIGHTS, AND YOU MAY ALSO HAVE OTHER RIGHTS WHICH VARY FROM JURISDICTION TO JURISDICTION.

**7. Disclaimer of Warranty on Software**

You expressly acknowledge and agree that use of the Software is at your sole risk. The Software and related documentation are provided "AS IS" and without warranty of any kind and SHARP and SHARP's Licensor(s) (for the purpose of provisions 6 and 7, SHARP and SHARP's Licensor(s) shall be collectively referred to as "SHARP") EXPRESSLY DISCLAIM ALL WARRANTIES, EXPRESS OR IMPLIED, INCLUDING, BUT NOT LIMITED TO, THE IMPLIED WARRANTIES OF MERCHANTABILITY AND FITNESS FOR A PARTICULAR PURPOSE. SHARP DOES NOT WARRANT THAT THE FUNCTIONS CONTAINED IN THE SOFTWARE WILL MEET YOUR REQUIREMENTS, OR THAT THE OPERATION OF THE SOFTWARE WILL BE UNINTERRUPTED OR ERROR-FREE, OR THAT DEFECTS IN THE SOFTWARE WILL BE CORRECTED. FURTHERMORE, SHARP DOES NOT WARRANT OR MAKE ANY REPRESENTATIONS REGARDING THE USE OR THE RESULTS OF THE USE OF THE SOFTWARE OR RELATED DOCUMENTATION IN TERMS OF THEIR CORRECTNESS, ACCURACY, RELIABILITY, OR OTHERWISE. NO ORAL OR WRITTEN INFORMATION OR ADVICE GIVEN BY SHARP OR A SHARP AUTHORIZED REPRESENTATIVE SHALL CREATE A WARRANTY OR IN ANY WAY INCREASE THE SCOPE OF THIS WARRANTY. SHOULD THE SOFTWARE PROVE DEFECTIVE, YOU (AND NOT SHARP OR A SHARP AUTHORIZED REPRESENTATIVE) ASSUME THE ENTIRE COST OF ALL NECESSARY SERVICING, REPAIR OR CORRECTION, SOME JURISDICTIONS DO NOT ALLOW THE EXCLUSION OF IMPLIED WARRANTIES, SO THE ABOVE EXCLUSION MAY NOT APPLY TO YOU.

**8. Limitation of Liability**

UNDER NO CIRCUMSTANCES INCLUDING NEGLIGENCE, SHALL SHARP BE LIABLE FOR ANY INCIDENTAL, SPECIAL OR CONSEQUENTIAL DAMAGES THAT RESULT FROM THE USE OR INABILITY TO USE THE SOFTWARE OR RELATED DOCUMENTATION, EVEN IF SHARP OR A SHARP AUTHORIZED REPRESENTATIVE HAS BEEN ADVISED OF THE POSSIBILITY OF SUCH DAMAGES. SOME JURISDICTIONS DO NOT ALLOW THE LIMITATION OR EXCLUSION OF LIABILITY FOR INCIDENTAL OR CONSEQUENTIAL DAMAGES SO THE ABOVE LIMITATION OR EXCLUSION MAY NOT APPLY TO YOU.

In no event shall SHARP's total liability to you for all damages, losses, and causes of action (whether in contract, tort (including negligence) or otherwise) exceed the amount paid by you for the Software.

**9. Controlling Law and Severability**

For a portion of the Software related with Apple Macintosh and Microsoft Windows, this license shall be governed by and construed in accordance with the laws of the state of California and Washington, respectively. If for any reason a court of competent jurisdiction finds any provision of this License, or portion thereof, to be unenforceable, that provision of the License shall be enforced to the maximum extent permissible so as to effect the intent of the parties, and the remainder of this License shall continue in full force and effect.

**10. Complete Agreement**

This License constitutes the entire agreement between the parties with respect to the use of the Software and related documentation, and supersedes all prior or contemporaneous understandings or agreements, written or oral, regarding such subject matter. No amendment to or modification of this License will be binding unless in writing and signed by a duly authorized representative of SHARP.

**SHARP**<sup>®</sup>  
SHARP CORPORATION